

VEVOR[®]

TOUGH TOOLS, HALF PRICE

Technical Support and E-Warranty Certificate

www.vevor.com/support

STEERING WHEEL STAND

MODEL: WS-P02

We continue to be committed to provide you tools with competitive price. "Save Half", "Half Price" or any other similar expressions used by us only represents an estimate of savings you might benefit from buying certain tools with us compared to the major top brands and does not necessarily mean to cover all categories of tools offered by us. You are kindly reminded to verify carefully when you are placing an order with us if you are actually saving half in comparison with the top major brands.

VEVOR[®]

TOUGH TOOLS, HALF PRICE

STEERING WHEEL STAND

MODEL: WS-P02

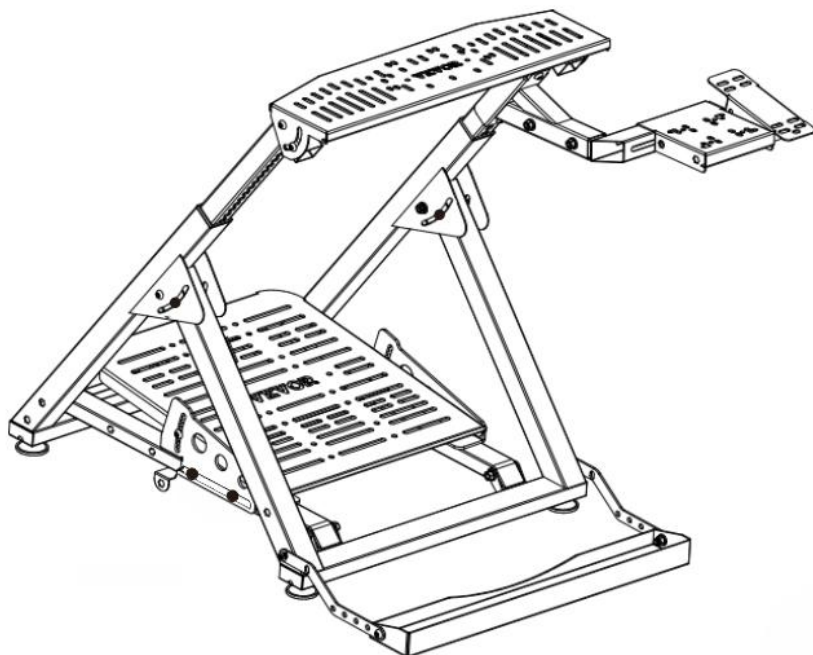

NEED HELP? CONTACT US!

Have product questions? Need technical support? Please feel free to contact us:

Technical Support and E-Warranty Certificate
www.vevor.com/support

This is the original instruction, please read all manual instructions carefully before operating. VEVOR reserves a clear interpretation of our user manual. The appearance of the product shall be subject to the product you received. Please forgive us that we won't inform you again if there are any technology or software updates on our product.











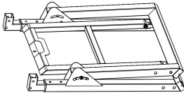







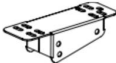

Warning-To reduce the risk of injury, user must read instructions manual carefully.









Attentions

- Please install and use the stand according to instruction .
- Please install moderately, avoid strong vibration .
Don't keep in humid conditions, high temperature or a dusty location .
- The product structure is flexible, wear work gloves during assembly. please take care of hurting hand when installation.
- Children should under adult's supervision when using the product.

Save the manual.

Part List			
Code	Picture	Name	QTY.
1		Wheel Stand	1
2		Pedal Plate	1
3		Wheel Plate	1

4		Shifter Mounting Arm	1
5		Shifter Arm	1
6		Gaming Chair Cradle	1
7		Cradle Bracket	2
8		Shifter Plate	1
9		Hand Brake Plate	1
10		Right Pedal Plate Bracket	1
11		Left Pedal Plate Bracket	1
12		Knob 32-M8*20	1
13		Knob 38-M8*20	4
14		Feet	4
15		Screw M6*16	12
16		Screw M8*16	18
17		Screw M8*50	6
18		Nut M6	12
19		Washer 8	22

20		Nut M8	6
21		Hex key 4	1
22		Hex key 5	1
23		Universal Casters	2
24		Wench 10	1
25		Wench 12	1
26		Wench 13	1
27		Binding Strap	6

Note:12pcs screws M6*16、 6pcs nuts M6 and 2pcs Universal Casters are complimentary.

STEP 1: Loosen the two knobs circled to unfold wheel stand.

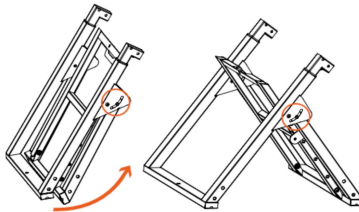

STEP 2: Cut the plastic ties ,then lay down the pedal frame and reinstall the twist knob at the front of the pedal.And install the feet.

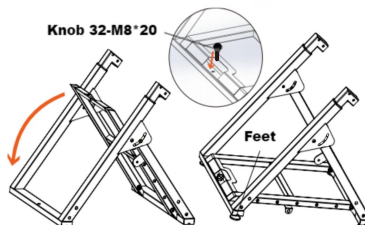

STEP 3: Line up the back holes on the pedal plate with the back holes on the pedal brackets and bolt through using 2 x M8*16 screws and washers.

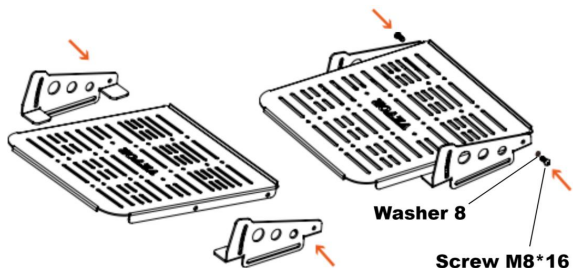

STEP 4: Adjust the pedal plate to your desired angle and bolt through the front holes using 2 x M8*16 screws and washers.

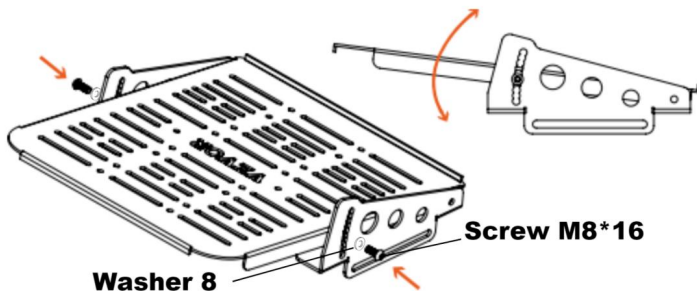

STEP 5:

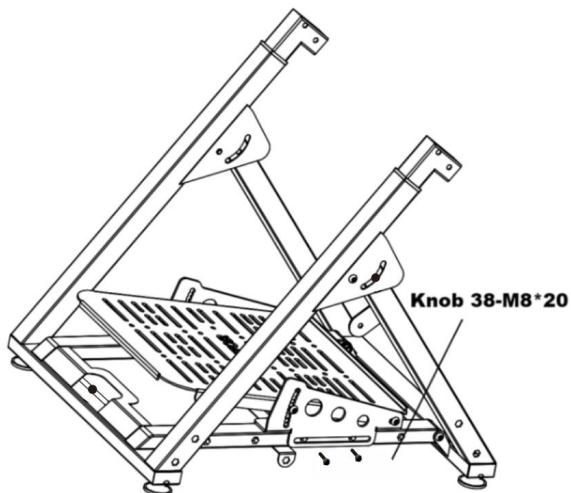

STEP 6:

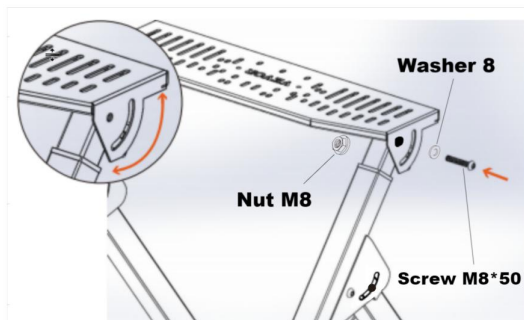

STEP 7:

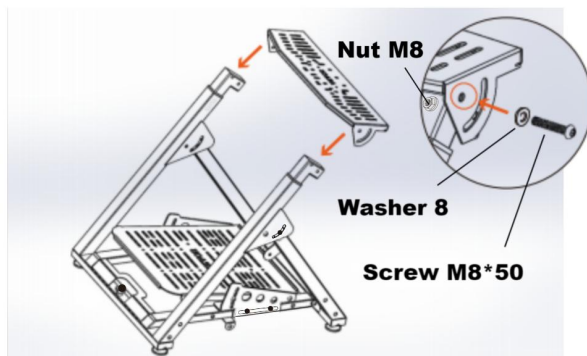

STEP 8:

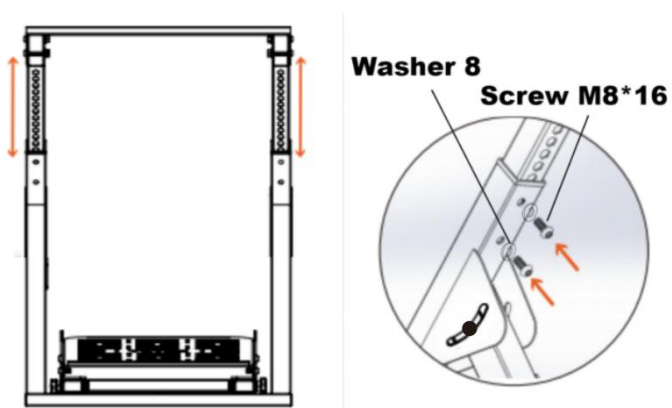

STEP 9:

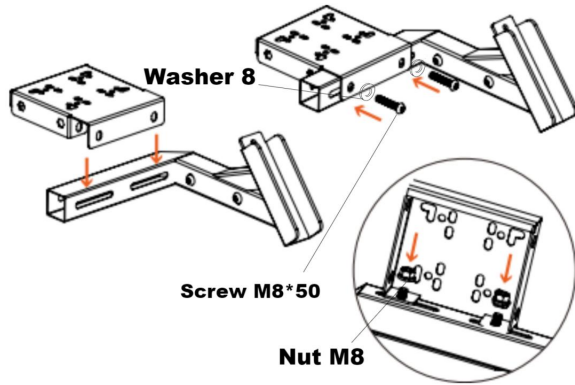

STEP 10:

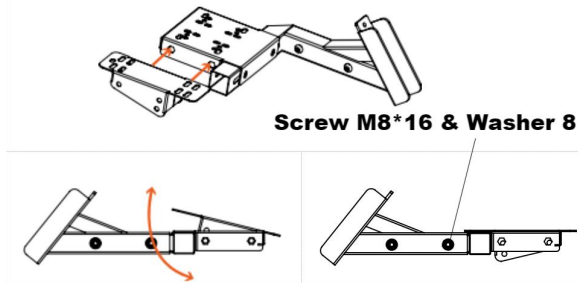

STEP 11: Line up the holes on the Shifter Mounting Arm with the threaded inserts on the vertical post choose your desired height securing with 2x M8*16mm screws and washers.

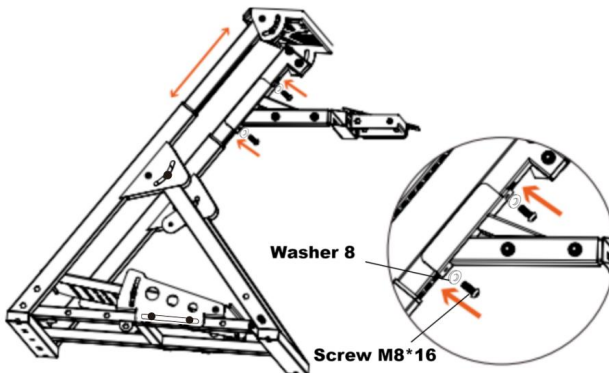

STEP 12:

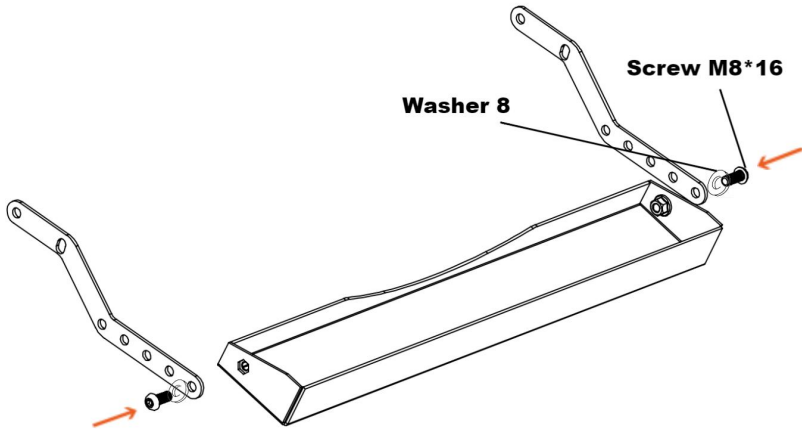

STEP 13:

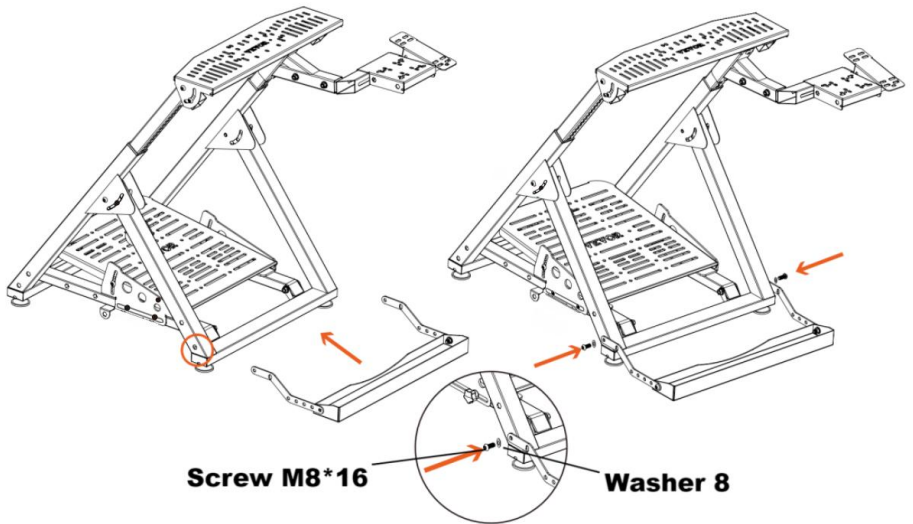

STEP 14: Seat Placement



STEP 15: Stow away the Gaming Chair Cradle as shown to allow easy folding of the stand for storage.

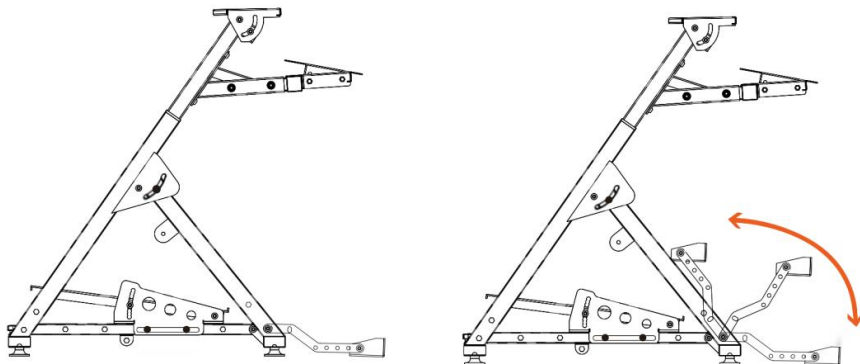

Manufacturer: Shanghaimuxinmuyeyouxiangongsi

Address: Shuangchenglu 803nong11hao1602A-1609shi, baoshanqu, shanghai 200000 CN.

Imported to AUS: SIHAO PTY LTD. 1 ROKEVA STREETEASTWOOD NSW 2122 Australia

Imported to USA: Sanven Technology Ltd. Suite 250, 9166 Anaheim Place, Rancho Cucamonga, CA 91730



E-CrossStu GmbH
Mainzer Landstr.69, 60329 Frankfurt am Main.



YH CONSULTING LIMITED.
C/O YH Consulting Limited Office 147, Centurion House, London Road, Staines-upon-Thames, Surrey, TW18 4AX

VEVOR[®]

TOUGH TOOLS, HALF PRICE

Technical Support and E-Warranty Certificate

www.vevor.com/support

VEVOR[®]

TOUGH TOOLS, HALF PRICE

Assistance technique et certificat de garantie

électronique www.vevor.com/support

SUPPORT DE VOLANT

MODÈLE : WS-P02

Nous continuons à nous engager à vous fournir des outils à des prix compétitifs.

« Économisez la moitié », « Moitié prix » ou toute autre expression similaire utilisée par nous ne représente qu'une estimation des économies que vous pourriez réaliser en achetant certains outils chez nous par rapport aux grandes marques et ne couvre pas nécessairement toutes les catégories d'outils que nous proposons.

Nous vous rappelons de bien vouloir vérifier soigneusement lorsque vous passez une commande chez nous si vous économisez réellement la moitié par rapport aux grandes marques.

VEVOR[®]

TOUGH TOOLS, HALF PRICE

VOLANT

RESTER

MODÈLE : WS-P02

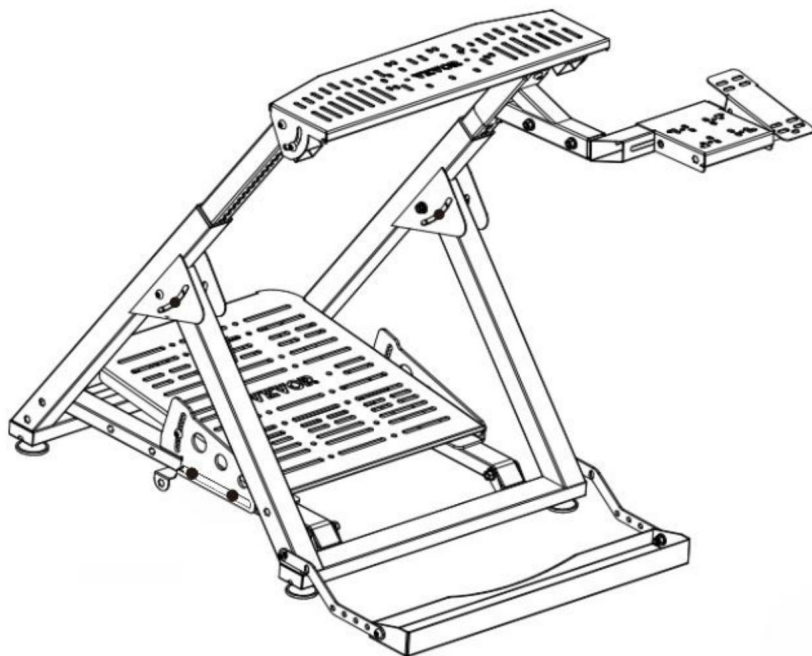

BESOIN D'AIDE? CONTACTEZ-NOUS!

Vous avez des questions sur nos produits ? Vous avez besoin d'assistance technique ?
N'hésitez pas

à nous contacter : Assistance technique et certificat de garantie
électronique www.vevor.com/support

Ceci est l'instruction originale, veuillez lire toutes les instructions du manuel attentivement avant d'utiliser. VEVOR se réserve une interprétation claire de nos manuel d'utilisation. L'apparence du produit est soumise à la produit que vous avez reçu. Veuillez nous excuser, nous ne vous informerons plus si il y a des mises à jour technologiques ou logicielles sur notre produit.



Avertissement - Pour réduire le risque de blessure, l'utilisateur doit lire
Lisez attentivement le manuel d'instructions.

Attention



Veuillez installer et utiliser le support conformément aux instructions. Veuillez l'installer avec modération, évitez les fortes vibrations.







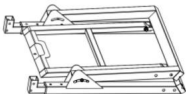









Ne pas conserver dans des conditions humides, à haute température ou dans un endroit poussiéreux.









La structure du produit est flexible, portez des gants de travail pendant l'assemblage. Veuillez faire attention à ne pas vous blesser la main lors de l'installation.

Les enfants doivent être sous la surveillance d'un adulte lors de l'utilisation du produit.

Conservez le manuel.

Liste des pièces			
Code	Image	Nom	QTÉ.
1		Support de roue	1
2		Plaque de pédale	1
3		Plaque de roue	1

4		Montage du levier de vitesses Bras	1
5		Bras de levier de vitesse	1
6		Chaise de jeu Berceau	1
7		Support de berceau	2
8		Plaque de changement de vitesse	1
9		Plaque de frein à main	1
10		Plaque de pédale droite Support	1
11		Plaque de pédale gauche Support	1
12		Bouton 32-M8*20	1
13		Bouton 38-M8*20	4
14		Pieds	4
15		Vis M6*16	12
16		Vis M8*16	18
17		Vis M8*50	6
18		Écrou M6	12
19		Rondelle 8	22

20		Écrou M8	6
21		Clé Allen 4	1
22		Clé Allen 5	1
23		Roulettes universelles	2
24		Fille 10	1
25		Fille 12	1
26		Fille 13	1
27		Sangle de fixation	6

Remarque : 12 vis M6 x 16, 6 écrous M6 et 2 roulettes universelles sont complémentaires.

ÉTAPE 1 : Desserrez les deux boutons entourés pour déplier le support de roue.

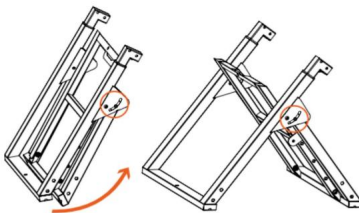

ÉTAPE 2 : Coupez les attaches en plastique, puis posez le cadre de la pédale et réinstallez le bouton rotatif à l'avant de la pédale. Et installez les pieds.

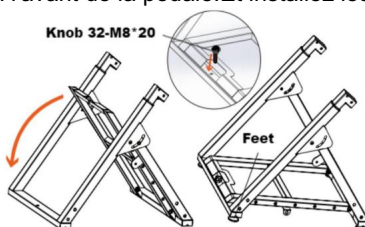

ÉTAPE 3 : Alignez les trous arrière de la plaque de pédale avec les trous arrière des supports de pédale et boulonnez à l'aide de 2 vis M8*16 et rondelles.

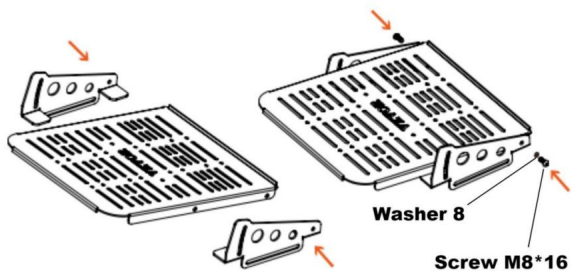

ÉTAPE 4 : Ajustez la plaque de pédale à l'angle souhaité et boulonnez-la à travers les trous avant à l'aide de 2 vis M8*16 et rondelles.

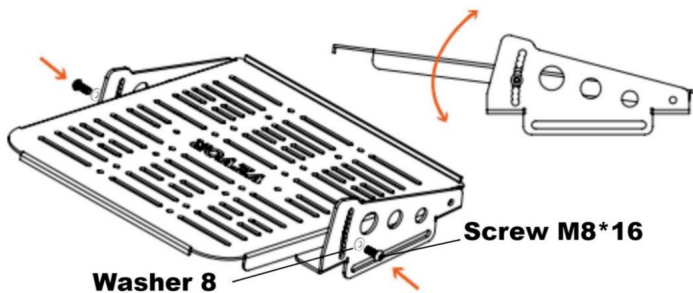

ÉTAPE 5 :

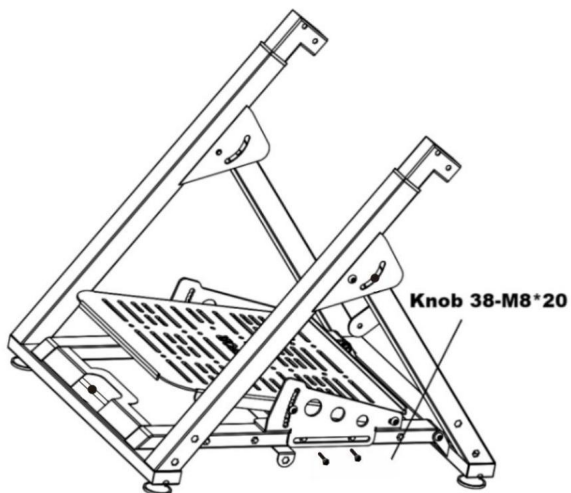

ÉTAPE 6 :

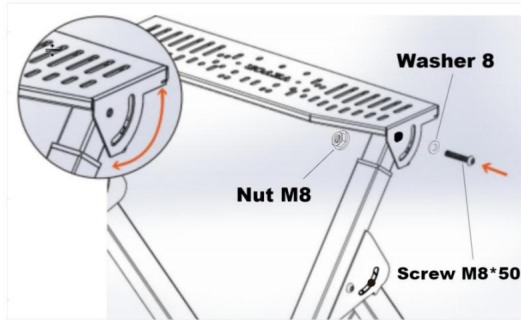

ÉTAPE 7 :

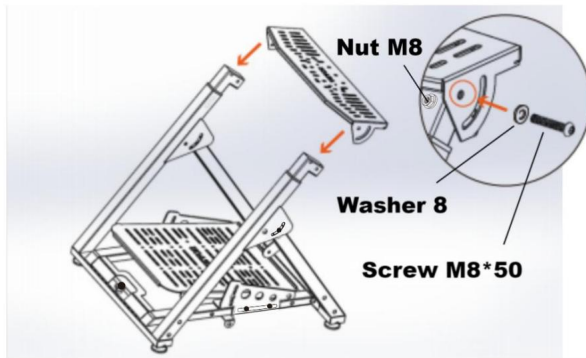

ÉTAPE 8 :

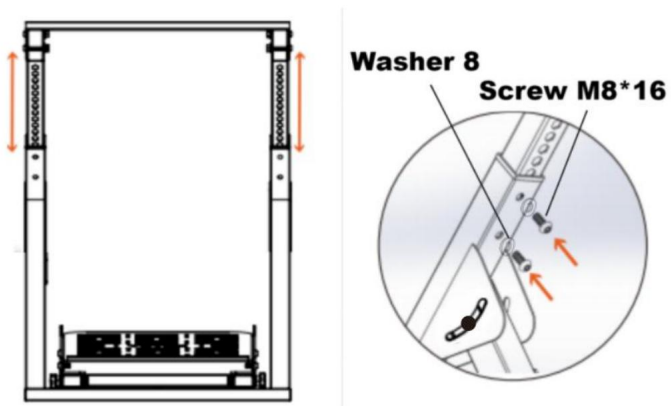

ÉTAPE 9 :

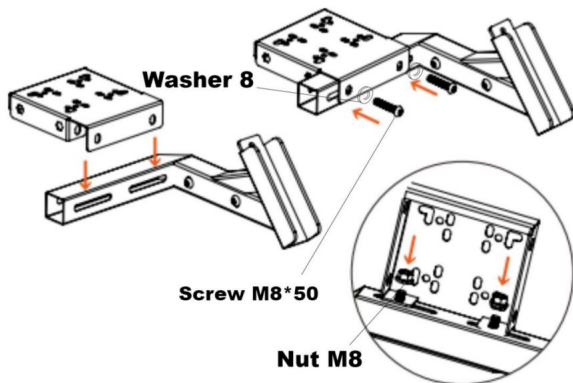

ÉTAPE 10 :

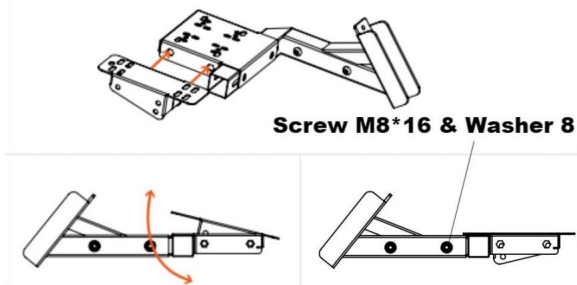

ÉTAPE 11 : Alignez les trous du bras de montage du levier de vitesses avec les inserts filetés sur le poteau vertical, choisissez la hauteur souhaitée et fixez-le avec 2 vis et rondelles M8*16 mm.

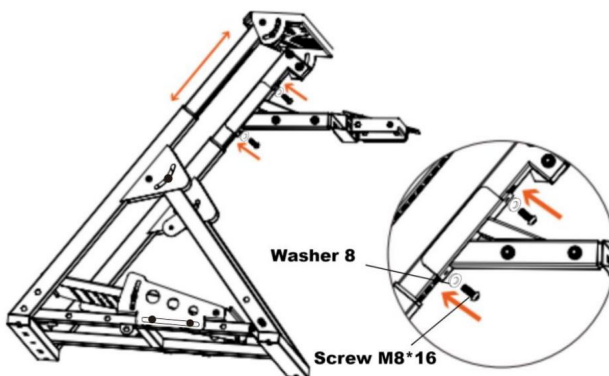

ÉTAPE 12 :

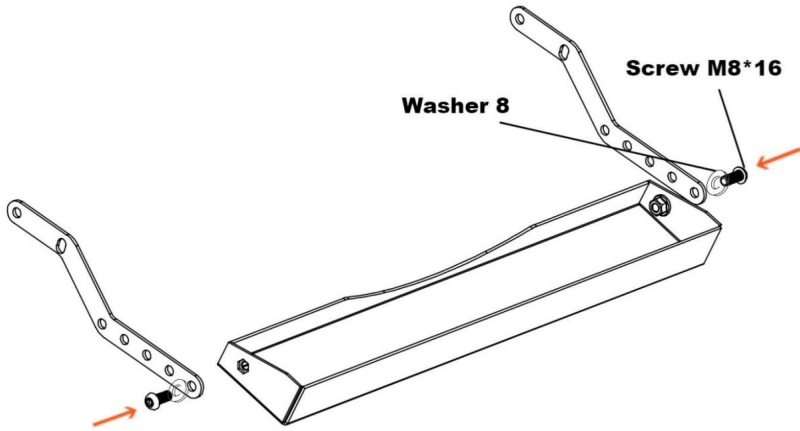

ÉTAPE 13 :

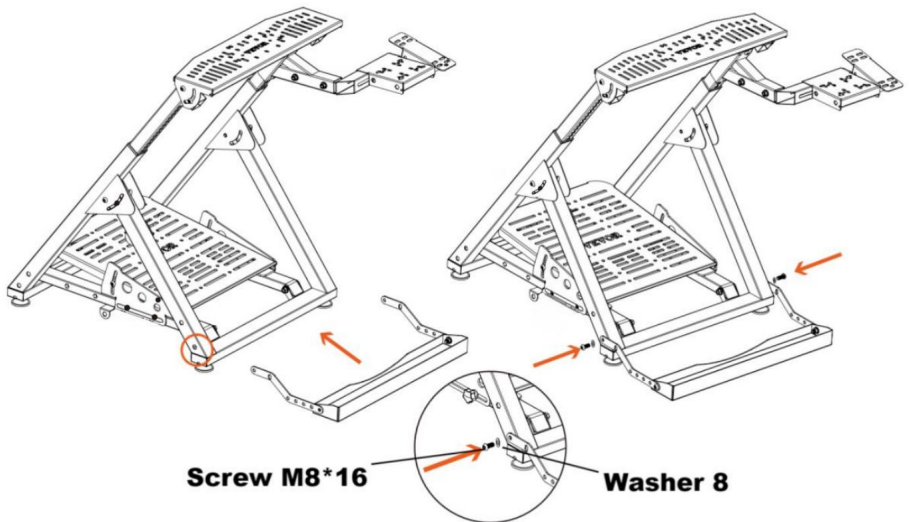

ÉTAPE 14 : Placement du siège

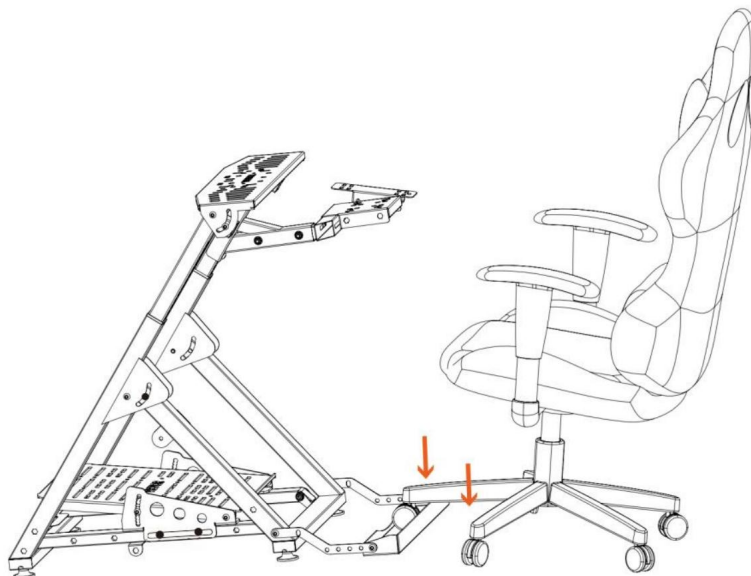

ÉTAPE 15 : Rangez le support de chaise de jeu comme indiqué pour permettre un pliage facile du support pour le stockage.

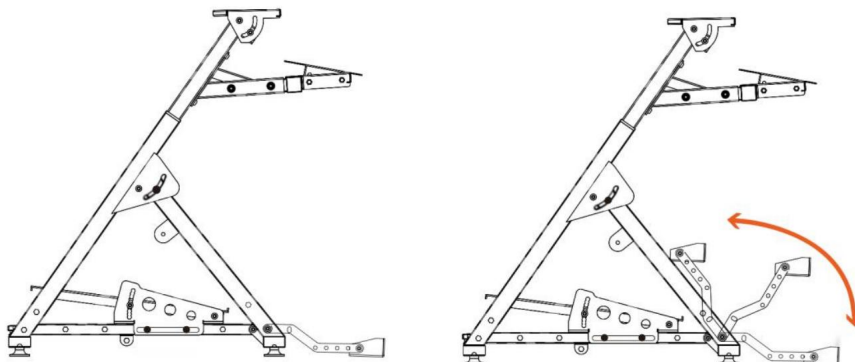

Fabricant : Shanghaimuxinmuyeyouxiangongsi

Adresse : Shuangchenglu 803nong11hao1602A-1609shi, baoshanqu, shanghai
200000 CN.

Importé en Australie : SIHAO PTY LTD. 1 ROKEVA STREETEASTWOOD
NSW 2122 Australie

Importé aux États-Unis : Sanven Technology Ltd. Suite 250, 9166 Anaheim
Lieu, Rancho Cucamonga, CA 91730



E-CrossStu GmbH

Mainzer Landstr.69, 60329 Francfort-sur-le-Main.



YH CONSULTING LIMITÉE.

A/S YH Consulting Limited Bureau 147, Centurion
Maison, London Road, Staines-upon-Thames, Surrey,
TW18 4AX

VEVOR®
TOUGH TOOLS, HALF PRICE

Assistance technique et certificat de garantie
électronique www.vevor.com/support

VEVOR[®]

TOUGH TOOLS, HALF PRICE

Technischer Support und E-Garantie-Zertifikat
www.vevor.com/support

LENKRADSTÄNDER

MODELL: WS-P02

Wir sind weiterhin bestrebt, Ihnen Werkzeuge zu wettbewerbsfähigen Preisen anzubieten. „Sparen Sie die Hälfte“, „Halber Preis“ oder andere ähnliche Ausdrücke, die wir verwenden, stellen nur eine Schätzung der Ersparnis dar, die Sie beim Kauf bestimmter Werkzeuge bei uns im Vergleich zu den großen Topmarken erzielen können, und decken nicht unbedingt alle von uns angebotenen Werkzeugkategorien ab. Wir möchten Sie freundlich daran erinnern, bei Ihrer Bestellung bei uns sorgfältig zu prüfen, ob Sie im Vergleich zu den großen Topmarken tatsächlich die Hälfte sparen.

VEVOR[®]
TOUGH TOOLS, HALF PRICE

**LENKRAD
STAND**

MODELL: WS-P02

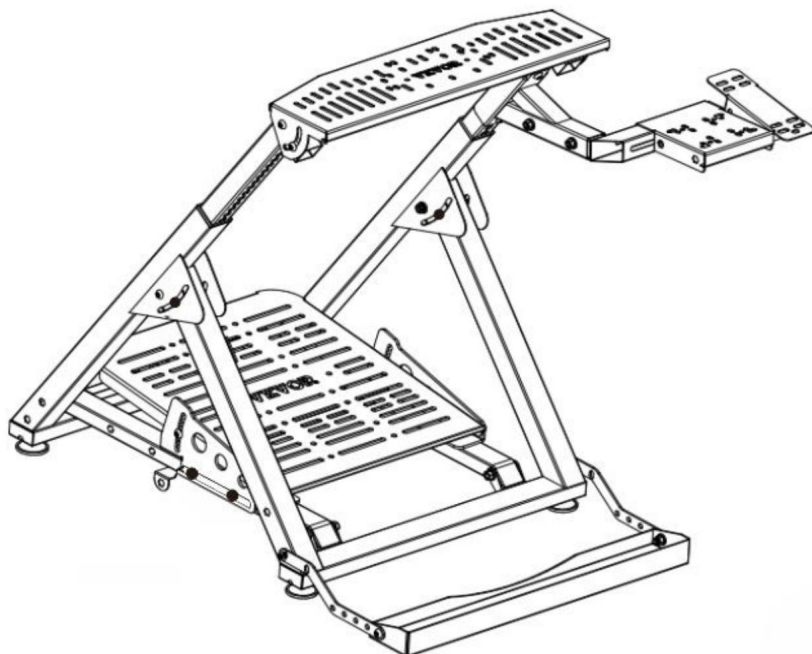

Brauchen Sie Hilfe? Kontaktieren Sie uns!

Haben Sie Fragen zum Produkt? Benötigen Sie technischen Support? Bitte kontaktieren Sie uns:

**Technischer Support und E-Garantie-Zertifikat [www.vevor.com/
support](http://www.vevor.com/support)**

Dies ist die Originalanleitung. Bitte lesen Sie alle Anweisungen im Handbuch. sorgfältig vor der Inbetriebnahme. VEVOR behält sich eine klare Auslegung unserer Benutzerhandbuch. Das Erscheinungsbild des Produkts unterliegt den Produkt, das Sie erhalten haben. Bitte haben Sie Verständnis, dass wir Sie nicht erneut informieren, wenn es gibt Technologie- oder Software-Updates für unser Produkt.



Warnung-Um das Verletzungsrisiko zu verringern, muss der Benutzer Lesen Sie die Bedienungsanleitung sorgfältig durch.

Aufmerksamkeiten

Bitte installieren und verwenden Sie den Ständer gemäß der Anleitung.

Bitte installieren Sie ihn maßvoll und vermeiden Sie starke Vibrationen.

















Nicht an einem feuchten Ort, bei hohen Temperaturen oder an einem staubigen Ort aufbewahren.









Die Produktstruktur ist flexibel. Tragen Sie während der Montage Arbeitshandschuhe.

Achten Sie bei der Montage darauf, dass Sie Ihre Hände nicht verletzen. Kinder sollten das Produkt nur unter Aufsicht eines Erwachsenen verwenden.

Bewahren Sie das Handbuch auf.

Stückliste			
Code	Bild	Name	MENGE.
1	A line drawing of a bicycle stand with two main legs and a horizontal bar at the top.	Radständer	1
2	A rectangular plate with a grid of small holes and a central slot.	Pedalplatte	1
3	A rectangular plate with a grid of small holes and a central slot, similar to the one above but with a slightly different shape.	Radplatte	1

4		Schalthebelmontage Arm	1
5		Schalthebel	1
6		Gaming Stuhl Wiege	1
7		Halterung für Wiege	2
8		Schaltplatte	1
9		Handbremsplatte	1
10		Rechte Pedalplatte Klammer	1
11		Linke Pedalplatte Klammer	1
12		Knopf 32-M8*20	1
13		Knopf 38-M8*20	4
14		FüÙe	4
15		Schraube M6*16	12
16		Schraube M8*16	18
17		Schraube M8*50	6
18		Mutter M6	12
19		Unterlegscheibe 8	22

20		Mutter M8	6
21		Inbusschlüssel 4	1
22		Inbusschlüssel 5	1
23		Universalrollen	2
24		Dirne 10	1
25		Dirne 12	1
26		Dirne 13	1
27		Bindeband	6

Hinweis: 12 Stück Schrauben M6 x 16, 6 Stück Muttern M6 und 2 Stück Universalrollen sind kostenlos.

SCHRITT 1: Lösen Sie die beiden eingekreisten Knöpfe, um den Radständer auszuklappen.

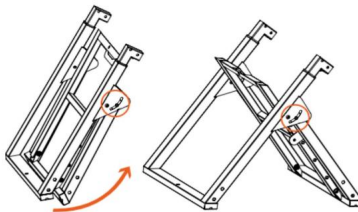

SCHRITT 2: Schneiden Sie die Plastikbänder ab, legen Sie dann den Pedalrahmen hin und bringen Sie den Drehknopf an der Vorderseite des Pedals wieder an und montieren Sie die Füße.

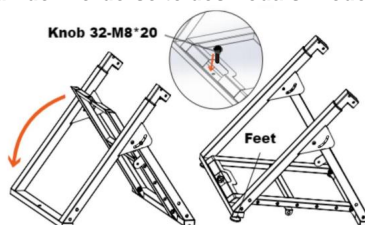

SCHRITT 3: Richten Sie die hinteren Löcher der Pedalplatte an den hinteren Löchern der Pedalhalterungen aus und schrauben Sie sie mit 2 x M8*16-Schrauben und Unterlegscheiben fest.

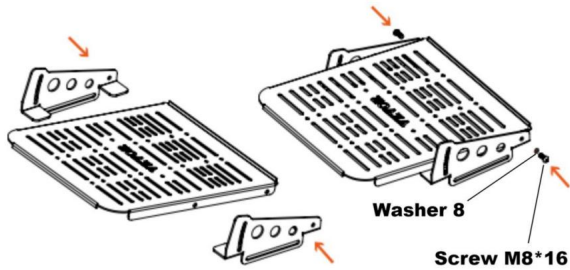

SCHRITT 4: Stellen Sie die Pedalplatte auf den gewünschten Winkel ein und schrauben Sie sie mit 2 x M8*16 Schrauben und Unterlegscheiben durch die vorderen Löcher.

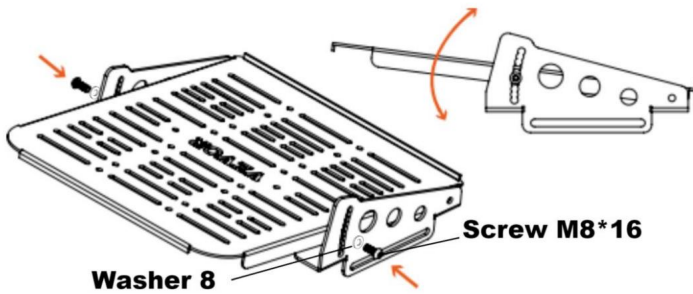

SCHRITT 5:

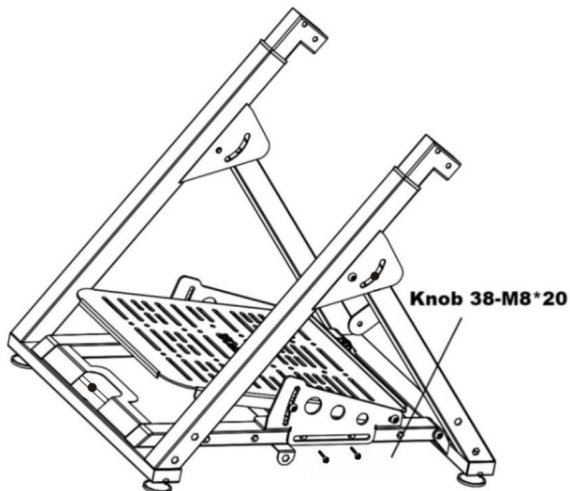

SCHRITT 6:

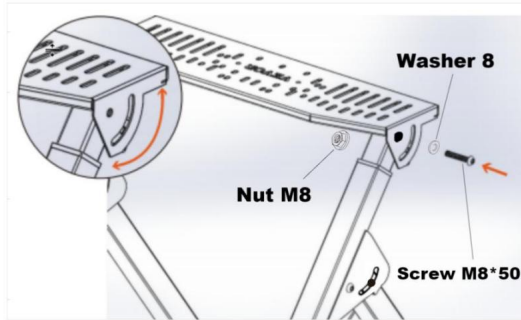

SCHRITT 7:

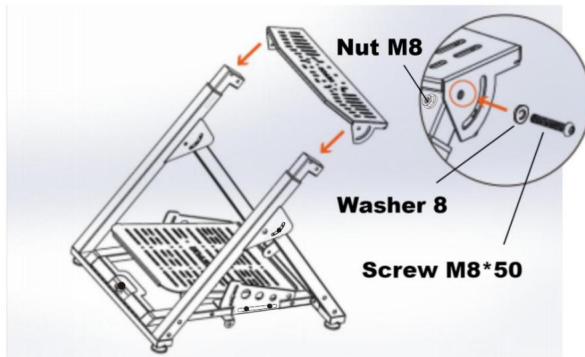

SCHRITT 8:

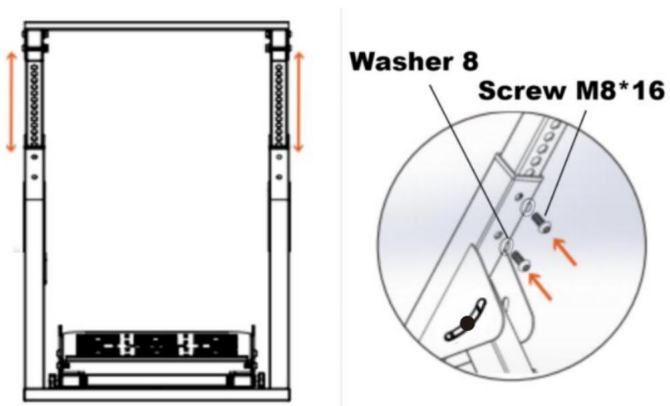

SCHRITT 9:

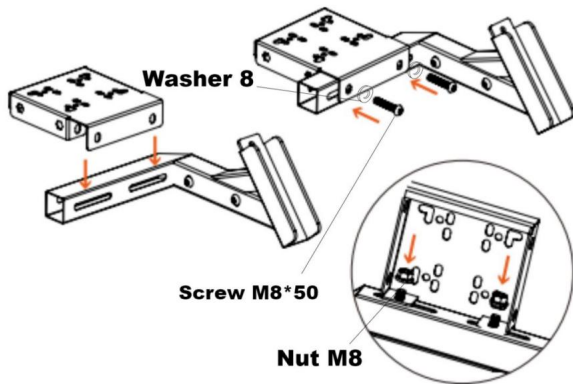

SCHRITT 10:

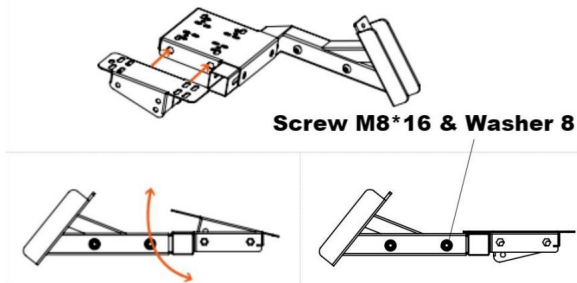

SCHRITT 11: Richten Sie die Löcher am Schalthebel-Montagearm mit den Gewindeeinsätzen am vertikalen Pfosten aus, wählen Sie die gewünschte Höhe und befestigen Sie sie mit 2 x M8 x 16 mm Schrauben und Unterlegscheiben.

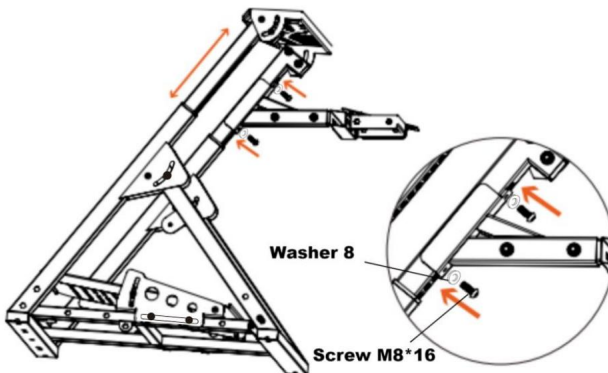

SCHRITT 12:

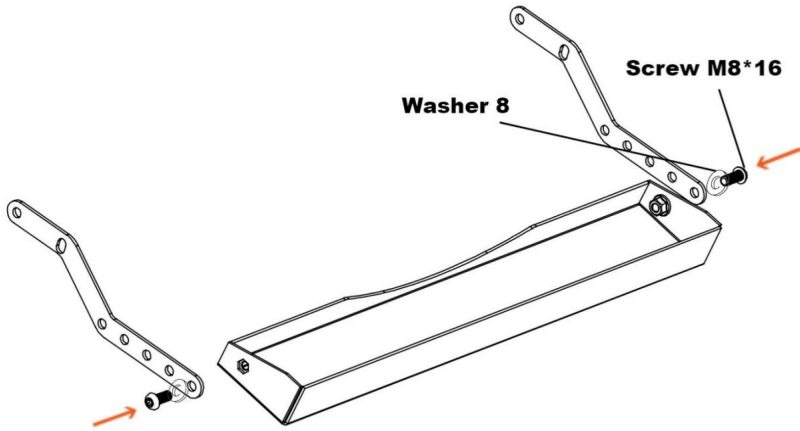

SCHRITT 13:

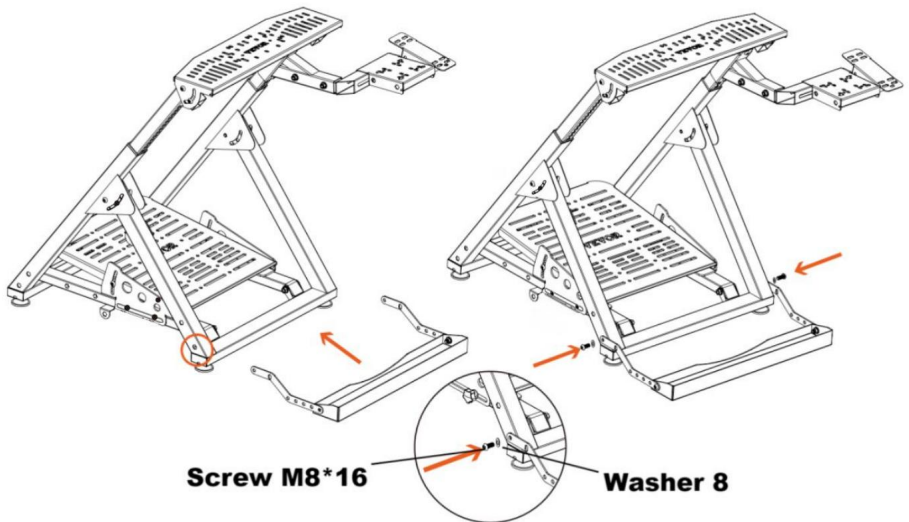

SCHRITT 14: Sitzplatzierung

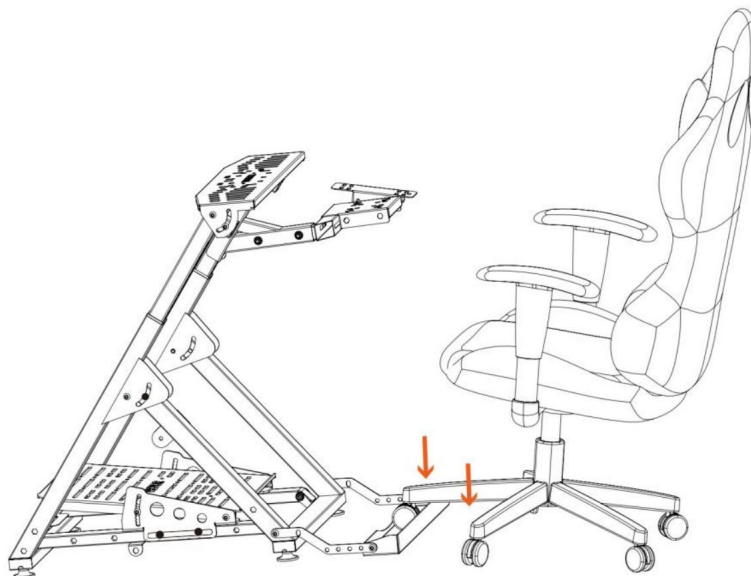

SCHRITT 15: Verstauen Sie die Gaming Chair Cradle wie gezeigt, damit Sie den Ständer einfach zusammenklappen und verstauen können.

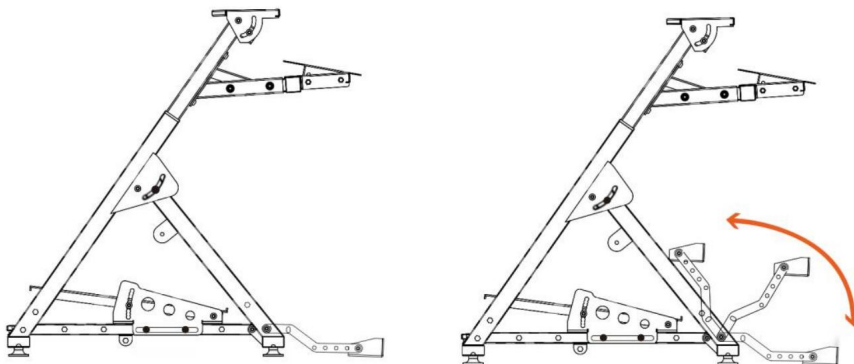

Hersteller: Shanghaimuxinmuyeyouxiangongsi

Adresse: Shuangchenglu 803nong11hao1602A-1609shi, baoshanqu,
Shanghai 200000 CN.

Nach AUS importiert: SIHAO PTY LTD. 1 ROKEVA STREETEASTWOOD
NSW 2122 Australien

Importiert in die USA: Sanven Technology Ltd. Suite 250, 9166 Anaheim
Ort, Rancho Cucamonga, CA 91730

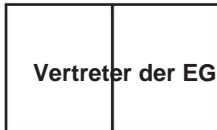

E-CrossStu GmbH

Mainzer Landstr.69, 60329 Frankfurt am Main.



YH CONSULTING LIMITED.

C/O YH Consulting Limited Office 147, Centurion
Haus, London Road, Staines-upon-Thames, Surrey,
TW18 4AX

VEVOR®
TOUGH TOOLS, HALF PRICE

Technischer Support und E-Garantie-Zertifikat
www.vevor.com/support

VEVOR[®]

TOUGH TOOLS, HALF PRICE

Supporto tecnico e certificato di garanzia

elettronica www.vevor.com/support

SUPPORTO PER VOLANTE

MODELLO: WS-P02

Continuiamo a impegnarci per fornirvi strumenti a prezzi competitivi.

"Risparmia la metà", "Metà prezzo" o qualsiasi altra espressione simile da noi utilizzata rappresenta solo una stima del risparmio che potresti ottenere acquistando determinati utensili con noi rispetto ai principali marchi principali e non significa necessariamente coprire tutte le categorie di utensili da noi offerti. Ti ricordiamo gentilmente di verificare attentamente quando effettui un ordine con noi se stai effettivamente risparmiando la metà rispetto ai principali marchi principali.

VEVOR[®]

TOUGH TOOLS, HALF PRICE

VOLANTE

IN PIEDI

MODELLO: WS-P02

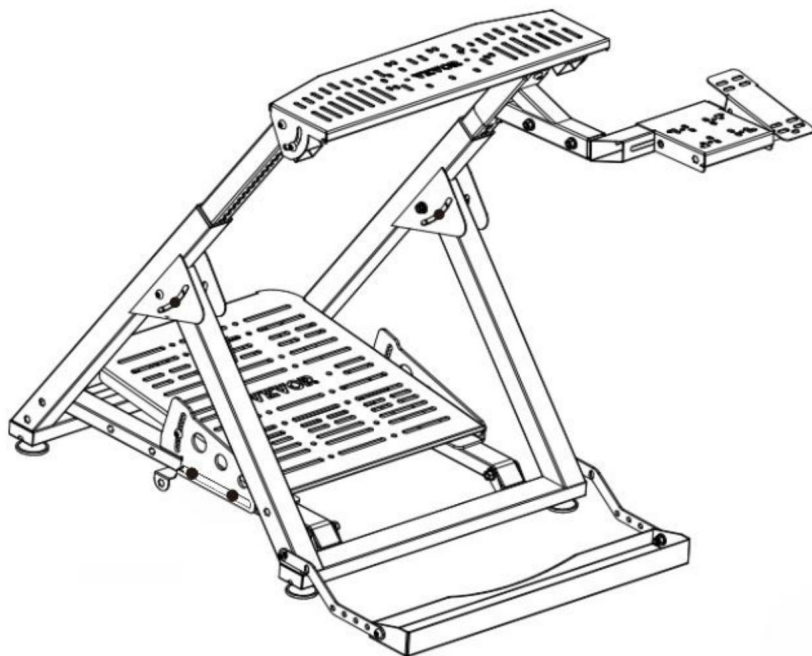

HAI BISOGNO DI AIUTO? CONTATTACI!

Hai domande sul prodotto? Hai bisogno di supporto tecnico? Non esitare a contattarci:

Supporto

**tecnico e certificato di garanzia elettronica [www.vevor.com/
support](http://www.vevor.com/support)**

Questa è l'istruzione originale, si prega di leggere tutte le istruzioni del manuale attentamente prima di operare. VEVOR si riserva una chiara interpretazione del nostro manuale utente. L'aspetto del prodotto sarà soggetto alla prodotto che hai ricevuto. Perdonaci se non ti informeremo di nuovo se ci sono aggiornamenti tecnologici o software sul nostro prodotto.



Attenzione: per ridurre il rischio di lesioni, l'utente deve leggere attentamente il manuale di istruzioni.

Attenzioni

ÿ Installare e utilizzare il supporto secondo le istruzioni. ÿ Installare con moderazione, evitare forti vibrazioni.



Non conservare in condizioni di umidità, temperature elevate o luoghi polverosi.







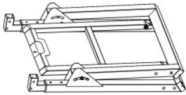
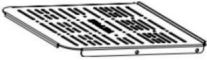





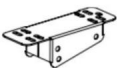

ÿ La struttura del prodotto è flessibile, indossare guanti da lavoro durante il montaggio.









Fare attenzione a non ferirsi le mani durante l'installazione. ÿ I

bambini devono utilizzare il prodotto solo sotto la supervisione di un adulto.

Salva il manuale.

Elenco delle parti			
Codice	Immagine	Nome	QTY.
1		Supporto per ruota	1
2		Piastra del pedale	1
3		Piastra della ruota	1

4		Montaggio del cambio Braccio	1
5		Braccio del cambio	1
6		Sedia da gioco Culla	1
7		Staffa di supporto	2
8		Piastra del cambio	1
9		Piastra freno a mano	1
10		Piastra del pedale destro Staffa	1
11		Piastra pedale sinistro Staffa	1
12		Manopola 32-M8*20	1
13		Manopola 38-M8*20	4
14		Piedi	4
15		Vite M6*16	12
16		Vite M8*16	18
17		Vite M8*50	6
18		Dado M6	12
19		Rondella 8	22

20		Dado M8	6
21		Chiave esagonale 4	1
22		Chiave esagonale 5	1
23		Ruote universali	2
24		Ragazza 10	1
25		Ragazza 12	1
26		Ragazza 13	1
27		Cinghia di legatura	6

Nota: 12 viti M6*16, 6 dadi M6 e 2 ruote universali sono gratuiti.

FASE 1: Allentare le due manopole cerchiate per aprire il cavalletto.

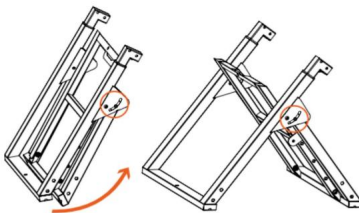

FASE 2: Tagliare le fascette di plastica, quindi adagiare il telaio del pedale e Reinstallare la manopola girevole nella parte anteriore del pedale e installare i piedini.

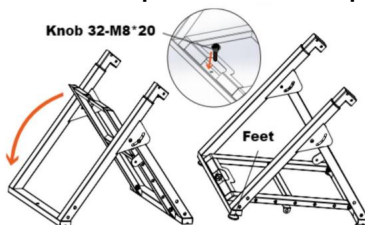

FASE 3: Allinea i fori posteriori sulla piastra del pedale con i fori posteriori sulle staffe del pedale e avvitali utilizzando 2 viti M8*16 e rondelle.

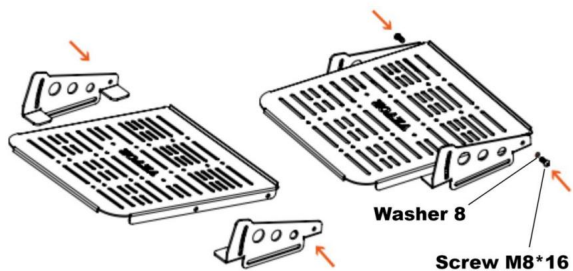

FASE 4: Regolare la piastra del pedale all'angolazione desiderata e avvitare attraverso i fori anteriori utilizzando 2 viti M8*16 e rondelle.

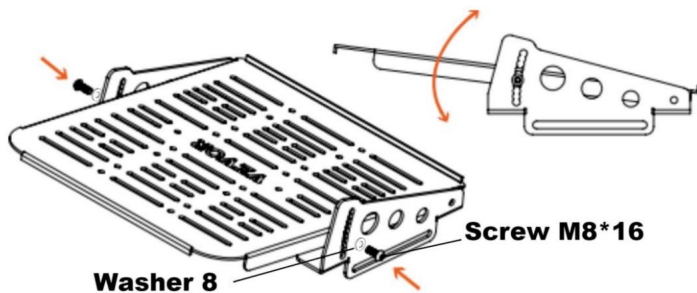

PASSO 5:

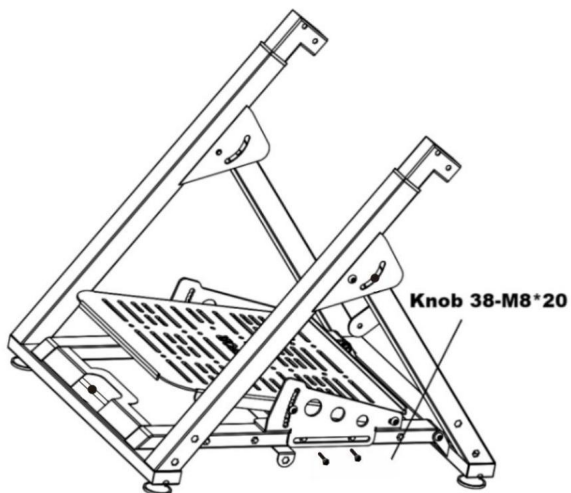

PASSO 6:

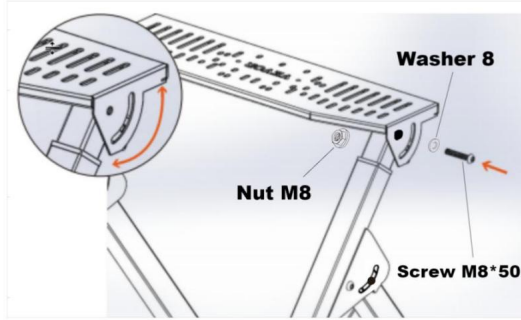

PASSO 7:

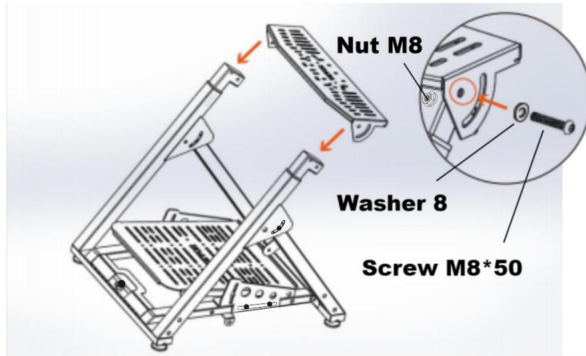

PASSO 8:

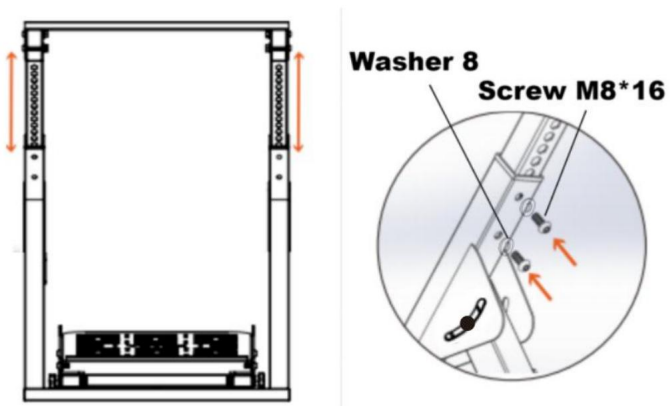

PASSO 9:

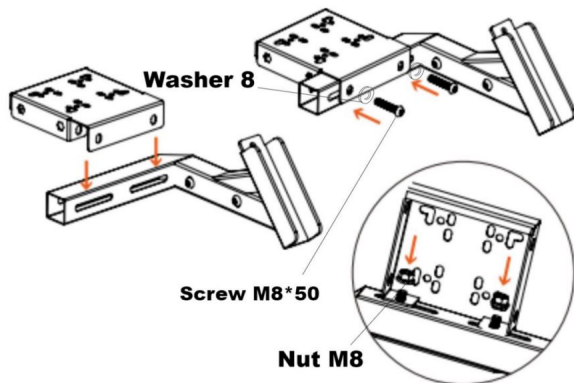

PASSO 10:

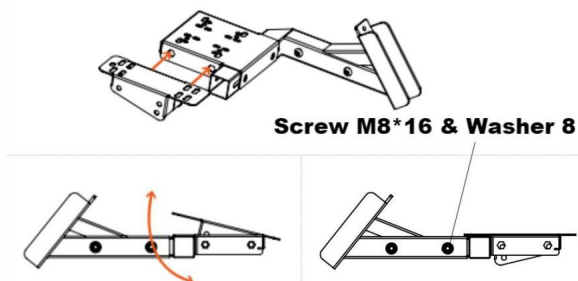

FASE 11: Allineare i fori sul braccio di montaggio del cambio con gli inserti filettati sul montante verticale; scegliere l'altezza desiderata fissando con 2 viti M8*16mm e rondelle.

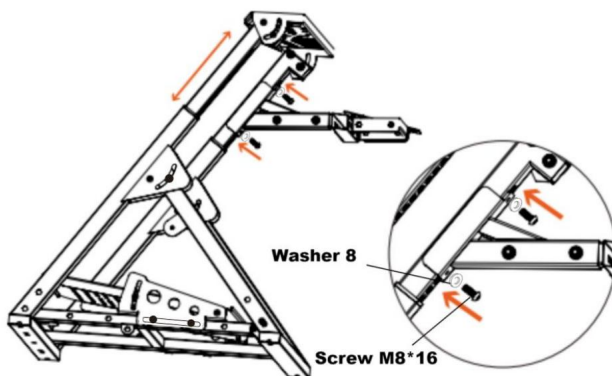

PASSO 12:

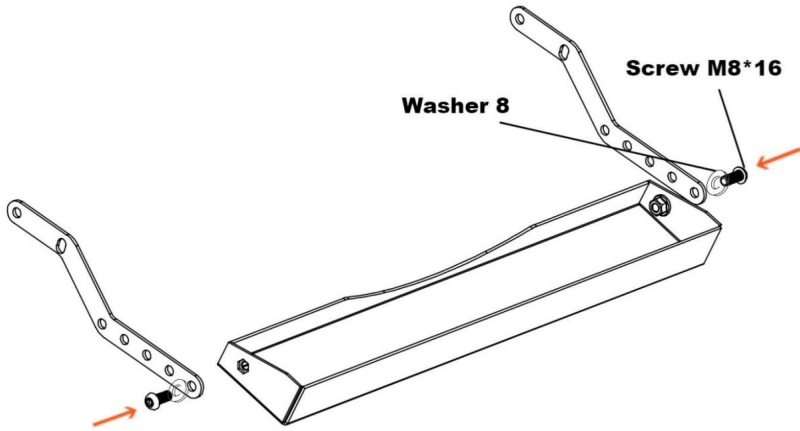

PASSO 13:

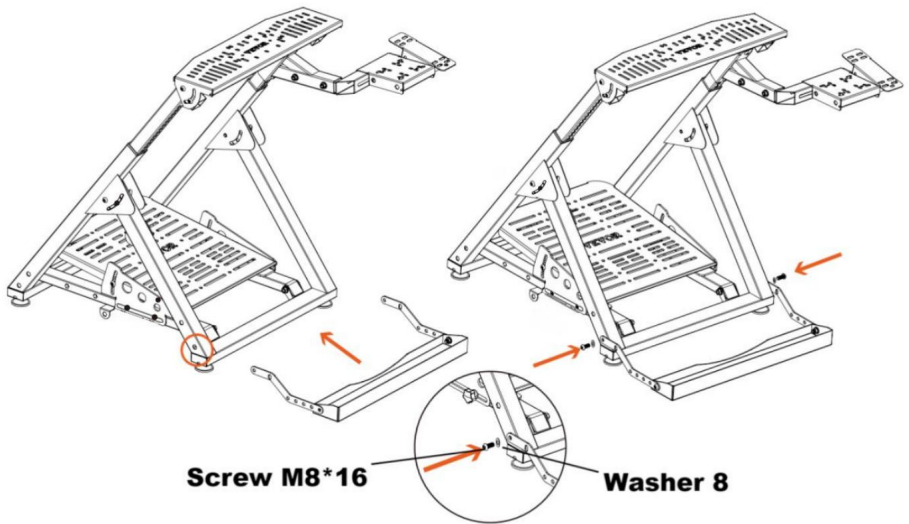

FASE 14: Posizionamento del sedile



FASE 15: Riporre il supporto della sedia da gaming come mostrato in figura per poterlo ripiegare facilmente e riportarlo.

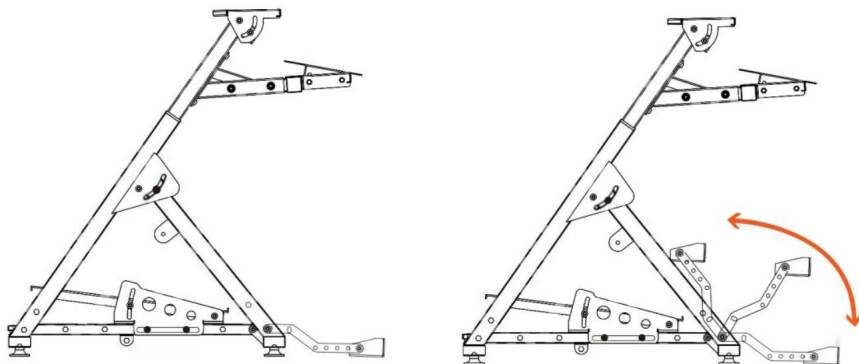

Produttore: Shanghaimuxinmuyeyouxiangongsi

Indirizzo: Shuangchenglu 803nong11hao1602A-1609shi, baoshanqu, shanghai 200000 CN.

Importato in AUS: SIHAO PTY LTD. 1 ROKEVA STREETEASTWOOD

Nuovo Galles del Sud 2122 Australia

Importato negli USA: Sanven Technology Ltd. Suite 250, 9166 Anaheim Luogo, Rancho Cucamonga, CA 91730

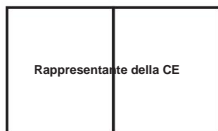

E-CrossStu GmbH

Mainzer Landstr.69, 60329 Francoforte sul Meno.



CONSULENZA YH LIMITATA.

C/O YH Consulting Limited Ufficio 147, Centurion Casa, London Road, Staines-upon-Thames, Surrey, TW184AX

VEVOR®
TOUGH TOOLS, HALF PRICE

Supporto tecnico e certificato di garanzia
elettronica www.vevor.com/support

VEVOR[®]

TOUGH TOOLS, HALF PRICE

Soporte técnico y certificado de garantía

electrónica www.vevor.com/support

SOPORTE PARA VOLANTE

MODELO: WS-P02

Seguimos comprometidos a brindarle herramientas a precios competitivos.

"Ahorre la mitad", "mitad de precio" o cualquier otra expresión similar que utilicemos solo representa una estimación del ahorro que podría obtener al comprar ciertas herramientas con nosotros en comparación con las principales marcas y no necesariamente significa que cubra todas las categorías de herramientas que ofrecemos. Le recordamos que, al realizar un pedido con nosotros, verifique cuidadosamente si realmente está ahorrando la mitad en comparación con las principales marcas.

VEVOR[®]
TOUGH TOOLS, HALF PRICE

VOLANTE

PARARSE

MODELO: WS-P02

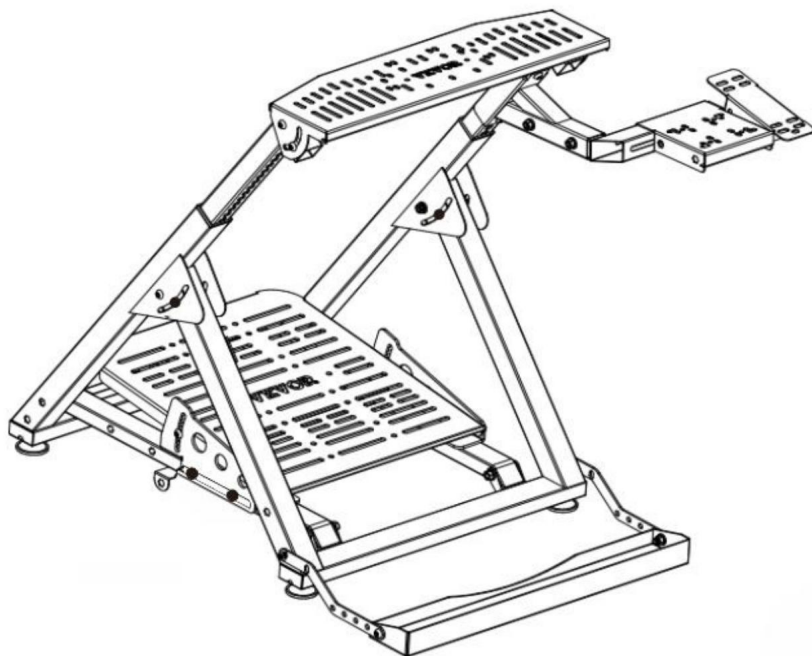

¿NECESITAS AYUDA? ¡CONTÁCTANOS!

¿Tiene preguntas sobre el producto? ¿Necesita asistencia técnica? No dude en ponerse en contacto con

nosotros: Asistencia técnica y certificado de garantía electrónica
www.vevor.com/support

Estas son las instrucciones originales, lea todas las instrucciones del manual. antes de operar. VEVOR se reserva una interpretación clara de nuestras manual de usuario. La apariencia del producto estará sujeta a las producto que recibiste. Por favor, perdónanos por no informarte nuevamente si ¿Hay alguna actualización tecnológica o de software en nuestro producto?



Advertencia: Para reducir el riesgo de lesiones, el usuario debe leer Lea atentamente el manual de instrucciones.



Atenciones







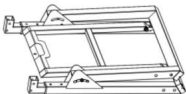









Instale y utilice el soporte de acuerdo con las instrucciones. Instale con moderación, evite vibraciones fuertes.









No lo guarde en condiciones de humedad, altas temperaturas o en lugares polvorientos.

La estructura del producto es flexible, use guantes de trabajo durante el ensamblaje. Tenga cuidado de no lastimarse las manos durante la instalación. Los niños deben estar bajo la supervisión de un adulto cuando utilicen el producto.

Guarde el manual.

Lista de piezas			
Código	Imagen	Nombre	CANTIDAD.
1		Soporte de rueda	1
2		Placa de pedal	1
3		Placa de rueda	1

4		Montaje de la palanca de cambios Brazo	1
5		Brazo de cambio	1
6		Silla para juegos Cuna	1
7		Soporte de cuna	2
8		Placa de cambio	1
9		Placa de freno de mano	1
10		Placa del pedal derecho Soporte	1
11		Placa del pedal izquierdo Soporte	1
12		Perilla 32-M8*20	1
13		Perilla 38-M8*20	4
14		Pies	4
15		Tornillo M6*16	12
16		Tornillo M8*16	18
17		Tornillo M8*50	6
18		Tuerca M6	12
19		Lavadora 8	22

20		Tuerca M8	6
21		Llave hexagonal 4	1
22		Llave hexagonal 5	1
23		Ruedas universales	2
24		Moza 10	1
25		Moza 12	1
26		Moza 13	1
27		Correa de encuadernación	6

Nota: 12 tornillos M6 x 16, 6 tuercas M6 y 2 ruedas universales.
son gratuitos.

PASO 1: Afloje las dos perillas marcadas con un círculo para desplegar el soporte de la rueda.

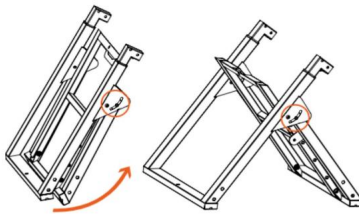

PASO 2: Corte las ataduras de plástico, luego coloque el marco del pedal y vuelva a instalar la perilla giratoria en la parte delantera del pedal e instale los pies.

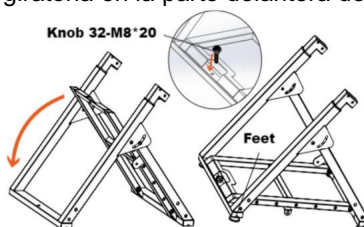

PASO 3: Alinee los orificios traseros de la placa del pedal con los orificios traseros de los soportes del pedal y atorníllelos usando 2 tornillos M8*16 y arandelas.

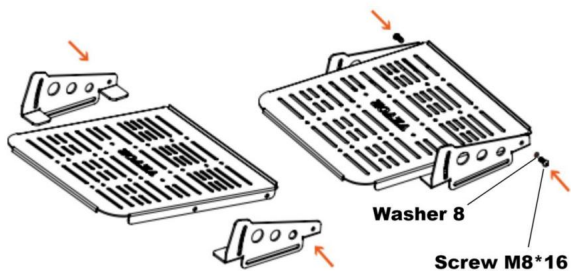

PASO 4: Ajuste la placa del pedal al ángulo deseado y atorníllela a través de los orificios frontales usando 2 tornillos M8*16 y arandelas.

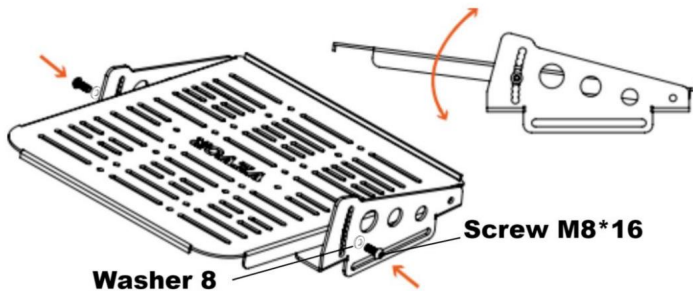

PASO 5:

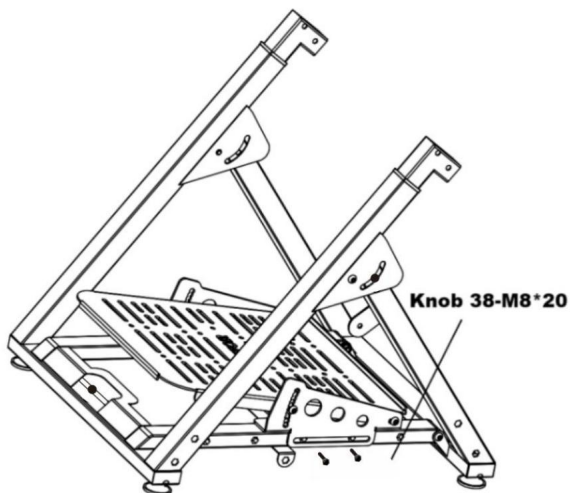

PASO 6:

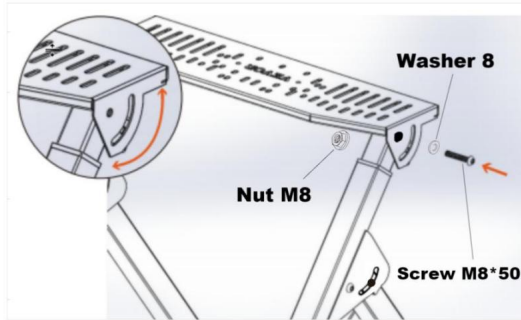

PASO 7:

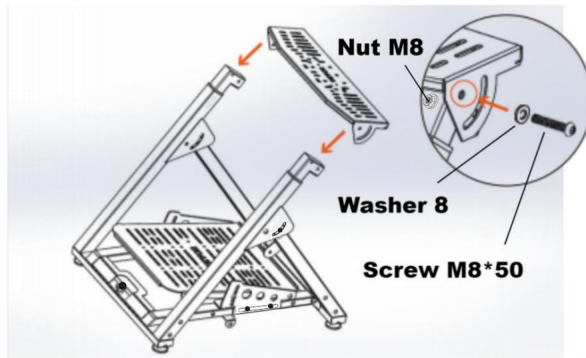

PASO 8:

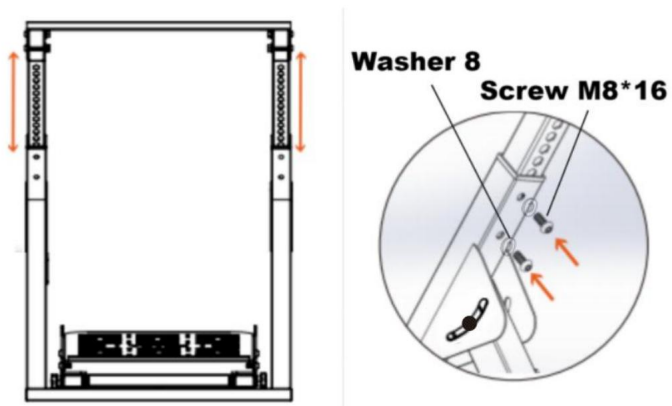

PASO 9:

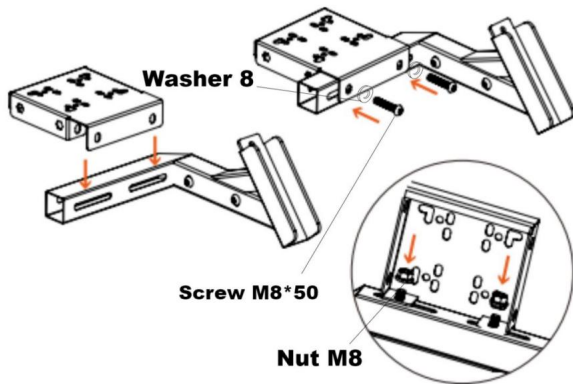

PASO 10:

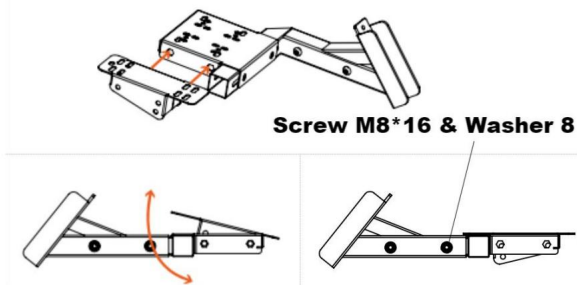

PASO 11: Alinee los orificios en el brazo de montaje de la palanca de cambios con los insertos roscados en el poste vertical, elija la altura deseada y asegure con 2 tornillos M8*16 mm y arandelas.

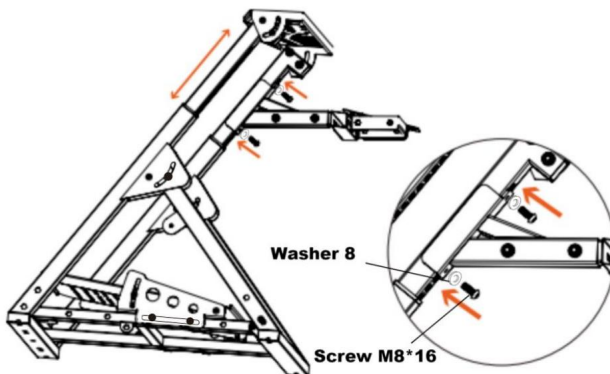

PASO 12:

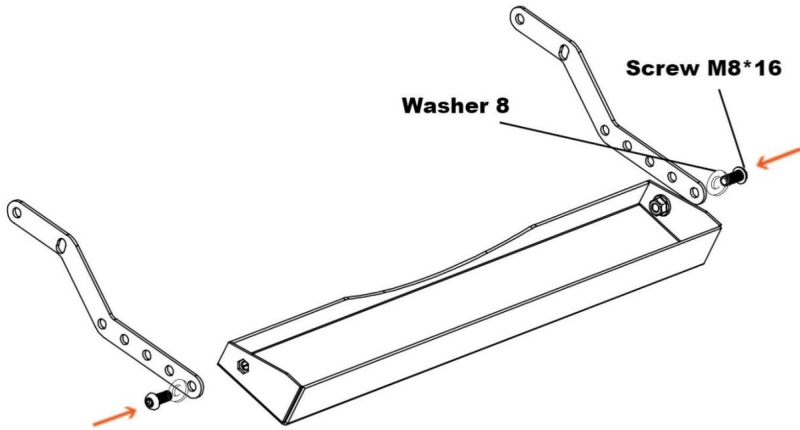

PASO 13:

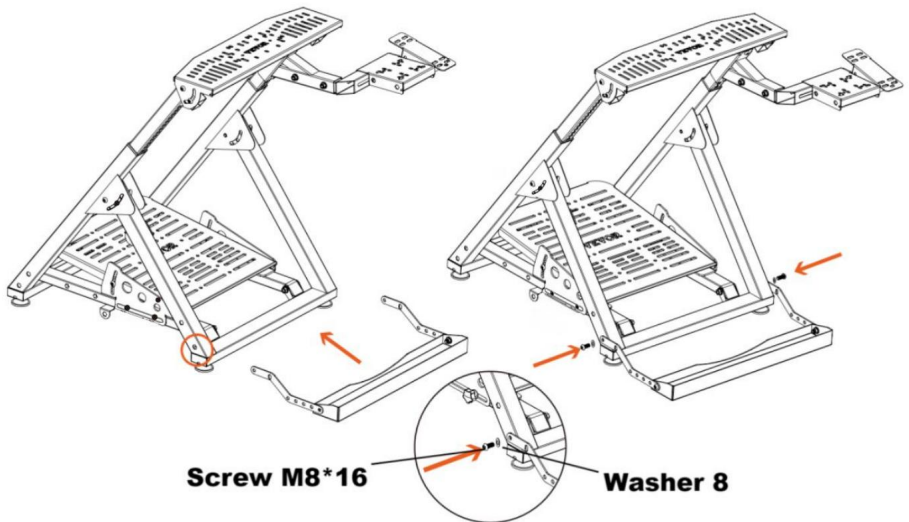

PASO 14: Colocación del asiento



PASO 15: Guarde la base de la silla de juego como se muestra para permitir plegar fácilmente el soporte para guardarlo.

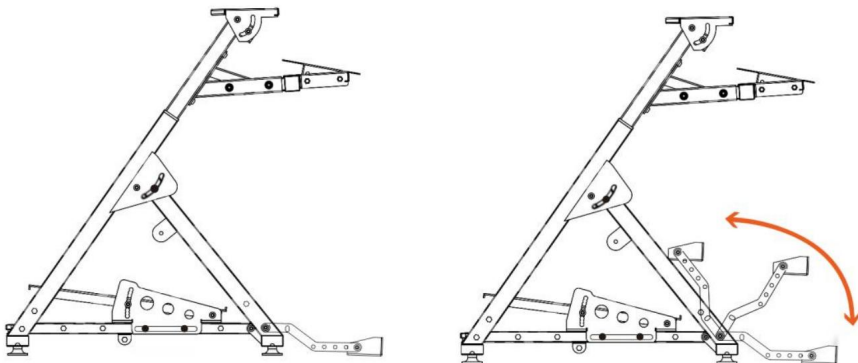

Fabricante: Shanghaimuxinmuyeyouxiangongsi

Dirección: Shuangchenglu 803nong11hao1602A-1609shi, baoshanqu, shanghai 200000 CN.

Importado a Australia: SIHAO PTY LTD. 1 ROKEVA STREETEASTWOOD

Nueva Gales del Sur 2122 Australia

Importado a EE. UU.: Sanven Technology Ltd. Suite 250, 9166 Anaheim Lugar, Rancho Cucamonga, CA 91730



E-CrossStu GmbH

Mainzer Landstr.69, 60329 Fráncfort del Meno.

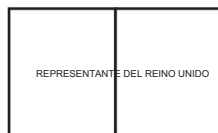

YH CONSULTING LIMITADA.

C/O YH Consulting Limited Oficina 147, Centurion Casa, London Road, Staines-upon-Thames, Surrey, TW18 4AX

VEVOR[®]
TOUGH TOOLS, HALF PRICE

Soporte técnico y certificado de garantía
electrónica www.vevor.com/support

VEVOR[®]

TOUGH TOOLS, HALF PRICE

Wsparcie techniczne i certyfikat gwarancji

elektronicznej www.vevor.com/support

PODSTAWKA POD KIEROWNICĘ

MODEL: WS-P02

Nadal staramy się oferować Państwu narzędzia w konkurencyjnych cenach.

„Oszczędź połowę”, „Połowa ceny” lub inne podobne wyrażenia używane przez nas stanowią jedynie szacunkowe oszczędności, jakie możesz uzyskać, kupując u nas określone narzędzia w porównaniu z głównymi markami i niekoniecznie oznaczają one objęcie wszystkich kategorii narzędzi oferowanych przez nas. Uprzejmie przypominamy, aby dokładnie sprawdzić, czy składając u nas zamówienie faktycznie oszczędzasz połowę w porównaniu z głównymi markami.

VEVOR[®]
TOUGH TOOLS, HALF PRICE

KIEROWNICA

PODSTAWKA

MODEL: WS-P02

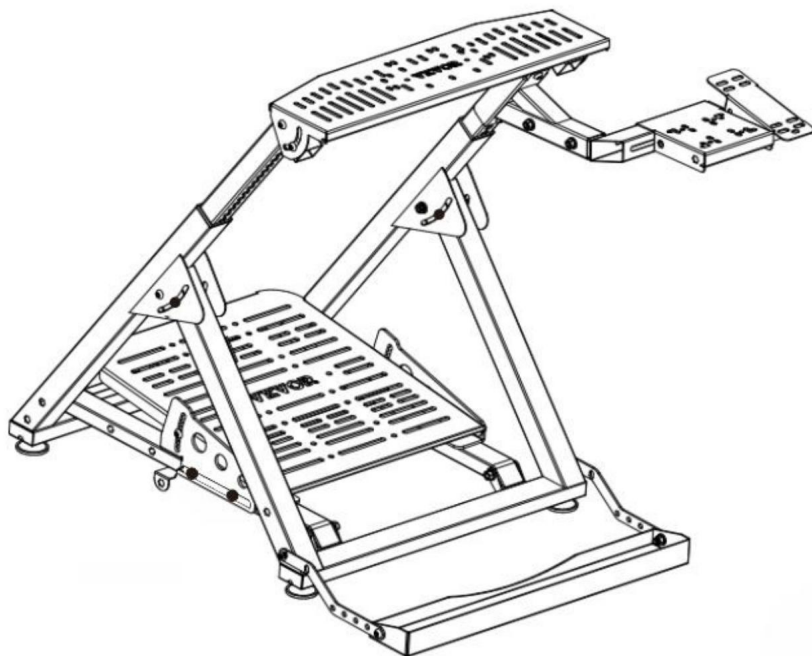

POTRZEBUJESZ POMOCY? SKONTAKTUJ SIĘ Z NAMI!

Masz pytania dotyczące produktu? Potrzebujesz wsparcia technicznego? Skontaktuj się z nami: Wsparcie

techniczne i certyfikat E-Gwarancji www.vevor.com/support

To jest oryginalna instrukcja, proszę przeczytać wszystkie instrukcje w podręczniku

przed rozpoczęciem użytkowania należy dokładnie zapoznać się z treścią niniejszego Regulaminu. VEVOR zastrzega sobie prawo do jednoznacznej interpretacji naszych

instrukcja obsługi. Wygląd produktu podlega

produkt, który otrzymałeś. Przepraszamy, że nie poinformujemy Cię ponownie, jeśli
czy w naszym produkcie pojawiły się jakieś aktualizacje technologii lub oprogramowania.



Ostrzeżenie – aby zmniejszyć ryzyko obrażeń, użytkownik musi przeczytać uważnie przeczytaj instrukcję obsługi.

Uprzejmości



Proszę zainstalować i używać stojaka zgodnie z instrukcją. Proszę zainstalować z umiarem, unikać silnych wibracji.







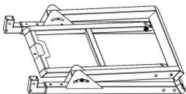









Nie przechowywać w wilgotnych warunkach, wysokiej temperaturze lub w miejscach zakurzonych.



Konstrukcja produktu jest elastyczna, podczas montażu należy założyć rękawice robocze.

Podczas instalacji należy uważać na zranione ręce. Dzieci powinny korzystać z produktu pod nadzorem osoby dorosłej.

Zapisz instrukcję.

Lista części			
Kod	Zdjęcie	Nazwa	ILOŚĆ.
1		Stojak na koła	1
2		Płytkę pedałową	1
3		Płytkę koła	1

4		Montaż dźwigni zmiany biegów Ramię	1
5		Ramię zmiany biegów	1
6		Fotel gamingowy Kolebka	1
7		Uchwyt kołyski	2
8		Płytki zmiany biegów	1
9		Płyta hamulca ręcznego	1
10		Prawa płytki pedału Nawias	1
11		Lewa płytki pedału Nawias	1
12		Gałka 32-M8*20	1
13		Gałka 38-M8*20	4
14		Stopy	4
15		Śruba M6*16	12
16		Śruba M8*16	18
17		Śruba M8*50	6
18		Nakrętka M6	12
19		Podkładka 8	22

20		Nakrętka M8	6
21		Klucz imbusowy 4	1
22		Klucz imbusowy 5	1
23		Uniwersalne kółka	2
24		Dziewczyno 10	1
25		Dziewczyno 12	1
26		Dziewczyno 13	1
27		Pasek wiążący	6

Uwaga: 12 śrub M6*16, 6 nakrętek M6 i 2 uniwersalne kółka są bezpłatne.

KROK 1: Aby rozłożyć stojak na koła, poluzuj dwa zaznaczone kółkami pokrętła.

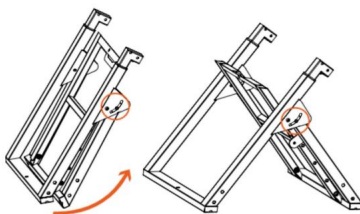

KROK 2: Odetnij plastikowe opaski zaciskowe, a następnie połóż ramę pedału i zamontuj ponownie pokrętło obrotowe z przodu pedału i zamontuj stopki.

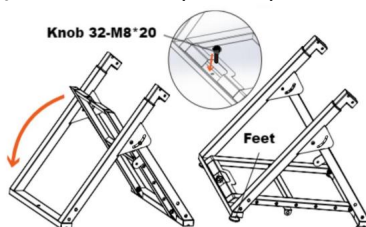

KROK 3: Dopasuj tylne otwory w płycie pedału do tylnych otworów w uchwytach pedałów i przykręć je za pomocą 2 śrub M8*16 z podkładkami.

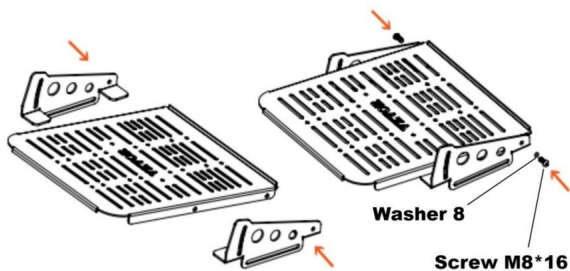

KROK 4: Ustaw płytę pedału pod żądanym kątem i przykręć ją przez przednie otwory za pomocą 2 śrub M8*16 i podkładek.

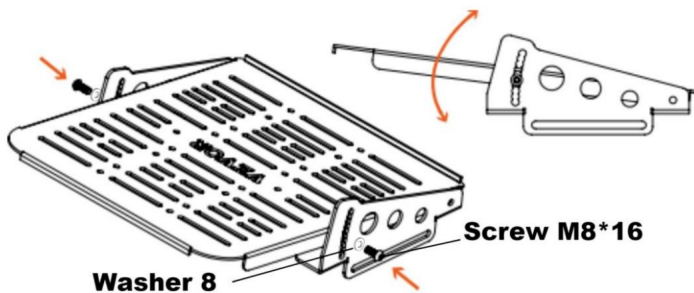

KROK 5:

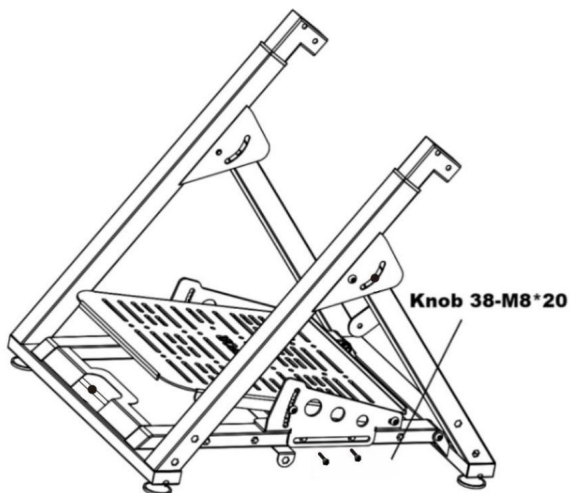

KROK 6:

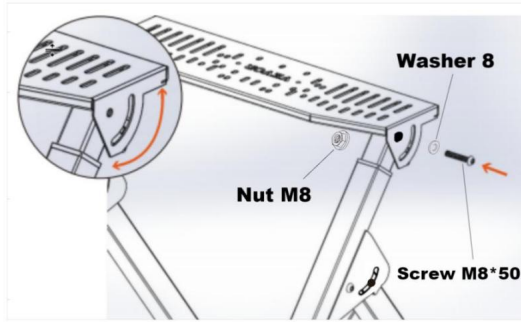

KROK 7:

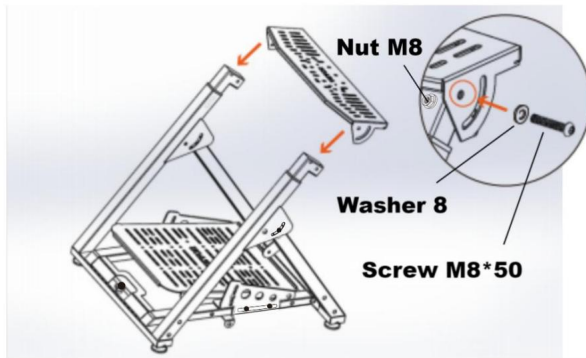

KROK 8:

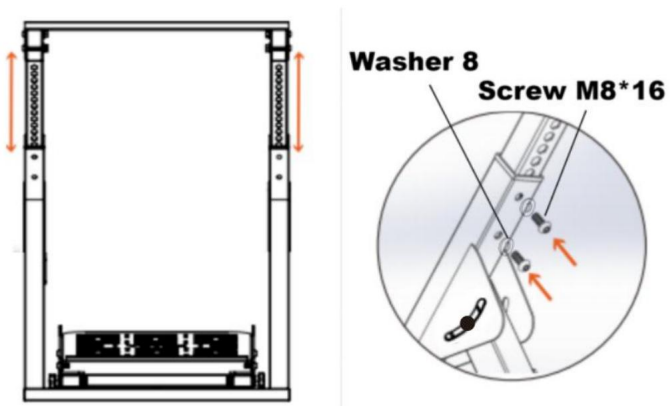

KROK 9:

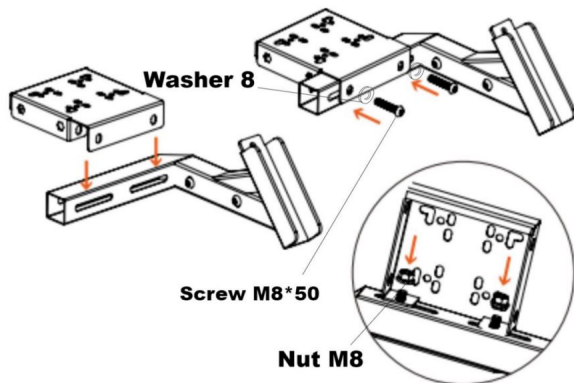

KROK 10:

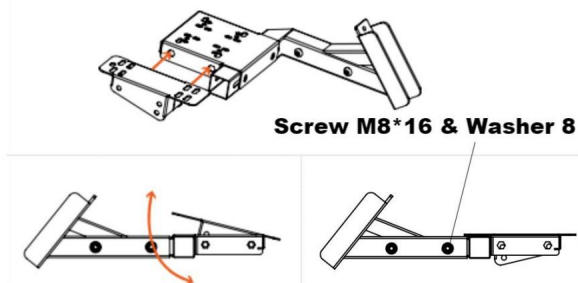

KROK 11: Dopasuj otwory w ramieniu montażowym dźwigni zmiany biegów do gwintowanych wkładek na pionowym słupku, wybierz żądaną wysokość i zabezpiecz ją za pomocą 2 śrub M8*16 mm i podkładek.

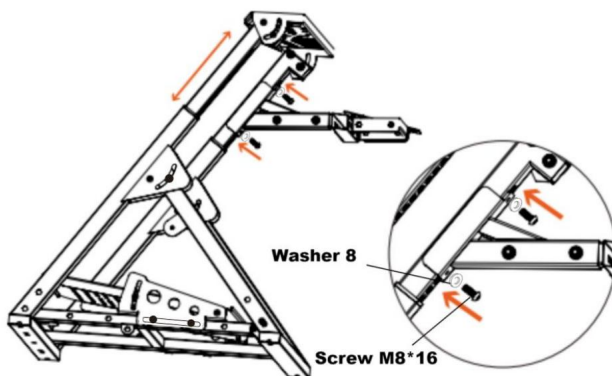

KROK 12:

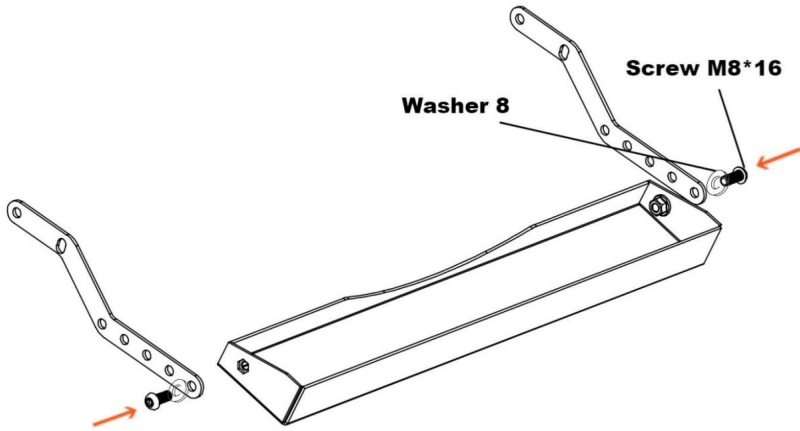

KROK 13:

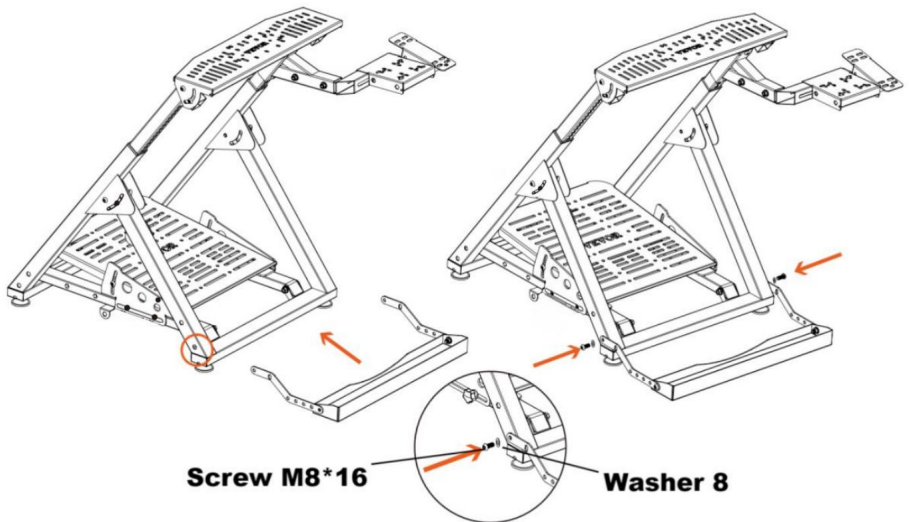

KROK 14: Ustawienie miejsc



KROK 15: Złóż podstawkę pod fotel gamingowy w sposób pokazany na zdjęciu, aby umożliwić łatwe złożenie podstawki w celu przechowywania.

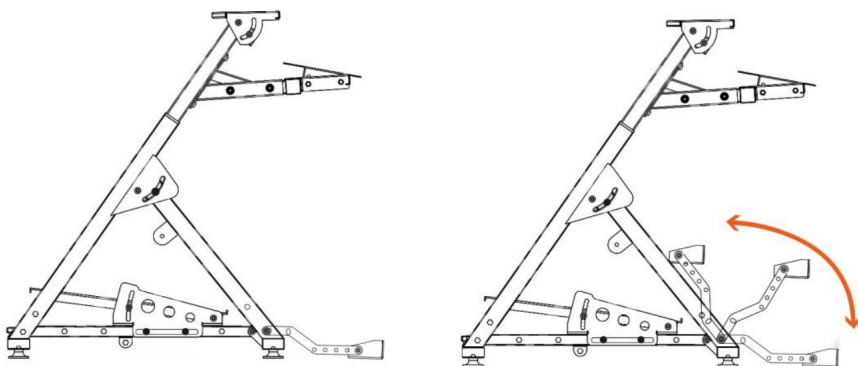

Producent: Shanghaimuxinmuyeyouxiangongsi

Adres: Shuangchenglu 803nong11hao1602A-1609shi, baoshanqu, szanghaj
200000 CN.

Importowane do AUS: SIHAO PTY LTD. 1 ROKEVA STREETEASTWOOD
NSW 2122 Australia

Importowane do USA: Sanven Technology Ltd. Suite 250, 9166 Anaheim
Miejsce, Rancho Cucamonga, CA 91730



E-CrossStu GmbH

Mainzer Landstr.69, 60329 Frankfurt nad Menem.



YH CONSULTING LIMITED.

C/O YH Consulting Limited Biuro 147, Centurion
Dom, London Road, Staines-upon-Thames, Surrey,
TW18 4AX

VEVOR®
TOUGH TOOLS, HALF PRICE

Wsparcie techniczne i certyfikat gwarancji
elektronicznej www.vevor.com/support

VEVOR[®]

TOUGH TOOLS, HALF PRICE

Technische ondersteuning en e-garantiecertificaat

www.vevor.com/support

STUURWIELSTANDAARD

MODEL: WS-P02

Wij streven er voortdurend naar om u gereedschappen tegen concurrerende prijzen te leveren.

"Save Half", "Half Price" of andere soortgelijke uitdrukkingen die wij gebruiken, geven alleen een schatting van de besparingen die u kunt behalen door bepaalde gereedschappen bij ons te kopen in vergelijking met de grote topmerken en betekent niet noodzakelijkerwijs dat alle categorieën gereedschappen die wij aanbieden, worden gedekt. Wij herinneren u eraan om zorgvuldig te controleren of u daadwerkelijk de helft bespaart in vergelijking met de grote topmerken wanneer u een bestelling bij ons plaatst.

VEVOR[®]

TOUGH TOOLS, HALF PRICE

STUUR

STELLAGE

MODEL: WS-P02

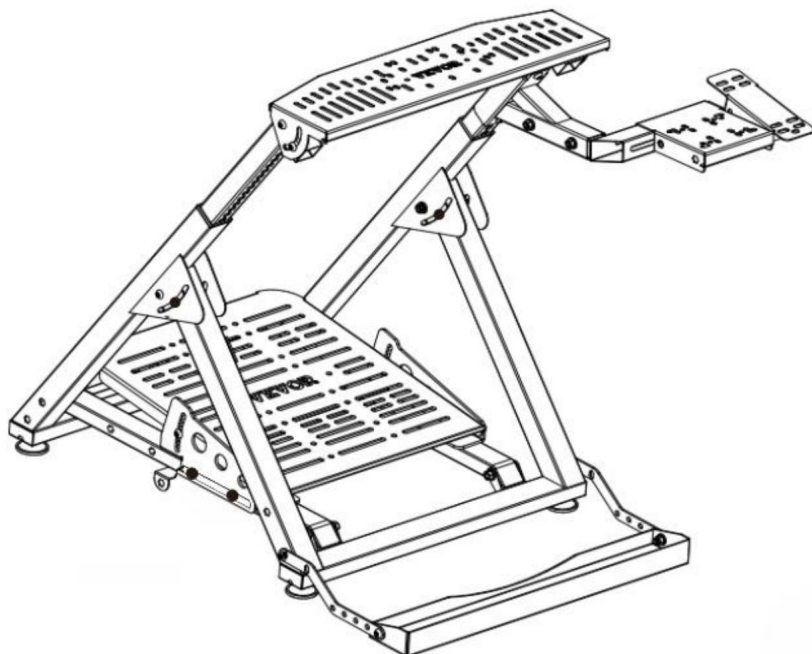

HULP NODIG? NEEM CONTACT MET ONS OP!

Heeft u vragen over het product? Heeft u technische ondersteuning nodig? Neem dan gerust contact met

ons op: **Technische ondersteuning en E-garantiecertificaat**
www.vevor.com/support

Dit is de originele instructie, lees alle instructies in de handleiding zorgvuldig door voordat u gaat werken. VEVOR behoudt zich een duidelijke interpretatie van onze gebruikershandleiding. Het uiterlijk van het product is onderworpen aan de product dat u hebt ontvangen. Vergeef ons dat we u niet opnieuw zullen informeren als er technologische of software-updates voor ons product zijn.



Waarschuwing - Om het risico op letsel te verminderen, moet de gebruiker de volgende informatie lezen:

Lees de gebruiksaanwijzing zorgvuldig door.



Aandacht







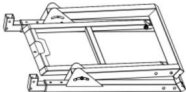
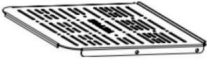





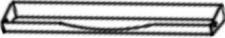

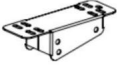
ÿ Installeer en gebruik de standaard volgens de instructies. ÿ Installeer de standaard voorzichtig en vermijd sterke trillingen.









Niet bewaren op een vochtige plek, bij een hoge temperatuur of op een stoffige plek.

ÿ De productstructuur is flexibel, draag werkhandschoenen tijdens de montage. Wees voorzichtig dat u uw handen niet bezeert tijdens de installatie. ÿ Kinderen moeten het product onder toezicht van een volwassene gebruiken.

Bewaar de handleiding.

Onderdelenlijst			
Code	Afbeelding	Naam	AANTAL.
1		Wielstandaard	1
2		Pedaalplaat	1
3		Wielplaat	1

4		Shifter-montage Arm	1
5		Schakelarm	1
6		Gaming stoel Wieg	1
7		Wiegbeugel	2
8		Schakelplaat	1
9		Handremplaat	1
10		Rechter pedaalplaat Beugel	1
11		Linker pedaalplaat Beugel	1
12		Knop 32-M8*20	1
13		Knop 38-M8*20	4
14		Voeten	4
15		Schroef M6*16	12
16		Schroef M8*16	18
17		Schroef M8*50	6
18		Moer M6	12
19		Ring 8	22

20		Moer M8	6
21		Inbussleutel 4	1
22		Inbussleutel 5	1
23		Universele wielen	2
24		Meid 10	1
25		Meid 12	1
26		Meid 13	1
27		Bindband	6

Let op: 12 stuks schroeven M6*16, 6 stuks moeren M6 en 2 stuks universele wielen zijn gratis.

STAP 1: Draai de twee omcirkelde knoppen los om de wielstandaard uit te klappen.

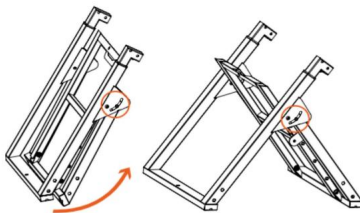

STAP 2: Knip de plastic banden door en leg het pedaalframe neer.

Plaats de draaiknop weer terug aan de voorkant van het pedaal. En monteer de voeten.

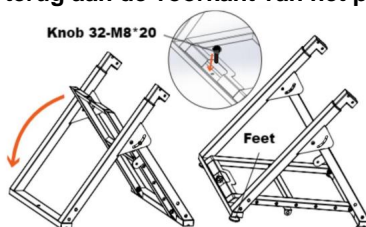

STAP 3: Lijn de achterste gaten op de pedaalplaat uit met de achterste gaten op de pedaalbeugels en schroef ze vast met 2 x M8*16 schroeven en ringen.

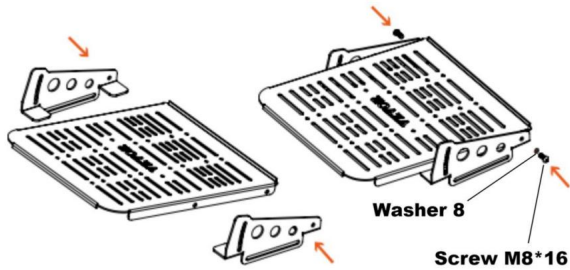

STAP 4: Stel de pedaalplaat in op de gewenste hoek en bevestig deze door de voorste gaten met 2 x M8*16 schroeven en ringen.

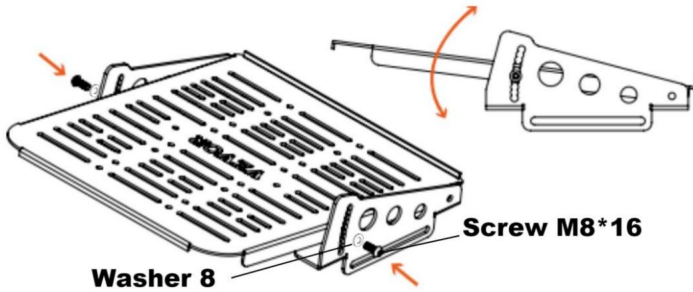

STAP 5:

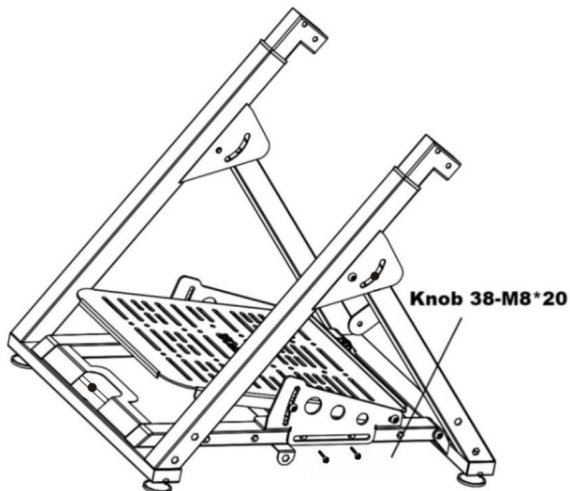

STAP 6:

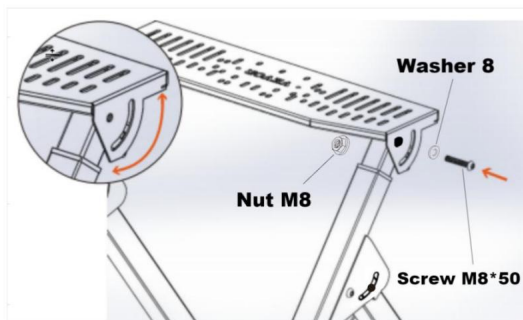

STAP 7:

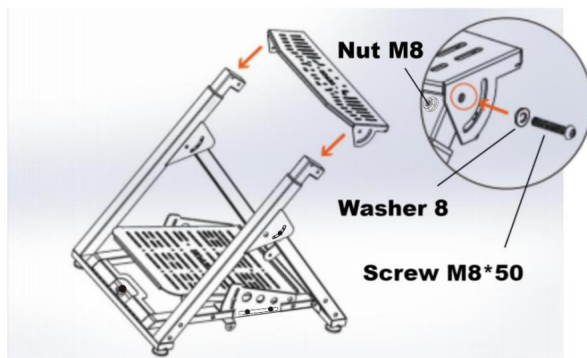

STAP 8:

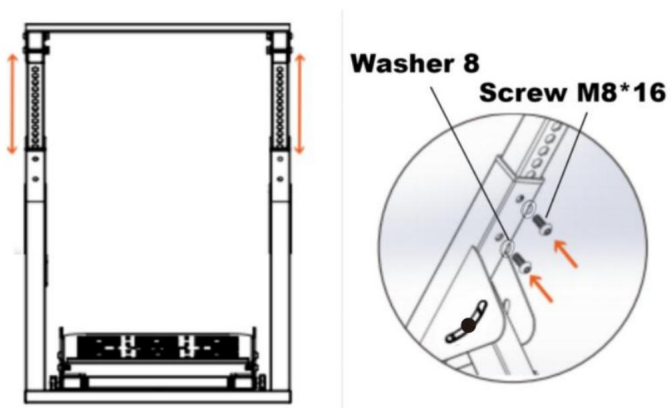

STAP 9:

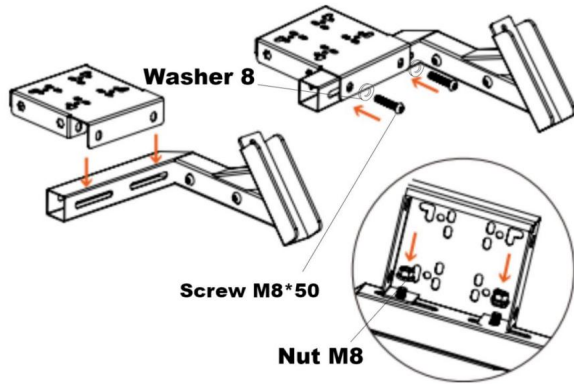

STAP 10:

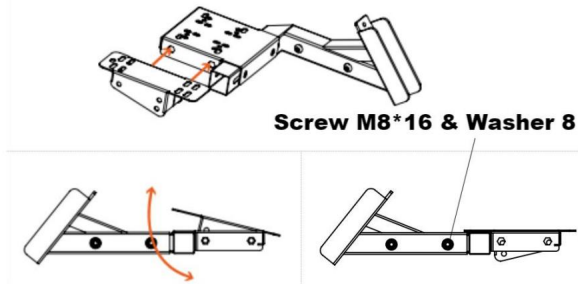

STAP 11: Lijn de gaten in de schakelarm uit met de schroefdraadbussen op de verticale paal. Kies de gewenste hoogte en bevestig met 2x M8*16mm schroeven en ringen.

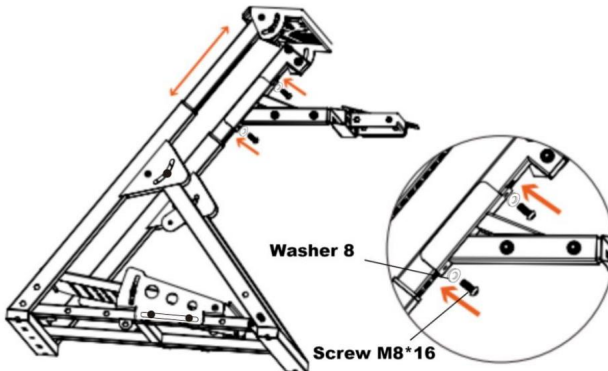

STAP 12:

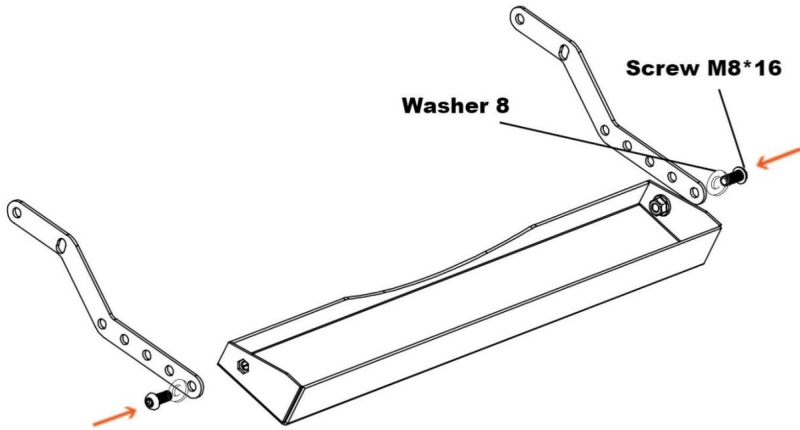

STAP 13:

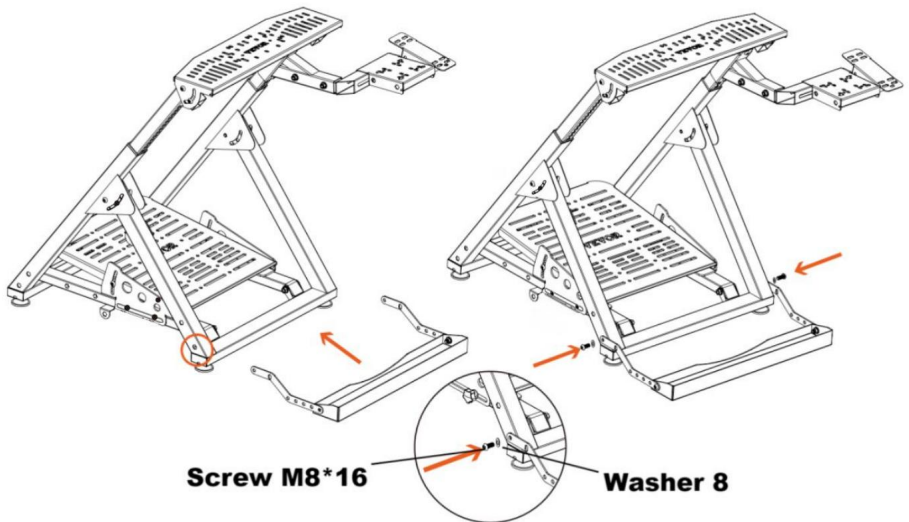

STAP 14: Plaatsing van de stoel



STAP 15: Berg de Gaming Chair Cradle op zoals afgebeeld, zodat u de standaard eenvoudig kunt opvouwen en opbergen.

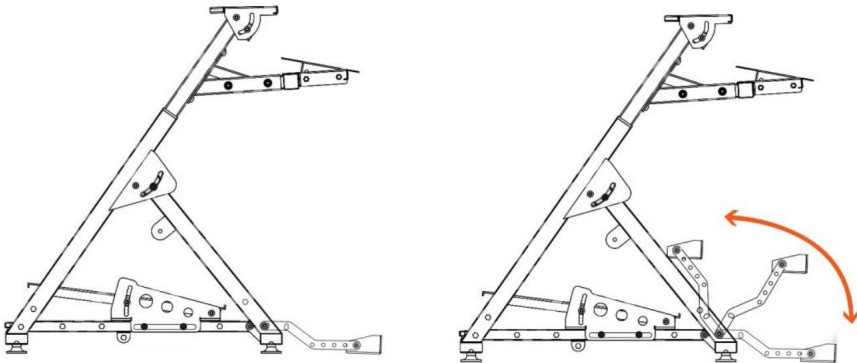

Fabrikant: Shanghaimuxinmuyeyouxiangongsi

Adres: Shuangchenglu 803nong11hao1602A-1609shi, baoshanqu, shanghai
200000 CN.

Geïmporteerd naar AUS: SIHAO PTY LTD. 1 ROKEVA STREETEASTWOOD
NSW 2122 Australië

Geïmporteerd naar de VS: Sanven Technology Ltd. Suite 250, 9166 Anaheim
Plaats, Rancho Cucamonga, CA 91730



E-CrossStu GmbH

Mainzer Landstr.69, 60329 Frankfurt am Main.



YH CONSULTING LIMITED.

C/O YH Consulting Limited Kantoor 147, Centurion
Huis, London Road, Staines-upon-Thames, Surrey,
TW18 4AX

VEVOR[®]
TOUGH TOOLS, HALF PRICE

Technische ondersteuning en e-
garantiecertificaat www.vevor.com/support

VEVOR[®]

TOUGH TOOLS, HALF PRICE

Teknisk support och e-garanticertifikat

www.vevor.com/support

RATTSTÄLL

MODELL: WS-P02

Vi fortsätter att vara engagerade i att ge dig verktyg till konkurrenskraftiga priser. "Spara hälften", "halva priset" eller andra liknande uttryck som används av oss representerar bara en uppskattning av besparingar du kan dra nytta av att köpa vissa verktyg hos oss jämfört med de stora toppmärkena och betyder inte nödvändigtvis att täcka alla kategorier av verktyg som erbjuds av oss. Du påminns vänligen om att noggrant kontrollera när du gör en beställning hos oss om du faktiskt sparar hälften i jämförelse med de främsta stora varumärkena.

VEVOR®

TOUGH TOOLS, HALF PRICE

RATT

STÅ

MODELL: WS-P02

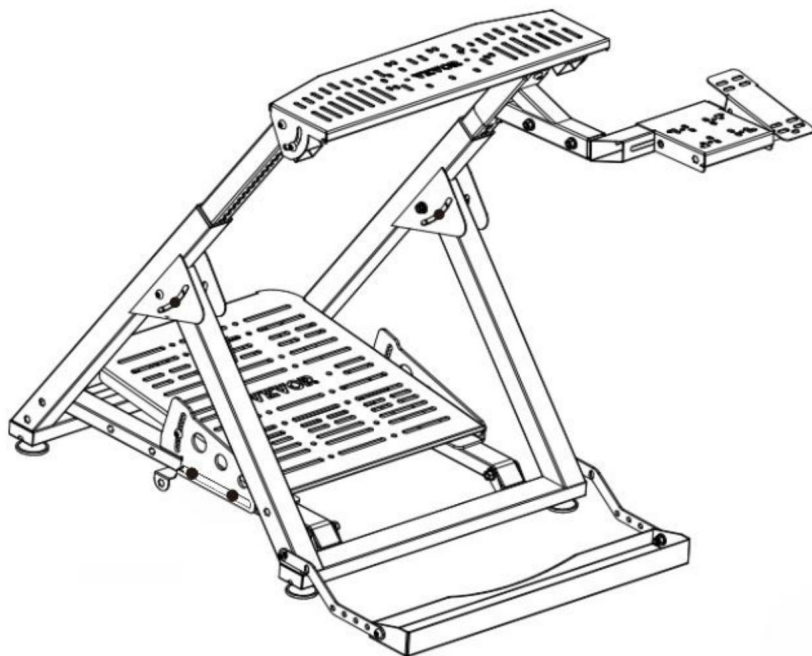

BEHÖVER HJÄLP? KONTAKTA OSS!

Har du produktfrågor? Behöver du teknisk support? Kontakta oss gärna: **Teknisk support och e-garanticertifikat** www.vevor.com/support

Detta är den ursprungliga instruktionen, läs alla manualer noggrant innan användning. VEVOR reserverar sig för en tydlig tolkning av vår bruksanvisning. Produktens utseende ska vara beroende av produkt du fått. Förlåt oss att vi inte kommer att informera dig igen om det finns någon teknik eller mjukvaruuppdateringar på vår produkt.



Varning - För att minska risken för skada måste användaren läsa bruksanvisningen noggrant.



Uppmärksamhet







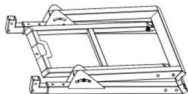





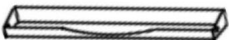

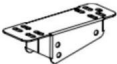
ÿ Installera och använd stativet enligt instruktionerna. ÿ Installera måttligt, undvik starka vibrationer.









Förvara inte i fuktiga förhållanden, höga temperaturer eller en dammig plats.

ÿ Produktstrukturen är flexibel, använd arbetshandskar vid montering. vänligen ta hand om skadade händer vid installation. ÿ Barn bör under vuxens uppsikt när de använder produkten.

Spara manualen.

Dellista			
Koda	Bild	Namn	ANTAL.
1		Hjulställ	1
2		Pedalplatta	1
3		Hjulplatta	1

4		Shifter montering Ärm	1
5		Växlarm	1
6		Spelstol Vagga	1
7		Vaggfäste	2
8		Växelplatta	1
9		Handbromsplatta	1
10		Höger pedalplatta Konsol	1
11		Vänster pedalplatta Konsol	1
12		Vred 32-M8*20	1
13		Vred 38-M8*20	4
14		Fötter	4
15		Skruv M6*16	12
16		Skruv M8*16	18
17		Skruv M8*50	6
18		Mutter M6	12
19		Bricka 8	22

20		Mutter M8	6
21		Insexnyckel 4	1
22		Insexnyckel 5	1
23		Universal hjul	2
24		Wench 10	1
25		Wench 12	1
26		Wench 13	1
27		Bindningsrem	6

Obs: 12 st skruvar M6*16, 6st muttrar M6 och 2st universalhjul är gratis.

STEG 1: Lossa de två rattarna inringade för att fälla ut hjulstativet.

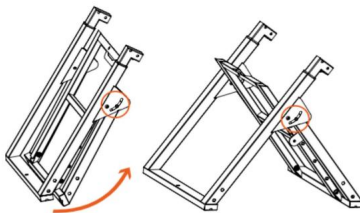

STEG 2: Klipp av plastbanden, lägg sedan ner pedalramen och Sätt tillbaka vridknappen på framsidan av pedalen. Och installera fötterna.

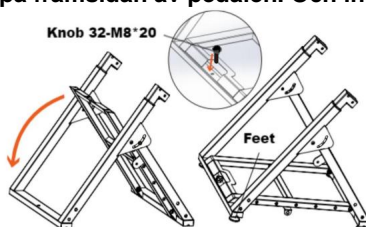

STEG 3: Rikta in de bakre hålen på pedalplattan med de bakre hålen på pedalfästena och skruva igenom med 2 x M8*16 skruvar och brickor.

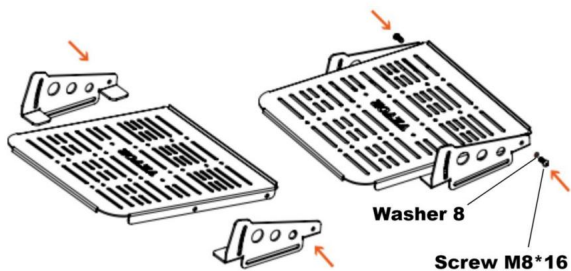

STEG 4: Justera pedalplattan till önskad vinkel och skruva genom de främre hålen med 2 x M8*16 skruvar och brickor.

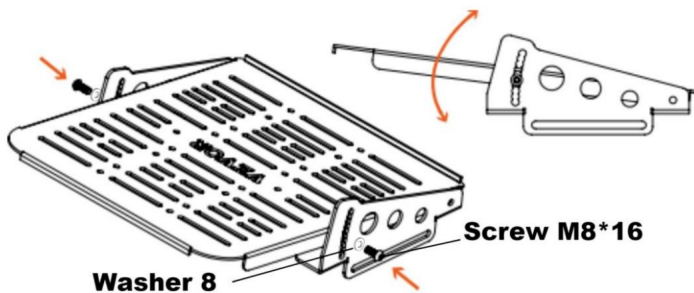

STEG 5:

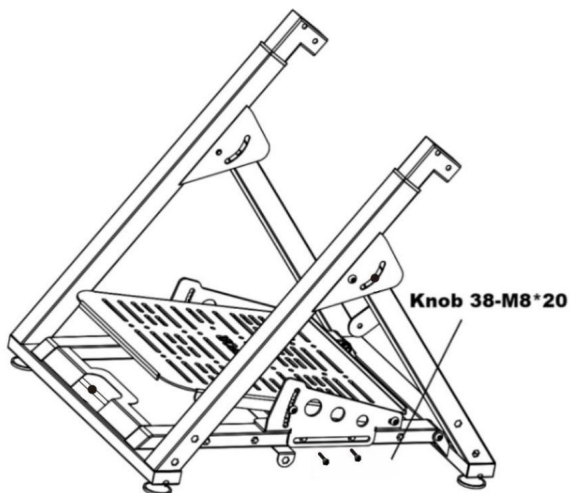

STEP 6:

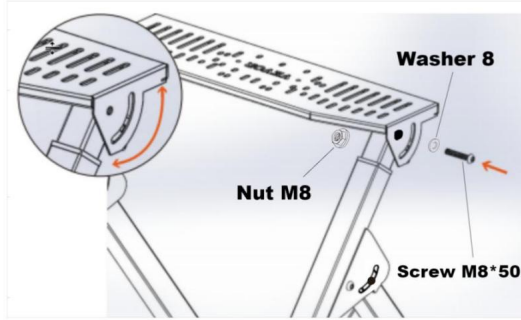

STEP 7:

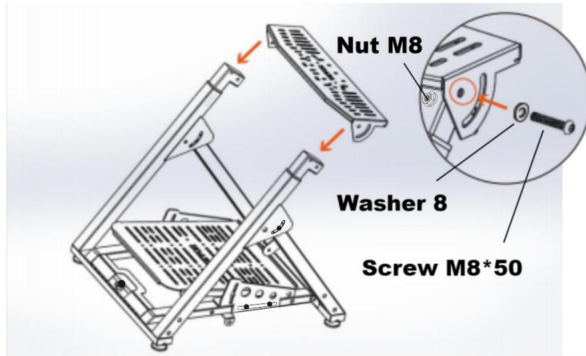

STEP 8:

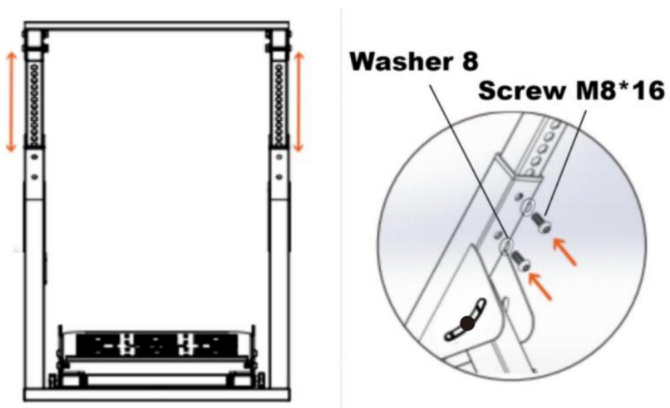

STEP 9:

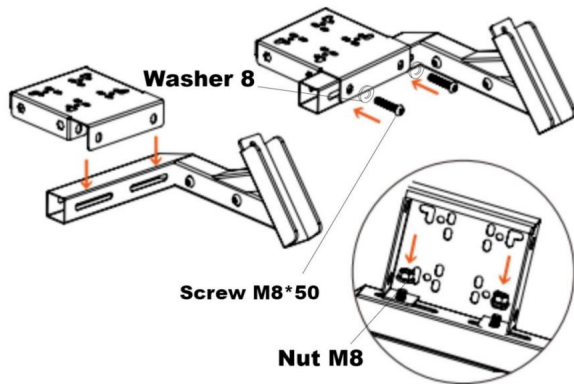

STEG 10:

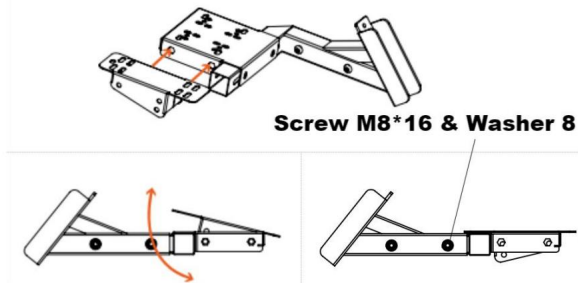

STEG 11: Rikta in hålen på växelmonteringsarmen med de gängade insatserna på den vertikala stolpen och välj önskad höjdsäkring med 2x M8*16 mm skruvar och brickor.

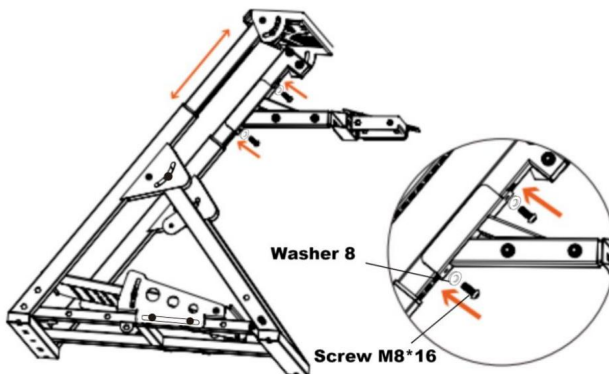

STEG 12:

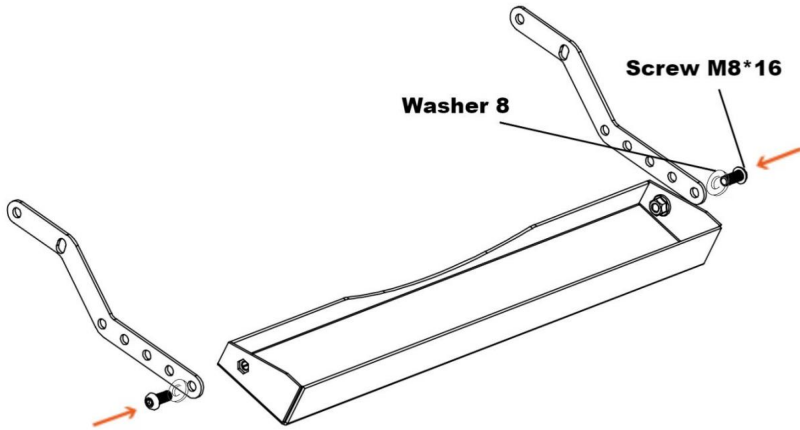

STEP 13:

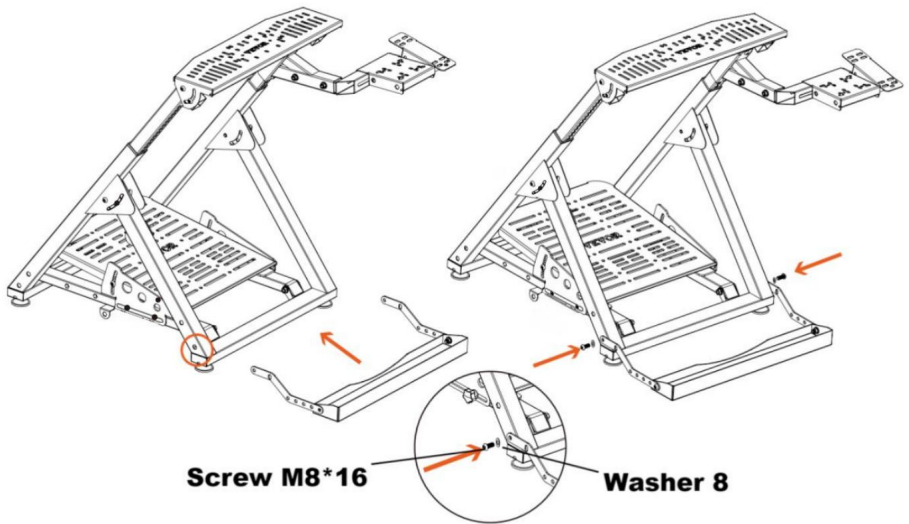

STEG 14: Sätessplacering



STEG 15: Ställ undan Gaming Chair Cradle som visas för att göra det enkelt att fälla ihop stativet för förvaring.

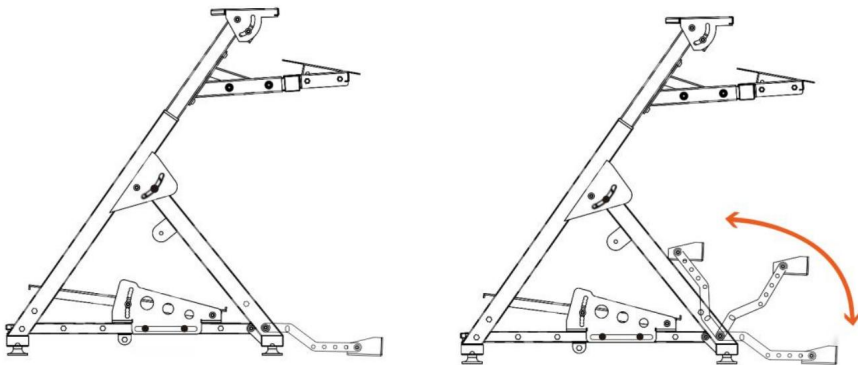

Tillverkare: Shanghaimuxinmuyeyouxiangongsi

Address: Shuangchenglu 803nong11hao1602A-1609shi, baoshanqu, shanghai 200000 CN.

Importerad till AUS: SIHAO PTY LTD. 1 ROKEVA STREETEASTWOOD NSW 2122 Australien

Importerad till USA: Sanven Technology Ltd. Suite 250, 9166 Anaheim Place, Rancho Cucamonga, CA 91730



E-CrossStu GmbH

Mainzer Landstr.69, 60329 Frankfurt am Main.



YH CONSULTING LIMITED.

C/O YH Consulting Limited Office 147, Centurion House, London Road, Staines-upon-Thames, Surrey, TW18 4AX

VEVOR®
TOUGH TOOLS, HALF PRICE

Teknisk support och e-garanticertifikat
www.vevor.com/support