

# **VEVOR®**

**TOUGH TOOLS, HALF PRICE**

Technical Support and E-Warranty Certificate [www.vevor.com/support](http://www.vevor.com/support)

## **FENCE POST ANCHOR GROUND SPIKE**

**MODEL: FX-3.5-24-8 FX-3.5-24-4 FX-3.5-24-6 FX-3.5-36-8**



**FX-3.5-36-4 WGB-3.7-24-4 WGB-3.7-24-6 WGF-2-34-2**

**WGF-2-34-4 UX-3.5-27-1 UX-3.5-27-4**

We continue to be committed to provide you tools with competitive price.

"Save Half", "Half Price" or any other similar expressions used by us only represents an estimate of savings you might benefit from buying certain tools with us compared to the major top brands and does not necessarily mean to cover all categories of tools offered by us. You are kindly reminded to verify carefully when you are placing an order with us if you are actually saving half in comparison with the top major brands.

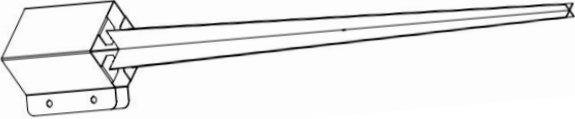
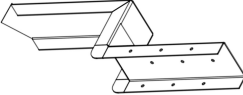

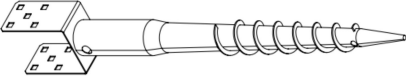
FX-3.5-24-8	
FX-3.5-24-4	
FX-3.5-24-6	
FX-3.5-36-8	
FX-3.5-36-4	
WGB-3.7-24-4	
WGB-3.7-24-6	
WGF-2-34-2	
WGF-2-34-4	
UX-3.5-27-1	
UX-3.5-27-4	

## NEED HELP? CONTACT US!

Have product questions? Need technical support? Please feel free to contact us:

**Technical Support and E-Warranty Certificate**  
[www.vevor.com/support](http://www.vevor.com/support)

This is the original instruction, please read all manual instructions carefully before operating. VEVOR reserves a clear interpretation of our user manual. The appearance of the product shall be subject to the product you received. Please forgive us that we won't inform you again if there are any technology or software updates on our product.

## INTRODUCTION

### WARNING:

#### ASSEMBLY PRECAUTIONS

1. Keep children and pets away during assembly.
2. Please assemble the product in strict accordance with the instructions. Incorrect assembly could be hazardous.
3. Separate and count all parts and hardware.
4. Prepare the following tool: Philips Head Screwdriver.
5. Follow the intended uses only.

**Save the instructions.**

## PRODUCT PARAMETERS

Model	Qty	Color	Material	Wood size to suitable	Height
<b>FX-3.5-24-8</b>	8	Black	Steel	3.5"	24"
<b>FX-3.5-24-4</b>	4	Black	Steel	3.5"	24"
<b>FX-3.5-24-6</b>	6	Black	Steel	3.5"	24"
<b>FX-3.5-36-8</b>	8	Black	Steel	3.5"	36"
<b>FX-3.5-36-4</b>	4	Black	Steel	3.5"	36"
<b>WGB-3.7-24-4</b>	4	Black	Steel	3.5"	24"
<b>WGB-3.7-24-6</b>	6	Black	Steel	3.5"	24"
<b>WGF-2-34-2</b>	2	Black	Steel	/	34"
<b>WGF-2-34-4</b>	4	Black	Steel	/	34"
<b>UX-3.5-27-1</b>	1	Silver	Steel	3.5"	27"
<b>UX-3.5-27-4</b>	4	Silver	Steel	3.5"	27"

## PART LIST

When unpacking this product, ensure the parts listed below are included and carefully inspect for any damage that may have occurred during transit. Do not attempt to assemble or use the product if any part is missing or damaged.

Model	Accessory					
FX-3.5-24-8	 M8×38	16pcs	 M8	16pcs	/	/
FX-3.5-24-4	 M8×38	8pcs	 M8	8pcs	/	/
FX-3.5-24-6	 M8×38	12pcs	 M8	12pcs	/	/
FX-3.5-36-8	 M8×38	16pcs	 M8	16pcs	/	/
FX-3.5-36-4	 M8×38	8pcs	 M8	8pcs	/	/
WGB-3.7-2 4-4	 M4.8×30	24pcs	 M4.8×50	12pcs		1pcs
WGB-3.7-2 4-6	 M4.8×30	36pcs	 M4.8×50	18pcs		1pcs
WGF-2-34- 2	 M4.8×50	8pcs		1pcs	/	/
WGF-2-34- 4	 M4.8×50	16pcs		1pcs	/	/
UX-3.5-27- 1	 M8×60	6pcs	 Rebar	1pcs	/	/
UX-3.5-27- 4	 M8×60	24pcs	 Rebar	1pcs	/	/

## INSTALLATION METHODS

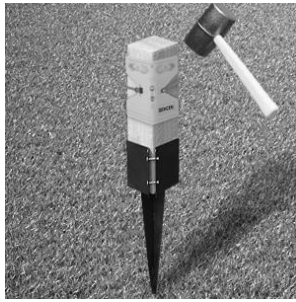
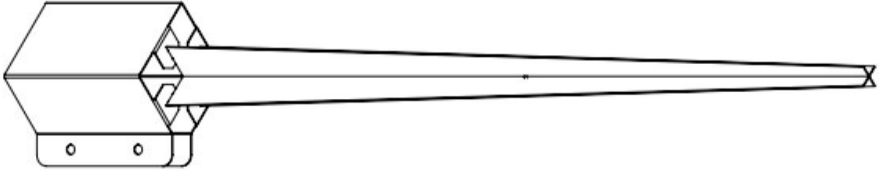

Place the post anchor in the desired position. Get a scrap piece of wood and insert it into the post base.

Using a club hammer or heavy-duty sledgehammer (not included), hit the wood, driving the post into the ground. Measuring with a level gradually while hammering.

Once the post is securely in the desired position, place your post and tighten the bolts to further prevent movement.

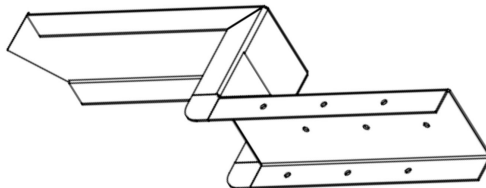



Snap the bracket into the wooden post and keep it perpendicular to the ground.

Tap the bracket so that it goes deep into the ground until it is parallel to the ground.

Drill out the pre-set holes and lock in the screws separately to complete the installation.

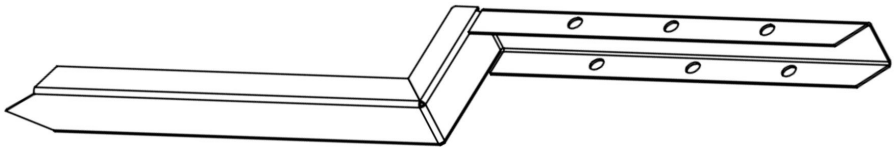

Attach the repair bracket to the post.

Hammering anchor nails into the ground.



Drill pre-set holes and drill in screws.

Finish the installation.

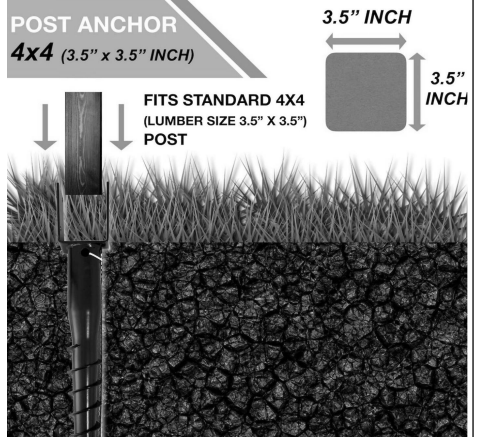
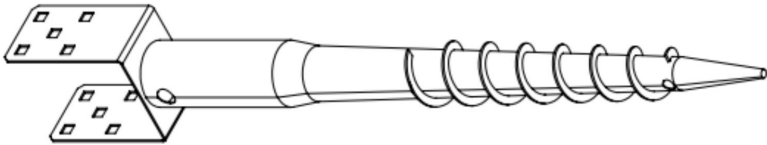



Press into the soil and twist into the ground with provided insert rod.  
 Clear a hole deep enough to accommodate the stake yes a smaller diameter than the stake shaft. Insert the stake and twist in with tightening rod.

Fits standard 4"x4" post(3.5"x3.5" inner) - perfect for most mailbox posts.

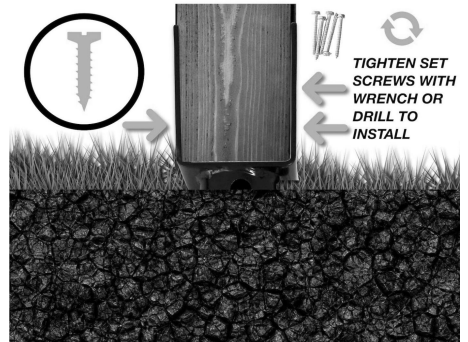
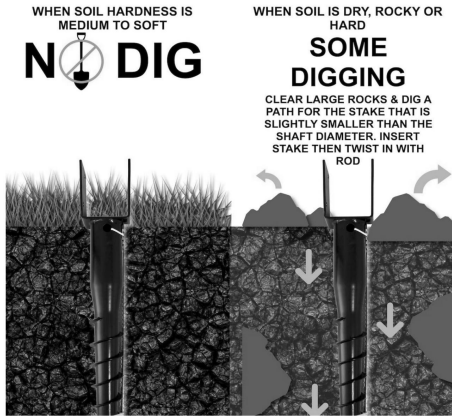

Installation : No need for cement  
 No dig option (for most soil types) .

Includes tightening rod and 5 lag bolts (use two bolts on one side and three on the other).

**Manufacturer:** Shanghaimuxinmuyeyouxiangongsi

**Address:** Baoshanqu Shuangchenglu 803long 11hao 1602A-1609shi  
Shanghai

**Imported to AUS:**SIHAO PTY LTD.1 ROKEVA STREETEASTWOOD  
NSW 2122 Australia

**Imported to USA:**Sanven Technology Ltd. Suite 250,9166 Anaheim  
Place,Rancho Cucamonga,CA91730



Pooledas Group Ltd

Unit 5 Albert Edward House,

The Pavilions Preston, United Kingdom

pooledas123@gmail.com

01772418127



SHUNSHUN GmbH

Römeräcker 9 Z2021,76351

Linkenheim-Hochstetten, Germany

euvertreter@gmail.com

+49 1727041930

**Made In China**



**VEVOR<sup>®</sup>**

**TOUGH TOOLS, HALF PRICE**

**Technical Support and E-Warranty Certificate**

**[www.vevor.com/support](http://www.vevor.com/support)**

**Made In China**

# **VEVOR<sup>®</sup>**

## **TOUGH TOOLS, HALF PRICE**

Assistance technique et certificat de garantie électronique [www.vevor.com/support](http://www.vevor.com/support)

### **PIQUET D'ANCRAGE AU SOL POUR POTEAU DE CLÔTURE**

**MODÈLE : FX-3.5-24-8 FX-3.5-24-4 FX-3.5-24-6 FX-3.5-36-8**

**FX-3.5-36-4 WGB-3.7-24-4 WGB-3.7-24-6 WGF-2-34-2**

**WGF-2-34-4 UX-3.5-27-1 UX-3.5-27-4**

Nous continuons à nous engager à vous fournir des outils à des prix compétitifs.

"Économisez la moitié", "Moitié prix" ou toute autre expression similaire que nous utilisons ne représente qu'une estimation des économies dont vous pourriez bénéficier en achetant certains outils chez nous par rapport aux grandes marques et ne signifie pas nécessairement couvrir toutes les catégories d'outils proposés. par nous.

Nous vous rappelons de bien vouloir vérifier attentivement lorsque vous passez une commande chez nous si vous économisez réellement la moitié par rapport aux grandes marques.





# VEVOR®

**TOUGH TOOLS, HALF PRICE**

ANCRAGE DE POTEAU DE CLÔTURE

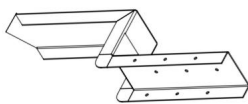
PIQUET AU SOL

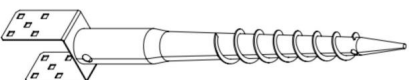
FX-3.5-24-8	
FX-3.5-24-4	
FX-3.5-24-6	
FX-3.5-36-8	
FX-3.5-36-4	
WGB-3.7-24-4	
WGB-3.7-24-6	
WGF-2-34-2	
WGF-2-34-4	
UX-3.5-27-1	
UX-3.5-27-4	

## BESOIN D'AIDE? CONTACTEZ-NOUS!

Vous avez des questions sur les produits ? Besoin d'une assistance technique ? N'hésitez pas à nous contacter:

Assistance technique et certificat de garantie  
électronique [www.vevor.com/support](http://www.vevor.com/support)

Il s'agit des instructions originales, veuillez lire attentivement toutes les instructions du manuel avant de l'utiliser. VEVOR se réserve une interprétation claire de notre manuel d'utilisation. L'apparence du produit dépend du produit que vous avez reçu. Veuillez nous pardonner que nous ne vous informerons plus s'il y a des mises à jour technologiques ou logicielles sur notre produit.

## INTRODUCTION

AVERTISSEMENT:

### PRÉCAUTIONS DE MONTAGE

1. Éloignez les enfants et les animaux domestiques pendant l'assemblage.
2. Veuillez assembler le produit en stricte conformité avec les instructions.  
Un assemblage incorrect pourrait être dangereux.
3. Séparez et comptez toutes les pièces et le matériel.
4. Préparez l'outil suivant : Tournevis cruciforme.
5. Suivez uniquement les utilisations prévues.

Enregistrez les instructions.

























## PARAMÈTRES DU PRODUIT

Modèle	Qté	Couleur	Matériau	Taille du bois à approprié	Hauteur
FX-3.5-24-8	8	Noir	Acier	3,5"	24"
FX-3.5-24-4	4	Noir	Acier	3,5"	24"
FX-3.5-24-6	6	Noir	Acier	3,5"	24"
FX-3.5-36-8	8	Noir	Acier	3,5"	36"
FX-3.5-36-4	4	Noir	Acier	3,5"	36"
WGB-3.7-24-4	4	Noir	Acier	3,5"	24"
WGB-3.7-24-6	6	Noir	Acier	3,5"	24"
WGF-2-34-2	2	Noir	Acier	/	34"
WGF-2-34-4	4	Noir	Acier	/	34"
UX-3.5-27-1	1	Argent	Acier	3,5"	27"
UX-3.5-27-4	4	Argent	Acier	3,5"	27"



## LISTE DES PIÈCES

Lors du déballage de ce produit, assurez-vous que les pièces répertoriées ci-dessous sont incluses et inspectez soigneusement tout dommage qui aurait pu survenir pendant le transit. N'essayez pas d'assembler ou d'utiliser le produit si une pièce est manquante ou endommagée.

Modèle	Accessoire					
FX-3.5-24-8	 M8×38	16 pièces	 M8	16 pièces	/	/
FX-3.5-24-4	 M8×38	8 pièces	 M8	8 pièces	/	/
FX-3.5-24-6	 M8×38	12 pièces	 M8	12 pièces	/	/
FX-3.5-36-8	 M8×38	16 pièces	 M8	16 pièces	/	/
FX-3.5-36-4	 M8×38	8 pièces	 M8	8 pièces	/	/
WGB-3.7-2 4-4	 M4.8*30	24 pièces	 M4.8*50	12 pièces		1 PCS
WGB-3.7-2 4-6	 M4.8*30	36 pièces	 M4.8*50	18 pcs		1 PCS
WGF-2-34- 2	 M4.8*50	8 pièces		1 PCS	/	/
WGF-2-34- 4	 M4.8*50	16 pièces		1 PCS	/	/
UX-3.5-27- 1	 M8*60	6 pièces	 Barre d'armature	1 PCS	/	/
UX-3.5-27- 4	 M8*60	24 pièces	 Barre d'armature	1 PCS	/	/

## MÉTHODES D'INSTALLATION

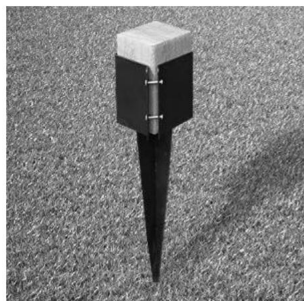
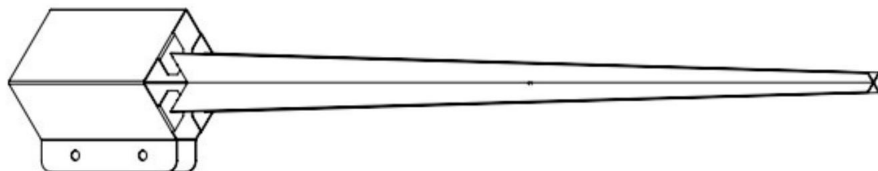

Placez l'ancrage du poteau dans la position souhaitée. Récupérez un morceau de bois et insérez-le dans la base du poteau.

À l'aide d'un marteau ou d'une masse robuste (non inclus), frappez le bois, enfonçant le poteau dans le sol. Mesurer avec un niveau progressivement en martelant.

Une fois le poteau bien placé dans la position souhaitée, placez votre poteau et serrez les boulons pour empêcher davantage tout mouvement.

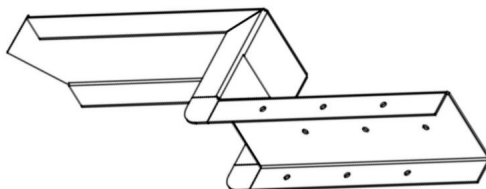



Enclenchez le support dans le poteau en bois et maintenez-le perpendiculaire au sol.

Tapotez le support pour qu'il s'enfonce profondément dans le sol jusqu'à ce qu'il soit parallèle à le sol.

Percez les trous prédéfinis et verrouillez les vis séparément pour terminer l'installation.

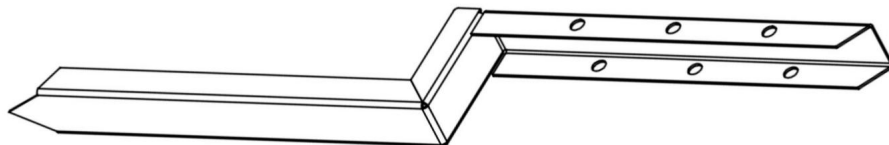

Fixez le support de réparation au poste.



Enfoncer des clous d'ancrage dans le sol.



Percez des trous prédéfinis et percez des vis.

Terminez l'installation.

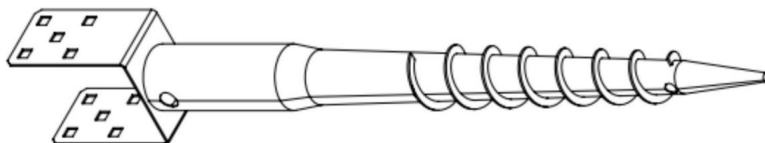

**POST ANCHOR**  
**4x4** (3.5" x 3.5" INCH)

3.5" INCH

FITS STANDARD 4X4  
(LUMBER SIZE 3.5" X 3.5")  
POST

3.5" INCH

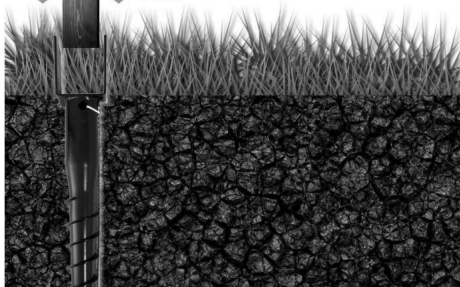

Enfoncez-le dans le sol et tournez-le dans le sol avec la tige d'insertion fournie.  
Dégagez un trou suffisamment profond pour accueillir le piquet oui d'un diamètre plus petit que l'arbre du piquet. Insérez le piquet et vissez-le avec la tige de serrage.

S'adapte aux poteaux standard de 10,2 x 10,2 cm (intérieur de 8,9 x 8,9 cm) – Parfait pour la plupart des poteaux de boîte aux lettres.

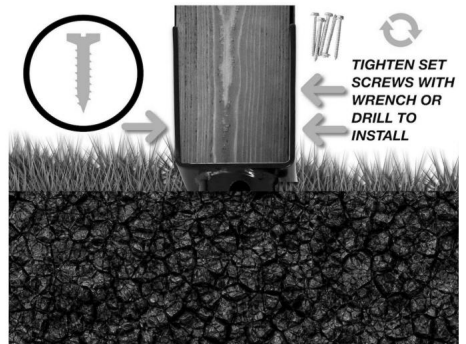
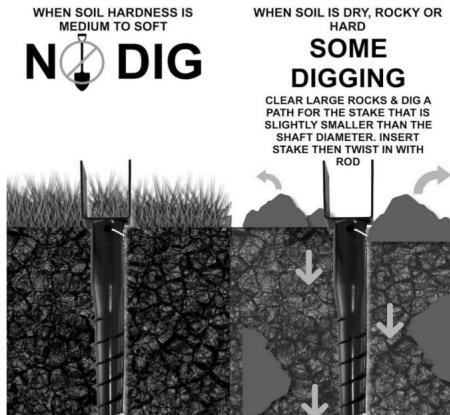

Installation : Pas besoin de ciment

Aucune option de creusement (pour la plupart des types de sols) .

Comprend une tige de serrage et 5 tire-fonds (utilisez deux boulons d'un côté et trois de l'autre).

Fabricant : Shanghaimuxinmuyeyouxiangongsi Adresse :

Baoshanqu Shuangchenglu 803long 11hao 1602A-1609shi Shanghai Importé en  
AUS :

SIHAO PTY LTD.1 ROKEVA STREETEASTWOOD NSW 2122 Australie

Importé aux États-Unis : Sanven Technology Ltd. Suite 250,9166 Anaheim Place,  
Rancho Cucamonga, CA91730



Pooledas Group Ltd

Unité 5 Albert Edward

House, The Pavilions Preston, Royaume-

Uni pooledas123@gmail.com

01772418127

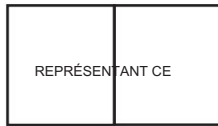

SHUNSHUN GmbH

Römeräcker 9 Z2021,76351

Linkenheim-Hochstetten, Allemagne

euagent@gmail.com

+49 1727041930

Fabriqué en Chine



**VEVOR<sup>®</sup>**

**TOUGH TOOLS, HALF PRICE**

Support technique et certificat de garantie électronique

[www.vevor.com/support](http://www.vevor.com/support)

Fabriqué en Chine



# **VEVOR<sup>®</sup>**

## **TOUGH TOOLS, HALF PRICE**

Technischer Support und E-Garantiezertifikat [www.vevor.com/support](http://www.vevor.com/support)

### **Zaunpfosten-Anker-Erdspieß**

**MODELL: FX-3.5-24-8 FX-3.5-24-4 FX-3.5-24-6 FX-3.5-36-8  
FX-3.5-36-4 WGB-3.7-24-4 WGB-3.7-24-6 WGF-2-34-2  
WGF-2-34-4 UX-3.5-27-1 UX-3.5-27-4**

Wir sind weiterhin bestrebt, Ihnen Werkzeuge zu wettbewerbsfähigen Preisen anzubieten.

„Sparen Sie die Hälfte“, „Halber Preis“ oder andere ähnliche von uns verwendete Ausdrücke stellen lediglich eine Schätzung der Einsparungen dar, die Sie durch den Kauf bestimmter Werkzeuge bei uns im Vergleich zu den großen Top-Marken erzielen könnten, und bedeuten nicht unbedingt, dass alle angebotenen Werkzeugkategorien abgedeckt werden von uns. Bitte prüfen Sie bei Ihrer Bestellung sorgfältig, ob Sie im Vergleich zu den Top-Marken tatsächlich die Hälfte sparen.





# VEVOR®

TOUGH TOOLS, HALF PRICE

ZAUNPFOSTENANKER

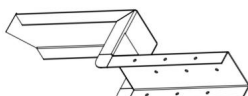
Erdspieß

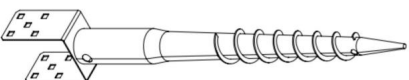
FX-3,5-24-8	
FX-3,5-24-4	
FX-3,5-24-6	
FX-3,5-36-8	
FX-3,5-36-4	
WGB-3.7-24-4	
WGB-3.7-24-6	
WGF-2-34-2	
WGF-2-34-4	
UX-3.5-27-1	
UX-3.5-27-4	

## BRAUCHEN SIE HILFE? KONTAKTIERE UNS!

Haben Sie Fragen zum Produkt? Benötigen Sie technische Unterstützung? Sie können uns gerne kontaktieren:

**Technischer Support und E-Garantiezertifikat**  
[www.vevor.com/support](http://www.vevor.com/support)

Dies ist die Originalanleitung. Bitte lesen Sie alle Bedienungsanleitungen sorgfältig durch, bevor Sie das Gerät in Betrieb nehmen. VEVOR behält sich eine klare Auslegung unserer Bedienungsanleitung vor. Das Aussehen des Produkts hängt von dem Produkt ab, das Sie erhalten haben. Bitte entschuldigen Sie, dass wir Sie nicht erneut informieren, wenn es zu unserem Produkt technische oder Software-Updates gibt.

## EINFÜHRUNG

### WARNUNG:

#### VORSICHTSMASSNAHMEN BEI DER MONTAGE

1. Halten Sie Kinder und Haustiere während der Montage fern.
2. Bitte bauen Sie das Produkt unter strikter Einhaltung der Anweisungen zusammen.  
Eine falsche Montage kann gefährlich sein.
3. Trennen und zählen Sie alle Teile und Hardware.
4. Bereiten Sie das folgende Werkzeug vor: Kreuzschlitzschraubendreher.
5. Befolgen Sie nur die vorgesehenen Verwendungszwecke.

**Bewahren Sie die Anweisungen auf.**

























## PRODUKTPARAMETER

Modell	Menge	Farbmaterial		Holzgröße bis geeignet	Höhe
<b>FX-3,5-24-8</b>	8	Schwarz	Stahl	3,5 Zoll	24 Zoll
<b>FX-3,5-24-4</b>	4	Schwarz	Stahl	3,5 Zoll	24 Zoll
<b>FX-3,5-24-6</b>	6	Schwarz	Stahl	3,5 Zoll	24 Zoll
<b>FX-3,5-36-8</b>	8	Schwarz	Stahl	3,5 Zoll	36 Zoll
<b>FX-3,5-36-4</b>	4	Schwarz	Stahl	3,5 Zoll	36 Zoll
<b>WGB-3.7-24-4</b>	4	Schwarz	Stahl	3,5 Zoll	24 Zoll
<b>WGB-3.7-24-6</b>	6	Schwarz	Stahl	3,5 Zoll	24 Zoll
<b>WGF-2-34-2</b>	2	Schwarz	Stahl	/	34 Zoll
<b>WGF-2-34-4</b>	4	Schwarz	Stahl	/	34 Zoll
<b>UX-3.5-27-1</b>	1	Silber	Stahl	3,5 Zoll	27 Zoll
<b>UX-3.5-27-4</b>	4	Silber	Stahl	3,5 Zoll	27 Zoll

## STÜCKLISTE

Stellen Sie beim Auspacken dieses Produkts sicher, dass die unten aufgeführten Teile enthalten sind und überprüfen Sie es sorgfältig auf etwaige Schäden

während des Transports. Versuchen Sie nicht, das Produkt zusammenzubauen oder zu verwenden, wenn Teile davon beschädigt sind fehlen oder beschädigt sind.

Modell	Zubehörteil					
FX-3,5-24-8	 M8x38	16 Stück	 M8	16 Stück	/	/
FX-3,5-24-4	 M8x38	8 Stück	 M8	8 Stück	/	/
FX-3,5-24-6	 M8x38	12 Stück	 M8	12 Stück	/	/
FX-3,5-36-8	 M8x38	16 Stück	 M8	16 Stück	/	/
FX-3,5-36-4	 M8x38	8 Stück	 M8	8 Stück	/	/
WGB-3.7-2 4-4	 M4,8*30	24 Stück	 M4,8*50	12 Stück		1 Stück
WGB-3.7-2 4-6	 M4,8*30	36 Stück	 M4,8*50	18 Stk		1 Stück
WGF-2-34- 2	 M4,8*50	8 Stück		1 Stück	/	/
WGF-2-34- 4	 M4,8*50	16 Stück		1 Stück	/	/
UX-3.5-27- 1	 M8*60	6 Stück	 Bewehrung	1 Stück	/	/
UX-3.5-27- 4	 M8*60	24 Stück	 Bewehrung	1 Stück	/	/

## INSTALLATIONSMETHODEN

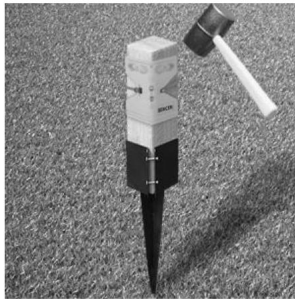
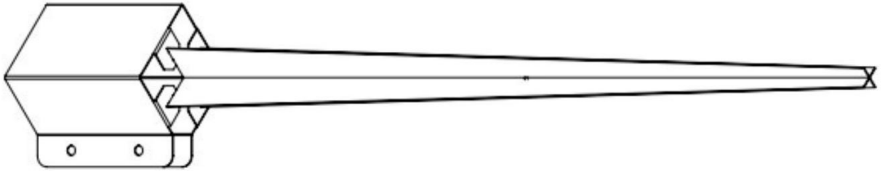

Platzieren Sie den Pfostenanker an der gewünschten Position. Besorge dir ein Stück Holz und in den Pfostenträger einsetzen.

Schlagen Sie mit einem Keulenhammer oder einem robusten Vorschlaghammer (nicht im Lieferumfang enthalten) auf Holz und treibt den Pfosten in den Boden. Mit einer Wasserwaage schrittweise messen beim Hämmern.

Sobald der Pfosten sicher in der gewünschten Position sitzt, platzieren Sie ihn und Ziehen Sie die Schrauben fest, um eine weitere Bewegung zu verhindern.

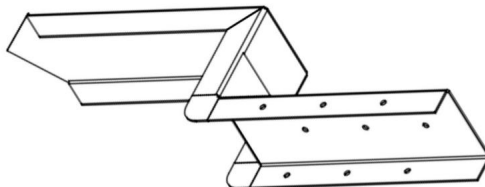





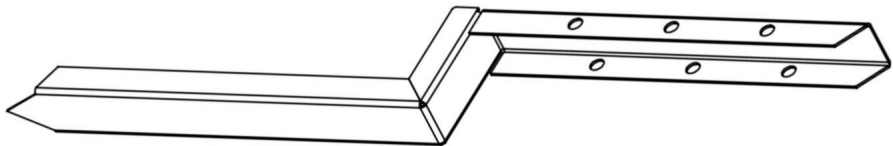

Rasten Sie die Halterung in den Holzpfosten ein und halten Sie sie senkrecht zum Boden.  
Klopfen Sie die Halterung so, dass sie tief in den Boden eindringt, bis sie parallel ist der Boden.

Bohren Sie die voreingestellten Löcher und befestigen Sie die Schrauben separat, um den Vorgang abzuschließen die Installation.

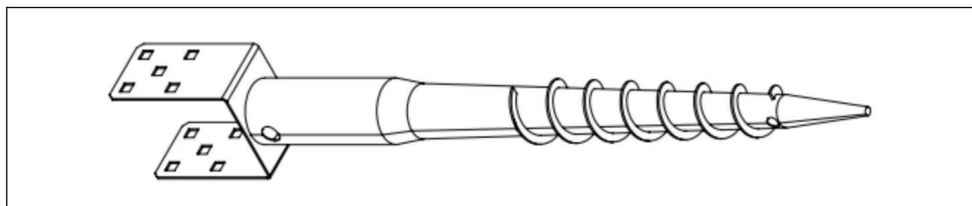

<p>Befestigen Sie die Reparaturhalterung am Post.</p> <p>Post.</p>	<p>Ankernägeln einschlagen</p> <p>Boden.</p>
	
<p>Vorgefertigte Löcher bohren und einbohren Schrauben.</p>	<p>Beenden Sie die Installation.</p>

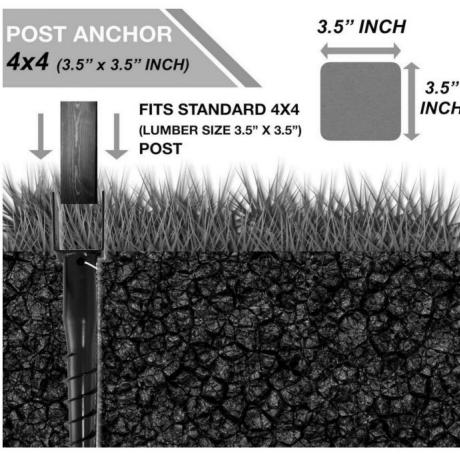

	<p><b>POST ANCHOR</b> <b>4x4</b> (3.5" x 3.5" INCH)</p> <p><b>3.5" INCH</b></p> <p><b>3.5" INCH</b></p> <p><b>FITS STANDARD 4X4</b> <b>(LUMBER SIZE 3.5" X 3.5")</b> <b>POST</b></p> 
---	--



In den Boden drücken und mit dem mitgelieferten Einsteckstab in den Boden drehen.  
Machen Sie ein Loch frei, das tief genug ist, um den Pfahl aufzunehmen, der jedoch einen kleineren Durchmesser als der Pfahlschaft hat.  
Setzen Sie den Pfahl ein und drehen Sie ihn mit der Spannstange fest.

Passend für standardmäßige 4 x 4 Zoll große Pfosten (3,5 x 3,5 Zoll innen) – perfekt für die meisten Briefkastenpfosten.

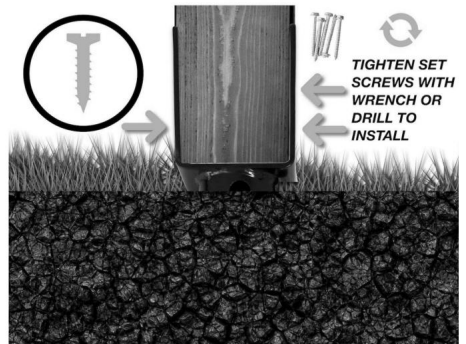
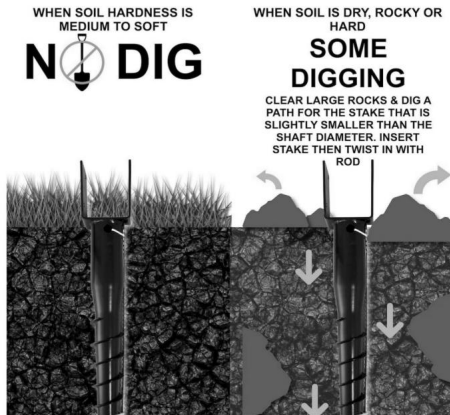

Installation: Kein Zement erforderlich  
Keine Graboption (für die meisten Bodentypen).

Inklusive Spannstange und 5 Zugschrauben  
(verwenden Sie zwei Schrauben auf der einen Seite und drei auf der anderen).

**Hersteller:** Shanghaimuxinmuyeyouxiangongsi **Adresse:**

Baoshanqu Shuangchenglu 803long 11hao 1602A-1609shi Shanghai **Importiert nach**

AUS:SIHAO

PTY LTD.1 ROKEVA STREETEASTWOOD NSW 2122 Australien

**Importiert in die USA:** Sanven Technology Ltd. Suite 250,9166 Anaheim Place,

Rancho Cucamonga, CA91730



Pooledas Group Ltd

Unit 5 Albert Edward House,

The Pavilions Preston, Vereinigtes

Königreich pooledas123@gmail.com

01772418127



SHUNSHUN GmbH

Römeräcker 9 Z2021,76351

Linkenheim-Hochstetten, Germany

euvertreter@gmail.com

+49 1727041930

**In China hergestellt**



**VEVOR<sup>®</sup>**

**TOUGH TOOLS, HALF PRICE**

**Technischer Support und E-Garantiezertifikat**

**[www.vevor.com/support](http://www.vevor.com/support)**

**Hergestellt in China**

# **VEVOR<sup>®</sup>**

## **TOUGH TOOLS, HALF PRICE**

Supporto tecnico e certificato di garanzia elettronica [www.vevor.com/support](http://www.vevor.com/support)

**PUNTO DI ANCORAGGIO A TERRA PER PALETTI DI RECINZIONE**

**MODELLO: FX-3.5-24-8 FX-3.5-24-4 FX-3.5-24-6 FX-3.5-36-8**

**FX-3.5-36-4 WGB-3.7-24-4 WGB-3.7-24-6 WGF-2-34-2**

**WGF-2-34-4 UX-3.5-27-1 UX-3.5-27-4**

Continuiamo a impegnarci per fornirvi strumenti a prezzi competitivi.

"Risparmia la metà", "Metà prezzo" o qualsiasi altra espressione simile da noi utilizzata rappresenta solo una stima del risparmio che potresti trarre dall'acquistare determinati strumenti con noi rispetto ai principali marchi più importanti e non significa necessariamente coprire tutte le categorie di strumenti offerti da noi. Ti ricordiamo gentilmente di verificare attentamente quando effettui un ordine con noi se stai effettivamente risparmiando la metà rispetto ai migliori marchi principali.





# VEVOR®

TOUGH TOOLS, HALF PRICE

ANCORAGGIO PER PALO RECINZIONE

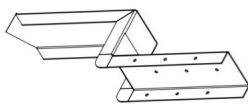
PUNTA DI TERRA

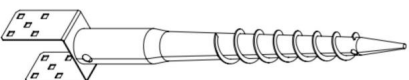
FX-3.5-24-8	
FX-3.5-24-4	
FX-3.5-24-6	
FX-3.5-36-8	
FX-3.5-36-4	
WGB-3.7-24-4	
WGB-3.7-24-6	
WGF-2-34-2	
WGF-2-34-4	
UX-3.5-27-1	
UX-3.5-27-4	

## HO BISOGNO DI AIUTO? CONTATTACI!

Hai domande sul prodotto? Hai bisogno di supporto tecnico? Non esitate a contattarci:

**Supporto tecnico e certificato di garanzia  
elettronica [www.vevor.com/support](http://www.vevor.com/support)**

Queste sono le istruzioni originali, leggere attentamente tutte le istruzioni del manuale prima dell'uso. VEVOR si riserva una chiara interpretazione del nostro manuale d'uso. L'aspetto del prodotto sarà soggetto al prodotto ricevuto. Ti preghiamo di perdonarci se non ti informeremo più se sono presenti aggiornamenti tecnologici o software sul nostro prodotto.

## INTRODUZIONE

### AVVERTIMENTO:

### PRECAUZIONI DI MONTAGGIO

1. Tenere lontani bambini e animali domestici durante il montaggio.
2. Si prega di assemblare il prodotto attenendosi rigorosamente alle istruzioni.  
Un montaggio errato potrebbe essere pericoloso.
3. Separare e contare tutte le parti e l'hardware.
4. Preparare il seguente strumento: cacciavite a croce.
5. Seguire solo gli usi previsti.

### Salva le istruzioni.

























## PARAMETRI DEL PRODOTTO

Modello	Qtà Colore Materiale			Dimensioni del legno fino a	Altezza
				adatto	
<b>FX-3.5-24-8</b>	8	Nero	Acciaio	3,5"	24"
<b>FX-3.5-24-4</b>	4	Nero	Acciaio	3,5"	24"
<b>FX-3.5-24-6</b>	6	Nero	Acciaio	3,5"	24"
<b>FX-3.5-36-8</b>	8	Nero	Acciaio	3,5"	36"
<b>FX-3.5-36-4</b>	4	Nero	Acciaio	3,5"	36"
<b>WGB-3.7-24-4</b>	4	Nero	Acciaio	3,5"	24"
<b>WGB- 3.7-24-66</b>		Nero	Acciaio	3,5"	24"
<b>WGF-2-34-2</b>	2	Nero	Acciaio	/	34"
<b>WGF-2-34-4</b>	4	Nero	Acciaio	/	34"
<b>UX-3.5-27-1</b>	1	Argento	Acciaio	3,5"	27"
<b>UX-3.5-27-4</b>	4	Argento	Acciaio	3,5"	27"



## ELENCO PARTI

Quando si disimballa il prodotto, assicurarsi che le parti elencate di seguito siano incluse e ispezionare attentamente eventuali danni che potrebbero essersi verificati durante il transito. Non tentare di assemblare o utilizzare il prodotto se qualsiasi parte lo è mancanti o danneggiati.

Modello	Accessorio					
FX-3.5-24-8	 M8x38	16 pezzi	 M8	16 pezzi	/	/
FX-3.5-24-4	 M8x38	8 pezzi	 M8	8 pezzi	/	/
FX-3.5-24-6	 M8x38	12 pezzi	 M8	12 pezzi	/	/
FX-3.5-36-8	 M8x38	16 pezzi	 M8	16 pezzi	/	/
FX-3.5-36-4	 M8x38	8 pezzi	 M8	8 pezzi	/	/
WGB-3.7-2 4-4	 M4,8*30	24 pezzi	 M4,8*50	12 pezzi		1 pz
WGB-3.7-2 4-6	 M4,8*30	36 pezzi	 M4,8*50	18 pollici		1 pz
WGF-2-34- 2	 M4,8*50	8 pezzi		1 pz	/	/
WGF-2-34- 4	 M4,8*50	16 pezzi		1 pz	/	/
UX-3.5-27- 1	 M8*60	6 pezzi	 Armatura	1 pz	/	/
UX-3.5-27- 4	 M8*60	24 pezzi	 Armatura	1 pz	/	/

## METODI DI INSTALLAZIONE

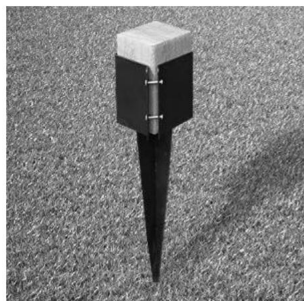
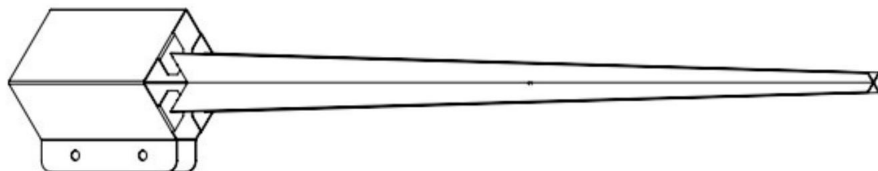

Posizionare l'ancoraggio del palo nella posizione desiderata. Prendi un pezzo di legno di scarto e inserirlo nella base del palo.

Usando un martello o una mazza pesante (non inclusa), colpisci il legno, conficcando il palo nel terreno. Misurare gradualmente con una livella mentre martella.

Una volta che il palo è saldamente nella posizione desiderata, posiziona il palo e serrare i bulloni per impedire ulteriormente il movimento.

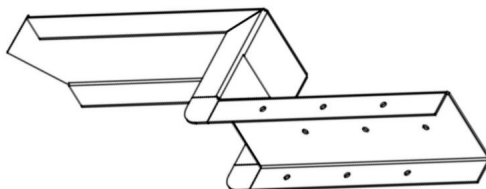



Inserisci la staffa nel palo di legno e mantienila perpendicolare al terra.

Tocca la staffa in modo che entri in profondità nel terreno finché non è parallela il terreno.

Praticare i fori preimpostati e bloccare le viti separatamente per completare l'installazione.

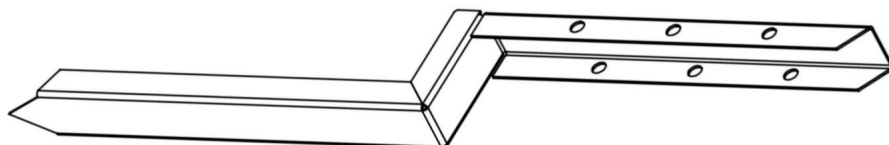

Fissare la staffa di riparazione al  
inviare.



Martellare i chiodi di ancoraggio nel  
terra.



Praticare i fori preimpostati e trapanare  
viti.

Termina l'installazione.

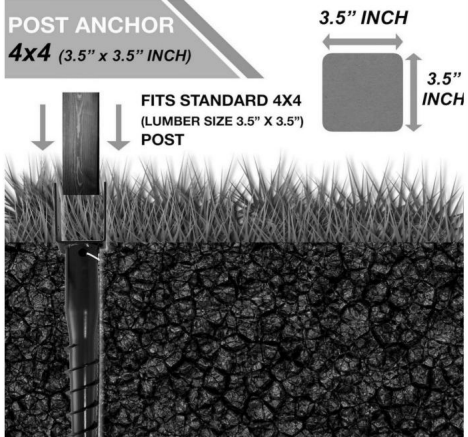
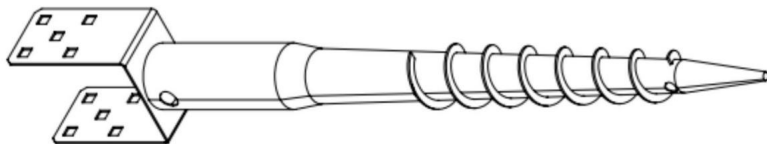

Premere nel terreno e ruotare nel terreno con l'asta di inserimento fornita. Praticare un foro sufficientemente profondo da contenere il paletto, sì, con un diametro inferiore rispetto all'albero del paletto. Inserire il paletto e avvitarlo con l'asta di serraggio.

Adatto per pali standard da 4"x4" (interno 3,5"x3,5") - perfetto per la maggior parte dei messaggi per cassette postali.

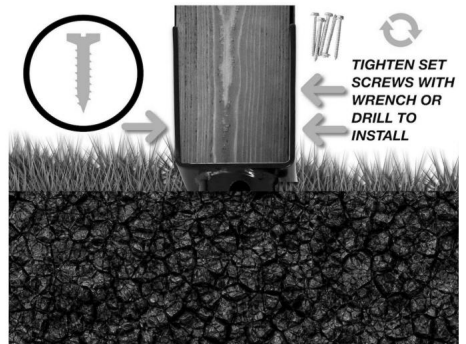
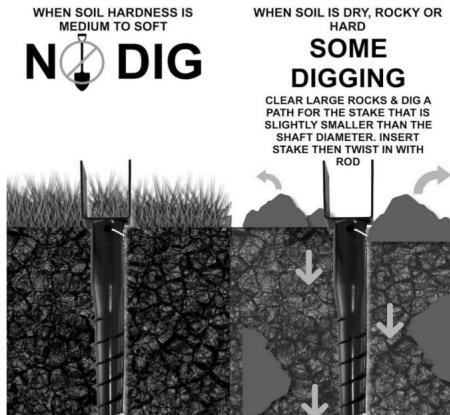

Installazione: non necessita di cemento

Nessuna opzione di scavo (per la maggior parte dei tipi di terreno).

Include asta di serraggio e 5 tirafondi (utilizzare due bulloni su un lato e tre sull'altro).

**Produttore:** Shanghaimuxinmuyeyouxiangongsi

**Indirizzo:** Baoshanqu Shuangchenglu 803long 11hao 1602A-1609shi  
Shanghai

**Importato in AUS:**SIHAO PTY LTD.1 ROKEVA STREETEASTWOOD NSW  
2122 Australia

**Importato negli Stati Uniti:** Sanven Technology Ltd. Suite 250,9166  
Anaheim Place, Rancho Cucamonga, CA91730

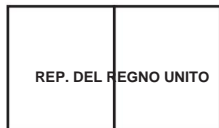

Pooledas Group Ltd  
Unità 5 Albert Edward House,  
The Pavilions Preston, Regno Unito  
pooledas123@gmail.com  
01772418127



SHUNSHUN GmbH  
Römeräcker 9 Z2021,76351  
Linkenheim-Hochstetten, Germania  
euagent@gmail.com  
+491727041930

**Made in China**



**VEVOR<sup>®</sup>**

**TOUGH TOOLS, HALF PRICE**

**Supporto tecnico e certificato di garanzia**

**elettronica [www.vevor.com/](http://www.vevor.com/)**

**support Prodotto in Cina**



# **VEVOR<sup>®</sup>**

## **TOUGH TOOLS, HALF PRICE**

Soporte técnico y certificado de garantía electrónica [www.vevor.com/support](http://www.vevor.com/support)

### **PUNTO DE TIERRA DE ANCLAJE DE POSTE DE CERCA**

**MODELO: FX-3.5-24-8 FX-3.5-24-4 FX-3.5-24-6 FX-3.5-36-8**

**FX-3.5-36-4 WGB-3.7-24-4 WGB-3.7-24-6 WGF-2-34-2**

**WGF-2-34-4 UX-3.5-27-1 UX-3.5-27-4**

Seguimos comprometidos a proporcionarle herramientas a precios competitivos.

"Ahorre a mitad de precio", "A mitad de precio" o cualquier otra expresión similar utilizada por nosotros solo representa una estimación de los ahorros que podría beneficiarse al comprar ciertas herramientas con nosotros en comparación con las principales marcas y no significa necesariamente cubrir todas las categorías de herramientas ofrecidas por nosotros. Le recordamos que, cuando realice un pedido con nosotros, verifique cuidadosamente si realmente está ahorrando la mitad en comparación con las principales marcas.





# VEVOR®

TOUGH TOOLS, HALF PRICE

ANCLA PARA POSTES DE CERCA

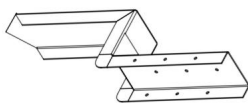
PICO DE TIERRA

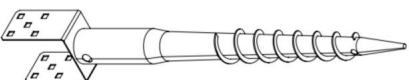
FX-3.5-24-8	
FX-3.5-24-4	
FX-3.5-24-6	
FX-3.5-36-8	
FX-3.5-36-4	
WGB-3.7-24-4	
WGB-3.7-24-6	
WGF-2-34-2	
WGF-2-34-4	
UX-3.5-27-1	
UX-3.5-27-4	

¿NECESITAS AYUDA? ¡CONTÁCTENOS!

¿Tiene preguntas sobre el producto? ¿Necesita soporte técnico? Siéntete libre de contactarnos:

Soporte técnico y certificado de garantía  
electrónica [www.vevor.com/support](http://www.vevor.com/support)

Estas son las instrucciones originales; lea atentamente todas las instrucciones del manual antes de operar. VEVOR se reserva una interpretación clara de nuestro manual de usuario. La apariencia del producto estará sujeta al producto que recibió. Perdónese que no le informaremos nuevamente si hay actualizaciones de tecnología o software en nuestro producto.

## INTRODUCCIÓN

ADVERTENCIA:

### PRECAUCIONES DE MONTAJE

1. Mantenga alejados a los niños y las mascotas durante el montaje.
2. Monte el producto estrictamente de acuerdo con las instrucciones.  
El montaje incorrecto podría ser peligroso.
3. Separe y cuente todas las piezas y herrajes.
4. Prepare la siguiente herramienta: Destornillador Philips.
5. Siga únicamente los usos previstos.

























Guarde las instrucciones.

## PARÁMETROS DEL PRODUCTO

Modelo	Cantidad	Color	Material	Tamaño de madera a adecuado	Altura
FX-3.5-24-8	8	Negro	Acero	3,5"	24"
FX-3.5-24-4	4	negro	Acero	3,5"	24"
FX-3.5-24-6	6	Negro	Acero	3,5"	24"
FX-3.5-36-8	8	Negro	Acero	3,5"	36"
FX-3.5-36-4	4	negro	Acero	3,5"	36"
WGB-3.7-24-4	4	Negro	Acero	3,5"	24"
WGB-3.7-24-6	6	Negro	Acero	3,5"	24"
WGF-2-34-2	2	Negro	Acero	/	34"
WGF-2-34-4	4	negro	Acero	/	34"
UX-3.5-27-1	1	Plata	Acero	3,5"	27"
UX-3.5-27-4	4	Plata	Acero	3,5"	27"

## LISTA DE

Al desembalar este producto, asegúrese de que las piezas que se enumeran a continuación estén incluidas e inspeccione cuidadosamente por cualquier daño que pueda haber ocurrido durante el tránsito. No intente ensamblar ni utilizar el producto si alguna pieza está faltantes o dañados.

Modelo	Accesorio					
FX-3.5-24-8	 M8×38	16 piezas	 M8	16 piezas	/	/
FX-3.5-24-4	 M8×38	8 piezas	 M8	8 piezas	/	/
FX-3.5-24-6	 M8×38	12 piezas	 M8	12 piezas	/	/
FX-3.5-36-8	 M8×38	16 piezas	 M8	16 piezas	/	/
FX-3.5-36-4	 M8×38	8 piezas	 M8	8 piezas	/	/
WGB-3.7-2 4-4	 M4.8*30	24 piezas	 M4.8*50	12 piezas		PC 1
WGB-3.7-2 4-6	 M4.8*30	36 piezas	 M4.8*50	18 piezas		PC 1
WGF-2-34- 2	 M4.8*50	8 piezas		PC 1	/	/
WGF-2-34- 4	 M4.8*50	16 piezas		PC 1	/	/
UX-3.5-27- 1	 M8*60	6 piezas	 Barra de refuerzo	PC 1	/	/
UX-3.5-27- 4	 M8*60	24 piezas	 Barra de refuerzo	PC 1	/	/

## MÉTODOS DE INSTALACIÓN

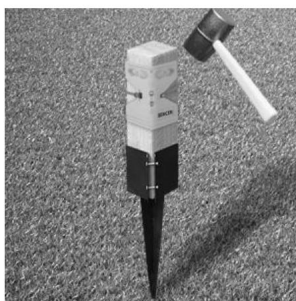
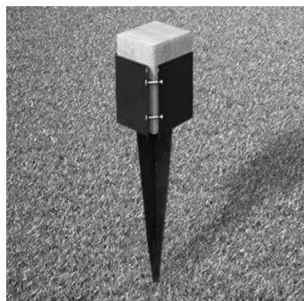
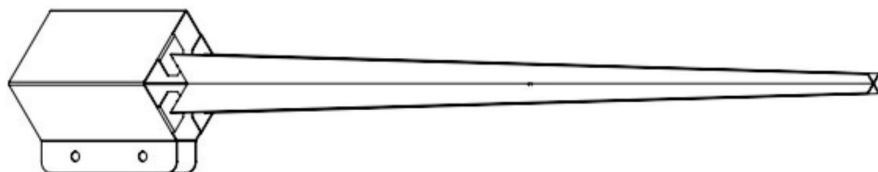

Coloque el anclaje del poste en la posición deseada. Consigue un trozo de madera e insértelo en la base del poste.

Con un martillo o un mazo resistente (no incluido), golpee el madera, clavando el poste en el suelo. Medir con un nivel gradualmente mientras martilla.

Una vez que el poste esté seguro en la posición deseada, coloque el poste y apriete los pernos para evitar aún más el movimiento.

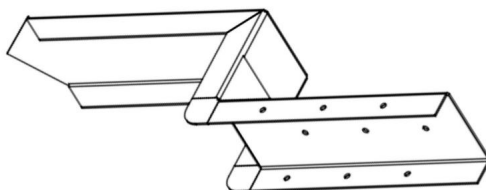



Coloque el soporte en el poste de madera y manténgalo perpendicular al suelo.

Golpee el soporte para que entre profundamente en el suelo hasta que quede paralelo al terreno.

Taladre los orificios preestablecidos y bloquee los tornillos por separado para completar la instalación.

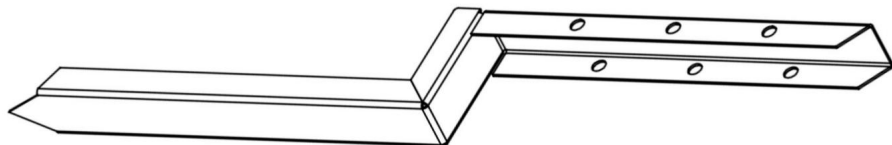

Fije el soporte de reparación al  
correo.



Clavar clavos de anclaje en el  
suelo.



Taladre agujeros preestablecidos y taladre  
tornillos.

Finalice la instalación.

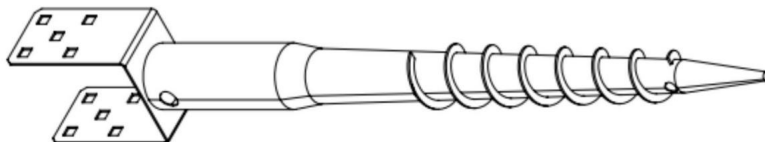

**POST ANCHOR**  
**4x4** (3.5" x 3.5" INCH)

3.5" INCH

3.5" INCH

FITS STANDARD 4X4  
(LUMBER SIZE 3.5" X 3.5")  
POST

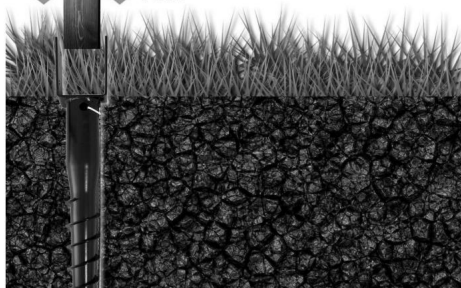



Presione en el suelo y gírelo en el suelo con la varilla de inserción proporcionada.

Haga un agujero lo suficientemente profundo como para acomodar la estaca, sí, con un diámetro más pequeño que el eje de la estaca. Inserte la estaca y gírela con la varilla de apriete.

Se adapta a postes estándar de 4"x4" (3,5"x3,5" interior), perfecto para la mayoría de los postes de buzones.

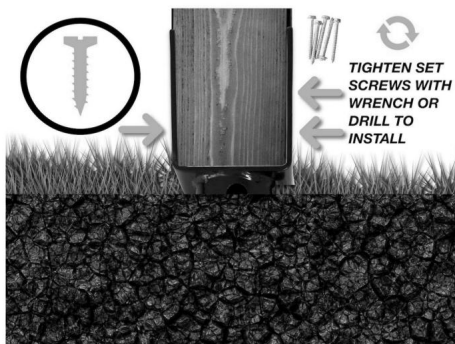
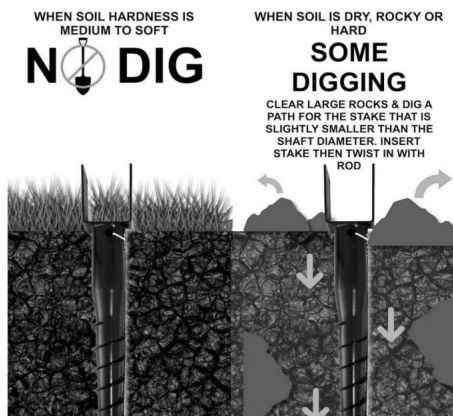

Instalación: No necesita cemento

Sin opción de excavación (para la mayoría de los tipos de suelo).

Incluye varilla de apriete y 5 tirafondos (use dos pernos en un lado y tres en el otro).

Fabricante: Shanghaimuxinmuyeyouxiangongsi

Dirección: Baoshanqu Shuangchenglu 803long 11hao 1602A-1609shi  
Shanghai

Importado a AUS:SIHAO PTY LTD.1 ROKEVA STREETEASTWOOD  
NSW 2122 Australia

Importado a EE. UU.: Sanven Technology Ltd. Suite 250,9166 Anaheim  
Place, Rancho Cucamonga, CA91730

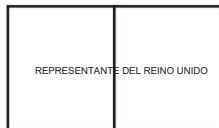

Pooledas Group Ltd  
Unidad 5 Albert Edward  
House, The Pavilions Preston, Reino  
Unido pooledas123@gmail.com  
01772418127

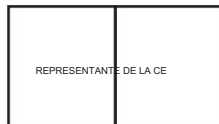

SHUNSHUN GmbH  
Römeräcker 9 Z2021,76351  
Linkenheim-Hochstetten, Alemania  
euagent@gmail.com  
+49 1727041930

Hecho en china



**VEVOR<sup>®</sup>**

**TOUGH TOOLS, HALF PRICE**

Soporte técnico y certificado de garantía electrónica

[www.vevor.com/support](http://www.vevor.com/support)

Fabricado en China

# VEVOR®

## TOUGH TOOLS, HALF PRICE

Wsparcie techniczne i certyfikat e-gwarancji [www.vevor.com/support](http://www.vevor.com/support)

### SŁUPEK OGRODZENIA KOTWICZ ZIEMIOWY

MODEL: FX-3.5-24-8 FX-3.5-24-4 FX-3.5-24-6 FX-3.5-36-8

FX-3.5-36-4 WGB-3.7-24-4 WGB-3.7-24-6 WGF-2-34-2

WGF-2-34-4 UX-3.5-27-1 UX-3.5-27-4

Nadal dokładamy wszelkich starań, aby zapewnić Państwu narzędzia w konkurencyjnej cenie.

„Zaoszczędź o połowę”, „o połowę ceny” lub inne podobne wyrażenia używane przez nas przedstawiają jedynie szacunkową oszczędność, jaką możesz zyskać kupując u nas określone narzędzia w porównaniu z głównymi najlepszymi markami i niekoniecznie oznaczają uwzględnienie wszystkich kategorii oferowanych narzędzi przez nas. Przypominamy, aby podczas składania zamówienia u nas dokładnie sprawdzić, czy faktycznie oszczędzasz połowę w porównaniu z czołowymi markami.





# VEVOR®

**TOUGH TOOLS, HALF PRICE**

KOTWA SŁUPKA OGRODZENIA

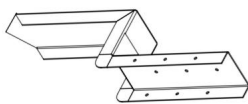
ZIEMNY KOLEK

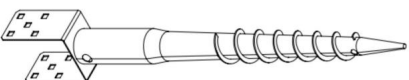
FX-3.5-24-8	
FX-3.5-24-4	
FX-3.5-24-6	
FX-3.5-36-8	
FX-3.5-36-4	
WGB-3.7-24-4	
WGB-3.7-24-6	
WGF-2-34-2	
WGF-2-34-4	
UX-3.5-27-1	
UX-3.5-27-4	

POTRZEBUJĘ POMOCY? SKONTAKTUJ SIĘ Z NAMI!

Masz pytania dotyczące produktu? Potrzebujesz wsparcia technicznego? Śmiało możesz się z nami skontaktować:

Wsparcie techniczne i certyfikat e-gwarancji  
[www.vevor.com/support](http://www.vevor.com/support)

To jest oryginalna instrukcja. Przed przystąpieniem do obsługi prosimy o dokładne zapoznanie się ze wszystkimi instrukcjami. VEVOR zastrzega sobie jasną interpretację naszej instrukcji obsługi. Wygląd produktu zależy od produktu, który otrzymałeś. Proszę wybaczyć nam, że nie będziemy ponownie informować Państwa, jeśli pojawią się jakieś aktualizacje technologii lub oprogramowania naszego produktu.

## WSTĘP

### OSTRZEŻENIE:

#### ŚRODKI OSTROŻNOŚCI PRZY MONTAŻU

1. Podczas montażu trzymaj dzieci i zwierzęta z daleka.
2. Prosimy o złożenie produktu ściśle według instrukcji. Nieprawidłowy montaż może być niebezpieczny.
3. Oddziel i policz wszystkie części i sprzęt.
4. Przygotuj następujące narzędzie: Śrubokręt Philips.
5. Postępuj zgodnie z przeznaczeniem.

Zapisz instrukcje.

























## PARAMETRY PRODUKTU

Model	Ilość	Kolor	Materiał	Rozmiar drewna do odpowiedni	Wysokość
FX-3.5-24-8	8	Czarny	Stal	3,5"	24"
FX-3.5-24-4	4	Czarny	Stal	3,5"	24"
FX-3.5-24-6	6	Czarny	Stal	3,5"	24"
FX-3.5-36-8	8	Czarny	Stal	3,5"	36"
FX-3.5-36-4	4	Czarny	Stal	3,5"	36"
WGB-3.7-24-4	4	Czarny	Stal	3,5"	24"
WGB-3.7-24-6	6	Czarny	Stal	3,5"	24"
WGF-2-34-2	2	Czarny	Stal	/	34"
WGF-2-34-4	4	Czarny	Stal	/	34"
UX-3.5-27-1	1	Srebro	Stal	3,5"	27"
UX-3.5-27-4	4	Srebro	Stal	3,5"	27"



## LISTA CZĘŚCI

Rozpakowując ten produkt, upewnij się, że w zestawie znajdują się wymienione poniżej części i dokładnie sprawdź, czy nie wystąpiły żadne uszkodzenia podczas transportu. Nie próbuj montować ani używać produktu, jeśli jakkolwiek część jest brak lub jest uszkodzony.

Model	Akcesorium					
FX-3.5-24-8	 M8×38	16szt	 M8	16szt	/	/
FX-3.5-24-4	 M8×38	8 szt	 M8	8 szt	/	/
FX-3.5-24-6	 M8×38	12szt	 M8	12szt	/	/
FX-3.5-36-8	 M8×38	16szt	 M8	16szt	/	/
FX-3.5-36-4	 M8×38	8 szt	 M8	8 szt	/	/
WGB-3.7-2 4-4	 M4,8*30	24szt	 M4,8*50	12szt		1 szt
WGB-3.7-2 4-6	 M4,8*30	36szt	 M4,8*50	18 sztuk		1 szt
WGF-2-34- 2	 M4,8*50	8 szt		1 szt	/	/
WGF-2-34- 4	 M4,8*50	16szt		1 szt	/	/
UX-3.5-27- 1	 M8*60	6szt	 Zbrojenie	1 szt	/	/
UX-3.5-27- 4	 M8*60	24szt	 Zbrojenie	1 szt	/	/

## METODY INSTALACJI

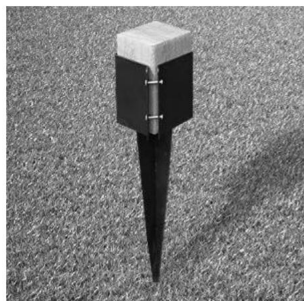
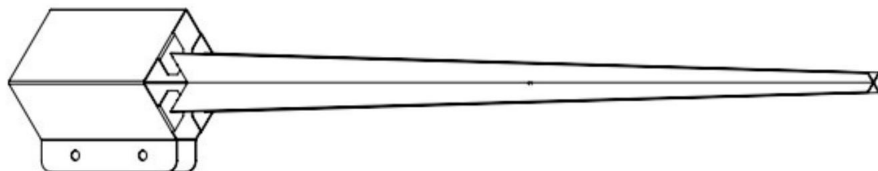

Umieść kotwę słupkową w żądanej pozycji. Zdobądź kawałek drewna i włóż go do podstawy słupka.

Używając młotka maczugowego lub ciężkiego młota kowalskiego (brak w zestawie), uderz w drewna, wbijając słupek w ziemię. Pomiar z poziomem stopniowo podczas młotkowania.

Gdy słupek znajdzie się bezpiecznie w żądanej pozycji, umieść go i dokręć śruby, aby jeszcze bardziej zapobiec ruchowi.

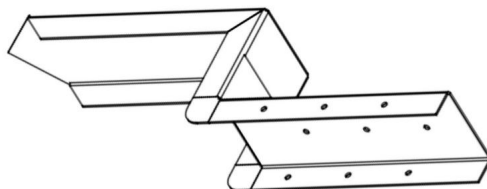



Zatrzaśnij wspornik w drewnianym słupku i trzymaj go prostopadłe do grunt.

Wbij wspornik tak, aby wszedł głęboko w ziemię, aż będzie równoległy do Ziemia.

Wywierć wstępnie ustawione otwory i zamocuj oddzielnie śruby, aby zakończyć instalacja.

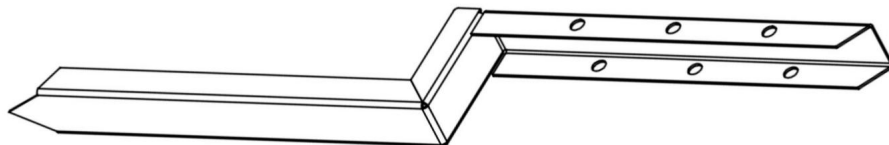

<p>Przymocuj wspornik naprawczy do post. post.</p>	<p>Wbijanie gwoździ kotwiących w grunt.</p>
	
<p>Wywiercić wstępnie ustawione otwory i wywiercić śruby.</p>	<p>Zakończ instalację.</p>

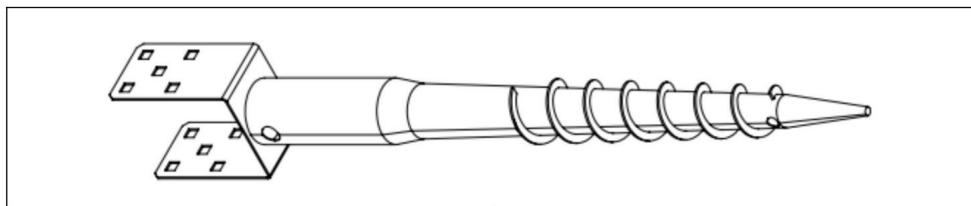

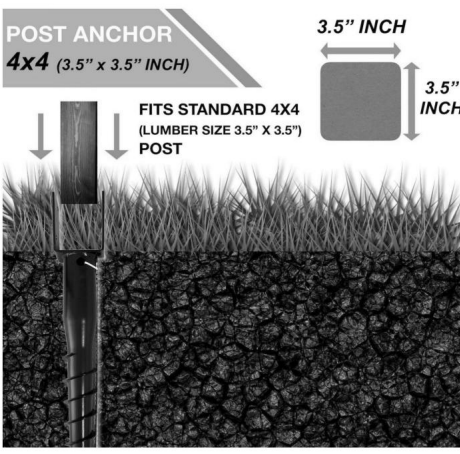
	<p><b>POST ANCHOR</b> <b>4x4 (3.5" x 3.5" INCH)</b></p> <p><b>3.5" INCH</b></p> <p><b>3.5" INCH</b></p> <p><b>FITS STANDARD 4X4 (LUMBER SIZE 3.5" X 3.5") POST</b></p> 
---	--

Wciśnij w ziemię i wkręć w ziemię za pomocą dostarczonego pręta wkładanego.  
Wyczyść otwór wystarczająco głęboki, aby pomieścić kołek o mniejszej średnicy niż trzonek kołka. Włóż kołek i przekręć za pomocą pręta napinającego.

Pasuje do standardowych słupków 4"x4" (wewnętrzne 3,5"x3,5") - idealnie pasuje do większości słupków do skrzynek pocztowych.

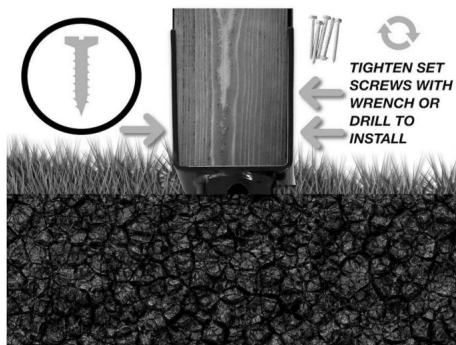
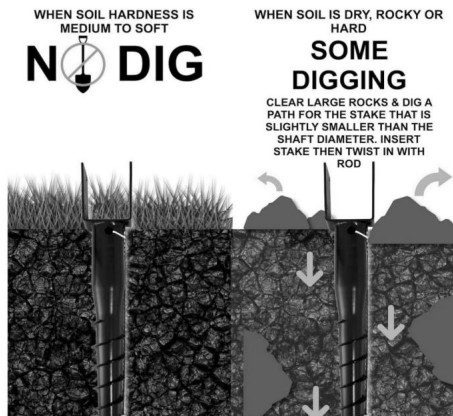

Instalacja: Nie ma potrzeby stosowania cementu  
Brak opcji kopania (w przypadku większości rodzajów gleby).

Zawiera drążek napinający i 5 śrub do drewna (użyj dwóch śrub po jednej stronie i trzech po drugiej).

Producent: Shanghaimuxinmuyeyouxiangongsi Adres:  
Baoshanqu Shuangchenglu 803long 11hao 1602A-1609shi Szanghaj Import do  
AUS:SIHAO  
PTY LTD.1 ROKEVA STREETEASTWOOD NSW 2122 Australia

Importowane do USA: Sanven Technology Ltd. Suite 250,9166 Anaheim Place,  
Rancho Cucamonga, CA91730



Pooledas Group Ltd  
Unit 5 Albert Edward House,  
The Pavilions Preston, Wielka Brytania  
Pooledas123@gmail.com  
01772418127

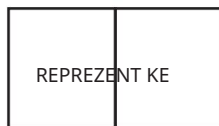

SHUNSHUN GmbH  
Römeräcker 9 Z2021,76351  
Linkenheim-Hochstetten, Niemcy  
euagent@gmail.com  
+49 1727041930

Wyprodukowano w Chinach



**VEVOR**®

**TOUGH TOOLS, HALF PRICE**

Certyfikat pomocy technicznej i e-gwarancji

[www.vevor.com/support](http://www.vevor.com/support)

Wyprodukowano w Chinach



# **VEVOR®**

## **TOUGH TOOLS, HALF PRICE**

Technische ondersteuning en e-garantiecertificaat [www.vevor.com/support](http://www.vevor.com/support)

### **OMHEININGSPPOST ANKER GRONDSPIKE**

**MODEL: FX-3,5-24-8 FX-3,5-24-4 FX-3,5-24-6 FX-3,5-36-8**

**FX-3,5-36-4 WGB-3,7-24-4 WGB-3,7-24-6 WGF-2-34-2**

**WGF-2-34-4 UX-3,5-27-1 UX-3,5-27-4**

We blijven ons inzetten om u gereedschap tegen een concurrerende prijs te bieden.



'Bespaar de helft', 'Halve prijs' of andere soortgelijke uitdrukkingen die door ons worden gebruikt vertegenwoordigen slechts een schatting van de besparingen die u zou kunnen profiteren als u bepaalde gereedschappen bij ons koopt in vergelijking met de grote topmerken en betekenen niet noodzakelijkerwijs dat ze alle categorieën van aangeboden gereedschappen dekken. door ons. Wij verzoeken u vriendelijk om bij het plaatsen van een bestelling bij ons goed na te gaan of u daadwerkelijk de helft bespaart in vergelijking met de grote topmerken.



# VEVOR®

TOUGH TOOLS, HALF PRICE

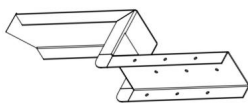
HEK POST ANKER  
GROND SPIKE

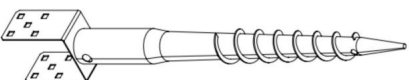
FX-3.5-24-8	
FX-3.5-24-4	
FX-3.5-24-6	
FX-3.5-36-8	
FX-3.5-36-4	
WGB-3.7-24-4	
WGB-3.7-24-6	
WGF-2-34-2	
WGF-2-34-4	
UX-3.5-27-1	
UX-3.5-27-4	

### HULP NODIG? NEEM CONTACT MET ONS OP!

Heeft u productvragen? Technische ondersteuning nodig? Neem dan gerust contact met ons op:

**Technische ondersteuning en e-garantiecertificaat [www.vevor.com/support](http://www.vevor.com/support)**

Dit is de originele instructie. Lees alle instructies in de handleiding zorgvuldig door voordat u ermee aan de slag gaat. VEVOR behoudt zich een duidelijke interpretatie van onze gebruikershandleiding voor. Het uiterlijk van het product is afhankelijk van het product dat u heeft ontvangen. Vergeef ons alstublieft dat we u niet opnieuw zullen informeren als er technologie- of software-updates zijn voor ons product.

## INVOERING

### WAARSCHUWING:

### MONTAGEVOORZORGSMAATREGELEN

1. Houd kinderen en huisdieren tijdens de montage uit de buurt.
2. Monteer het product strikt volgens de instructies.  
Een onjuiste montage kan gevaarlijk zijn.
3. Scheid en tel alle onderdelen en hardware.
4. Houd het volgende gereedschap gereed: kruiskopschroevendraaier.
5. Volg uitsluitend het beoogde gebruik.

























### Bewaar de instructies.

## PRODUCTPAREMETERS

Model	Aantal	Kleur	Materiaal	Houtmaat tot geschikt	Hoogte
FX-3.5-24-8	8	Zwart	Staal	3,5"	24"
FX-3.5-24-4	4	Zwart	Staal	3,5"	24"
FX-3.5-24-6	6	Zwart	Staal	3,5"	24"
FX-3.5-36-8	8	Zwart	Staal	3,5"	36"
FX-3.5-36-4	4	Zwart	Staal	3,5"	36"
WGB-3.7-24-4	4	Zwart	Staal	3,5"	24"
WGB-3.7-24-6	6	Zwart	Staal	3,5"	24"
WGF-2-34-2	2	Zwart	Staal	/	34"
WGF-2-34-4	4	Zwart	Staal	/	34"
UX-3.5-27-1	1	Zilver	Staal	3,5"	27"
UX-3.5-27-4	4	Zilver	Staal	3,5"	27"

## ONDERDELEN LIJST

Zorg er bij het uitpakken van dit product voor dat de onderstaande onderdelen aanwezig zijn en inspecteer zorgvuldig op eventuele schade tijdens het transport. Probeer het product niet te monteren of te gebruiken als er een onderdeel is ontbreekt of is beschadigd.

Model	Accessoire					
FX-3.5-24-8	 M8x38	16 stuks	 M8	16 stuks	/	/
FX-3.5-24-4	 M8x38	8 stuks	 M8	8 stuks	/	/
FX-3.5-24-6	 M8x38	12 stuks	 M8	12 stuks	/	/
FX-3.5-36-8	 M8x38	16 stuks	 M8	16 stuks	/	/
FX-3.5-36-4	 M8x38	8 stuks	 M8	8 stuks	/	/
WGB-3.7-2 4-4	 M4,8*30	24 stuks	 M4,8*50	12 stuks		1 stuk
WGB-3.7-2 4-6	 M4,8*30	36 stuks	 M4,8*50	18 stuks		1 stuk
WGF-2-34- 2	 M4,8*50	8 stuks		1 stuk	/	/
WGF-2-34- 4	 M4,8*50	16 stuks		1 stuk	/	/
UX-3.5-27- 1	 M8*60	6 stuks	 Wapening	1 stuk	/	/
UX-3.5-27- 4	 M8*60	24 stuks	 Wapening	1 stuk	/	/

## INSTALLATIEMETHODEN

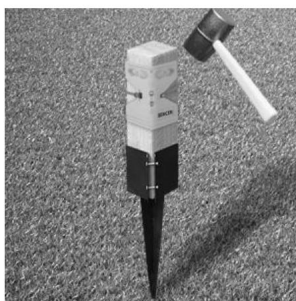
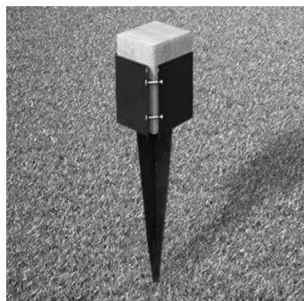
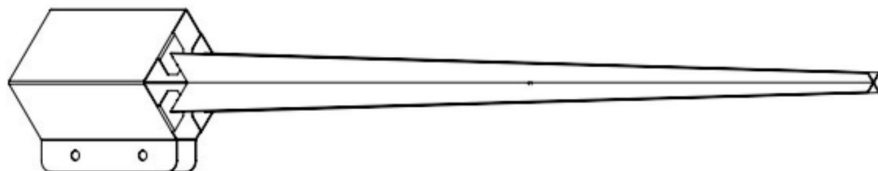

Plaats het paalanker in de gewenste positie. Neem een stukje hout en plaats deze in de paalbasis.

Gebruik een knuppelhamer of een zware voorhamer (niet inbegrepen) en sla op de hout, waardoor de paal in de grond werd geslagen. Meten met een niveau geleidelijk tijdens het hameren.

Zodra de paal veilig op de gewenste positie staat, plaatst u uw paal en draai de bouten vast om beweging verder te voorkomen.

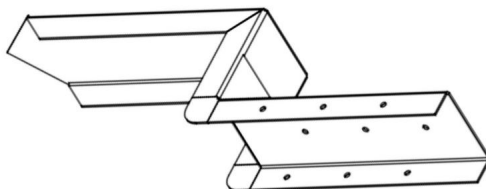



Klik de beugel in de houten paal en houd deze loodrecht op de grond.

Tik op de beugel zodat deze diep in de grond gaat totdat deze evenwijdig is aan de grond.

Boor de vooraf ingestelde gaten uit en draai de schroeven apart vast om te voltooien de installatie.

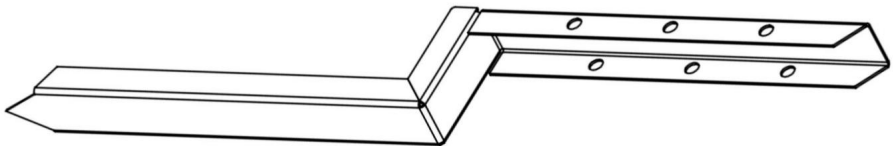

Bevestig de reparatiebeugel aan de na.



Het hameren van ankerspijkers in de grond.



Voorgeboorde gaten boren en erin boren schroeven.

Voltooi de installatie.

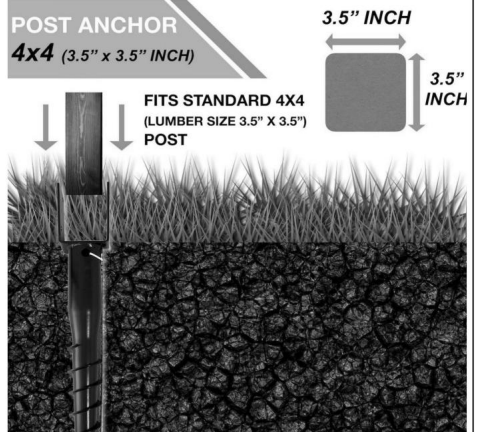
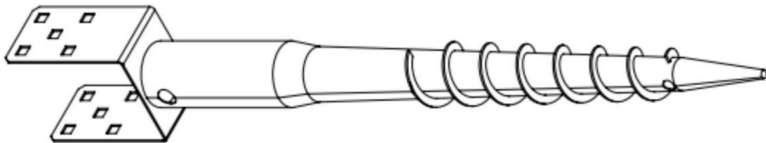



Druk in de grond en draai met de meegeleverde insteekstang in de grond. Maak een gat vrij dat diep genoeg is voor de paal, ja, met een kleinere diameter dan de paalschacht. Steek de paal erin en draai hem vast met een spanstang.

Past op standaard 4"x4" post (3,5"x3,5" binnen) - perfect voor de meeste brievenbusposten.

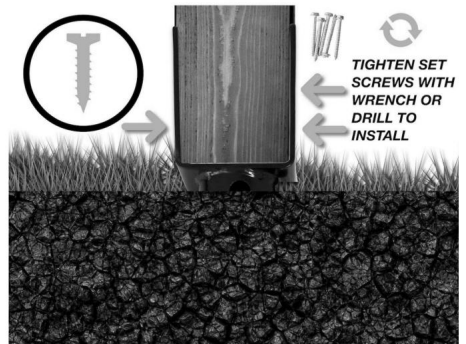
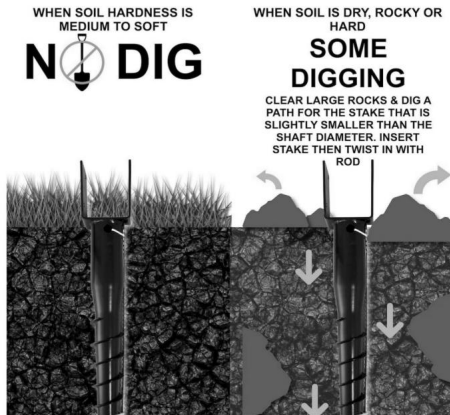

Installatie: Geen cement nodig  
Geen graafmogelijkheid (voor de meeste grondsoorten).

Inclusief spanstang en 5 houtdraadbouten (gebruik twee bouten aan de ene kant en drie aan de andere kant).

**Fabrikant:** Shanghaimuxinmuyeyouxiangongsi **Adres:**

Baoshanqu Shuangchenglu 803long 11hao 1602A-1609shi Shanghai

**Geïmporteerd in AUS:**SIHAO PTY LTD.1 ROKEVA STREETEASTWOOD NSW  
2122 Australië

**Geïmporteerd naar de VS:** Sanven Technology Ltd. Suite 250,9166 Anaheim  
Place, Rancho Cucamonga, CA91730



Pooledas Group Ltd

Unit 5 Albert Edward House,

The Pavilions Preston, Verenigd Koninkrijk

pooledas123@gmail.com

01772418127



SHUNSHUN GmbH

Römeräcker 9 Z2021,76351

Linkenheim-Hochstetten, Duitsland

euagent@gmail.com

+49 1727041930

**Gemaakt in China**



**VEVOR**<sup>®</sup>

**TOUGH TOOLS, HALF PRICE**

**Technische ondersteuning en e-  
garantiecertificaat**

**[www.vevor.com/support](http://www.vevor.com/support) Made In China**

# **VEVOR®**

## **TOUGH TOOLS, HALF PRICE**

Teknisk support och e-garanticertifikat [www.vevor.com/support](http://www.vevor.com/support)

### **STÄNGSELSTOLPE FÖRANKAR MARKSPIKE**

**MODELL: FX-3.5-24-8 FX-3.5-24-4 FX-3.5-24-6 FX-3.5-36-8**

**FX-3.5-36-4 WGB-3.7-24-4 WGB-3.7-24-6 WGF-2-34-2**

**WGF-2-34-4 UX-3.5-27-1 UX-3.5-27-4**

Vi fortsätter att vara engagerade i att ge dig verktyg till konkurrenskraftiga priser.



"Spara hälften", "halva priset" eller andra liknande uttryck som används av oss representerar bara en uppskattning av besparingar du kan dra nytta av att köpa vissa verktyg hos oss jämfört med de stora toppmärkena och betyder inte nödvändigtvis att täcka alla kategorier av verktyg som erbjuds av oss. Du påminns vänligen om att noggrant kontrollera när du gör en beställning hos oss om du faktiskt sparar hälften i jämförelse med de främsta stora varumärkena.



# VEVOR®

TOUGH TOOLS, HALF PRICE

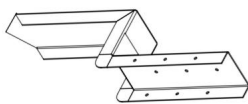
STÄNGSELSPOSTANKARE  
MARKSPIKE

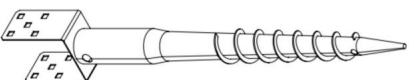
FX-3.5-24-8	
FX-3.5-24-4	
FX-3.5-24-6	
FX-3.5-36-8	
FX-3.5-36-4	
WGB-3.7-24-4	
WGB-3.7-24-6	
WGF-2-34-2	
WGF-2-34-4	
UX-3.5-27-1	
UX-3.5-27-4	

## BEHÖVS HJÄLP? KONTAKTA OSS!

Har du produktfrågor? Behöver du teknisk support? Kontakta oss gärna:

**Teknisk support och e-garanticertifikat**  
**[www.vevor.com/support](http://www.vevor.com/support)**

Detta är den ursprungliga instruktionen, läs alla instruktioner noggrant innan du använder den. VEVOR reserverar sig för en tydlig tolkning av vår användarmanual. Utseendet på produkten är beroende av den produkt du fått. Ursäkta oss att vi inte kommer att informera dig igen om det finns någon teknik eller mjukvaruuppdateringar på vår produkt.

## INTRODUKTION

### VARNING:

#### FÖRSIKTIGHETSÅTGÄRDER FÖR MONTERING

1. Håll barn och husdjur borta under monteringen.
2. Vänligen montera produkten i strikt enlighet med instruktionerna.  
Felaktig montering kan vara farligt.
3. Separera och räkna alla delar och hårdvara.
4. Förbered följande verktyg: Philips huvudskruvmejsel.
5. Följ endast avsedd användning.

### Spara instruktionerna.

























## PRODUKTPAREMETRAR

Modell	Antal	färgmaterial		Trästorlek till lämplig	Höjd
FX-3.5-24-8	8	Svart	Stål	3,5"	24"
FX-3.5-24-4	4	Svart	Stål	3,5"	24"
FX-3.5-24-6	6	Svart	Stål	3,5"	24"
FX-3.5-36-8	8	Svart	Stål	3,5"	36"
FX-3.5-36-4	4	Svart	Stål	3,5"	36"
WGB-3.7-24-4	4	Svart	Stål	3,5"	24"
WGB-3.7-24-6	6	Svart	Stål	3,5"	24"
WGF-2-34-2	2	Svart	Stål	/	34"
WGF-2-34-4	4	Svart	Stål	/	34"
UX-3.5-27-1	1	Silver	Stål	3,5"	27"
UX-3.5-27-4	4	Silver	Stål	3,5"	27"



## DELLISTA

När du packar upp den här produkten, se till att delarna som anges nedan ingår och inspektera noggrant för eventuella skador som kan ha uppstått under transitering. Försök inte att montera eller använda produkten om någon del är det saknas eller är skadad.

Modell	Tillbehör					
FX-3.5-24-8	 M8x38	16 st	 M8	16 st	/	/
FX-3.5-24-4	 M8x38	8 st	 M8	8 st	/	/
FX-3.5-24-6	 M8x38	12 st	 M8	12 st	/	/
FX-3.5-36-8	 M8x38	16 st	 M8	16 st	/	/
FX-3.5-36-4	 M8x38	8 st	 M8	8 st	/	/
WGB-3.7-2 4-4	 M4,8*30	24 st	 M4,8*50	12 st		1 st
WGB-3.7-2 4-6	 M4,8*30	36 st	 M4,8*50	18 st		1 st
WGF-2-34- 2	 M4,8*50	8 st		1 st	/	/
WGF-2-34- 4	 M4,8*50	16 st		1 st	/	/
UX-3.5-27- 1	 M8*60	6 st	 Armeringsjärn	1 st	/	/
UX-3.5-27- 4	 M8*60	24 st	 Armeringsjärn	1 st	/	/

## INSTALLATIONSMETODER

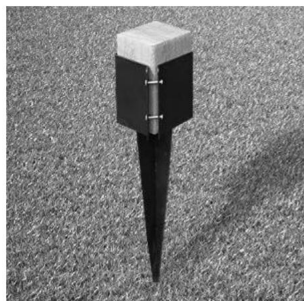
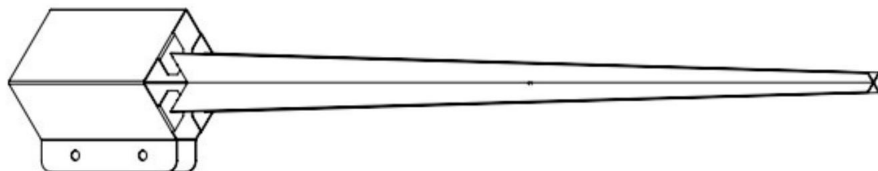

Placera stolpeankaret i önskat läge. Skaffa en träbit och sätt in den i stolpbasen.

Använd en klubbhammare eller kraftig slägga (ingår ej), slå på trä, kör stolpen i marken. Mätning med en nivå gradvis medan du hamrar.

När stolpen sitter säkert i önskad position, placera din stolpe och dra åt bultarna för att ytterligare förhindra rörelse.

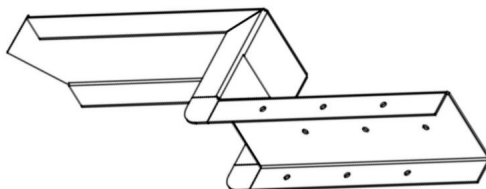



Snäpp fast fästet i trästolpen och håll det vinkelrätt mot jord.

Knacka på fästet så att det går djupt ner i marken tills det är parallellt med marken.

Borra ut de förinställda hålen och lås in skruvarna separat för att slutföra installationen.

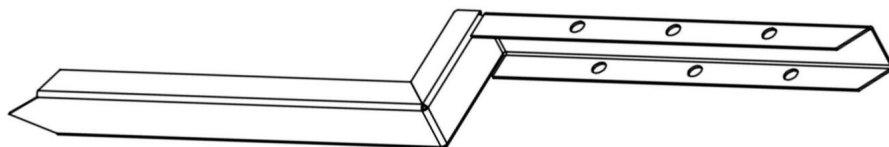

Fäst reparationsfästet på  
posta.



Slår ankarspikar in i  
jord.



Borra förinställda hål och borra i  
skruvar.

Avsluta installationen.

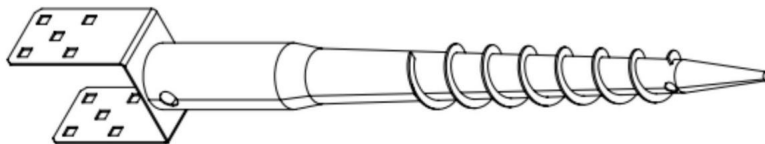

**POST ANCHOR**  
**4x4** (3.5" x 3.5" INCH)

3.5" INCH

FITS STANDARD 4X4  
(LUMBER SIZE 3.5" X 3.5")  
POST

3.5" INCH

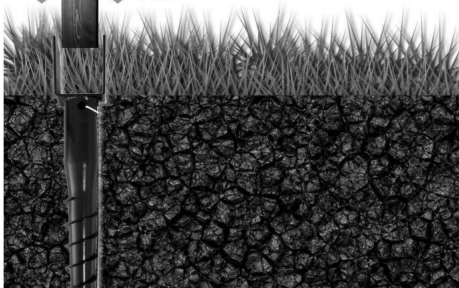

Tryck ner i jorden och vrid ner i marken med medföljande insatsstav.  
Rensa ett hål som är tillräckligt djupt för att rymma pålen, ja en mindre diameter än pålens skaft. Sätt in pålen och vrid in med spännstången.

Passar standard 4"x4" stolpe (3,5"x3,5" inre) - perfekt för de flesta postlådestolpar.

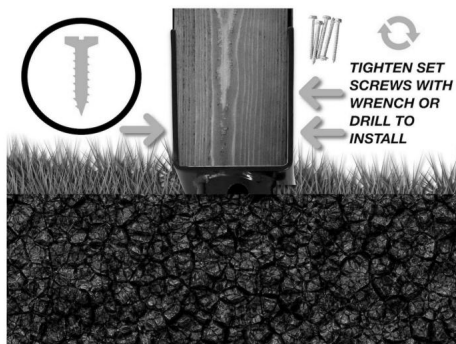
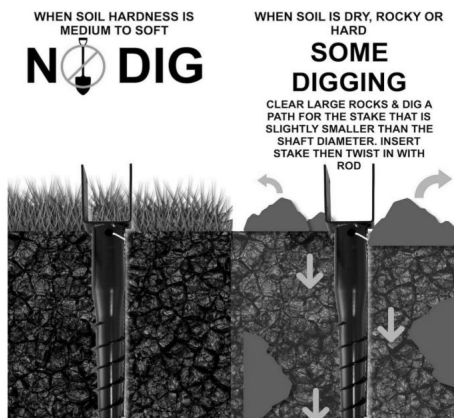

Installation: Inget behov av cement  
Inget grävningalternativ (för de flesta jordtyper).

Inkluderar spännstång och 5 lagbultar (använd två bultar på ena sidan och tre på den andra).

**Tillverkare:** Shanghaimuxinmuyeyouxiangongsi

**Adress:** Baoshanqu Shuangchenglu 803long 11hao 1602A-1609shi  
Shanghai

**Importerad till AUS:**SIHAO PTY LTD.1 ROKEVA STREETEASTWOOD  
NSW 2122 Australien

**Importerad till USA:**Sanven Technology Ltd. Suite 250,9166 Anaheim  
Place, Rancho Cucamonga, CA91730



Pooledas Group Ltd  
Unit 5 Albert Edward House,  
The Pavilions Preston, Storbritannien  
pooledas123@gmail.com  
01772418127



SHUNSHUN GmbH  
Römeräcker 9 Z2021,76351  
Linkenheim-Hochstetten, Tyskland  
euagent@gmail.com  
+49 1727041930

**Tillverkad i Kina**



**VEVOR**®

**TOUGH TOOLS, HALF PRICE**

**Teknisk support och e-garanticertifikat**

**[www.vevor.com/support](http://www.vevor.com/support)**

**Tillverkad i Kina**