

# **VEVOR<sup>®</sup>**

**TOUGH TOOLS, HALF PRICE**

Technical Support and E-Warranty Certificate [www.vevor.com/support](http://www.vevor.com/support)

## **MINI SPLIT LINE SET COVER**

### **OPERATING INSTRUCTIONS**

We continue to be committed to provide you tools with competitive price.

"Save Half", "Half Price" or any other similar expressions used by us only represents an estimate of savings you might benefit from buying certain tools with us compared to the major top brands and does not necessarily mean to cover all categories of tools offered by us. You are kindly reminded to verify carefully when you are placing an order with us if you are actually saving half in comparison with the top major brands.

# VEVOR®

TOUGH TOOLS, HALF PRICE



## NEED HELP? CONTACT US!

Have product questions? Need technical support? Please feel free to contact us:

**Technical Support and E-Warranty Certificate**  
**[www.vevor.com/support](http://www.vevor.com/support)**

This is the original instruction, please read all manual instructions carefully before operating. VEVOR reserves a clear interpretation of our user manual. The appearance of the product shall be subject to the product you received. Please forgive us that we won't inform you again if there are any technology or software updates on our product.

## **WARNING:**

1. This product is not a toy, Do not allow children to climb on the unit.
2. Keep children and pets away during assembly.
3. To avoid the danger of suffocation, always keep plastic bags away from children and pets.

## **ASSEMBLY PRECAUTIONS**

1. Please assemble the product in strict accordance with the instructions. Incorrect assembly could be hazardous.
2. Please wear safety goggles and work gloves properly during assembly.
3. Do not try to assemble the product when feeling tired or when under the influence of alcohol, drugs or medication.
4. Load bearing capacity and other product parameters are applied to the properly and completely assembled product only.
5. Separate and count all parts and hardware.
6. Prepare the following tool: Philips Head Screwdriver.
7. If using power tools, please be careful to slow down and stop when needed.
8. Two people are required for assembly.
9. Follow the intended uses only. Do not sit or stand on the above.





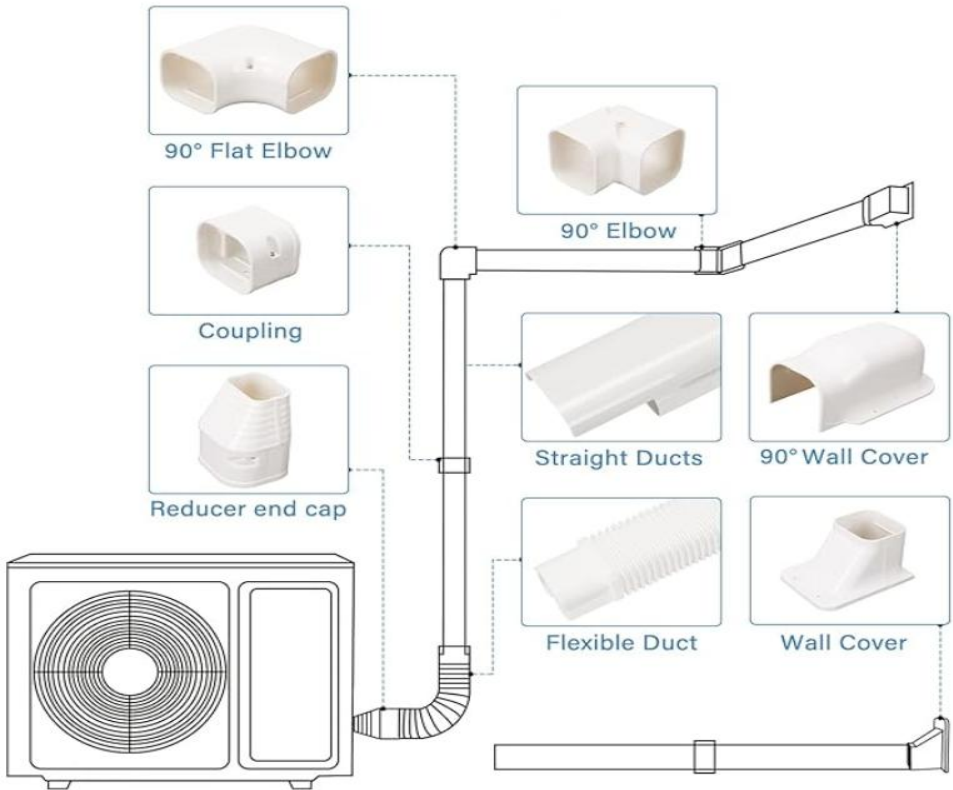



**SAVE THESE INSTRUCTIONS.**

# INSTALLATION



# PARTS LIST

No	Comp onents	Picture	Fits Model#				
			11000 61667	11000 61668	11000 61669	11000 61670	11000 61671
1	Straig ht Ducts		2pcs	5pcs	4pcs	10pcs	4pcs

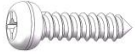
2	Flexible Duct		N	1pcs	1pcs	1pcs	2pcs
3	Coupling		1pcs	4pcs	3pcs	9pcs	3pcs
4	Reducer end cap		1pcs	1pcs	1pcs	1pcs	1pcs
5	90° Flat Elbow		N	1pcs	1pcs	1pcs	1pcs
6	90° Elbow		N	1pcs	1pcs	1pcs	1pcs
7	90° Wall Cover		1pcs	1pcs	1pcs	1pcs	1pcs
8	Wall Cover		N	N	N	1pcs	1pcs
9	ST3.5*16		8pcs	19pcs	17pcs	30pcs	17pcs
10	ST4*25		5pcs	12pcs	11pcs	19pcs	13pcs

11	Ribbon		5pcs	12pcs	10pcs	22pcs	10pcs
----	--------	---	------	-------	-------	-------	-------

Remark: "N" =No

## PARAMETER TABLE

Model	Installation size
1100061667	227*7.5*6cm
1100061668	311*7.5*6cm
1100061669	483*7.5*6cm
1100061670	540*7.5*6cm
1100061671	535*7.5*6cm

**Address:** Baoshanqu Shuangchenglu 803long 11hao 1602A-1609shi  
Shanghai

**Imported to AUS:** SIHAO PTY LTD. 1 ROKEVA STREETEASTWOOD  
NSW 2122 Australia

**Imported to USA:** Sanven Technology Ltd. Suite 250, 9166 Anaheim  
Place, Rancho Cucamonga, CA 91730



**SHUNSHUN GmbH**  
Römeräcker 9 Z2021,76351  
Linkenheim-Hochstetten, Germany  
euvertreter@gmail.com  
+49 1727041930



**Pooledas Group Ltd**  
Unit 5 Albert Edward House, The  
Pavilions Preston, United Kingdom  
pooledas123@gmail.com  
01772418127

**Made In China**



**VEVOR<sup>®</sup>**

**TOUGH TOOLS, HALF PRICE**

**Technical Support and E-Warranty Certificate**

**[www.vevor.com/support](http://www.vevor.com/support)**



# **VEVOR<sup>®</sup>**

**TOUGH TOOLS, HALF PRICE**

Technique Assistance et certificat de garantie électronique

[www.vevor.com/support](http://www.vevor.com/support)

## **COUVERCLE MINI SPLIT LINE**

### **MODE D'EMPLOI**

We continue to be committed to provide you tools with competitive price.

"Save Half", "Half Price" or any other similar expressions used by us only represents an estimate of savings you might benefit from buying certain tools with us compared to the major top brands and does not necessarily mean to cover all categories of tools offered by us. You are kindly reminded to verify carefully when you are placing an order with us if you are actually saving half in comparison with the top major brands.

# VEVOR®

TOUGH TOOLS, HALF PRICE



## NEED HELP? CONTACT US!

Have product questions? Need technical support? Please feel free to contact us:

**Technical Support and E-Warranty Certificate**  
**[www.vevor.com/support](http://www.vevor.com/support)**

This is the original instruction, please read all manual instructions carefully before operating. VEVOR reserves a clear interpretation of our user manual. The appearance of the product shall be subject to the product you received. Please forgive us that we won't inform you again if there are any technology or software updates on our product.

## **AVERTISSEMENT:**

1. Ce produit n'est pas un jouet, ne laissez pas les enfants grimper sur l'appareil.
2. Éloignez les enfants et les animaux domestiques pendant l'assemblage.
3. Pour éviter tout risque d'étouffement, gardez toujours les sacs en plastique hors de portée des enfants et des animaux domestiques.

## **PRÉCAUTIONS DE MONTAGE**

1. Veuillez assembler le produit en stricte conformité avec les instructions. Un assemblage incorrect pourrait être dangereux.
2. Veuillez porter correctement des lunettes de sécurité et des gants de travail pendant l'assemblage.
3. N'essayez pas d'assembler le produit lorsque vous vous sentez fatigué ou sous l'influence de l'alcool, de drogues ou de médicaments.
4. La capacité de charge et les autres paramètres du produit sont appliqués uniquement au produit correctement et complètement assemblé.
5. Séparez et comptez toutes les pièces et le matériel.
6. Préparez l'outil suivant : Tournevis cruciforme.
7. Si vous utilisez des outils électriques, veillez à ralentir et à vous arrêter si nécessaire.
8. Deux personnes sont nécessaires pour le montage.
9. Suivez uniquement les utilisations prévues. Ne vous asseyez pas et ne vous tenez pas debout sur ce qui précède.





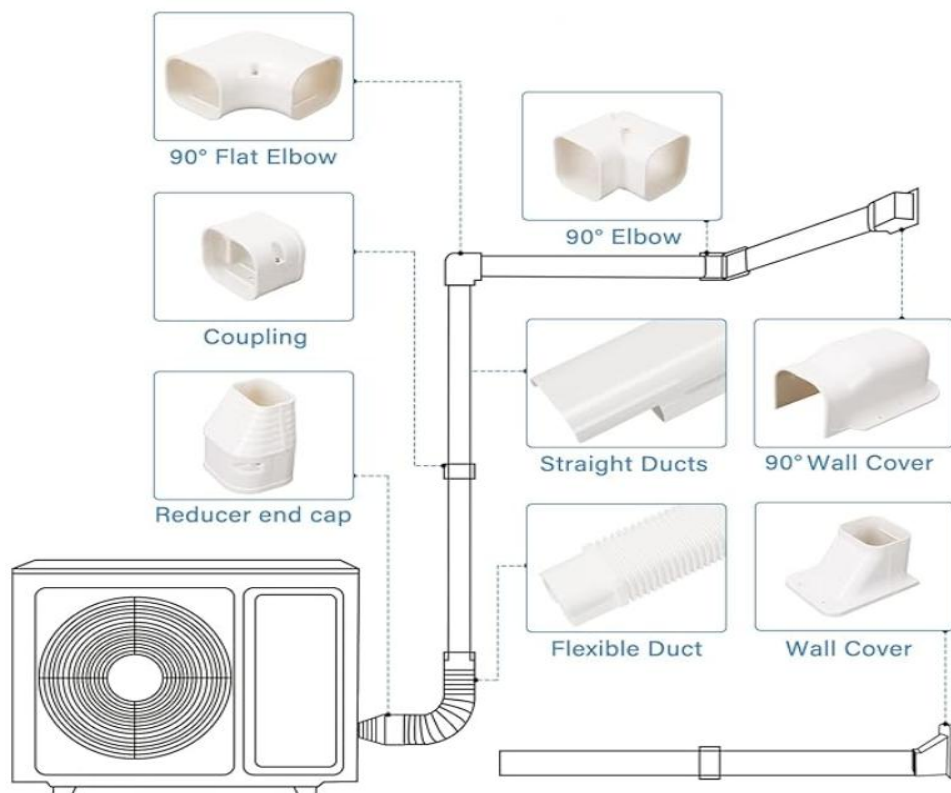



## **CONSERVEZ CES INSTRUCTIONS.**

# INSTALLATION



# LISTE DES PIECES

No n	Comp osants	Image	Convient au modèle #				
			11000 61667	11000 61668	11000 61669	11000 61670	11000 61671

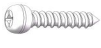
1	Conduits droits		2 pièces	5 pièces	4 pièces	10 pièces	4 pièces
2	Conduit flexible		N	1 PCS	1 PCS	1 PCS	2 pièces
3	Couplage		1 PCS	4 pièces	3 pièces	9 pièces	3 pièces
4	Embout réducteur		1 PCS	1 PCS	1 PCS	1 PCS	1 PCS
5	Coude plat à 90°		N	1 PCS	1 PCS	1 PCS	1 PCS
6	Coude 90°		N	1 PCS	1 PCS	1 PCS	1 PCS
7	Couverture murale 90°		1 PCS	1 PCS	1 PCS	1 PCS	1 PCS
8	Couverture murale		N	N	N	1 PCS	1 PCS
9	ST3.5* 16		8 pièces	19 pièces	17 pièces	30 pièces	17 pièces

dix	ST4*2 5		5 pièces	12 pièces	11 pièces	19 pièces	13 pièces
11	Ruban		5 pièces	12 pièces	10 pièces	22 pièces	10 pièces

Remarque : « N » =Non

## TABLEAU DES PARAMÈTRES

Modèle	Taille d'installation
1100061667	227*7.5*6cm
110006166 8	311*7.5*6cm
110006166 9	483*7.5*6cm
11000616 70	540*7.5*6cm
11000616 71	535*7.5*6cm

**Adresse :** Baoshanqu Shuangchenglu 803long 11hao 1602A-1609shi  
Shanghai

**Importé en Australie :** SIHAO PTY LTD . 1 ROKEVA STREETASTWOOD  
NSW 2122 Australie

**Importé aux États-Unis :** Sanven Technology Ltd. Suite 250, 9166  
Anaheim Place, Rancho Cucamonga, CA 91730



**SHUNSHUN GmbH**  
Römeräcker 9 Z2021,76351  
Linkenheim-Hochstetten, Germany  
euvertreter@gmail.com  
+49 1727041930



**Pooledas Group Ltd**  
Unit 5 Albert Edward House, The  
Pavilions Preston, United Kingdom  
pooledas123@gmail.com  
01772418127

**Fabriqué en Chine**





**VEVOR**<sup>®</sup>

**TOUGH TOOLS, HALF PRICE**

**Technique Assistance et certificat de garantie électronique**

**[www.vevor.com/support](http://www.vevor.com/support)**

# **VEVOR<sup>®</sup>**

**TOUGH TOOLS, HALF PRICE**

Technisch Support- und E-Garantie-Zertifikat [www.vevor.com/support](http://www.vevor.com/support)

## **MINI-SPLIT-LINE-SET-ABDECKUNG**

### **BEDIENUNGSANLEITUNG**

We continue to be committed to provide you tools with competitive price.

"Save Half", "Half Price" or any other similar expressions used by us only represents an estimate of savings you might benefit from buying certain tools with us compared to the major top brands and does not necessarily mean to cover all categories of tools offered by us. You are kindly reminded to verify carefully when you are placing an order with us if you are actually saving half in comparison with the top major brands.

# VEVOR®

TOUGH TOOLS, HALF PRICE



## NEED HELP? CONTACT US!

Have product questions? Need technical support? Please feel free to contact us:

**Technical Support and E-Warranty Certificate**  
**[www.vevor.com/support](http://www.vevor.com/support)**

This is the original instruction, please read all manual instructions carefully before operating. VEVOR reserves a clear interpretation of our user manual. The appearance of the product shall be subject to the product you received. Please forgive us that we won't inform you again if there are any technology or software updates on our product.

## **WARNUNG:**

1. Dieses Produkt ist kein Spielzeug. Erlauben Sie Kindern nicht, auf das Gerät zu klettern.
2. Halten Sie Kinder und Haustiere während der Montage fern.
3. Um Erstickungsgefahr zu vermeiden, halten Sie Plastiktüten immer von Kindern und Haustieren fern.

## **VORSICHTSMASSNAHMEN BEI DER MONTAGE**

1. Bitte bauen Sie das Produkt unter strikter Einhaltung der Anweisungen zusammen. Eine falsche Montage kann gefährlich sein.
2. Bitte tragen Sie bei der Montage ordnungsgemäß eine Schutzbrille und Arbeitshandschuhe.
3. Versuchen Sie nicht, das Produkt zusammenzubauen, wenn Sie sich müde fühlen oder unter dem Einfluss von Alkohol, Drogen oder Medikamenten stehen.
4. Tragfähigkeit und andere Produktparameter beziehen sich ausschließlich auf das ordnungsgemäß und vollständig montierte Produkt.
5. Trennen und zählen Sie alle Teile und Hardware.
6. Bereiten Sie das folgende Werkzeug vor: Kreuzschlitzschraubendreher.
7. Wenn Sie Elektrowerkzeuge verwenden, achten Sie bitte darauf, langsamer zu fahren und bei Bedarf anzuhalten.
8. Für den Aufbau sind zwei Personen erforderlich.
9. Befolgen Sie nur die vorgesehenen Verwendungszwecke. Setzen oder stehen Sie nicht darauf.





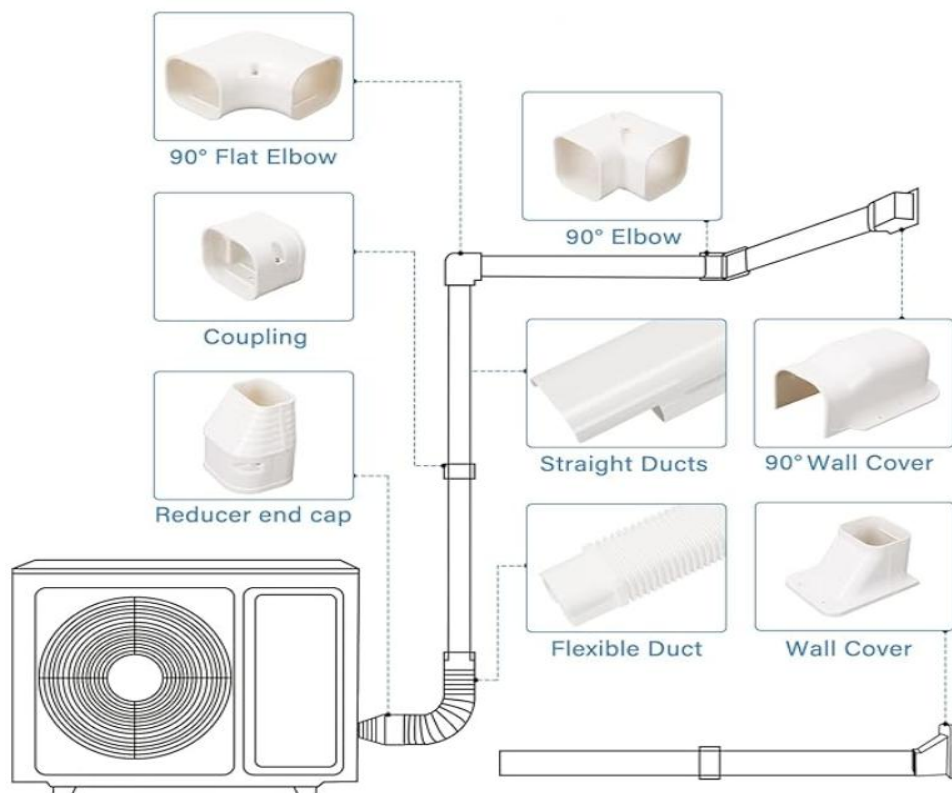



## **ANLEITUNG AUFBEWAHREN.**



# INSTALLATION



## LISTE DER EINZELTEILE

NE IN	Komponenten	Bild	Passend für Modell Nr.				
			11000 61667	11000 61668	11000 61669	11000 61670	11000 61671

1	Gerade Kanäle		2Stk	5 Stück	4 Stück	10 Stück	4 Stück
2	Flexibler Kanal		N	1 Stück	1 Stück	1 Stück	2Stk
3	Kupplung		1 Stück	4 Stück	3 Stück	9 Stück	3 Stück
4	Endkappe des Reduzierstücks		1 Stück	1 Stück	1 Stück	1 Stück	1 Stück
5	90°-Flachbogen		N	1 Stück	1 Stück	1 Stück	1 Stück
6	90°-Winkel		N	1 Stück	1 Stück	1 Stück	1 Stück
7	90°-Wandabdeckung		1 Stück	1 Stück	1 Stück	1 Stück	1 Stück
8	Wandabdeckung		N	N	N	1 Stück	1 Stück

9	ST3,5* 16		8 Stück	19 Stück	17 Stück	30 Stück	17 Stück
10	ST4*2 5		5 Stück	12 Stück	11 Stück	19 Stück	13 Stück
11	Schleif e		5 Stück	12 Stück	10 Stück	22 Stück	10 Stück

Bemerkung: „ N “ =Nein

## PARAMETERTABELLE

Modell	Installationsgröße
1100061667	227*7,5*6cm
110006166 8	311*7,5*6cm
110006166 9	483*7,5*6cm
11000616 70	540*7,5*6cm
11000616 71	535*7,5*6cm

**Adresse:** Baoshanqu Shuangchenglu 803long 11hao 1602A-1609shi  
Shanghai

**Importiert nach AUS:** SIHAO PTY LTD . 1 ROKEVA  
STREETEASTWOOD NSW 2122 Australien

**In die USA importiert:** Sanven Technology Ltd. Suite 250, 9166 Anaheim  
Place, Rancho Cucamonga, CA 91730



**SHUNSHUN GmbH**  
Römeräcker 9 Z2021,76351  
Linkenheim-Hochstetten, Germany  
euvertreter@gmail.com  
+49 1727041930



**Pooledas Group Ltd**  
Unit 5 Albert Edward House, The  
Pavilions Preston, United Kingdom  
pooledas123@gmail.com  
01772418127

**In China hergestellt**





**VEVOR<sup>®</sup>**

**TOUGH TOOLS, HALF PRICE**

**Technisch Support- und E-Garantiezertifikat**

**[www.vevor.com/support](http://www.vevor.com/support)**

# **VEVOR<sup>®</sup>**

**TOUGH TOOLS, HALF PRICE**

Tecnico Supporto e certificato di garanzia elettronica [www.vevor.com/support](http://www.vevor.com/support)

## **COPERTURA SET MINI SPLIT LINE**

### **ISTRUZIONI PER L'USO**

We continue to be committed to provide you tools with competitive price.

"Save Half", "Half Price" or any other similar expressions used by us only represents an estimate of savings you might benefit from buying certain tools with us compared to the major top brands and does not necessarily mean to cover all categories of tools offered by us. You are kindly reminded to verify carefully when you are placing an order with us if you are actually saving half in comparison with the top major brands.

# VEVOR®

TOUGH TOOLS, HALF PRICE



## NEED HELP? CONTACT US!

Have product questions? Need technical support? Please feel free to contact us:

**Technical Support and E-Warranty Certificate**  
**[www.vevor.com/support](http://www.vevor.com/support)**

This is the original instruction, please read all manual instructions carefully before operating. VEVOR reserves a clear interpretation of our user manual. The appearance of the product shall be subject to the product you received. Please forgive us that we won't inform you again if there are any technology or software updates on our product.

## **AVVERTIMENTO:**

1. Questo prodotto non è un giocattolo, non permettere ai bambini di salire sull'unità.
2. Tenere lontani bambini e animali domestici durante il montaggio.
3. Per evitare il pericolo di soffocamento, tenere sempre i sacchetti di plastica lontano dalla portata dei bambini e degli animali domestici.

## **PRECAUZIONI DI MONTAGGIO**

1. Si prega di assemblare il prodotto attenendosi rigorosamente alle istruzioni. Un montaggio errato potrebbe essere pericoloso.
2. Indossare correttamente occhiali protettivi e guanti da lavoro durante il montaggio.
3. Non tentare di montare il prodotto quando ci si sente stanchi o sotto l'influenza di alcol, droghe o farmaci.
4. La capacità di carico e altri parametri del prodotto vengono applicati solo al prodotto correttamente e completamente assemblato.
5. Separare e contare tutte le parti e l'hardware.
6. Preparare il seguente strumento: cacciavite a croce.
7. Se si utilizzano utensili elettrici, fare attenzione a rallentare e fermarsi quando necessario.
8. Per il montaggio sono necessarie due persone.
9. Seguire solo gli usi previsti. Non sedersi o stare in piedi su quanto sopra.

## **CONSERVA QUESTE ISTRUZIONI.**

## INSTALLAZIONE

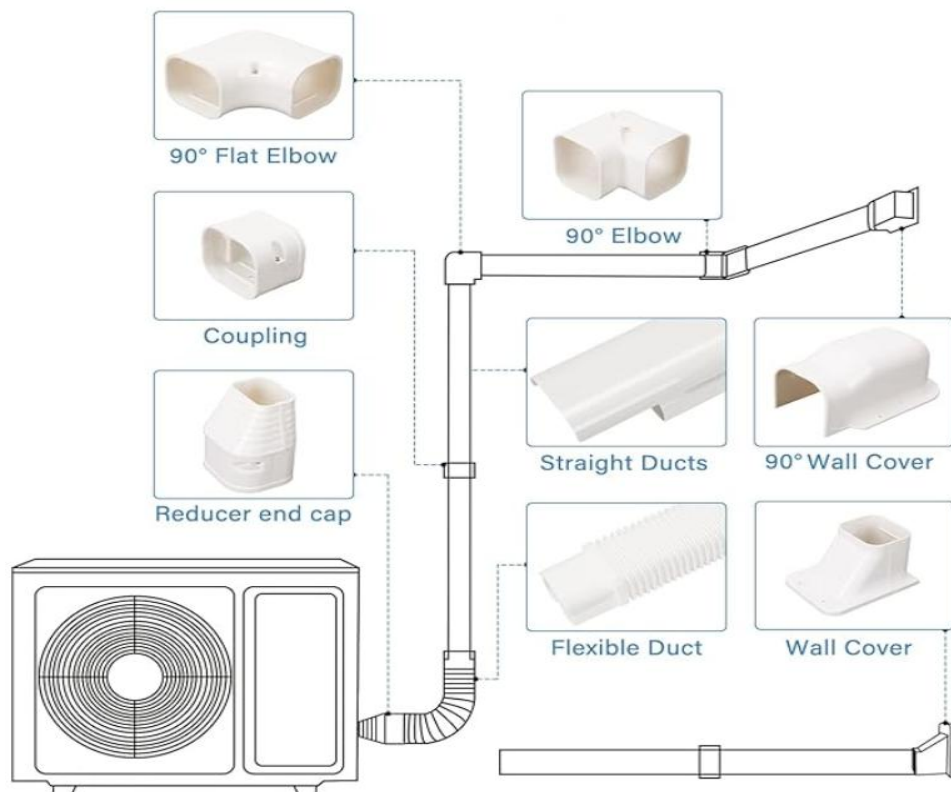

## ELENCO DELLE PARTI

NO	Comp onenti	Immagine	Adatto al modello n.				
			11000 61667	11000 61668	11000 61669	11000 61670	11000 61671

1	Condotti dritti		2 pezzi	5 pezzi	4 pezzi	10 pezzi	4 pezzi
2	Condotto flessibile		N	1 pz	1 pz	1 pz	2 pezzi
3	Accoppiamento		1 pz	4 pezzi	3 pezzi	9 pezzi	3 pezzi
4	Tappo terminale riduttore		1 pz	1 pz	1 pz	1 pz	1 pz
5	Gomitolo piatto a 90°		N	1 pz	1 pz	1 pz	1 pz
6	Gomitolo a 90°		N	1 pz	1 pz	1 pz	1 pz
7	Copertura da parete a 90°		1 pz	1 pz	1 pz	1 pz	1 pz
8	Copertura murale		N	N	N	1 pz	1 pz

9	ST3,5* 16		8 pezzi	19 pezzi	17 pezzi	30 pezzi	17 pezzi
10	ST4*2 5		5 pezzi	12 pezzi	11 pezzi	19 pezzi	13 pezzi
11	Nastro		5 pezzi	12 pezzi	10 pezzi	22 pezzi	10 pezzi

Nota: “ N ” =No

## TABELLA PARAMETRI

Modello	Dimensioni dell'installazione
1100061667	227*7,5*6 cm
1100061668 _	311*7,5*6 cm
1100061669 _	483*7,5*6 cm
1100061670 _	540*7,5*6 cm
1100061671 _	535*7,5*6 cm

**Indirizzo:** Baoshanqu Shuangchenglu 803long 11hao 1602A-1609shi  
Shanghai

**Importato in AUS:** SIHAO PTY LTD . 1 ROKEVA STREETEASTWOOD  
NSW 2122 Australia

**Importato negli Stati Uniti:** Sanven Technology Ltd. Suite 250, 9166  
Anaheim Place, Rancho Cucamonga, CA 91730





**SHUNSHUN GmbH**  
Römeräcker 9 Z2021,76351  
Linkenheim-Hochstetten, Germany  
euvertreter@gmail.com  
+49 1727041930



**Pooledas Group Ltd**  
Unit 5 Albert Edward House, The  
Pavilions Preston, United Kingdom  
pooledas123@gmail.com  
01772418127

**Made in China**



**VEVOR**<sup>®</sup>

**TOUGH TOOLS, HALF PRICE**

**Tecnico Supporto e certificato di garanzia elettronica**

**[www.vevor.com/support](http://www.vevor.com/support)**

# **VEVOR<sup>®</sup>**

**TOUGH TOOLS, HALF PRICE**

Técnico Soporte y certificado de garantía electrónica [www.vevor.com/support](http://www.vevor.com/support)

## **FUNDA JUEGO LÍNEA MINI SPLIT**

### **INSTRUCCIONES DE OPERACIÓN**

We continue to be committed to provide you tools with competitive price.

"Save Half", "Half Price" or any other similar expressions used by us only represents an estimate of savings you might benefit from buying certain tools with us compared to the major top brands and does not necessarily mean to cover all categories of tools offered by us. You are kindly reminded to verify carefully when you are placing an order with us if you are actually saving half in comparison with the top major brands.

# VEVOR®

TOUGH TOOLS, HALF PRICE



## NEED HELP? CONTACT US!

Have product questions? Need technical support? Please feel free to contact us:

**Technical Support and E-Warranty Certificate**  
**[www.vevor.com/support](http://www.vevor.com/support)**

This is the original instruction, please read all manual instructions carefully before operating. VEVOR reserves a clear interpretation of our user manual. The appearance of the product shall be subject to the product you received. Please forgive us that we won't inform you again if there are any technology or software updates on our product.

## **ADVERTENCIA:**

1. Este producto no es un juguete. No permita que los niños se suban a la unidad.
2. Mantenga alejados a los niños y las mascotas durante el montaje.
3. Para evitar el peligro de asfixia, mantenga siempre las bolsas de plástico fuera del alcance de los niños y las mascotas.

## **PRECAUCIONES DE MONTAJE**

1. Ensamble el producto estrictamente de acuerdo con las instrucciones. El montaje incorrecto podría ser peligroso.
2. Utilice gafas de seguridad y guantes de trabajo correctamente durante el montaje.
3. No intente montar el producto cuando se sienta cansado o bajo la influencia del alcohol, drogas o medicamentos.
4. La capacidad de carga y otros parámetros del producto se aplican únicamente al producto ensamblado de manera adecuada y completa.
5. Separe y cuente todas las piezas y herrajes.
6. Prepare la siguiente herramienta: Destornillador Philips.
7. Si utiliza herramientas eléctricas, tenga cuidado de reducir la velocidad y detenerse cuando sea necesario.
8. Para el montaje se necesitan dos personas.
9. Siga únicamente los usos previstos. No se sienta ni se pare sobre lo anterior.





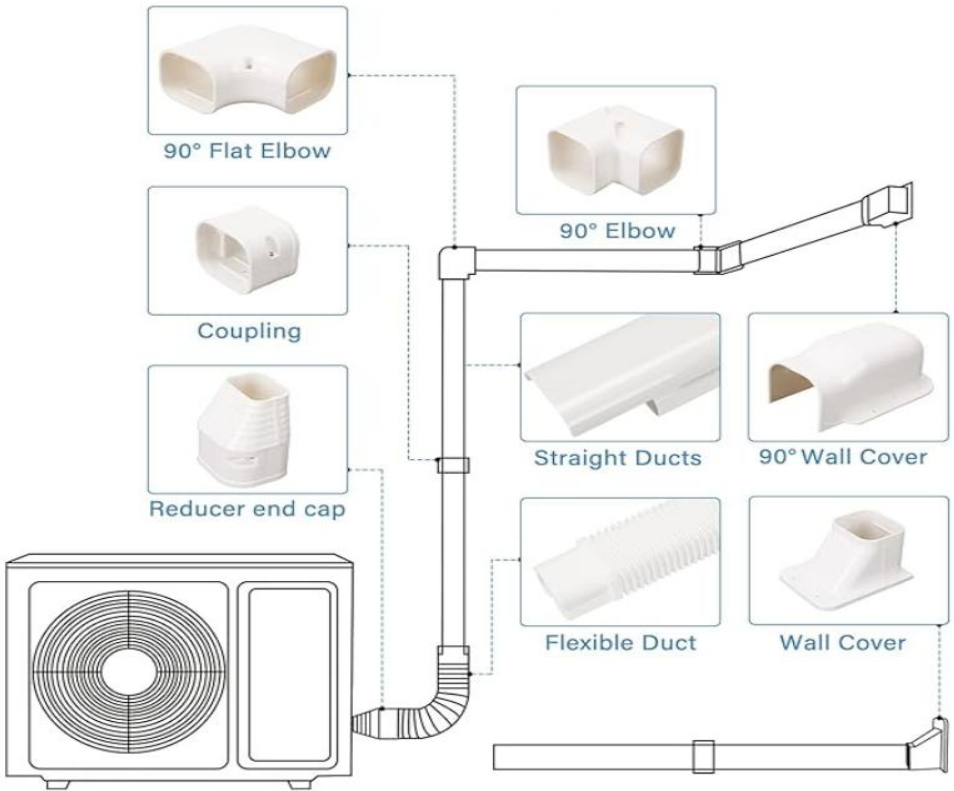



## **GUARDA ESTAS INSTRUCCIONES.**

# INSTALACIÓN



## LISTA DE PARTES

No	Componentes	Imagen	Se adapta al modelo #				
			11000 61667	11000 61668	11000 61669	11000 61670	11000 61671

1	Condu ctos Rectos		2 piezas	5 piezas	4 piezas	10 piezas	4 piezas
2	Condu cto flexible		norte	PC 1	PC 1	PC 1	2 piezas
3	Acopla miento		PC 1	4 piezas	3 piezas	9 piezas	3 piezas
4	Tapa del extrem o del reduct or		PC 1	PC 1	PC 1	PC 1	PC 1
5	Codo plano de 90°		norte	PC 1	PC 1	PC 1	PC 1
6	Codo de 90°		norte	PC 1	PC 1	PC 1	PC 1
7	Cubier ta de pared de 90°		PC 1	PC 1	PC 1	PC 1	PC 1
8	Cubier ta de pared		norte	norte	norte	PC 1	PC 1



9	ST3.5* 16		8 piezas	19 piezas	17 piezas	30 piezas	17 piezas
10	ST4*2 5		5 piezas	12 piezas	11 piezas	19 piezas	13 piezas
11	Cinta		5 piezas	12 piezas	10 piezas	22 piezas	10 piezas

Observación: “ N ” =No

## TABLA DE PARÁMETROS

Modelo	Tamaño de instalación
1100061667	227*7,5*6cm
110006166 8	311*7,5*6cm
110006166 9	483*7,5*6cm
11000616 70	540*7,5*6cm
11000616 71	535*7,5*6cm

**Dirección:** Baoshanqu Shuangchenglu 803long 11hao 1602A-1609shi  
Shanghai

**Importado a AUS:** SIHAO PTY LTD . 1 ROKEVA STREET ASTWOOD  
NSW 2122 Australia

**Importado a EE. UU.:** Sanven Technology Ltd. Suite 250, 9166 Anaheim  
Place, Rancho Cucamonga, CA 91730



**SHUNSHUN GmbH**  
Römeräcker 9 Z2021,76351  
Linkenheim-Hochstetten, Germany  
euvertreter@gmail.com  
+49 1727041930



**Pooledas Group Ltd**  
Unit 5 Albert Edward House, The  
Pavilions Preston, United Kingdom  
pooledas123@gmail.com  
01772418127

**Hecho en china**



**VEVOR**<sup>®</sup>

**TOUGH TOOLS, HALF PRICE**

**Técnico Certificado de soporte y garantía electrónica**

**[www.vevor.com/support](http://www.vevor.com/support)**

# **VEVOR<sup>®</sup>**

**TOUGH TOOLS, HALF PRICE**

Techniczny Certyfikat wsparcia i e-gwarancji [www.vevor.com/support](http://www.vevor.com/support)

## **POKRYWA ZESTAWU MINI SPLIT LINE**

### **INSTRUKCJA OBSŁUGI**

We continue to be committed to provide you tools with competitive price.

"Save Half", "Half Price" or any other similar expressions used by us only represents an estimate of savings you might benefit from buying certain tools with us compared to the major top brands and does not necessarily mean to cover all categories of tools offered by us. You are kindly reminded to verify carefully when you are placing an order with us if you are actually saving half in comparison with the top major brands.

# VEVOR®

TOUGH TOOLS, HALF PRICE



## NEED HELP? CONTACT US!

Have product questions? Need technical support? Please feel free to contact us:

**Technical Support and E-Warranty Certificate**  
**[www.vevor.com/support](http://www.vevor.com/support)**

This is the original instruction, please read all manual instructions carefully before operating. VEVOR reserves a clear interpretation of our user manual. The appearance of the product shall be subject to the product you received. Please forgive us that we won't inform you again if there are any technology or software updates on our product.

## **OSTRZEŻENIE:**

1. Ten produkt nie jest zabawką. Nie pozwalaj dzieciom wspinać się na urządzenie.
2. Trzymaj dzieci i zwierzęta domowe z daleka podczas montażu.
3. Aby uniknąć niebezpieczeństwa uduszenia, plastikowe torby należy zawsze trzymać z dala od dzieci i zwierząt domowych.

## **ŚRODKI OSTROŻNOŚCI PRZY MONTAŻU**

1. Prosimy o złożenie produktu ściśle według instrukcji. Nieprawidłowy montaż może być niebezpieczny.
2. Podczas montażu należy nosić okulary ochronne i rękawice robocze.
3. Nie przystępuj do składania produktu będąc zmęczonym, pod wpływem alkoholu, narkotyków lub leków.
4. Nośność i inne parametry produktu odnoszą się wyłącznie do produktu prawidłowo i całkowicie zmontowanego.
5. Oddziel i policz wszystkie części i osprzęt.
6. Przygotuj następujące narzędzie: Śrubokręt Philips.
7. Jeśli korzystasz z elektronarzędzi, pamiętaj, aby zwolnić i zatrzymać się, jeśli zajdzie taka potrzeba.
8. Do montażu potrzebne są dwie osoby.
9. Postępuj zgodnie z przeznaczeniem. Nie siadaj ani nie stawaj na powyższym.

## **ZACHOWAJ TE INSTRUKCJE.**



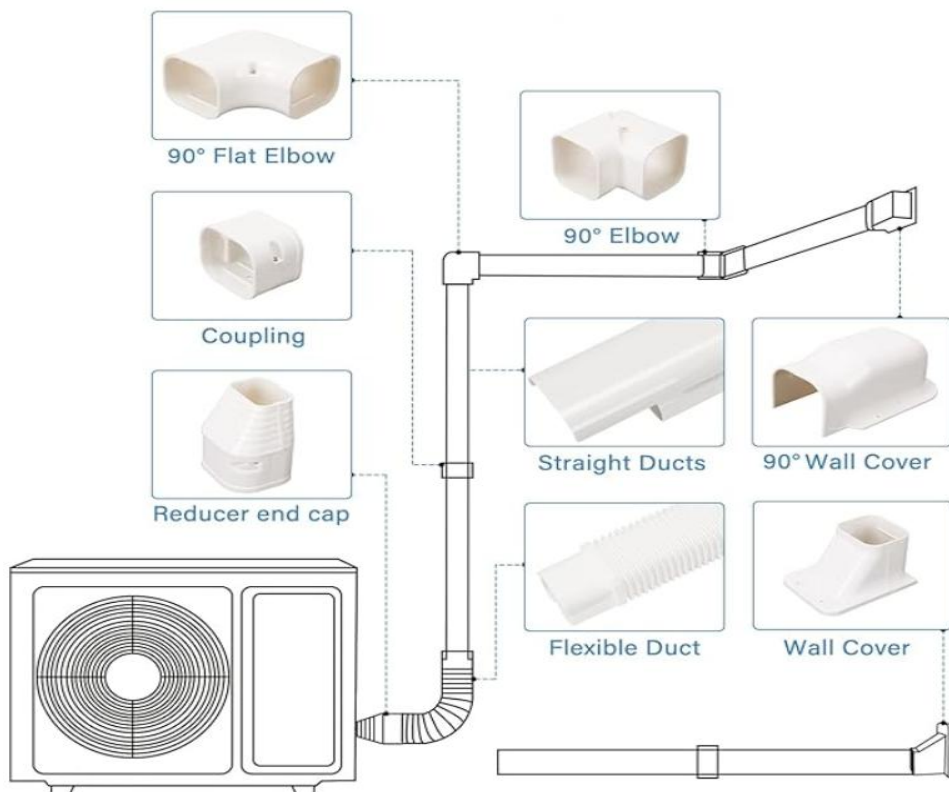





## INSTALACJA



## LISTA CZĘŚCI

NI	składni ki	Zdjęcie	Pasuje do modelu #				
			11000 61667	11000 61668	11000 61669	11000 61670	11000 61671
E							



1	Kanały proste		2 szt	5szt	4szt	10 sztuk	4szt
2	Elastyczny kanał		N	1 szt	1 szt	1 szt	2 szt
3	Sprężanie		1 szt	4szt	3 szt	9szt	3 szt
4	Zaślepka redukcyjna		1 szt	1 szt	1 szt	1 szt	1 szt
5	Kolanko płaskie 90°		N	1 szt	1 szt	1 szt	1 szt
6	Kolanko 90°		N	1 szt	1 szt	1 szt	1 szt
7	Ośłona ścienna 90°		1 szt	1 szt	1 szt	1 szt	1 szt
8	Ośłona ścienna		N	N	N	1 szt	1 szt

9	ST3,5* 16		8 szt	19szt	17szt	30szt	17szt
10	ST4*2 5		5szt	12szt	11szt	19szt	13 szt
11	Wstąż ka		5szt	12szt	10 sztuk	22szt	10 sztuk

Uwaga: „ N ” = Nie

## TABELA PARAMETRÓW

Model	Rozmiar instalacji
1100061667	227*7,5*6cm
110006166 8	311*7,5*6 cm
110006166 9	483*7,5*6 cm
11000616 70	540*7,5*6cm
11000616 71	535*7,5*6cm

**Adres:** Baoshanqu Shuangchenglu 803long 11hao 1602A-1609shi  
Szanghaj

**Import do AUS:** SIHAO PTY LTD . 1 ROKEVA STREETEASTWOOD  
NSW 2122 Australia

**Import do USA:** Sanven Technology Ltd. Suite 250, 9166 Anaheim Place,  
Rancho Cucamonga, CA 91730



**SHUNSHUN GmbH**  
Römeräcker 9 Z2021,76351  
Linkenheim-Hochstetten, Germany  
euvertreter@gmail.com  
+49 1727041930



**Pooledas Group Ltd**  
Unit 5 Albert Edward House, The  
Pavilions Preston, United Kingdom  
pooledas123@gmail.com  
01772418127

**Wyprodukowano w Chinach**



**VEVOR**<sup>®</sup>

**TOUGH TOOLS, HALF PRICE**

**Techniczny Certyfikat wsparcia i e-gwarancji**

**[www.vevor.com/support](http://www.vevor.com/support)**

# **VEVOR<sup>®</sup>**

**TOUGH TOOLS, HALF PRICE**

Technisch Ondersteuning en e-garantiecertificaat [www.vevor.com/support](http://www.vevor.com/support)

## **MINI SPLIT LINE SET COVER**

### **GEBRUIKSAANWIJZING**

We continue to be committed to provide you tools with competitive price.

"Save Half", "Half Price" or any other similar expressions used by us only represents an estimate of savings you might benefit from buying certain tools with us compared to the major top brands and does not necessarily mean to cover all categories of tools offered by us. You are kindly reminded to verify carefully when you are placing an order with us if you are actually saving half in comparison with the top major brands.

# VEVOR®

TOUGH TOOLS, HALF PRICE



## NEED HELP? CONTACT US!

Have product questions? Need technical support? Please feel free to contact us:

**Technical Support and E-Warranty Certificate**  
**[www.vevor.com/support](http://www.vevor.com/support)**

This is the original instruction, please read all manual instructions carefully before operating. VEVOR reserves a clear interpretation of our user manual. The appearance of the product shall be subject to the product you received. Please forgive us that we won't inform you again if there are any technology or software updates on our product.

## **WAARSCHUWING:**

1. Dit product is geen speelgoed. Laat kinderen niet op het apparaat klimmen.
2. Houd kinderen en huisdieren uit de buurt tijdens de montage.
3. Houd plastic zakken altijd uit de buurt van kinderen en huisdieren om verstikkingsgevaar te voorkomen.

## **MONTAGEVOORZORGSMATREGELEN**

1. Monteer het product strikt volgens de instructies. Een onjuiste montage kan gevaarlijk zijn.
2. Draag tijdens de montage een veiligheidsbril en werkhandschoenen.
3. Probeer het product niet in elkaar te zetten als u zich moe voelt of onder invloed bent van alcohol, drugs of medicijnen.
4. Draagvermogen en andere productparameters gelden alleen voor het correct en volledig gemonteerde product.
5. Scheid en tel alle onderdelen en hardware.
6. Houd het volgende gereedschap gereed: kruiskopschroevendraaier.
7. Als u elektrisch gereedschap gebruikt, zorg er dan voor dat u langzamer gaat rijden en stopt wanneer dat nodig is.
8. Voor de montage zijn twee personen nodig.
9. Volg uitsluitend het beoogde gebruik. Ga niet op het bovenstaande zitten of staan.

## **BEWAAR DEZE INSTRUCTIES.**





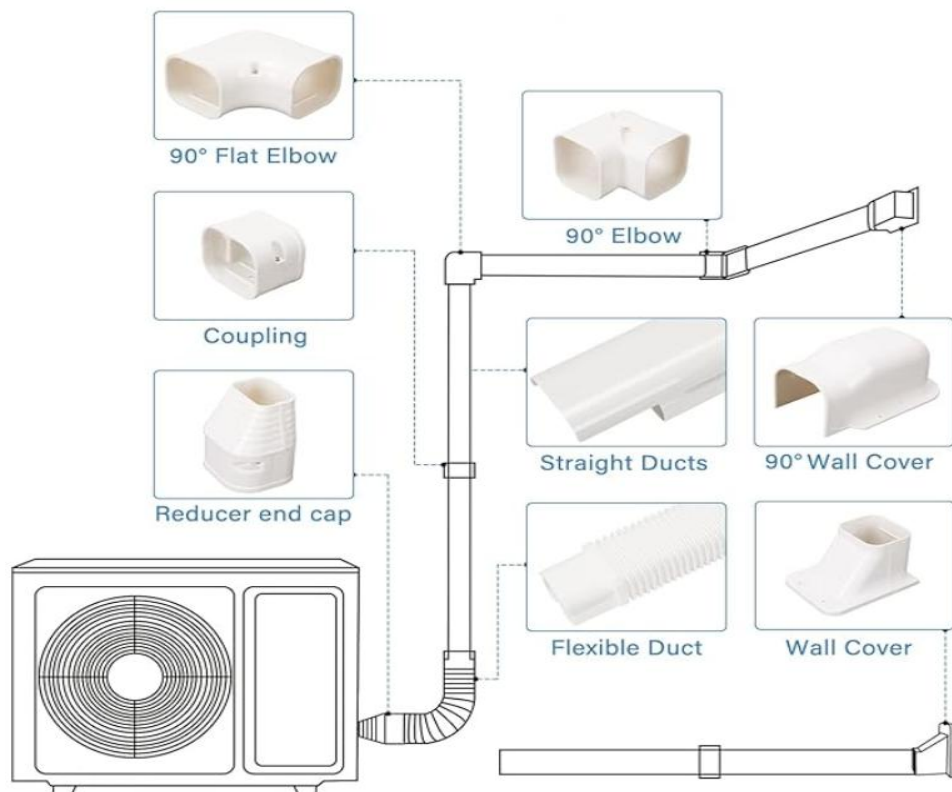







# INSTALLATIE



# ONDERDELEN LIJST

N e	Comp onente n	Afbeelding	Past op model #				
			11000 61667	11000 61668	11000 61669	11000 61670	11000 61671

1	Rechte kanalen		2 stuks	5 stuks	4 stuks	10 stuks	4 stuks
2	Flexibel kanaal		N	1 stuk	1 stuk	1 stuk	2 stuks
3	Koppelen		1 stuk	4 stuks	3 stuks	9 stuks	3 stuks
4	Verlooptstuk eindkap		1 stuk	1 stuk	1 stuk	1 stuk	1 stuk
5	90° platte elleboog		N	1 stuk	1 stuk	1 stuk	1 stuk
6	90° elleboog		N	1 stuk	1 stuk	1 stuk	1 stuk
7	90° wandafdekking		1 stuk	1 stuk	1 stuk	1 stuk	1 stuk
8	Wandbekleding		N	N	N	1 stuk	1 stuk
9	ST3,5*16		8 stuks	19 stuks	17 stuks	30 stuks	17 stuks

10	ST4*2 5		5 stuks	12 stuks	11 stuks	19 stuks	13 stuks
11	Lintje		5 stuks	12 stuks	10 stuks	22 stuks	10 stuks

Opmerking: " N " =Nee

## PARAMETERTABEL

Model	Installatiegrootte
1100061667	227*7.5*6cm
110006166 8	311*7.5*6cm
110006166 9	483*7.5*6cm
11000616 70	540*7.5*6cm
11000616 71	535*7.5*6cm

**Adres:** Baoshanqu Shuangchenglu 803long 11hao 1602A-1609shi  
Shanghai

**Geïmporteerd naar AUS:** SIHAO PTY LTD . 1 ROKEVA  
STREETEASTWOOD NSW 2122 Australië

**Geïmporteerd naar de VS:** Sanven Technology Ltd. Suite 250, 9166  
Anaheim Place, Rancho Cucamonga, CA 91730



**SHUNSHUN GmbH**  
Römeräcker 9 Z2021,76351  
Linkenheim-Hochstetten, Germany  
euvertreter@gmail.com  
+49 1727041930



**Pooledas Group Ltd**  
Unit 5 Albert Edward House, The  
Pavilions Preston, United Kingdom  
pooledas123@gmail.com  
01772418127

**Gemaakt in China**



**VEVOR**<sup>®</sup>

**TOUGH TOOLS, HALF PRICE**

**Technisch Ondersteuning en e-garantiecertificaat**

**[www.vevor.com/support](http://www.vevor.com/support)**

# **VEVOR<sup>®</sup>**

**TOUGH TOOLS, HALF PRICE**

Teknisk Support och e-garanticertifikat [www.vevor.com/support](http://www.vevor.com/support)

## **MINI SPLIT LINE SET SKYDD**

### **BRUKSANVISNINGAR**

We continue to be committed to provide you tools with competitive price.

"Save Half", "Half Price" or any other similar expressions used by us only represents an estimate of savings you might benefit from buying certain tools with us compared to the major top brands and does not necessarily mean to cover all categories of tools offered by us. You are kindly reminded to verify carefully when you are placing an order with us if you are actually saving half in comparison with the top major brands.

# VEVOR®

TOUGH TOOLS, HALF PRICE



## NEED HELP? CONTACT US!

Have product questions? Need technical support? Please feel free to contact us:

**Technical Support and E-Warranty Certificate**  
**[www.vevor.com/support](http://www.vevor.com/support)**

This is the original instruction, please read all manual instructions carefully before operating. VEVOR reserves a clear interpretation of our user manual. The appearance of the product shall be subject to the product you received. Please forgive us that we won't inform you again if there are any technology or software updates on our product.



## **VARNING:**

1. Denna produkt är inte en leksak, låt inte barn klättra på enheten.
2. Håll barn och husdjur borta under monteringen.
3. För att undvika risken för kvävning, förvara alltid plastpåsar borta från barn och husdjur.

## **FÖRSIKTIGHETSÅTGÄRDER FÖR MONTERING**

1. Vänligen montera produkten i strikt enlighet med instruktionerna. Felaktig montering kan vara farligt.
2. Använd skyddsglasögon och arbetshandskar ordentligt under monteringen.
3. Försök inte att sätta ihop produkten när du känner dig trött eller är påverkad av alkohol, droger eller medicin.
4. Bärförmåga och andra produktparametrar tillämpas endast på den korrekt och färdigmonterade produkten.
5. Separera och räkna alla delar och hårdvara.
6. Förbered följande verktyg: Philips huvudskruvmejsel.
7. Om du använder elverktyg, var noga med att sakta ner och stanna vid behov.
8. Två personer krävs för montering.
9. Följ endast avsedd användning. Sitt eller stå inte på ovanstående.





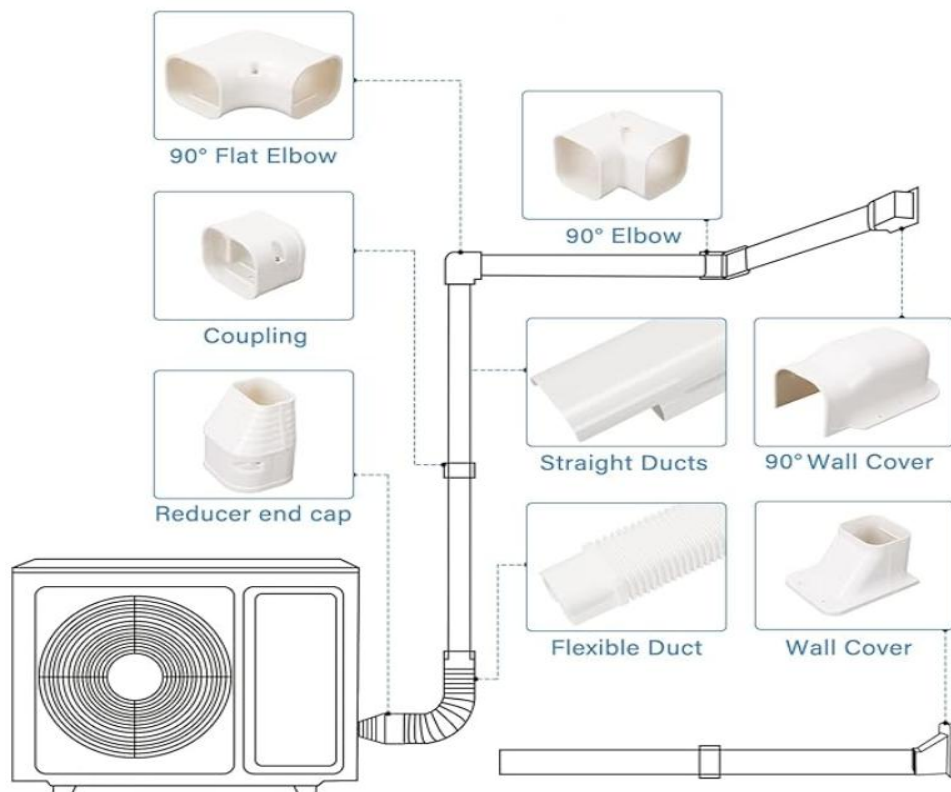



## **SPARA DESSA INSTRUKTIONER.**

# INSTALLATION



# DELLISTA

Nej	Komponenter	Bild	Passar modell#				
			11000 61667	11000 61668	11000 61669	11000 61670	11000 61671

1	Raka kanaler		2 st	5 st	4 st	10 st	4 st
2	Flexibel kanal		N	1 st	1 st	1 st	2 st
3	Koppling		1 st	4 st	3 st	9 st	3 st
4	Reducer gavel		1 st	1 st	1 st	1 st	1 st
5	90° platt armbåge		N	1 st	1 st	1 st	1 st
6	90° armbåge		N	1 st	1 st	1 st	1 st
7	90° Vägghåpa		1 st	1 st	1 st	1 st	1 st
8	Vägghåpa		N	N	N	1 st	1 st
9	ST3,5* 16		8 st	19 st	17 st	30 st	17 st

10	ST4*2 5		5 st	12 st	11 st	19 st	13 st
11	Band		5 st	12 st	10 st	22 st	10 st

Anmärkning: “ N ” =Nej

## PARAMETERTABELL

Modell	Installationsstorlek
1100061667	227*7,5*6cm
110006166 8	311*7,5*6cm
110006166 9	483*7,5*6cm
11000616 70	540*7,5*6cm
11000616 71	535*7,5*6cm

**Adress:** Baoshanqu Shuangchenglu 803long 11hao 1602A-1609shi  
Shanghai

**Importerad till AUS:** SIHAO PTY LTD . 1 ROKEVA STREETEASTWOOD  
NSW 2122 Australien

**Importerad till USA:** Sanven Technology Ltd. Suite 250, 9166 Anaheim  
Place, Rancho Cucamonga, CA 91730



**SHUNSHUN GmbH**  
Römeräcker 9 Z2021,76351  
Linkenheim-Hochstetten, Germany  
euvertreter@gmail.com  
+49 1727041930



**Pooledas Group Ltd**  
Unit 5 Albert Edward House, The  
Pavilions Preston, United Kingdom  
pooledas123@gmail.com  
01772418127

**Tillverkad i Kina**



**VEVOR**<sup>®</sup>

**TOUGH TOOLS, HALF PRICE**

**Teknisk Support och e-garanticertifikat**

**[www.vevor.com/support](http://www.vevor.com/support)**