

VEVOR[®]

TOUGH TOOLS, HALF PRICE

Technical Support and E-Warranty Certificate www.vevor.com/support

STANDING DESK FRAME

OPERATING INSTRUCTIONS

We continue to be committed to provide you tools with competitive price.

"Save Half", "Half Price" or any other similar expressions used by us only represents an estimate of savings you might benefit from buying certain tools with us compared to the major top brands and does not necessarily mean to cover all categories of tools offered by us. You are kindly reminded to verify carefully when you are placing an order with us if you are actually saving half in comparison with the top major brands.

VEVOR®

TOUGH TOOLS, HALF PRICE

STANDING DESK FRAME

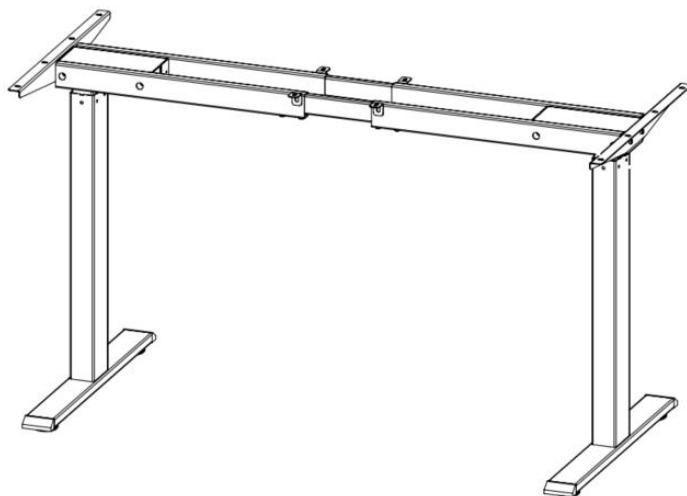

NEED HELP? CONTACT US!

Have product questions? Need technical support? Please feel free to contact us:

Technical Support and E-Warranty Certificate
www.vevor.com/support

This is the original instruction, please read all manual instructions carefully before operating. VEVOR reserves a clear interpretation of our user manual. The appearance of the product shall be subject to the product you received. Please forgive us that we won't inform you again if there are any technology or software updates on our product.

Parts List



A x 2



B x 2



C x 2



D x 2



E x 2



F x 2



G x 1



H x 1



J x 1



M6*35

M x 8



M6*13

N x 20

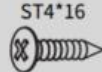

ST4*16

O x 2



P x 2

INSTALLATION

1 Beam installation-Step1

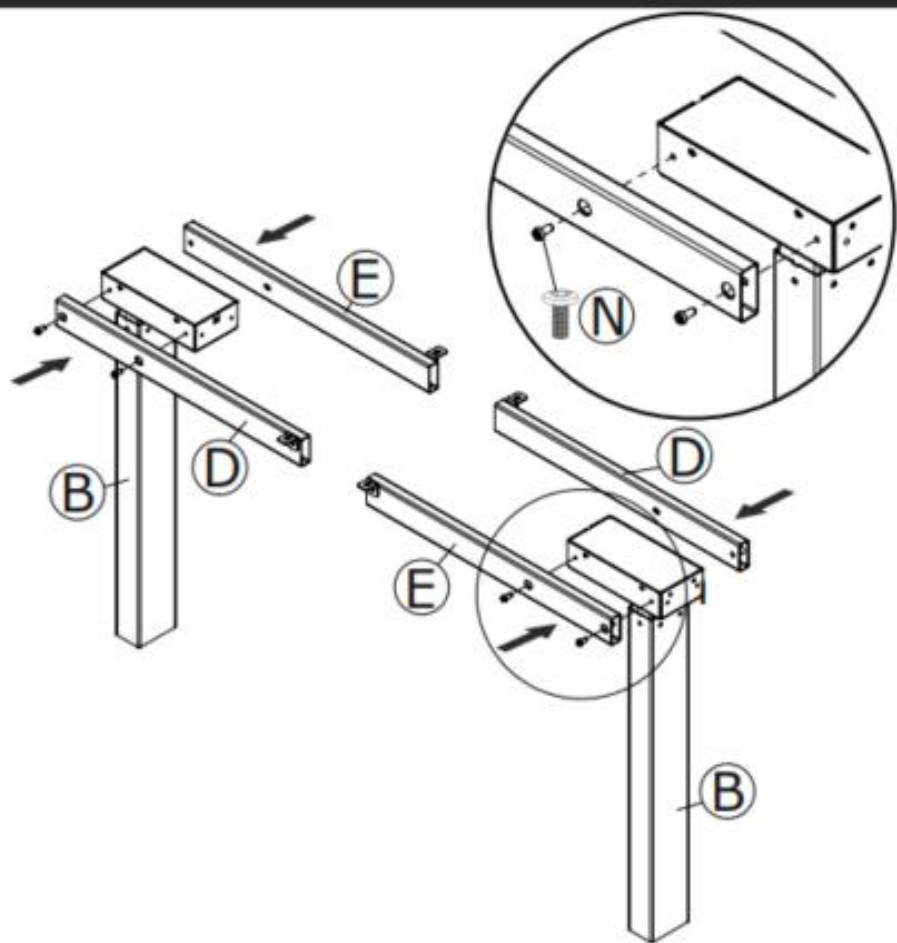

D x 2
E x 2
B x 2

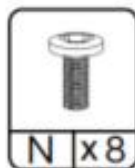

2 Beam installation-Step2

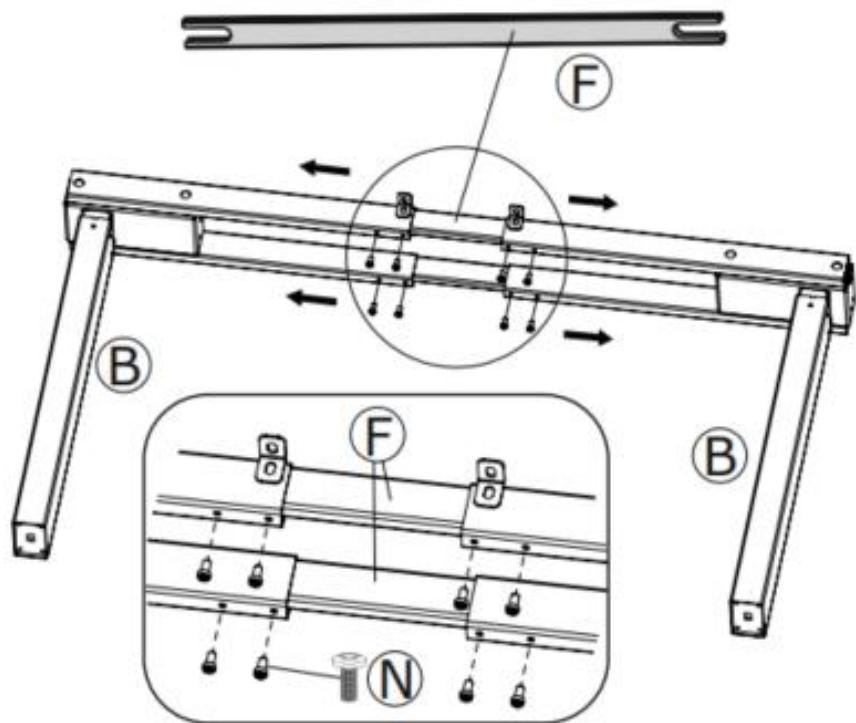

F x 2



3 Foot installation

When the ground is uneven, the foot pad can be rotated to achieve balance.

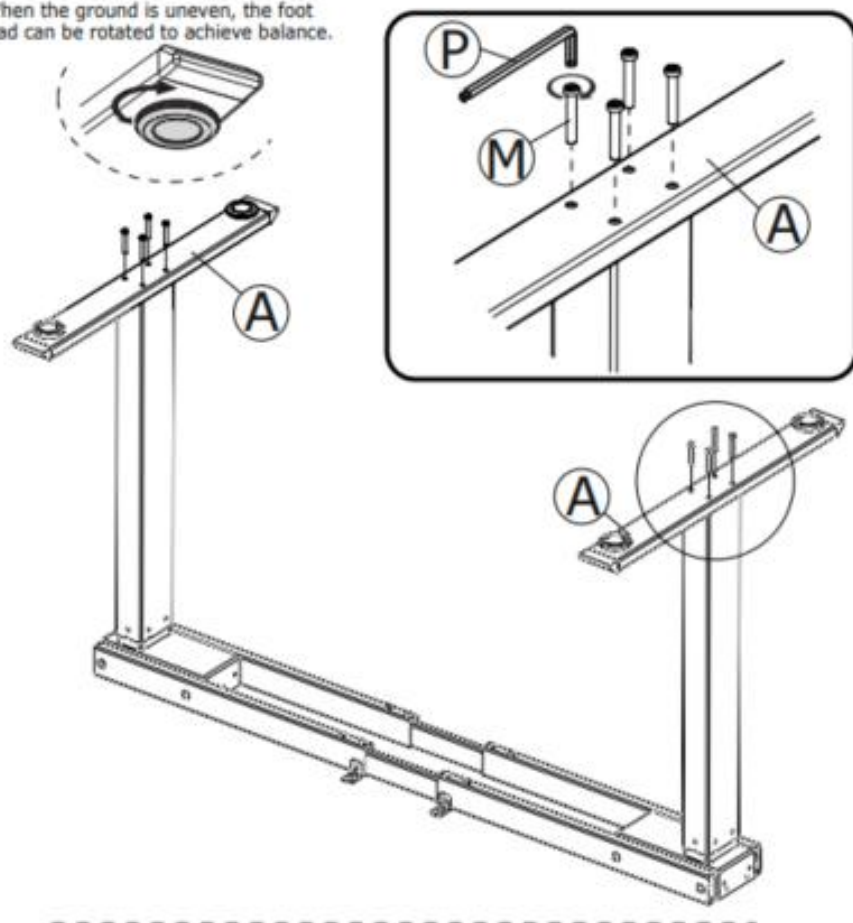

A x 2



4 Side wing installation

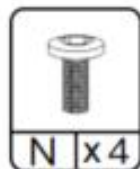
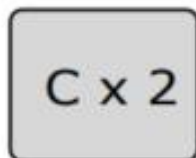
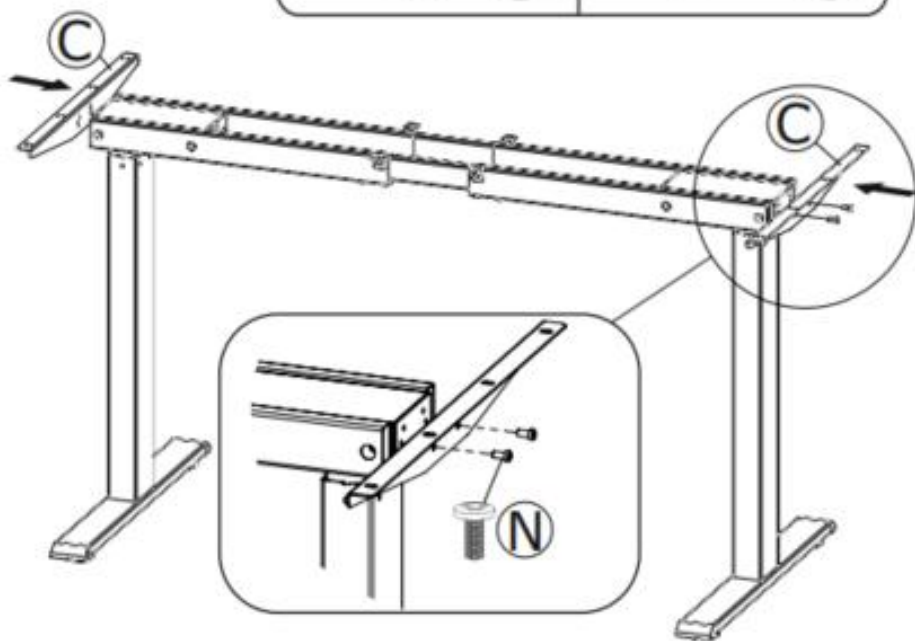
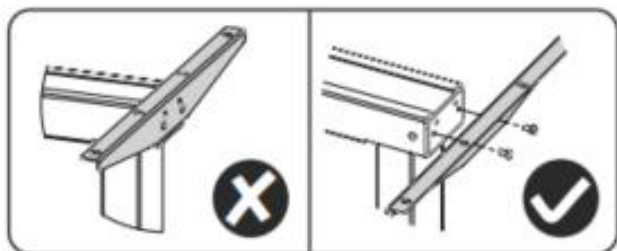

5 Line connection

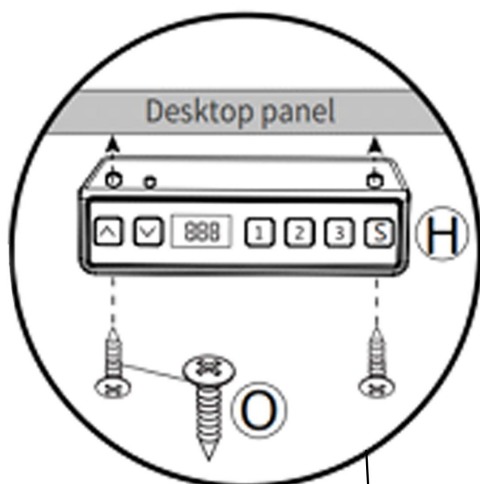

The controller can be fixed to the tabletop

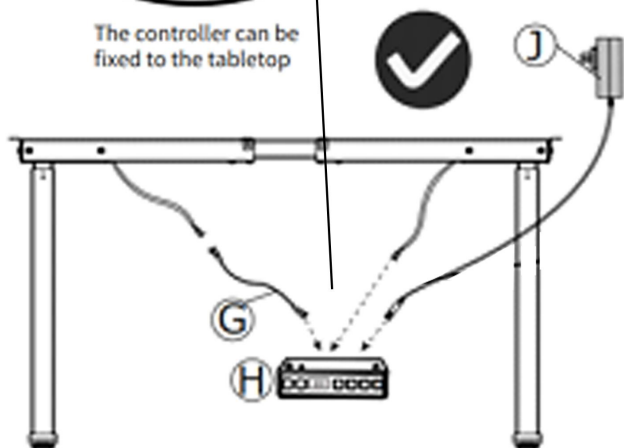







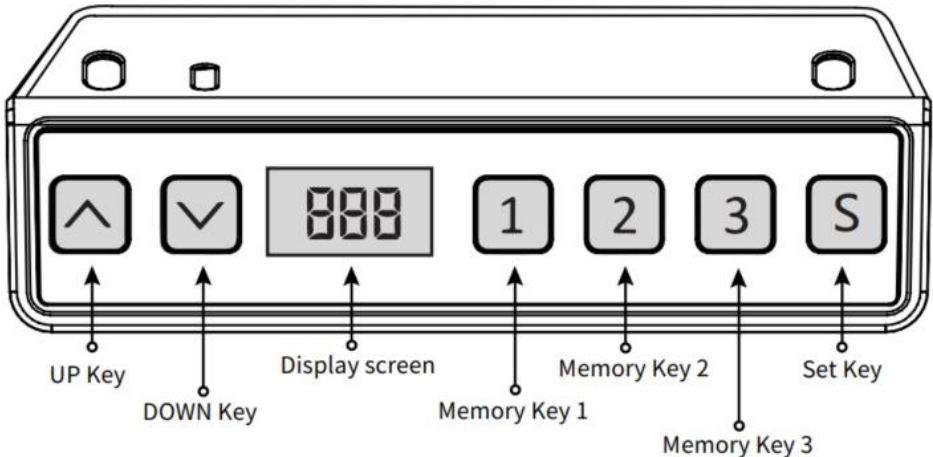

H x 1
J x 1
G x 1





OPERATING INSTRUCTIONS

Note: Before using the height-adjustable desk, it's recommended to perform a reset to ensure that both lift columns are at the same height, as they may have slight variations from the factory (see OPERATING INSTRUCTIONS–Reset).



-  UP Key ---- Press and hold the " ^ " button to raise the desk.
 -  DOWN Key ---- Press and hold the " v " button to lower the desk.
 -  Display screen ---- Press any button to wake up the LED display.
 -  Memory Key 1 ----
 -  Memory Key 2 ----
 -  Memory Key 3 ----
 -  Set Key
- The desk can store 3 memory heights (memory 1, 2, and 3).

Reset

Long press the "" key, after running the desktop to the lowest point, keep holding the "" key until the screen

flashes " --- " and the buzzer makes a "beep" sound, the screen displays the lowest height value, and the reset operation is successful.



Lift function operation

When the "" key is pressed, the desktop runs upwards until it reaches the highest point of the desktop.

When the "" key is pressed, the desktop runs down until it reaches the lowest point of the desktop.

Memory Position Storage/Memory Location Run

1.Location storage



Press and hold the memory button "", the buzzer will make a "beep" sound, and the screen will flash "S-1" at the same time, and the current altitude value will be displayed, and the memory storage will be saved successfully. A total of 3 heights can be recorded at the same time (press and hold the memory button "", the screen flashes "S-2", press and hold the memory  key " ", the screen flashes "S-3").



Note: If you set the memory location on the same number key again and save it successfully, the record storage that was previously set by the key will be overwritten.

2.Memory position operation

Short press the "" button, the display flashes the memory position height 2seconds, the desktop automatically runs to the height of the memory position, and any key can stop running during operation.

3.Lock and unlock

Lock: Press and hold "" + "" + "" at the same time for 5 seconds, when the display shows " L ", it means that the system has been locked and cannot lift the system.

Unlock: Press and hold "" + "" + "" at the same time for 5 seconds, when the digital tube is displayed from "L" to the normal digital display, it means that the system has been unlocked.

4.Sedentary reminder (countdown method)

Countdown time: 3 stops, "r30" = 30 minutes, "r45" = 45 minutes, "r60" = 60 minutes.

Countdown start: Press "S" screen to display "r30 / r45 / r60" in turn, and the countdown will start.

Exit Countdown:

1. Short press the "S" button, the display will display the number, and exit the countdown.
2. When the countdown time is up, the display will flash "cHr", the flashing time is 1 minute, press any button to stop the timer and exit.
3. After the countdown time is up, if there is no operation, it will automatically exit the timer after reminding 3 times continuously every 5 minutes.

Restore factory settings

Method: Press and hold the "▲" + "▼" + "3" buttons at the same time for 5 seconds, and the screen displays "clr", which means that the parameter is successfully restored.

Metric Imperial switching

Metric (CM unit): Long press "▲" + "3", after the buzzer "tick", the screen display will switch to the metric CM unit Imperial (inch as unit): Long press "▼" + "3", after the buzzer "tick", the screen display will switch to imperial inch units.

Error description

Error codes	Description	Resolution
E01	The motor is not connected	Press the up or down button again, if it still persists, please check the column motor connection cable
E02	Motor overcurrent	Press the up or down button again, it still persists, please replace the motor or reduce the load
E03	Motor Hall failure	Press the up or down button again, it still persists, please check the connection or replace the motor
E04	The mains power supply is abnormal	If the cable cannot be eliminated after power failure and reconnection, replace the power supply
E05	The motor current is abnormal	Reconnect the cable after power failure, if it still can't be removed, you need to return it to the factory
E06	The motor power device is bad	Reconnect the cable after power failure, if it still can't be removed, you need to return it to the factory
E09	Motor stalled	Press the up or down button again, it still persists, please replace the motor or reduce the load
H0f	Over-temperature protection	Wait for the temperature to drop, run for 2 minutes, and stop for 18 minutes
r5f	Illegal power outages	Reduce the load or check if the power cable is loose

Parameter table

Model	Height lifting range (cm)	Motor	Table leg level	Length extension range (cm)	Size (cm)	Table board length (Suggested size)
ZW-13 ZW-14 ZW-15 ZW-16	70-117	2pcs	two-stage	110-178	110*58*70	L:120-220cm W:62-80cm
ZW-17 ZW-18 ZW-19 ZW-20	64-129	2pcs	three-stage	110-178	110*58*64	L:120-220cm W:62-80cm

Address: Baoshanqu Shuangchenglu 803long 11hao 1602A-1609shi
Shanghai

Imported to AUS: SIHAO PTY LTD. 1 ROKEVA STREETEASTWOOD
NSW 2122 Australia

Imported to USA: Sanven Technology Ltd. Suite 250, 9166 Anaheim
Place, Rancho Cucamonga, CA 91730



SHUNSHUN GmbH
Römeräcker 9 Z2021,76351
Linkenheim-Hochstetten,Germany



Pooledas Group Ltd
Unit 5 Albert Edward House, The Pavilions
Preston, United Kingdom

Made In China

VEVOR[®]

TOUGH TOOLS, HALF PRICE

Technical Support and E-Warranty Certificate

www.vevor.com/support

VEVOR[®]

TOUGH TOOLS, HALF PRICE

Technique Assistance et certificat de garantie électronique

www.vevor.com/support

STRUCTURE DE BUREAU DEBOUT

MODE D'EMPLOI

We continue to be committed to provide you tools with competitive price.

"Save Half", "Half Price" or any other similar expressions used by us only represents an estimate of savings you might benefit from buying certain tools with us compared to the major top brands and does not necessarily mean to cover all categories of tools offered by us. You are kindly reminded to verify carefully when you are placing an order with us if you are actually saving half in comparison with the top major brands.

VEVOR[®]

TOUGH TOOLS, HALF PRICE

STANDING DESK FRAME

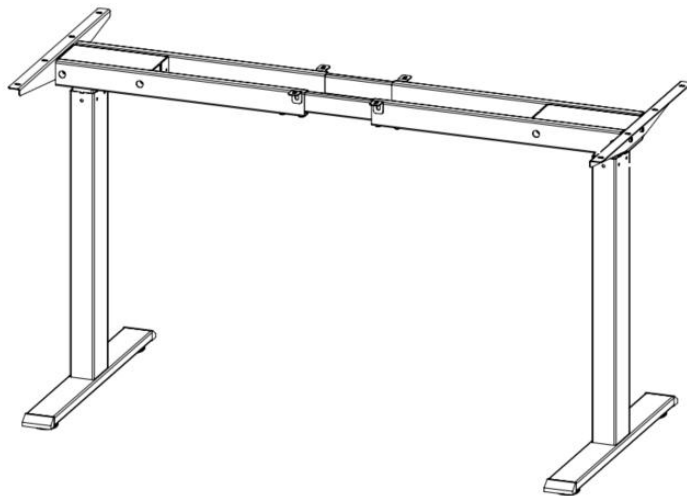

NEED HELP? CONTACT US!

Have product questions? Need technical support? Please feel free to contact us:

Technical Support and E-Warranty Certificate
www.vevor.com/support

This is the original instruction, please read all manual instructions carefully before operating. VEVOR reserves a clear interpretation of our user manual. The appearance of the product shall be subject to the product you received. Please forgive us that we won't inform you again if there are any technology or software updates on our product.

Liste des pieces



A x 2

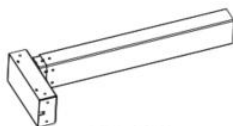

B x 2



C x 2



D x 2



E x 2



F x 2



G x 1



H x 1



J x 1



M x 8



N x 20

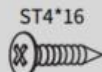

O x 2



P x 2

INSTALLATION

1 Beam installation-Step1

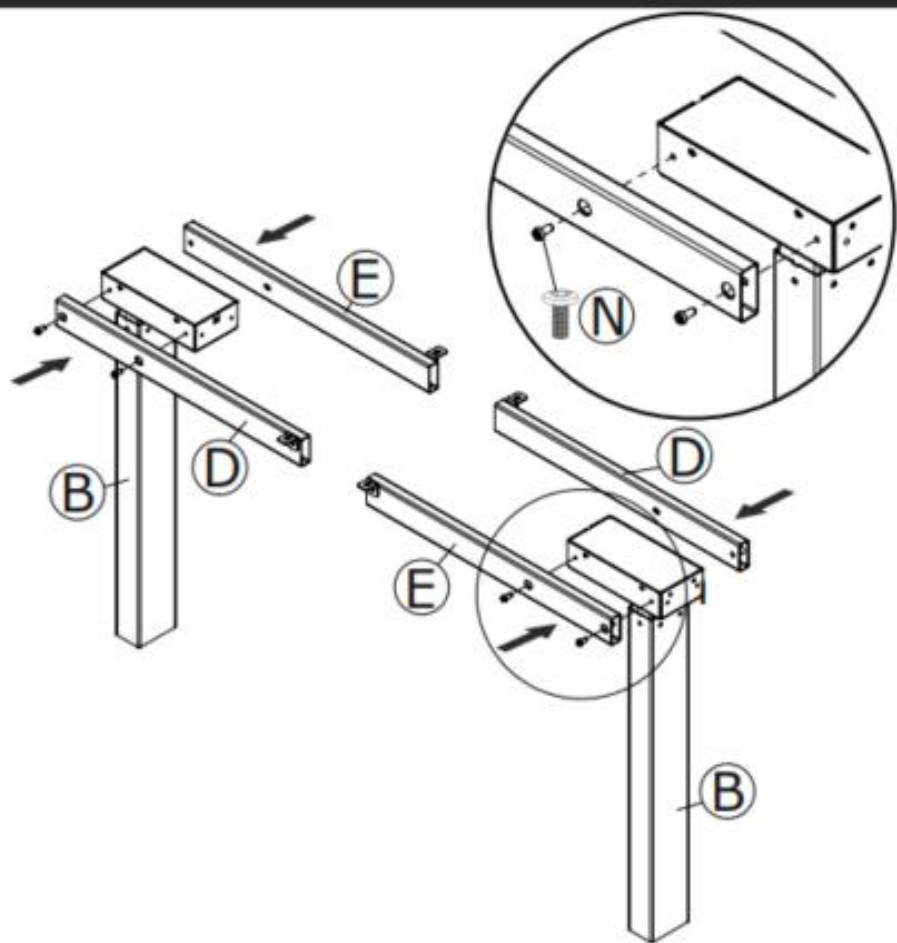

D x 2
E x 2
B x 2

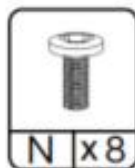

2 Beam installation-Step2

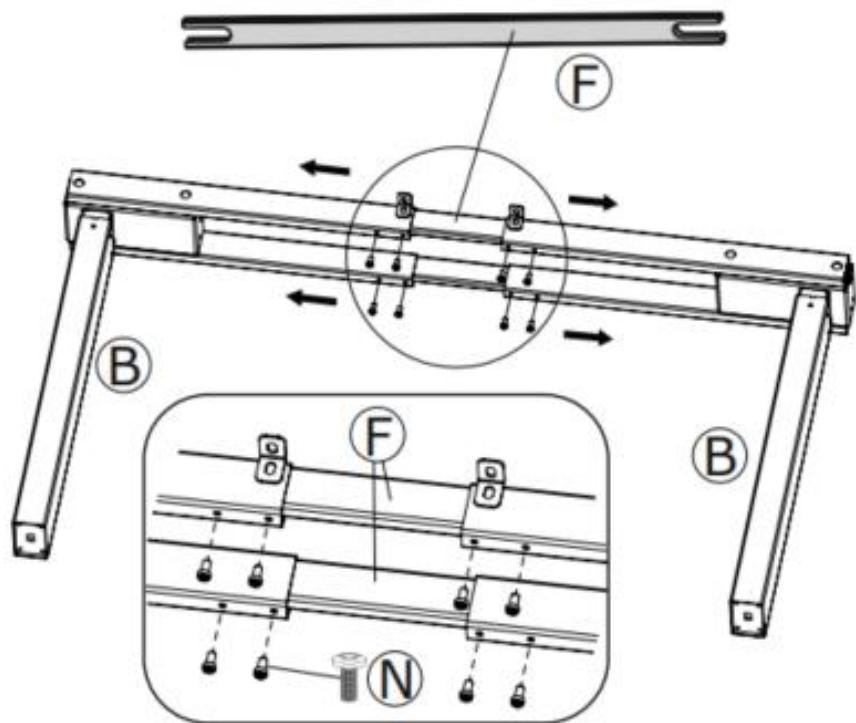

F x 2



3 Foot installation

When the ground is uneven, the foot pad can be rotated to achieve balance.

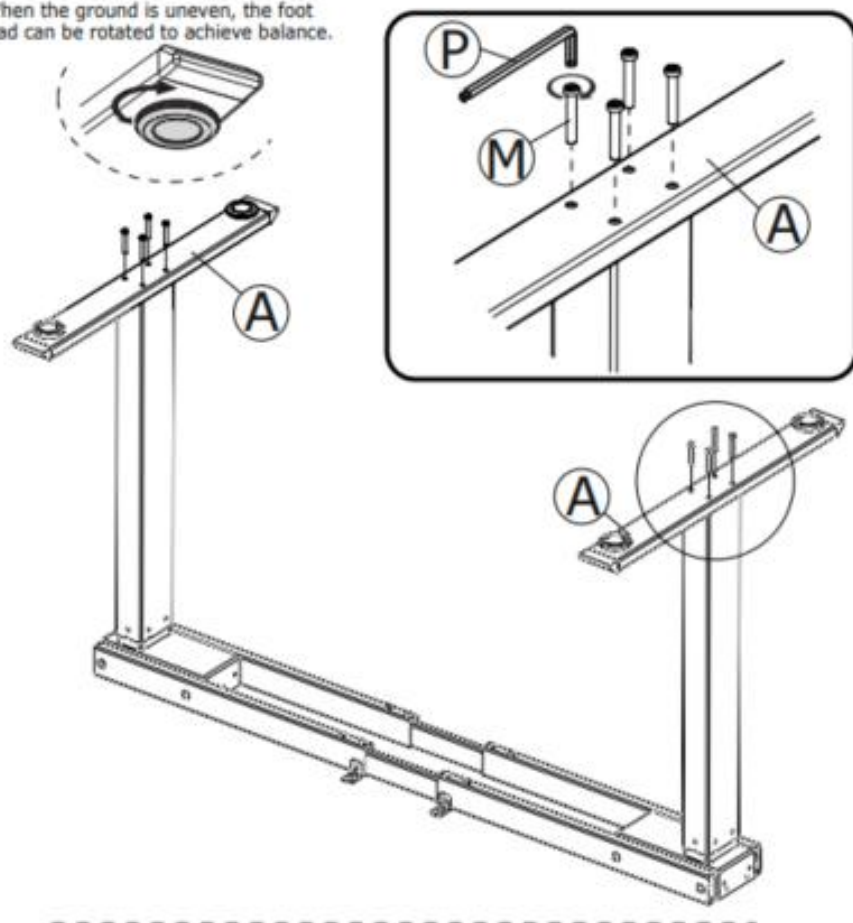

A x 2



4 Side wing installation

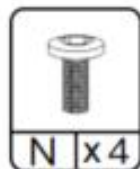
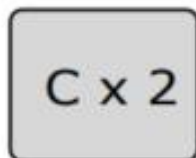
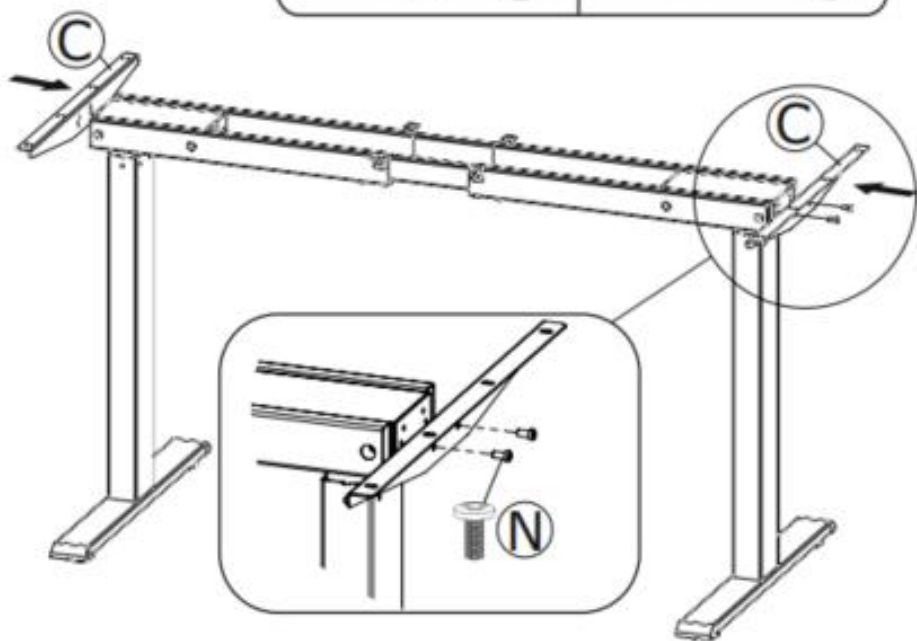
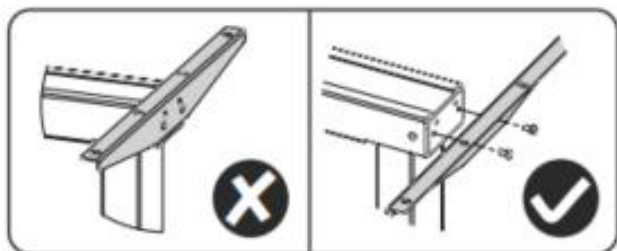

5 Line connection

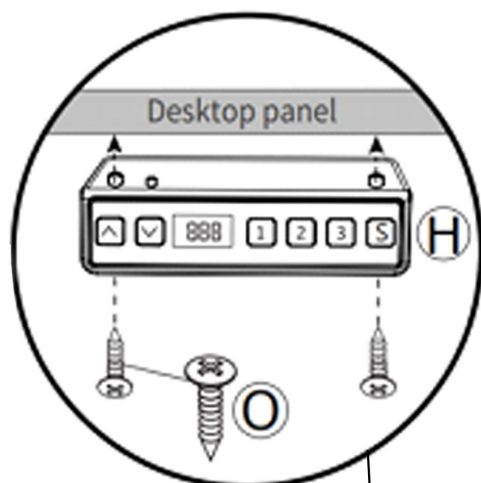

The controller can be fixed to the tabletop

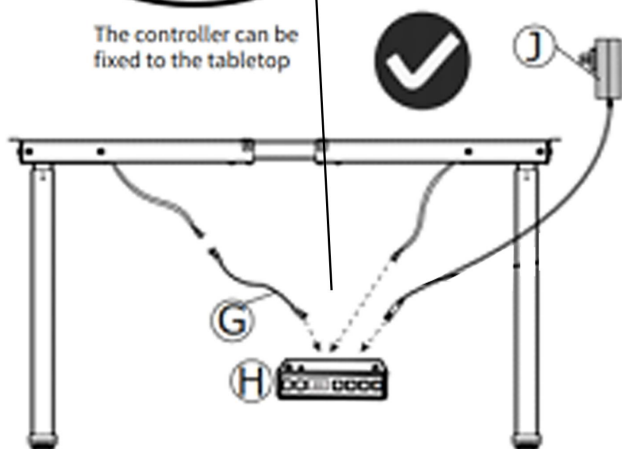







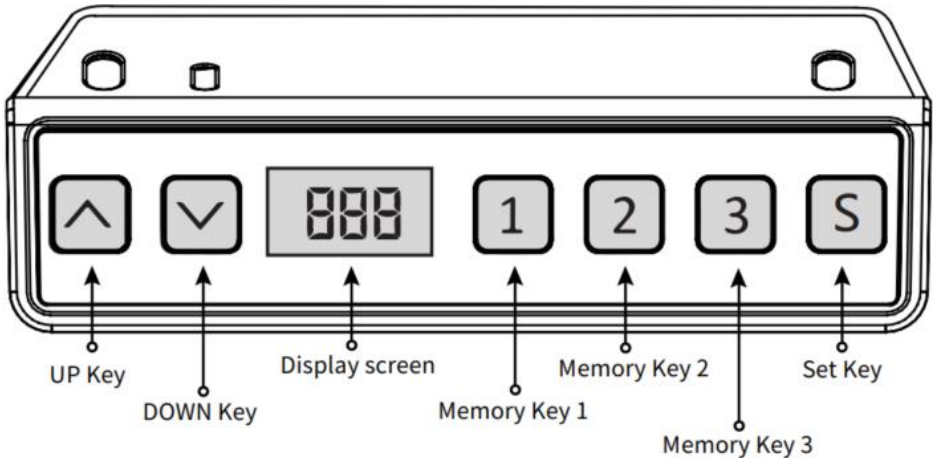

H x 1
J x 1
G x 1





MODE D'EMPLOI

Remarque : Avant d'utiliser le bureau réglable en hauteur, il est recommandé d'effectuer une réinitialisation pour s'assurer que les deux colonnes de levage sont à la même hauteur, car elles peuvent avoir un léger variations de l'usine (voir INSTRUCTIONS D'UTILISATION – Réinitialisation).



-  UP Key ---- Press and hold the "^" button to raise the desk.
 -  DOWN Key ---- Press and hold the "v" button to lower the desk.
 -  Display screen ---- Press any button to wake up the LED display.
 -  Memory Key 1 ----
 -  Memory Key 2 ----
 -  Memory Key 3 ----
 -  Set Key
- The desk can store 3 memory heights (memory 1, 2, and 3).

Réinitialiser

Appuyez longuement sur la  touche "v", après avoir exécuté le bureau jusqu'au point le plus bas, maintenez la  touche "v" jusqu'à ce que l'écran

clignote « --- » et le buzzer émet un « bip », l'écran affiche la valeur de hauteur la plus basse et l'opération de réinitialisation est réussie.

Fonctionnement de la fonction de levage



Lorsque la  touche " " est enfoncée, le bureau monte vers le haut jusqu'à atteindre le point le plus élevé du bureau.

Lorsque la  touche " " est enfoncée, le bureau s'exécute jusqu'à ce qu'il atteigne le point le plus bas du bureau.

Stockage de la position mémoire/exécution de l'emplacement mémoire



1. Stockage de localisation

Appuyez et maintenez enfoncé le bouton mémoire "  ", le buzzer émettra un "bip" et l'écran fera clignoter "S-1" à la fin.



en même temps, la valeur d'altitude actuelle sera affichée et le stockage en mémoire sera enregistré avec succès. Un total de 3 hauteurs peuvent être enregistrées en même temps (appuyez et maintenez le bouton mémoire "  ", l'écran clignote "S-2", appuyez et maintenez maintenez la touche  mémoire " ", l'écran clignote "S-3").

Remarque : Si vous définissez à nouveau l'emplacement mémoire sur la même touche numérique et que vous l'enregistrez avec succès, le stockage d'enregistrement qui a été précédemment défini par la touche sera écrasé.



2. Fonctionnement de la position mémoire

Appuyez brièvement sur le bouton «  /  /  », l'écran fait clignoter la hauteur de la position mémoire pendant 2 secondes, le bureau fonctionne automatiquement à la hauteur de la position mémoire et n'importe quelle touche peut cesser de fonctionner pendant le fonctionnement.



3. Verrouiller et déverrouiller





Verrouillage : Appuyez et maintenez "  " + "  " + "  " en même temps pendant 5 secondes, lorsque l'écran affiche " L ", cela signifie que le

système a été verrouillé et ne peut pas soulever le système.



Déverrouiller : appuyez et maintenez "  " + "  " + "  " en même temps pendant 5 secondes, lorsque le tube numérique s'affiche de " L " à l'affichage numérique normal, cela signifie que le système a été déverrouillé.

4. Rappel sédentaire (méthode de compte à rebours)





Temps de compte à rebours : 3 arrêts, "  " = 30 minutes, "  " = 45 minutes, "  " = 60 minutes.

Démarrage du compte à rebours : appuyez sur  l'écran " " pour afficher "  /  /  " tour à tour et le compte à rebours commencera.



Compte à rebours de sortie :



1. Appuyez brièvement sur le  bouton « », l'écran affichera le numéro et quittera le compte à rebours.
2. Lorsque le compte à rebours est écoulé, l'écran clignote "  ", le temps de clignotement est de 1 minute, appuyez sur n'importe quel bouton pour arrêter le minuteur et sortie.
3. Une fois le compte à rebours écoulé, s'il n'y a aucune opération, il quittera automatiquement la minuterie après avoir rappelé 3 fois en continu toutes les 5 minutes.

Rétablir les paramètres d'usine

Méthode : appuyez et maintenez enfoncés les boutons "  " + "  " + "  " en même temps pendant 5 secondes, et l'écran affiche "  ", ce qui signifie que le paramètre est restauré avec succès .

Commutation métrique impériale

Métrique (unité CM) : appuyez longuement sur "  " + "  ", après le "tic" du buzzer, l'affichage de l'écran passera à l'unité métrique CM Impérial

(pouces en unité) : appuyez longuement sur "  " + "  ", après le "tic" du buzzer, l'affichage de l'écran passera aux unités en pouces impériaux .

Erreur de description

Error codes	Description	Resolution
E01	The motor is not connected	Press the up or down button again, if it still persists, please check the column motor connection cable
E02	Motor overcurrent	Press the up or down button again, it still persists, please replace the motor or reduce the load
E03	Motor Hall failure	Press the up or down button again, it still persists, please check the connection or replace the motor
E04	The mains power supply is abnormal	If the cable cannot be eliminated after power failure and reconnection, replace the power supply
E05	The motor current is abnormal	Reconnect the cable after power failure, if it still can't be removed, you need to return it to the factory
E06	The motor power device is bad	Reconnect the cable after power failure, if it still can't be removed, you need to return it to the factory
E09	Motor stalled	Press the up or down button again, it still persists, please replace the motor or reduce the load
H0f	Over-temperature protection	Wait for the temperature to drop, run for 2 minutes, and stop for 18 minutes
r5f	Illegal power outages	Reduce the load or check if the power cable is loose

Tableau des paramètres

Modèle	Plage de lavage en hauteur (cm)	Moteur	Niveau des pieds de table	Plage d'extension de longueur (cm)	Taille (cm)	Longueur du plateau de table (Taille suggérée)

ZW-13 ZW-14 ZW-15 ZW-16	70-117	2 pièce s	en deux étapes	110-178	110*5 8*70	L:120-220 cm L:62-80 cm
ZW-17 ZW-18 ZW-19 ZW-20	64-129	2 pièce s	en trois étapes	110-178	110*5 8*64	L:120-220 cm L:62-80 cm

Adresse : Baoshanqu Shuangchenglu 803long 11hao 1602A-1609shi
Shanghai

Importé en Australie : SIHAO PTY LTD . 1 ROKEVA STREETASTWOOD
NSW 2122 Australie

Importé aux États-Unis : Sanven Technology Ltd. Suite 250, 9166
Anaheim Place, Rancho Cucamonga, CA 91730

EC	REP	SHUNSHUN GmbH Römeräcker 9 Z2021,76351 Linkenheim-Hochstetten,Germany
-----------	------------	---

UK	REP	Pooledas Group Ltd Unit 5 Albert Edward House, The Pavilions Preston, United Kingdom
-----------	------------	--

Fabriqué en Chine

VEVOR[®]

TOUGH TOOLS, HALF PRICE

Technique Assistance et certificat de garantie électronique

www.vevor.com/support

VEVOR[®]

TOUGH TOOLS, HALF PRICE

Technisch Support- und E-Garantie-Zertifikat www.vevor.com/support

STHEPULTGESTELL

BEDIENUNGSANLEITUNG

We continue to be committed to provide you tools with competitive price.

"Save Half", "Half Price" or any other similar expressions used by us only represents an estimate of savings you might benefit from buying certain tools with us compared to the major top brands and does not necessarily mean to cover all categories of tools offered by us. You are kindly reminded to verify carefully when you are placing an order with us if you are actually saving half in comparison with the top major brands.

VEVOR[®]

TOUGH TOOLS, HALF PRICE

STANDING DESK FRAME

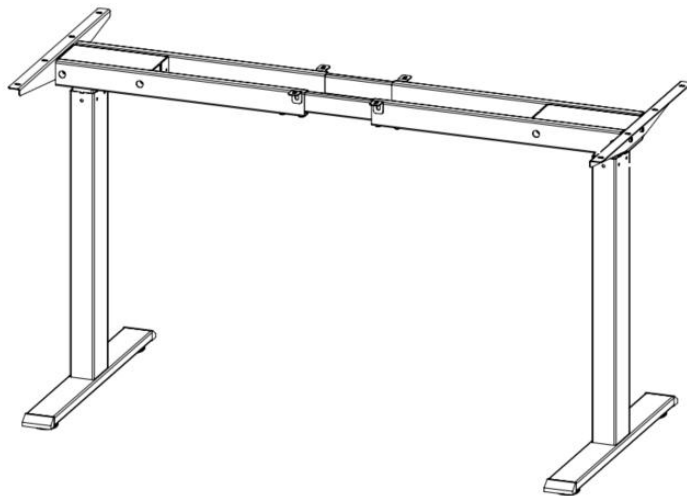

NEED HELP? CONTACT US!

Have product questions? Need technical support? Please feel free to contact us:

Technical Support and E-Warranty Certificate
www.vevor.com/support

This is the original instruction, please read all manual instructions carefully before operating. VEVOR reserves a clear interpretation of our user manual. The appearance of the product shall be subject to the product you received. Please forgive us that we won't inform you again if there are any technology or software updates on our product.

Liste der Einzelteile



A x 2

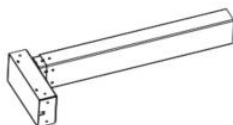

B x 2



C x 2



D x 2



E x 2



F x 2



G x 1



H x 1



J x 1



M x 8



N x 20

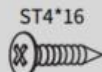

O x 2



P x 2

INSTALLATION

1 Beam installation-Step1

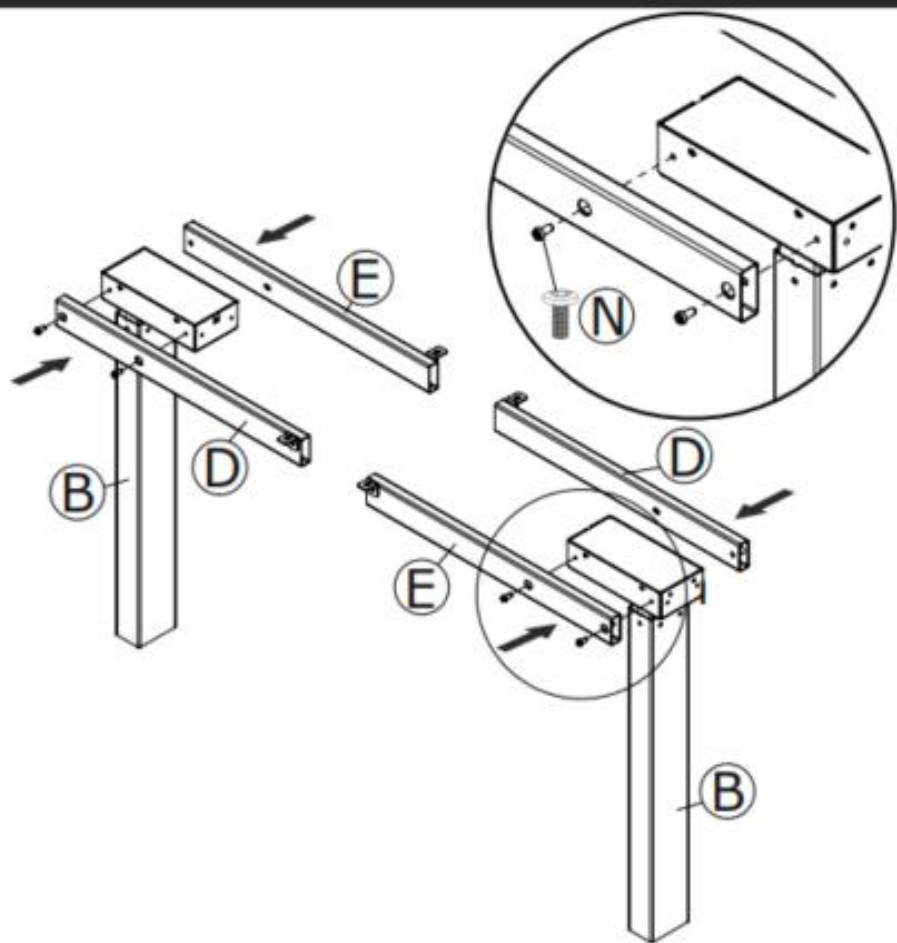

D x 2
E x 2
B x 2

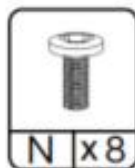

2 Beam installation-Step2

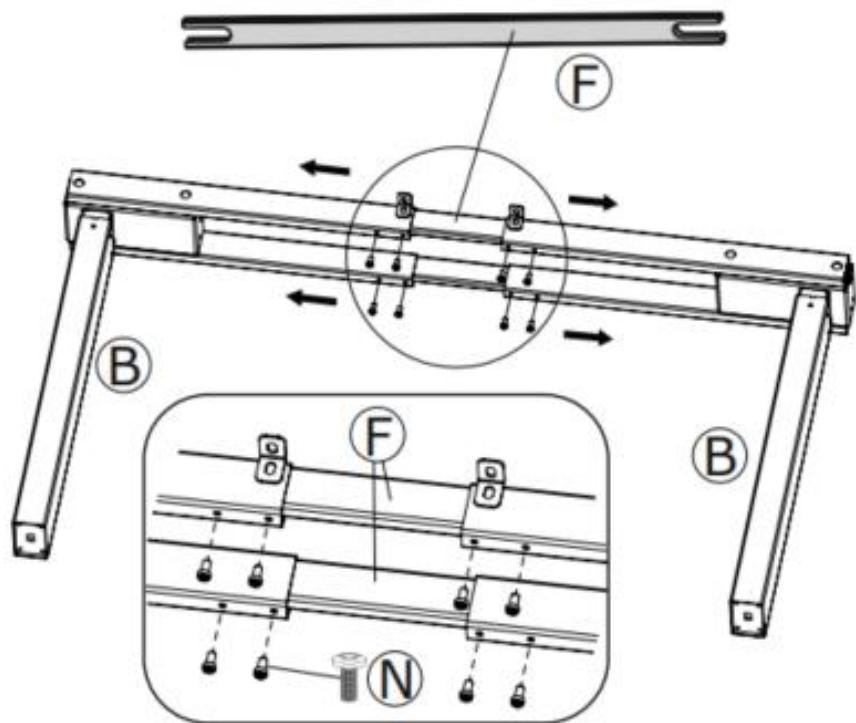

F x 2

N x 8

3 Foot installation

When the ground is uneven, the foot pad can be rotated to achieve balance.

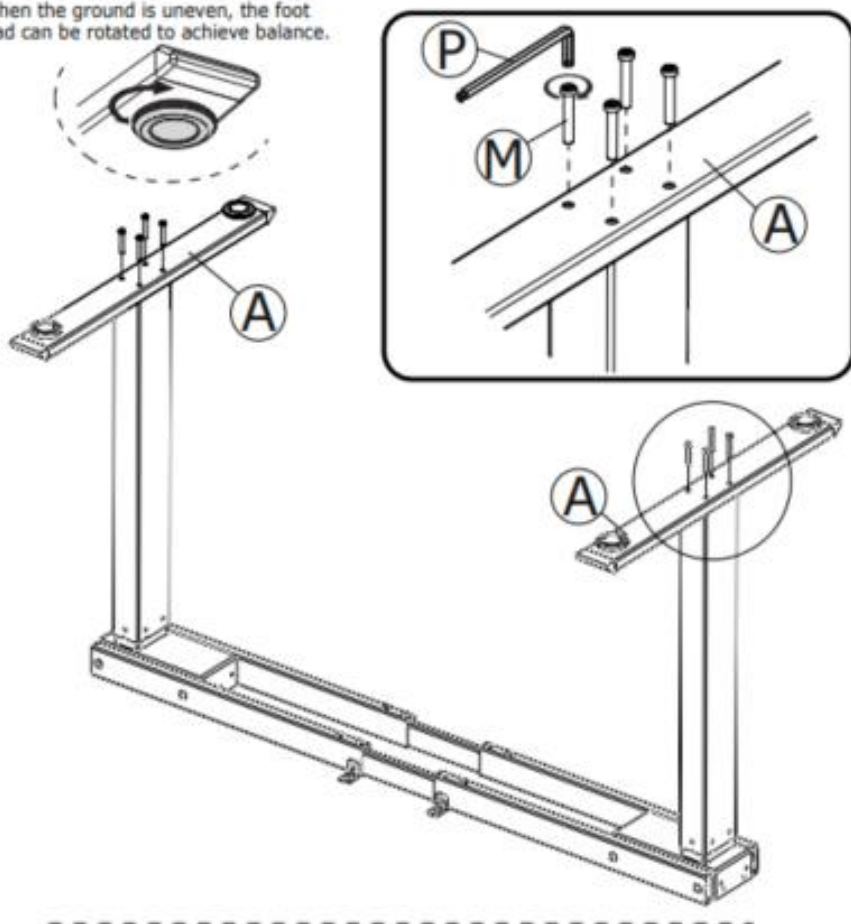

A x 2



4 Side wing installation

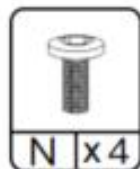
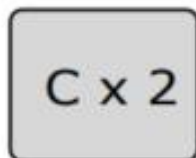
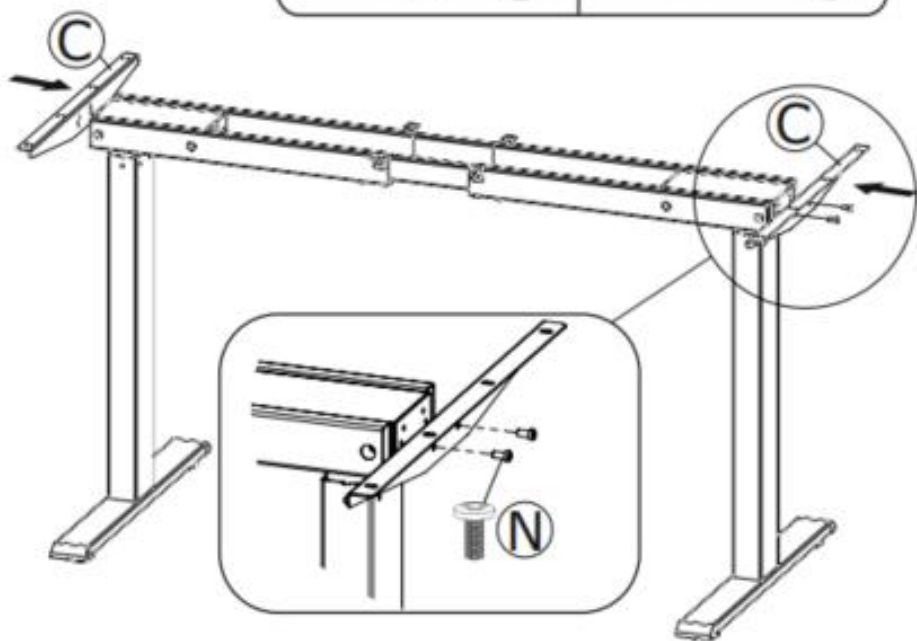
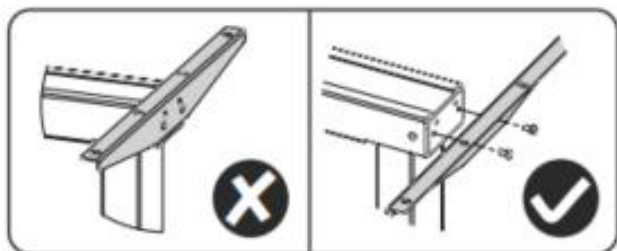

5 Line connection

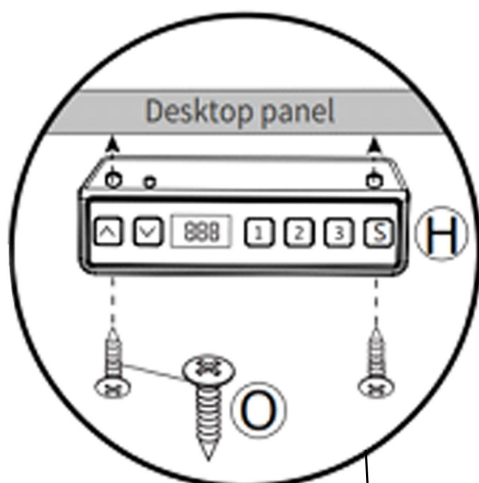

The controller can be fixed to the tabletop

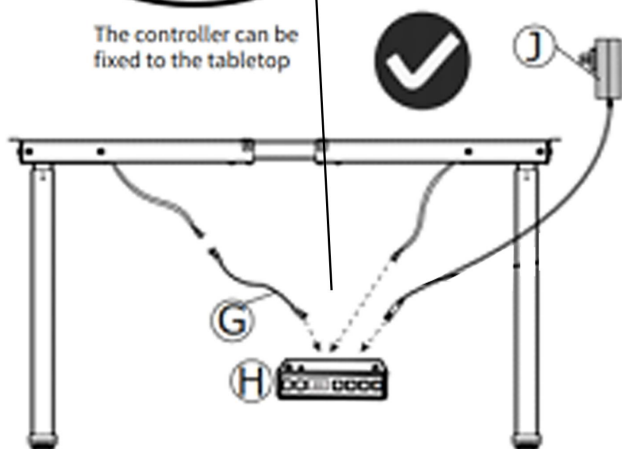







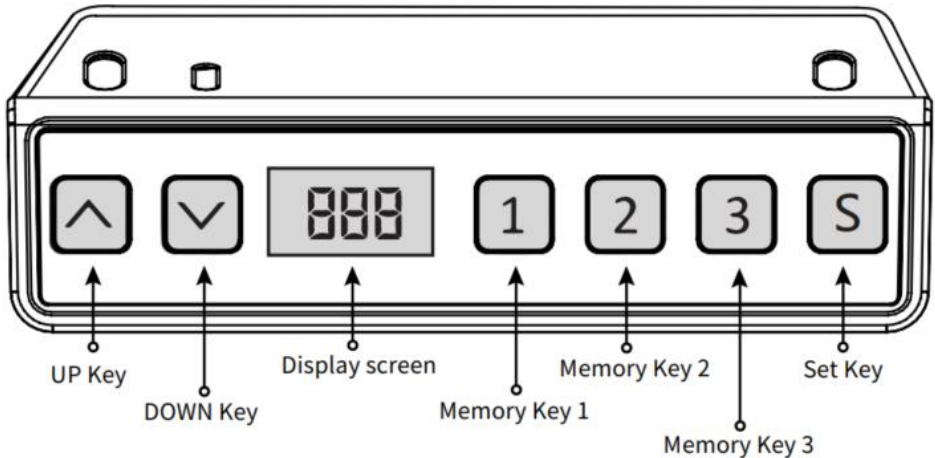

H x 1
J x 1
G x 1





BEDIENUNGSANLEITUNG

Hinweis: Bevor Sie den höhenverstellbaren Schreibtisch verwenden, wird empfohlen, einen Reset durchzuführen. Achten Sie darauf, dass sich beide Hubsäulen auf gleicher Höhe befinden, da es zu leichten Abweichungen kommen kann (Abweichungen vom Werk (siehe BEDIENUNGSANLEITUNG – Zurücksetzen).



-  UP Key ---- Press and hold the " ^ " button to raise the desk.
 -  DOWN Key ---- Press and hold the " v " button to lower the desk.
 -  Display screen ---- Press any button to wake up the LED display.
 -  Memory Key 1 ----
 -  Memory Key 2 ----
 -  Memory Key 3 ----
- The desk can store 3 memory heights (memory 1, 2, and 3).
-  Set Key

Zurücksetzen

Halten Sie die Taste „  “ lange gedrückt. Nachdem Sie den Desktop zum niedrigsten Punkt bewegt haben, halten Sie die  Taste „  “ weiterhin gedrückt, bis der Bildschirm erscheint

blinkt „---“ und der Summer gibt einen „Piepton“ von sich, der Bildschirm zeigt den niedrigsten Höhenwert und den Reset-Vorgang an ist erfolgreich.

Bedienung der Hebefunktion

Durch Drücken der Taste „“ fährt die Tischplatte nach oben, bis sie den höchsten Punkt der Tischplatte erreicht.

Durch Drücken der Taste „“ fährt die Tischplatte nach unten, bis sie den tiefsten Punkt der Tischplatte erreicht.

Memory-Position-Speicherung/Memory-Location-Lauf

1. Standortspeicherung

Halten Sie die Speichertaste „“ gedrückt, der Summer gibt einen „Piepton“ aus und auf dem Bildschirm blinkt „S-1“.



Gleichzeitig wird der aktuelle Höhenwert angezeigt und der Speicher erfolgreich gespeichert. Insgesamt 3 Höhen können gleichzeitig aufgezeichnet werden (halten Sie die Speichertaste „“ gedrückt, auf dem Bildschirm blinkt „S-2“, drücken Sie und

Halten Sie die  Speichertaste „ “ gedrückt, auf dem Bildschirm blinkt „S-3“).

Hinweis: Wenn Sie den Speicherort auf derselben Zifferntaste erneut festlegen und erfolgreich speichern, wird der bisherige Datensatzspeicherort gelöscht





Der zuvor mit der Taste eingestellte Wert wird überschrieben.

2. Speicherpositionsbetrieb



Drücken Sie kurz die Taste „//“ , das Display blinkt 2  Sekunden  lang die Höhe der Speicherposition, der Desktop fährt automatisch auf die Höhe der Speicherposition und jede Taste kann während des Betriebs angehalten werden.





3. Sperren und entsperren

„ + „  „ + „  „ gleichzeitig 5 Sekunden lang gedrückt . Wenn auf



dem Display „L“ angezeigt wird, bedeutet dies, dass das System gesperrt wurde und nicht angehoben werden kann. 
„ + „  „ + „  „ gleichzeitig 5 Sekunden lang gedrückt, wenn die digitale Röhre von „L“ bis angezeigt wird  Die normale Digitalanzeige bedeutet, dass das System entsperrt wurde.

4. Sitzende Erinnerung (Countdown-Methode)





Countdown-Zeit: 3 Stopps, „  “ = 30 Minuten, „  “ = 45 Minuten,
„  “ = 60 Minuten.

Countdown-Start: Drücken Sie „  “ auf dem Bildschirm, um nacheinander „ “ anzuzeigen  /  /  , und der Countdown beginnt.



Ausgangs-Countdown:



1. Drücken Sie kurz die  Taste „ “ . Das Display zeigt die Nummer an und beendet den Countdown.
2. Wenn die Countdown-Zeit abgelaufen ist, blinkt auf dem Display „  “ . Die Blinkzeit beträgt 1 Minute. Drücken Sie eine beliebige Taste, um den Countdown zu stoppen Timer und Ausgang.
3. Wenn nach Ablauf der Countdown-Zeit keine Bedienung erfolgt, wird der Timer automatisch beendet, nachdem alle 5 Minuten dreimal ununterbrochen daran erinnert wird.

Werkseinstellungen wiederherstellen

“ + „  “ + „  “ gleichzeitig 5 Sekunden lang gedrückt. Auf dem Bildschirm wird „ “ angezeigt  ,  was bedeutet, dass der Parameter erfolgreich wiederhergestellt wurde .

Metrische imperiale Umschaltung

Metrisch (CM-Einheit): Drücken Sie lange „  „ + „  „, nachdem der

Summer „tickte“, wechselt die Bildschirmanzeige zur metrischen CM-Einheit Imperial (Zoll als Einheit): Drücken Sie lange auf „+“ , nachdem der Summer „getickt“ hat, wechselt die Bildschirmanzeige zu imperialen Zolleinheiten.

Fehlerbeschreibung

Error codes	Description	Resolution
E01	The motor is not connected	Press the up or down button again, if it still persists, please check the column motor connection cable
E02	Motor overcurrent	Press the up or down button again, it still persists, please replace the motor or reduce the load
E03	Motor Hall failure	Press the up or down button again, it still persists, please check the connection or replace the motor
E04	The mains power supply is abnormal	If the cable cannot be eliminated after power failure and reconnection, replace the power supply
E05	The motor current is abnormal	Reconnect the cable after power failure, if it still can't be removed, you need to return it to the factory
E06	The motor power device is bad	Reconnect the cable after power failure, if it still can't be removed, you need to return it to the factory
E09	Motor stalled	Press the up or down button again, it still persists, please replace the motor or reduce the load
Hof	Over-temperature protection	Wait for the temperature to drop, run for 2 minutes, and stop for 18 minutes
r5f	Illegal power outages	Reduce the load or check if the power cable is loose

Parametertabelle

Modell	Höhenbereich (cm)	Motor	Tischhöhe	Längenerweiterungsbereich (cm)	Größe (cm)	Länge der Tischplatte (Empfohlene Größe)

ZW-13 ZW-14 ZW-15 ZW-16	70-117	2Stk	zweistufig	110-178	110*5 8*70	L: 120 – 220 cm B: 62 – 80 cm
ZW-17 ZW-18 ZW-19 ZW-20	64-129	2Stk	dreistufig	110-178	110*5 8*64	L: 120 – 220 cm B: 62 – 80 cm

Adresse: Baoshanqu Shuangchenglu 803long 11hao 1602A-1609shi
Shanghai

Importiert nach AUS: SIHAO PTY LTD . 1 ROKEVA
STREETEASTWOOD NSW 2122 Australien

In die USA importiert: Sanven Technology Ltd. Suite 250, 9166 Anaheim
Place, Rancho Cucamonga, CA 91730

EC	REP	SHUNSHUN GmbH Römeräcker 9 Z2021,76351 Linkenheim-Hochstetten,Germany
-----------	------------	---

UK	REP	Pooledas Group Ltd Unit 5 Albert Edward House, The Pavilions Preston, United Kingdom
-----------	------------	--

In China hergestellt

VEVOR[®]

TOUGH TOOLS, HALF PRICE

Technisch Support- und E-Garantiezertifikat

www.vevor.com/support

VEVOR[®]

TOUGH TOOLS, HALF PRICE

Tecnico Supporto e certificato di garanzia elettronica www.vevor.com/support

STRUTTURA PER SCRIVANIA IN PIEDI

ISTRUZIONI PER L'USO

We continue to be committed to provide you tools with competitive price.

"Save Half", "Half Price" or any other similar expressions used by us only represents an estimate of savings you might benefit from buying certain tools with us compared to the major top brands and does not necessarily mean to cover all categories of tools offered by us. You are kindly reminded to verify carefully when you are placing an order with us if you are actually saving half in comparison with the top major brands.

VEVOR[®]

TOUGH TOOLS, HALF PRICE

STANDING DESK FRAME

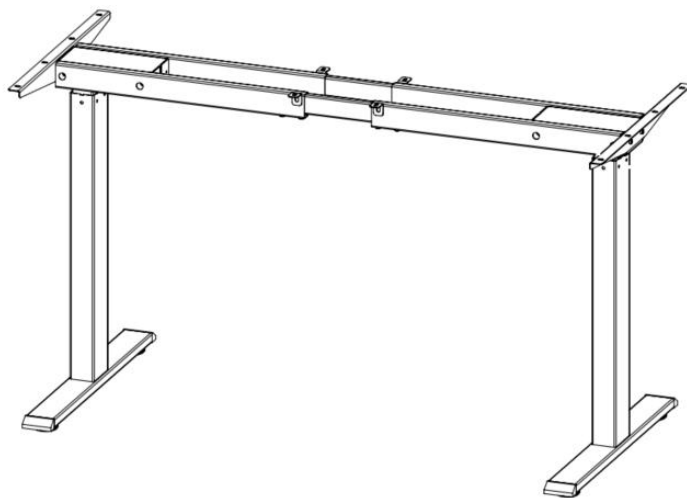

NEED HELP? CONTACT US!

Have product questions? Need technical support? Please feel free to contact us:

Technical Support and E-Warranty Certificate
www.vevor.com/support

This is the original instruction, please read all manual instructions carefully before operating. VEVOR reserves a clear interpretation of our user manual. The appearance of the product shall be subject to the product you received. Please forgive us that we won't inform you again if there are any technology or software updates on our product.

Elenco delle parti



A x 2

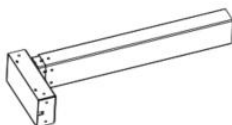

B x 2



C x 2



D x 2



E x 2



F x 2



G x 1



H x 1



J x 1



M x 8



N x 20

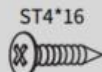

O x 2



P x 2

INSTALLAZIONE

1 Beam installation-Step1

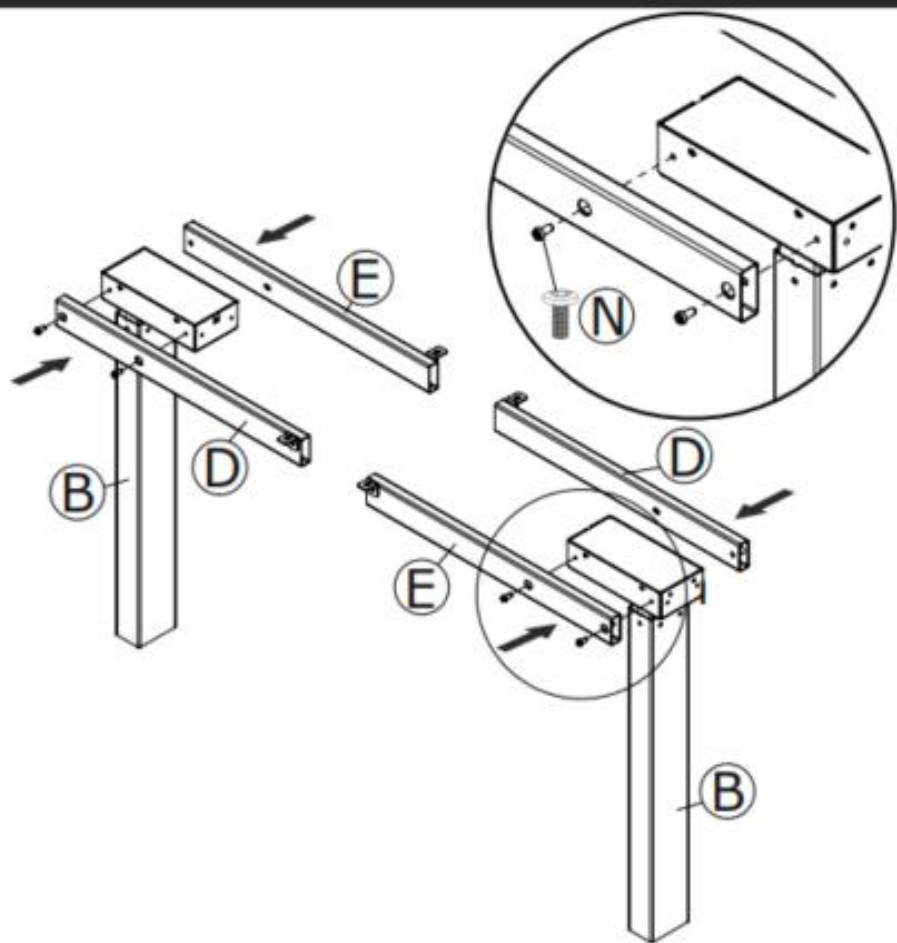

D x 2
E x 2
B x 2



2 Beam installation-Step2

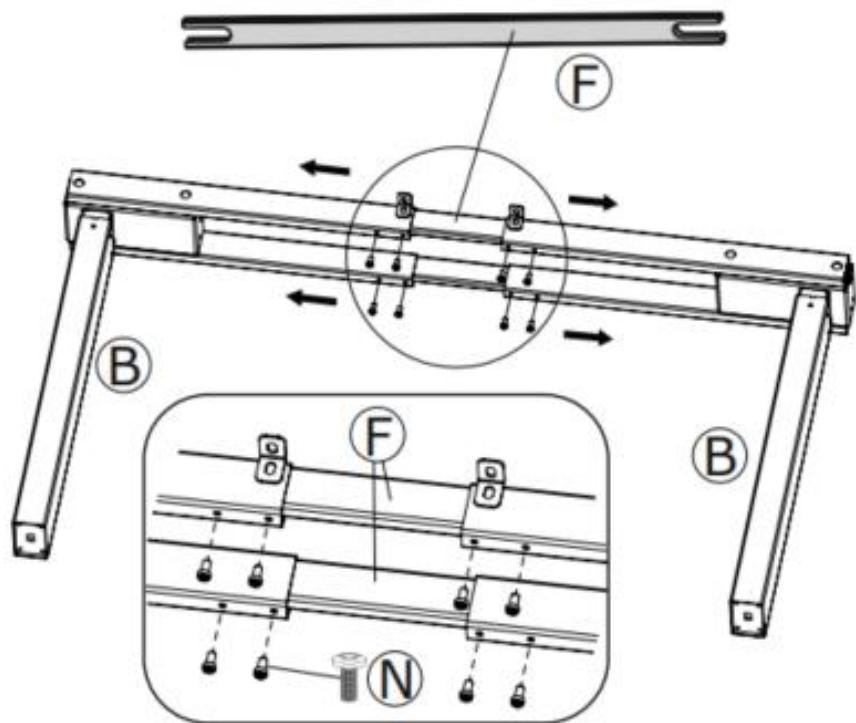

F x 2

N x 8

3 Foot installation

When the ground is uneven, the foot pad can be rotated to achieve balance.

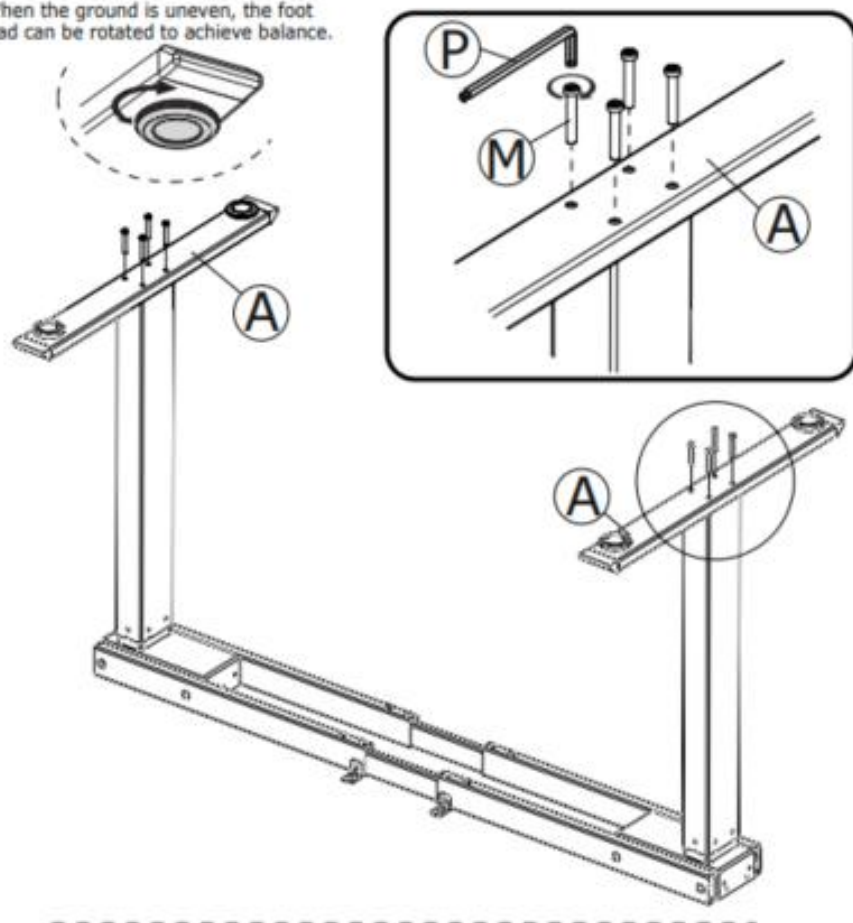

A x 2



4 Side wing installation

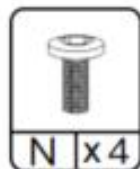
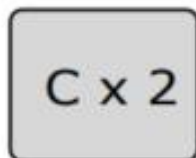
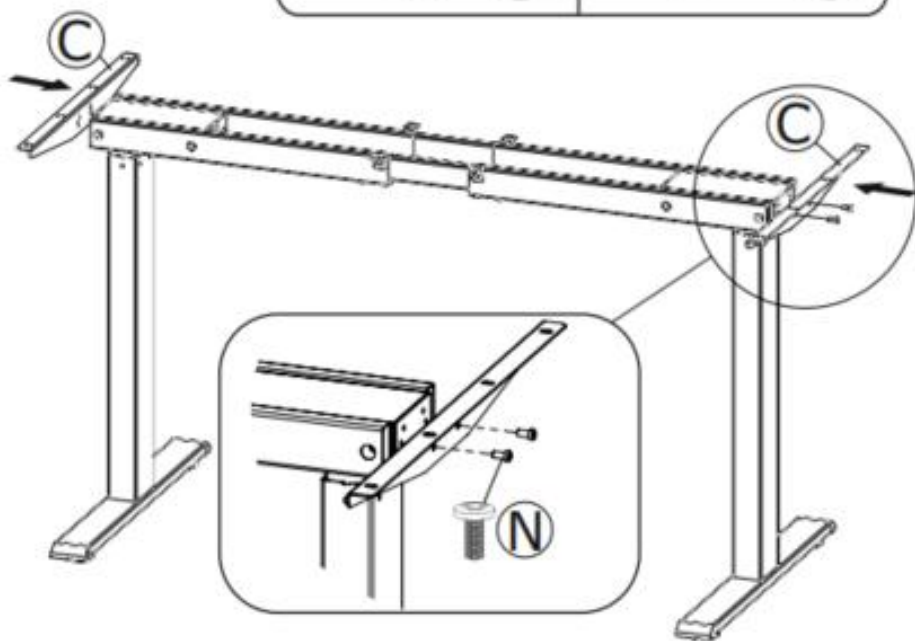
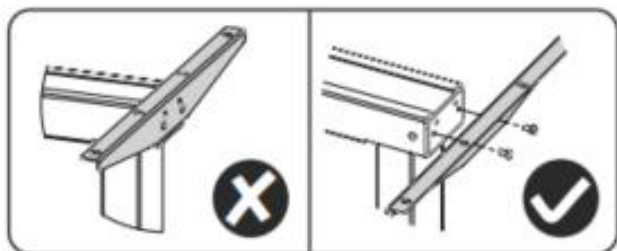

5 Line connection

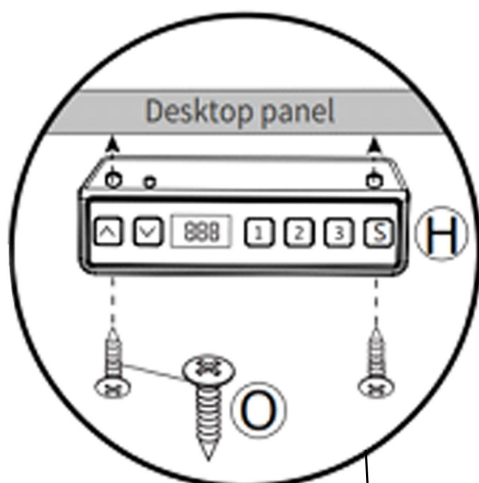

The controller can be fixed to the tabletop

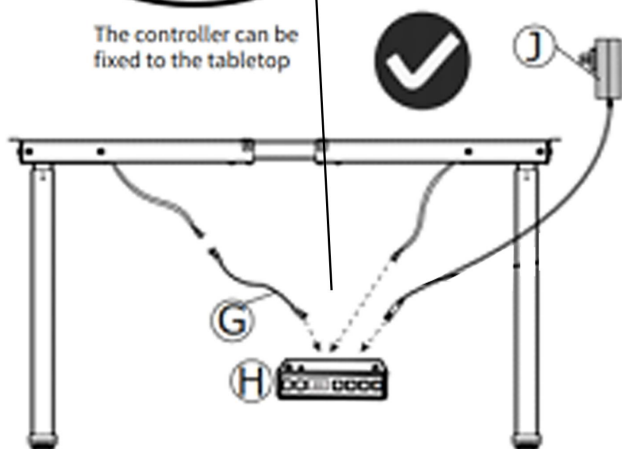







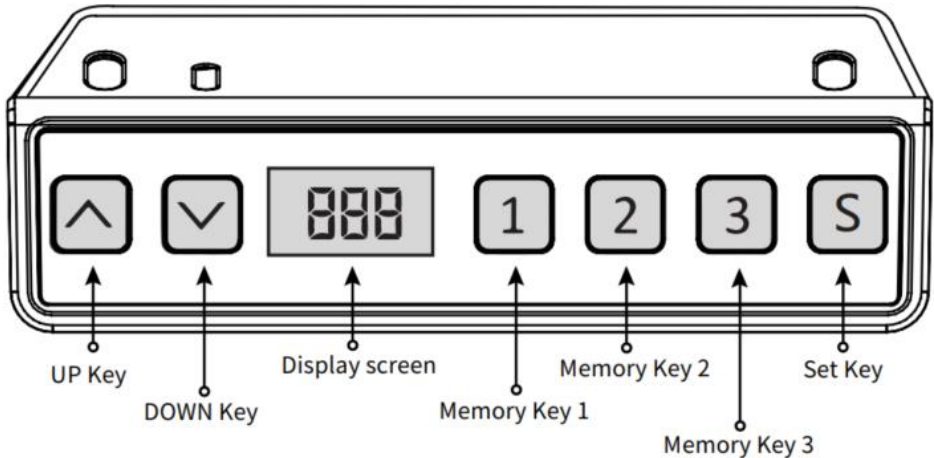

H x 1
J x 1
G x 1





ISTRUZIONI PER L'USO

Nota: prima di utilizzare la scrivania regolabile in altezza, si consiglia di eseguire un ripristino per garantire che entrambe le colonne di sollevamento siano alla stessa altezza, poiché potrebbero avere una leggera altezza variazioni rispetto alla fabbrica (vedi ISTRUZIONI PER L'USO-Reset).



-  UP Key ---- Press and hold the " ^ " button to raise the desk.
 -  DOWN Key ---- Press and hold the " v " button to lower the desk.
 -  Display screen ---- Press any button to wake up the LED display.
 -  Memory Key 1 ----
 -  Memory Key 2 ----
 -  Memory Key 3 ----
 -  Set Key
- The desk can store 3 memory heights (memory 1, 2, and 3).

Ripristina

Premere a lungo il  tasto " v ", dopo aver portato il desktop al punto più basso, continuare a tenere premuto il  tasto " v " fino allo schermo lampeggia " --- " e il cicalino emette un "bip", lo schermo visualizza il valore

di altezza più basso e l'operazione di ripristino ha successo.

Funzionamento della funzione di sollevamento

il tasto " " il desktop scorre verso l'alto fino a raggiungere il punto più alto del desktop.



Quando si preme il tasto " ", il desktop si abbassa fino a raggiungere il punto più basso del desktop.

Memorizzazione della posizione di memoria/Posizione di memoria Esegui

1. Memorizzazione della posizione

Premere e tenere premuto il pulsante di memoria " ", il cicalino emetterà un "bip" e sullo schermo lampeggerà "S-1"



allo stesso tempo, verrà visualizzato il valore dell'altitudine attuale e la memoria verrà salvata con successo. Un totale di 3 È possibile registrare 3 altezze contemporaneamente (tenere premuto il pulsante di memoria "

", sullo schermo lampeggia "S-2", premere e tenere premuto il tasto memoria " ", sullo schermo lampeggia "S-3").



Nota: se si imposta nuovamente la posizione di memoria sullo stesso tasto numerico e la si salva con successo, la memorizzazione del record precedente



precedentemente impostato tramite tasto verrà sovrascritto.

2. Operazione di posizione di memoria



Premere brevemente il pulsante "  /  / ", il display lampeggia per 2 secondi con l'altezza della posizione di memoria, il desktop si sposta automaticamente all'altezza della posizione di memoria e qualsiasi tasto può smettere di funzionare durante il funzionamento.





3. Blocca e sblocca

Blocco: tenere premuto "  " + "  " + "  " contemporaneamente per 5 secondi, quando il display mostra " L ", significa che il sistema è stato bloccato e non è possibile sollevarlo.



Sblocco: tenere premuto "  " + "  " + "  " contemporaneamente per 5 secondi, quando il tubo digitale viene visualizzato da "L" a il normale display digitale, significa che il sistema è stato sbloccato.

4. Promemoria sedentario (metodo del conto alla rovescia)





Durata del conto alla rovescia: 3 fermate, "  " = 30 minuti, "  " = 45 minuti, "  " = 60 minuti.

Avvio del conto alla rovescia: Premere  lo schermo " " per visualizzare "  /  /  " in successione e il conto alla rovescia avrà inizio.





Esci dal conto alla rovescia:

1. Premere brevemente il  pulsante " ", il display visualizzerà il numero e uscirà dal conto alla rovescia.
2. Una volta terminato il conto alla rovescia, il display lampeggerà "  ", il tempo lampeggiante è di 1 minuto, premere un pulsante qualsiasi per interrompere il timer e uscire.
3. Al termine del conto alla rovescia, se non viene eseguita alcuna operazione, il timer uscirà automaticamente dopo averlo ricordato 3 volte consecutive ogni 5 minuti.

Ripristinare le impostazioni predefinite

Metodo: tenere premuti  contemporaneamente i pulsanti "  " + "  " + " " per 5 secondi e sullo schermo verrà visualizzato "  ", il che significa che il parametro è stato ripristinato correttamente .

Commutazione metrica imperiale

Metrico (unità CM): premere a lungo "  " + "  ", dopo il "tick" del cicalino, la visualizzazione sullo schermo passerà all'unità metrica CM
Imperiali (pollici come unità): premere a lungo "  " + "  ", dopo il "tick" del cicalino, la visualizzazione sullo schermo passerà alle unità imperiali in

pollici .

Descrizione dell'errore

Error codes	Description	Resolution
E01	The motor is not connected	Press the up or down button again, if it still persists, please check the column motor connection cable
E02	Motor overcurrent	Press the up or down button again, if it still persists, please replace the motor or reduce the load
E03	Motor Hall failure	Press the up or down button again, it still persists, please check the connection or replace the motor
E04	The mains power supply is abnormal	If the cable cannot be eliminated after power failure and reconnection, replace the power supply
E05	The motor current is abnormal	Reconnect the cable after power failure, if it still can't be removed, you need to return it to the factory
E06	The motor power device is bad	Reconnect the cable after power failure, if it still can't be removed, you need to return it to the factory
E09	Motor stalled	Press the up or down button again, it still persists, please replace the motor or reduce the load
Hof	Over-temperature protection	Wait for the temperature to drop, run for 2 minutes, and stop for 18 minutes
r5f	Illegal power outages	Reduce the load or check if the power cable is loose

Tabella dei parametri

Modello	Gamma di sollevamento in altezza (cm)	Il motore	Livello della gamba del tavolo	Gamma di estensione e della lunghezza (cm)	Misura (cm)	Lunghezza del piano del tavolo (dimensione consigliata)
---------	---------------------------------------	-----------	--------------------------------	--	-------------	---

ZW-13 ZW-14 ZW-15 ZW-16	70-117	2 pezzi	due stadi	110-178	110*5 8*70	L:120-220 cm L: 62-80 cm
ZW-17 ZW-18 ZW-19 ZW-20	64-129	2 pezzi	tre stadi	110-178	110*5 8*64	L:120-220 cm L: 62-80 cm

Indirizzo: Baoshanqu Shuangchenglu 803long 11hao 1602A-1609shi
Shanghai

Importato in AUS: SIHAO PTY LTD . 1 ROKEVA STREETEASTWOOD
NSW 2122 Australia

Importato negli Stati Uniti: Sanven Technology Ltd. Suite 250, 9166
Anaheim Place, Rancho Cucamonga, CA 91730

EC	REP
-----------	------------

SHUNSHUN GmbH
Römeräcker 9 Z2021,76351
Linkenheim-Hochstetten,Germany

UK	REP
-----------	------------

Pooledas Group Ltd
Unit 5 Albert Edward House, The Pavilions
Preston, United Kingdom

Made in China

VEVOR[®]

TOUGH TOOLS, HALF PRICE

Tecnico Supporto e certificato di garanzia elettronica

www.vevor.com/support

VEVOR[®]

TOUGH TOOLS, HALF PRICE

Técnico Soporte y certificado de garantía electrónica www.vevor.com/support

ESTRUCTURA DE ESCRITORIO DE PIE

INSTRUCCIONES DE OPERACIÓN

We continue to be committed to provide you tools with competitive price.

"Save Half", "Half Price" or any other similar expressions used by us only represents an estimate of savings you might benefit from buying certain tools with us compared to the major top brands and does not necessarily mean to cover all categories of tools offered by us. You are kindly reminded to verify carefully when you are placing an order with us if you are actually saving half in comparison with the top major brands.

VEVOR®

TOUGH TOOLS, HALF PRICE

STANDING DESK FRAME

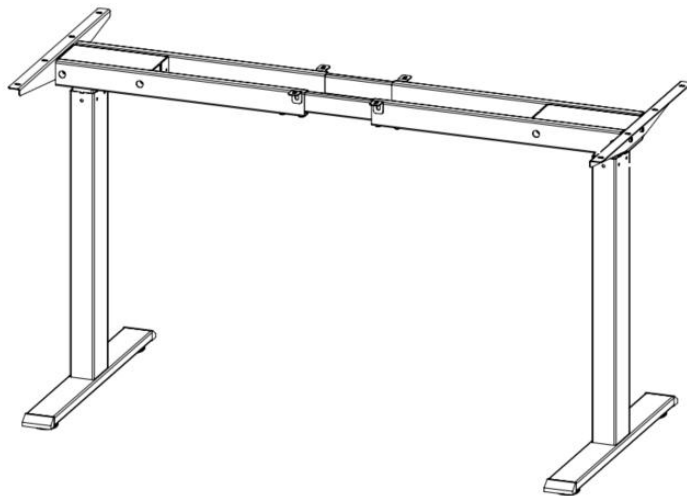

NEED HELP? CONTACT US!

Have product questions? Need technical support? Please feel free to contact us:

Technical Support and E-Warranty Certificate
www.vevor.com/support

This is the original instruction, please read all manual instructions carefully before operating. VEVOR reserves a clear interpretation of our user manual. The appearance of the product shall be subject to the product you received. Please forgive us that we won't inform you again if there are any technology or software updates on our product.

Lista de partes



A x 2

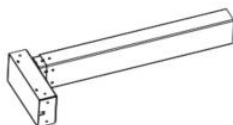

B x 2



C x 2



D x 2



E x 2



F x 2



G x 1



H x 1



J x 1



M x 8



N x 20

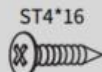

O x 2



P x 2

INSTALACIÓN

1 Beam installation-Step1

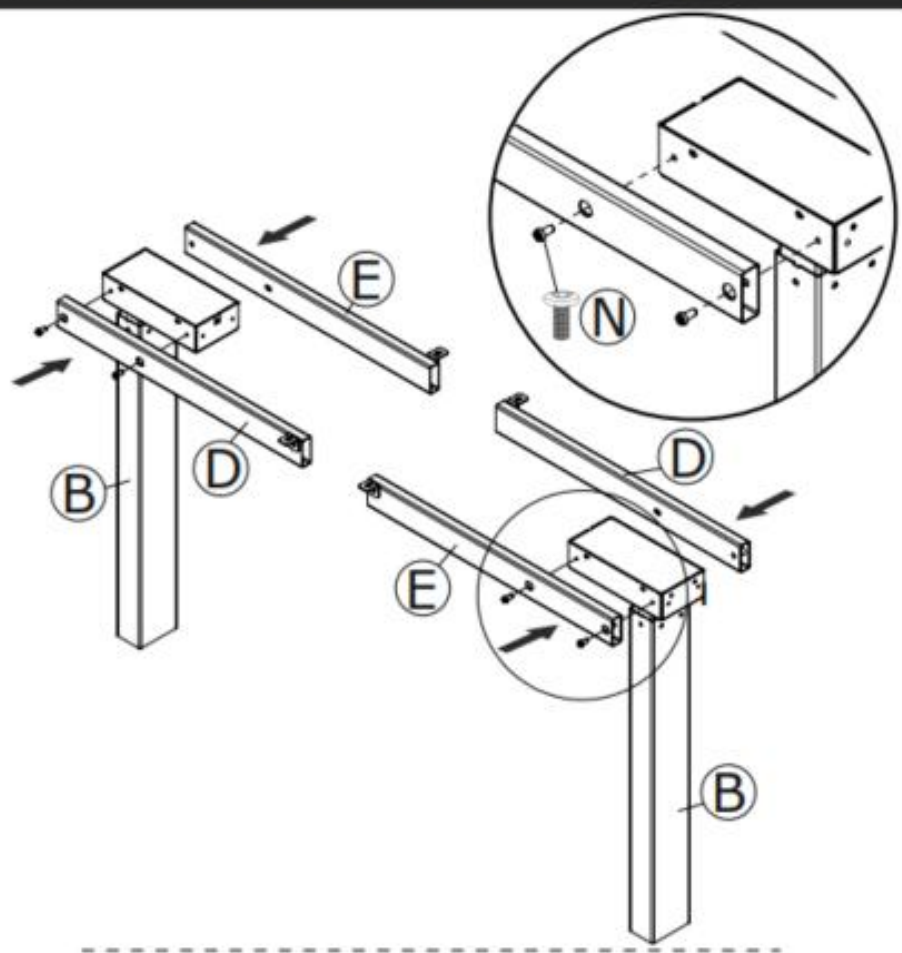

D x 2
E x 2
B x 2

N x 8

2 Beam installation-Step2

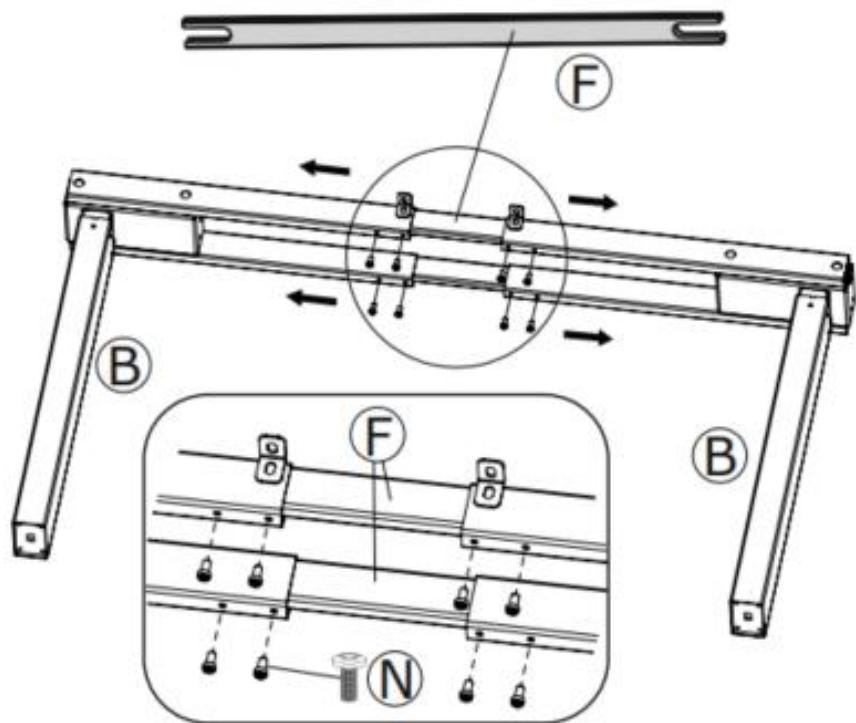

F x 2

N x 8

3 Foot installation

When the ground is uneven, the foot pad can be rotated to achieve balance.

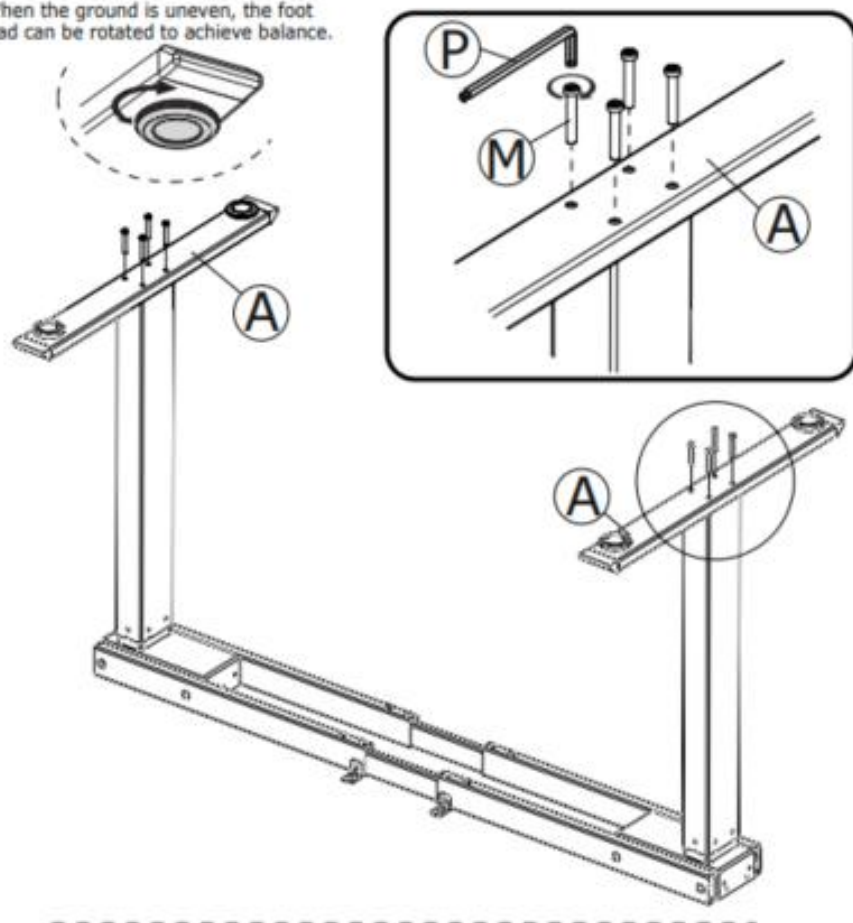

A x 2



4 Side wing installation

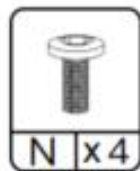
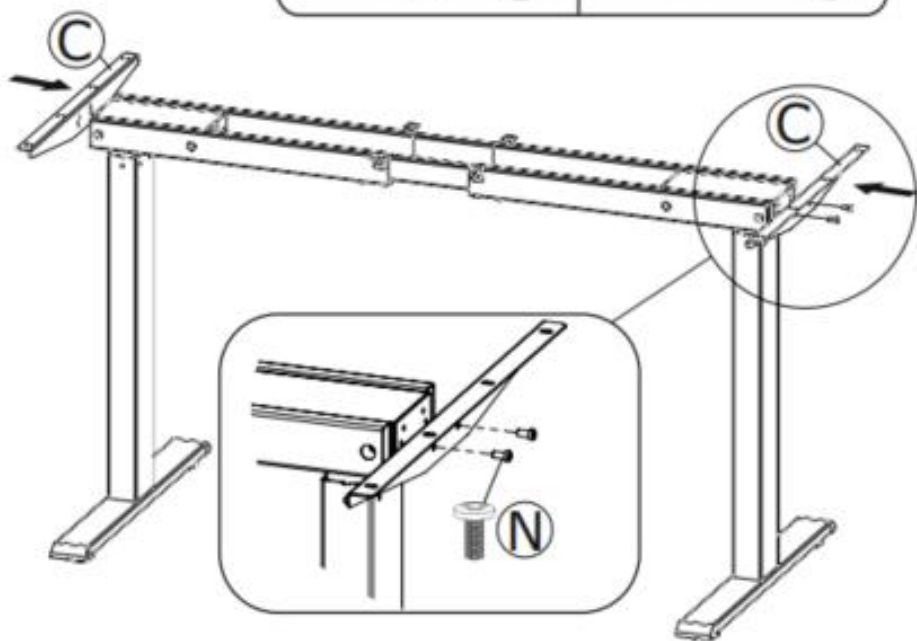
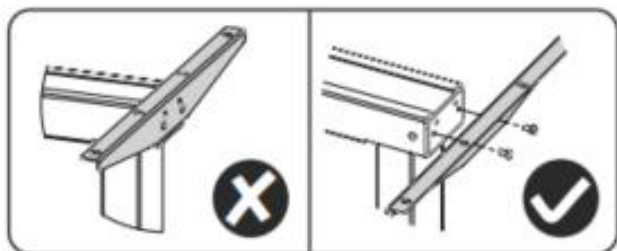

5 Line connection

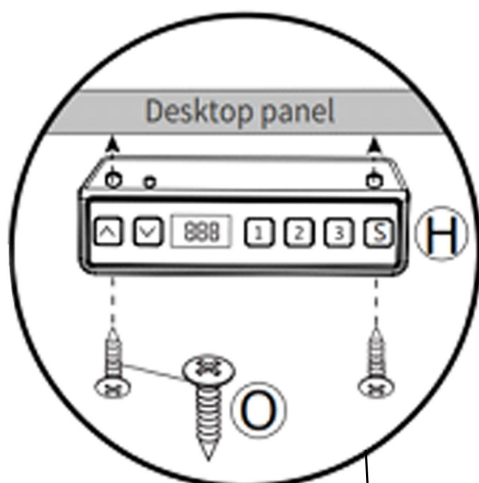

The controller can be fixed to the tabletop

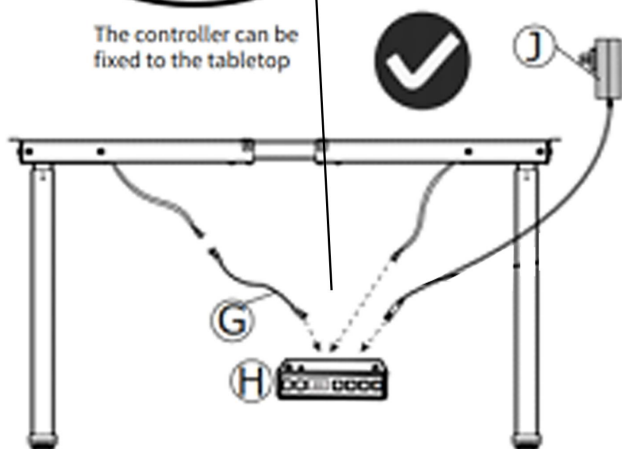







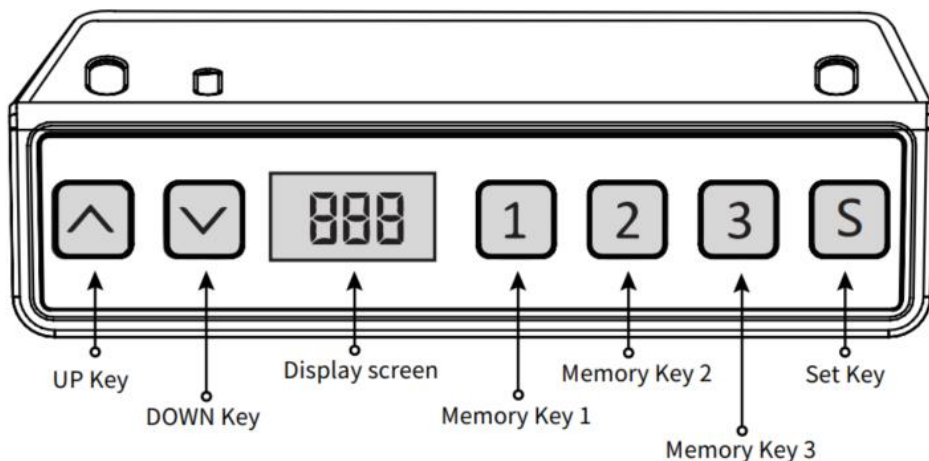

H x 1
J x 1
G x 1





INSTRUCCIONES DE OPERACIÓN

Nota: Antes de usar el escritorio de altura ajustable, se recomienda realizar un reinicio asegúrese de que ambas columnas de elevación estén a la misma altura, ya que pueden tener ligeras variaciones respecto a la fábrica (ver INSTRUCCIONES DE FUNCIONAMIENTO–Reinicio).



-  UP Key ---- Press and hold the " ^ " button to raise the desk.
-  DOWN Key ---- Press and hold the " v " button to lower the desk.
-  Display screen ---- Press any button to wake up the LED display.
-  Memory Key 1 ----
-  Memory Key 2 ---- The desk can store 3 memory heights (memory 1, 2, and 3).
-  Memory Key 3 ----
-  Set Key

Reiniciar

Mantenga presionada la  tecla " v ", después de ejecutar el escritorio hasta el punto más bajo, mantenga presionada la  tecla " v " hasta que aparezca la pantalla.

parpadea " --- " y el zumbador emite un sonido de "bip", la pantalla

muestra el valor de altura más bajo y la operación de reinicio es exitoso.

Operación de la función de elevación

Cuando se presiona la tecla "  ", el escritorio corre hacia arriba hasta llegar al punto más alto del escritorio.

Cuando se presiona la tecla "  ", el escritorio baja hasta llegar al punto más bajo del escritorio.

Posición de memoria Almacenamiento/Ubicación de memoria Ejecutar

1. Almacenamiento de ubicación

Mantenga presionado el botón de memoria "  ", el timbre emitirá un "bip" y la pantalla parpadeará "S-1" en el



Al mismo tiempo, se mostrará el valor de altitud actual y el almacenamiento de la memoria se guardará correctamente. Un total de Se pueden grabar 3 alturas al mismo tiempo (presione y mantenga presionado el botón de memoria "  ", presione y

mantenga  presionada la tecla de memoria " ", la pantalla parpadea "S-3").

Nota: Si configura la ubicación de la memoria en la misma tecla numérica nuevamente y la guarda exitosamente, el almacenamiento de registros que se

Los datos previamente configurados con la tecla se sobrescribirán.



2. Operación de posición de memoria

Presione brevemente el botón "  /  /  ", la pantalla parpadea la altura de la posición de la memoria durante 2 segundos, el escritorio se ejecuta automáticamente hasta la altura de la posición de la memoria y cualquier tecla puede dejar de funcionar durante la operación.



3. Bloquear y desbloquear





Bloquear: Mantenga presionado "  " + "  " + "  " al mismo tiempo

durante 5 segundos, cuando la pantalla muestre " L ", significa que el sistema se ha bloqueado y no puede levantarlo.



Desbloquear: Mantenga presionado "  " + "  " + "  " al mismo tiempo durante 5 segundos, cuando el tubo digital se muestre de "L" a la pantalla digital normal, significa que el sistema ha sido desbloqueado.

4.Recordatorio de sedentarismo (método de cuenta regresiva)





Tiempo de cuenta atrás: 3 paradas, "  " = 30 minutos, "  " = 45 minutos, "  " = 60 minutos.

Inicio de cuenta regresiva: Presione  la pantalla " " para mostrar "  /  /  " a su vez y comenzará la cuenta regresiva.



Salir de la cuenta regresiva:



1. Presione brevemente el  botón " ", la pantalla mostrará el número y saldrá de la cuenta regresiva.
2. Cuando finalice el tiempo de cuenta regresiva, la pantalla parpadeará "  ", el tiempo de parpadeo es de 1 minuto, presione cualquier botón para detener la temporizador y salida.
3. Una vez finalizado el tiempo de cuenta atrás, si no se realiza ninguna operación, saldrá automáticamente del temporizador después de recordarlo 3 veces seguidas cada 5 minutos.

Restaurar la configuración de fábrica

Método: Mantenga presionados los botones "  " + "  " + "  " al mismo tiempo durante 5 segundos y la pantalla mostrará "  ", lo que significa que el parámetro se restauró exitosamente .

Conmutación métrica imperial

Métrico (unidad CM): Mantenga presionado "  " + "  ", después del "tic" del timbre, la visualización de la pantalla cambiará a la unidad métrica

CM Imperial (pulgadas como unidad): Mantenga presionado "  " + "  ", después del "tic" del timbre, la pantalla cambiará a unidades de pulgadas imperiales .

Error de descripción

Error codes	Description	Resolution
E01	The motor is not connected	Press the up or down button again, if it still persists, please check the column motor connection cable
E02	Motor overcurrent	Press the up or down button again, it still persists, please replace the motor or reduce the load
E03	Motor Hall failure	Press the up or down button again, it still persists, please check the connection or replace the motor
E04	The mains power supply is abnormal	If the cable cannot be eliminated after power failure and reconnection, replace the power supply
E05	The motor current is abnormal	Reconnect the cable after power failure, if it still can't be removed, you need to return it to the factory
E06	The motor power device is bad	Reconnect the cable after power failure, if it still can't be removed, you need to return it to the factory
E09	Motor stalled	Press the up or down button again, it still persists, please replace the motor or reduce the load
H0f	Over-temperature protection	Wait for the temperature to drop, run for 2 minutes, and stop for 18 minutes
r5f	Illegal power outages	Reduce the load or check if the power cable is loose

tabla de parámetros

Modelo	Rango de elevación de altura (cm)	Motor	Nivel de las patas de la mesa	Rango de extensión de longitud (cm)	Tamaño o (cm)	Longitud del tablero de la mesa (Tamaño sugerido)

ZW-13 ZW-14 ZW-15 ZW-16	70-117	2 pieza s	dos etapas	110-178	110*5 8*70	Largo: 120-220 cm Ancho: 62-80 cm
ZW-17 ZW-18 ZW-19 ZW-20	64-129	2 pieza s	tres etapas	110-178	110*5 8*64	Largo: 120-220 cm Ancho: 62-80 cm

Dirección: Baoshanqu Shuangchenglu 803long 11hao 1602A-1609shi
Shanghai

Importado a AUS: SIHAO PTY LTD . 1 ROKEVA STREET ASTWOOD
NSW 2122 Australia

Importado a EE. UU.: Sanven Technology Ltd. Suite 250, 9166 Anaheim
Place, Rancho Cucamonga, CA 91730

EC	REP
-----------	------------

SHUNSHUN GmbH
Römeräcker 9 Z2021,76351
Linkenheim-Hochstetten, Germany

UK	REP
-----------	------------

Pooledas Group Ltd
Unit 5 Albert Edward House, The Pavilions
Preston, United Kingdom

Hecho en china

VEVOR[®]

TOUGH TOOLS, HALF PRICE

Técnico Certificado de soporte y garantía electrónica

www.vevor.com/support

VEVOR[®]

TOUGH TOOLS, HALF PRICE

Techniczny Certyfikat wsparcia i e-gwarancji www.vevor.com/support

STOJĄCA RAMA BIURKA

INSTRUKCJA OBSŁUGI

We continue to be committed to provide you tools with competitive price.

"Save Half", "Half Price" or any other similar expressions used by us only represents an estimate of savings you might benefit from buying certain tools with us compared to the major top brands and does not necessarily mean to cover all categories of tools offered by us. You are kindly reminded to verify carefully when you are placing an order with us if you are actually saving half in comparison with the top major brands.

VEVOR[®]

TOUGH TOOLS, HALF PRICE

STANDING DESK FRAME

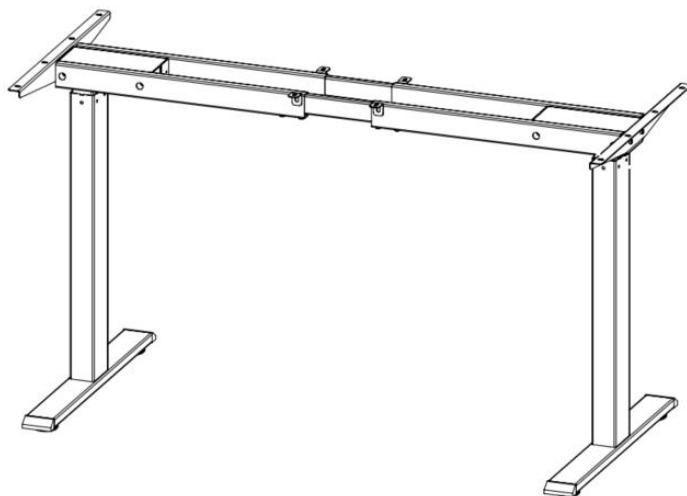

NEED HELP? CONTACT US!

Have product questions? Need technical support? Please feel free to contact us:

Technical Support and E-Warranty Certificate
www.vevor.com/support

This is the original instruction, please read all manual instructions carefully before operating. VEVOR reserves a clear interpretation of our user manual. The appearance of the product shall be subject to the product you received. Please forgive us that we won't inform you again if there are any technology or software updates on our product.

Lista części



A x 2

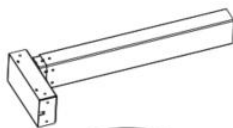

B x 2



C x 2



D x 2



E x 2



F x 2



G x 1



H x 1



J x 1



M x 8



N x 20

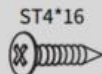

O x 2



P x 2

INSTALACJA

1 Beam installation-Step1

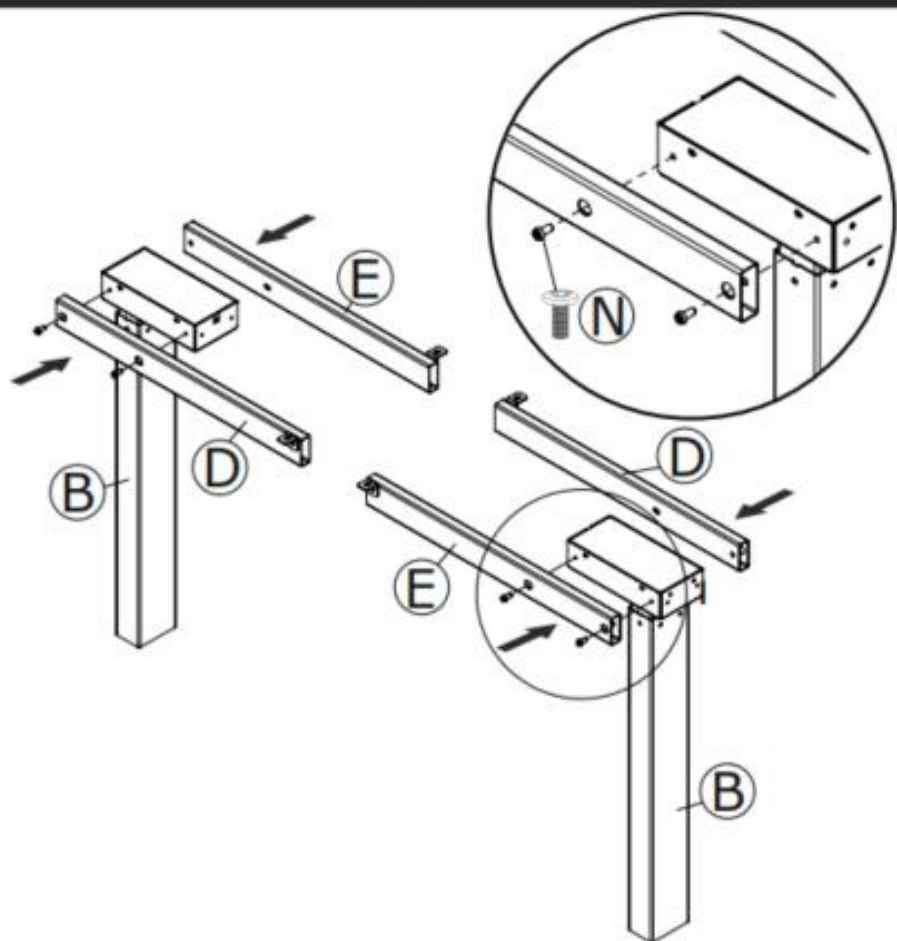

D x 2
E x 2
B x 2



2 Beam installation-Step2

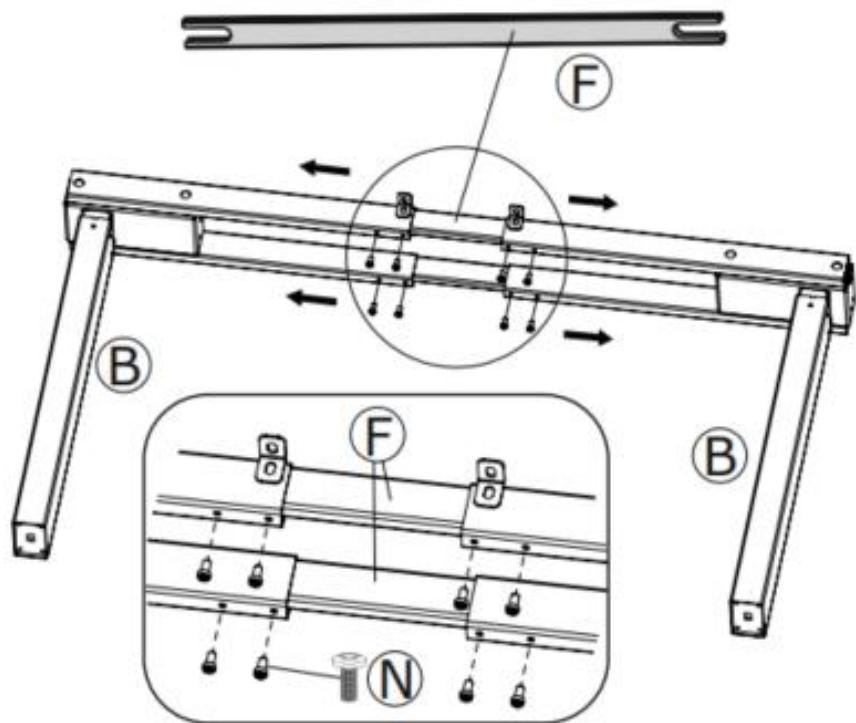

F x 2

N x 8

3 Foot installation

When the ground is uneven, the foot pad can be rotated to achieve balance.

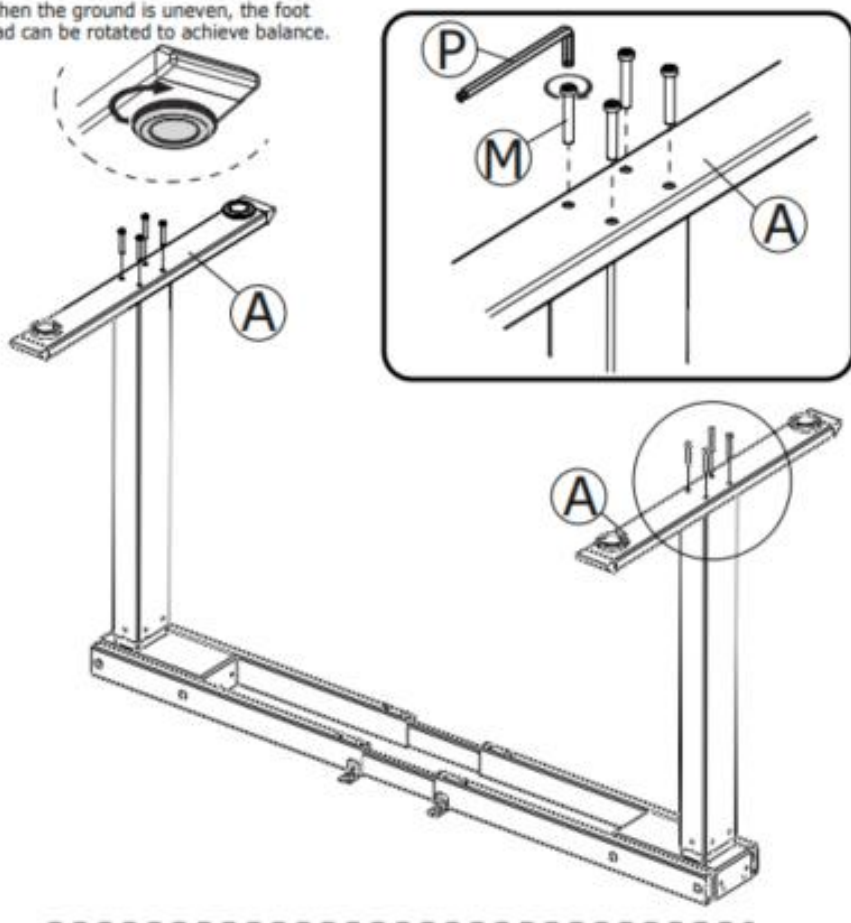

A x 2



4 Side wing installation

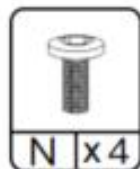
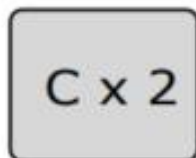
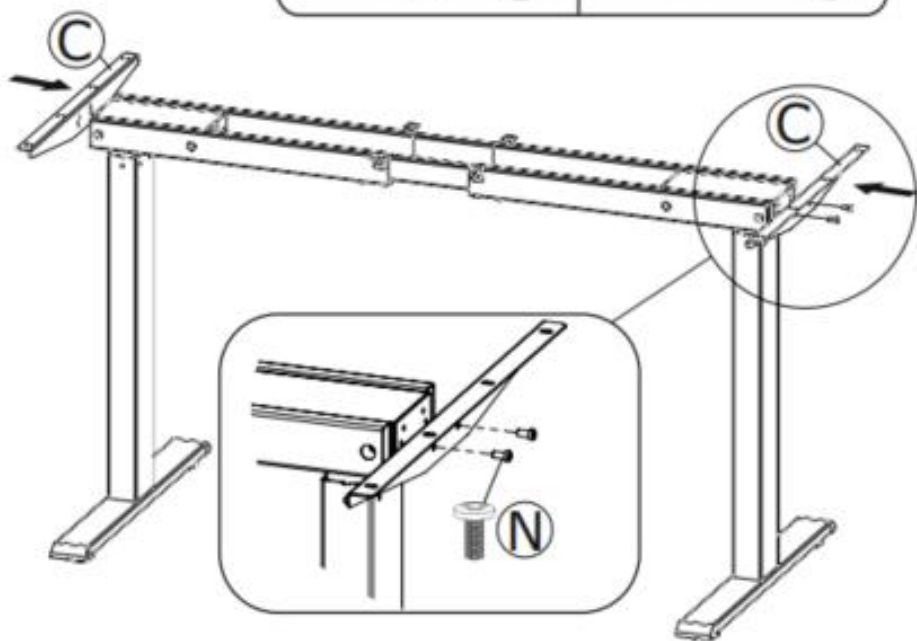
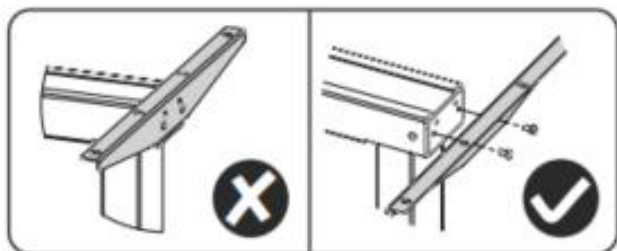

5 Line connection

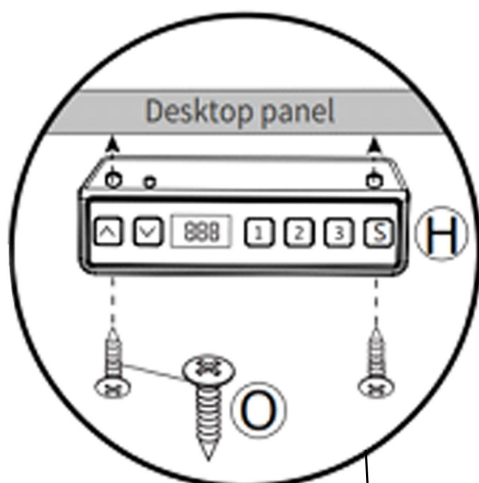

The controller can be fixed to the tabletop

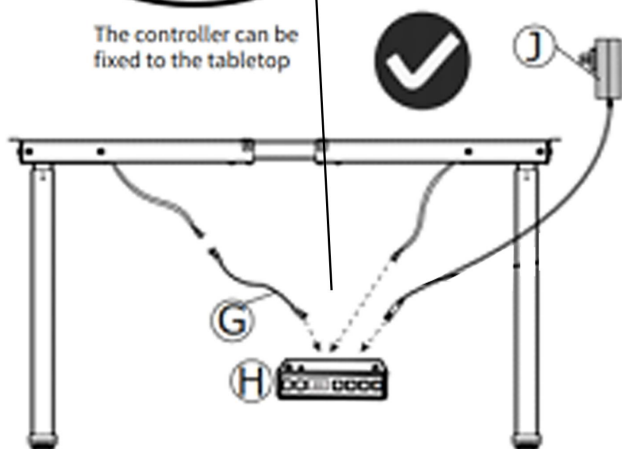







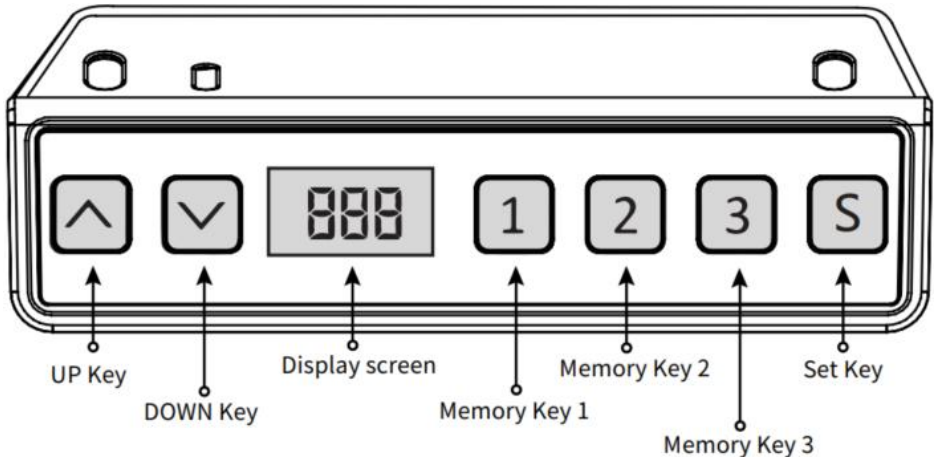

H x 1
J x 1
G x 1





INSTRUKCJA OBSŁUGI

Uwaga: Przed użyciem biurka z regulacją wysokości zaleca się wykonanie resetu aby upewnić się, że obie kolumny podnoszące znajdują się na tej samej wysokości, ponieważ mogą mieć niewielką wysokość różniącą się od fabrycznych (patrz INSTRUKCJA OBSŁUGI – Reset).



-  UP Key ---- Press and hold the " ^ " button to raise the desk.
 -  DOWN Key ---- Press and hold the " v " button to lower the desk.
 -  Display screen ---- Press any button to wake up the LED display.
 -  Memory Key 1 ----
 -  Memory Key 2 ----
 -  Memory Key 3 ----
- The desk can store 3 memory heights (memory 1, 2, and 3).
-  Set Key

Resetowanie

Naciśnij długo klawisz „  ”, po przesunięciu pulpitu do najniższego punktu, trzymaj  klawisz „ ” aż do pojawienia się ekranu miga „---” i brzęczyk wydaje sygnał dźwiękowy, na ekranie wyświetlana jest najniższa wartość wysokości i następuje operacja resetowania zakoń

czony powodzeniem.

Działanie funkcji podnoszenia



Po naciśnięciu klawisza „  ” pulpit przesuwa się w górę, aż osiągnie najwyższy punkt pulpitu.

Po naciśnięciu klawisza „  ” pulpit przesuwa się w dół, aż do najniższego punktu pulpitu.

Pozycja pamięci Przechowywanie/Lokalizacja pamięci Uruchom

1. Przechowywanie lokalizacji



Naciśnij i przytrzymaj przycisk pamięci „  ”, brzęczyk wyda sygnał dźwiękowy, a na ekranie zacznie migać „S-1”

w tym samym czasie, zostanie wyświetlona aktualna wartość wysokości, a pamięć zostanie pomyślnie zapisana. Łącznie Jednocześnie można zapisać 3 wysokości (naciśnij i przytrzymaj przycisk pamięci „  ”, na ekranie zacznie migać „S-2”, naciśnij i przytrzymaj klawisz  pamięci „ ”, na ekranie zacznie migać „S-3”).



Uwaga: Jeśli ponownie ustawisz lokalizację pamięci na tym samym klawiszu numerycznym i pomyślnie ją zapiszesz, dotychczasowa pamięć rekordów

wcześniej ustawione za pomocą klawisza zostaną nadpisane.

2. Operacja pozycji pamięci

Krótko naciśnij przycisk „  /  /  ”, wyświetlacz będzie migać przez 2 sekundy przez 2 sekundy wysokość pozycji pamięci, pulpit automatycznie przejdzie do wysokości pozycji pamięci, a dowolny klawisz może przestać działać podczas pracy.

3. Zablokuj i odblokuj

Blokada: Naciśnij i przytrzymaj  jednocześnie „ „ + „  „ + „ ” przez 5 sekund, gdy na wyświetlaczu pojawi się „ L ”, oznacza to, że system został zablokowany i nie można go podnieść. 

Odblokowanie: Naciśnij i przytrzymaj  jednocześnie „ „ + „  „ +

„ ” przez 5 sekund, gdy cyfrowy w kształcie tuby wyświetli się od „L” do **2** normalnego wyświetlacza cyfrowego, oznacza to, że system został odblokowany.

4. Przypomnienie o siedzeniu (metoda odliczania)

Czas odliczania: 3 przystanki, " **30**" = 30 minut, " **45**" = 45 minut, "

60" = 60 minut.

Rozpoczęcie odliczania: Naciśnij **S** ekran „ ”, aby wyświetlić „ **30** / **45** / **60** ” po kolei i rozpocznie się odliczanie.

Wyjdź z odliczania:

1. Krótko naciśnij **S** przycisk „ ”, wyświetlacz wyświetli liczbę i zakończy odliczanie.

2. Gdy czas odliczania dobiegnie końca, wyświetlacz zacznie migać „

CH ”, czas migania wynosi 1 minutę. Naciśnij dowolny przycisk, aby zatrzymać minutnik i wyjdź.

3. Jeśli po upływie czasu odliczania nie zostanie wykonana żadna operacja, licznik czasu zostanie automatycznie wyłączony po 3-krotnym przypomnieniu co 5 minut.

Przywrócić ustawienia fabryczne

Metoda: Naciśnij i przytrzymaj **^** jednocześnie przyciski „ **CLR** „ + „ **v** „ + „ ” przez 5 sekund, a na ekranie pojawi się „ **3** ”, co oznacza, że parametr został pomyślnie przywrócony .

Przełączanie metryczne imperialne

Metryczne (jednostka CM): Długie naciśnięcie „ **^** „ + „ **3** ”, po „ tyknięciu” brzęczyka wyświetlacz ekranu przełączy się na jednostkę metryczną CM Imperial (cale jako jednostka): Naciśnij i przytrzymaj „ **v** ”

+ „ **3** ”, po „tyknięciu” sygnału dźwiękowego wyświetlacz ekranu

przełączy się na cale imperialne .

Opis błędów

Error codes	Description	Resolution
E01	The motor is not connected	Press the up or down button again, if it still persists, please check the column motor connection cable
E02	Motor overcurrent	Press the up or down button again, it still persists, please replace the motor or reduce the load
E03	Motor Hall failure	Press the up or down button again, it still persists, please check the connection or replace the motor
E04	The mains power supply is abnormal	If the cable cannot be eliminated after power failure and reconnection, replace the power supply
E05	The motor current is abnormal	Reconnect the cable after power failure, if it still can't be removed, you need to return it to the factory
E06	The motor power device is bad	Reconnect the cable after power failure, if it still can't be removed, you need to return it to the factory
E09	Motor stalled	Press the up or down button again, it still persists, please replace the motor or reduce the load
H0f	Over-temperature protection	Wait for the temperature to drop, run for 2 minutes, and stop for 18 minutes
r5f	Illegal power outages	Reduce the load or check if the power cable is loose

Tabela parametrów

Model	Zakres podnoszenia na wysokość (cm)	Silnik	Poziomóg stołu	Zakres przedłużenia długości (cm)	Rozmiar (cm)	Długość deski stołu (Sugerowany rozmiar)
-------	-------------------------------------	--------	----------------	-----------------------------------	--------------	--

ZW-13 ZW-14 ZW-15 ZW-16	70-117	2 szt	dwuet apowy	110-178	110*5 8*70	Długość: 120-220 cm Szer: 62-80 cm
ZW-17 ZW-18 ZW-19 ZW-20	64-129	2 szt	trzysto pniowy	110-178	110*5 8*64	Długość: 120-220 cm Szer: 62-80 cm

Adres: Baoshanqu Shuangchenglu 803long 11hao 1602A-1609shi
Szanghaj

Import do AUS: SIHAO PTY LTD . 1 ROKEVA STREETEASTWOOD
NSW 2122 Australia

Import do USA: Sanven Technology Ltd. Suite 250, 9166 Anaheim Place,
Rancho Cucamonga, CA 91730

EC	REP	SHUNSHUN GmbH Römeräcker 9 Z2021,76351 Linkenheim-Hochstetten,Germany
-----------	------------	---

UK	REP	Pooledas Group Ltd Unit 5 Albert Edward House, The Pavilions Preston, United Kingdom
-----------	------------	--

Wyprodukowano w Chinach

VEVOR[®]

TOUGH TOOLS, HALF PRICE

Techniczny Certyfikat wsparcia i e-gwarancji

www.vevor.com/support

VEVOR[®]

TOUGH TOOLS, HALF PRICE

Technisch Ondersteuning en e-garantiecertificaat www.vevor.com/support

STAAND BUREAUFRAME

GEBRUIKSAANWIJZING

We continue to be committed to provide you tools with competitive price.

"Save Half", "Half Price" or any other similar expressions used by us only represents an estimate of savings you might benefit from buying certain tools with us compared to the major top brands and does not necessarily mean to cover all categories of tools offered by us. You are kindly reminded to verify carefully when you are placing an order with us if you are actually saving half in comparison with the top major brands.

VEVOR[®]

TOUGH TOOLS, HALF PRICE

STANDING DESK FRAME

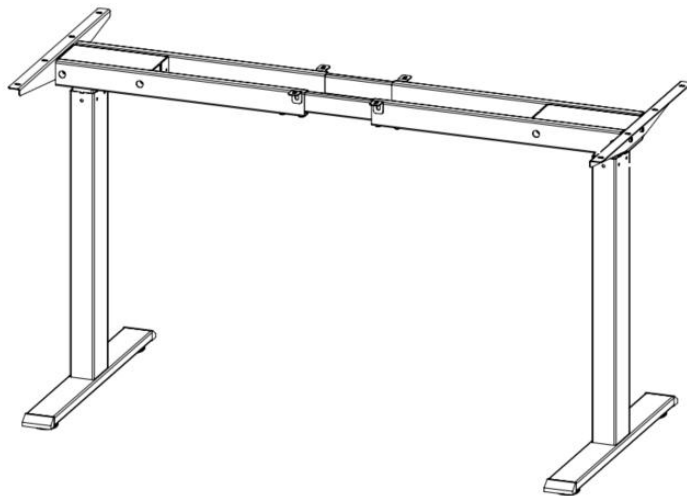

NEED HELP? CONTACT US!

Have product questions? Need technical support? Please feel free to contact us:

Technical Support and E-Warranty Certificate
www.vevor.com/support

This is the original instruction, please read all manual instructions carefully before operating. VEVOR reserves a clear interpretation of our user manual. The appearance of the product shall be subject to the product you received. Please forgive us that we won't inform you again if there are any technology or software updates on our product.

Onderdelen lijst



A x 2

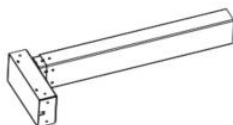

B x 2



C x 2



D x 2



E x 2



F x 2



G x 1



H x 1



J x 1



M x 8



N x 20

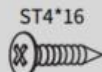

O x 2



P x 2

INSTALLATIE

1 Beam installation-Step1

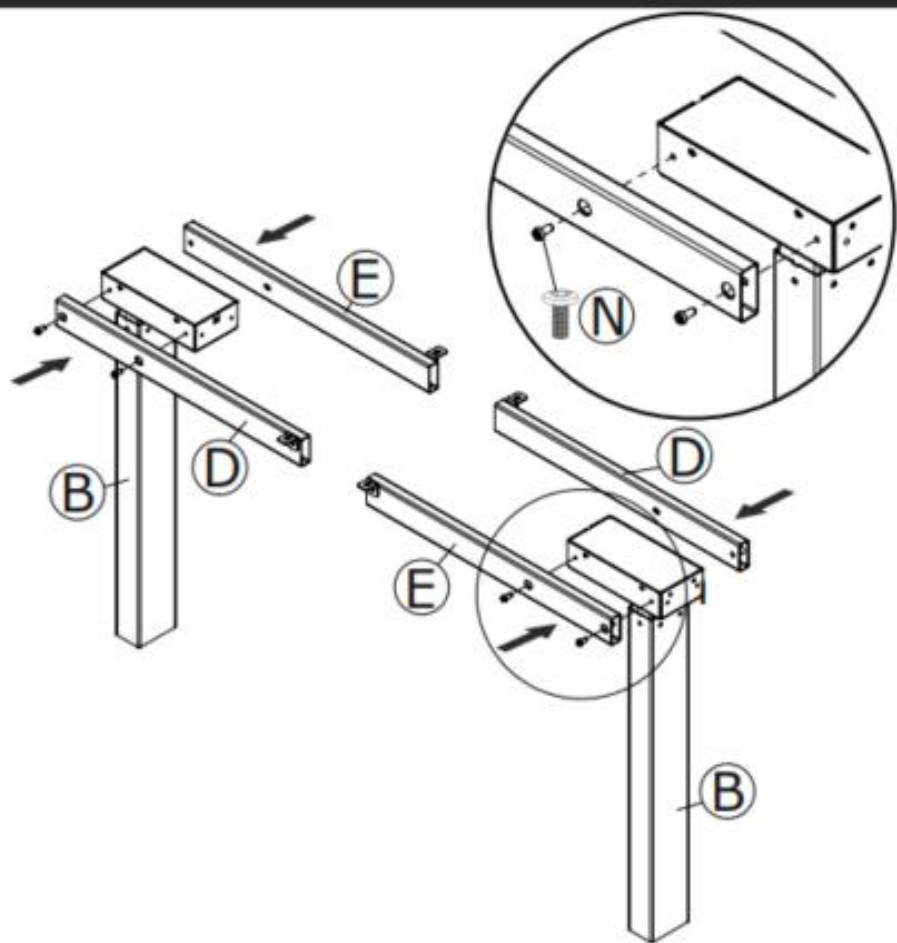

D x 2
E x 2
B x 2

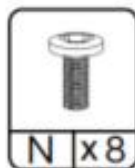

2 Beam installation-Step2

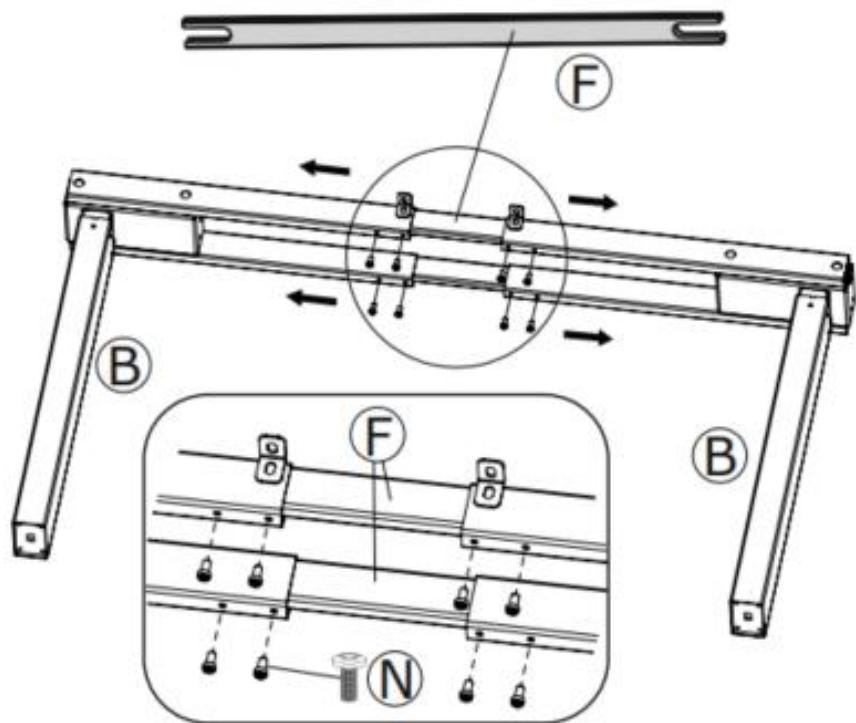

F x 2



3 Foot installation

When the ground is uneven, the foot pad can be rotated to achieve balance.

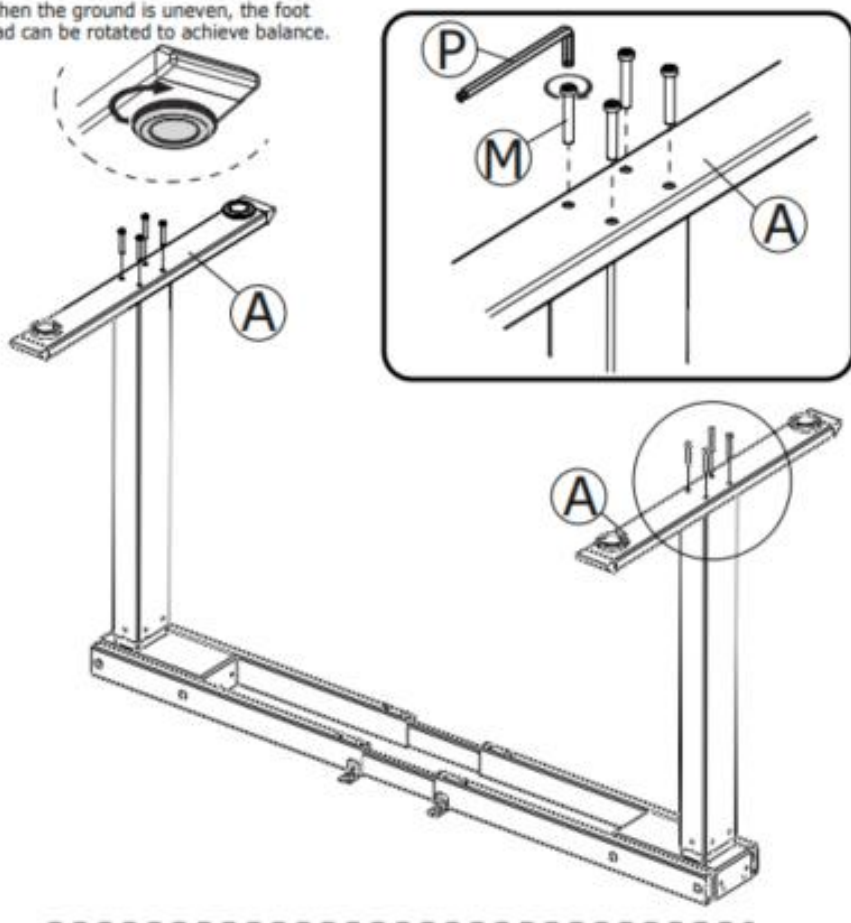

A x 2



4 Side wing installation

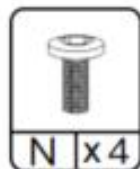
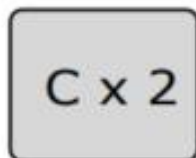
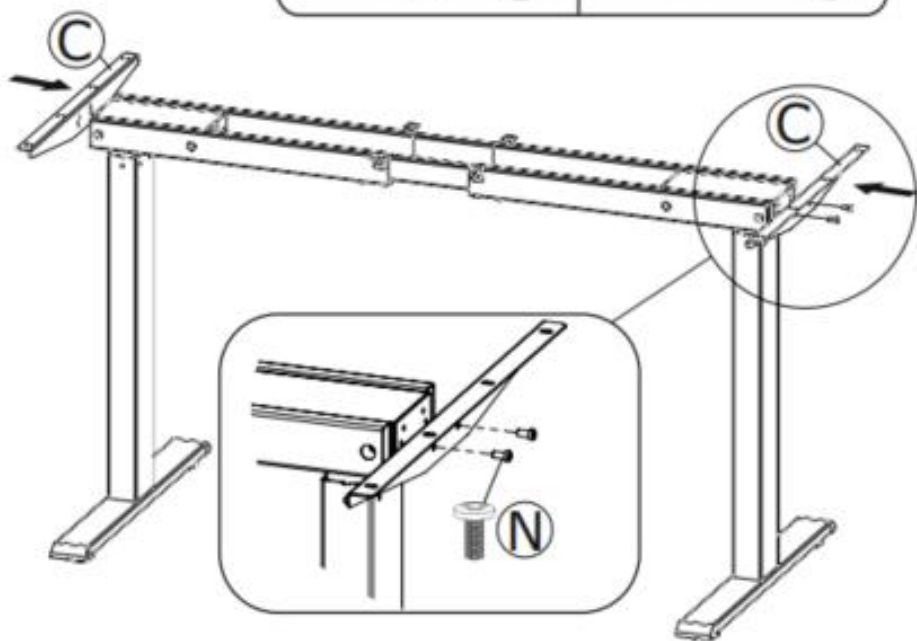
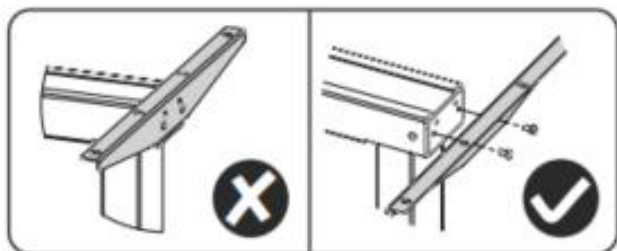

5 Line connection

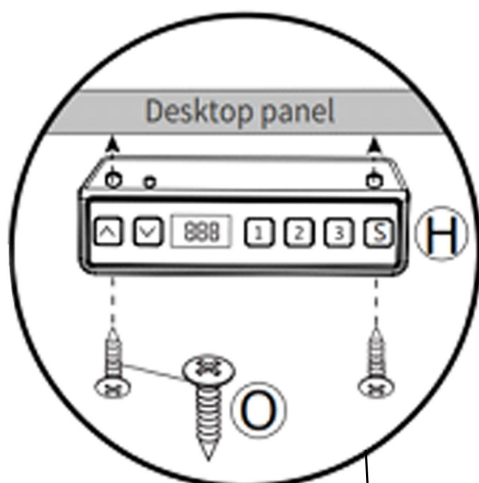

The controller can be fixed to the tabletop

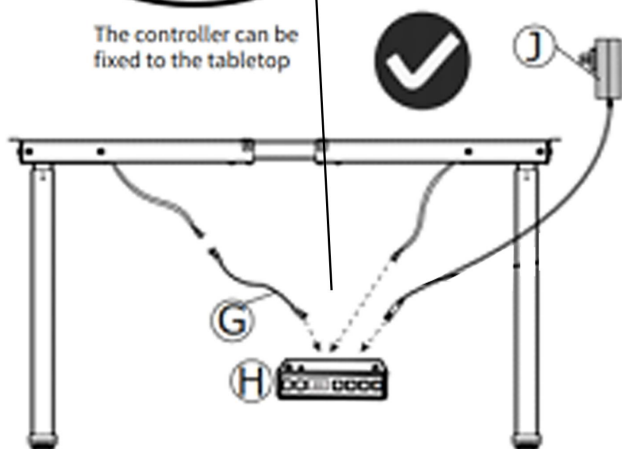







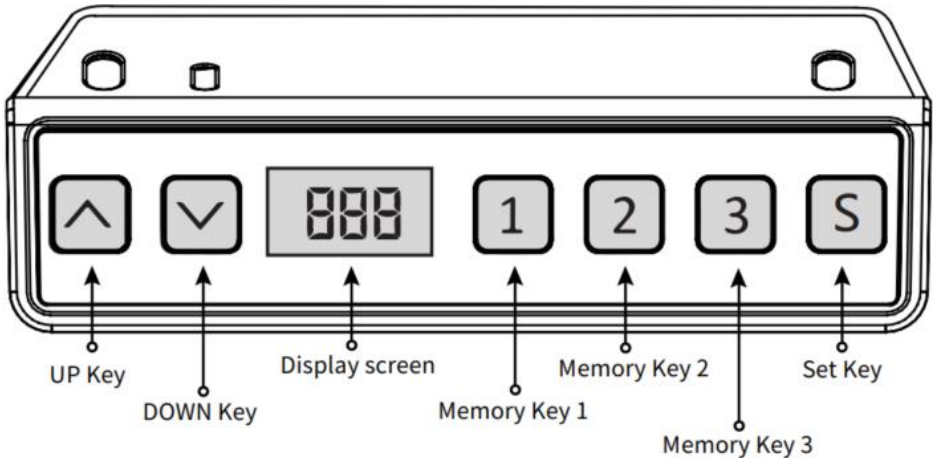

H x 1
J x 1
G x 1



GEBRUIKSAANWIJZING

Let op: Voordat u het in hoogte verstelbare bureau gebruikt, is het raadzaam een reset uit te voeren om ervoor te zorgen dat beide hefkolommen zich op dezelfde hoogte bevinden, aangezien deze licht kunnen zijn afwijkend ten opzichte van de fabriek (zie GEBRUIKSAANWIJZING – Reset).



-  UP Key ---- Press and hold the " ^ " button to raise the desk.
 -  DOWN Key ---- Press and hold the " v " button to lower the desk.
 -  Display screen ---- Press any button to wake up the LED display.
 -  Memory Key 1 ----
 -  Memory Key 2 ----
 -  Memory Key 3 ----
 -  Set Key
- The desk can store 3 memory heights (memory 1, 2, and 3).

Opnieuw instellen

Druk lang op de "  "-toets, nadat u het bureaublad naar het laagste punt hebt geleid, blijf de "  "-toets ingedrukt houden tot het scherm verschijnt knippert " --- " en de zoemer maakt een "piep" -geluid, het scherm geeft de

laagste hoogtewaarde weer en de resetbewerking is succesvol.

Bediening heffunctie



Wanneer de toets " " wordt ingedrukt, loopt het bureaublad omhoog totdat het het hoogste punt van het bureaublad bereikt.

Wanneer de toets " " wordt ingedrukt, loopt het bureaublad naar beneden totdat het het laagste punt van het bureaublad bereikt.

Geheugenpositieopslag/geheugenlocatie uitvoeren



1. Locatieopslag

Houd de geheugenknop "  " ingedrukt, de zoemer maakt een "piep"-geluid en op het scherm knippert "S-1".



Tegelijkertijd wordt de huidige hoogtewaarde weergegeven en wordt de geheugenopslag met succes opgeslagen. Een totaal van Er kunnen 3 hoogtes tegelijkertijd worden opgenomen (houd de geheugenknop "  " ingedrukt, het scherm knippert "S-2", druk op en houd de geheugentoets " " ingedrukt, het scherm knippert "S-3").



Opmerking: Als u de geheugenlocatie opnieuw op dezelfde cijfertoets instelt en deze met succes opslaat, wordt de recordopslag gebruikt die was die eerder met de sleutel is ingesteld, wordt overschreven.

2. Werking van de geheugenpositie

Druk kort op de knop "  /  /  ", het display knippert de hoogte van de geheugenpositie 2 seconden, het bureaublad loopt automatisch naar de hoogte van de geheugenpositie en elke toets kan tijdens gebruik stoppen met draaien.

3. Vergrendelen en ontgrendelen

" + "  " + "  " tegelijkertijd gedurende 5 seconden ingedrukt . Wanneer het display " L " toont, betekent dit dat het systeem is vergrendeld en het systeem niet kan optillen. 

Ontgrendelen: Houd "  " + "  " + "  " tegelijkertijd gedurende 5

seconden ingedrukt, wanneer de digitale buis wordt weergegeven van "L" tot het normale digitale display betekent dit dat het systeem is ontgrendeld.

4. Sedentaire herinnering (aftelmethode)

Afteltijd: 3 stops, " $\overline{r30}$ " = 30 minuten, " $\overline{r45}$ " = 45 minuten, " $\overline{r60}$ " = 60 minuten.

Aftellen starten: Druk op \overline{S} het scherm " " om achtereenvolgens " $\overline{r30}$ / $\overline{r45}$ / $\overline{r60}$ " weer te geven en het aftellen begint.

Aftellen afsluiten:

1. Druk kort op de \overline{S} knop " ". Het display geeft het nummer weer en sluit het aftellen af.
2. Wanneer de afteltijd is verstreken, knippert op het display " \overline{cHr} ", de knipperende tijd is 1 minuut. Druk op een willekeurige knop om het stoppen te stoppen. timer en afsluiten.
3. Nadat de afteltijd is verstreken en er geen handeling plaatsvindt, wordt de timer automatisch verlaten nadat er elke 5 minuten 3 keer continu aan is herinnerd.

Herstel naar fabrieksinstellingen

Methode: Houd de knoppen " $\overline{\wedge}$ " + " $\overline{\vee}$ " + " $\overline{3}$ " tegelijkertijd gedurende 5 seconden ingedrukt, en het scherm geeft " \overline{cLr} " weer, wat betekent dat de parameter succesvol is hersteld .

Metrische imperiale schakeling

Metrisch (CM-eenheid): Druk lang op " $\overline{\wedge}$ " + " $\overline{3}$ ", na het "vinkje" van de zoemer schakelt de schermweergave over naar de metrische CM-eenheid
Imperial (inch als eenheid): Druk lang op " $\overline{\vee}$ " + " $\overline{3}$ ", nadat de zoemer "tikt", schakelt de schermweergave over naar imperiale inch-eenheden .

Foutbeschrijving

Error codes	Description	Resolution
E01	The motor is not connected	Press the up or down button again, if it still persists, please check the column motor connection cable
E02	Motor overcurrent	Press the up or down button again, it still persists, please replace the motor or reduce the load
E03	Motor Hall failure	Press the up or down button again, it still persists, please check the connection or replace the motor
E04	The mains power supply is abnormal	If the cable cannot be eliminated after power failure and reconnection, replace the power supply
E05	The motor current is abnormal	Reconnect the cable after power failure, if it still can't be removed, you need to return it to the factory
E06	The motor power device is bad	Reconnect the cable after power failure, if it still can't be removed, you need to return it to the factory
E09	Motor stalled	Press the up or down button again, it still persists, please replace the motor or reduce the load
H0f	Over-temperature protection	Wait for the temperature to drop, run for 2 minutes, and stop for 18 minutes
r5f	Illegal power outages	Reduce the load or check if the power cable is loose

Parametertabel

Model	Hoogte hefber eik (cm)	Motor	Niveau tafelpo ot	Lengte-uitbreidings bereik (cm)	Maat (cm)	Lengte tafelblad (Voorgestelde maat)
ZW-13 ZW-14 ZW-15 ZW-16	70-117	2 stuks	tweetraps	110-178	110*5 8*70	L:120-220cm B:62-80cm

ZW-17 ZW-18 ZW-19 ZW-20	64-129	2 stuks	drietra ps	110-178	110*5 8*64	L:120-220cm B:62-80cm
----------------------------------	--------	------------	---------------	---------	---------------	--------------------------

Adres: Baoshanqu Shuangchenglu 803long 11hao 1602A-1609shi
Shanghai

Geïmporteerd naar AUS: SIHAO PTY LTD . 1 ROKEVA
STREETEASTWOOD NSW 2122 Australië

Geïmporteerd naar de VS: Sanven Technology Ltd. Suite 250, 9166
Anaheim Place, Rancho Cucamonga, CA 91730

EC	REP
-----------	------------

SHUNSHUN GmbH
Römeräcker 9 Z2021,76351
Linkenheim-Hochstetten, Germany

UK	REP
-----------	------------

Pooledas Group Ltd
Unit 5 Albert Edward House, The Pavilions
Preston, United Kingdom

Gemaakt in China

VEVOR[®]

TOUGH TOOLS, HALF PRICE

Technisch Ondersteuning en e-garantiecertificaat

www.vevor.com/support

VEVOR[®]

TOUGH TOOLS, HALF PRICE

Teknisk Support och e-garanticertifikat www.vevor.com/support

STÅENDE SKRIVBORDSRAM

BRUKSANVISNINGAR

We continue to be committed to provide you tools with competitive price.

"Save Half", "Half Price" or any other similar expressions used by us only represents an estimate of savings you might benefit from buying certain tools with us compared to the major top brands and does not necessarily mean to cover all categories of tools offered by us. You are kindly reminded to verify carefully when you are placing an order with us if you are actually saving half in comparison with the top major brands.

VEVOR[®]

TOUGH TOOLS, HALF PRICE

STANDING DESK FRAME

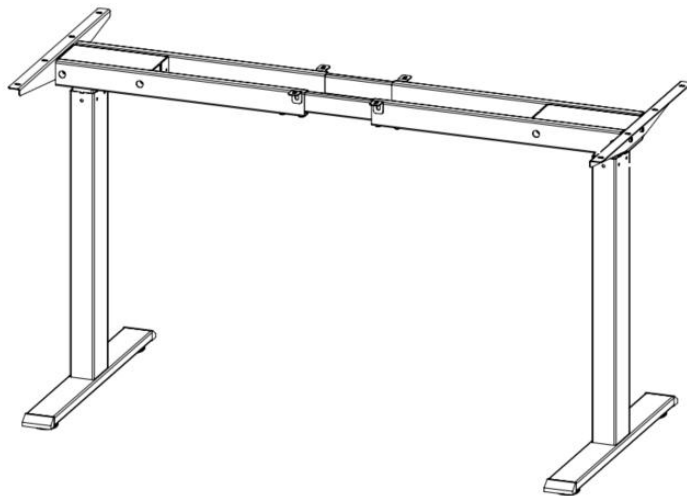

NEED HELP? CONTACT US!

Have product questions? Need technical support? Please feel free to contact us:

Technical Support and E-Warranty Certificate
www.vevor.com/support

This is the original instruction, please read all manual instructions carefully before operating. VEVOR reserves a clear interpretation of our user manual. The appearance of the product shall be subject to the product you received. Please forgive us that we won't inform you again if there are any technology or software updates on our product.

Delarlista



A x 2

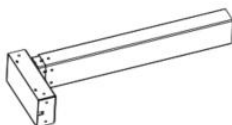

B x 2



C x 2



D x 2



E x 2



F x 2



G x 1



H x 1



J x 1



M x 8



N x 20

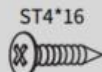

O x 2



P x 2

INSTALLATION

1 Beam installation-Step1

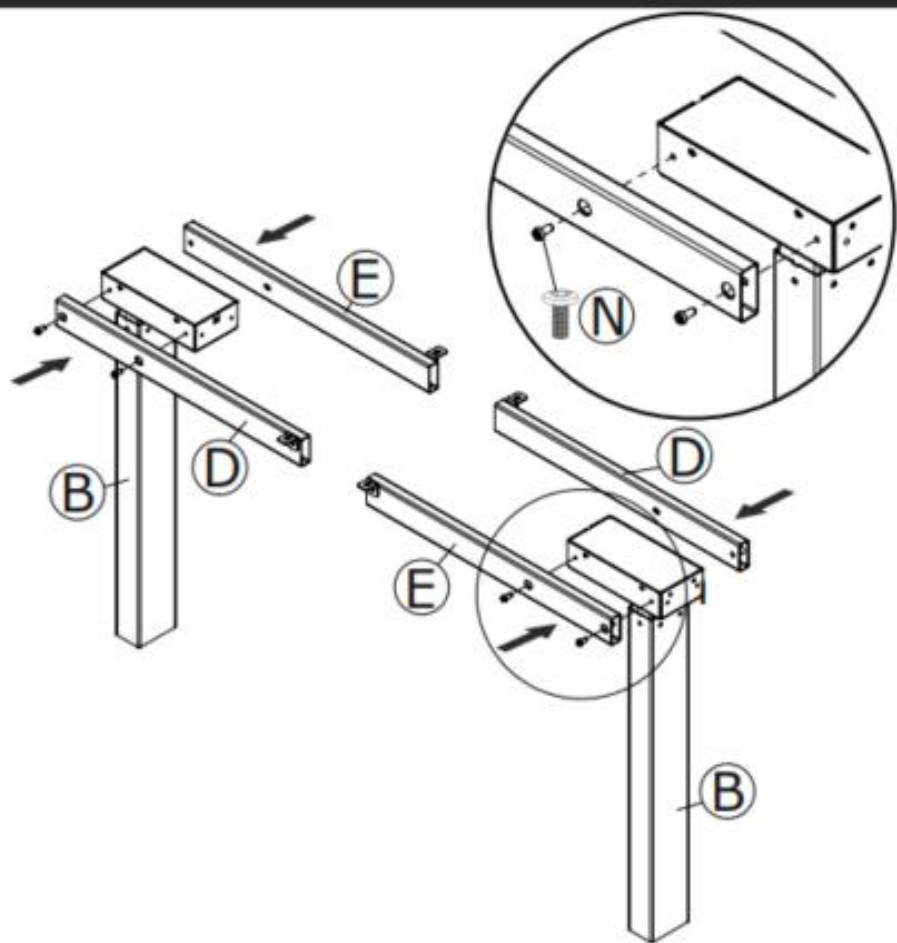

D x 2
E x 2
B x 2

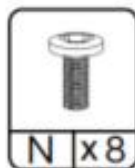

2 Beam installation-Step2

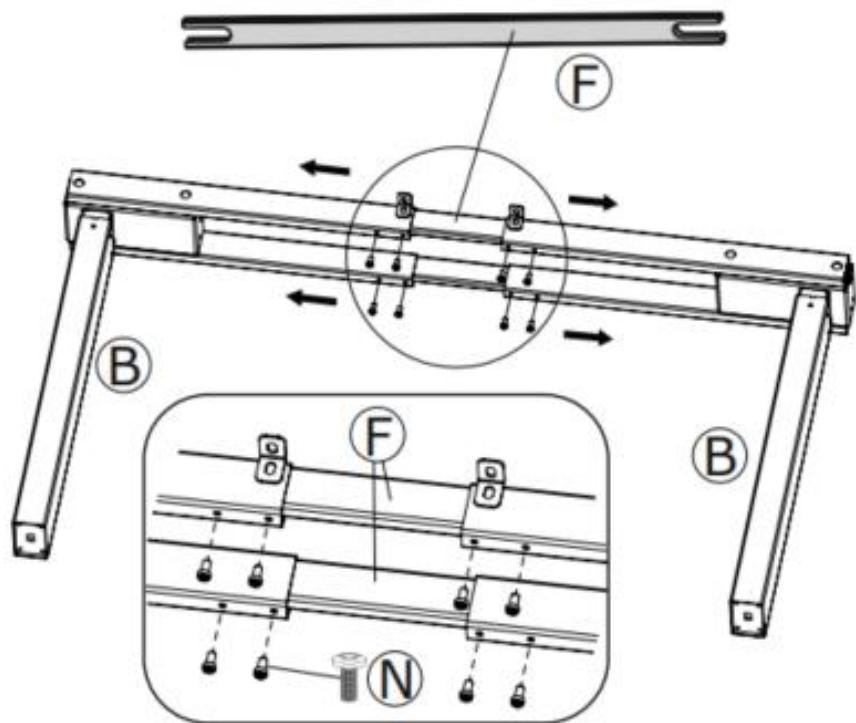

F x 2

N x 8

3 Foot installation

When the ground is uneven, the foot pad can be rotated to achieve balance.

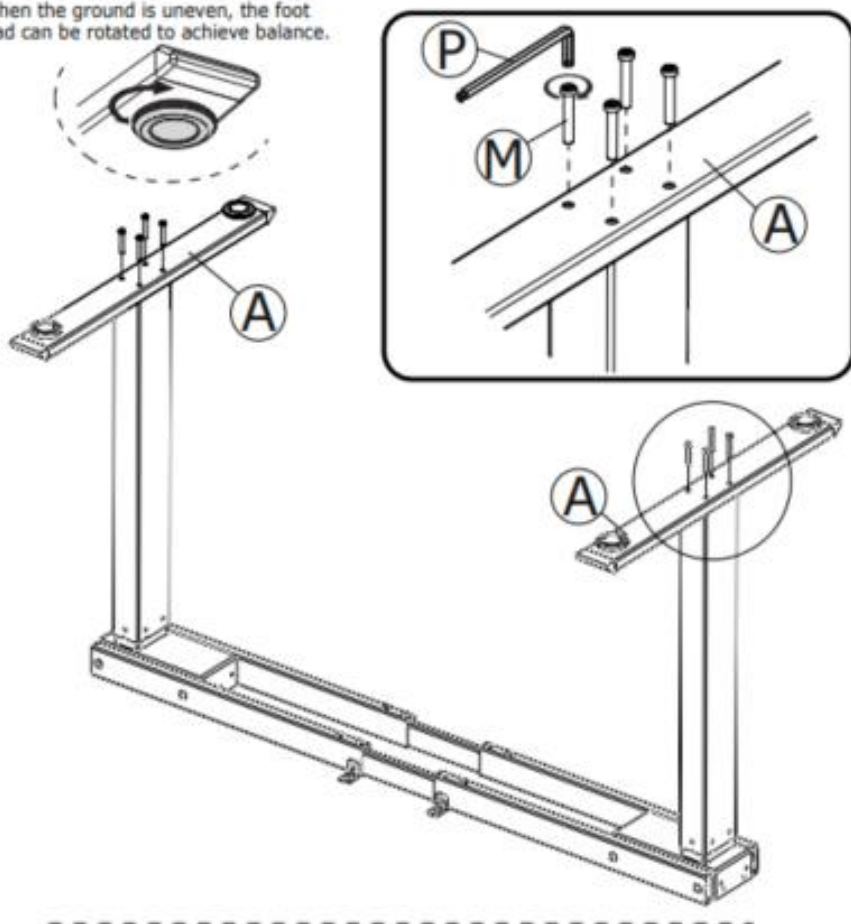

A x 2



4 Side wing installation

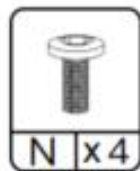
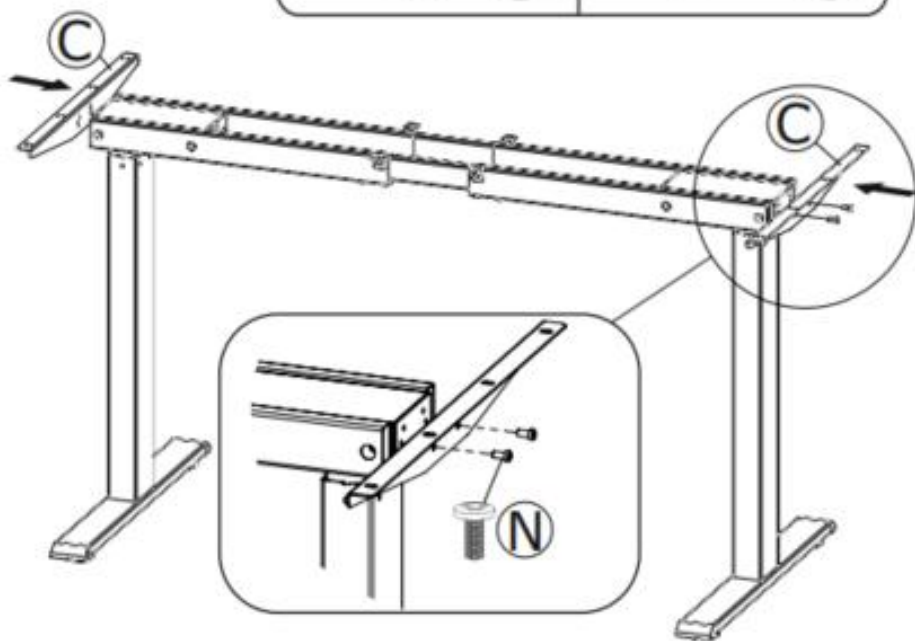
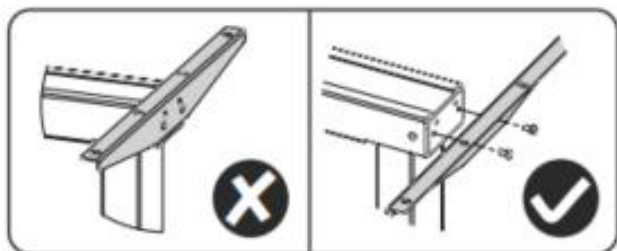

5 Line connection

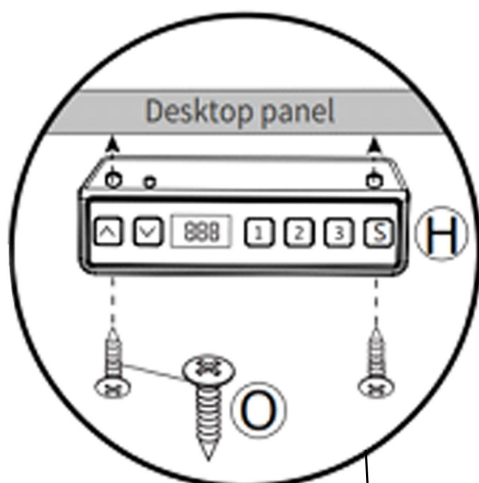

The controller can be fixed to the tabletop

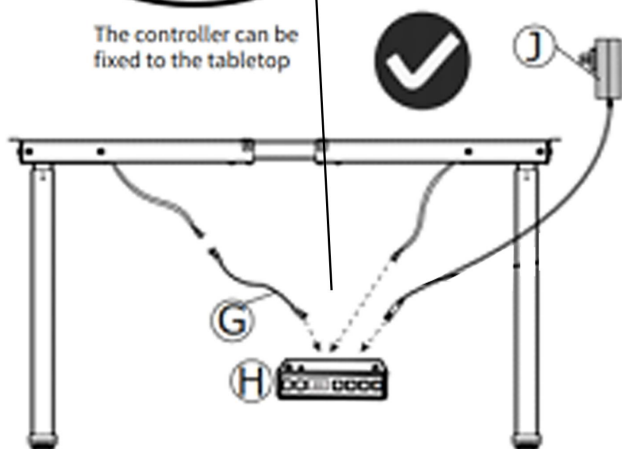







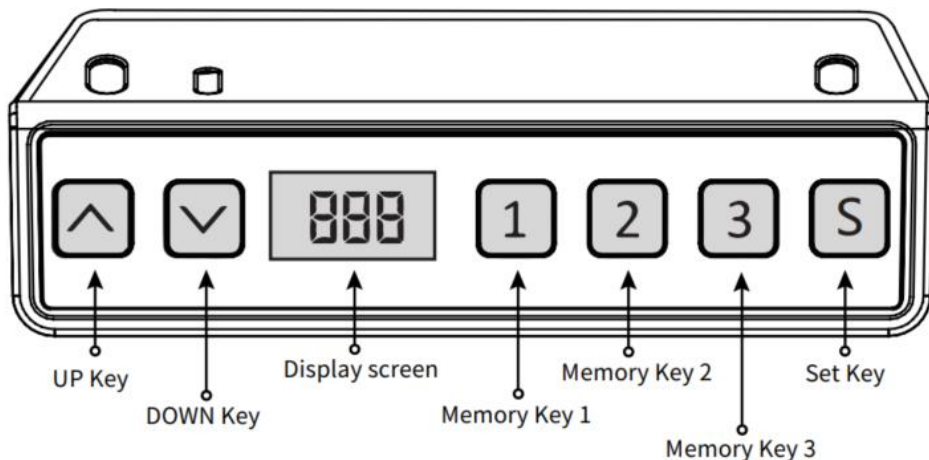

H x 1
J x 1
G x 1





BRUKSANVISNINGAR

Obs: Innan du använder det höj- och sänkbara skrivbordet rekommenderas det att utföra en återställning för att säkerställa att båda lyftpelarna är på samma höjd, eftersom de kan ha svaga variationer från fabriken (se DRIFTSINSTRUKTIONER-Återställ).





-  UP Key ---- Press and hold the " ^ " button to raise the desk.
 -  DOWN Key ---- Press and hold the " v " button to lower the desk.
 -  Display screen ---- Press any button to wake up the LED display.
 -  Memory Key 1 ----
 -  Memory Key 2 ----
 -  Memory Key 3 ----
- The desk can store 3 memory heights (memory 1, 2, and 3).
-  Set Key

Återställa

Tryck länge på "  "-tangenten, efter att ha kört skrivbordet till den lägsta punkten, fortsätt att hålla ned "  "-tangenten tills skärmen visar blinkar " --- " och summern avger ett "pip"-ljud, skärmen visar det lägsta höjdvärdet och återställningsoperationen är framgångsrik.

Lyftfunktionsdrift

När du  trycker på " " -tangents körs skrivbordet uppåt tills det når den högsta punkten på skrivbordet.

När du  trycker på " " -tangents körs skrivbordet ner tills det når den lägsta punkten på skrivbordet.

Minnesposition Lagring/minnesplats Kör

1. Platslagring



Tryck och håll minnesknappen " " , summern avger ett "pip" ljud och skärmen blinkar "S-1" vid

samtidigt, och det aktuella höjdvärdet kommer att visas och minneslagringen kommer att sparas. En summa av 3 höjder kan spelas in samtidigt (tryck och håll minnesknappen " " ,  skärmen blinkar "S-2", tryck och



håll  minnestangenten " " , skärmen blinkar "S-3").



Obs: Om du ställer in minnesplatsen på samma sifferknapp igen och sparar den framgångsrikt, kommer den postlagring som var tidigare inställda av tangenten kommer att skrivas över.

2. Minnespositionsdrift

Tryck kort på "  /  /  "-knappen, displayen blinkar minnespositionens höjd 2 sekunder, skrivbordet körs automatiskt till höjden av minnespositionen, och valfri tangent kan sluta fungera under drift.

3. Lås och lås upp

Lås: Tryck och håll "  " + "  " + "  " samtidigt i 5 sekunder, när displayen visar " L " betyder det att systemet är låst och inte kan lyfta systemet.

Lås upp: Tryck och håll " "  + "  " + "  " samtidigt i 5 sekunder, när det digitala röret visas från "L" till den normala digitala displayen betyder det att systemet har låsts upp.

4. Stillasittande påminnelse (nedräkningsmetod)

Nedräkningstid: 3 stopp, " \uparrow 30" = 30 minuter, " \uparrow 45" = 45 minuter, " \uparrow 60" = 60 minuter.

Start av nedräkning: Tryck på \boxed{S} skärmen " " för att visa " \uparrow 30 / \uparrow 45 / \uparrow 60 " i tur och ordning, så startar nedräkningen.

Avsluta Countdown:

1. Tryck kort på \boxed{S} knappen " ", displayen visar numret och avslutar nedräkningen.

2. När nedräkningstiden är slut kommer displayen att blinka " ",

CLR blinktiden är 1 minut, tryck på valfri knapp för att stoppa timer och avsluta.

3. Efter att nedräkningstiden är slut, om det inte finns någon åtgärd, kommer den automatiskt att lämna timern efter att ha påmint 3 gånger kontinuerligt var 5:e minut.

Fabriksåterställ

Metod: Tryck och håll ned " \uparrow " + " \downarrow " + " $\boxed{3}$ "-knapparna samtidigt i 5 sekunder, och skärmen visar " CLR ", vilket betyder att parametern har återställts .

Metrisk imperial växling

Metrisk (CM-enhet): Tryck länge på " \uparrow " + " $\boxed{3}$ ", efter summern "tick", växlar skärmen till den metriska CM-enheten Imperial (tum som enhet):
Långt tryck på " \downarrow " + " $\boxed{3}$ ", efter summern "tick", kommer skärmen att växla till imperialistiska tumenheter .

Felbeskrivning

Error codes	Description	Resolution
E01	The motor is not connected	Press the up or down button again, if it still persists, please check the column motor connection cable
E02	Motor overcurrent	Press the up or down button again, it still persists, please replace the motor or reduce the load
E03	Motor Hall failure	Press the up or down button again, it still persists, please check the connection or replace the motor
E04	The mains power supply is abnormal	If the cable cannot be eliminated after power failure and reconnection, replace the power supply
E05	The motor current is abnormal	Reconnect the cable after power failure, if it still can't be removed, you need to return it to the factory
E06	The motor power device is bad	Reconnect the cable after power failure, if it still can't be removed, you need to return it to the factory
E09	Motor stalled	Press the up or down button again, it still persists, please replace the motor or reduce the load
H0f	Over-temperature protection	Wait for the temperature to drop, run for 2 minutes, and stop for 18 minutes
r5f	Illegal power outages	Reduce the load or check if the power cable is loose

Parametertabell

Modell	Höjdyft område (centimeter)	Motor	Bordsbensnivå	Längdförlängnings område (centimeter)	Storlek (centimeter)	Bordsskivans längd (Föreslagen storlek)
ZW-13 ZW-14 ZW-15 ZW-16	70-117	2 st	tvåsteg	110-178	110*58*70	L:120-220cm B: 62-80 cm
ZW-17 ZW-18 ZW-19 ZW-20	64-129	2 st	tretegg	110-178	110*58*64	L:120-220cm B: 62-80 cm

Adress: Baoshanqu Shuangchenglu 803long 11hao 1602A-1609shi
Shanghai

Importerad till AUS: SIHAO PTY LTD . 1 ROKEVA STREETEASTWOOD
NSW 2122 Australien

Importerad till USA: Sanven Technology Ltd. Suite 250, 9166 Anaheim
Place, Rancho Cucamonga, CA 91730



SHUNSHUN GmbH
Römeräcker 9 Z2021,76351
Linkenheim-Hochstetten, Germany



Pooledas Group Ltd
Unit 5 Albert Edward House, The Pavilions
Preston, United Kingdom

Tillverkad i Kina

VEVOR[®]

TOUGH TOOLS, HALF PRICE

Teknisk Support och e-garanticertifikat

www.vevor.com/support