

# **VEVOR<sup>®</sup>**

**TOUGH TOOLS, HALF PRICE**

Technical Support and E-Warranty Certificate

[www.vevor.com/support](http://www.vevor.com/support)

## **Outdoor Wall-mounted Handrail**

**MODEL:HR-03-29-2**

We continue to be committed to provide you tools with competitive price.

"Save Half", "Half Price" or any other similar expressions used by us only represents an estimate of savings you might benefit from buying certain tools with us compared to the major top brands and does not necessarily mean to cover all categories of tools offered by us. You are kindly reminded to verify carefully when you are placing an order with us if you are actually saving half in comparison with the top major brands.

# VEVOR®

TOUGH TOOLS, HALF PRICE

## Outdoor Wall-mounted Handrail

MODEL: HR-03-29-2

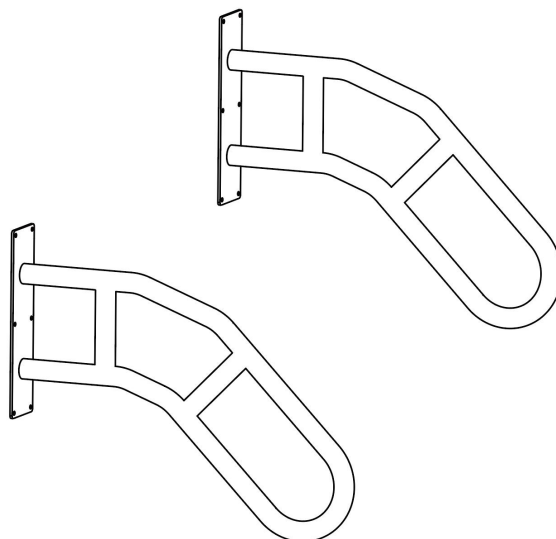

### NEED HELP? CONTACT US!

Have product questions? Need technical support? Please feel free to contact us:

**Technical Support and E-Warranty Certificate**  
[www.vevor.com/support](http://www.vevor.com/support)

This is the original instruction, please read all manual instructions carefully before operating. VEVOR reserves a clear interpretation of our user manual. The appearance of the product shall be subject to the product you received. Please forgive us that we won't inform you again if there are any technology or software updates on our product.

## SAFE INSTRUCTIONS

**CAUTION:** carefully read instructions and procedures for safe operations. Failure to do so can result in serious injury.







### **WARNING:**

1. Before using the handrail, ensure that the handrail is securely installed to prevent personal injury and accidents.
2. When using the handrail, do not overload the handrail to avoid personal injury or accident.
3. Do not draw, cut, or use sharp objects on the handrail to avoid damage.
4. If you need to disassemble the handrail, please follow the reverse steps to disassemble it and store it properly.
5. This product is not a toy. Do not allow children to play with this item.

### **Assembly precautions**

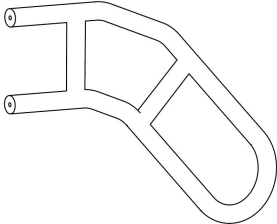
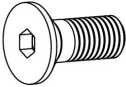
1. Assemble only according to these instructions. Improper assembly can create hazards.
2. Wear ANSI-approved safety goggles and heavy-duty work gloves during assembly.
3. Keep assembly area clean and well lit.
4. Keep bystanders out of the area during assembly.
5. Do not assemble when tired or when under the influence of alcohol, drug or medication.
6. Product capabilities apply to properly and completely assembled product only.
7. For additional information regarding the parts listed in the following pages, please refer to the Assembly Diagram of this manual. Unwrap and separate all parts in a clean work area.
8. For safety reasons, This hardware is recommended to be installed by 2 people

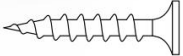
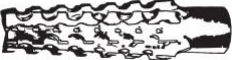
**SAVE THESE INSTRUCTIONS**

Part List			
NO.	Name	Picture	Qty.
A	Baseplate		2
B	Handrail		2
C	Screw		4
D	Drill Bit		1
E	Screw		12
F	Expansion Tube		12
G	Wrench		1

# Product Installation

## Step 1:

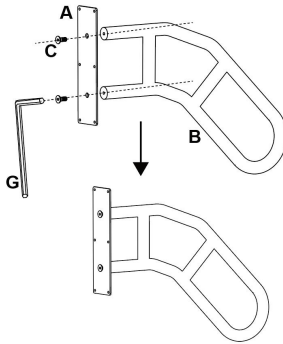

Secure A and B with an Allen wrench.

## Step 2:

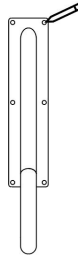

Use the C bracket to place on the wall to draw the locating circle.

## Step 3:

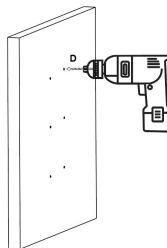

Drill holes in the locating ring.

#### Step 4:

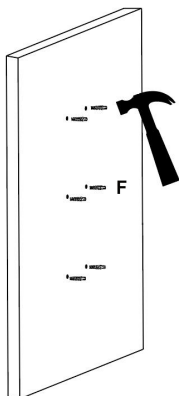

Set the expansion screws into the pre-drilled holes. Tap the wall with a hammer.

#### Step 5:

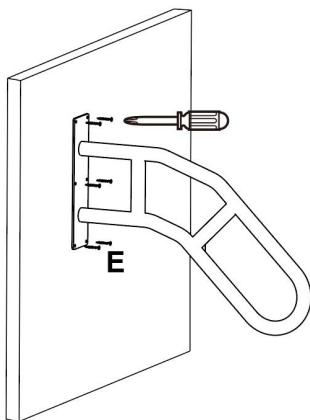

Just align the C with the holes, put the screws on and tighten them.

**Manufacturer:** Shanghaimuxinmuyeyouxiangongsi

**Address:** Shuangchenglu 803nong11hao1602A-1609shi, baoshanqu, shanghai 200000 CN.

**Imported to AUS:** SIHAO PTY LTD. 1 ROKEVA STREETEASTWOOD NSW 2122 Australia

**Imported to USA:** Sanven Technology Ltd. Suite 250, 9166 Anaheim Place, Rancho Cucamonga, CA 91730



YH CONSULTING LIMITED.  
C/O YH Consulting Limited Office 147,  
Centurion House, London Road,  
Staines-upon-Thames, Surrey, TW18 4AX



E-CrossStu GmbH  
Mainzer Landstr.69,  
60329 Frankfurt am Main.

**VEVOR<sup>®</sup>**

**TOUGH TOOLS, HALF PRICE**

Technical Support and E-Warranty Certificate

[www.vevor.com/support](http://www.vevor.com/support)



# **VEVOR<sup>®</sup>**

**TOUGH TOOLS, HALF PRICE**

Technical Support and E-Warranty Certificate

[www.vevor.com/support](http://www.vevor.com/support)

## **Outdoor Wall-mounted Handrail**

**MODEL:HR-03-29-2**

We continue to be committed to provide you tools with competitive price.

"Save Half", "Half Price" or any other similar expressions used by us only represents an estimate of savings you might benefit from buying certain tools with us compared to the major top brands and does not necessarily mean to cover all categories of tools offered by us. You are kindly reminded to verify carefully when you are placing an order with us if you are actually saving half in comparison with the top major brands.

# VEVOR®

TOUGH TOOLS, HALF PRICE

## Outdoor Wall-mounted Handrail

MODEL: HR-03-29-2

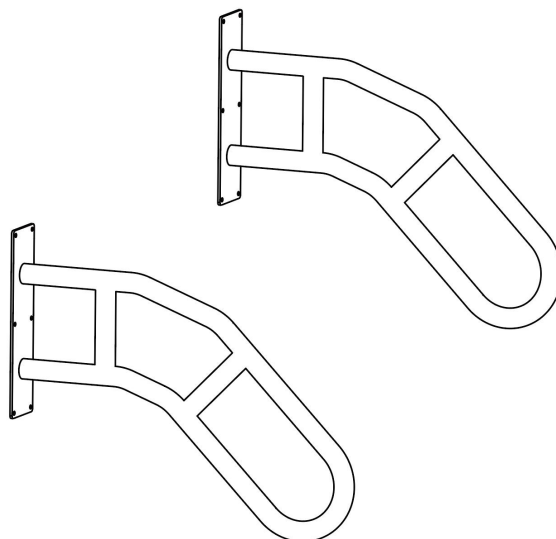

### NEED HELP? CONTACT US!

Have product questions? Need technical support? Please feel free to contact us:

**Technical Support and E-Warranty Certificate**  
**[www.vevor.com/support](http://www.vevor.com/support)**

This is the original instruction, please read all manual instructions carefully before operating. VEVOR reserves a clear interpretation of our user manual. The appearance of the product shall be subject to the product you received. Please forgive us that we won't inform you again if there are any technology or software updates on our product.

## SAFE INSTRUCTIONS

**CAUTION:** carefully read instructions and procedures for safe operations. Failure to do so can result in serious injury.







### **WARNING:**

1. Before using the handrail, ensure that the handrail is securely installed to prevent personal injury and accidents.
2. When using the handrail, do not overload the handrail to avoid personal injury or accident.
3. Do not draw, cut, or use sharp objects on the handrail to avoid damage.
4. If you need to disassemble the handrail, please follow the reverse steps to disassemble it and store it properly.
5. This product is not a toy. Do not allow children to play with this item.

### **Assembly precautions**

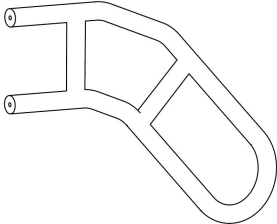
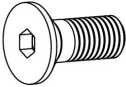
1. Assemble only according to these instructions. Improper assembly can create hazards.
2. Wear ANSI-approved safety goggles and heavy-duty work gloves during assembly.
3. Keep assembly area clean and well lit.
4. Keep bystanders out of the area during assembly.
5. Do not assemble when tired or when under the influence of alcohol, drug or medication.
6. Product capabilities apply to properly and completely assembled product only.
7. For additional information regarding the parts listed in the following pages, please refer to the Assembly Diagram of this manual. Unwrap and separate all parts in a clean work area.
8. For safety reasons, This hardware is recommended to be installed by 2 people

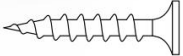
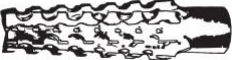
**SAVE THESE INSTRUCTIONS**

Part List			
NO.	Name	Picture	Qty.
A	Baseplate		2
B	Handrail		2
C	Screw		4
D	Drill Bit		1
E	Screw		12
F	Expansion Tube		12
G	Wrench		1

# Product Installation

## Step 1:

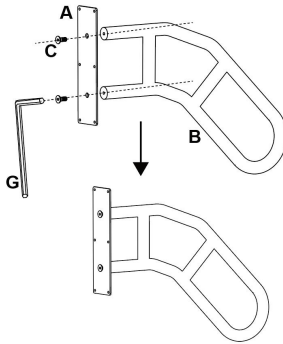

Secure A and B with an Allen wrench.

## Step 2:

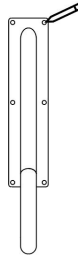

Use the C bracket to place on the wall to draw the locating circle.

## Step 3:

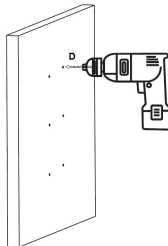

Drill holes in the locating ring.

#### Step 4:

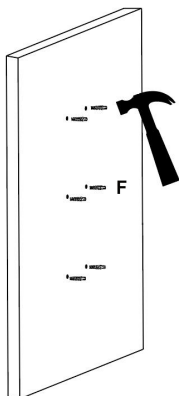

Set the expansion screws into the pre-drilled holes. Tap the wall with a hammer.

#### Step 5:

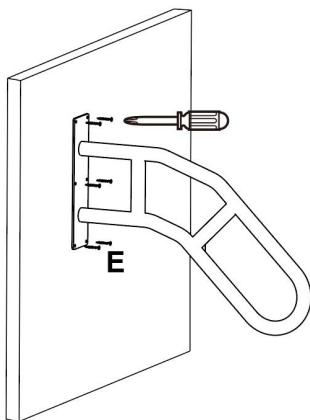

Just align the C with the holes, put the screws on and tighten them.

**Manufacturer:** Shanghaimuxinmuyeyouxiangongsi

**Address:** Shuangchenglu 803nong11hao1602A-1609shi, baoshanqu, shanghai 200000 CN.

**Imported to AUS:** SIHAO PTY LTD. 1 ROKEVA STREETEASTWOOD NSW 2122 Australia

**Imported to USA:** Sanven Technology Ltd. Suite 250, 9166 Anaheim Place, Rancho Cucamonga, CA 91730



YH CONSULTING LIMITED.  
C/O YH Consulting Limited Office 147,  
Centurion House, London Road,  
Staines-upon-Thames, Surrey, TW18 4AX



E-CrossStu GmbH  
Mainzer Landstr.69,  
60329 Frankfurt am Main.

**VEVOR<sup>®</sup>**

**TOUGH TOOLS, HALF PRICE**

Technical Support and E-Warranty Certificate

[www.vevor.com/support](http://www.vevor.com/support)



# **VEVOR<sup>®</sup>**

**TOUGH TOOLS, HALF PRICE**

Technical Support and E-Warranty Certificate

[www.vevor.com/support](http://www.vevor.com/support)

## **Outdoor Wall-mounted Handrail**

**MODEL:HR-03-29-2**

We continue to be committed to provide you tools with competitive price.

"Save Half", "Half Price" or any other similar expressions used by us only represents an estimate of savings you might benefit from buying certain tools with us compared to the major top brands and does not necessarily mean to cover all categories of tools offered by us. You are kindly reminded to verify carefully when you are placing an order with us if you are actually saving half in comparison with the top major brands.

# VEVOR®

TOUGH TOOLS, HALF PRICE

## Outdoor Wall-mounted Handrail

MODEL: HR-03-29-2

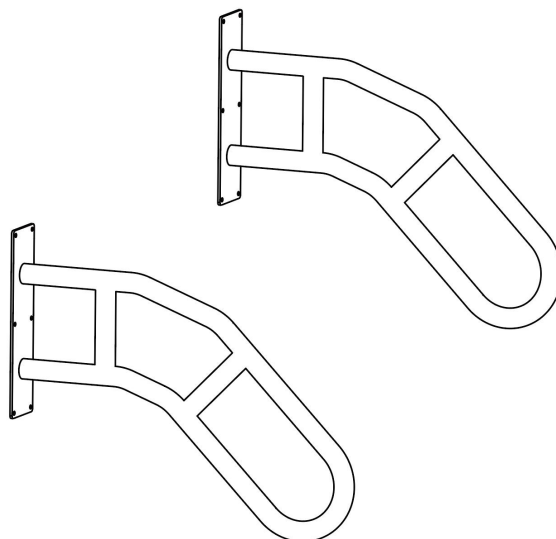

### NEED HELP? CONTACT US!

Have product questions? Need technical support? Please feel free to contact us:

**Technical Support and E-Warranty Certificate**  
[www.vevor.com/support](http://www.vevor.com/support)

This is the original instruction, please read all manual instructions carefully before operating. VEVOR reserves a clear interpretation of our user manual. The appearance of the product shall be subject to the product you received. Please forgive us that we won't inform you again if there are any technology or software updates on our product.

## SAFE INSTRUCTIONS

**CAUTION:** carefully read instructions and procedures for safe operations. Failure to do so can result in serious injury.







### **WARNING:**

1. Before using the handrail, ensure that the handrail is securely installed to prevent personal injury and accidents.
2. When using the handrail, do not overload the handrail to avoid personal injury or accident.
3. Do not draw, cut, or use sharp objects on the handrail to avoid damage.
4. If you need to disassemble the handrail, please follow the reverse steps to disassemble it and store it properly.
5. This product is not a toy. Do not allow children to play with this item.

### **Assembly precautions**

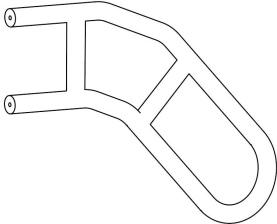
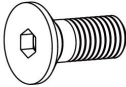
1. Assemble only according to these instructions. Improper assembly can create hazards.
2. Wear ANSI-approved safety goggles and heavy-duty work gloves during assembly.
3. Keep assembly area clean and well lit.
4. Keep bystanders out of the area during assembly.
5. Do not assemble when tired or when under the influence of alcohol, drug or medication.
6. Product capabilities apply to properly and completely assembled product only.
7. For additional information regarding the parts listed in the following pages, please refer to the Assembly Diagram of this manual. Unwrap and separate all parts in a clean work area.
8. For safety reasons, This hardware is recommended to be installed by 2 people

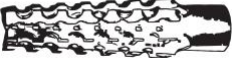
**SAVE THESE INSTRUCTIONS**

Part List			
NO.	Name	Picture	Qty.
A	Baseplate		2
B	Handrail		2
C	Screw		4
D	Drill Bit		1
E	Screw		12
F	Expansion Tube		12
G	Wrench		1

# Product Installation

## Step 1:

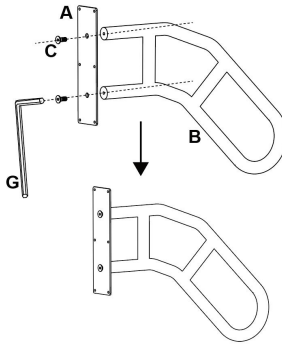

Secure A and B with an Allen wrench.

## Step 2:

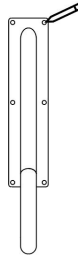

Use the C bracket to place on the wall to draw the locating circle.

## Step 3:

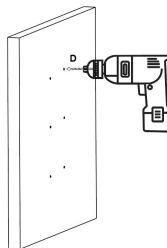

Drill holes in the locating ring.

#### Step 4:

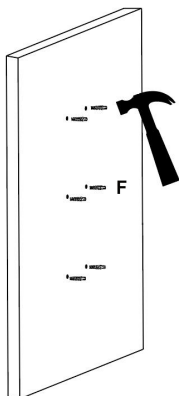

Set the expansion screws into the pre-drilled holes. Tap the wall with a hammer.

#### Step 5:

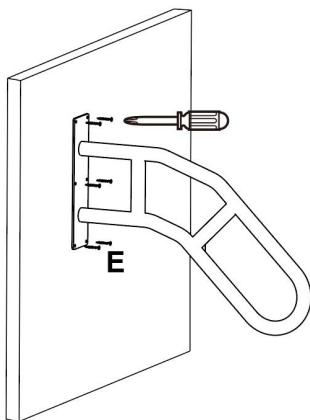

Just align the C with the holes, put the screws on and tighten them.

**Manufacturer:** Shanghai muxinmuyeyouxiangongsi

**Address:** Shuangchenglu 803nong11hao1602A-1609shi, baoshanqu, shanghai 200000 CN.

**Imported to AUS:** SIHAO PTY LTD. 1 ROKEVA STREET EASTWOOD NSW 2122 Australia

**Imported to USA:** Sanven Technology Ltd. Suite 250, 9166 Anaheim Place, Rancho Cucamonga, CA 91730



YH CONSULTING LIMITED.  
C/O YH Consulting Limited Office 147,  
Centurion House, London Road,  
Staines-upon-Thames, Surrey, TW18 4AX



E-CrossStu GmbH  
Mainzer Landstr.69,  
60329 Frankfurt am Main.

**VEVOR<sup>®</sup>**

**TOUGH TOOLS, HALF PRICE**

Technical Support and E-Warranty Certificate

[www.vevor.com/support](http://www.vevor.com/support)



# **VEVOR<sup>®</sup>**

**TOUGH TOOLS, HALF PRICE**

Technical Support and E-Warranty Certificate

[www.vevor.com/support](http://www.vevor.com/support)

## **Outdoor Wall-mounted Handrail**

**MODEL:HR-03-29-2**

We continue to be committed to provide you tools with competitive price.

"Save Half", "Half Price" or any other similar expressions used by us only represents an estimate of savings you might benefit from buying certain tools with us compared to the major top brands and does not necessarily mean to cover all categories of tools offered by us. You are kindly reminded to verify carefully when you are placing an order with us if you are actually saving half in comparison with the top major brands.

# VEVOR<sup>®</sup>

TOUGH TOOLS, HALF PRICE

## Outdoor Wall-mounted Handrail

MODEL: HR-03-29-2

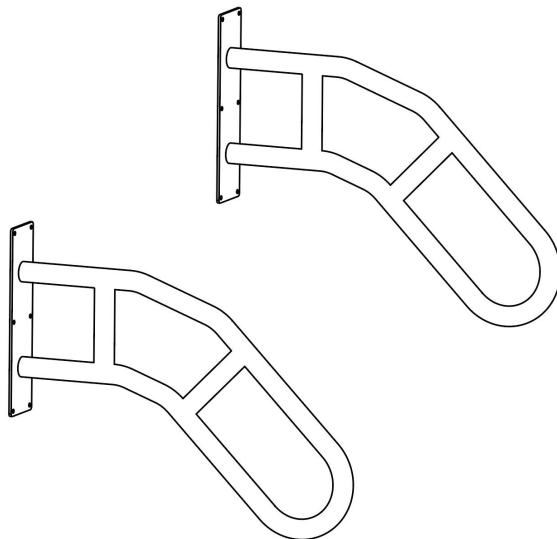

### NEED HELP? CONTACT US!

Have product questions? Need technical support? Please feel free to contact us:

**Technical Support and E-Warranty Certificate**  
[www.vevor.com/support](http://www.vevor.com/support)

This is the original instruction, please read all manual instructions carefully before operating. VEVOR reserves a clear interpretation of our user manual. The appearance of the product shall be subject to the product you received. Please forgive us that we won't inform you again if there are any technology or software updates on our product.

## SAFE INSTRUCTIONS

**CAUTION:** carefully read instructions and procedures for safe operations. Failure to do so can result in serious injury.







### **WARNING:**

1. Before using the handrail, ensure that the handrail is securely installed to prevent personal injury and accidents.
2. When using the handrail, do not overload the handrail to avoid personal injury or accident.
3. Do not draw, cut, or use sharp objects on the handrail to avoid damage.
4. If you need to disassemble the handrail, please follow the reverse steps to disassemble it and store it properly.
5. This product is not a toy. Do not allow children to play with this item.

### **Assembly precautions**

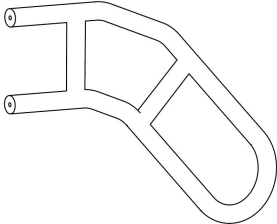
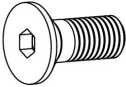
1. Assemble only according to these instructions. Improper assembly can create hazards.
2. Wear ANSI-approved safety goggles and heavy-duty work gloves during assembly.
3. Keep assembly area clean and well lit.
4. Keep bystanders out of the area during assembly.
5. Do not assemble when tired or when under the influence of alcohol, drug or medication.
6. Product capabilities apply to properly and completely assembled product only.
7. For additional information regarding the parts listed in the following pages, please refer to the Assembly Diagram of this manual. Unwrap and separate all parts in a clean work area.
8. For safety reasons, This hardware is recommended to be installed by 2 people

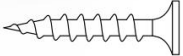
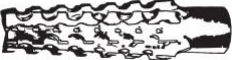
**SAVE THESE INSTRUCTIONS**

Part List			
NO.	Name	Picture	Qty.
A	Baseplate		2
B	Handrail		2
C	Screw		4
D	Drill Bit		1
E	Screw		12
F	Expansion Tube		12
G	Wrench		1

# Product Installation

## Step 1:

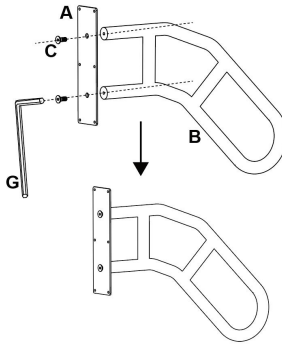

Secure A and B with an Allen wrench.

## Step 2:

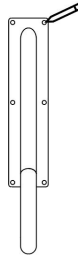

Use the C bracket to place on the wall to draw the locating circle.

## Step 3:

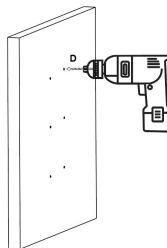

Drill holes in the locating ring.

#### Step 4:

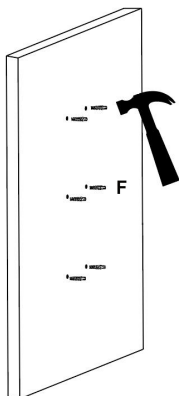

Set the expansion screws into the pre-drilled holes. Tap the wall with a hammer.

#### Step 5:

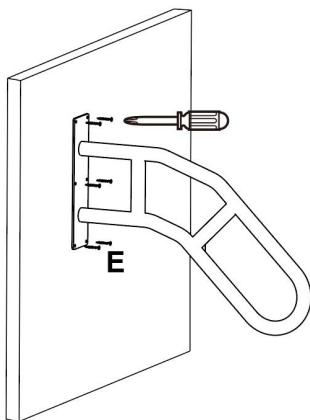

Just align the C with the holes, put the screws on and tighten them.

**Manufacturer:** Shanghaimuxinmuyeyouxiangongsi

**Address:** Shuangchenglu 803nong11hao1602A-1609shi, baoshanqu, shanghai 200000 CN.

**Imported to AUS:** SIHAO PTY LTD. 1 ROKEVA STREETEASTWOOD NSW 2122 Australia

**Imported to USA:** Sanven Technology Ltd. Suite 250, 9166 Anaheim Place, Rancho Cucamonga, CA 91730



YH CONSULTING LIMITED.  
C/O YH Consulting Limited Office 147,  
Centurion House, London Road,  
Staines-upon-Thames, Surrey, TW18 4AX



E-CrossStu GmbH  
Mainzer Landstr.69,  
60329 Frankfurt am Main.

**VEVOR<sup>®</sup>**

**TOUGH TOOLS, HALF PRICE**

Technical Support and E-Warranty Certificate

[www.vevor.com/support](http://www.vevor.com/support)



# **VEVOR<sup>®</sup>**

**TOUGH TOOLS, HALF PRICE**

Technical Support and E-Warranty Certificate

[www.vevor.com/support](http://www.vevor.com/support)

## **Outdoor Wall-mounted Handrail**

**MODEL:HR-03-29-2**

We continue to be committed to provide you tools with competitive price.

"Save Half", "Half Price" or any other similar expressions used by us only represents an estimate of savings you might benefit from buying certain tools with us compared to the major top brands and does not necessarily mean to cover all categories of tools offered by us. You are kindly reminded to verify carefully when you are placing an order with us if you are actually saving half in comparison with the top major brands.

# VEVOR<sup>®</sup>

TOUGH TOOLS, HALF PRICE

## Outdoor Wall-mounted Handrail

MODEL: HR-03-29-2

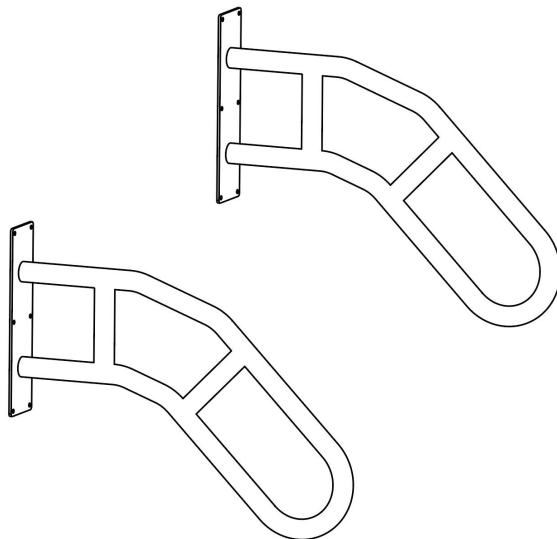

### NEED HELP? CONTACT US!

Have product questions? Need technical support? Please feel free to contact us:

**Technical Support and E-Warranty Certificate**  
[www.vevor.com/support](http://www.vevor.com/support)

This is the original instruction, please read all manual instructions carefully before operating. VEVOR reserves a clear interpretation of our user manual. The appearance of the product shall be subject to the product you received. Please forgive us that we won't inform you again if there are any technology or software updates on our product.

## SAFE INSTRUCTIONS

**CAUTION:** carefully read instructions and procedures for safe operations. Failure to do so can result in serious injury.







### **WARNING:**

1. Before using the handrail, ensure that the handrail is securely installed to prevent personal injury and accidents.
2. When using the handrail, do not overload the handrail to avoid personal injury or accident.
3. Do not draw, cut, or use sharp objects on the handrail to avoid damage.
4. If you need to disassemble the handrail, please follow the reverse steps to disassemble it and store it properly.
5. This product is not a toy. Do not allow children to play with this item.

### **Assembly precautions**

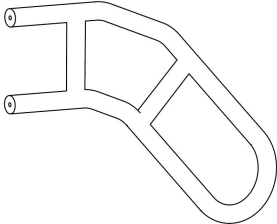
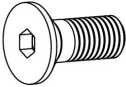
1. Assemble only according to these instructions. Improper assembly can create hazards.
2. Wear ANSI-approved safety goggles and heavy-duty work gloves during assembly.
3. Keep assembly area clean and well lit.
4. Keep bystanders out of the area during assembly.
5. Do not assemble when tired or when under the influence of alcohol, drug or medication.
6. Product capabilities apply to properly and completely assembled product only.
7. For additional information regarding the parts listed in the following pages, please refer to the Assembly Diagram of this manual. Unwrap and separate all parts in a clean work area.
8. For safety reasons, This hardware is recommended to be installed by 2 people

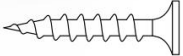
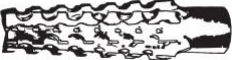
**SAVE THESE INSTRUCTIONS**

Part List			
NO.	Name	Picture	Qty.
A	Baseplate		2
B	Handrail		2
C	Screw		4
D	Drill Bit		1
E	Screw		12
F	Expansion Tube		12
G	Wrench		1

# Product Installation

## Step 1:

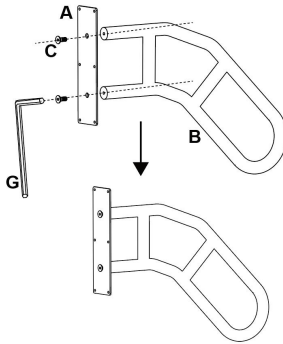

Secure A and B with an Allen wrench.

## Step 2:

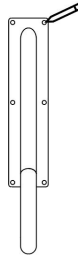

Use the C bracket to place on the wall to draw the locating circle.

## Step 3:

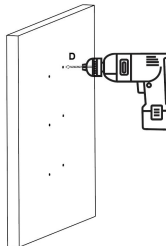

Drill holes in the locating ring.

#### Step 4:

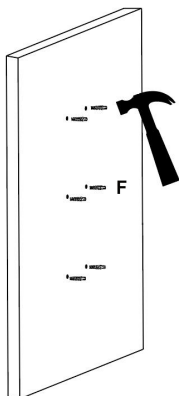

Set the expansion screws into the pre-drilled holes. Tap the wall with a hammer.

#### Step 5:

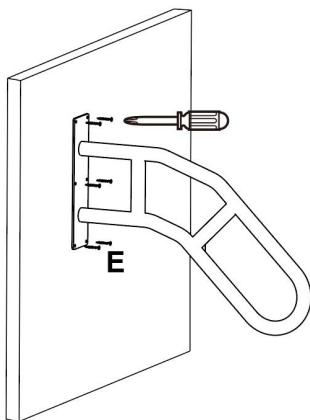

Just align the C with the holes, put the screws on and tighten them.

**Manufacturer:** Shanghaimuxinmuyeyouxiangongsi

**Address:** Shuangchenglu 803nong11hao1602A-1609shi, baoshanqu, shanghai 200000 CN.

**Imported to AUS:** SIHAO PTY LTD. 1 ROKEVA STREETEASTWOOD NSW 2122 Australia

**Imported to USA:** Sanven Technology Ltd. Suite 250, 9166 Anaheim Place, Rancho Cucamonga, CA 91730



YH CONSULTING LIMITED.  
C/O YH Consulting Limited Office 147,  
Centurion House, London Road,  
Staines-upon-Thames, Surrey, TW18 4AX



E-CrossStu GmbH  
Mainzer Landstr.69,  
60329 Frankfurt am Main.

**VEVOR<sup>®</sup>**

**TOUGH TOOLS, HALF PRICE**

Technical Support and E-Warranty Certificate

[www.vevor.com/support](http://www.vevor.com/support)



# **VEVOR<sup>®</sup>**

**TOUGH TOOLS, HALF PRICE**

Technical Support and E-Warranty Certificate

[www.vevor.com/support](http://www.vevor.com/support)

## **Outdoor Wall-mounted Handrail**

**MODEL:HR-03-29-2**

We continue to be committed to provide you tools with competitive price.

"Save Half", "Half Price" or any other similar expressions used by us only represents an estimate of savings you might benefit from buying certain tools with us compared to the major top brands and does not necessarily mean to cover all categories of tools offered by us. You are kindly reminded to verify carefully when you are placing an order with us if you are actually saving half in comparison with the top major brands.

# VEVOR<sup>®</sup>

TOUGH TOOLS, HALF PRICE

## Outdoor Wall-mounted Handrail

MODEL: HR-03-29-2

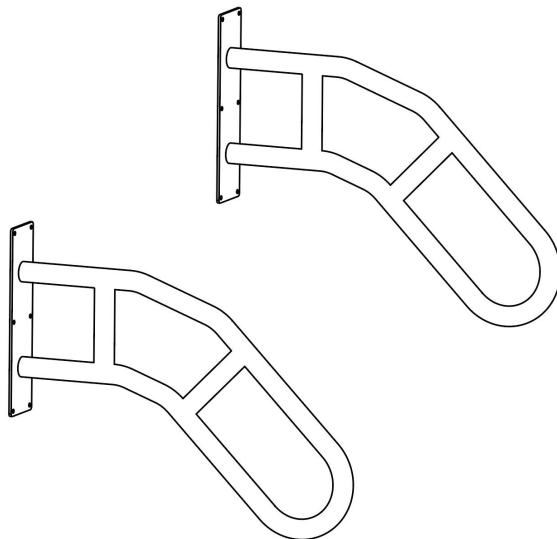

### NEED HELP? CONTACT US!

Have product questions? Need technical support? Please feel free to contact us:

**Technical Support and E-Warranty Certificate**  
[www.vevor.com/support](http://www.vevor.com/support)

This is the original instruction, please read all manual instructions carefully before operating. VEVOR reserves a clear interpretation of our user manual. The appearance of the product shall be subject to the product you received. Please forgive us that we won't inform you again if there are any technology or software updates on our product.

## SAFE INSTRUCTIONS

**CAUTION:** carefully read instructions and procedures for safe operations. Failure to do so can result in serious injury.







### **WARNING:**

1. Before using the handrail, ensure that the handrail is securely installed to prevent personal injury and accidents.
2. When using the handrail, do not overload the handrail to avoid personal injury or accident.
3. Do not draw, cut, or use sharp objects on the handrail to avoid damage.
4. If you need to disassemble the handrail, please follow the reverse steps to disassemble it and store it properly.
5. This product is not a toy. Do not allow children to play with this item.

### **Assembly precautions**

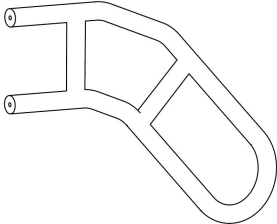
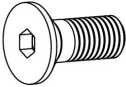
1. Assemble only according to these instructions. Improper assembly can create hazards.
2. Wear ANSI-approved safety goggles and heavy-duty work gloves during assembly.
3. Keep assembly area clean and well lit.
4. Keep bystanders out of the area during assembly.
5. Do not assemble when tired or when under the influence of alcohol, drug or medication.
6. Product capabilities apply to properly and completely assembled product only.
7. For additional information regarding the parts listed in the following pages, please refer to the Assembly Diagram of this manual. Unwrap and separate all parts in a clean work area.
8. For safety reasons, This hardware is recommended to be installed by 2 people

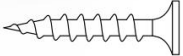
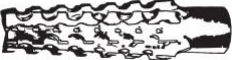
**SAVE THESE INSTRUCTIONS**

Part List			
NO.	Name	Picture	Qty.
A	Baseplate		2
B	Handrail		2
C	Screw		4
D	Drill Bit		1
E	Screw		12
F	Expansion Tube		12
G	Wrench		1

# Product Installation

## Step 1:

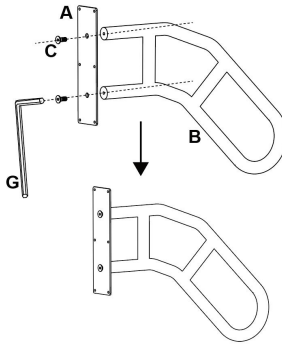

Secure A and B with an Allen wrench.

## Step 2:

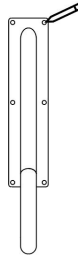

Use the C bracket to place on the wall to draw the locating circle.

## Step 3:

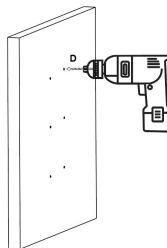

Drill holes in the locating ring.

**Step 4:**

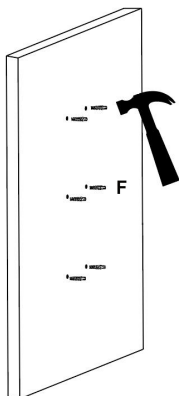

Set the expansion screws into the pre-drilled holes. Tap the wall with a hammer.

**Step 5:**

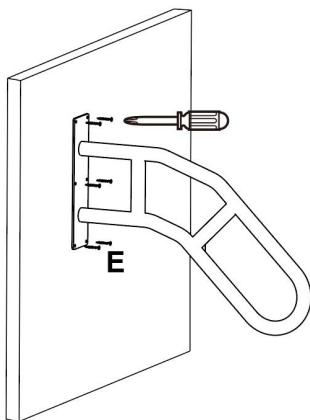

Just align the C with the holes, put the screws on and tighten them.

**Manufacturer:** Shanghai muxinmuyeyouxiangongsi

**Address:** Shuangchenglu 803nong11hao1602A-1609shi, baoshanqu, shanghai 200000 CN.

**Imported to AUS:** SIHAO PTY LTD. 1 ROKEVA STREET EASTWOOD NSW 2122 Australia

**Imported to USA:** Sanven Technology Ltd. Suite 250, 9166 Anaheim Place, Rancho Cucamonga, CA 91730



YH CONSULTING LIMITED.  
C/O YH Consulting Limited Office 147,  
Centurion House, London Road,  
Staines-upon-Thames, Surrey, TW18 4AX



E-CrossStu GmbH  
Mainzer Landstr.69,  
60329 Frankfurt am Main.

**VEVOR<sup>®</sup>**

**TOUGH TOOLS, HALF PRICE**

Technical Support and E-Warranty Certificate

[www.vevor.com/support](http://www.vevor.com/support)



# **VEVOR<sup>®</sup>**

**TOUGH TOOLS, HALF PRICE**

Technical Support and E-Warranty Certificate

[www.vevor.com/support](http://www.vevor.com/support)

## **Outdoor Wall-mounted Handrail**

**MODEL:HR-03-29-2**

We continue to be committed to provide you tools with competitive price.

"Save Half", "Half Price" or any other similar expressions used by us only represents an estimate of savings you might benefit from buying certain tools with us compared to the major top brands and does not necessarily mean to cover all categories of tools offered by us. You are kindly reminded to verify carefully when you are placing an order with us if you are actually saving half in comparison with the top major brands.

# VEVOR<sup>®</sup>

TOUGH TOOLS, HALF PRICE

## Outdoor Wall-mounted Handrail

MODEL: HR-03-29-2

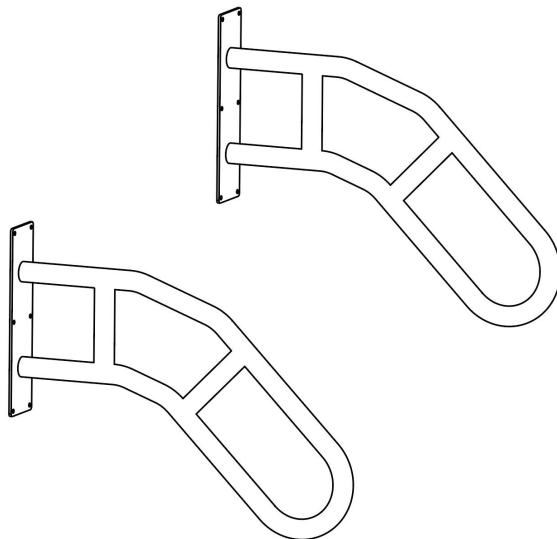

### NEED HELP? CONTACT US!

Have product questions? Need technical support? Please feel free to contact us:

**Technical Support and E-Warranty Certificate**  
[www.vevor.com/support](http://www.vevor.com/support)

This is the original instruction, please read all manual instructions carefully before operating. VEVOR reserves a clear interpretation of our user manual. The appearance of the product shall be subject to the product you received. Please forgive us that we won't inform you again if there are any technology or software updates on our product.

## SAFE INSTRUCTIONS

**CAUTION:** carefully read instructions and procedures for safe operations. Failure to do so can result in serious injury.







### **WARNING:**

1. Before using the handrail, ensure that the handrail is securely installed to prevent personal injury and accidents.
2. When using the handrail, do not overload the handrail to avoid personal injury or accident.
3. Do not draw, cut, or use sharp objects on the handrail to avoid damage.
4. If you need to disassemble the handrail, please follow the reverse steps to disassemble it and store it properly.
5. This product is not a toy. Do not allow children to play with this item.

### **Assembly precautions**

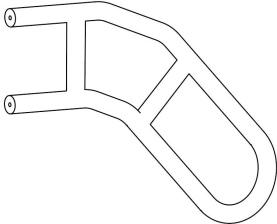
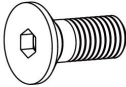
1. Assemble only according to these instructions. Improper assembly can create hazards.
2. Wear ANSI-approved safety goggles and heavy-duty work gloves during assembly.
3. Keep assembly area clean and well lit.
4. Keep bystanders out of the area during assembly.
5. Do not assemble when tired or when under the influence of alcohol, drug or medication.
6. Product capabilities apply to properly and completely assembled product only.
7. For additional information regarding the parts listed in the following pages, please refer to the Assembly Diagram of this manual. Unwrap and separate all parts in a clean work area.
8. For safety reasons, This hardware is recommended to be installed by 2 people

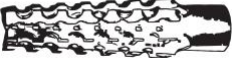
**SAVE THESE INSTRUCTIONS**

Part List			
NO.	Name	Picture	Qty.
A	Baseplate		2
B	Handrail		2
C	Screw		4
D	Drill Bit		1
E	Screw		12
F	Expansion Tube		12
G	Wrench		1

# Product Installation

## Step 1:

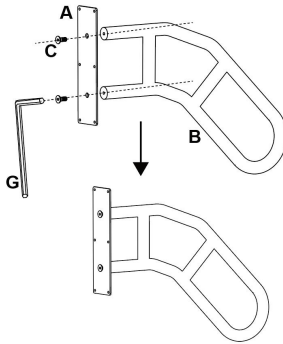

Secure A and B with an Allen wrench.

## Step 2:

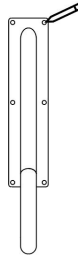

Use the C bracket to place on the wall to draw the locating circle.

## Step 3:

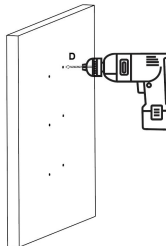

Drill holes in the locating ring.

#### Step 4:

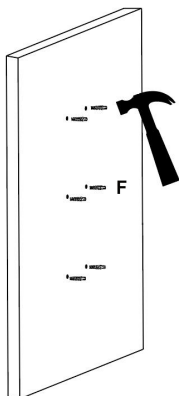

Set the expansion screws into the pre-drilled holes. Tap the wall with a hammer.

#### Step 5:

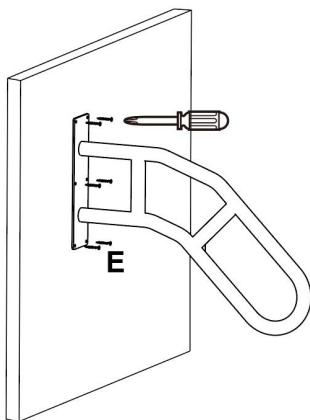

Just align the C with the holes, put the screws on and tighten them.

**Manufacturer:** Shanghai muxinmuyeyouxiangongsi

**Address:** Shuangchenglu 803nong11hao1602A-1609shi, baoshanqu, shanghai 200000 CN.

**Imported to AUS:** SIHAO PTY LTD. 1 ROKEVA STREET EASTWOOD NSW 2122 Australia

**Imported to USA:** Sanven Technology Ltd. Suite 250, 9166 Anaheim Place, Rancho Cucamonga, CA 91730



YH CONSULTING LIMITED.  
C/O YH Consulting Limited Office 147,  
Centurion House, London Road,  
Staines-upon-Thames, Surrey, TW18 4AX



E-CrossStu GmbH  
Mainzer Landstr.69,  
60329 Frankfurt am Main.

**VEVOR<sup>®</sup>**

**TOUGH TOOLS, HALF PRICE**

Technical Support and E-Warranty Certificate

[www.vevor.com/support](http://www.vevor.com/support)



# **VEVOR<sup>®</sup>**

**TOUGH TOOLS, HALF PRICE**

Technical Support and E-Warranty Certificate

[www.vevor.com/support](http://www.vevor.com/support)

## **Outdoor Wall-mounted Handrail**

**MODEL:HR-03-29-2**

We continue to be committed to provide you tools with competitive price.

"Save Half", "Half Price" or any other similar expressions used by us only represents an estimate of savings you might benefit from buying certain tools with us compared to the major top brands and does not necessarily mean to cover all categories of tools offered by us. You are kindly reminded to verify carefully when you are placing an order with us if you are actually saving half in comparison with the top major brands.

# VEVOR®

TOUGH TOOLS, HALF PRICE

## Outdoor Wall-mounted Handrail

MODEL: HR-03-29-2

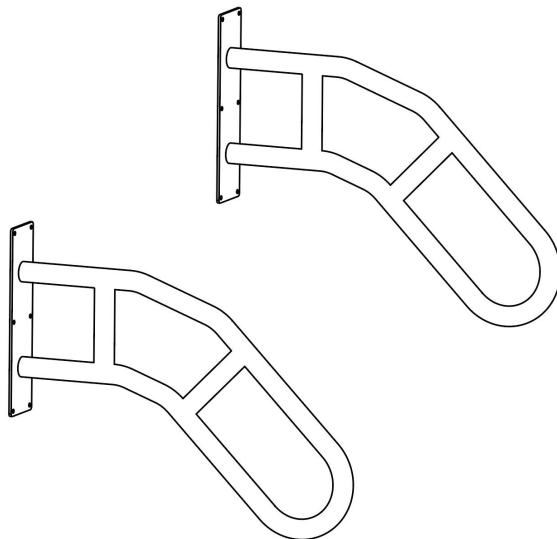

### NEED HELP? CONTACT US!

Have product questions? Need technical support? Please feel free to contact us:

**Technical Support and E-Warranty Certificate**  
[www.vevor.com/support](http://www.vevor.com/support)

This is the original instruction, please read all manual instructions carefully before operating. VEVOR reserves a clear interpretation of our user manual. The appearance of the product shall be subject to the product you received. Please forgive us that we won't inform you again if there are any technology or software updates on our product.

## SAFE INSTRUCTIONS

**CAUTION:** carefully read instructions and procedures for safe operations. Failure to do so can result in serious injury.







### **WARNING:**

1. Before using the handrail, ensure that the handrail is securely installed to prevent personal injury and accidents.
2. When using the handrail, do not overload the handrail to avoid personal injury or accident.
3. Do not draw, cut, or use sharp objects on the handrail to avoid damage.
4. If you need to disassemble the handrail, please follow the reverse steps to disassemble it and store it properly.
5. This product is not a toy. Do not allow children to play with this item.

### **Assembly precautions**

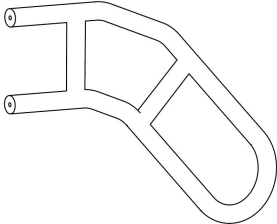
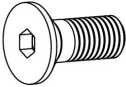
1. Assemble only according to these instructions. Improper assembly can create hazards.
2. Wear ANSI-approved safety goggles and heavy-duty work gloves during assembly.
3. Keep assembly area clean and well lit.
4. Keep bystanders out of the area during assembly.
5. Do not assemble when tired or when under the influence of alcohol, drug or medication.
6. Product capabilities apply to properly and completely assembled product only.
7. For additional information regarding the parts listed in the following pages, please refer to the Assembly Diagram of this manual. Unwrap and separate all parts in a clean work area.
8. For safety reasons, This hardware is recommended to be installed by 2 people

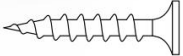
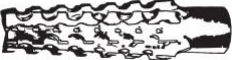
**SAVE THESE INSTRUCTIONS**

Part List			
NO.	Name	Picture	Qty.
A	Baseplate		2
B	Handrail		2
C	Screw		4
D	Drill Bit		1
E	Screw		12
F	Expansion Tube		12
G	Wrench		1

# Product Installation

## Step 1:

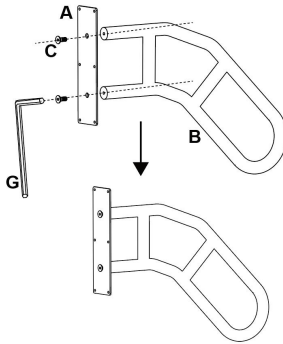

Secure A and B with an Allen wrench.

## Step 2:

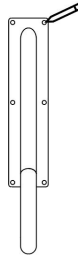

Use the C bracket to place on the wall to draw the locating circle.

## Step 3:

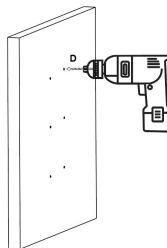

Drill holes in the locating ring.

#### Step 4:

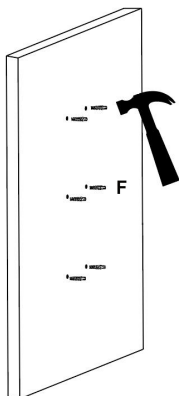

Set the expansion screws into the pre-drilled holes. Tap the wall with a hammer.

#### Step 5:

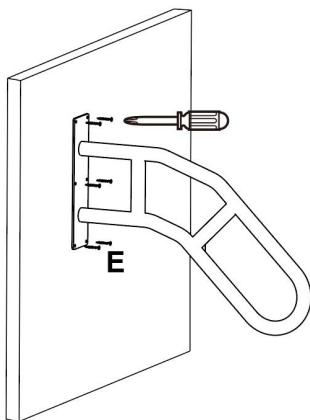

Just align the C with the holes, put the screws on and tighten them.

**Manufacturer:** Shanghaimuxinmuyeyouxiangongsi

**Address:** Shuangchenglu 803nong11hao1602A-1609shi, baoshanqu, shanghai 200000 CN.

**Imported to AUS:** SIHAO PTY LTD. 1 ROKEVA STREETEASTWOOD NSW 2122 Australia

**Imported to USA:** Sanven Technology Ltd. Suite 250, 9166 Anaheim Place, Rancho Cucamonga, CA 91730



YH CONSULTING LIMITED.  
C/O YH Consulting Limited Office 147,  
Centurion House, London Road,  
Staines-upon-Thames, Surrey, TW18 4AX



E-CrossStu GmbH  
Mainzer Landstr.69,  
60329 Frankfurt am Main.

**VEVOR**<sup>®</sup>

**TOUGH TOOLS, HALF PRICE**

Technical Support and E-Warranty Certificate

[www.vevor.com/support](http://www.vevor.com/support)