

# **VEVOR<sup>®</sup>**

## **TOUGH TOOLS, HALF PRICE**

Technical Support and E-Warranty Certificate [www.vevor.com/support](http://www.vevor.com/support)

**WATERPROOF SHOWER SUBSTRATE**

**MODEL:**

**JQ-3860PA/JQ-3860ZA/JQ-3860ZP/JQ3860PP**

**JQ-4848AJQ-4848P/JQ-4860A/JQ-4860P**

**JQ-4872A/JQ\*4872P/JQ-7272A/JQ-7272P**

We continue to be committed to provide you tools with competitive price.

"Save Half", "Half Price" or any other similar expressions used by us only represents an estimate of savings you might benefit from buying certain tools with us compared to the major top brands and dose not necessarily mean to cover all categories of tools offered by us. You are kindly reminded to verify carefully when you are placing an order with us if you are actually saving half in comparison with the top major brands.

# VEVOR®

TOUGH TOOLS, HALF PRICE

WATERPROOF SHOWER  
SUBSTRATE

MODEL: JQ-3860PA/JQ-3860ZA/JQ-3860ZP/JQ3860PP  
JQ-4848AJQ-4848P/JQ-4860A/JQ-4860P  
JQ-4872A/JQ\*4872P/JQ-7272A/JQ-7272P

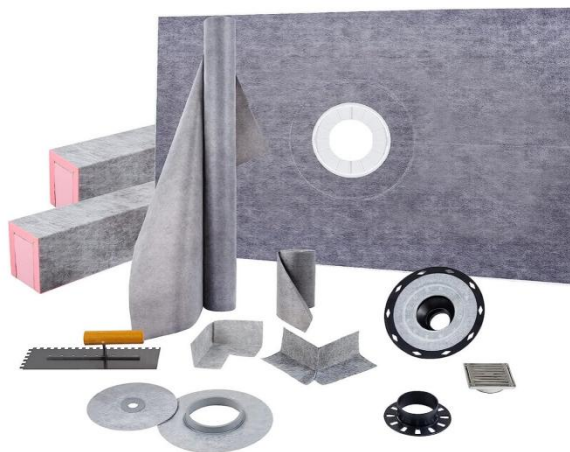

## NEED HELP? CONTACT US!

Have product questions? Need technical support? Please feel free to contact us:

**Technical Support and E-Warranty Certificate**  
[www.vevor.com/support](http://www.vevor.com/support)

This is the original instruction, please read all manual instructions carefully before operating. VEVOR reserves a clear interpretation of our user manual. The appearance of the product shall be subject to the product you received. Please forgive us that we won't inform you again if there are any technology or software updates on our product.



Warning-To reduce the risk of injury, user must read instructions manual carefully.



Code	Name	QTY.	Code	Name	QTY.
A	Shower Curb	2	G	Waterproofng Corners 1	4
B	Waterproofng Membrane	1	H	Waterproofng Strip	1
C	Tray	1	I	Waterproofing Corners 2	2
D	Trowel	1	J	Drain Adjustment Ring	1

E	Mixing Valve Seal	1	K	Bonding Flange	1
F	Pipe Seal	1	L	Drain Grate	1

◆The number of Waterproofng strips (H) of JQ-7272A and JQ-7272P are 2pcs.

Ceramic and stone tiles are durable, easy to maintain, and hygienic, representing the ideal surface coverings, particularly in wet areas such as showers and bathtub surrounds.

However, these coverings are not inherently waterproof. They must be installed in conjunction with a waterproofing system that effectively manages moisture to protect moisture-sensitive building materials and control mold growth.

Model	Specification (inch)	Colour	Flange Material	Shower Tray Hole
JQ-3860PA	38*60	Gray	ABS	Offset
JQ-3860ZA	38*60		ABS	Centre
JQ-3860ZP	38*60		PVC	Centre
JQ3860PP	38*60		PVC	Offset
JQ-4848A	48*48		ABS	Centre
JQ-4848P	48*48		PVC	Centre
JQ-4860A	48*60		ABS	Centre
JQ-4860P	48*60		PVC	Centre
JQ-4872A	48*72		ABS	Centre
JQ-4872P	48*72		PVC	Centre
JQ-7272A	72*72		ABS	Centre
JQ-7272P	72*72		PVC	Centre

## INSTALLATION STEPS

◆ Clean any dust or other debris from the surface of the solid backing.  
Dampen particularly dry and porous substrates in order to help prevent premature drying or skinning of the thin-set mortar.

### Step 1:

	
Prepare mortar	Brush the mortar
	
Cover the membrane	Trim the membrane
	
Make it even	Finish covering the membrane

### Step 2:



Cover the waterproofing strip on the corner



Trim the strip



Brush the mortar



Cover the waterproofing strip on the joint



Trim the strip



Make the wall surface even

### Step 3:



Cover the mixing valve seal



Make the surface even

## Step 4:



Unfold the tray



Embed the tray in the mortar

## Step 5:



Brush the mortar





Install the waterproofing corners 1





Trim the corner

## Step 6:



Brush the mortar	Cover the waterproofing strip
	
Make the surface even	





**Step 7:**

	
Brush the mortar	Cover the pipe seal
	Trim the pipe seal



**Step 8:**

	
--	--





<p>Brush the mortar</p>	<p>Press the bonding flange into the mortar</p>
	
<p>Rotate the flange to fix it firmly</p>	<p>Brush the mortar around</p>
	
<p>Trim the surface</p>	<p>Cover the waterproofing membrane</p>
	<p>Make the surface even</p>

**Step 9:**

	
<p>Install the drain adjustment ring</p>	<p>Ensure full coverage</p>



## Step 10:

	
Brush the mortar	Press the curb
	Fix the curb firmly

## Step 11:

	
Brush the mortar	Cover the waterproofing corners 2
	Trim the corner

## Step 12:

	
<p>Cover the waterproofing strip</p>	<p>Trim the strip</p>

## Installation of waterproof system is completed.

**Address:** Baoshanqu Shuangchenglu 803long 11hao 1602A-1609shi  
Shanghai

**Imported to AUS:** SIHAO PTY LTD, 1 ROKEVA STREETEASTWOOD  
NSW 2122 Australia

**Imported to USA:** Sanven Technology Ltd., Suite 250, 9166 Anaheim  
Place, Rancho Cucamonga, CA 91730

<p><b>UK</b></p>	<p><b>REP</b></p>
------------------	-------------------

Pooledas Group Ltd  
Unit 5 Albert Edward House, The Pavilions  
Preston, United Kingdom

<p><b>EC</b></p>	<p><b>REP</b></p>
------------------	-------------------

SHUNSHUN GmbH  
Römeräcker 9 Z2021, 76351  
Linkenheim-Hochstetten, Germany

**Made In China**

**VEVOR<sup>®</sup>**

**TOUGH TOOLS, HALF PRICE**

**Technical Support and E-Warranty Certificate**

**[www.vevor.com/support](http://www.vevor.com/support)**

# **VEVOR<sup>®</sup>**

## **TOUGH TOOLS, HALF PRICE**

Technique Assistance et certificat de garantie électronique

[www.vevor.com/support](http://www.vevor.com/support)

**SUBSTRAT DE DOUCHE IMPERMÉABLE**

**MODÈLE:**

**JQ-3860PA /JQ-3860ZA/JQ-3860ZP/JQ3860PP**

**JQ-4848AJQ-4848P/ JQ-4860A /JQ-4860P**

**JQ-4872A/JQ\*4872P/JQ-7272A/JQ-7272P**

We continue to be committed to provide you tools with competitive price.

"Save Half", "Half Price" or any other similar expressions used by us only represents an estimate of savings you might benefit from buying certain tools with us compared to the major top brands and dose not necessarily mean to cover all categories of tools offered by us. You

are kindly reminded to verify carefully when you are placing an order with us if you are actually saving half in comparison with the top major brands.



# VEVOR®

TOUGH TOOLS, HALF PRICE

WATERPROOF SHOWER  
SUBSTRATE

MODÈLE : JQ-3860PA /JQ-3860ZA/JQ-3860ZP/JQ3860PP  
JQ-4848AJQ-4848P/ JQ-4860A /JQ-4860P  
JQ-4872A/JQ\*4872P/JQ-7272A/JQ-7272P

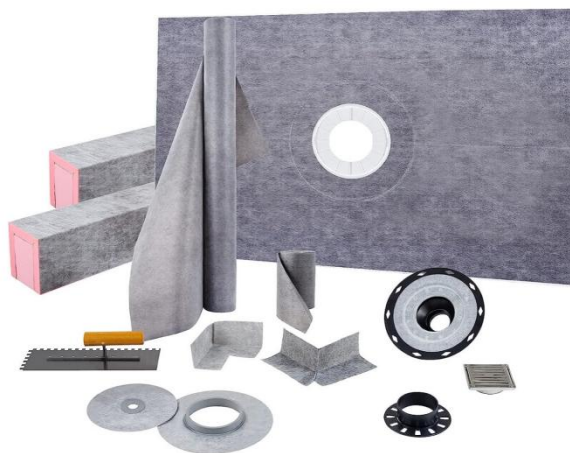

## NEED HELP? CONTACT US!

Have product questions? Need technical support? Please feel free to contact us:

**Technical Support and E-Warranty Certificate**  
[www.vevor.com/support](http://www.vevor.com/support)

This is the original instruction, please read all manual instructions carefully before operating. VEVOR reserves a clear interpretation of our user manual. The appearance of the product shall be subject to the product you received. Please forgive us that we won't inform you again if there are any technology or software updates on our product.



Avertissement : Pour réduire le risque de blessure, l'utilisateur doit lire attentivement le manuel d'instructions.

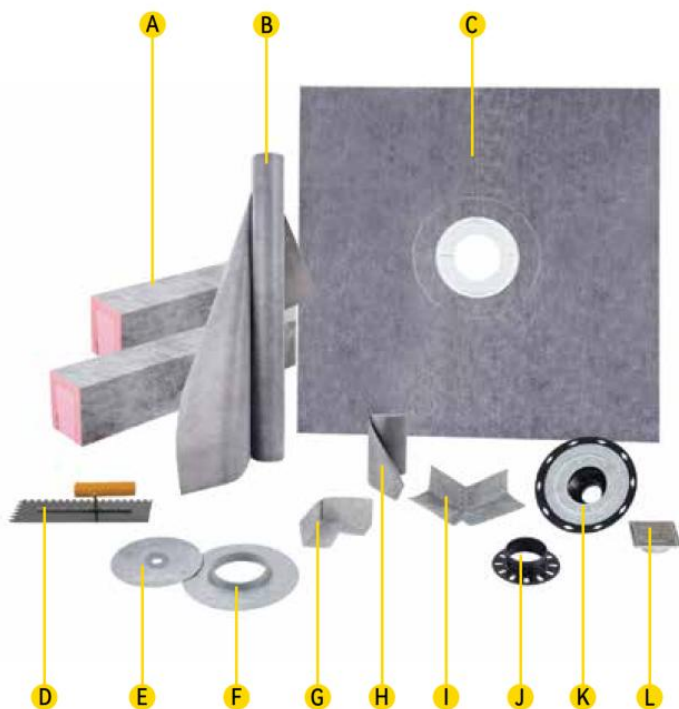

Code	Nom	QTÉ.	Code	Nom	QTÉ.
UN	Bordure de douche	2	g	Coins d'étanchéité 1	4
B	Membrane d'étanchéité	1	H	Bande d'étanchéité	1
C	Plateau	1	je	Coins d'étanchéité 2	2
D	Truelle	1	J.	Bague de réglage de vidange	1



E	Joint de vanne mélangeuse	1	K	Bride de liaison	1
F	Joint de tuyau	1	L	Grille de vidange	1

◆ Le nombre de Les bandes d'étanchéité (H) du JQ-7272A et du JQ-7272P sont 2 pièces.

Les carreaux de céramique et de pierre sont durables, faciles à entretenir et hygiéniques, représentant le revêtement de surface idéal , en particulier dans les zones humides telles que les contours de douches et de baignoires.

Cependant, ces revêtements ne sont pas intrinsèquement étanches. Ils doivent être installés conjointement avec un système d'étanchéité qui gère efficacement l'humidité afin de protéger les matériaux de construction sensibles à l'humidité et de contrôler la croissance des moisissures.

Modèle	Spécification (pouces)	Couleur	Matériau de la bride	Trou pour receveur de douche
JQ-3860PA	38*60	Gris	abdos	Compenser
JQ-3860ZA	38*60		abdos	Centre
JQ-3860ZP	38*60		PVC	Centre
JQ3860PP	38*60		PVC	Compenser
JQ-4848A	48*48		abdos	Centre
JQ-4848P	48*48		PVC	Centre
JQ-4860A	48*60		abdos	Centre
JQ-4860P	48*60		PVC	Centre
JQ-4872A	48*72		abdos	Centre
JQ-4872P	48*72		PVC	Centre
JQ-7272A	72*72		abdos	Centre
JQ-7272P	72*72		PVC	Centre

## ÉTAPES D'INSTALLATION

◆ Nettoyez toute poussière ou autre débris de la surface du support solide. Humidifier les supports particulièrement secs et poreux afin d'éviter un séchage prématuré ou un pelage du mortier-colle.

### Étape 1:

	
Préparer le mortier	Badigeonner le mortier
	
Couvrir la membrane	Couper la membrane
	
Rendez-le égal	Finir de recouvrir la membrane

## Étape 2 :

	
Recouvrir la bande d'étanchéité le coin	Coupez la bande
	
Badigeonner le mortier	Recouvrir la bande d'étanchéité Le joint
	
Coupez la bande	Rendre la surface du mur uniforme

## Étape 3 :



Couvrir le joint du mitigeur



Rendre la surface uniforme

## Étape 4 :



Dépliez le plateau



Encastrer le plateau dans le mortier

## Étape 5 :



Badigeonner le mortier



Installer les coins d'étanchéité 1



Couper le coin

## Étape 6 :



Badigeonner le mortier



Couvrir la bande d'étanchéité



Rendre la surface uniforme

## Étape 7 :



Badigeonner le mortier



Couvrir le joint du tuyau



Couper le joint du tuyau

## Étape 8 :

	
Badigeonner le mortier	Enfoncer la bride de collage dans le mortier
	
Faites pivoter la bride pour la fixer fermement	Badigeonner le mortier autour
	
Couper la surface	Couvrir la membrane d'étanchéité
	Rendre la surface uniforme

## Étape 9 :



Installer la bague de réglage de la vidange



Assurer une couverture complète

## Étape 10 :



Badigeonner le mortier



Appuyez sur le trottoir



Fixez fermement la bordure

## Étape 11 :



Badigeonner le mortier



Couvrir les coins d'étanchéité 2



Couper le coin

## Étape 12 :



Couvrir la bande d'étanchéité



Coupez la bande

**L'installation du système étanche est terminée.**

**Adresse :** Baoshanqu Shuangchenglu 803long 11hao 1602A-1609shi  
Shanghai

**Importé en Australie :** SIHAO PTY LTD, 1 ROKEVA STREETASTWOOD  
NSW 2122 Australie

**Importé aux États-Unis :** Sanven Technology Ltd., Suite 250, 9166  
Anaheim Place, Rancho Cucamonga, CA 91730



<b>UK</b>	<b>REP</b>
-----------	------------

Pooledas Group Ltd  
Unit 5 Albert Edward House, The Pavilions  
Preston, United Kingdom

<b>EC</b>	<b>REP</b>
-----------	------------

SHUNSHUN GmbH  
Römeräcker 9 Z2021, 76351  
Linkenheim-Hochstetten, Germany

**Fabriqué en Chine**

**VEVOR<sup>®</sup>**

**TOUGH TOOLS, HALF PRICE**

**Technique Assistance et certificat de garantie électronique**

**[www.vevor.com/support](http://www.vevor.com/support)**

# **VEVOR<sup>®</sup>**

## **TOUGH TOOLS, HALF PRICE**

Technisch Support- und E-Garantie-Zertifikat [www.vevor.com/support](http://www.vevor.com/support)

**WASSERFESTER DUSCHGRUND**

**MODELL:**

**JQ-3860PA / JQ-3860ZA / JQ-3860ZP / JQ3860PP**

**JQ-4848AJQ-4848P / JQ-4860A / JQ-4860P**

**JQ-4872AJQ\*4872P / JQ-7272AJQ-7272P**

We continue to be committed to provide you tools with competitive price.

"Save Half", "Half Price" or any other similar expressions used by us only represents an estimate of savings you might benefit from buying certain tools with us compared to the major top brands and dose not necessarily mean to cover all categories of tools offered by us. You are kindly reminded to verify carefully when you are placing an order with us if you are actually saving half in comparison with the top major brands.





Warnung: Um das Verletzungsrisiko zu verringern, muss der Benutzer die Bedienungsanleitung sorgfältig lesen.

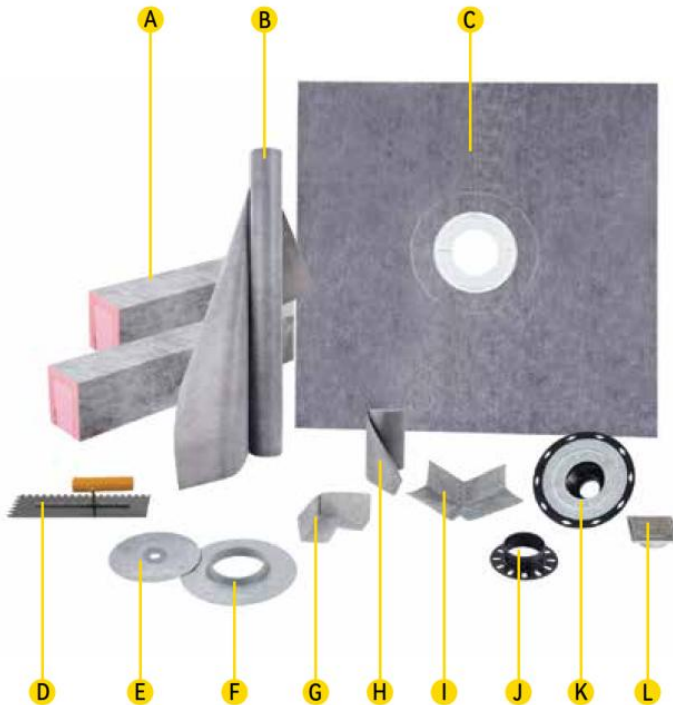

Code	Name	MEN GE.	Code	Name	MEN GE.
A	Duschrand	2	G	Wasserdichte Ecken 1	4
B	Wasserdichte Membran	1	H	Wasserdichter Streifen	1
C	Tablett	1	ICH	Abdichtung von Ecken 2	2
D	Kelle	1	J	Abfluss-Einstellring	1

E	Mischventildichtung	1	K	Klebeflansch	1
F	Rohrdichtung	1	L	Ablaufgitter	1

◆ Die Anzahl der die wasserdichten Streifen (H) von JQ-7272A und JQ-7272P sind 2 Stück.

Keramik- und Steinfliesen sind langlebig, pflegeleicht und hygienisch und stellen den idealen Oberflächenbelag insbesondere in Nassbereichen wie Duschen und Badewannenurandungen dar.

Allerdings sind diese Beläge nicht grundsätzlich wasserdicht. Sie müssen in Verbindung mit einem Abdichtungssystem installiert werden, das die Feuchtigkeit effektiv verwaltet, um feuchtigkeitsempfindliche Baumaterialien zu schützen und Schimmelbildung zu verhindern.

Modell	Spezifikation (Zoll)	Farbe	Flansch material	Loch für Duschwanne
JQ-3860PA	38*60	Grau	Abs	Versatz
JQ-3860ZA	38*60		Abs	Center
JQ-3860ZP	38*60		PVC	Center
JQ3860PP	38*60		PVC	Versatz
JQ-4848A	48*48		Abs	Center
JQ-4848P	48*48		PVC	Center
JQ-4860A	48*60		Abs	Center
JQ-4860P	48*60		PVC	Center
JQ-4872A	48*72		Abs	Center
JQ-4872P	48*72		PVC	Center
JQ-7272A	72*72		Abs	Center
JQ-7272P	72*72		PVC	Center

# INSTALLATIONSSCHRITTE

◆Entfernen Sie Staub und andere Rückstände von der Oberfläche der festen Unterlage. Befeuchten Sie besonders trockene und poröse Untergründe, um ein vorzeitiges Austrocknen oder eine Hautbildung des Dünnbettmörtels zu verhindern.

## Schritt 1:

	
Mörtel vorbereiten	Den Mörtel bestreichen
	
Decken Sie die Membran ab	Schneiden Sie die Membran ab
	
Machen Sie es gleichmäßig	Bedecken Sie die Membran fertig

## Schritt 2 :

	
Decken Sie den Abdichtungsstreifen ab die Ecke	Schneiden Sie den Streifen ab
	
Den Mörtel bestreichen	Decken Sie den Abdichtungsstreifen ab Der Joint
	
Schneiden Sie den Streifen ab	Machen Sie die Wandoberfläche eben

## Schritt 3 :





Decken Sie die Dichtung des Mischventils ab



Machen Sie die Oberfläche eben

#### Schritt 4 :



Klappen Sie das Fach auf



Die Schale in den Mörtel einbetten

#### Schritt 5 :



Den Mörtel bestreichen



Installieren Sie die Abdichtungsecken 1

	<p>Schneiden Sie die Ecke ab</p>
--	----------------------------------

**Schritt 6 :**

	
<p>Den Mörtel bestreichen</p>	<p>Decken Sie den Abdichtungstreifen ab</p>
	
<p>Machen Sie die Oberfläche eben</p>	

**Schritt 7 :**

	
<p>Den Mörtel bestreichen</p>	<p>Decken Sie die Rohrdichtung ab</p>



Schneiden Sie die  
Rohrdichtung ab

## Schritt 8 :



Den Mörtel bestreichen



Den Klebeflansch in den Mörtel  
eindrücken



Drehen Sie den Flansch, um ihn  
fest zu befestigen



Den Mörtel rundherum bestreichen



Beschneiden Sie die Oberfläche



Decken Sie die Abdichtungsbahn  
ab



Machen Sie die Oberfläche eben

### Schritt 9 :



Installieren Sie den  
Ablaufeinstellung



Sorgen Sie für eine vollständige  
Abdeckung

### Schritt 10 :



Den Mörtel bestreichen



Drücken Sie auf den Bordstein





Befestigen Sie den  
Bordstein fest

### Schritt 11 :

	
Den Mörtel bestreichen	Decken Sie die wasserdichten Ecken ab 2
	Schneiden Sie die Ecke ab

## Schritt 12 :

	
Decken Sie den Abdichtungsstreifen ab	Schneiden Sie den Streifen ab

**Die Installation des wasserdichten Systems ist abgeschlossen.**

**Adresse:** Baoshanqu Shuangchenglu 803long 11hao 1602A-1609shi

Shanghai

**Importiert nach AUS:** SIHAO PTY LTD, 1 ROKEVA STREET EASTWOOD  
NSW 2122 Australien

**In die USA importiert:** Sanven Technology Ltd., Suite 250, 9166 Anaheim  
Place, Rancho Cucamonga, CA 91730

<b>UK</b>	<b>REP</b>
-----------	------------

Pooledas Group Ltd  
Unit 5 Albert Edward House, The Pavilions  
Preston, United Kingdom

<b>EC</b>	<b>REP</b>
-----------	------------

SHUNSHUN GmbH  
Römeräcker 9 Z2021, 76351  
Linkenheim-Hochstetten, Germany

**In China hergestellt**

**VEVOR**<sup>®</sup>

**TOUGH TOOLS, HALF PRICE**

**Technisch Support- und E-Garantiezertifikat**

**[www.vevor.com/support](http://www.vevor.com/support)**

# **VEVOR<sup>®</sup>**

## **TOUGH TOOLS, HALF PRICE**

Tecnico Supporto e certificato di garanzia elettronica [www.vevor.com/support](http://www.vevor.com/support)

**SUPPORTO DOCCIA IMPERMEABILE**

**MODELLO:**

**JQ-3860PA / JQ-3860ZA / JQ-3860ZP / JQ3860PP**

**JQ-4848AJQ-4848P / JQ-4860A / JQ-4860P**

**JQ-4872AJQ\*4872P / JQ-7272AJQ-7272P**

We continue to be committed to provide you tools with competitive price.

"Save Half", "Half Price" or any other similar expressions used by us only represents an estimate of savings you might benefit from buying certain tools with us compared to the major top brands and dose not necessarily mean to cover all categories of tools offered by us. You are kindly reminded to verify carefully when you are placing an order with us if you are actually saving half in comparison with the top major brands.



# VEVOR®

TOUGH TOOLS, HALF PRICE

WATERPROOF SHOWER  
SUBSTRATE

MODELLO: JQ-3860PA / JQ-3860ZA / JQ-3860ZP / JQ3860PP  
JQ-4848AJQ-4848P / JQ-4860A / JQ-4860P  
JQ-4872A / JQ\*4872P / JQ-7272A / JQ-7272P

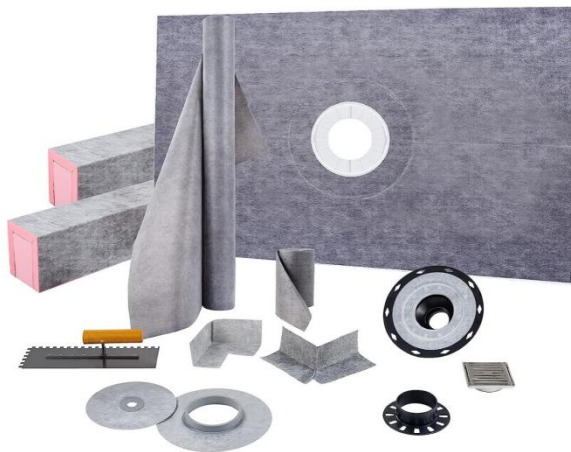

## NEED HELP? CONTACT US!

Have product questions? Need technical support? Please feel free to contact us:

**Technical Support and E-Warranty Certificate**  
**[www.vevor.com/support](http://www.vevor.com/support)**

This is the original instruction, please read all manual instructions carefully before operating. VEVOR reserves a clear interpretation of our user manual. The appearance of the product shall be subject to the product you received. Please forgive us that we won't inform you again if there are any technology or software updates on our product.



Avvertenza: per ridurre il rischio di lesioni, l'utente deve leggere attentamente il manuale di istruzioni.

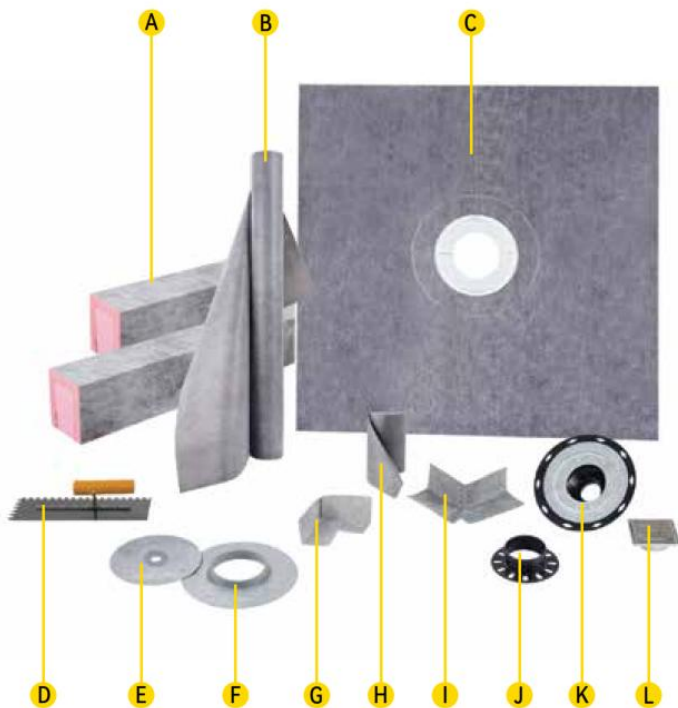

Codice	Nome	QUANTITÀ	Codice	Nome	QUANTITÀ
UN	Cordolo doccia	2	G	Angoli impermeabilizzanti 1	4
B	Membrana impermeabilizzante	1	H	Striscia impermeabilizzante	1
C	Vassoio	1	IO	Angoli impermeabilizzanti 2	2

D	Cazzuola	1	J	Anello di regolazione dello scarico	1
E	Guarnizione della valvola di miscelazione	1	K	Flangia di collegamento	1
F	Guarnizione del tubo	1	I	Griglia di scarico	1

◆ Il numero di Le strisce impermeabili (H) di JQ-7272A e JQ-7272P sono 2 pezzi.

Le piastrelle in ceramica e pietra sono durevoli, di facile manutenzione e igieniche e rappresentano il rivestimento ideale delle superfici, in particolare nelle zone umide come docce e bordi vasca.

Tuttavia, questi rivestimenti non sono intrinsecamente impermeabili.

Devono essere installati insieme a un sistema impermeabilizzante che gestisca efficacemente l'umidità per proteggere i materiali da costruzione sensibili all'umidità e controllare la crescita della muffa.

<b>Modello</b>	<b>Specifica (pollici)</b>	<b>Colore</b>	<b>Material e della flangia</b>	<b>Foro per piatto doccia</b>
JQ-3860PA	38*60	Grigio	addomin ali	Compensare
JQ-3860ZA	38*60		addomin ali	Centro
JQ-3860ZP	38*60		PVC	Centro
JQ3860PP	38*60		PVC	Compensare
JQ-4848A	48*48		addomin ali	Centro
JQ-4848P	48*48		PVC	Centro
JQ-4860A	48*60		addomin	Centro



			ali	
JQ-4860P	48*60		PVC	Centro
JQ-4872A	48*72		addomin ali	Centro
JQ-4872P	48*72		PVC	Centro
JQ-7272A	72*72		addomin ali	Centro
JQ-7272P	72*72		PVC	Centro

## FASI DI INSTALLAZIONE

◆ Rimuovere polvere o altri detriti dalla superficie del supporto solido.  
Inumidire i supporti particolarmente asciutti e porosi per evitare un precoce essiccamento o sfogliamento della malta sottile.

### Passo 1:

	
Preparare la malta	Spennellare la malta
	

Coprire la membrana	Taglia la membrana
	
Rendilo uniforme	Finire di coprire la membrana

## Passo 2 :

	
Coprire la striscia impermeabilizzante l'angolo	Taglia la striscia
	
Spennellare la malta	Coprire la striscia impermeabilizzante il giunto



Taglia la striscia



Rendere uniforme la superficie del muro

### Passaggio 3 :



Coprire la guarnizione della valvola miscelatrice



Rendi la superficie uniforme

### Passaggio 4 :



Aprire il vassoio



Incorporare la vaschetta nel mortaio

### Passaggio 5 :

	
<p>Spennellare la malta</p>	<p>Installare gli angoli impermeabilizzanti 1</p>
	<p>Taglia l'angolo</p>

## Passaggio 6 :

	
<p>Spennellare la malta</p>	<p>Coprire la striscia impermeabilizzante</p>
	
<p>Rendi la superficie uniforme</p>	

## Passaggio 7 :



Spennellare la malta



Coprire la guarnizione del tubo



Tagliare la guarnizione del tubo

## Passaggio 8 :



Spennellare la malta



Premere la flangia di incollaggio nella malta



Ruotare la flangia per fissarla saldamente



Spennellare la malta





Taglia la superficie



Coprire la membrana impermeabilizzante



Rendi la superficie uniforme

## Passaggio 9 :



Installare l'anello di regolazione dello scarico



Garantire una copertura completa

## Passaggio 10 :



Spennellare la malta	Premi il cordolo
	<p data-bbox="717 213 997 288">Fissare saldamente il cordolo</p>

### Passaggio 11 :

	
Spennellare la malta	Coprire gli angoli dell'impermeabilizzazione 2
	<p data-bbox="706 916 893 954">Taglia l'angolo</p>

### Passaggio 12 :

	
--	--

Coprire la striscia  
impermeabilizzante

Taglia la striscia

## L'installazione del sistema impermeabile è completata.

**Indirizzo:** Baoshanqu Shuangchenglu 803long 11hao 1602A-1609shi  
Shanghai

**Importato in AUS:** SIHAO PTY LTD, 1 ROKEVA STREETEASTWOOD  
NSW 2122 Australia

**Importato negli Stati Uniti:** Sanven Technology Ltd., Suite 250, 9166  
Anaheim Place, Rancho Cucamonga, CA 91730



Pooledas Group Ltd  
Unit 5 Albert Edward House, The Pavilions  
Preston, United Kingdom



SHUNSHUN GmbH  
Römeräcker 9 Z2021, 76351  
Linkenheim-Hochstetten, Germany

**Made in China**

**VEVOR<sup>®</sup>**

**TOUGH TOOLS, HALF PRICE**

**Tecnico Supporto e certificato di garanzia elettronica**

**[www.vevor.com/support](http://www.vevor.com/support)**

# **VEVOR<sup>®</sup>**

## **TOUGH TOOLS, HALF PRICE**

Técnico Soporte y certificado de garantía electrónica [www.vevor.com/support](http://www.vevor.com/support)

**SUSTRATO DE DUCHA IMPERMEABLE**

**MODELO:**

**JQ-3860PA / JQ-3860ZA / JQ-3860ZP / JQ3860PP**

**JQ-4848AJQ-4848P / JQ-4860A / JQ-4860P**

**JQ-4872AJQ\*4872P / JQ-7272AJQ-7272P**

We continue to be committed to provide you tools with competitive price.

"Save Half", "Half Price" or any other similar expressions used by us only represents an estimate of savings you might benefit from buying certain tools with us compared to the major top brands and dose not necessarily mean to cover all categories of tools offered by us. You are kindly reminded to verify carefully when you are placing an order with us if you are actually saving half in comparison with the top major brands.

# VEVOR®

TOUGH TOOLS, HALF PRICE

WATERPROOF SHOWER  
SUBSTRATE

MODELO: JQ-3860PA /JQ-3860ZA/JQ-3860ZP/JQ3860PP  
JQ-4848AJQ-4848P / JQ-4860A /JQ-4860P  
JQ-4872A/JQ\*4872P/JQ-7272A/JQ-7272P



## NEED HELP? CONTACT US!

Have product questions? Need technical support? Please feel free to contact us:

**Technical Support and E-Warranty Certificate**  
[www.vevor.com/support](http://www.vevor.com/support)

This is the original instruction, please read all manual instructions carefully before operating. VEVOR reserves a clear interpretation of our user manual. The appearance of the product shall be subject to the product you received. Please forgive us that we won't inform you again if there are any technology or software updates on our product.



Advertencia: para reducir el riesgo de lesiones, el usuario debe leer atentamente el manual de instrucciones.

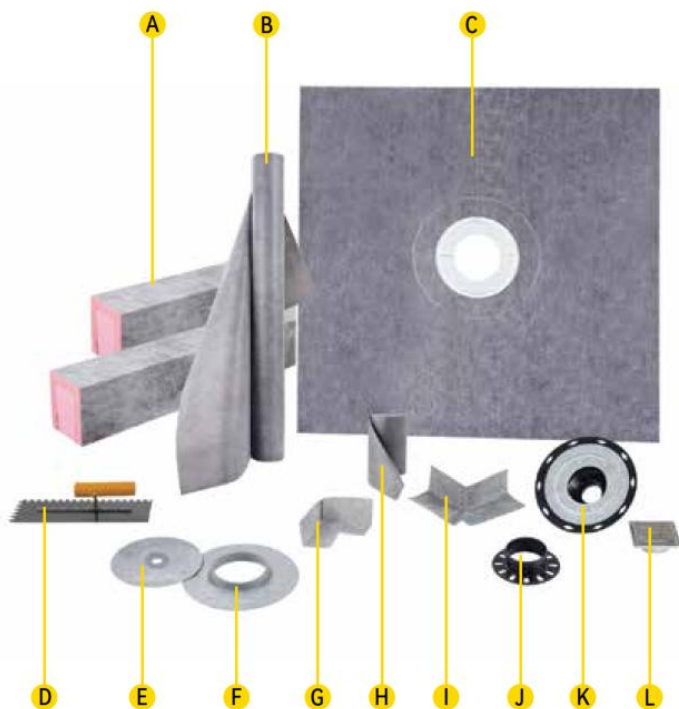

Código	Nombre	CAN T.	Código	Nombre	CAN T.
A	Bordillo de ducha	2	GRAMO	Impermeabilización de Esquinas 1	4
B	Membrana impermeabilizante	1	h	Tira impermeabilizante	1
C	Bandeja	1	l	Impermeabilización de Esquinas 2	2

D	Paleta	1	j	Anillo de ajuste de drenaje	1
mi	Sello de válvula mezcladora	1	k	Brida de unión	1
F	Sello de tubería	1	l	Rejilla de drenaje	1

◆El número de Las tiras impermeabilizantes (H) de JQ-7272A y JQ-7272P son de 2 piezas.

Las baldosas de cerámica y piedra son duraderas, fáciles de mantener e higiénicas, y representan los revestimientos de superficies ideales, especialmente en zonas húmedas como duchas y bañeras.

Sin embargo, estos revestimientos no son inherentemente impermeables. Deben instalarse junto con un sistema de impermeabilización que controle eficazmente la humedad para proteger los materiales de construcción sensibles a la humedad y controlar el crecimiento de moho.

Modelo	Especificación (pulgadas)	Color	Material de brida	Orificio para plato de ducha
JQ-3860PA	38*60	Gris	abdominales	Compensar
JQ-3860ZA	38*60		abdominales	Centro
JQ-3860ZP	38*60		CLORURO DE POLIVINILO	Centro
JQ3860PP	38*60		CLORURO DE POLIVIN	Compensar



			ILO	
JQ-4848A	48*48		abdominales	Centro
JQ-4848P	48*48		CLORURO DE POLIVINILO	Centro
JQ-4860A	48*60		abdominales	Centro
JQ-4860P	48*60		CLORURO DE POLIVINILO	Centro
JQ-4872A	48*72		abdominales	Centro
JQ-4872P	48*72		CLORURO DE POLIVINILO	Centro
JQ-7272A	72*72		abdominales	Centro
JQ-7272P	72*72		CLORURO DE POLIVINILO	Centro

## **PASOS DE INSTALACIÓN**

◆ Limpie el polvo u otros residuos de la superficie del respaldo sólido. Humedezca los sustratos particularmente secos y porosos para ayudar a prevenir el secado prematuro o la formación de piel del mortero de capa

delgada.

## Paso 1:

	
preparar mortero	Cepilla el mortero
	
Cubrir la membrana	Recortar la membrana
	
hazlo incluso	Terminar de cubrir la membrana.

## Paso 2 :



Cubra la tira impermeabilizante la esquina



Recortar la tira



Cepilla el mortero



Cubra la tira impermeabilizante la articulación



Recortar la tira



Haga que la superficie de la pared sea uniforme

### Paso 3 :



Cubra el sello de la válvula mezcladora.

Haz la superficie uniforme

## Etapa 4 :



desplegar la bandeja



Incrustar la bandeja en el mortero.

## Paso 5 :



Cepilla el mortero



Instalar las esquinas impermeabilizantes 1



Recortar la esquina

## Paso 6 :

	
<p>Cepilla el mortero</p>	<p>Cubrir la tira impermeabilizante.</p>
	
<p>Haz la superficie uniforme</p>	

## Paso 7 :

	
<p>Cepilla el mortero</p>	<p>Cubra el sello de la tubería</p>
	<p>Recortar el sello de la tubería</p>

## Paso 8 :

	
<p>Cepilla el mortero</p>	<p>Presione la brida de unión en el mortero.</p>
	
<p>Gire la brida para fijarla firmemente.</p>	<p>Cepille el mortero alrededor</p>
	
<p>Recortar la superficie</p>	<p>Cubrir la membrana impermeabilizante.</p>
	<p>Haz la superficie uniforme</p>

## Paso 9 :



Instale el anillo de ajuste del drenaje.



Garantizar una cobertura total

## Paso 10 :



Cepilla el mortero



Presione la acera



Fija el bordillo firmemente

## Paso 11 :



Cepilla el mortero



Cubrir las esquinas

	impermeabilizantes 2
	Recortar la esquina

## Paso 12 :

	
Cubrir la tira impermeabilizante.	Recortar la tira

**Se completa la instalación del sistema impermeable.**

**Dirección:** Baoshanqu Shuangchenglu 803long 11hao 1602A-1609shi  
Shanghai

**Importado a AUS:** SIHAO PTY LTD, 1 ROKEVA STREETEASTWOOD  
NSW 2122 Australia

**Importado a EE. UU.:** Sanven Technology Ltd., Suite 250, 9166 Anaheim  
Place, Rancho Cucamonga, CA 91730



<b>UK</b>	<b>REP</b>
-----------	------------

Pooledas Group Ltd  
Unit 5 Albert Edward House, The Pavilions  
Preston, United Kingdom

<b>EC</b>	<b>REP</b>
-----------	------------

SHUNSHUN GmbH  
Römeräcker 9 Z2021, 76351  
Linkenheim-Hochstetten, Germany

**Hecho en china**

**VEVOR<sup>®</sup>**

**TOUGH TOOLS, HALF PRICE**

**Técnico Certificado de soporte y garantía electrónica**

**[www.vevor.com/support](http://www.vevor.com/support)**

# **VEVOR®**

## **TOUGH TOOLS, HALF PRICE**

Techniczny Certyfikat wsparcia i e-gwarancji [www.vevor.com/support](http://www.vevor.com/support)

**WODOODPORNE PODŁOŻE PRYSZNICOWE**

**MODEL:**

**JQ-3860PA /JQ-3860ZA/JQ-3860ZP/JQ3860PP**

**JQ-4848AJQ-4848P/ JQ-4860A /JQ-4860P**

**JQ-4872AJQ\*4872P/JQ-7272AJQ-7272P**

We continue to be committed to provide you tools with competitive price.

"Save Half", "Half Price" or any other similar expressions used by us only represents an estimate of savings you might benefit from buying certain tools with us compared to the major top brands and dose not necessarily mean to cover all categories of tools offered by us. You are kindly reminded to verify carefully when you are placing an order with us if you are actually saving half in comparison with the top major brands.

# VEVOR®

TOUGH TOOLS, HALF PRICE

WATERPROOF SHOWER  
SUBSTRATE

MODELU: JQ-3860PA / JQ-3860ZA / JQ-3860ZP / JQ3860PP  
JQ-4848AJQ-4848P / JQ-4860A / JQ-4860P  
JQ-4872A / JQ\*4872P / JQ-7272A / JQ-7272P

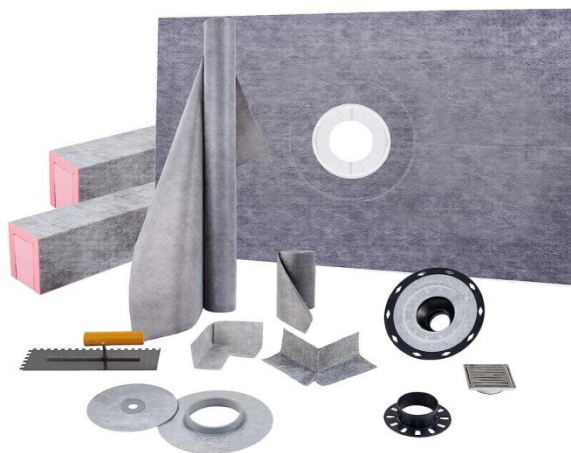

## NEED HELP? CONTACT US!

Have product questions? Need technical support? Please feel free to contact us:

**Technical Support and E-Warranty Certificate**  
[www.vevor.com/support](http://www.vevor.com/support)

This is the original instruction, please read all manual instructions carefully before operating. VEVOR reserves a clear interpretation of our user manual. The appearance of the product shall be subject to the product you received. Please forgive us that we won't inform you again if there are any technology or software updates on our product.



Ostrzeżenie — aby zmniejszyć ryzyko obrażeń, użytkownik musi uważnie przeczytać instrukcję obsługi.

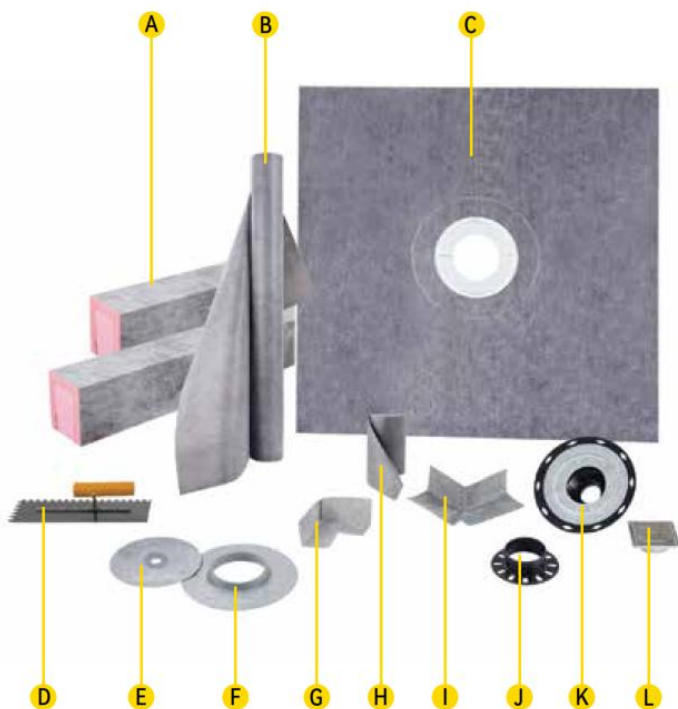

Kod	Nazwa	ILOŚĆ	Kod	Nazwa	ILOŚĆ
A	Krawężnik prysznicowy	2	G	Wodoodporne narożniki 1	4
B	Wodoodporna membrana	1	H	Wodoodporny pasek	1
C	Taca	1	I	Hydroizolacja narożników 2	2
D	Kielnia	1	J	Pierścień regulacji spustu	1

mi	Uszczelka zaworu mieszającego	1	K	Kołnierz łączący	1
F	Uszczelka rury	1	L	Ruszt spustowy	1

◆ Liczba Paski wodoodporne (H) JQ -7272A i JQ-7272P to 2 sztuki.

Płytki ceramiczne i kamienne są trwałe, łatwe w utrzymaniu i higieniczne, stanowią idealne pokrycie powierzchni, szczególnie w obszarach wilgotnych, takich jak prysznice i obudowy wanien.

Jednakże te pokrycia nie są z natury wodoodporne. Muszą być instalowane w połączeniu z systemem hydroizolacji, który skutecznie zarządza wilgocią, aby chronić wrażliwe na wilgoć materiały budowlane i kontrolować rozwój pleśni.

Model	Specyfikacja (cale)	Kolor	Materiał kołnierza	Otwór na brodzik
JQ-3860PA	38*60	Szary	ABS	Zrównoważyć
JQ-3860ZA	38*60		ABS	Centrum
JQ-3860ZP	38*60		PCV	Centrum
JQ3860PP	38*60		PCV	Zrównoważyć
JQ-4848A	48*48		ABS	Centrum
JQ-4848P	48*48		PCV	Centrum
JQ-4860A	48*60		ABS	Centrum
JQ-4860P	48*60		PCV	Centrum
JQ-4872A	48*72		ABS	Centrum
JQ-4872P	48*72		PCV	Centrum
JQ-7272A	72*72		ABS	Centrum
JQ-7272P	72*72		PCV	Centrum

## KROKI INSTALACJI

◆ Wyczyść powierzchnię stałego podłoża z kurzu i innych zanieczyszczeń. Szczególnie suche i porowate podłoża należy zwilżyć, aby zapobiec przedwczesnemu wysychaniu lub tworzeniu się kożucha cienkowarstwowej zaprawy.

### Krok 1:

	
Przygotuj zaprawę	Posmaruj zaprawę
	
Przykryj membranę	Przytnij membranę
	
Zrób to równo	Zakończ zakrywanie membrany

## Krok 2 :

	
Zakryj pasek hydroizolacyjny róg	Przytnij pasek
	
Posmaruj zaprawę	Zakryj pasek hydroizolacyjny staw
	
Przytnij pasek	Wyrównaj powierzchnię ściany

## Krok 3 :





Zakryć uszczelkę zaworu mieszającego



Wyrównaj powierzchnię

#### Krok 4 :



Rozłóż tacę



Zanurz tacę w zaprawie

#### Krok 5 :



Posmaruj zaprawę



Zamontuj narożniki hydroizolacyjne

1

	<p>Przytnij róg</p>
---	---------------------

## Krok 6 :

	
<p>Posmaruj zaprawę</p>	<p>Zakryj pasek hydroizolacyjny</p>
	
<p>Wyrównaj powierzchnię</p>	

## Krok 7 :

	
<p>Posmaruj zaprawę</p>	<p>Zakryć uszczelkę rury</p>



Przytnij uszczelkę rury

## Krok 8 :



Posmaruj zaprawę



Wcisnąć kołnierz łączący w zaprawę



Obróć kołnierz, aby go mocno zamocować



Posmaruj zaprawą dookoła



Przytnij powierzchnię



Przykryj membranę hydroizolacyjną



Wyrównaj powierzchnię

### Krok 9 :



Zamontuj pierścień regulacyjny spustu



Zapewnij pełne pokrycie

### Krok 10 :



Posmaruj zaprawę



Naciśnij krawężnik



Mocno zamocuj krawężnik

### Krok 11 :

	
Posmaruj zaprawę	Zakryj narożniki hydroizolacją 2
	Przytnij róg

## Krok 12 :

	
Zakryj pasek hydroizolacyjny	Przytnij pasek

**Zakończono montaż systemu wodoodpornego.**

**Adres:** Baoshanqu Shuangchenglu 803long 11hao 1602A-1609shi  
Szanghaj

**Import do AUS:** SIHAO PTY LTD, 1 ROKEVA STREET EASTWOOD NSW  
2122 Australia

**Import do USA:** Sanven Technology Ltd., Suite 250, 9166 Anaheim Place,  
Rancho Cucamonga, CA 91730



Pooledas Group Ltd  
Unit 5 Albert Edward House, The Pavilions  
Preston, United Kingdom



SHUNSHUN GmbH  
Römeräcker 9 Z2021, 76351  
Linkenheim-Hochstetten, Germany

**Wyprodukowano w Chinach**

**VEVOR<sup>®</sup>**

**TOUGH TOOLS, HALF PRICE**

**Techniczny Certyfikat wsparcia i e-gwarancji**

**[www.vevor.com/support](http://www.vevor.com/support)**

# **VEVOR<sup>®</sup>**

## **TOUGH TOOLS, HALF PRICE**

Technisch Ondersteuning en e-garantiecertificaat [www.vevor.com/support](http://www.vevor.com/support)

**WATERDICHT DOUCHESUBSTRAAT**

**MODEL:**

**JQ-3860PA /JQ-3860ZA/JQ-3860ZP/JQ3860PP**

**JQ-4848AJQ-4848P/ JQ-4860A /JQ-4860P**

**JQ-4872AJQ\*4872P/JQ-7272AJQ-7272P**

We continue to be committed to provide you tools with competitive price.

"Save Half", "Half Price" or any other similar expressions used by us only represents an estimate of savings you might benefit from buying certain tools with us compared to the major top brands and dose not necessarily mean to cover all categories of tools offered by us. You are kindly reminded to verify carefully when you are placing an order with us if you are actually saving half in comparison with the top major brands.



# VEVOR®

TOUGH TOOLS, HALF PRICE

WATERPROOF SHOWER  
SUBSTRATE

MODEL: JQ-3860PA / JQ-3860ZA / JQ-3860ZP / JQ3860PP  
JQ-4848AJQ-4848P / JQ-4860A / JQ-4860P  
JQ-4872A / JQ\*4872P / JQ-7272A / JQ-7272P

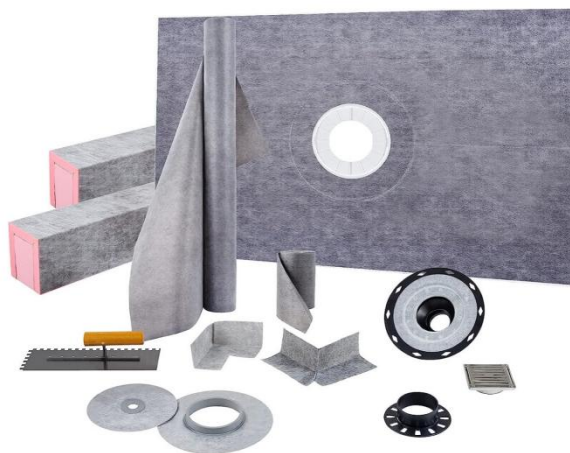

## NEED HELP? CONTACT US!

Have product questions? Need technical support? Please feel free to contact us:

**Technical Support and E-Warranty Certificate**  
[www.vevor.com/support](http://www.vevor.com/support)

This is the original instruction, please read all manual instructions carefully before operating. VEVOR reserves a clear interpretation of our user manual. The appearance of the product shall be subject to the product you received. Please forgive us that we won't inform you again if there are any technology or software updates on our product.



Waarschuwing-Om het risico op letsel te verminderen, moet de gebruiker de handleiding zorgvuldig lezen.



Code	Naam	AAN TAL.	Code	Naam	AAN TAL.
A	Doucherand	2	G	Hoeken waterdicht maken 1	4
B	Waterdicht membraan	1	H	Waterdichte strip	1
C	Dienblad	1	I	Hoeken waterdicht maken 2	2
D	Troffel	1	J	Afvoerafstelring	1

E	Mengklepafdichting	1	K	Verbindingsflens	1
F	Pijpafdichting	1	L	Afvoerrooster	1

◆ Het aantal Waterdichtingsstrips (H) van JQ-7272A en JQ-7272P zijn 2 stuks.

Keramische en stenen tegels zijn duurzaam, gemakkelijk te onderhouden en hygiënisch en vormen de ideale oppervlaktebedekking, vooral in natte ruimtes zoals douches en badkuipen.

Deze bekledingen zijn echter niet inherent waterdicht. Ze moeten worden geïnstalleerd in combinatie met een waterdichtingssysteem dat effectief vocht beheert om vochtgevoelige bouwmaterialen te beschermen en schimmelgroei onder controle te houden.

Model	Specificatie (inch)	Kleur	Flens materiaal	Douchebakgat
JQ-3860PA	38*60	Grijs	buikspieren	Offset
JQ-3860ZA	38*60		buikspieren	centrum
JQ-3860ZP	38*60		PVC	centrum
JQ3860PP	38*60		PVC	Offset
JQ-4848A	48*48		buikspieren	centrum
JQ-4848P	48*48		PVC	centrum
JQ-4860A	48*60		buikspieren	centrum
JQ-4860P	48*60		PVC	centrum
JQ-4872A	48*72		buikspieren	centrum

JQ-4872P	48*72		PVC	centrum
JQ-7272A	72*72		buikspier en	centrum
JQ-7272P	72*72		PVC	centrum

## INSTALLATIESTAPPEN

◆ Verwijder stof en ander vuil van het oppervlak van de stevige achterkant. Bevochtig vooral droge en poreuze ondergronden om voortijdige uitdroging of huidverkleuring van de dunbedmortel te helpen voorkomen.

### Stap 1:

	
Mortel voorbereiden	Borstel de mortel
	
Bedek het membraan	Knip het membraan af



Maak het gelijk



Werk het membraan af

## Stap 2 :



Bedek de waterdichtingsstrip  
de hoek



Knip de strook af



Borstel de mortel



Bedek de waterdichtingsstrip  
het gewricht



Knip de strook af

Maak het muuroppervlak egaal

### Stap 3 :



Dek de afdichting van de mengklep af



Maak het oppervlak egaal

### Stap 4 :



Vouw de lade open



Plaats de lade in de mortel

### Stap 5 :



Borstel de mortel



Installeer de waterdichtingshoeken



1

	<p>Knip de hoek af</p>
--	------------------------

**Stap 6 :**

	
<p>Borstel de mortel</p>	<p>Bedek de waterdichtingsstrip</p>
	
<p>Maak het oppervlak egaal</p>	

**Stap 7 :**

	
<p>Borstel de mortel</p>	<p>Bedek de buisafdichting</p>



Snijd de buisafdichting af

## Stap 8 :



Borstel de mortel



Druk de lijmflens in de mortel



Draai de flens om deze stevig vast te zetten



Borstel de mortel rond



Snijd het oppervlak af



Bedek het waterdichtingsmembraan





Maak het oppervlak egaal

### Stap 9 :



Installeer de afvoerafstelring



Zorg voor volledige dekking

### Stap 10 :



Borstel de mortel



Druk op de stoeprand





Zet de stoeprand stevig vast

### Stap 11 :

	
Borstel de mortel	Bedek de waterdichtingshoeken 2
	Knip de hoek af

## Stap 12 :

	
Bedek de waterdichtingsstrip	Knip de strook af

**De installatie van het waterdichte systeem is voltooid.**

**Adres:** Baoshanqu Shuangchenglu 803long 11hao 1602A-1609shi  
Shanghai

**Geïmporteerd naar AUS:** SIHAO PTY LTD, 1 ROKEVA  
STREETEASTWOOD NSW 2122 Australië

**Geïmporteerd naar de VS:** Sanven Technology Ltd., Suite 250, 9166  
Anaheim Place, Rancho Cucamonga, CA 91730



Pooledas Group Ltd  
Unit 5 Albert Edward House, The Pavilions  
Preston, United Kingdom



SHUNSHUN GmbH  
Römeräcker 9 Z2021, 76351  
Linkenheim-Hochstetten, Germany

**Gemaakt in China**

**VEVOR<sup>®</sup>**

**TOUGH TOOLS, HALF PRICE**

**Technisch Ondersteuning en e-garantiecertificaat**

**[www.vevor.com/support](http://www.vevor.com/support)**

# **VEVOR<sup>®</sup>**

## **TOUGH TOOLS, HALF PRICE**

Teknisk Support och e-garanticertifikat [www.vevor.com/support](http://www.vevor.com/support)

**VATTENTÄTT DUSCHUNDERLAG**

**MODELL:**

**JQ-3860PA /JQ-3860ZA/JQ-3860ZP/JQ3860PP**

**JQ-4848AJQ-4848P/ JQ-4860A /JQ-4860P**

**JQ-4872AJQ\*4872P/JQ-7272AJQ-7272P**

We continue to be committed to provide you tools with competitive price.

"Save Half", "Half Price" or any other similar expressions used by us only represents an estimate of savings you might benefit from buying certain tools with us compared to the major top brands and dose not necessarily mean to cover all categories of tools offered by us. You are kindly reminded to verify carefully when you are placing an order with us if you are actually saving half in comparison with the top major brands.

# VEVOR®

TOUGH TOOLS, HALF PRICE

WATERPROOF SHOWER  
SUBSTRATE

MODELL: JQ-3860PA / JQ-3860ZA / JQ-3860ZP / JQ3860PP  
JQ-4848AJQ-4848P / JQ-4860A / JQ-4860P  
JQ-4872A / JQ\*4872P / JQ-7272A / JQ-7272P

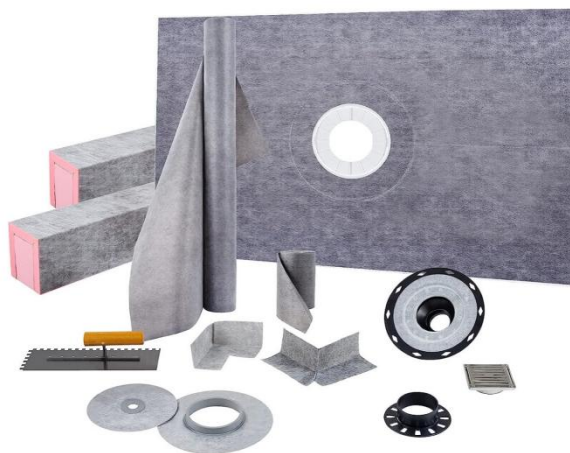

## NEED HELP? CONTACT US!

Have product questions? Need technical support? Please feel free to contact us:

**Technical Support and E-Warranty Certificate**  
[www.vevor.com/support](http://www.vevor.com/support)

This is the original instruction, please read all manual instructions carefully before operating. VEVOR reserves a clear interpretation of our user manual. The appearance of the product shall be subject to the product you received. Please forgive us that we won't inform you again if there are any technology or software updates on our product.



Varning - För att minska risken för skada måste användaren läsa instruktionerna noggrant.

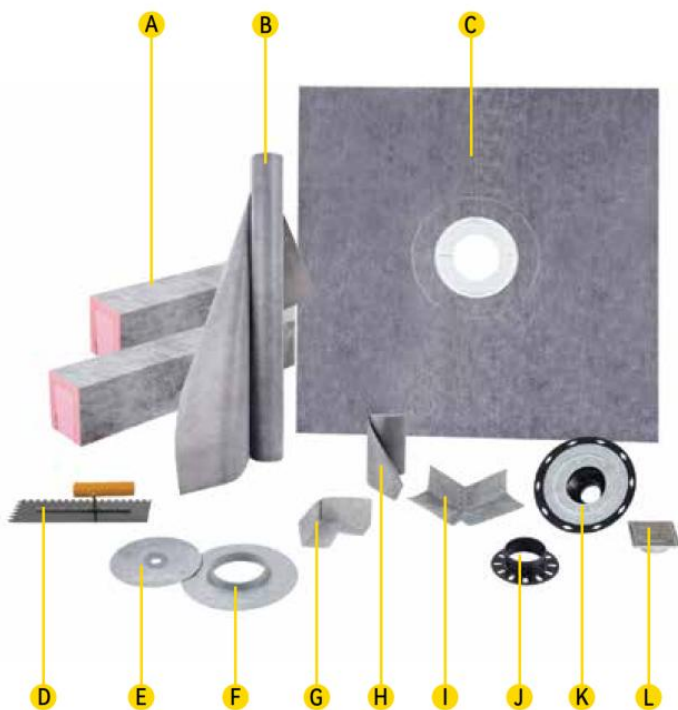

Koda	namn	ANT AL.	Koda	namn	ANT AL.
A	Duschkant	2	G	Vattentäta hörn 1	4
B	Vattentätande membran	1	H	Vattentätningstremsa	1
C	Bricka	1	I	Vattentäta hörn 2	2
D	Murslev	1	J	Avloppsjusteringsring	1

E	Blandningsventiltätning	1	K	Limfläns	1
F	Rörtätning	1	L	Töm gallret	1

◆ Antalet Vattentätningsskivor (H) av JQ-7272A och JQ-7272P är 2 st.

Keramiska plattor och stenplattor är hållbara, lätta att underhålla och hygieniska, vilket representerar den idealiska ytbeläggningen, särskilt i våta utrymmen som duschar och badkar.

Dessa beläggningar är dock inte i sig vattentäta. De måste installeras i samband med ett vattentätningssystem som effektivt hanterar fukt för att skydda fuktkänsliga byggmaterial och kontrollera mögeltillväxt.

Modell	Specifikation (tum)	Färg	Flänsmaterial	Hål för duschar
JQ-3860PA	38*60	grå	magmus kler	Offset
JQ-3860ZA	38*60		magmus kler	Centrum
JQ-3860ZP	38*60		PVC	Centrum
JQ3860PP	38*60		PVC	Offset
JQ-4848A	48*48		magmus kler	Centrum
JQ-4848P	48*48		PVC	Centrum
JQ-4860A	48*60		magmus kler	Centrum
JQ-4860P	48*60		PVC	Centrum
JQ-4872A	48*72		magmus kler	Centrum
JQ-4872P	48*72		PVC	Centrum
JQ-7272A	72*72		magmus kler	Centrum



JQ-7272P	72*72		PVC	Centrum
----------	-------	--	-----	---------

## INSTALLATIONSSTEG

◆ Ta bort allt damm eller annat skräp från ytan på den fasta baksidan.  
Fukta särskilt torra och porösa underlag för att förhindra för tidig torkning eller avskalning av det tunna bruket.

### Steg 1:

	
Förbered murbruk	Borsta murbruket
	
Täck membranet	Trimma membranet
	

Gör det jämnt

Slutför täckning av membranet

## Steg 2 :



Täck tätskiktet på  
hörnet



Trimma remsan



Borsta murbruket



Täck tätskiktet på  
leden



Trimma remsan



Gör väggytan jämn

## Steg 3 :



Täck blandningsventilens tätning



Gör ytan jämn

#### Steg 4 :



Vik ut brickan



Bädda in brickan i murbruket

#### Steg 5 :



Borsta murbruket



Montera de vattentäta hörnen 1



Trimma hörnet

## Steg 6 :



Borsta murbruket



Täck vattentättningsremsan



Gör ytan jämn

## Steg 7 :



Borsta murbruket









Täck rörtätningen



Trimma rörtätningen

## Steg 8 :

	
<p>Borsta murbruket</p>	<p>Pressa in limflänsen i murbruket</p>
	
<p>Vrid flänsen för att fixera den ordentligt</p>	<p>Borsta murbruket runt</p>
	
<p>Trimma ytan</p>	<p>Täck vattentätningmembranet</p>
	<p>Gör ytan jämn</p>

## Steg 9 :



Montera avloppsjusteringsringen



Säkerställ full täckning

## Steg 10 :



Borsta murbruket



Tryck på trottoarkanten



Fixera trottoarkanten  
ordentligt

## Steg 11 :



Borsta murbruket



Täck vattentätningshörnen 2



Trimma hörnet

## Steg 12 :



Täck vattentättningsremsan



Trimma remsan

## Installation av vattentätt system är klar.

**Adress:** Baoshanqu Shuangchenglu 803long 11hao 1602A-1609shi  
Shanghai

**Importerad till AUS:** SIHAO PTY LTD, 1 ROKEVA STREETEASTWOOD  
NSW 2122 Australien

**Importerad till USA:** Sanven Technology Ltd., Suite 250, 9166 Anaheim  
Place, Rancho Cucamonga, CA 91730

<b>UK</b>	<b>REP</b>
-----------	------------

Pooledas Group Ltd  
Unit 5 Albert Edward House, The Pavilions  
Preston, United Kingdom

<b>EC</b>	<b>REP</b>
-----------	------------

SHUNSHUN GmbH  
Römeräcker 9 Z2021, 76351  
Linkenheim-Hochstetten, Germany

**Tillverkad i Kina**



**VEVOR<sup>®</sup>**

**TOUGH TOOLS, HALF PRICE**

**Teknisk Support och e-garanticertifikat**

**[www.vevor.com/support](http://www.vevor.com/support)**