

VEVOR[®]

TOUGH TOOLS, HALF PRICE

Technical Support and E-Warranty Certificate www.vevor.com/support

HEAVY DUTY DRAWER SLIDES

MODEL:5301 / 5301Z

We continue to be committed to provide you tools with competitive price. "Save Half", "Half Price" or any other similar expressions used by us only represents an estimate of savings you might benefit from buying certain tools with us compared to the major top brands and does not necessarily mean to cover all categories of tools offered by us. You are kindly reminded to verify carefully when you are placing an order with us if you are actually Saving Half in comparison with the top major brands.

VEVOR®

TOUGH TOOLS, HALF PRICE

HEAVY DUTY DRAWER SLIDES

MODEL:5301 / 5301Z



NEED HELP? CONTACT US!

Have product questions? Need technical support? Please feel free to contact us:

Technical Support and E-Warranty Certificate
www.vevor.com/support

This is the original instruction, please read all manual instructions carefully before operating. VEVOR reserves a clear interpretation of our user manual. The appearance of the product shall be subject to the product you received. Please forgive us that we won't inform you again if there are any technology or software updates on our product.



Warning-To reduce the risk of injury, user must read instructions manual carefully.





WARNING:

1. Please assemble the product in strict accordance with the instructions. Incorrect assembly could be hazardous.
 2. Please wear safety goggles and work gloves properly during assembly.
 3. Do not try to assemble the product when feeling tired or when under the influence of alcohol, drugs, or medication.
 4. Load-bearing capacity and other product parameters are applied to the properly and completely assembled product only.
 5. Separate and count all parts and hardware.
 6. Prepare the following tool: Philips Head Screwdriver.
 7. If using power tools, please be careful to slow down and stop when needed.
 8. Two people are required for assembly.
 9. Follow the intended uses only.
- Save the instructions.





Attention:

1. Pay attention to waterproof and moisture-proof, should not be placed in the open air, wet or chemical environment.
2. Pay attention to strong chemicals, do not use strong chemicals, cleaning agents or strong detergents to clean products. Clean the appearance of the product stains can be wiped with a clean cloth.
3. Pay attention to anti-high temperature, do not put the product in an environment where the temperature is too high (recommended product environmental requirements: working temperature :-10°C-50°C).

5301/5301Z-16"~5301/5301Z-30"

Part List					
Code	Picture	Qty.	Code	Picture	Qty.
1		1	2		1
3		16	4		16

5301/5301Z-32"~5301/5301Z-60"

Part List					
Code	Picture	Qty.	Code	Picture	Qty.
1		1	2		1
3		24	4		24

Installation Procedure (Method 1)

1. Pay attention to the installation space on both sides. (Units: mm)



2. Install the outer rail.

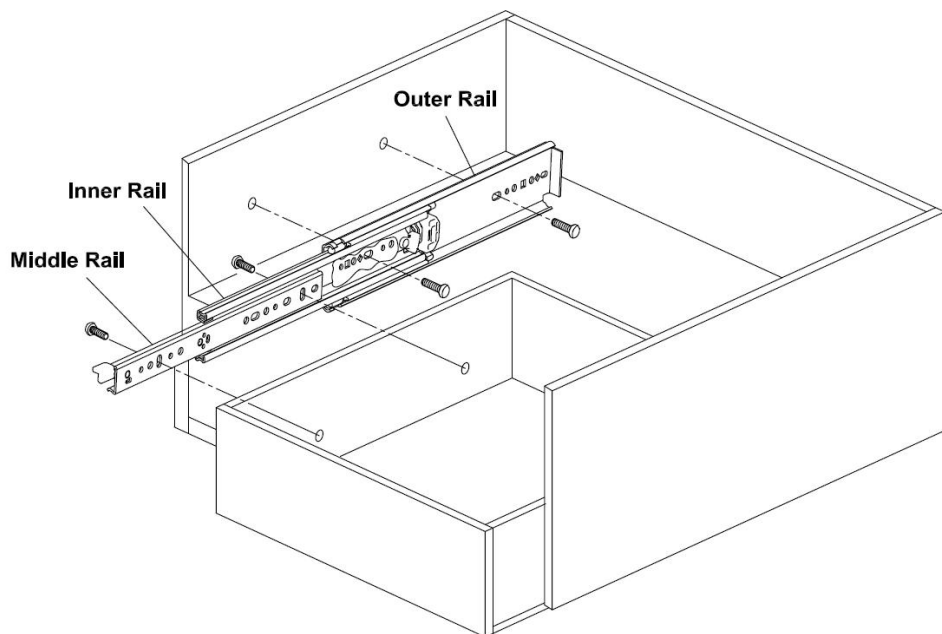

3.Install the drawer.

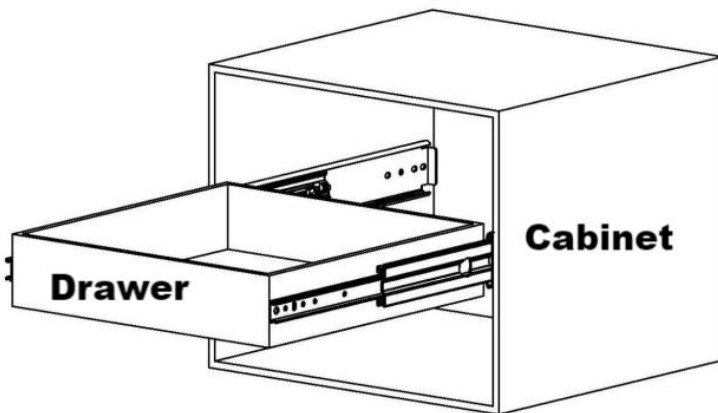

Press To Unlock



Installation Procedure(Method 2)

1.Pay attention to the installation space on both sides. (Units: mm)

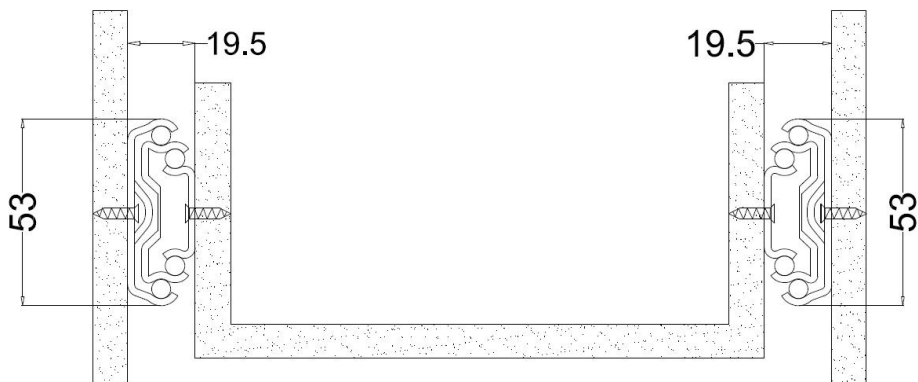

2. Install the outer rail.

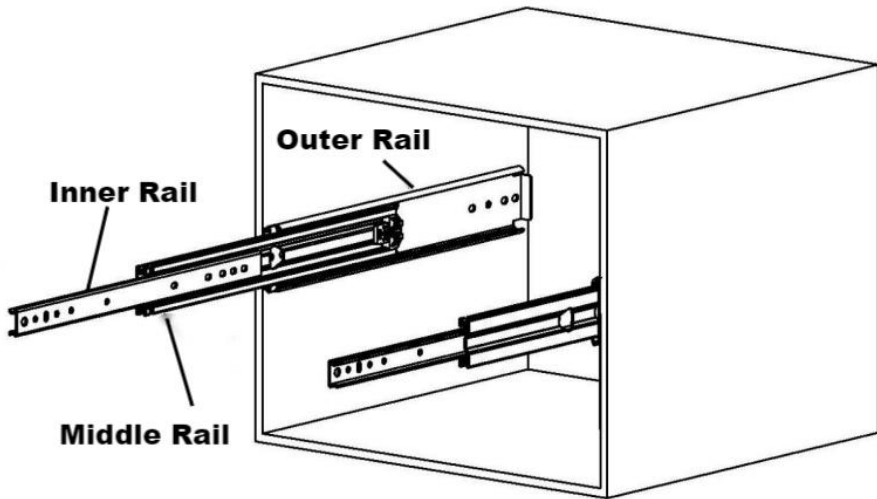

3. Install the drawer.

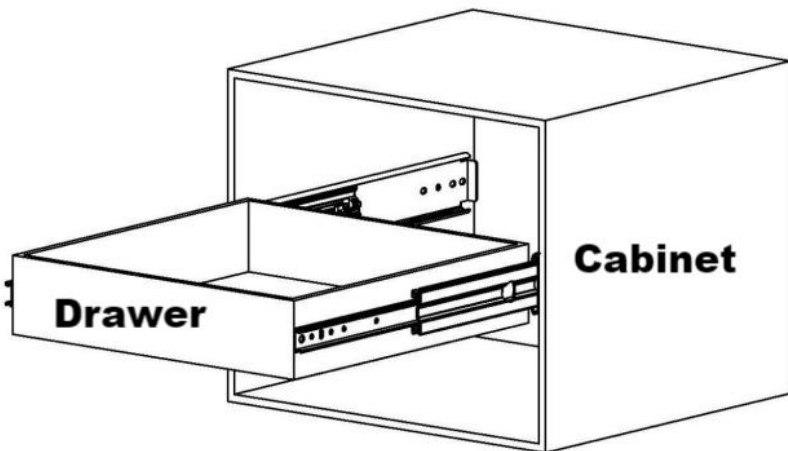

Press To Unlock



Manufacturer: Shanghaimuxinmuyeyouxiangongsi

Address: Shuangchenglu 803nong11hao1602A-1609shi, baoshanqu, shanghai 200000 CN.

Imported to AUS: SIHAO PTY LTD. 1 ROKEVA STREETEASTWOOD NSW 2122 Australia

Imported to USA: Sanven Technology Ltd. Suite 250, 9166 Anaheim Place, Rancho Cucamonga, CA 91730

UK	REP
-----------	------------

YH CONSULTING LIMITED.

C/O YH Consulting Limited Office 147,
Centurion House, London Road,
Staines-upon-Thames, Surrey, TW18 4AX

EC	REP
-----------	------------

E-CrossStu GmbH
Mainzer Landstr.69,
60329 Frankfurt am Main.

VEVOR®

TOUGH TOOLS, HALF PRICE

Technical Support and E-Warranty Certificate

www.vevor.com/support

VEVOR[®]

TOUGH TOOLS, HALF PRICE

Assistance technique et certificat de garantie électronique www.vevor.com/support

COULISSES DE TIROIRS À USAGE INTENSIF

MODÈLE : 5301 / 5301Z

Nous continuons à nous engager à vous fournir des outils à des prix compétitifs.

« Économisez la moitié », « Moitié prix » ou toute autre expression similaire utilisée par nous ne représente qu'une estimation des économies que vous pourriez réaliser en achetant certains outils chez nous par rapport aux grandes marques et ne couvre pas nécessairement toutes les catégories d'outils que nous proposons. Nous vous rappelons de bien vouloir vérifier soigneusement lorsque vous passez une commande chez nous si vous économisez réellement la moitié par rapport aux grandes marques.

VEVOR[®]
TOUGH TOOLS, HALF PRICE

TIROIR À USAGE INTENSIF

DIAPOSITIVES

MODÈLE : 5301 / 5301Z



BESOIN D'AIDE? CONTACTEZ-NOUS!

Vous avez des questions sur nos produits ? Vous avez besoin d'assistance technique ?
N'hésitez pas

à nous contacter : Assistance technique et certificat de garantie
électronique www.vevor.com/support

Il s'agit de la notice d'utilisation d'origine. Veuillez lire attentivement toutes les instructions du manuel avant de l'utiliser. VEVOR se réserve le droit d'interpréter clairement notre manuel d'utilisation. L'apparence du produit dépend du produit que vous avez reçu. Veuillez nous excuser, nous ne vous informerons plus en cas de mise à jour technologique ou logicielle de notre produit.



Avertissement - Pour réduire le risque de blessure, l'utilisateur doit lire
Lisez attentivement le manuel d'instructions.

AVERTISSEMENT:

1. Veuillez assembler le produit en stricte conformité avec les instructions.

Un assemblage incorrect peut être dangereux.

2. Veuillez porter des lunettes de sécurité et des gants de travail correctement pendant l'assemblage.

3. N'essayez pas d'assembler le produit lorsque vous vous sentez fatigué ou sous la influence de l'alcool, de drogues ou de médicaments.

4. La capacité de charge et d'autres paramètres du produit sont appliqués à la produit correctement et complètement assemblé uniquement.

5. Séparez et comptez toutes les pièces et le matériel.

6. Préparez l'outil suivant : tournevis cruciforme.

7. Si vous utilisez des outils électriques, veillez à ralentir et à vous arrêter lorsque nécessaire.

8. Deux personnes sont nécessaires pour l'assemblage.

9. Respecter uniquement les utilisations prévues.

Conservez les instructions.

Attention:

1. Faites attention à l'imperméabilité et à la résistance à l'humidité, ne doit pas être placé dans l'air libre, l'environnement humide ou chimique.

2. Faites attention aux produits chimiques forts, n'utilisez pas de produits chimiques forts, de nettoyage agents ou détergents puissants pour nettoyer les produits. Nettoyez l'apparence des taches du produit peuvent être essuyées avec un chiffon propre.

3. Faites attention aux températures élevées, ne mettez pas le produit dans un environnement où la température est trop élevée (produit recommandé exigences environnementales : température de fonctionnement : -10 -50).

Liste des pièces détachées 5301/5301Z-16"~5301/5301Z-30"					
Code	Image	Qté.	Code	Image	Qté.
1		1	2		1
3		16	4		16

Liste des pièces détachées 5301/5301Z-32"~5301/5301Z-60"					
Code	Image	Qté.	Code	Image	Qté.
1		1	2		1
3		24	4		24

Présentation du produit

Modèle	Tiroir applicable Longueur (pouce)	Longueur de glissement (mm)	Charge max. (kg / lb)
5301/5301Z-16"	16,5	400	106/ 234
5301/5301Z-18"	18,5	450	113/ 250
5301/5301Z-20"	20,5	500	105/ 233
5301/5301Z-24"	24,5	600	98/ 216
5301/5301Z-30"	30,5	750	80/176,5
5301/5301Z-36"	36,5	900	61/134,6
5301/5301Z-38"	38,5	950	54/119
5301/5301Z-60"	60,5	1500	39/85

Schéma de perçage d'installation 5301/5301Z (unités : mm)

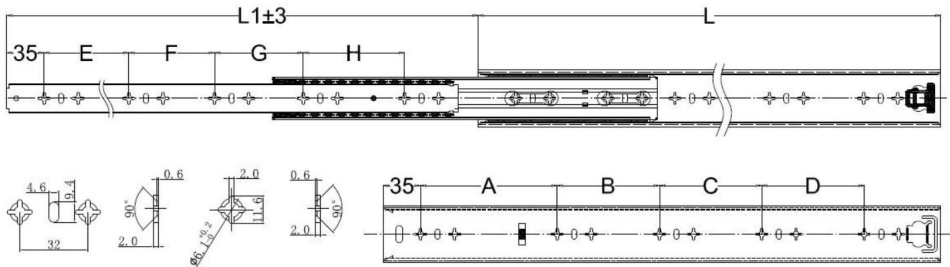

Ltem No	L	L1	A	B	C	D	E	F	G	H
16"	400	405	128	128	/	/	128	128	/	/
18"	450	455	160	160	/	/	128	224	/	/
20"	500	513	128	224	/	/	128	224	/	/
24"	600	612	160	160	160	/	224	256	/	/
30"	750	765	224	224	192	/	224	224	192	/
36"	900	902	256	256	256	/	256	256	256	/
38"	950	957	256	256	288	/	256	288	256	/
60"	1500	1510	352	352	352	320	320	352	352	320

Procédure d'installation (méthode 1)

1. Faites attention à l'espace d'installation des deux côtés. (Unités : mm)

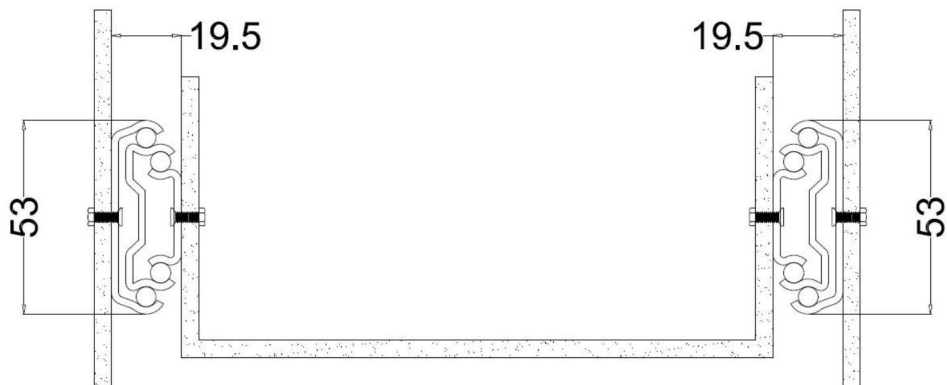

2. Installez le rail extérieur.

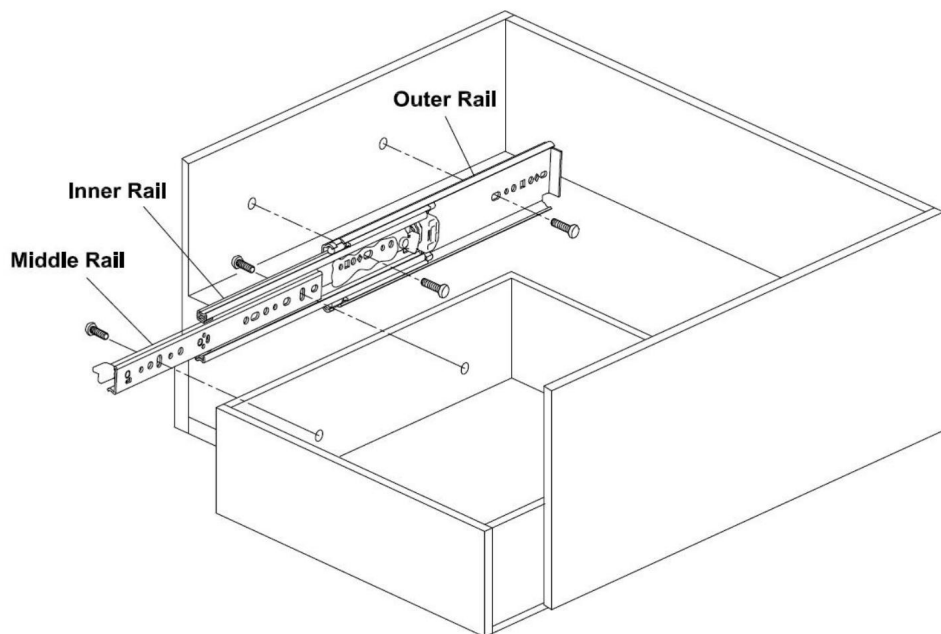

3. Installez le tiroir.

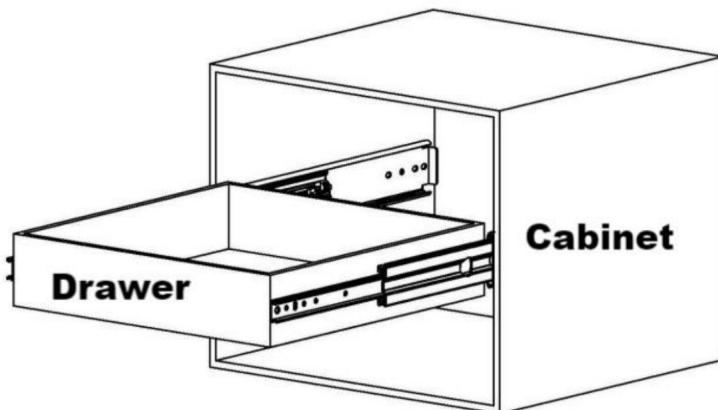

Press To Unlock

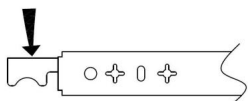

Procédure d'installation (méthode 2)

1. Faites attention à l'espace d'installation des deux côtés. (Unités : mm)

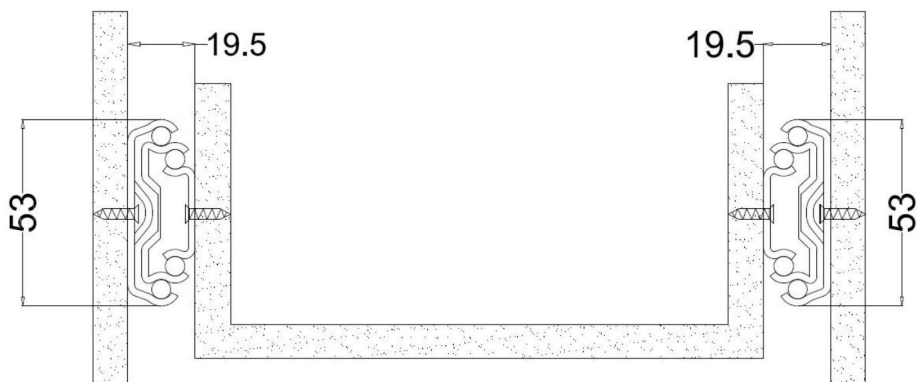

2. Installez le rail extérieur.

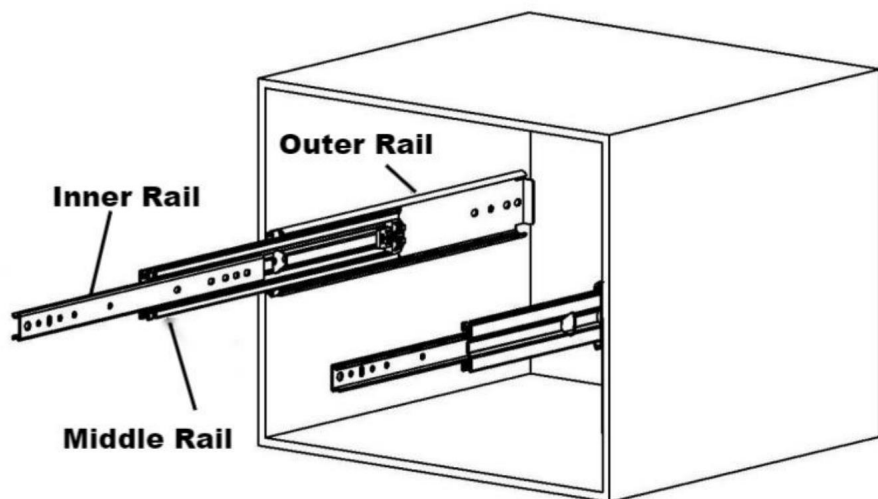

3. Installez le tiroir.

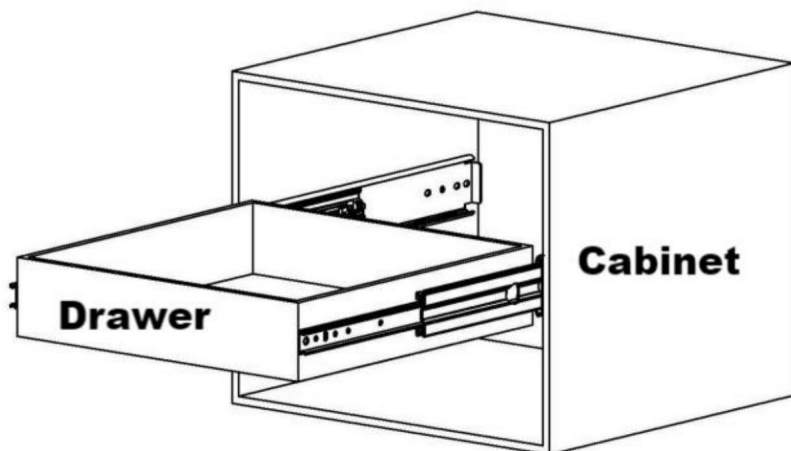

Press To Unlock

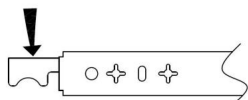

Fabricant : Shanghaimuxinmuyeyouxiangongsi

Adresse : Shuangchenglu 803nong11hao1602A-1609shi, baoshanqu, Shanghai
200000 CN.

Importé en Australie : SIHAO PTY LTD. 1 ROKEVA STREETEASTWOOD
NSW 2122 Australie

Importé aux États-Unis : Sanven Technology Ltd. Suite 250, 9166 Anaheim
Lieu, Rancho Cucamonga, CA 91730



YH CONSULTING LIMITÉE.

A/S YH Consulting Limited Bureau 147,
Centurion House, London Road,
Staines-upon-Thames, Surrey, TW18 4AX



E-CrossStu GmbH

Mainzer Landstr.69,
60329 Francfort-sur-le-Main.

VEVOR®

TOUGH TOOLS, HALF PRICE

Assistance technique et certificat de garantie
électronique www.vevor.com/support

VEVOR[®]

TOUGH TOOLS, HALF PRICE

Technischer Support und E-Garantie-Zertifikat www.vevor.com/support

SCHWERLAST-SCHUBLADENFÜHRUNGEN

MODELL:5301 / 5301Z

Wir sind weiterhin bestrebt, Ihnen Werkzeuge zu wettbewerbsfähigen Preisen anzubieten. „Sparen Sie die Hälfte“, „Halber Preis“ oder andere ähnliche Ausdrücke, die wir verwenden, stellen nur eine Schätzung der Ersparnis dar, die Sie beim Kauf bestimmter Werkzeuge bei uns im Vergleich zu den großen Topmarken erzielen können, und decken nicht unbedingt alle von uns angebotenen Werkzeugkategorien ab. Wir möchten Sie freundlich daran erinnern, bei Ihrer Bestellung bei uns sorgfältig zu prüfen, ob Sie im Vergleich zu den großen Topmarken tatsächlich die Hälfte sparen.

VEVOR[®]
TOUGH TOOLS, HALF PRICE

SCHWERE SCHUBLADE
Folien

MODELL: 5301 / 5301Z



Brauchen Sie Hilfe? Kontaktieren Sie uns!

Haben Sie Fragen zum Produkt? Benötigen Sie technischen Support? Bitte kontaktieren Sie uns:

Technischer Support und E-Garantie-Zertifikat www.vevor.com/support

Dies ist die Originalanleitung. Bitte lesen Sie alle Anweisungen sorgfältig durch, bevor Sie das Gerät in Betrieb nehmen. VEVOR behält sich eine klare Auslegung unserer Bedienungsanleitung vor. Das Erscheinungsbild des Produkts richtet sich nach dem Produkt, das Sie erhalten haben. Bitte verzeihen Sie uns, dass wir Sie nicht erneut informieren, wenn es Technologie- oder Software-Updates für unser Produkt gibt.



Warnung-Um das Verletzungsrisiko zu verringern, muss der Benutzer

Lesen Sie die Bedienungsanleitung sorgfältig durch.

WARNUNG:

1. Bitte montieren Sie das Produkt streng gemäß der Anleitung.

Eine falsche Montage kann gefährlich sein.

2. Bitte tragen Sie während der Montage eine Schutzbrille und Arbeitshandschuhe.

3. Versuchen Sie nicht, das Produkt zusammenzubauen, wenn Sie müde sind oder unter Einfluss von Alkohol, Drogen oder Medikamenten.

4. Die Tragfähigkeit und andere Produktparameter werden auf die
Nur ordnungsgemäß und vollständig montiertes Produkt.

5. Trennen und zählen Sie alle Teile und die Hardware.

6. Bereiten Sie das folgende Werkzeug vor: Kreuzschlitzschraubendreher.

7. Achten Sie bei der Verwendung von Elektrowerkzeugen darauf, die Geschwindigkeit zu verringern und anzuhalten, erforderlich.

8. Für die Montage sind zwei Personen erforderlich.

9. Befolgen Sie nur die vorgesehenen Verwendungszwecke.

Bewahren Sie die Anleitung auf.

Aufmerksamkeit:

1. Achten Sie auf wasserdicht und feuchtigkeitsbeständig, sollte nicht in
die freie Luft, feuchte oder chemische Umgebung.

2. Achten Sie auf starke Chemikalien, verwenden Sie keine starken Chemikalien, Reinigungsmittel
oder starke Reinigungsmittel zum Reinigen von Produkten. Reinigen Sie das Aussehen von
Die Produktflecken können mit einem sauberen Tuch abgewischt werden.

3. Achten Sie auf anti-hohe Temperatur, legen Sie das Produkt nicht in eine
Umgebung mit zu hohen Temperaturen (empfohlenes Produkt

Umweltanforderungen: Arbeitstemperatur: -10 °C–50 °C).

5301/5301Z-16"~5301/5301Z-30"Teilleiste					
Code	Bild	Menge Code		Bild	Stk.
1		1	2		1
3		16	4		16

5301/5301Z-32"~5301/5301Z-60"Teilleiste					
Code	Bild	Menge Code		Bild	Stk.
1		1	2		1
3		24	4		24

Produkteinführung

Modell	Anwendbare Schublade Länge (Zoll)	Gleitlänge (mm)	Max. Belastung (kg / Pfund)
5301/5301Z-16"	16,5	400	106/ 234
5301/5301Z-18"	18,5	450	113/ 250
5301/5301Z-20"	20,5	500	105/ 233
5301/5301Z-24"	24,5	600	98/ 216
5301/5301Z-30"	30,5	750	80/176,5
5301/5301Z-36"	36,5	900	61/134,6
5301/5301Z-38"	38,5	950	54/119
5301/5301Z-60"	60,5	1500	39/85

5301/5301Z Installationslochmuster (Einheiten: mm)

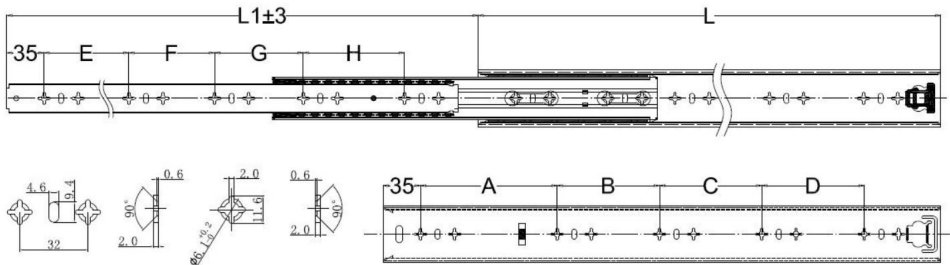

Ltem No	L	L1	A	B	C	D	E	F	G	H
16"	400	405	128	128	/	/	128	128	/	/
18"	450	455	160	160	/	/	128	224	/	/
20"	500	513	128	224	/	/	128	224	/	/
24"	600	612	160	160	160	/	224	256	/	/
30"	750	765	224	224	192	/	224	224	192	/
36"	900	902	256	256	256	/	256	256	256	/
38"	950	957	256	256	288	/	256	288	256	/
60"	1500	1510	352	352	352	320	320	352	352	320

Installationsverfahren (Methode 1)

1. Achten Sie auf den Installationsraum auf beiden Seiten. (Einheiten: mm)

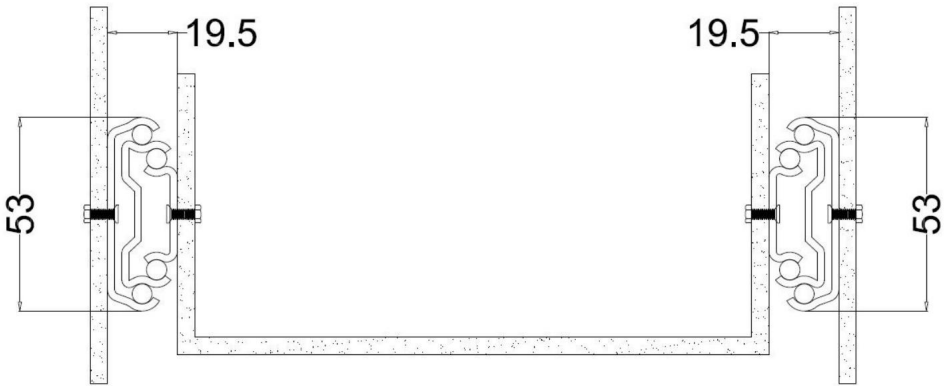

2. Installieren Sie die äußere Schiene.

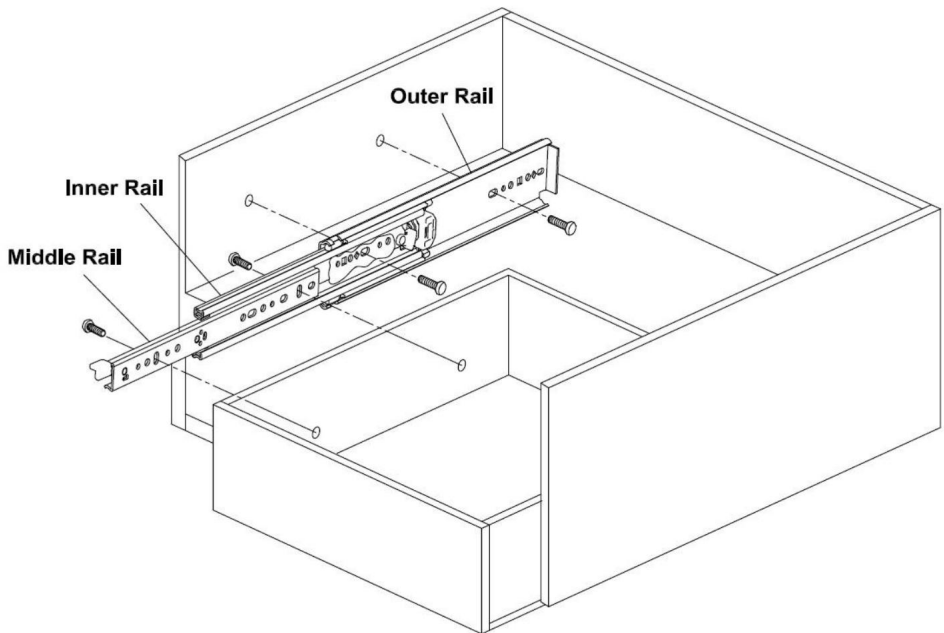

3. Installieren Sie die Schublade.

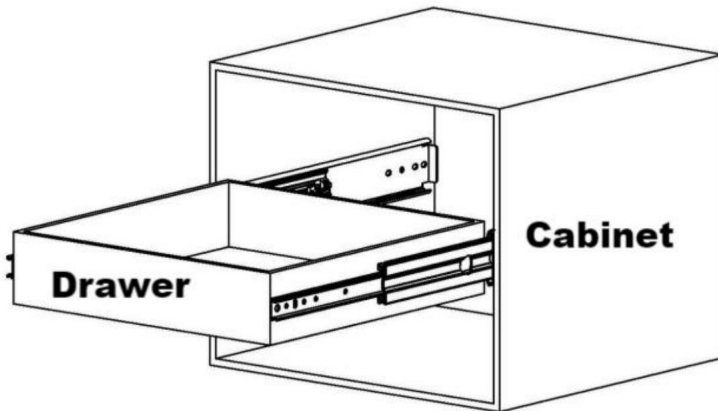

Press To Unlock

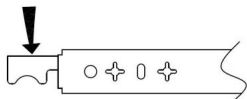

Installationsverfahren (Methode 2)

1. Achten Sie auf den Installationsraum auf beiden Seiten. (Einheiten: mm)

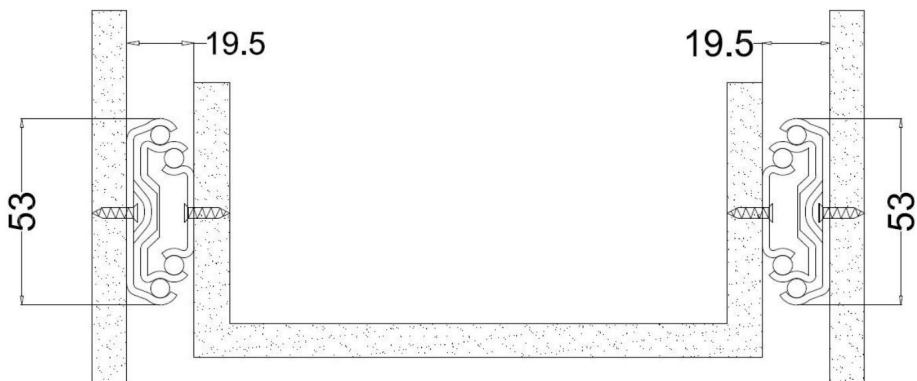

2. Installieren Sie die äußere Schiene.

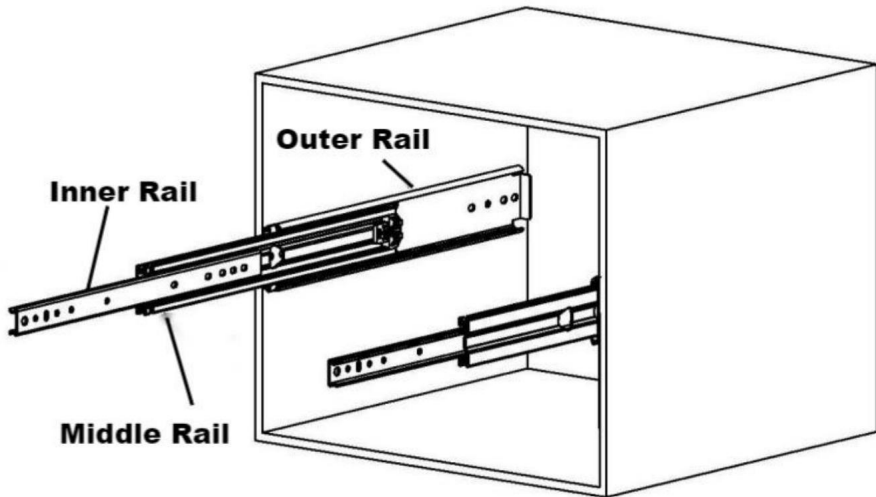

3. Installieren Sie die Schublade.

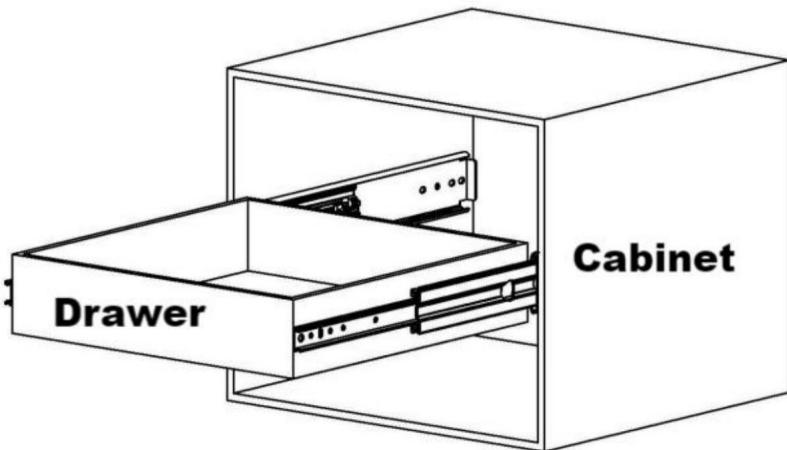

Press To Unlock

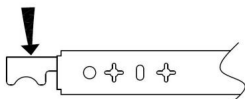

Hersteller: Shanghaimuxinmuyeyouxiangongsi

Adresse: Shuangchenglu 803nong11hao1602A-1609shi, baoshanqu, Shanghai 200000 CN.

Nach AUS importiert: SIHAO PTY LTD. 1 ROKEVA STREETEASTWOOD NSW 2122 Australien

Importiert in die USA: Sanven Technology Ltd. Suite 250, 9166 Anaheim Ort, Rancho Cucamonga, CA 91730



YH CONSULTING LIMITED.

C/O YH Consulting Limited Office 147,
Centurion House, London Road,
Staines-upon-Thames, Surrey, TW18 4AX

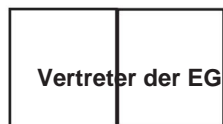

E-CrossStu GmbH

Mainzer Landstr.69,
60329 Frankfurt am Main.

VEVOR®

TOUGH TOOLS, HALF PRICE

Technischer Support und E-Garantie-Zertifikat

www.vevor.com/support

VEVOR[®]

TOUGH TOOLS, HALF PRICE

Supporto tecnico e certificato di garanzia elettronica www.vevor.com/support

GUIDE PER CASSETTI PER IMPIEGHI PESANTI

MODELLO:5301 / 5301Z

Continuiamo a impegnarci per fornirvi strumenti a prezzi competitivi.

"Risparmia la metà", "Metà prezzo" o qualsiasi altra espressione simile da noi utilizzata rappresenta solo una stima del risparmio che potresti ottenere acquistando determinati utensili con noi rispetto ai principali marchi principali e non significa necessariamente coprire tutte le categorie di utensili da noi offerti. Ti ricordiamo gentilmente di verificare attentamente quando effettui un ordine con noi se stai effettivamente risparmiando la metà rispetto ai principali marchi principali.

VEVOR[®]
TOUGH TOOLS, HALF PRICE

CASSETTO PER LAVORI PESANTI

DIAPOSITIVE

MODELLO:5301 / 5301Z



HAI BISOGNO DI AIUTO? CONTATTACI!

Hai domande sul prodotto? Hai bisogno di supporto tecnico? Non esitare a contattarci: **Supporto tecnico e**

certificato di garanzia elettronica www.vevor.com/support

Questa è l'istruzione originale, si prega di leggere attentamente tutte le istruzioni del manuale prima di utilizzare. VEVOR si riserva una chiara interpretazione del nostro manuale utente. L'aspetto del prodotto sarà soggetto al prodotto ricevuto. Vi preghiamo di perdonarci se non vi informeremo di nuovo se ci sono aggiornamenti tecnologici o software sul nostro prodotto.



Attenzione: per ridurre il rischio di lesioni, l'utente deve leggere attentamente il manuale di istruzioni.

AVVERTIMENTO:

1. Si prega di montare il prodotto seguendo scrupolosamente le istruzioni.
Un montaggio non corretto potrebbe rivelarsi pericoloso.
2. Durante il montaggio, indossare occhiali protettivi e guanti da lavoro.
3. Non tentare di montare il prodotto quando ci si sente stanchi o sotto sforzo.
influenza di alcol, droghe o farmaci.
4. La capacità portante e altri parametri del prodotto vengono applicati al solo prodotti correttamente e completamente assemblati.
5. Separare e contare tutte le parti e l'hardware.
6. Preparare il seguente utensile: cacciavite a croce.
7. Se si utilizzano utensili elettrici, fare attenzione a rallentare e fermarsi quando necessario.
8. Per il montaggio sono necessarie due persone.
9. Attenersi esclusivamente agli usi previsti.
Salva le istruzioni.

Attenzione:

1. Prestare attenzione all'impermeabilità e all'umidità, non deve essere posizionato in all'aria aperta, in ambiente umido o chimico.
2. Prestare attenzione ai prodotti chimici aggressivi, non utilizzare prodotti chimici aggressivi, pulizia agenti o detersivi forti per pulire i prodotti. Pulire l'aspetto di
le macchie di prodotto possono essere eliminate con un panno pulito.
3. Prestare attenzione alle alte temperature, non mettere il prodotto in un ambiente in cui la temperatura è troppo elevata (prodotto consigliato requisiti ambientali: temperatura di esercizio: -10ÿ-50ÿ).

Elenco dei pezzi 5301/5301Z-16"~5301/5301Z-30"					
Codice	Immagine	Quantità	Codice	Immagine	Quantità
1		1	2		1
3		16	4		16

Elenco dei pezzi 5301/5301Z-32"~5301/5301Z-60"					
Codice	Immagine	Quantità	Codice	Immagine	Quantità
1		1	2		1
3		24	4		24

Introduzione al prodotto

Modello	Cassetto applicabile Lunghezza (pollici)	Lunghezza scorrevole (mm)	Carico massimo (kg / libbre)
5301/5301Z-16"	16.5	400	106/234
5301/5301Z-18"	18.5	450	113/ 250
5301/5301Z-20"	20.5	500	105/233
5301/5301Z-24"	24.5	600	98/ 216
5301/5301Z-30"	30.5	750	80/176,5
5301/5301Z-36"	36.5	900	61/134.6
5301/5301Z-38"	38.5	950	54/119
5301/5301Z-60"	60,5	1500	39/85

Schema dei fori di installazione 5301/5301Z (unità: mm)

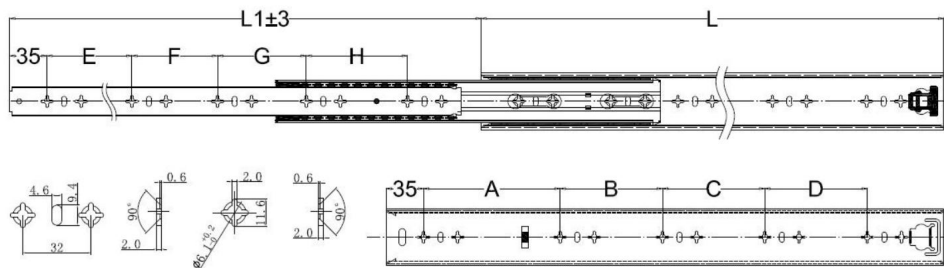

Ltem No	L	L1	A	B	C	D	E	F	G	H
16"	400	405	128	128	/	/	128	128	/	/
18"	450	455	160	160	/	/	128	224	/	/
20"	500	513	128	224	/	/	128	224	/	/
24"	600	612	160	160	160	/	224	256	/	/
30"	750	765	224	224	192	/	224	224	192	/
36"	900	902	256	256	256	/	256	256	256	/
38"	950	957	256	256	288	/	256	288	256	/
60"	1500	1510	352	352	352	320	320	352	352	320

Procedura di installazione (Metodo 1)

1. Prestare attenzione allo spazio di installazione su entrambi i lati. (Unità: mm)

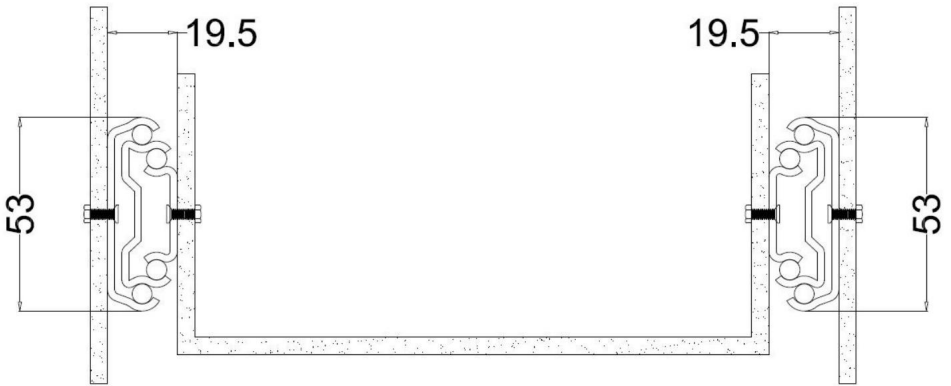

2. Installare la rotaia esterna.

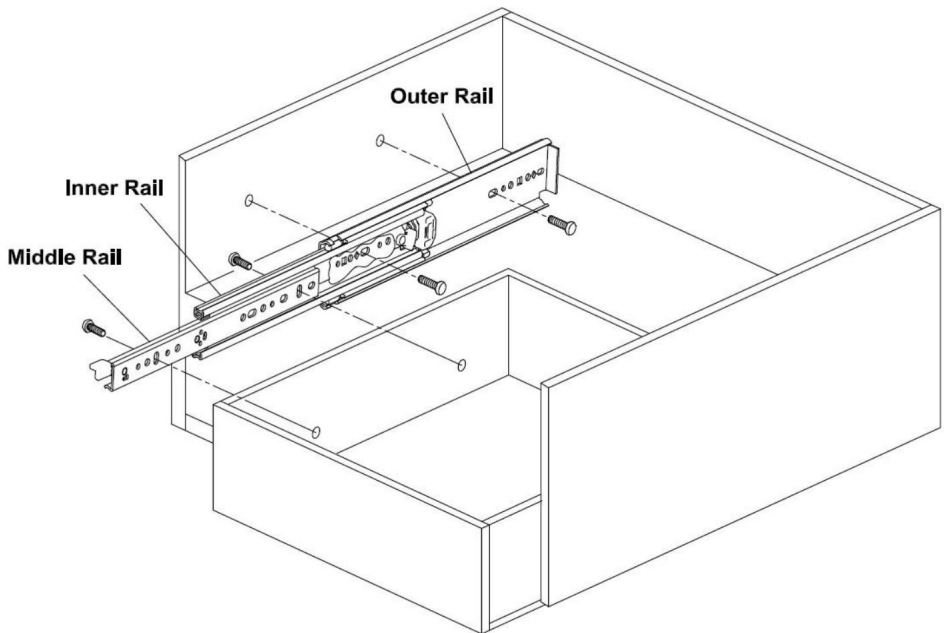

3. Installare il cassetto.

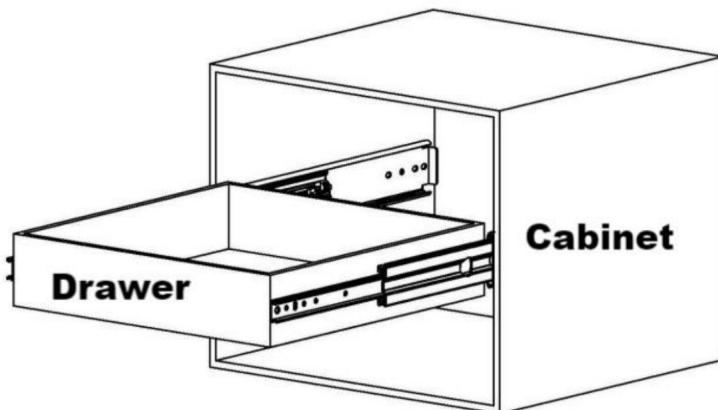

Press To Unlock

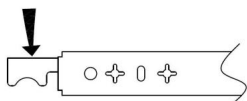

Procedura di installazione (metodo 2)

1. Prestare attenzione allo spazio di installazione su entrambi i lati. (Unità: mm)

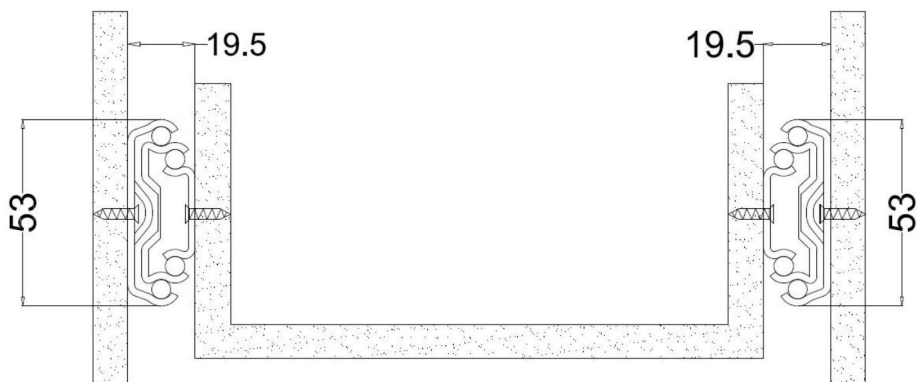

2. Installare la rotaia esterna.

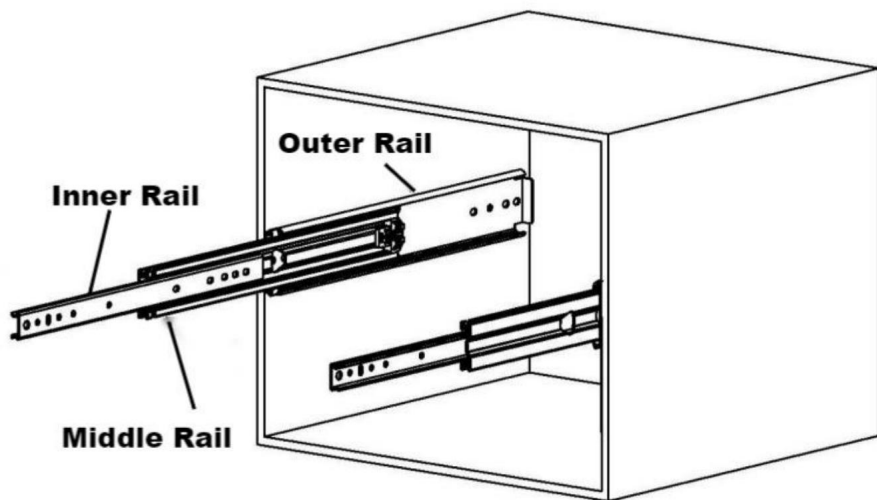

3. Installare il cassetto.

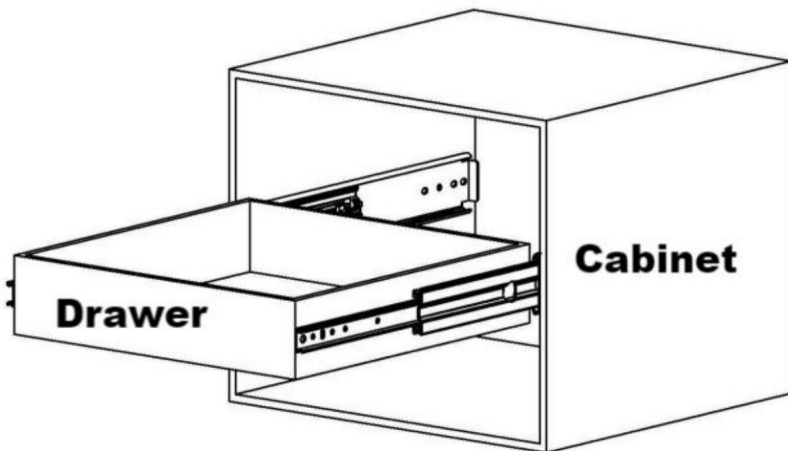

Press To Unlock

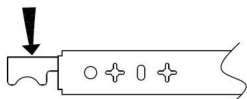

Produttore: Shanghaimuxinmuyeyouxiangongsi

Indirizzo: Shuangchenglu 803nong11hao1602A-1609shi, baoshanqu, shanghai
200000 CN.

Importato in AUS: SIHAO PTY LTD. 1 ROKEVA STREETEASTWOOD

Nuovo Galles del Sud 2122 Australia

Importato negli USA: Sanven Technology Ltd. Suite 250, 9166 Anaheim
Luogo, Rancho Cucamonga, CA 91730



CONSULENZA YH LIMITATA.

C/O YH Consulting Limited Ufficio 147,
Centurion House, London Road,
Staines-upon-Thames, Surrey, TW18 4AX

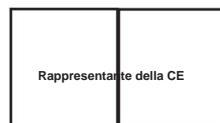

E-CrossStu GmbH

Mainzer Landstr.69,
60329 Francoforte sul Meno.

VEVOR®

TOUGH TOOLS, HALF PRICE

**Supporto tecnico e certificato di garanzia
elettronica www.vevor.com/support**

VEVOR[®]

TOUGH TOOLS, HALF PRICE

Soporte técnico y certificado de garantía electrónica www.vevor.com/support

GUÍAS PARA CAJONES DE ALTA RESISTENCIA

MODELO:5301 / 5301Z

Seguimos comprometidos a brindarle herramientas a precios competitivos.

"Ahorre la mitad", "mitad de precio" o cualquier otra expresión similar que utilicemos solo representa una estimación del ahorro que podría obtener al comprar ciertas herramientas con nosotros en comparación con las principales marcas y no necesariamente significa que cubra todas las categorías de herramientas que ofrecemos. Le recordamos que, al realizar un pedido con nosotros, verifique cuidadosamente si realmente está ahorrando la mitad en comparación con las principales marcas.

VEVOR[®]
TOUGH TOOLS, HALF PRICE

CAJÓN DE ALTA RESISTENCIA

DIPOSITIVAS

MODELO:5301 / 5301Z



¿NECESITA AYUDA? ¡CONTÁCTENOS!

¿Tiene preguntas sobre el producto? ¿Necesita asistencia técnica? No dude en ponerse en contacto con

nosotros: Asistencia técnica y certificado de garantía electrónica

www.vevor.com/support

Estas son las instrucciones originales, lea atentamente todas las instrucciones del manual antes de utilizar el producto. VEVOR se reserva una interpretación clara de nuestro manual de usuario. La apariencia del producto estará sujeta al producto que recibió. Perdónenos por no informarle nuevamente si hay actualizaciones de tecnología o software en nuestro producto.



Advertencia: Para reducir el riesgo de lesiones, el usuario debe leer

Lea atentamente el manual de instrucciones.

ADVERTENCIA:

1. Por favor, monte el producto siguiendo estrictamente las instrucciones.

Un montaje incorrecto podría resultar peligroso.

2. Utilice gafas de seguridad y guantes de trabajo adecuadamente durante el montaje.

3. No intente ensamblar el producto cuando se sienta cansado o bajo la influencia del alcohol. influencia del alcohol, drogas o medicamentos.

4. La capacidad de carga y otros parámetros del producto se aplican a la únicamente producto ensamblado de forma correcta y completa.

5. Separe y cuente todas las piezas y el hardware.

6. Prepare la siguiente herramienta: Destornillador de cabeza Philips.

7. Si utiliza herramientas eléctricas, tenga cuidado de reducir la velocidad y detenerse cuando necesario.

8. Se necesitan dos personas para el montaje.

9. Siga únicamente los usos previstos.

Guarde las instrucciones.

Atención:





1. Preste atención a la impermeabilidad y a la humedad, no debe colocarse en el aire libre, ambiente húmedo o químico.

2. Preste atención a los productos químicos fuertes, no utilice productos químicos fuertes, limpieza agentes o detergentes fuertes para limpiar productos. Limpiar la apariencia de Las manchas del producto se pueden limpiar con un paño limpio.





3. Preste atención a las altas temperaturas, no coloque el producto en un lugar ambiente donde la temperatura es demasiado alta (producto recomendado)

Requisitos ambientales: temperatura de trabajo: -10 -50).

Lista de piezas 5301/5301Z-16"~5301/5301Z-30"

Código	Imagen	Código	de cant.	Imagen	Cantidad.
1		1	2		1
3		16	4		16

Lista de piezas 5301/5301Z-32"~5301/5301Z-60"

Código	Imagen	Código	de cant.	Imagen	Cantidad.
1		1	2		1
3		24	4		24

Introducción del producto

Modelo	Cajón aplicable Longitud (pulgadas)	Longitud deslizante (mm)	Carga máx. (kg/libras)
5301/5301Z-16"	16.5	400	106/234
5301/5301Z-18"	18.5	450	113/250
5301/5301Z-20"	20.5	500	105/233
5301/5301Z-24"	24.5	600	98/216
5301/5301Z-30"	30.5	750	80/176,5
5301/5301Z-36"	36.5	900	61/134,6
5301/5301Z-38"	38.5	950	54/119
5301/5301Z-60"	60,5	1500	39/85

Patrón de orificios de instalación 5301/5301Z (Unidades: mm)

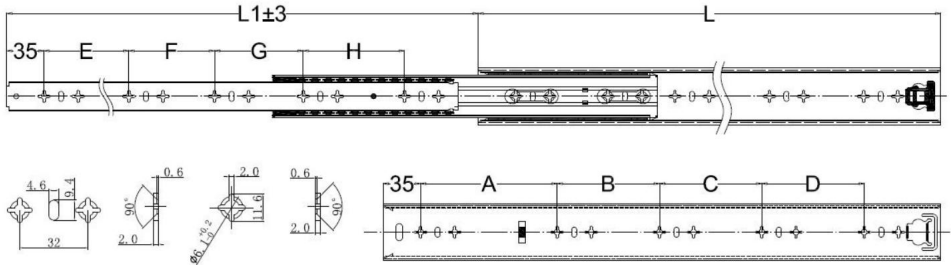

Ltem No	L	L1	A	B	C	D	E	F	G	H
16"	400	405	128	128	/	/	128	128	/	/
18"	450	455	160	160	/	/	128	224	/	/
20"	500	513	128	224	/	/	128	224	/	/
24"	600	612	160	160	160	/	224	256	/	/
30"	750	765	224	224	192	/	224	224	192	/
36"	900	902	256	256	256	/	256	256	256	/
38"	950	957	256	256	288	/	256	288	256	/
60"	1500	1510	352	352	352	320	320	352	352	320

Procedimiento de instalación (Método 1)

1. Preste atención al espacio de instalación en ambos lados. (Unidades: mm)

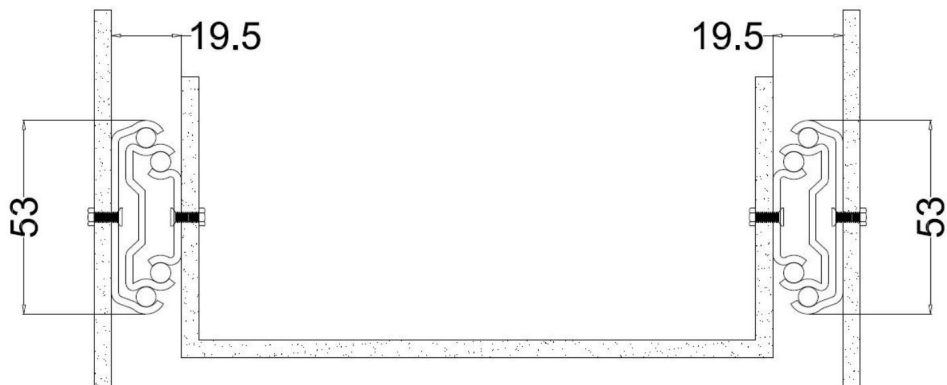

2. Instale el riel exterior.

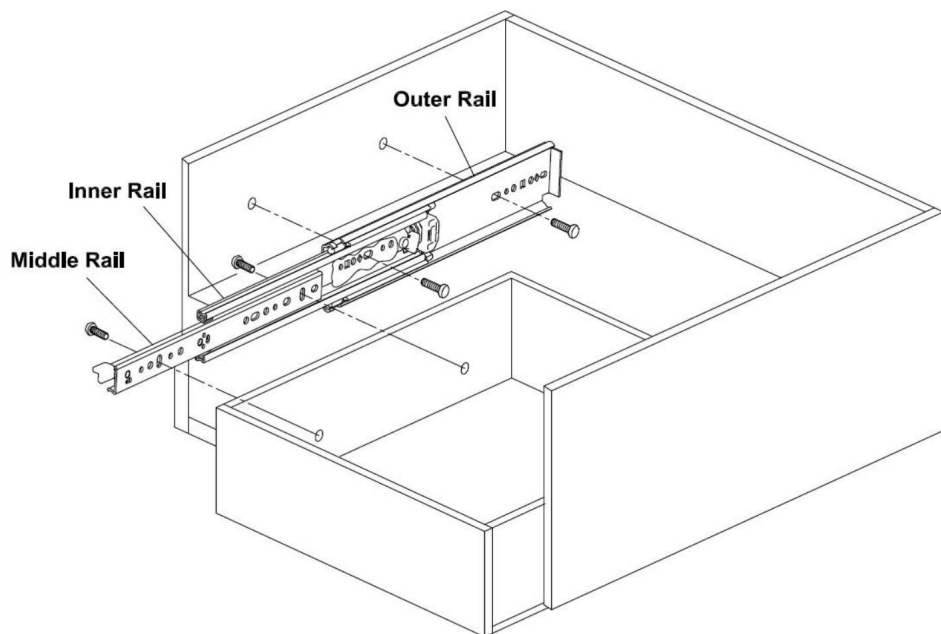

3. Instale el cajón.

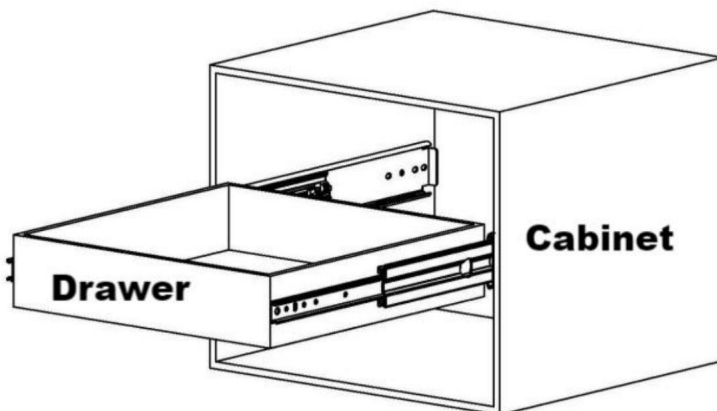

Press To Unlock

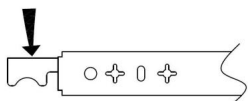

Procedimiento de instalación (método 2)

1. Preste atención al espacio de instalación en ambos lados. (Unidades: mm)

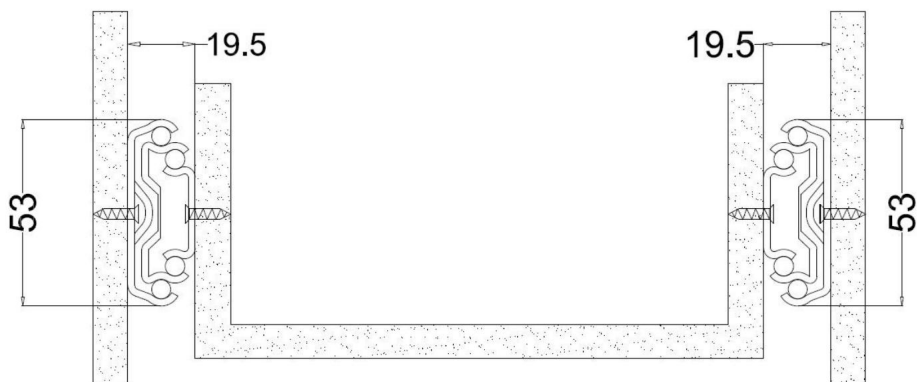

2. Instale el riel exterior.

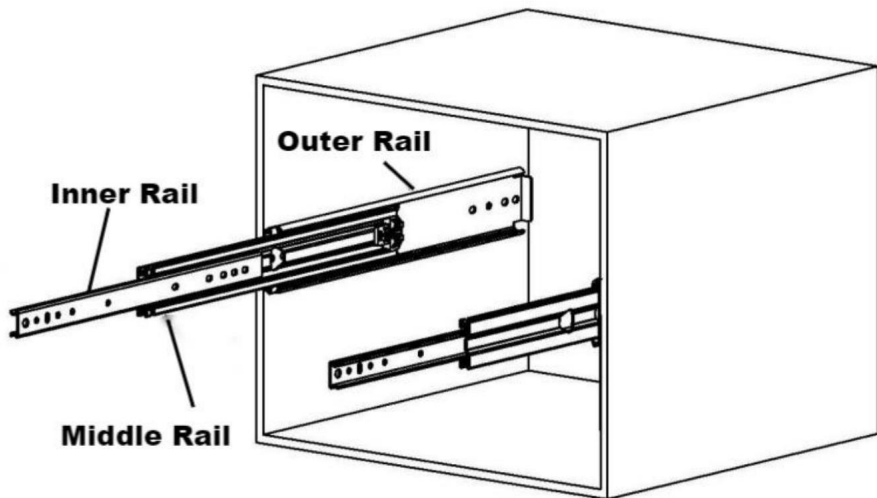

3. Instale el cajón.

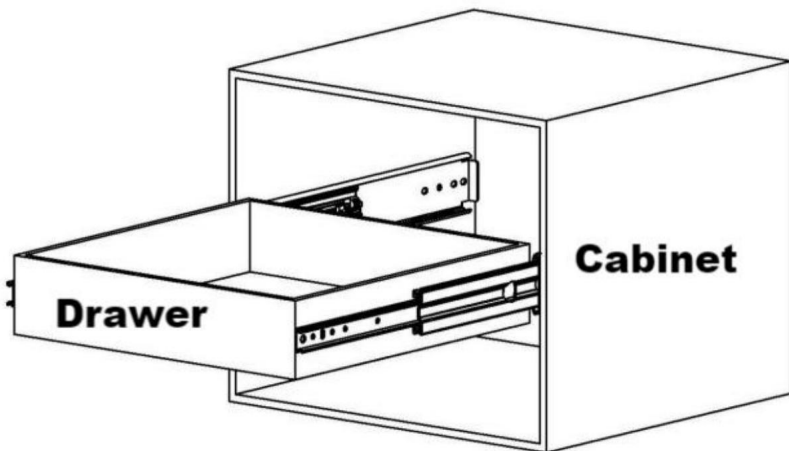

Press To Unlock

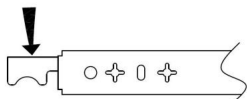

Fabricante: Shanghaimuxinmuyeyouxiangongsi

Dirección: Shuangchenglu 803nong11hao1602A-1609shi, baoshanqu, shanghai
200000 CN.

Importado a Australia: SIHAO PTY LTD. 1 ROKEVA STRETEASTWOOD

Nueva Gales del Sur 2122 Australia

Importado a EE. UU.: Sanven Technology Ltd. Suite 250, 9166 Anaheim

Lugar, Rancho Cucamonga, CA 91730

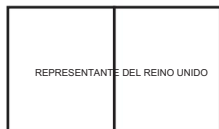

YH CONSULTING LIMITADA.

C/O YH Consulting Limited Oficina 147,
Centurion House, London Road,
Staines-upon-Thames, Surrey, TW18 4AX

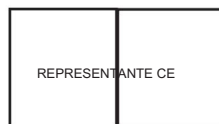

E-CrossStu GmbH

Mainzer Landstr.69,
60329 Fráncfort del Meno.

VEVOR®

TOUGH TOOLS, HALF PRICE

Soporte técnico y certificado de garantía
electrónica www.vevor.com/support

VEVOR[®]

TOUGH TOOLS, HALF PRICE

Wsparcie techniczne i certyfikat gwarancji elektronicznej www.vevor.com/support

WYTRZYMAŁE PROWADNICE SZUFLAD

MODEL:5301 / 5301Z

Nadal staramy się oferować Państwu narzędzia w konkurencyjnych cenach. „Oszczędzaj połowę”, „Połowa ceny” lub inne podobne wyrażenia używane przez nas stanowią jedynie szacunkowe oszczędności, jakie możesz uzyskać, kupując u nas określone narzędzia w porównaniu z głównymi markami i niekoniecznie oznaczają one objęcie wszystkich kategorii oferowanych przez nas narzędzi. Uprzejmie przypominamy, aby przy składaniu zamówienia dokładnie sprawdzić, czy faktycznie oszczędzasz połowę w porównaniu z głównymi markami.

VEVOR[®]
TOUGH TOOLS, HALF PRICE

SZUFLADA O WYSOKIEJ WYTRZYMAŁOŚCI

SLAJDY

MODEL:5301 / 5301Z



POTRZEBUJESZ POMOCY? SKONTAKTUJ SIĘ Z NAMI!

Masz pytania dotyczące produktu? Potrzebujesz wsparcia technicznego? Skontaktuj się z nami:
Wsparcie

techniczne i certyfikat E-Gwarancji www.vevor.com/support

To jest oryginalna instrukcja, przed użyciem należy uważnie przeczytać wszystkie instrukcje. VEVOR zastrzega sobie jasną interpretację naszej instrukcji obsługi. Wygląd produktu będzie zależał od produktu, który otrzymałeś. Prosimy o wybaczenie, że nie poinformujemy Cię ponownie, jeśli w naszym produkcie pojawią się jakiegokolwiek aktualizacje technologiczne lub oprogramowania.



Ostrzeżenie – aby zmniejszyć ryzyko obrażeń, użytkownik musi przeczytać
Przeczytaj uważnie instrukcję obsługi.

OSTRZEŻENIE:

1. Produkt należy złożyć ściśle według instrukcji.
Nieprawidłowy montaż może być niebezpieczny.
2. Podczas montażu należy prawidłowo nosić okulary ochronne i rękawice robocze.
3. Nie próbuj składać produktu, gdy jesteś zmęczony lub osłabiony.
pod wpływem alkoholu, narkotyków lub leków.
4. Nośność i inne parametry produktu są stosowane do
wyłącznie produkt prawidłowo i kompletnie zmontowany.
5. Oddziel i policz wszystkie części i elementy montażowe.
6. Przygotuj następujące narzędzie: śrubokręt krzyżakowy.
7. Używając elektronarzędzi, pamiętaj o zwolnieniu i zatrzymaniu się.
wymagany.
8. Do montażu potrzebne są dwie osoby.
9. Stosuj wyłącznie produkty zgodne z przeznaczeniem.
Zapisz instrukcję.

Uwaga:

1. Należy zwrócić uwagę na wodoodporność i odporność na wilgoć, nie należy umieszczać w
otwarte powietrze, środowisko wilgotne lub chemiczne.
2. Zwróć uwagę na silne środki chemiczne, nie używaj silnych środków chemicznych do czyszczenia
środki czyszczące lub silne detergenty do czyszczenia produktów. Wyczyść wygląd
Plamy powstałe na skutek działania produktu można zetrzeć czystą szmatką.
3. Należy zwrócić uwagę na wysoką temperaturę, nie umieszczać produktu w
środowisko, w którym temperatura jest zbyt wysoka (zalecany produkt)
Wymagania środowiskowe: temperatura pracy: -10°C-50°C).

Lista części 5301/5301Z-16"~5301/5301Z-30"					
Kod	Zdjęcie	Ilość	Kod	Zdjęcie	Ilość.
1		1	2		1
3		16	4		16

Lista części 5301/5301Z-32"~5301/5301Z-60"					
Kod	Zdjęcie	Ilość	Kod	Zdjęcie	Ilość.
1		1	2		1
3		24	4		24

Wprowadzenie do produktu

Model	Odpowiednia szuflada Długość (cale)	Długość przesuwania (mm)	Maksymalne obciążenie (kg / funty)
5301/5301Z-16"	16,5	400	106/ 234
5301/5301Z-18"	18,5	450	113/ 250
5301/5301Z-20"	20,5	500	105/ 233
5301/5301Z-24"	24,5	600	98/ 216
5301/5301Z-30"	30,5	750	80/176,5
5301/5301Z-36"	36,5	900	61/134.6
5301/5301Z-38"	38,5	950	54/119
5301/5301Z-60"	60,5	1500	39/85

5301/5301Z Wzór otworów montażowych (jednostki: mm)

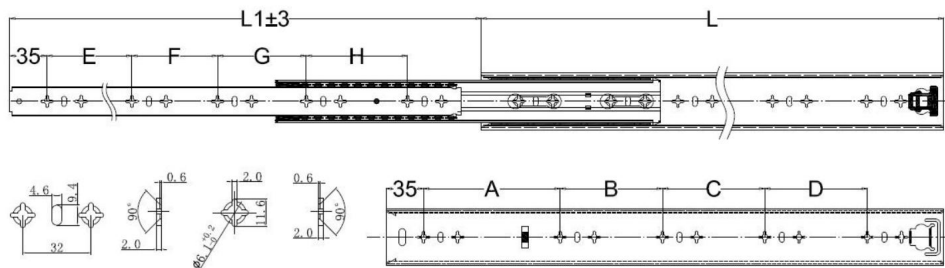

Ltem No	L	L1	A	B	C	D	E	F	G	H
16"	400	405	128	128	/	/	128	128	/	/
18"	450	455	160	160	/	/	128	224	/	/
20"	500	513	128	224	/	/	128	224	/	/
24"	600	612	160	160	160	/	224	256	/	/
30"	750	765	224	224	192	/	224	224	192	/
36"	900	902	256	256	256	/	256	256	256	/
38"	950	957	256	256	288	/	256	288	256	/
60"	1500	1510	352	352	352	320	320	352	352	320

Procedura instalacji (Metoda 1)

1. Należy zwrócić uwagę na przestrzeń montażową po obu stronach. (Jednostki: mm)

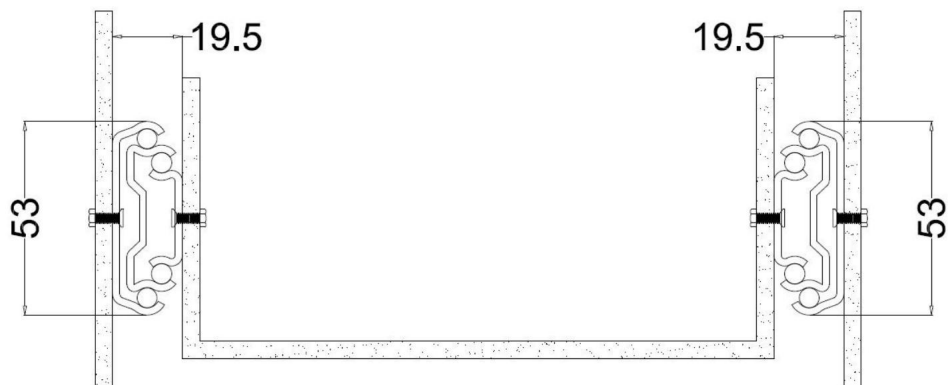

2. Zamontuj zewnętrzną szynę.

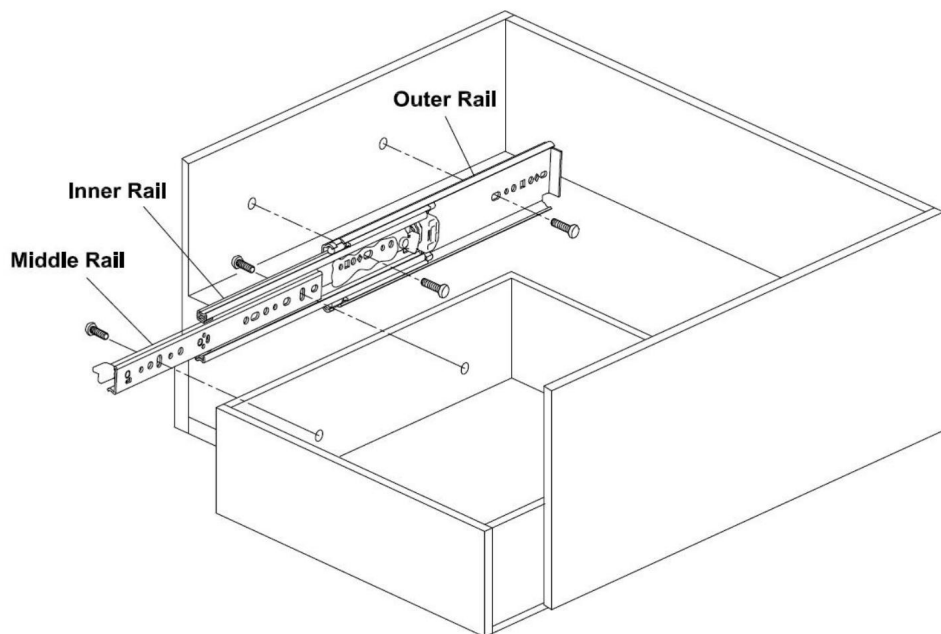

3. Zainstaluj szufladę.

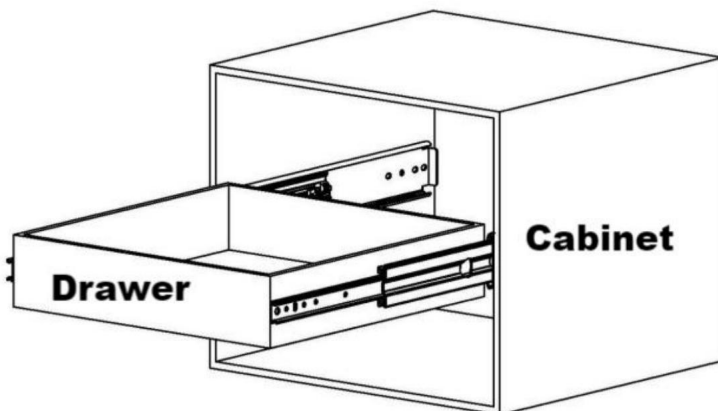

Press To Unlock

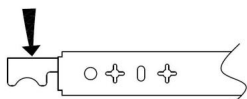

Procedura instalacji (metoda 2)

1. Należy zwrócić uwagę na przestrzeń montażową po obu stronach. (Jednostki: mm)

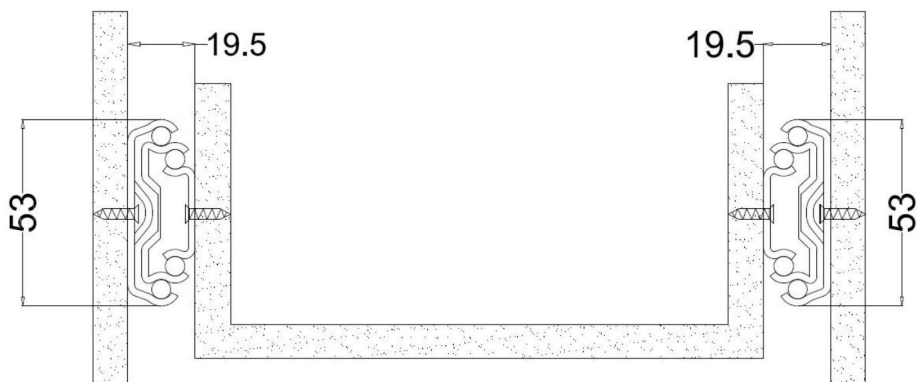

2. Zamontuj zewnętrzną szynę.

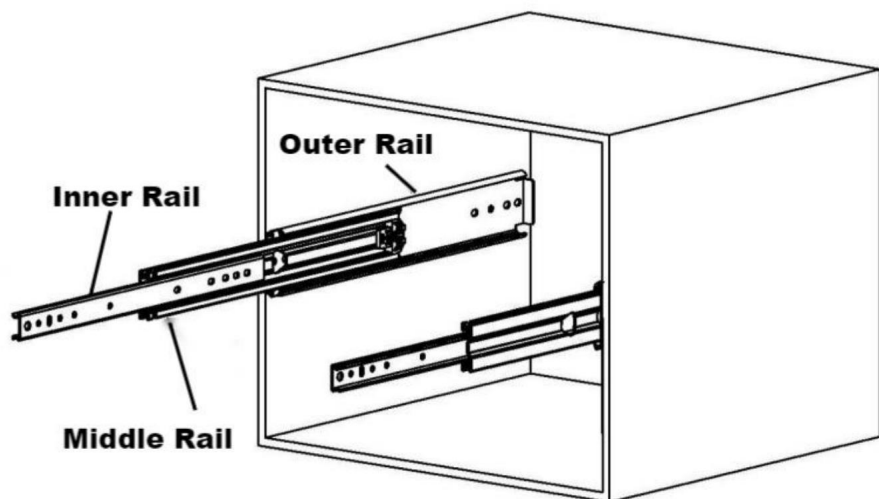

3. Zainstaluj szufladę.

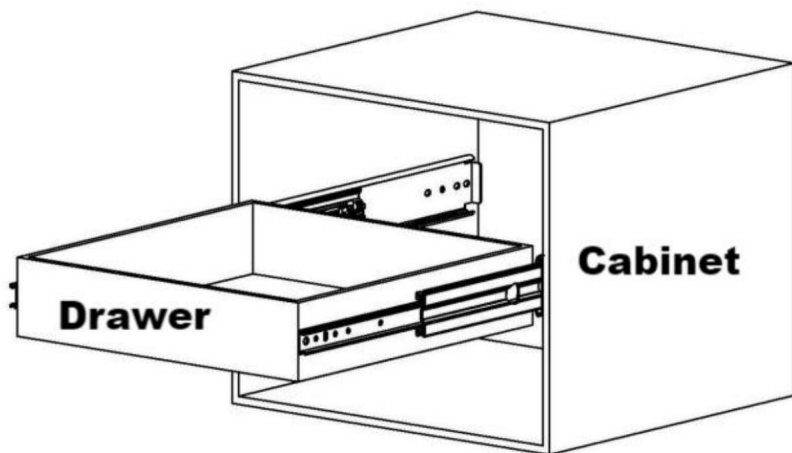

Press To Unlock

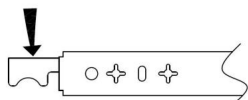

Producent: Shanghaimuxinmuyeyouxiangongsi

Adres: Shuangchenglu 803nong11hao1602A-1609shi, baoshanqu, szanghaj
200000 CN.

Importowane do AUS: SIHAO PTY LTD. 1 ROKEVA STREETEASTWOOD
NSW 2122 Australia

Importowane do USA: Sanven Technology Ltd. Suite 250, 9166 Anaheim
Miejsce, Rancho Cucamonga, CA 91730



YH CONSULTING LIMITED.

C/O YH Consulting Limited Biuro 147,
Centurion House, London Road,
Staines-upon-Thames, Surrey, TW18 4AX



E-CrossStu GmbH

Mainzer Landstr.69,
60329 Frankfurt nad Menem.

VEVOR®

TOUGH TOOLS, HALF PRICE

Wsparcie techniczne i certyfikat gwarancji
elektronicznej www.vevor.com/support

VEVOR[®]

TOUGH TOOLS, HALF PRICE

Technische ondersteuning en e-garantiecertificaat www.vevor.com/support

ZWARE LADESCHUIF

MODEL:5301 / 5301Z

Wij streven er voortdurend naar om u gereedschappen tegen concurrerende prijzen te leveren. "Save Half", "Half Price" of andere soortgelijke uitdrukkingen die wij gebruiken, geven alleen een schatting weer van de besparingen die u kunt behalen door bepaalde gereedschappen bij ons te kopen in vergelijking met de grote topmerken en betekent niet noodzakelijkerwijs dat alle categorieën gereedschappen die wij aanbieden, worden gedekt. Wij herinneren u eraan om zorgvuldig te controleren of u daadwerkelijk de helft bespaart in vergelijking met de grote topmerken wanneer u een bestelling bij ons plaatst.

VEVOR[®]
TOUGH TOOLS, HALF PRICE

ZWARE LADE

DIAS

MODEL:5301 / 5301Z



HULP NODIG? NEEM CONTACT MET ONS OP!

Heeft u vragen over het product? Heeft u technische ondersteuning nodig? Neem dan gerust contact met

ons op: **Technische ondersteuning en E-garantiecertificaat**
www.vevor.com/support

Dit is de originele instructie, lees alle handleidingen zorgvuldig door voordat u het product gebruikt. VEVOR behoudt zich een duidelijke interpretatie van onze gebruikershandleiding voor. Het uiterlijk van het product is afhankelijk van het product dat u hebt ontvangen. Vergeef ons dat we u niet opnieuw zullen informeren als er technologie- of software-updates voor ons product



Waarschuwing - Om het risico op letsel te verminderen, moet de gebruiker de gebruiksaanwijzing lezen

Lees de gebruiksaanwijzing zorgvuldig door.

WAARSCHUWING:

1. Monteer het product strikt volgens de instructies.

Een verkeerde montage kan gevaarlijk zijn.

2. Draag tijdens de montage een veiligheidsbril en werkhandschoenen.

3. Probeer het product niet te monteren als u zich moe voelt of onder invloed bent.
invloed van alcohol, drugs of medicijnen.

4. Draagvermogen en andere productparameters worden toegepast op de
Alleen een product dat correct en volledig is gemonteerd.

5. Scheid alle onderdelen en hardware en tel ze.

6. Bereid het volgende gereedschap voor: kruiskopschroevendraaier.

7. Als u elektrisch gereedschap gebruikt, wees dan voorzichtig en vertraag en stop wanneer u
nodig.

8. Voor de montage zijn twee personen nodig.

9. Gebruik het product uitsluitend voor het beoogde gebruik.

Bewaar de instructies.

Aandacht:

1. Let op water- en vochtbestendig, mag niet in
de openlucht, vochtige of chemische omgeving.

2. Let op sterke chemicaliën, gebruik geen sterke chemicaliën, schoonmaak
middelen of sterke reinigingsmiddelen om producten schoon te maken. Reinig het uiterlijk van
Vlekken van het product kunnen met een schone doek worden weggeveegd.

3. Let op de anti-hoge temperatuur, plaats het product niet in een
omgeving waar de temperatuur te hoog is (aanbevolen product
Omgevingseisen: werktemperatuur: -10ÿ-50ÿ).

5301/5301Z-16" ~5301/5301Z-30"Onderdelenlijst					
Code	Afbeelding	Hoeveelheid Code		Afbeelding	Aantal
1		1	2		1
3		16	4		16

5301/5301Z-32" ~5301/5301Z-60"Onderdelenlijst					
Code	Afbeelding	Hoeveelheid Code		Afbeelding	Aantal
1		1	2		1
3		24	4		24

Productintroductie

Model	Toepasselijke lade Lengte (inch)	Schuiflengte (mm)	Maximale belasting (kg/lbs)
5301/5301Z-16"	16.5	400	106/ 234
5301/5301Z-18"	18.5	450	113/ 250
5301/5301Z-20"	20.5	500	105/ 233
5301/5301Z-24"	24.5	600	98/ 216
5301/5301Z-30"	30.5	750	80/176.5
5301/5301Z-36"	36.5	900	61/134.6
5301/5301Z-38"	38.5	950	54/119
5301/5301Z-60"	60.5	1500	39/85

5301/5301Z installatiegatpatroon (eenheden: mm)

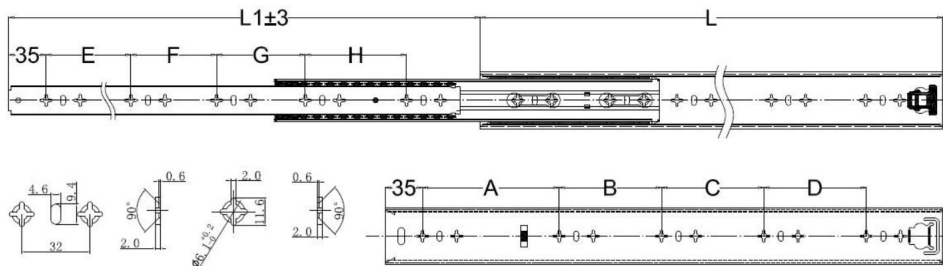

Ltem No	L	L1	A	B	C	D	E	F	G	H
16"	400	405	128	128	/	/	128	128	/	/
18"	450	455	160	160	/	/	128	224	/	/
20"	500	513	128	224	/	/	128	224	/	/
24"	600	612	160	160	160	/	224	256	/	/
30"	750	765	224	224	192	/	224	224	192	/
36"	900	902	256	256	256	/	256	256	256	/
38"	950	957	256	256	288	/	256	288	256	/
60"	1500	1510	352	352	352	320	320	352	352	320

Installatieprocedure (Methode 1)

1. Let op de installatieruimte aan beide zijden. (Eenheid: mm)

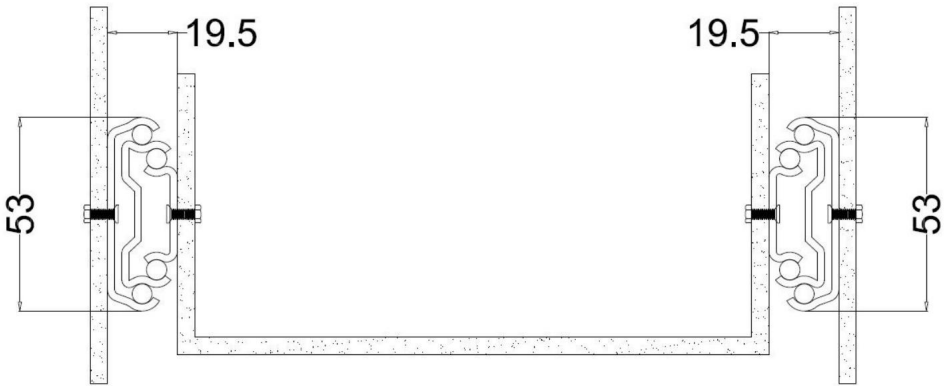

2. Plaats de buitenrail.

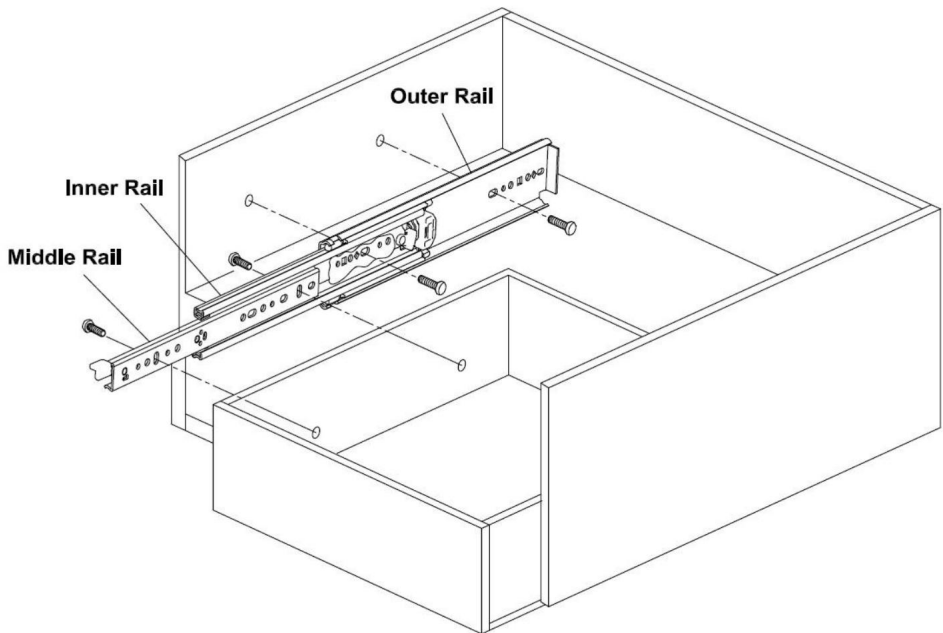

3. Plaats de lade.

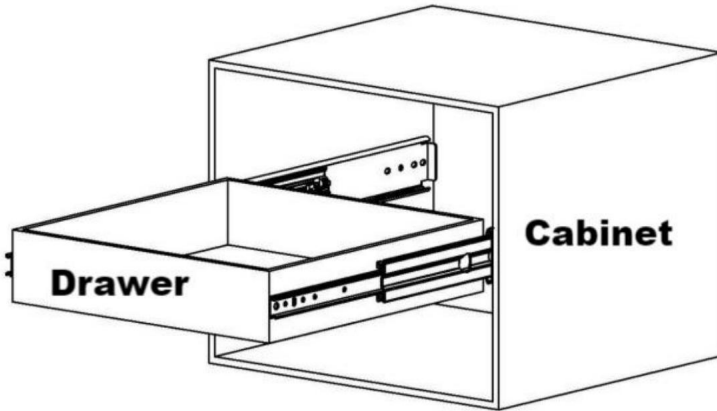

Press To Unlock

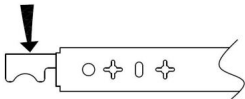

Installatieprocedure (Methode 2)

1. Let op de installatieruimte aan beide zijden. (Eenheid: mm)

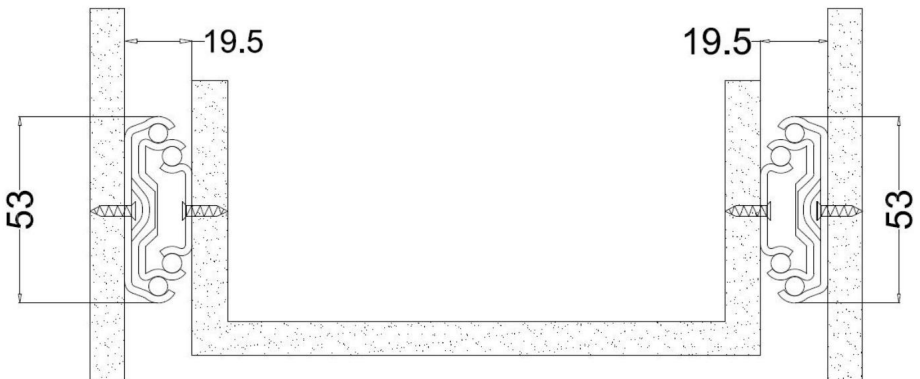

2. Plaats de buitenrail.

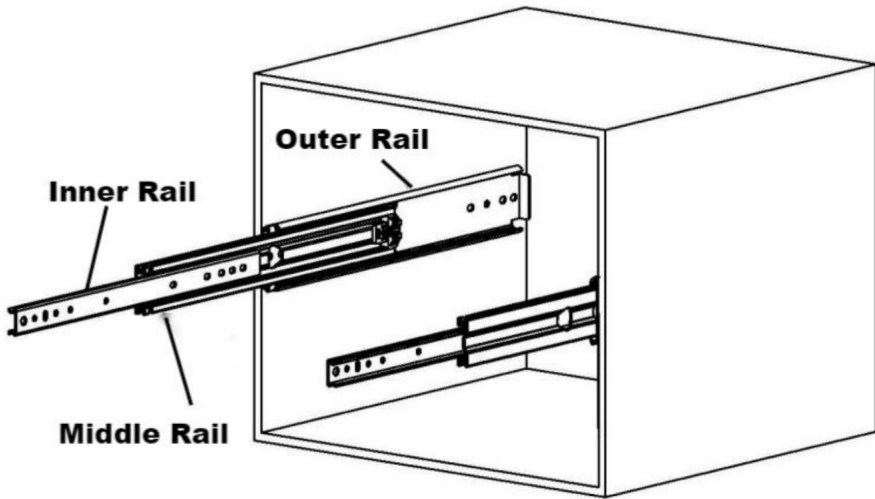

3. Plaats de lade.

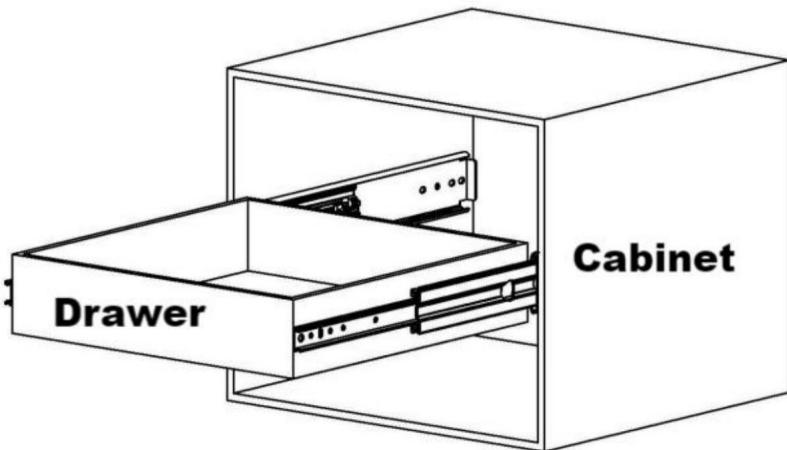

Press To Unlock

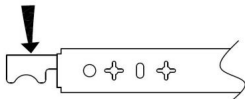

Fabrikant: Shanghaimuxinmuyeyouxiangongsi

Adres: Shuangchenglu 803nong11hao1602A-1609shi, baoshanqu, shanghai
200000 CN.

Geïmporteerd naar AUS: SIHAO PTY LTD. 1 ROKEVA STREETEASTWOOD
NSW 2122 Australië

Geïmporteerd naar de VS: Sanven Technology Ltd. Suite 250, 9166 Anaheim
Plaats, Rancho Cucamonga, CA 91730



YH CONSULTING LIMITED.

C/O YH Consulting Limited Kantoor 147,
Centurion House, London Road,
Staines-upon-Thames, Surrey, TW18 4AX



E-CrossStu GmbH
Mainzer Landstr.69,
60329 Frankfurt am Main.

VEVOR®

TOUGH TOOLS, HALF PRICE

Technische ondersteuning en e-
garantiecertificaat www.vevor.com/support

VEVOR[®]

TOUGH TOOLS, HALF PRICE

Teknisk support och e-garanticertifikat www.vevor.com/support

HEAVY DUTY LÅDASLIDER

MODELL: 5301 / 5301Z

Vi fortsätter att vara engagerade i att ge dig verktyg till konkurrenskraftiga priser. "Spara hälften", "halva priset" eller andra liknande uttryck som används av oss representerar bara en uppskattning av besparingar du kan dra nytta av att köpa vissa verktyg hos oss jämfört med de stora toppmärkena och betyder inte nödvändigtvis att täcka alla kategorier av verktyg som erbjuds av oss. Du påminns om att noggrant kontrollera när du gör en beställning hos oss om du verkligen sparar hälften i jämförelse med de främsta varumärkena.

VEVOR[®]
TOUGH TOOLS, HALF PRICE

HEAVY DUTY LÅDA

GLÄDJOR

MODELL: 5301 / 5301Z



BEHÖVER HJÄLP? KONTAKTA OSS!

Har du produktfrågor? Behöver du teknisk support? Kontakta oss gärna: **Teknisk support och e-**

garanticertifikat www.vevor.com/support

Detta är den ursprungliga instruktionen, läs alla instruktioner noggrant innan du använder den. VEVOR reserverar sig för en tydlig tolkning av vår användarmanual. Utseendet på produkten är beroende av den produkt du fått. Ursäkta oss att vi inte kommer att informera dig igen om det finns någon teknik eller mjukvaruuppdateringar på vår produkt.



Varning - För att minska risken för skada måste användaren läsa bruksanvisningen noggrant.

VARNING:

1. Vänligen montera produkten i strikt enlighet med instruktionerna.
Felaktig montering kan vara farligt.
2. Använd skyddsglasögon och arbetshandskar ordentligt under monteringen.
3. Försök inte att montera produkten när du känner dig trött eller när du är under påverkan av alkohol, droger eller mediciner.
4. Bärförmåga och andra produktparametrar tillämpas på endast korrekt och färdigmonterad produkt.
5. Separera och räkna alla delar och hårdvara.
6. Förbered följande verktyg: Philips huvudskruvmejsel.
7. Om du använder elverktyg, var noga med att sakta ner och stoppa när behövs.
8. Två personer krävs för montering.
9. Följ endast avsedd användning.
Spara instruktionerna.

Uppmärksamhet:

1. Var uppmärksam på vattentät och fuktsäker, ska inte placeras i den fria, våta eller kemiska miljön.
2. Var uppmärksam på starka kemikalier, använd inte starka kemikalier, rengöring medel eller starka rengöringsmedel för att rengöra produkter. Rengör utseendet på produktfläckarna kan torkas av med en ren trasa.
3. Var uppmärksam på anti-hög temperatur, lägg inte produkten i en miljö där temperaturen är för hög (rekommenderad produkt miljökrav: arbetstemperatur:-10ÿ-50ÿ).

5301/5301Z-16"~5301/5301Z-30" Part List

Koda	Bild	Antal.	Koda	Bild	Antal.
1		1	2		1
3		16	4		16

5301/5301Z-32"~5301/5301Z-60" Part List

Koda	Bild	Antal.	Koda	Bild	Antal.
1		1	2		1
3		24	4		24

Produktintroduktion

Modell	Tillämplig låda Längd (tum)	Glidlängd (mm)	Max. Ladda (kg / lbs)
5301/5301Z-16"	16.5	400	106/234
5301/5301Z-18"	18.5	450	113/250
5301/5301Z-20"	20.5	500	105/233
5301/5301Z-24"	24.5	600	98/216
5301/5301Z-30"	30,5	750	80/176,5
5301/5301Z-36"	36,5	900	61/134,6
5301/5301Z-38"	38,5	950	54/119
5301/5301Z-60"	60,5	1500	39/85

5301/5301Z Installationshålmönster (Enheter:mm)

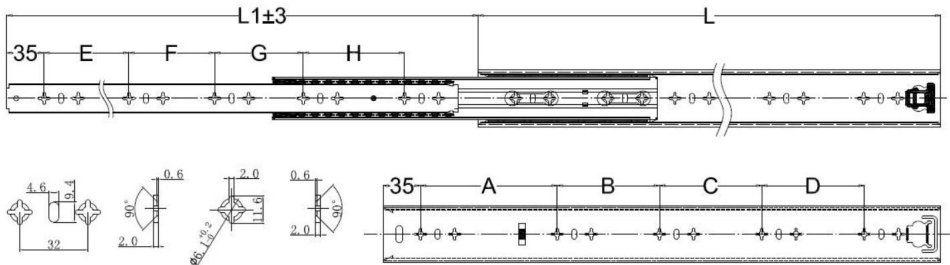

Ltem No	L	L1	A	B	C	D	E	F	G	H
16"	400	405	128	128	/	/	128	128	/	/
18"	450	455	160	160	/	/	128	224	/	/
20"	500	513	128	224	/	/	128	224	/	/
24"	600	612	160	160	160	/	224	256	/	/
30"	750	765	224	224	192	/	224	224	192	/
36"	900	902	256	256	256	/	256	256	256	/
38"	950	957	256	256	288	/	256	288	256	/
60"	1500	1510	352	352	352	320	320	352	352	320

Installationsprocedur (metod 1)

1. Var uppmärksam på installationsutrymmet på båda sidor.(Enheter:mm)

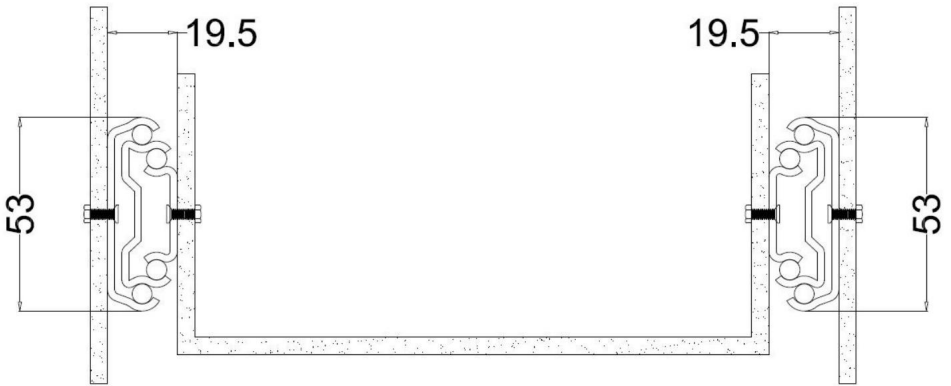

2. Montera den yttre skenan.

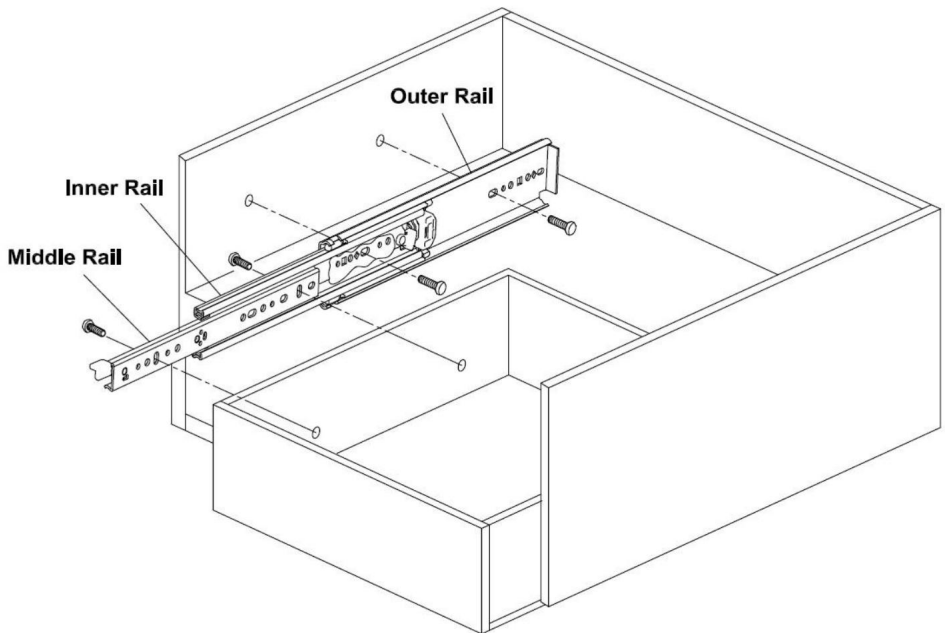

3. Installera lådan.

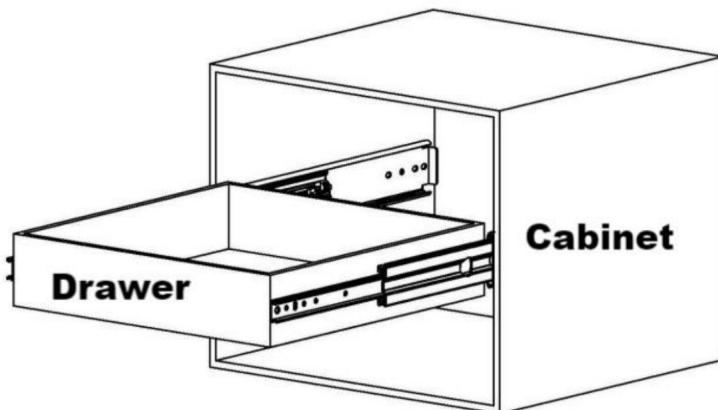

Press To Unlock

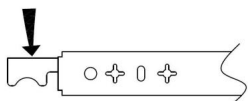

Installationsprocedur (metod 2)

1. Var uppmärksam på installationsutrymmet på båda sidor. Enheterömm

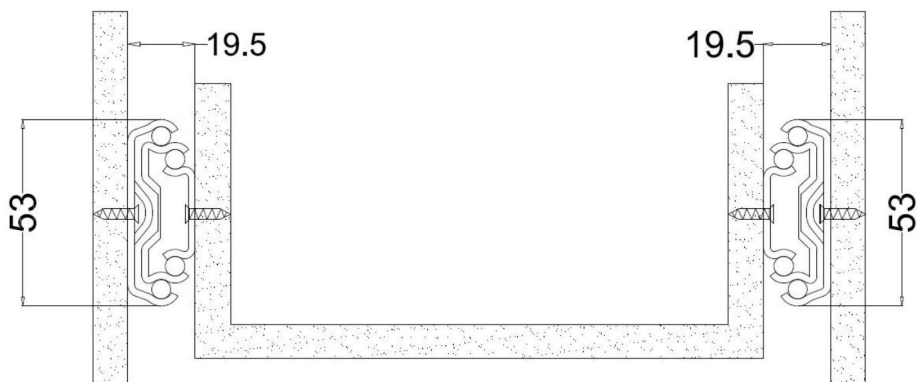

2. Montera den yttre skenan.

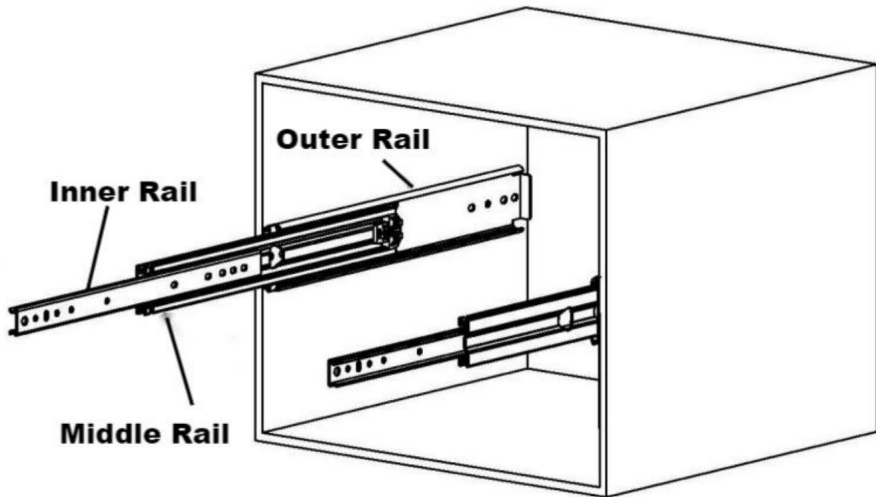

3. Installera lådan.

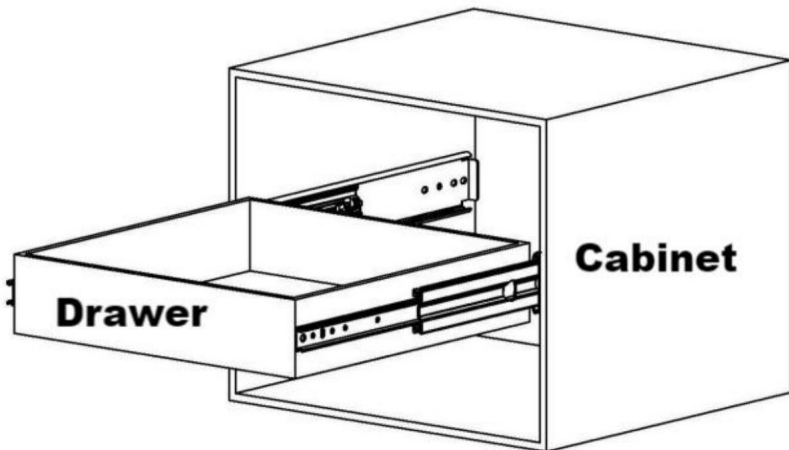

Press To Unlock

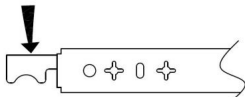

Tillverkare: Shanghaimuxinmuyeyouxiangongsi

Adress: Shuangchenglu 803nong11hao1602A-1609shi, baoshanqu, shanghai
200000 CN.

Importerad till AUS: SIHAO PTY LTD. 1 ROKEVA STREETEASTWOOD
NSW 2122 Australien

Importerad till USA: Sanven Technology Ltd. Suite 250, 9166 Anaheim
Place, Rancho Cucamonga, CA 91730



YH CONSULTING LIMITED.

C/O YH Consulting Limited Office 147,
Centurion House, London Road,
Staines-upon-Thames, Surrey, TW18 4AX



E-CrossStu GmbH

Mainzer Landstr.69,
60329 Frankfurt am Main.

VEVOR®

TOUGH TOOLS, HALF PRICE

Teknisk support och e-garanticertifikat

www.vevor.com/support