

VEVOR[®]

TOUGH TOOLS, HALF PRICE

Technical Support and E-Warranty Certificate

www.vevor.com/support

GARAGE WALL CABINET

USER MANUAL

We continue to be committed to provide you tools with competitive price.

"Save Half", "Half Price" or any other similar expressions used by us only represents an estimate of savings you might benefit from buying certain tools with us compared to the major top brands and does not necessarily mean to cover all categories of tools offered by us. You are kindly reminded to verify carefully when you are placing an order with us if you are actually saving half in comparison with the top major brands.

VEVOR[®]

TOUGH TOOLS, HALF PRICE

GARAGE WALL CABINET

FWC26

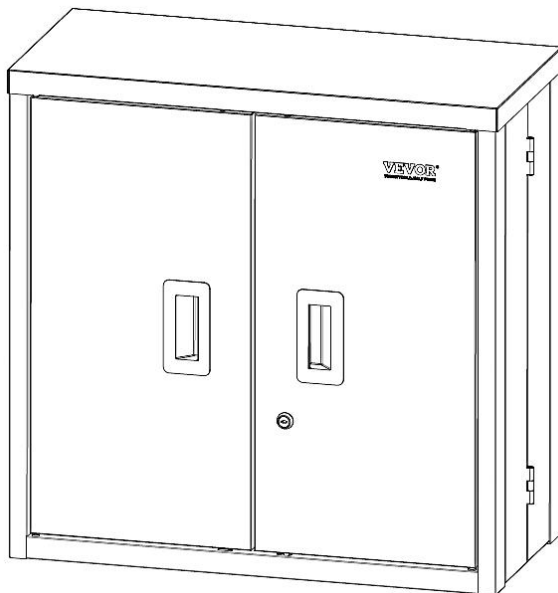

NEED HELP? CONTACT US!

Have product questions? Need technical support? Please feel free to contact us:

Technical Support and E-Warranty Certificate

www.vevor.com/support

This is the original instruction, please read all manual instructions carefully before operating. VEVOR reserves a clear interpretation of our user manual. The appearance of the product shall be subject to the product you received. Please forgive us that we won't inform you again if there are any technology or software updates on our product.

IMPORTANT SAFETY INSTRUCTIONS



Warning - To reduce the risk of injury, user must read instructions manual carefully.

⚠ WARNING!

1. Do not allow children to climb on the unit. -Serious or fatal crushing injuries can occur from furniture tip-over. To prevent this, furniture must be permanently fixed to the wall.
2. Keep children and pets away during assembly.
3. To avoid the danger of suffocation, always keep plastic bags away from children and pets.



ASSEMBLY PRECAUTIONS

1. Please assemble the product in strict accordance with the instructions. Incorrect assembly could be hazardous.
2. Please wear safety goggles and work gloves properly during assembly.
3. Do not try to assemble the product when feeling tired or when under the influence of alcohol, drugs or medication.
4. Load bearing capacity and other product parameters are applied to the properly and completely assembled product only.
5. Separate and count all parts and hardware.
6. Prepare the following tool: Philips Head Screwdriver.
7. If using power tools, please be careful to slow down and stop when needed.
8. Two people are required for assembly.
9. Follow the intended uses only. Do not sit or stand on the above.

PRODUCT PARAMETERS

- 1) Name: Garage wall cabinet
- 2) Model: FWC26
- 3) G.W.: 15.5kg
- 4) Package Size: 740x730x120mm
- 5) Product Size: 26x12x26inch / 660x305x660mm
- 6) Total Load Limit: 240lbs
- 7) Load Limit for Each Shelf:120lbs

PART LIST

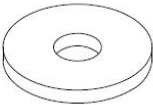
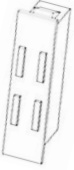
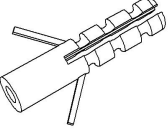
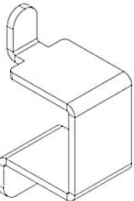
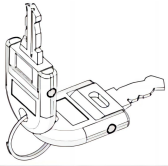
NO.	Name	Parts	Qty	NO.	Name	Parts	Qty
A	Garage wall cabinet		1	F	Screw st6.3*35		4
B	Top shelf		1	G	Washer		4
C	Magnet		4	H	Rubber plug		4
D	Shelf support		2	I	Key		2

E	Overcoil		1	J	EVA		4
---	----------	---	---	---	-----	---	---

Attention:

For additional information regarding the parts listed above, please refer to the Assembly Diagram of this manual. Unwrap and separate all parts in a clear work area.

ASSEMBLY STEP

1. Take the product out of the packaging and open it.

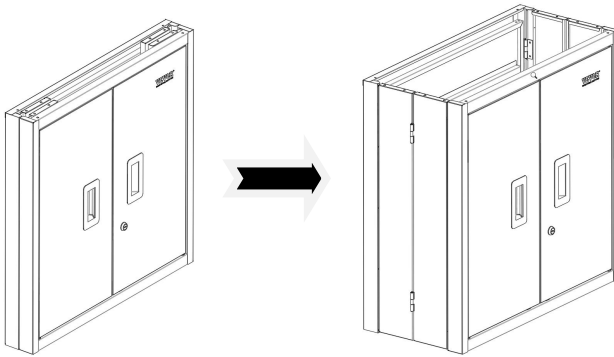

2. Install the shelf support. Please note that there are 4 adjustable installation slots upon opening for adjusting the height of the middle shelf. However, it can only be folded when installed in the second hole from the top.

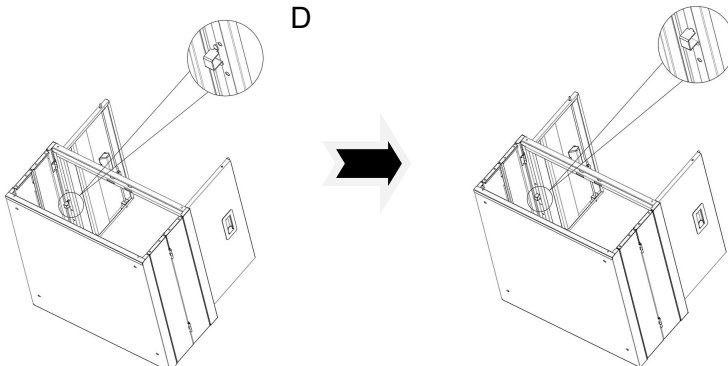

3. Open the middle shelf and bottom shelf as shown in the following picture. The overcoil(Part E) was installed before leaving the factory, and there is no need for you to install it.

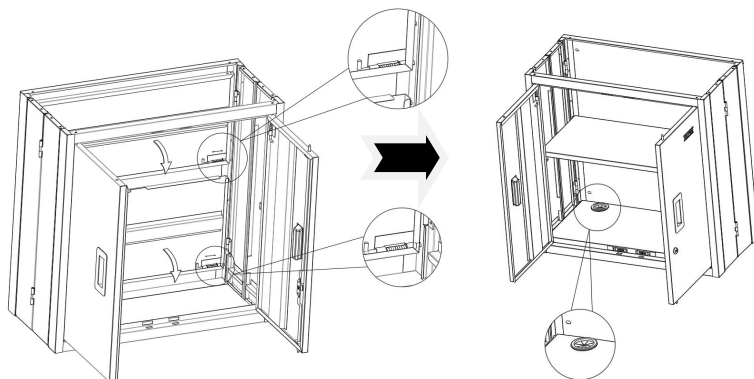

4. Install the magnet (part C)

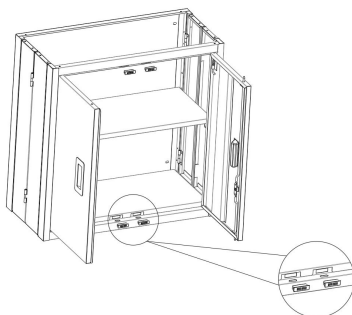

5. Install EVA(part J) stickers next to the magnet. The EVA of the upper and lower ends of the door frame are attached to the magnet, as shown in the figure.

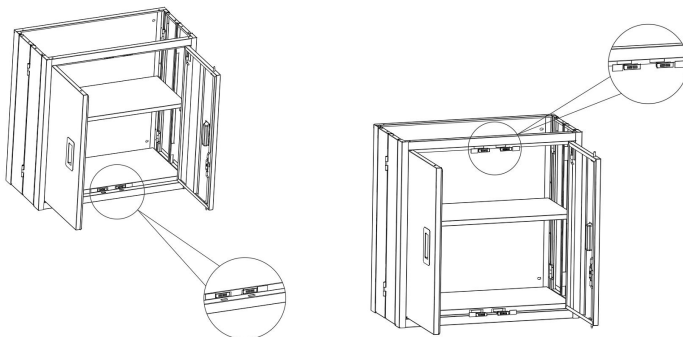

6. Install the top shelf(part B). Please note that the top shelf should be hooked onto the side of the cabinet door first before being covered.

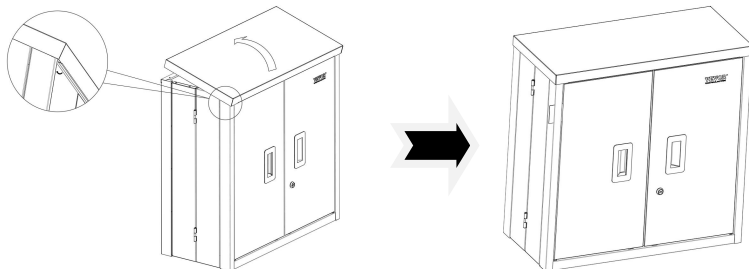

7. Install the garage wall cabinet onto the wall. Please note that the holes should be drilled accurately. The rubber plug (part G) should be securely inserted into the wall to ensure stability, and the screws must be tightened with a washer. They need to be fully tightened. Before installation, please make sure that the wall surface is flat.

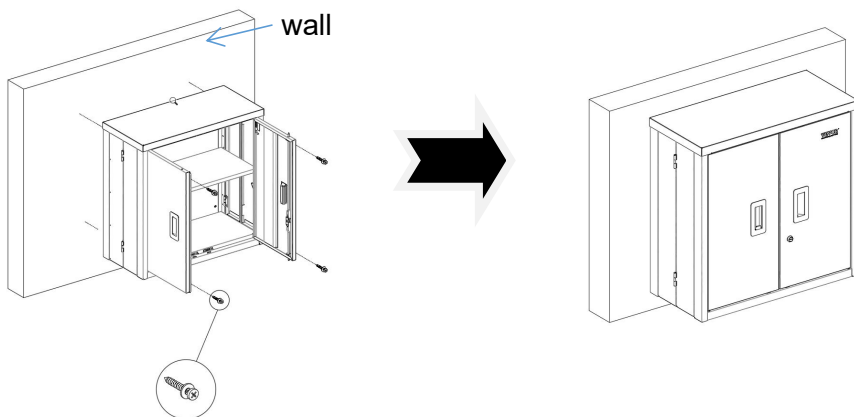

8. Please ensure that the weight is evenly distributed and do not exceed the weight limit when in use.

VEVOR[®]

TOUGH TOOLS, HALF PRICE

Technical Support and E-Warranty Certificate

www.vevor.com/support