

# **VEVOR<sup>®</sup>**

## **TOUGH TOOLS, HALF PRICE**

Technical Support and E-Warranty Certificate [www.vevor.com/support](http://www.vevor.com/support)

### **CAT EXERCISE WHEEL USER MANUAL**

We continue to be committed to provide you tools with competitive price.

"Save Half", "Half Price" or any other similar expressions used by us only represents an estimate of savings you might benefit from buying certain tools with us compared to the major top brands and does not necessarily mean to cover all categories of tools offered by us. You are kindly reminded to verify carefully when you are placing an order with us if you are actually saving half in comparison with the top major brands.



# VEVOR<sup>®</sup>

TOUGH TOOLS, HALF PRICE

## CAT EXERCISE WHEEL

Model: 4.0 XS 4.0 M 4.0 XL 4.0 XXL

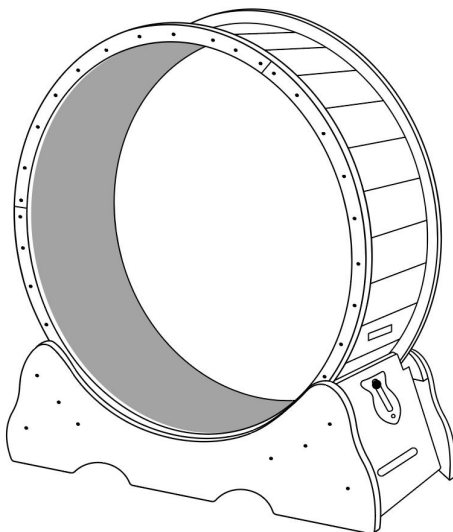

### NEED HELP? CONTACT US!

Have product questions? Need technical support? Please feel free to contact us:

**Technical Support and E-Warranty Certificate**  
[www.vevor.com/support](http://www.vevor.com/support)

This is the original instruction, please read all manual instructions carefully before operating. VEVOR reserves a clear interpretation of our user manual. The appearance of the product shall be subject to the product you received. Please forgive us that we won't inform you again if there are any technology or software updates on our product.

## **SPECIFICATIONS**







Model	4.0 XS
Product Size	750×320×800mm
Color	Natural

Model	4.0 M
Product Size	910×320×970mm
Color	Natural

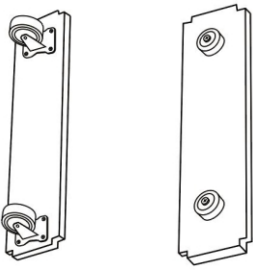
Model	4.0 XL
Product Size	1105×345×1170mm
Color	Black

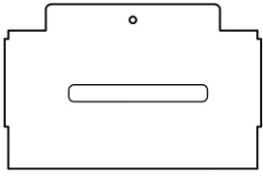
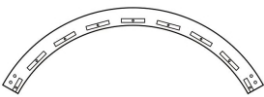
Model	4.0 XXL
Product Size	1320×340×1415mm
Color	Natural

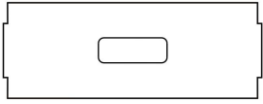
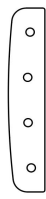
# COMPONENTS

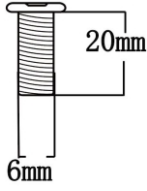
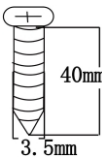
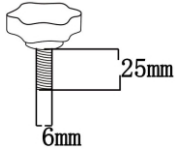
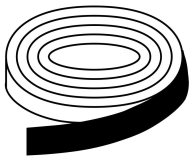
 <p><b>A×2</b>      <b>P×2</b></p>	 <p><b>B×2</b></p>	 <p>*C a plank with only one screw hole</p> <p><b>C×2</b></p>
 <p><b>D×6</b></p>	<p>* three pieces of E have double holes on the side.</p>  <p>4.0XS /4.0M    <b>E×17</b> 4.0XL/4.0XXL   <b>E×23</b></p>	 <p><b>F×1</b></p>
 <p><b>G×6</b></p>	 <p><b>H×1</b></p>	 <p><b>K×24</b></p>
 <p>4.0XS /4.0M    <b>L×58</b> 4.0XL/4.0XXL   <b>L×70</b></p>	 <p><b>N×1</b></p>	 <p><b>M×1</b></p>
<p>* Components A, C, E, F, P have been pre installed with plastic solenoids.</p> <p>* Each set comes with a screwdriver, cat teaser, gloves and sandpaper.</p>		

# Assembly Instructions

## Instructions hint:

**Do not tighten the mounting screws to the end at one time, and tighten them again after a single component is installed and formed!**

### STEP1

### Base installation

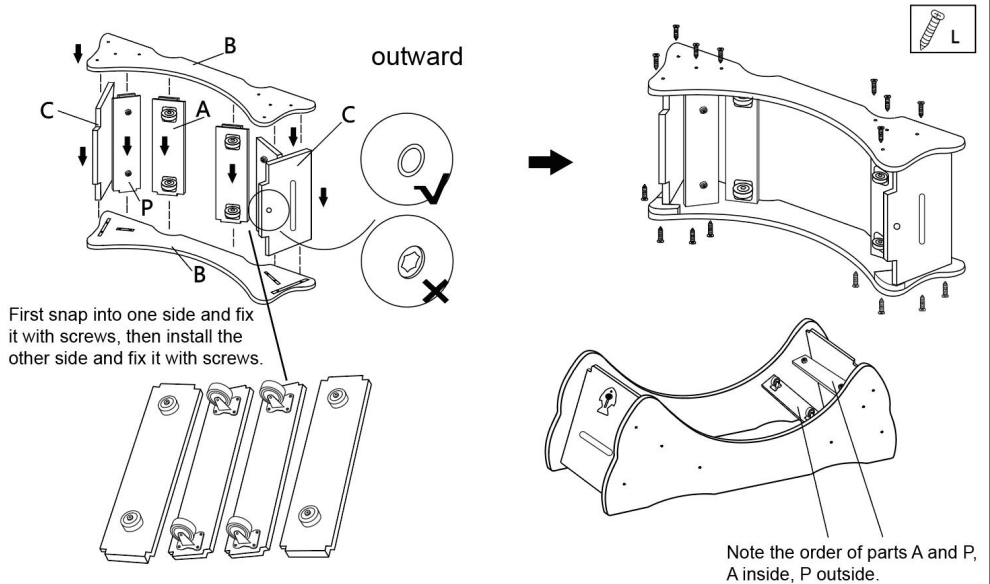

### STEP2

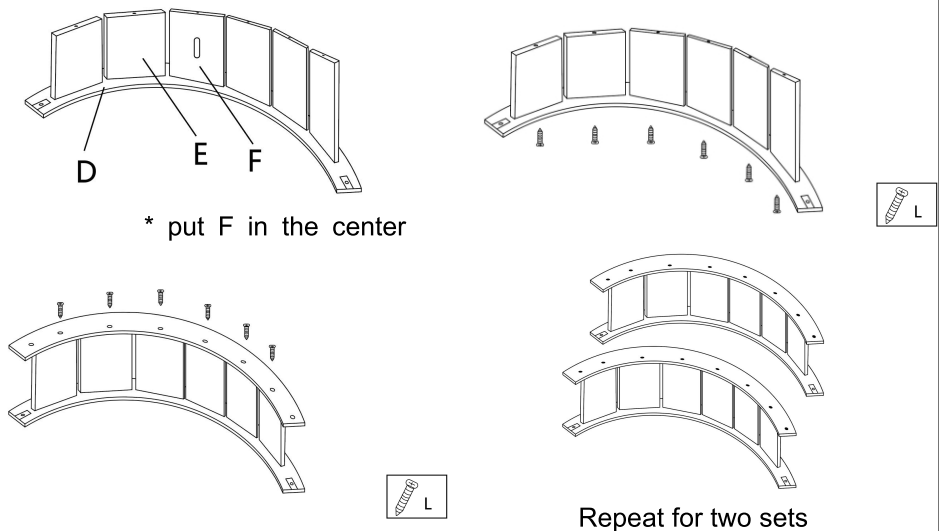

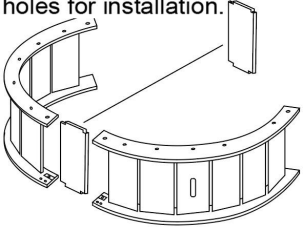
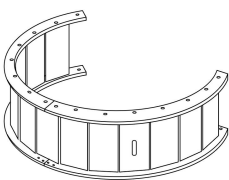
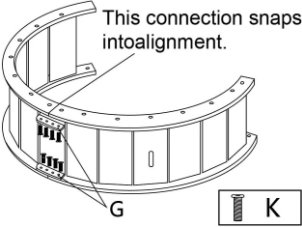
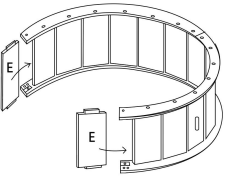
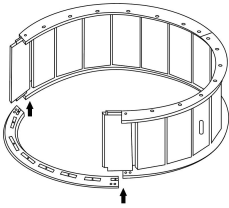
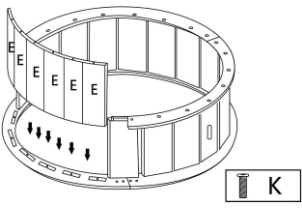
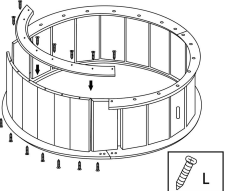
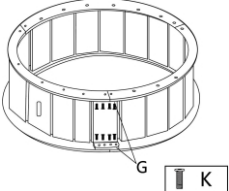
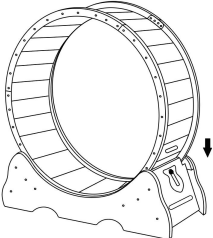
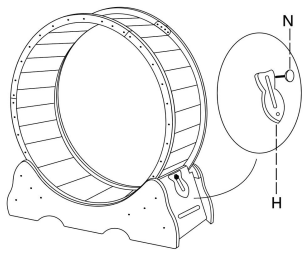
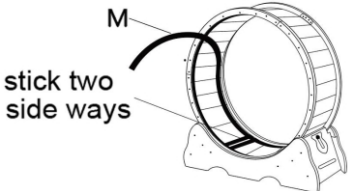
<p><b>STEP3</b></p> <p>Here, use E with double holes for installation.</p> 	<p><b>STEP4</b></p> 	<p><b>STEP5</b></p> <p>This connection snaps into alignment.</p> 
<p><b>STEP6</b></p> 	<p><b>STEP7</b></p> 	<p><b>STEP8</b></p> 
<p><b>STEP9</b></p> 	<p><b>STEP10</b></p> 	<p><b>STEP11</b></p>  <p>Place the rollers on the base.</p>
<p><b>STEP12</b></p>  <p>Connect the lock plate H with the screw N and fix it on the plate with holes C.</p>	<p><b>STEP13</b></p> <p>Please paste the black buckle as shown in the figure below.</p>  <p>stick two side ways</p> <p>Put black belt back glue mother-in-law Tear off the top layer paper, along the Roller fixed one circle.(Wipe the rollers clean first!)</p> <p>The Velcro of the accessories is sent out in one piece, which needs to be cut according to the length of the runway.</p>	

STEP14

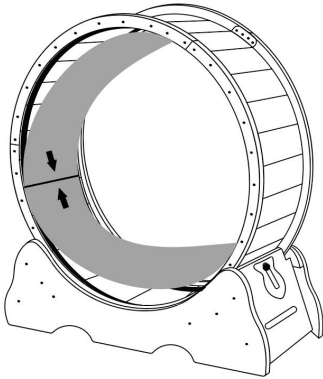

STEP15

Finished

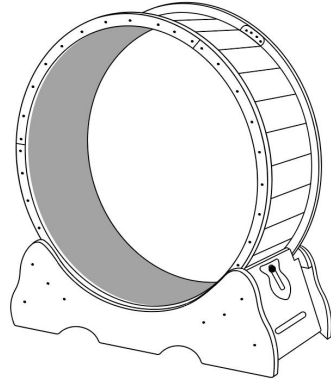

Lock it when not in use.

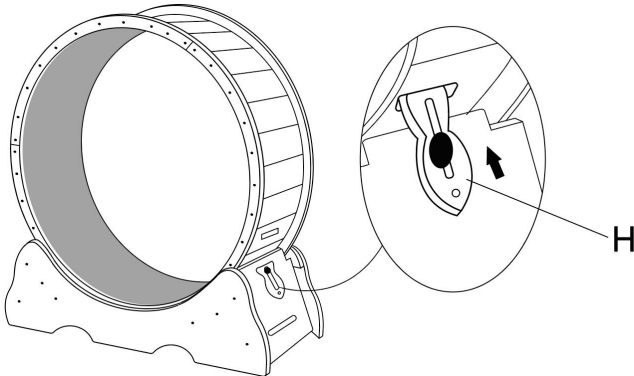

\* H wooden lock is inserted into the card slot and locked.

**TIPS:**

1. The number of screws marked above is the actual number used during installation. When the product is shipped, 1~3 more screws of each type will be given as spares.
2. During the use of the product, children are prohibited from approaching without the company of adults.
3. The edge of the product is a bit sharp, and you need to wear gloves for installation; at the same time, it comes with sandpaper, so you can polish the edge again by yourself; without gloves, be careful when touching the running wheel.



**Address:** Shuangchenglu 803nong11hao1602A-1609shi, baoshanqu, shanghai 200000 CN.

**Imported to AUS:** SIHAO PTY LTD, 1 ROKEVA STREETEASTWOOD NSW 2122 Australia

**Imported to USA:** Sanven Technology Ltd.Suite 250, 9166 Anaheim Place, Rancho Cucamonga, CA 91730

<b>EC</b>	<b>REP</b>
-----------	------------

E-CrossStu GmbH.

Mainzer Landstr.69, 60329 Frankfurt am Main.

<b>UK</b>	<b>REP</b>
-----------	------------

YH CONSULTING LIMITED.

C/O YH Consulting Limited Office 147, Centurion House,  
London Road, Staines-upon-Thames, Surrey, TW18 4AX.





**VEVOR<sup>®</sup>**

**TOUGH TOOLS, HALF PRICE**

**Technical Support and E-Warranty Certificate**

**[www.vevor.com/support](http://www.vevor.com/support)**