

# **VEVOR<sup>®</sup>**

**TOUGH TOOLS, HALF PRICE**

Technical Support and E-Warranty Certificate [www.vevor.com/support](http://www.vevor.com/support)

## **OUTDOOR STORAGE BOX**

### **USER MANUAL**

We continue to be committed to provide you tools with competitive price.

"Save Half", "Half Price" or any other similar expressions used by us only represents an estimate of savings you might benefit from buying certain tools with us compared to the major top brands and does not necessarily mean to cover all categories of tools offered by us. You are kindly reminded to verify carefully when you are placing an order with us if you are actually saving half in comparison with the top major brands.

# VEVOR<sup>®</sup>

TOUGH TOOLS, HALF PRICE

## OUTDOOR STORAGE BOX

JH-100 / JH-150 / JH-230



### NEED HELP? CONTACT US!

Have product questions? Need technical support? Please feel free to contact us:

**Technical Support and E-Warranty Certificate**  
[www.vevor.com/support](http://www.vevor.com/support)

This is the original instruction, please read all manual instructions carefully before operating. VEVOR reserves a clear interpretation of our user manual. The appearance of the product shall be subject to the product you received. Please forgive us that we won't inform you again if there are any technology or software updates on our product.

# Safety precautions

## WARNING:

**Read this instructions** before using this product. Failure to do so can result in serious injury. the basic precautions should always be followed,including the following:

1. The storage box may not be used or stored in hazardous areas. It is not allowed to use the appliance in hazardous locations.
2. The storage box must be checked to ensure that it is in proper working order and is operating safely prior to use. Otherwise,the appliance must not be used.
3. Use as intended only. The storage box is not suitable for sweeping off corrosive substances. as they can harm the materials on it.
4. Do not put it near flammable materials, Keep away from fire.
5. The operator must use the storage box properly. He must consider the local conditions and must pay attention to third parties,in particular children,when working with the storage box.
6. This storage box is not intended for use by persons (including children) with reduced physical,sensory or mental abilities or lacking experience and/or knowledge,unless they are super- vised by a person responsible for their safety or are instructed by these persons on the use of the device. Children should be supervised,to ensure that they do not play with the storage box.

## SAVE THESE INSTRUCTIONS

# Part List

---

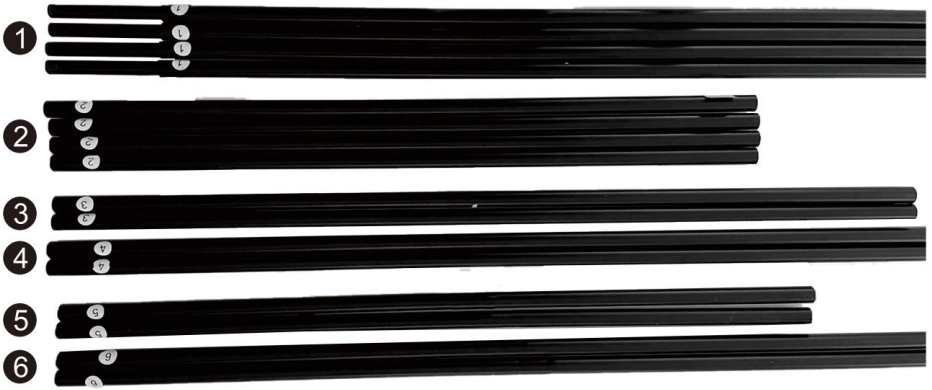

Metal tube

①x4

②x4

③x2

④x2

⑤x2

⑥x2

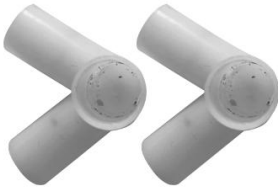

A-70°Tee×2

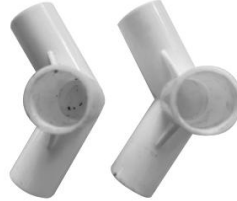

B-110°Tee×2



Cloth coverx1



C-90°Tee×4

# Product Specification

	JH-100	JH-150	JH-230
Volume	100gal	150gal	230gal
Product Size	122*64*(75*52)cm	155*64*(75*52)cm	147*86*(109*84)cm
Package Size	76*19*12cm	84*20*12cm	110*20*13cm
Net Weight	5.53kg	6.45kg	7.8kg
Gross Weight	5kg	5.95kg	7.35kg

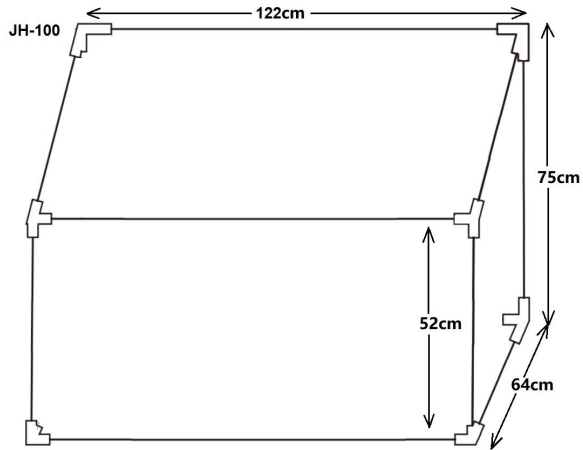

# Structure Diagram

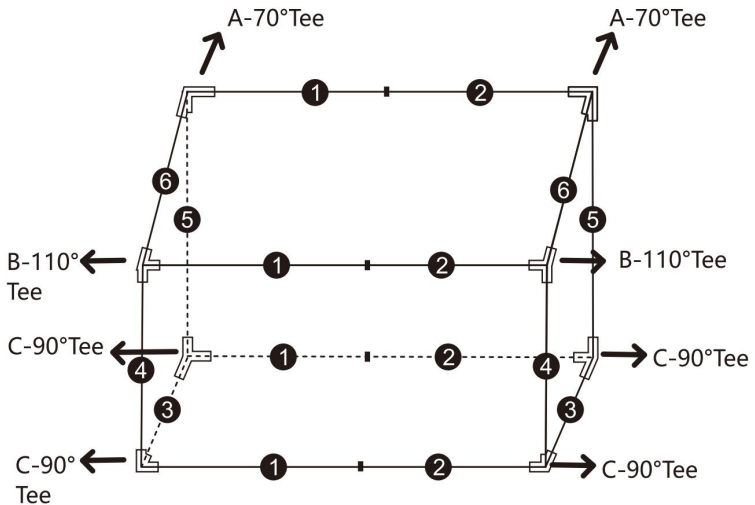

# Assembly Steps

## Step1

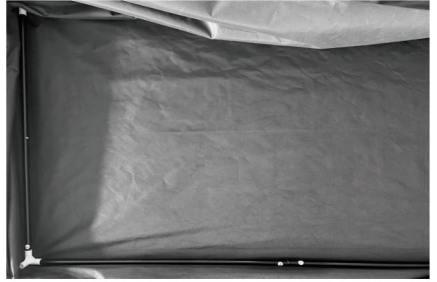
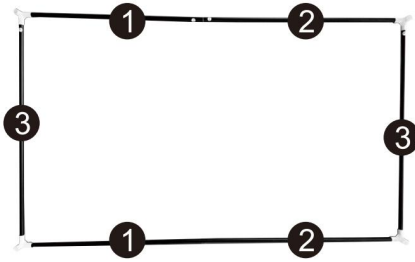

C-90° Tee\*4

① x2

② x2

③ x2

Put the 1,2 and 3 metal pipes into the bottom of the cloth sleeve after assembly according to the legend.

## Step2



A-70°

Tee x2

B-110°

Tee x2

① x2

② x2

④ x2

⑤ x2

⑥ x2

Assemble other metal pipes in turn.

## Step3

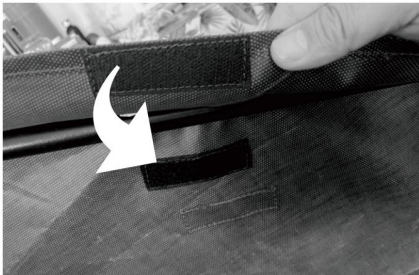

Assembly

Complete

Tighten the cloth cover and paste the Velcro.

**Manufacturer:**Shanghaimuxinmuyeyouxiangongsi

**Address:** Shuangchenglu 803nong11hao1602A-1609shi, baoshanqu, shanghai  
200000 CN.

**Imported to AUS:** SIHAO PTY LTD. 1 ROKEVA STREETEASTWOOD NSW 2122  
Australia

**Imported to USA:** Sanven Technology Ltd. Suite 250, 9166 Anaheim Place,  
Rancho Cucamonga, CA 91730

<b>EC</b>	<b>REP</b>
-----------	------------

E-CrossStu GmbH  
Mainzer Landstr.69, 60329 Frankfurt am Main.

<b>UK</b>	<b>REP</b>
-----------	------------

YH CONSULTING LIMITED.  
C/O YH Consulting Limited Office 147, Centurion House,  
London Road, Staines-upon-Thames, Surrey, TW18 4AX

**VEVOR<sup>®</sup>**

**TOUGH TOOLS, HALF PRICE**

**Technical Support and E-Warranty Certificate**

**[www.vevor.com/support](http://www.vevor.com/support)**