

VEVOR[®]

TOUGH TOOLS, HALF PRICE

Technical Support and E-Warranty Certificate www.vevor.com/support

ANIMAL TRAP

MODEL:LB-18/LB-28A

We continue to be committed to provide you tools with competitive price.

"Save Half", "Half Price" or any other similar expressions used by us only represents an estimate of savings you might benefit from buying certain tools with us compared to the major top brands and does not necessarily mean to cover all categories of tools offered by us. You are kindly reminded to verify carefully when you are placing an order with us if you are actually saving half in comparison with the top major brands.

VEVOR[®]

TOUGH TOOLS, HALF PRICE

ANIMAL TRAP

MODEL:LB-18/LB-28A

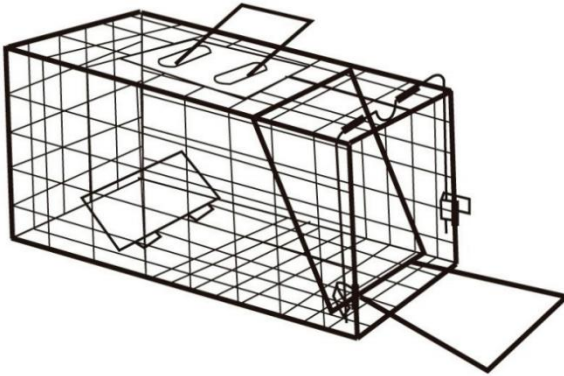

NEED HELP? CONTACT US!

Have product questions? Need technical support? Please feel free to contact us:

Technical Support and E-Warranty Certificate
www.vevor.com/support

This is the original instruction, please read all manual instructions carefully before operating. VEVOR reserves a clear interpretation of our user manual. The appearance of the product shall be subject to the product you received. Please forgive us that we won't inform you again if there are any technology or software updates on our product.

WARNING:

Read this material before using this product. Failure to do so can result in serious injury.

Assembly precautions

1. Assemble only according to these instructions. Improper assembly can create hazards.
2. In order to ensure your own safety, please make sure to wear ANSI-approved safety goggles and heavy-duty work gloves when installing this product.
3. Keep the assembly area clean and well lit.
4. Keep bystanders out of the area during assembly.
5. Do not assemble when tired or when under the influence of alcohol, drugs or medication.
6. Product capabilities apply to properly and completely assembled product only.
7. Assemble on a flat, level, hard and smooth surface capable of safely supporting a fully loaded animal trap.

Use precautions

TO PREVENT SERIOUS INJURY AND DEATH FROM TIPPING:

1. DO NOT SIT OR STAND ON THIS ITEM.
2. This product is not a toy. Do not allow children to play with or near this item. Please keep small spare parts out of children's reach.
3. Use only on a flat, level, hard and smooth surface capable of safely supporting a fully loaded animal trap.
4. Use as intended only.
5. Inspect before every use; do not use if parts are loose or damaged.
6. We recommend 2 or more people to install.

SAVE THESE INSTRUCTIONS

SPECIFICATIONS

Model	LB-18	LB-28A
Product Size	610X203X203 mm	813X254X305mm
Color	silver	silver
accessories	cable ties*10	cable ties*10

Assembly Instructions

Notice:

1. When installing, please wear gloves and be careful where you touch (pull rod, pedal, etc.) to avoid being hurt.

2. Use nylon cable ties to reinforce the back door where the wild animal may escapes more likely.

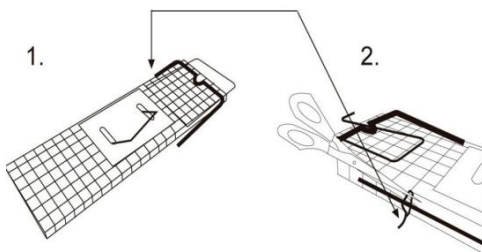

Use scissors to cut the cable.

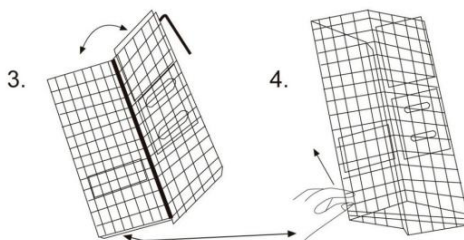

Flip the cage over to the right hand side and then lift the cage up.

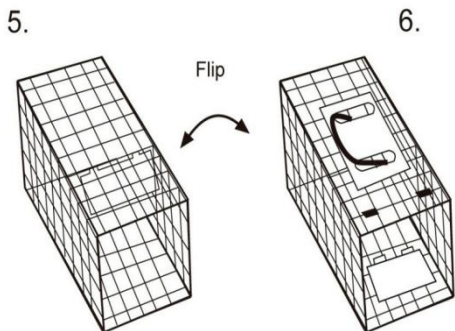

The cage should look like diagram 5. Its currently in an upside down position. Flip and turn the whole cage around so its the correct side up You are now looking at the back of the cage

7. Back of the cage

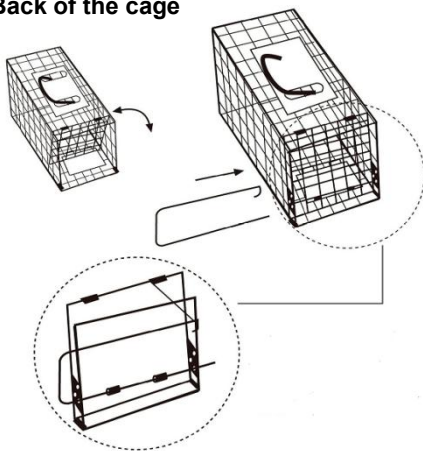

Pull the back plate down and lock it in place, insert the short metal rod through the holes(do not forget to hook the rod around the side of the cage)

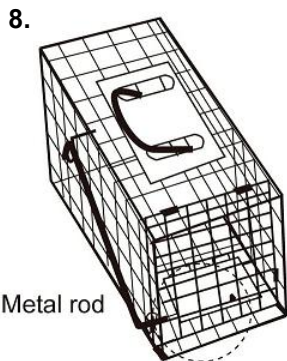

Metal rod

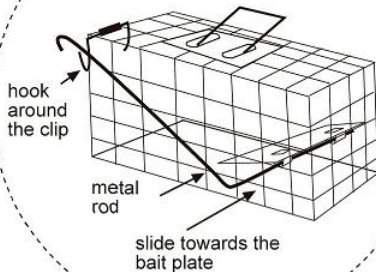

Front of the cage

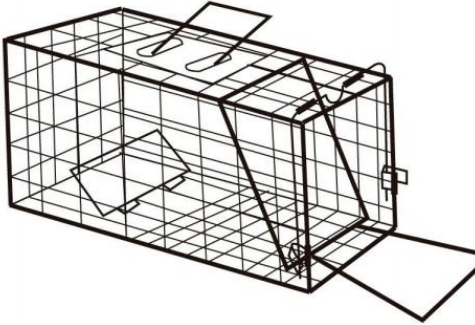

Slide the metal rod towards the bottom of the bait plate and then hook the rod around the clip. Setting up the back is now complete

Turn the cage around so you are now facing the front of the cage.

9.

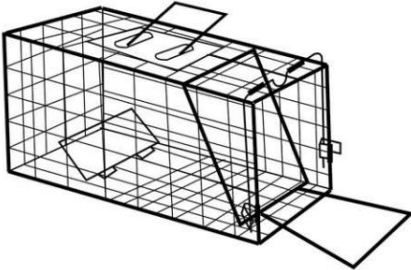

10.

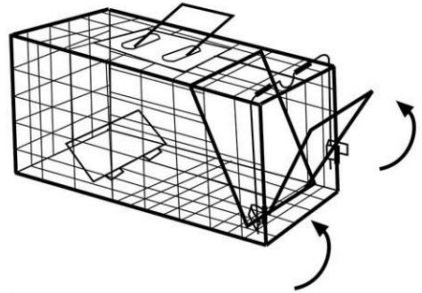

11.

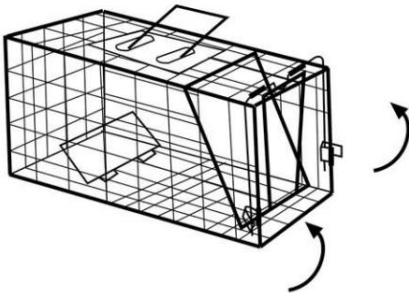

12.

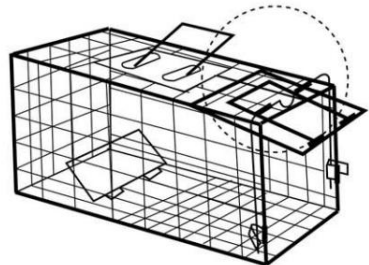

Lift the trap door spring and push towards the bait plate. Now is the time to place the baits behind the bait plate. Secure the metal rod using the metal folding tags already attached to the cage.

13.

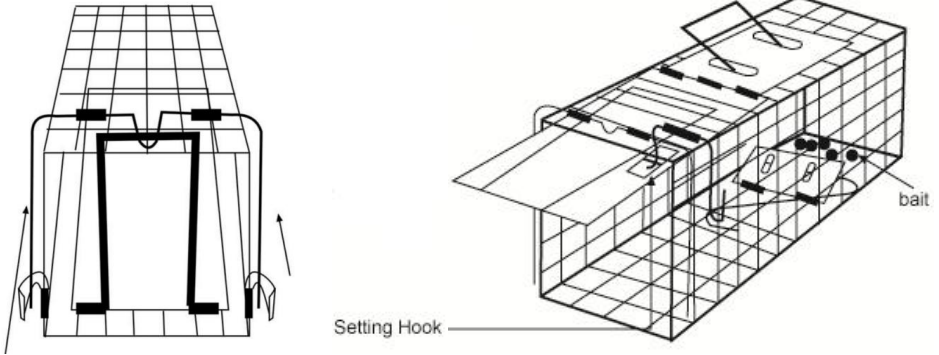

Hold the trap door in an open position, set the trap by swinging the setting hook beneath the bush on the trap door, and then lower the door to release pressure back onto the setting hook. The cage should look like diagram 14. Once set, the trap should be left in position for at least 7 days before relocating.

You can transport the cage using the carrier handles at the top of the trap.

Baoshanqu Shuangchenglu 803long 11hao 1602A-1609shi Shanghai
Imported to USA: Sanven Technology Ltd., Suite 250, 9166 Anaheim Place,
Rancho Cucamonga, CA 91730

EC	REP	SHUNSHUN GmbH Römeräcker 9 Z2021,76351 Linkenheim-Hochstetten, Germany
UK	REP	Pooledas Group Ltd Unit 5 Albert Edward House, The Pavilions Preston, United Kingdom

MADE IN CHINA

VEVOR[®]

TOUGH TOOLS, HALF PRICE

Technical Support and E-Warranty Certificate

www.vevor.com/support