

Double Curtain Rods

TW-R36/72
TW-R72/144
TW-S36/72



NOTE: The shown is for illustration purposes only, it does not represent the finial purchased! Please refer to your purchase!

NEED HELP? CONTACT US!

Have product questions? Need technical support?
Please feel free to contact us:
Technical Support and E-Warranty Certificate
www.vevor.com/support

This is the original instruction, please read all manual instructions carefully before operating. VEVOR reserves clear interpretation of our user manual. The appearance of the product shall be subject to the product you received. Please forgive us that we won't inform you again if there is any technology or software updates on our product.

SAFETY INSTRUCTIONS

1.This product contains small parts. If swallowed, it will pose a choking hazard. Keep these small parts away from children !

2.Read, understand and follow your power tool manufacturer's instructions for safety. Always wear safety glasses or eye shields before assembly and commencing power tool operation. Always keep hands, face, hair, loose clothing, and body at a safe distance from spindles and cutting tools. Always keep a firm grip on tool handles when in operation. Always disconnect from the power source before adjusting power tools.

NOTE:

1.The shown is for illustration purposes only. It may not represent the style of the finial purchased.

2.Please follow the installation steps to mount this curtain rod. Wrong installation steps may cause some damage trouble.

3. Installation is easy. Handle it gently, please.

MODEL AND PARAMETERS

Model	TW-R36/72	TW-R72/144	TW-S36/72
Stretch Length	36-72inch	72-144inch	36-72inch
Color	Black	Black	Black
Finial			
Capacity	30lbs	30lbs	30lbs

STRUCTURE DIAGRAM AND COMPONENTS

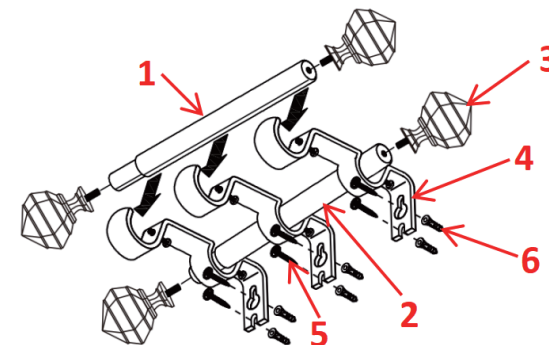

Model	Parts
TW-R36/72	1.Front Rod x 1 2.Back Rod x 1 3.Trim Head x 4(Each size 2) 4.Brackets(Inclusion bolt) x 3 5.Mounting screws x 7 6.Expansion Plugs x 7 7.User Manual x 1
TW-R72/144	1.Front Rod x 1 2.Back Rod x 1 3.Trim Head x 4 (Each size 2) 4.Brackets(Inclusion bolt) x 4 5.Mounting screws x 9 6.Expansion Plugs x 9 7.User Manual x 1
TW-S36/72	1.Front Rod x 1 2.Back Rod x 1 3.Trim Head x 4 (Each size 2) 4.Brackets(Inclusion bolt) x 3 5.Mounting screws x 7 6.Expansion Plugs x 7 7.User Manual x 1

HOW TO INSTALL IT

Step 1

Place brackets against the wall at desired locations. Mark screw holes and be sure the marks of each bracket are at the same height level.

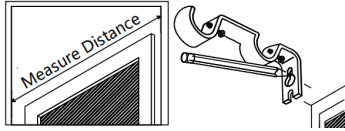

Step 2

Please drill a 3/16" hole at each pencil mark and then mount the brackets .

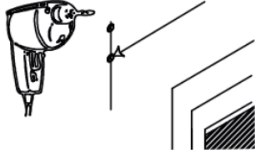

Step 3

Assemble the inner or outer rod parts and then shirr the drapery treatment onto the

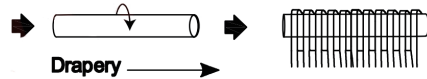

Step 4

Screw rod finials on each rod end. Rotate the finial and rod parts for proper alignment and visual balance if required.

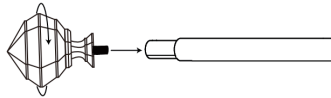

Step 5

Extend the rod to the desired width. Lift the rod with drapery and drop it into brackets. Adjust draperies to the desired position.

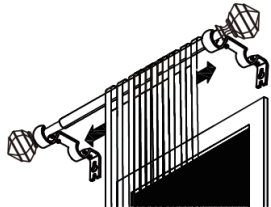

Step 6

Lock each rod part into position by tightening the screw by the tool until tight as picture shows, which will prevent the rod from moving.

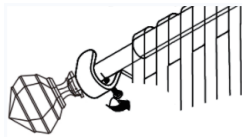

MAINTENANCE

1. Cleaning regularly .
2. Collision avoidance.

Address: Shuangchenglu 803nong11hao1602A-1609shi, baoshanqu, shanghai 200000 CN.

Imported to AUS: SIHAO PTY LTD, 1 ROKEVA STREETEASTWOOD NSW 2122 Australia

Imported to USA: Sanven Technology Ltd., Suite 250, 9166 Anaheim Place, Rancho Cucamonga, CA 91730

EC	REP
----	-----

E-CrossStu GmbH
Mainzer Landstr.69, 60329 Frankfurt am Main.

UK	REP
----	-----

YH CONSULTING LIMITED.
C/O YH Consulting Limited Office 147, Centurion House,
London Road, Staines-upon-Thames, Surrey, TW18 4AX

VEVOR®

TOUGH TOOLS, HALF PRICE

Technical Support and E-Warranty Certificate
www.vevor.com/support

Double Curtain Rods

We continue to be committed to provide you tools with competitive price. "Save Half", "Half Price" or any other similar expressions used by us only represents an estimate of savings you might benefit from buying certain tools with us compared to the major top brands and does not necessarily mean to cover all categories of tools offered by us. You are kindly reminded to verify carefully when you are placing an order with us if you are actually saving half in comparison with the top major brands.

VEVOR®

TOUGH TOOLS, HALF PRICE

Technical Support and E-Warranty Certificate
www.vevor.com/support