

VEVOR[®]

TOUGH TOOLS, HALF PRICE

Technical Support and E-Warranty Certificate www.vevor.com/support

SNOW PUSHER

USER MANUAL

We continue to be committed to provide you tools with competitive price.

"Save Half", "Half Price" or any other similar expressions used by us only represents an estimate of savings you might benefit from buying certain tools with us compared to the major top brands and does not necessarily mean to cover all categories of tools offered by us. You are kindly reminded to verify carefully when you are placing an order with us if you are actually saving half in comparison with the top major brands.

VEVOR®

TOUGH TOOLS, HALF PRICE

SNOW PUSHER

CY-SL24



NEED HELP? CONTACT US!

Have product questions? Need technical support? Please feel free to contact us:

Technical Support and E-Warranty Certificate
www.vevor.com/support

This is the original instruction, please read all manual instructions carefully before operating. VEVOR reserves a clear interpretation of our user manual. The appearance of the product shall be subject to the product you received. Please forgive us that we won't inform you again if there are any technology or software updates on our product.

Safety precautions

WARNING:

Read this instructions before using this product. Failure to do so can result in serious injury. the basic precautions should always be followed, including the following:

1. The snow pusher may not be used or stored in hazardous areas. It is not allowed to use the appliance in hazardous locations.
2. The snow pusher must be checked to ensure that it is in proper working order and is operating safely prior to use. Otherwise, the appliance must not be used.
3. Use as intended only. The snow pusher is not suitable for sweeping off corrosive substances. as they can harm the materials on the snow pusher.
4. Please wear safety gloves when operating snow pusher.
5. The operator must use the snow pusher properly. He must consider the local conditions and must pay attention to third parties, in particular children, when working with the snow pusher.
6. This snow pusher is not intended for use by persons (including children) with reduced physical, sensory or mental abilities or lacking experience and/or knowledge, unless they are supervised by a person responsible for their safety or are instructed by these persons on the use of the device. Children should be supervised, to ensure that they do not play with the snow pusher.







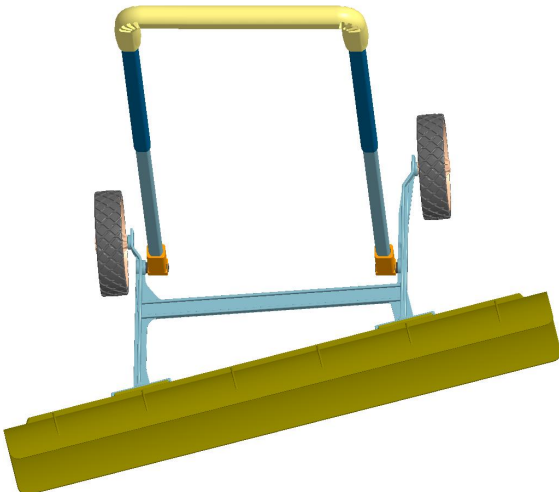
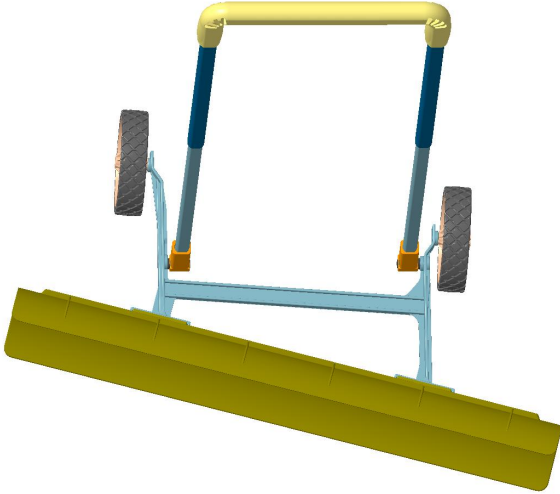



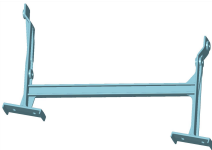
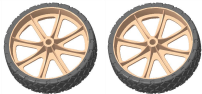

SAVE THESE INSTRUCTIONS

Model	Width(in)	Length(in)	Plow Materials
CY-SL24	10	30	Aluminium alloy

THE SNOW PUSHER CAN BE REVERSED UP AND DOWN FOR BETTER SNOW REMOVAL.



Part List

Number	Name	Quantity	Picture
A	Handle	1	
B	Extension Rod	2	
C	Fixed Support	1	
D	Wheel	2	
E	Snow Pusher	1	
F	Screw	4	
G	Screw	2	
H	Screw	2	
J	Nut	8	
K	Aluminium Block	4	
L	Spacer	10	
M	Spacer	2	
N	Spanner	2	

Assemble Step

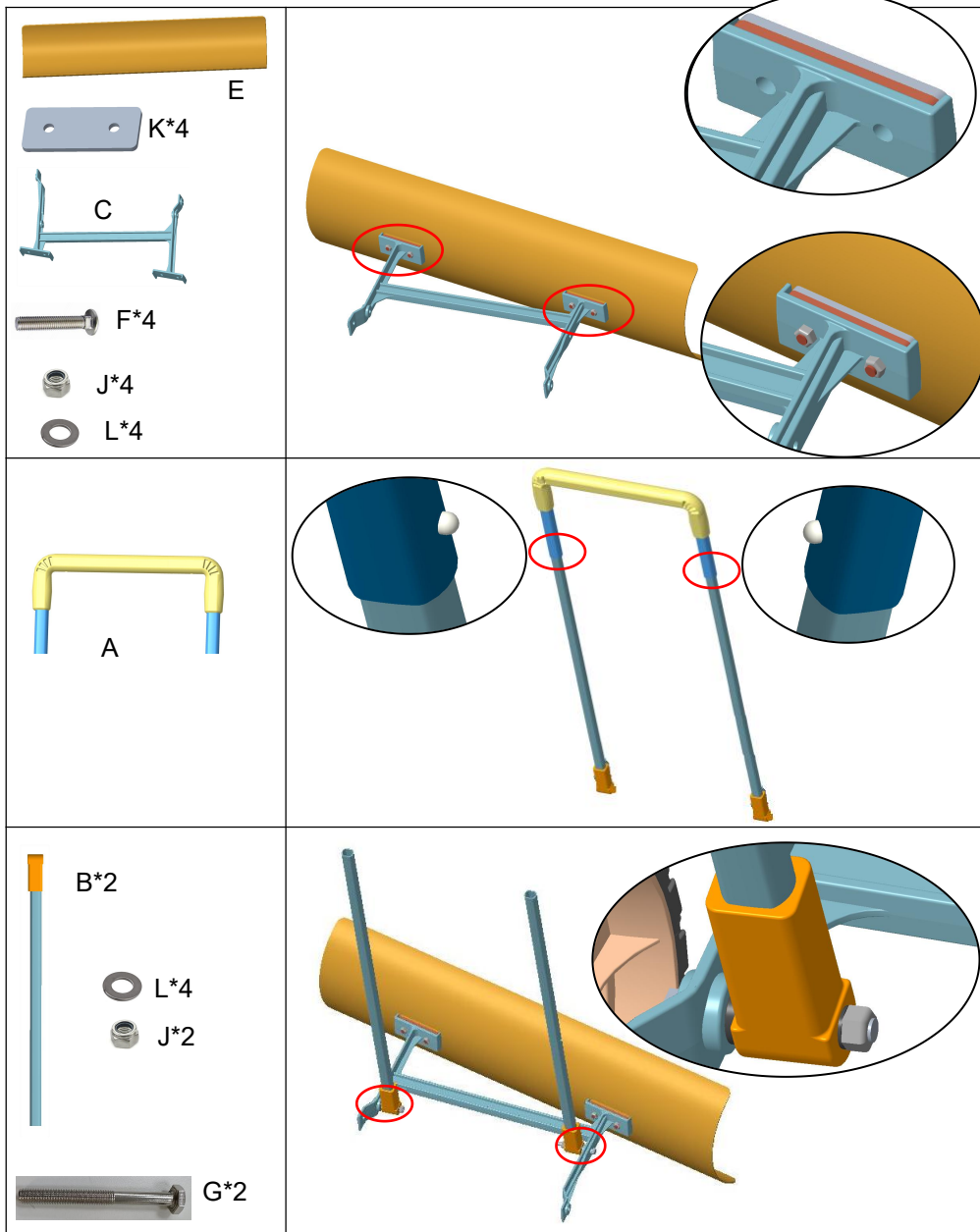

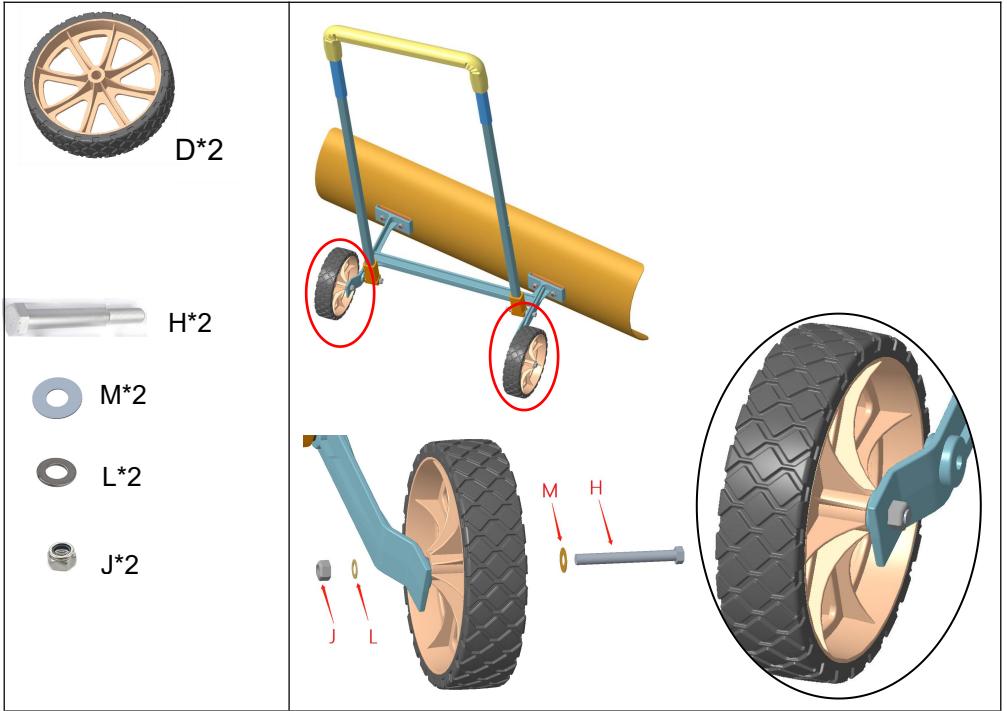

Sanven Technology Ltd.

Address: Suite 250, 9166 Anaheim Place, Rancho Cucamonga, CA 91730

VEVOR[®]

TOUGH TOOLS, HALF PRICE

Technical Support and E-Warranty Certificate

www.vevor.com/support