

VEVOR[®]

TOUGH TOOLS, HALF PRICE

Technical Support and E-Warranty Certificate www.vevor.com/support

DOG CRATE USER MANUAL

We continue to be committed to provide you tools with competitive price.

"Save Half", "Half Price" or any other similar expressions used by us only represents an estimate of savings you might benefit from buying certain tools with us compared to the major top brands and does not necessarily mean to cover all categories of tools offered by us. You are kindly reminded to verify carefully when you are placing an order with us if you are actually saving half in comparison with the top major brands.

VEVOR[®]

TOUGH TOOLS, HALF PRICE

DOG CRATE

Model: C20230602W-02

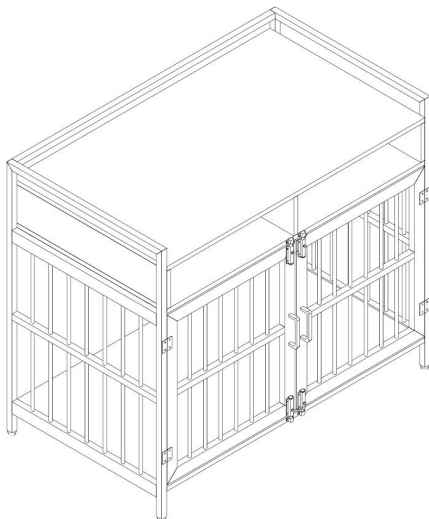

NEED HELP? CONTACT US!

Have product questions? Need technical support? Please feel free to contact us:

Technical Support and E-Warranty Certificate
www.vevor.com/support

This is the original instruction, please read all manual instructions carefully before operating. VEVOR reserves a clear interpretation of our user manual. The appearance of the product shall be subject to the product you received. Please forgive us that we won't inform you again if there are any technology or software updates on our product.

SAFETY NOTICE

Read this material before using this product. Failure to do so can result in serious injury.

Assembly precautions

1. Assemble only according to these instructions. Improper assembly can create hazards.
2. In order to ensure your own safety, please make sure to ANSI-approved safety goggles and heavy-duty work gloves when installing this product.
3. Keep the assembly area clean and well lit.
4. Keep bystanders out of the area during assembly.
5. Do not assemble when tired or when under the influence of alcohol, drugs or medication.
6. Product capabilities apply to properly and completely assembled products only.
7. Assemble on a flat, level, hard and smooth surface capable of safely supporting a fully loaded dog cage.

Use precautions

TO PREVENT SERIOUS INJURY AND DEATH FROM TIPPING:











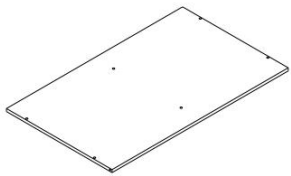
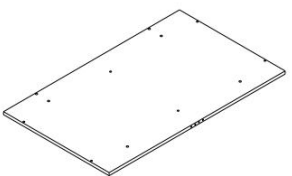
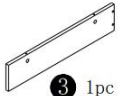
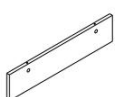
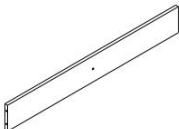
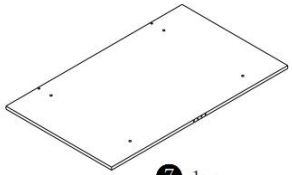









1. DO NOT SIT, STAND OR CLIMB ON THIS ITEM.
2. This product is not a toy. Do not allow children to play with or near this item. Please keep small spare parts out of children's reach.
3. Use only on a flat, level, hard and smooth surface capable of safely supporting a fully loaded dog cage.
4. Use as intended only.
5. Inspect before every use; do not use if parts are loose or damaged.

SAVE THESE INSTRUCTIONS

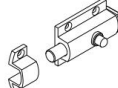
SPECIFICATIONS

| | |
|--------------|----------------|
| Model | C20230602W-02 |
| Product Size | 41*23.6*36.2in |
| Color | Brown |

COMPONENTS

| | | | | | |
|---------------------------------------------------------------------------------------------------------------|--|---------------------------------------------------------------------------------------------------------------|--|--------------------------------------------------------------------------------------------------------------|--|
|  <p>1 1pc</p> | |  <p>2 1pc</p> | |  <p>3 1pc</p> | |
|  <p>5 1pc</p> | |  <p>6 1pc</p> | |  <p>7 1pc</p> | |
|  <p>9 1pc</p> | |  <p>10 1pc</p> | |  <p>11 2pcs</p> | |
| | |  <p>12 4pcs</p> | |  <p>13 1pc</p> | |
|  <p>A 9pcs</p> | |  <p>B 16pcs</p> | |  <p>C 9pcs</p> | |
|  <p>D 5pcs</p> | |  <p>F 9pcs</p> | | | |
|  <p>H 11pcs</p> | |  <p>S 5pcs</p> | |  <p>K 2pcs</p> | |
|  <p>Q 11pcs</p> | |  <p>R 4pcs</p> | | | |
|  <p>N 9pcs</p> | |  <p>L 17pcs</p> | |  <p>Y 4pcs</p> | |
|  <p>X 1pc</p> | |  | |  | |

Assembly Instructions

Installation of Cams and Pins

Screw the pin into the hole. To set the cams correctly, ensure that the arrow on the cam is opening to the hole of the pin it is locking. Lock the cam by turning tightened. Please do not use an electric screwdriver to assemble the unit. the cam head with a screwdriver until it .

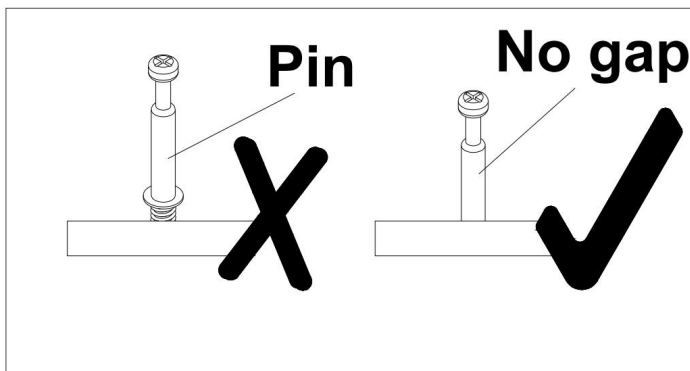
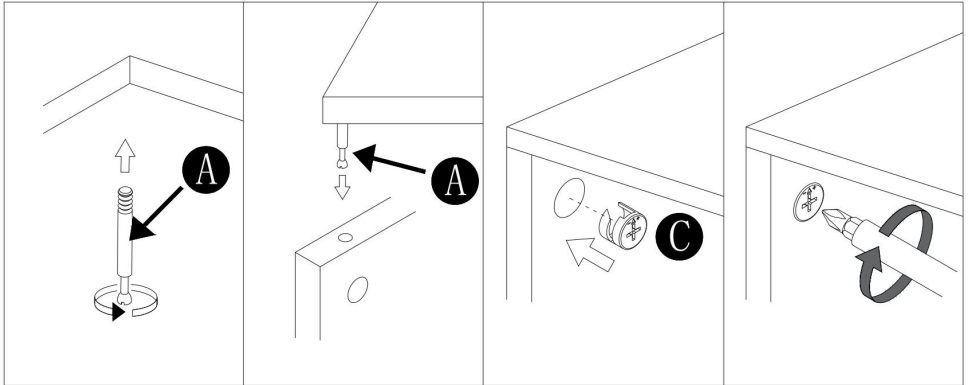

Read each step carefully before starting. It is very important that each step of instruction is performed in the correct order. If these steps are not followed in sequence, assembly difficulties will occur.

STEP1

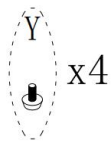
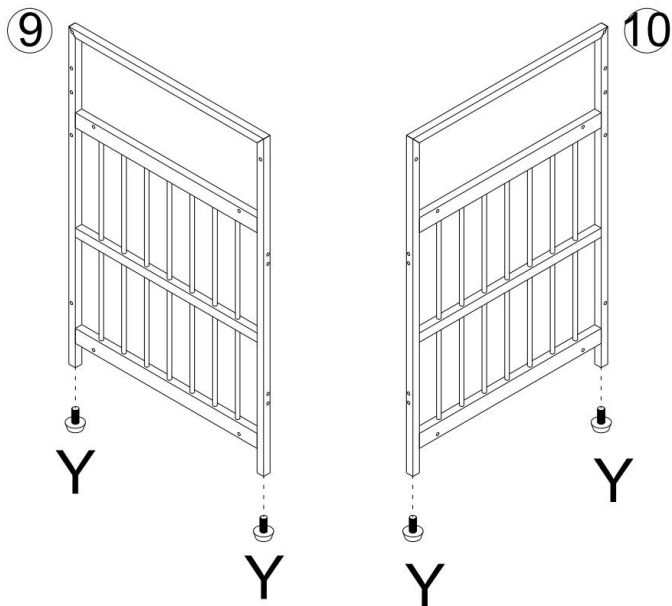

STEP2

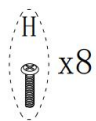
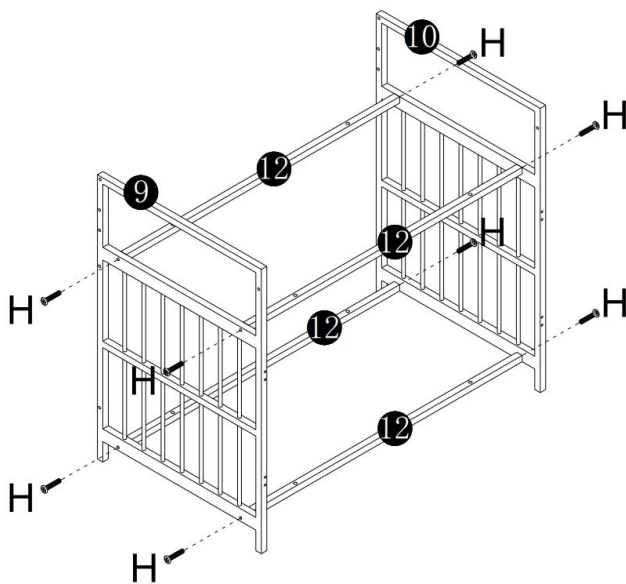

STEP3

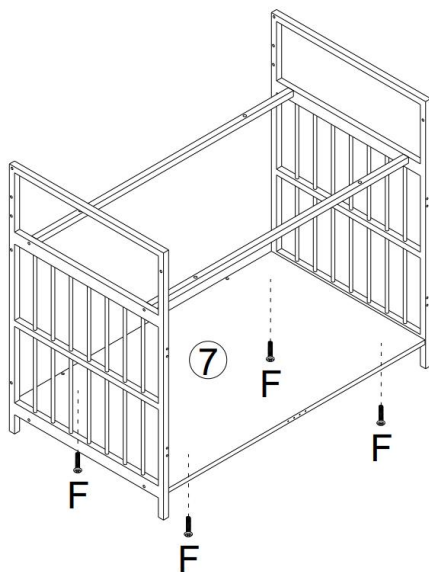
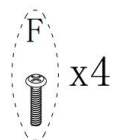

STEP4

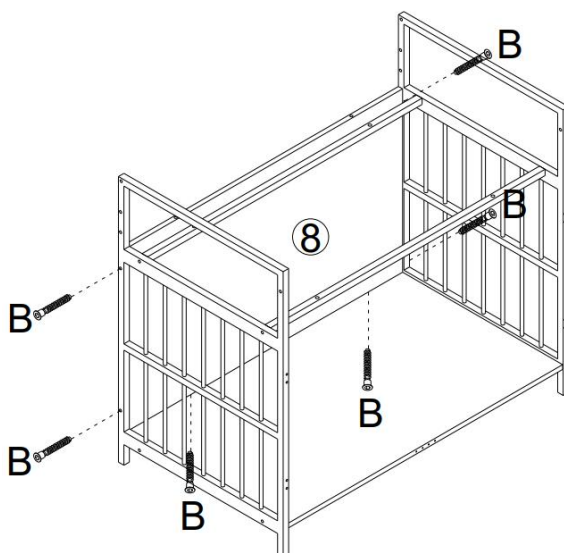
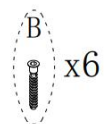

STEP5

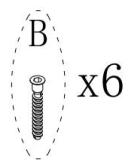
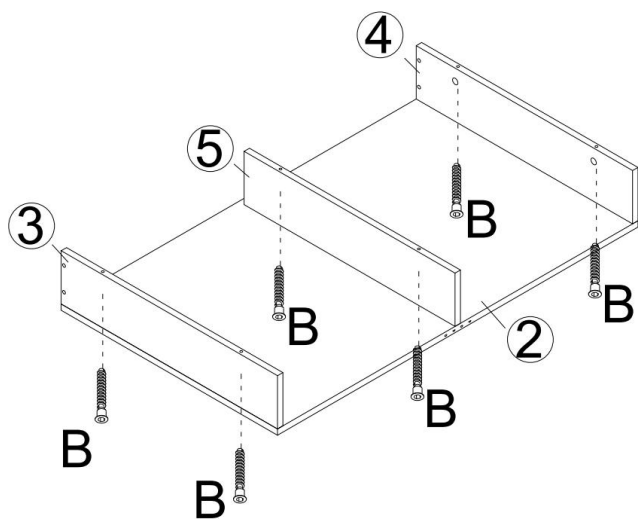

STEP6

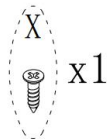
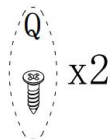
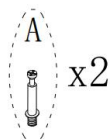
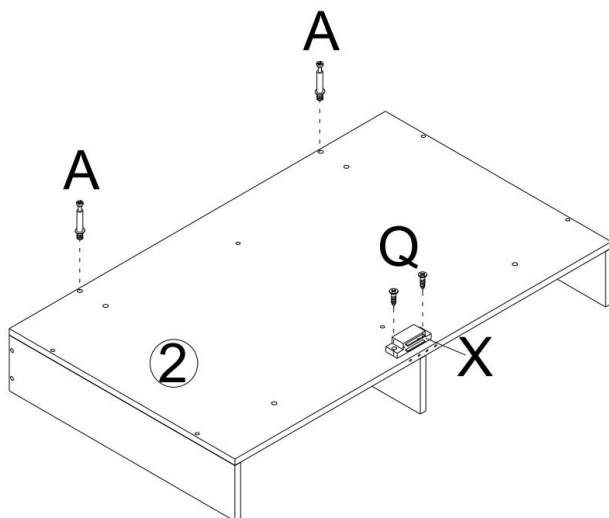

STEP7

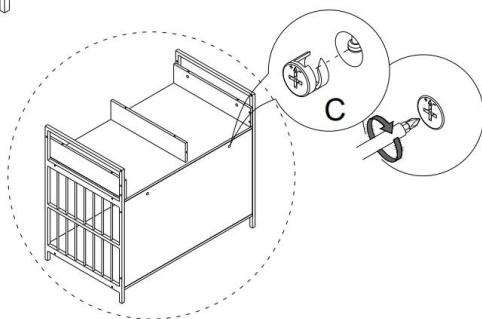
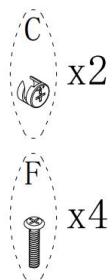
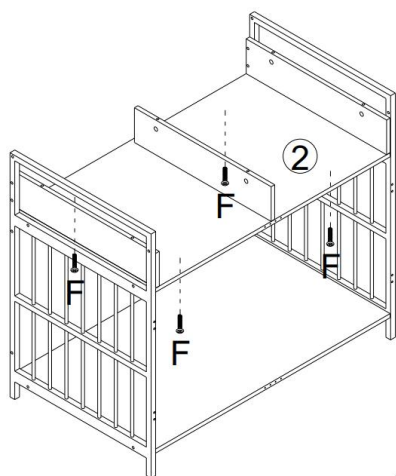

STEP8

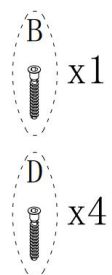
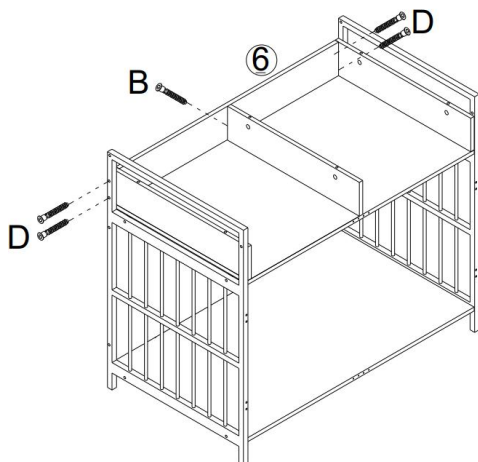

STEP9

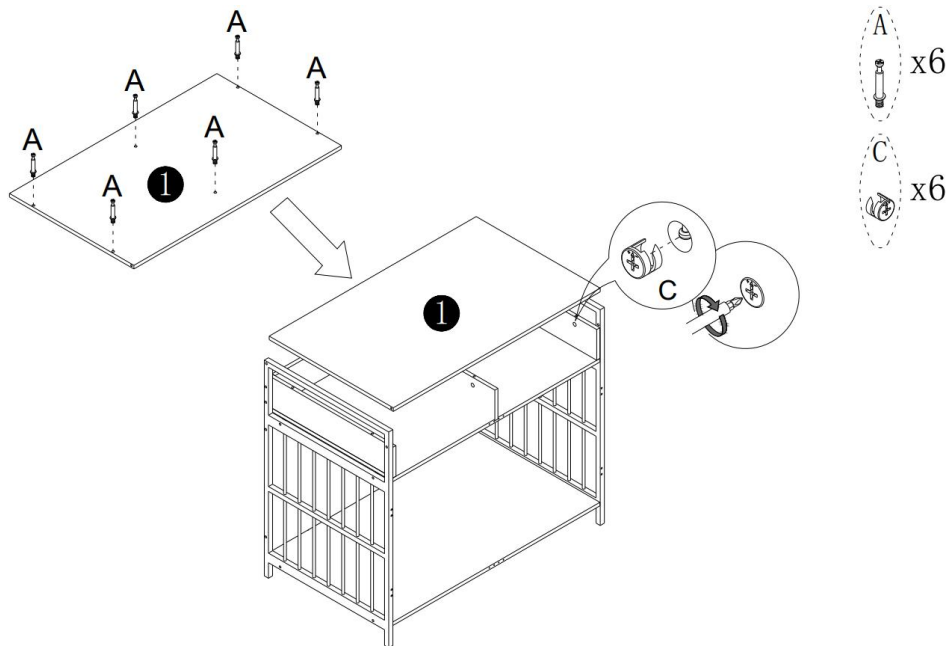

STEP10

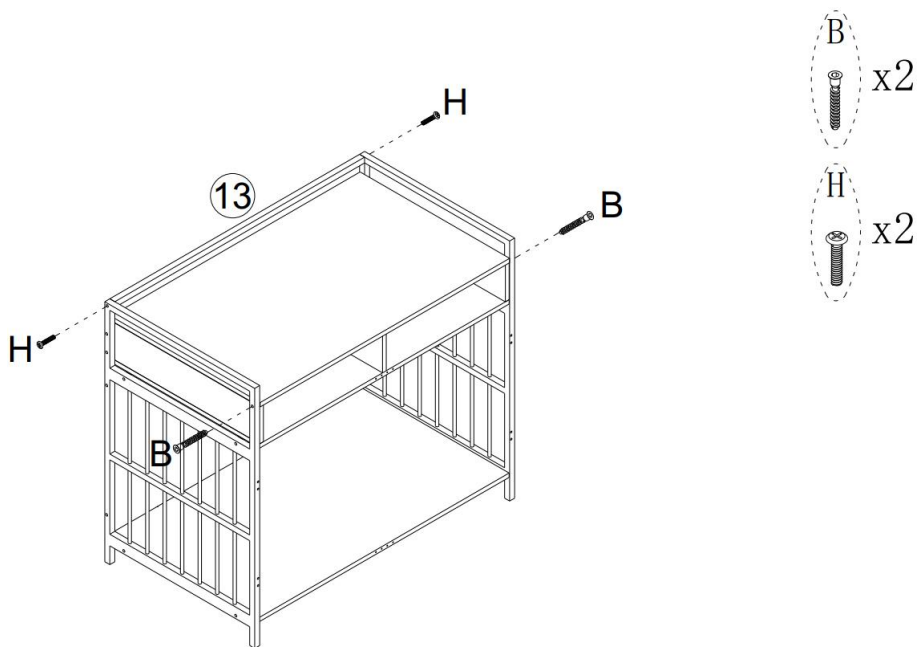

STEP11

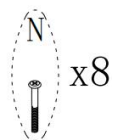
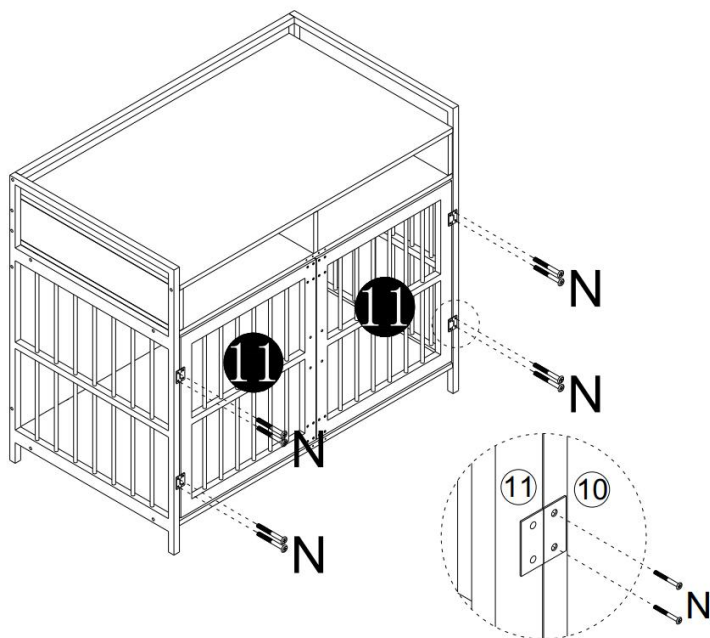

STEP12

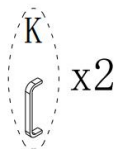
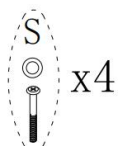
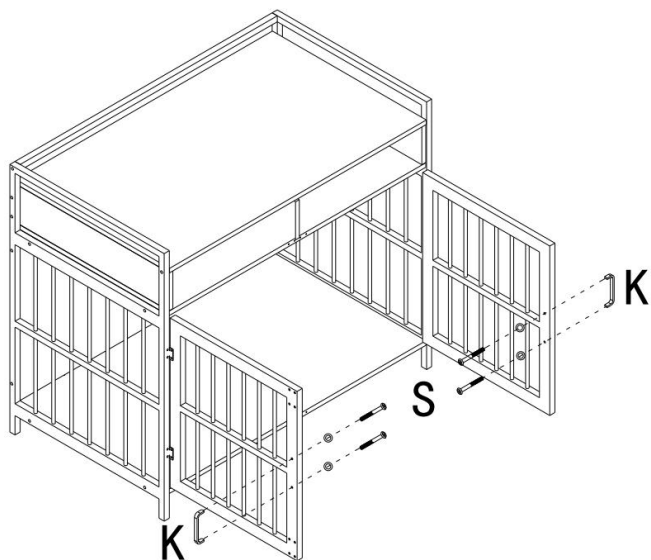

STEP13

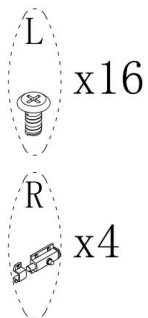
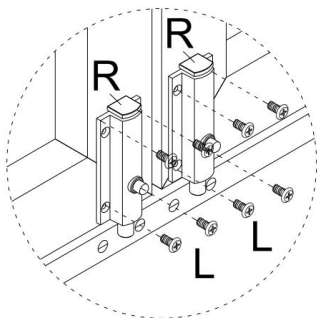
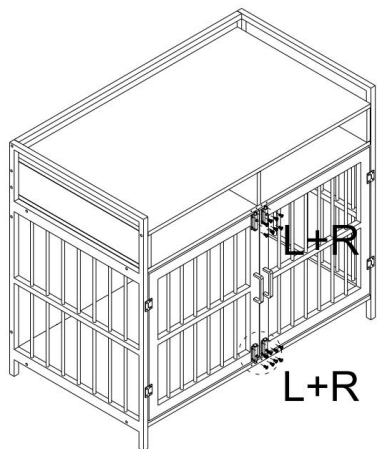

STEP14

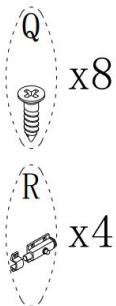
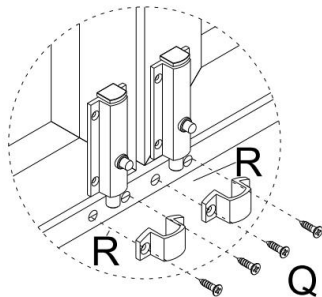
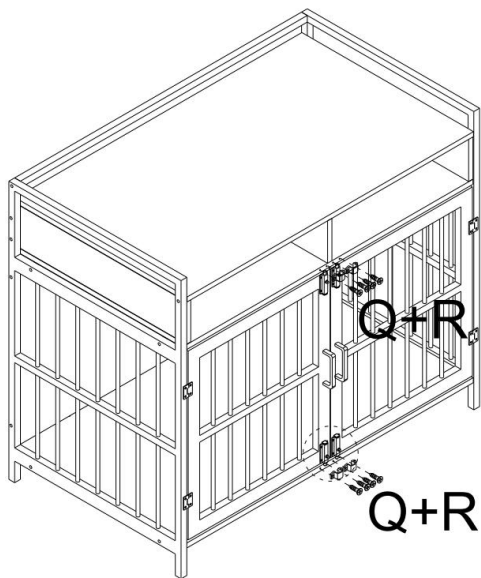

Note: Lock this accessory , the latch is a little stuck, please turn this accessory to install.

Manufacturer: Shanghaimuxinmuyeyouxiangongsi
Address: Shuangchenglu 803nong11hao1602A-1609shi, baoshanqu, shanghai
200000 CN.
EC REP: E-CrossStu GmbH.
Mainzer Landstr.69, 60329 Frankfurt am Main.
UK REP: YH CONSULTING LIMITED.
C/O YH Consulting Limited Office 147, Centurion House, London Road, Staines-
upon-Thames, Surrey, TW18 4AX
Imported to AUS: SIHAO PTY LTD.
1 ROKEVA STREETEASTWOOD NSW 2122 Australia
Imported to USA: Sanven Technology Ltd.
Suite 250, 9166 Anaheim Place, Rancho Cucamonga, CA 91730

VEVOR[®]

TOUGH TOOLS, HALF PRICE

Technical Support and E-Warranty Certificate

www.vevor.com/support