

# **VEVOR<sup>®</sup>**

## **TOUGH TOOLS, HALF PRICE**

Technical Support and E-Warranty Certificate [www.vevor.com/support](http://www.vevor.com/support)

### **ELECTRIC FENCE NETTING USER MANUAL**

We continue to be committed to provide you tools with competitive price.

"Save Half", "Half Price" or any other similar expressions used by us only represents an estimate of savings you might benefit from buying certain tools with us compared to the major top brands and does not necessarily mean to cover all categories of tools offered by us. You are kindly reminded to verify carefully when you are placing an order with us if you are actually saving half in comparison with the top major brands.





# VEVOR<sup>®</sup>

TOUGH TOOLS, HALF PRICE

## ELECTRIC FENCE NETTING

Model: S0900915D 90cm-15cm,S1080815D 108cm-15cm ,S1261015D  
126cm-15cm,SP1201407D51 120cm-7.5cm,SP1201407D35  
120cm-7.5cm,LFR050-1,LFR040-1,LFRO50-2,LFR040-2

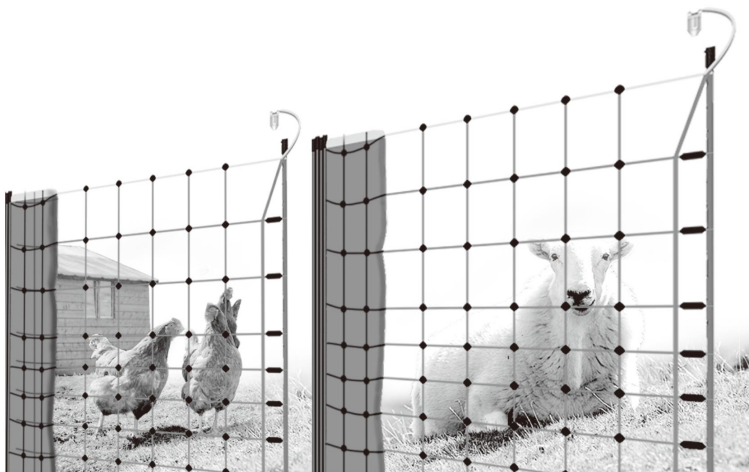

### NEED HELP? CONTACT US!

Have product questions? Need technical support? Please feel free to contact us:

**Technical Support and E-Warranty Certificate**  
**[www.vevor.com/support](http://www.vevor.com/support)**

This is the original instruction, please read all manual instructions carefully before operating. VEVOR reserves a clear interpretation of our user manual. The appearance of the product shall be subject to the product you received. Please forgive us that we won't inform you again if there are any technology or software updates on our product.

## SPECIFICATIONS

Model	SIZE	PARTS LIST
S0900915D 90cm-15cm	35in*164ft	<ol style="list-style-type: none"> <li>1. Electric Netting(1pc)</li> <li>2. Net Repair Kit (1set)</li> <li>3. Wire Hanging Kit (2sets)</li> <li>4. Warning Sign (1pc)</li> </ol>
S1080815D 108cm-15cm	42in*164ft	
S1261015D 126cm-15cm	50in*164ft	
SP1201407D51 120cm-7.5cm	48in*168ft	
SP1201407D35 120cm-7.5cm	48in*100ft	
LFR050-1	48in*168ft	<ol style="list-style-type: none"> <li>1. Electric Netting(1pc)</li> <li>2. Net Repair Kit (1set)</li> <li>3. Wire Hanging Kit (2sets)</li> <li>4. Warning Sign (1pc)</li> <li>5. Solar Energizer (1pc)</li> <li>6. Alligator clips (1set)</li> <li>7. 12KV Lead-acid battery</li> <li>8. 12KV Fence Tester (1pc)</li> <li>9. Earth Rod (1pc)</li> </ol>
LFR040-1	48in*100ft	
LFR050-2	48in*168ft	
LFR040-2	48in*100ft	

# PRODUCT PARTS LIST

## PRODUCT PARTS PICTURES

### Fences and related accessories



Electric Netting (1pc)



Net Repair Kit (1set)



Wire Hanging Kit (2sets)



Warning Sign (1pc)

### Solar Energizer and related accessories



Solar Energizer (1pc)



Alligator clips (1set)



12KV Lead-acid battery



12KV Fence Tester (1pc)



Earth Rod (1pc)

**NOTE:** Some models do not include solar energizer and related accessories, and users need to purchase and install them separately.

# INSTRUCTION MANUAL FOR ELECTRIC NETTING

## 1. SITE PREPARATION



Carry roll(s) of net to proposed fence line. Prepare line by either spraying with Glyphosate or mowing all vegetation over 4 inches tall. This creates a clean path for the fence.

## 2. UNTYING THE ROLL OF NETTING



Untie the 2 tie strings and pull apart the 2 metal clips to release the roll of net.

## 3. UNROLLING THE NET



Grip all the posts as a group and lift them up in front of you. This allows the netting to unroll in front of you in a series of folded "pleats," each attached to the posts in your hands. Lay unrolled pleats on the ground. Locate the beginning post. (It's the post with 2 tie strings attached and a steel connector at the top).

## 4. INSERTING THE FIRST POST



Insert the beginning post into the soil beside a stronger support post or an existing fence. The plastic posts are great for the in-line posts but will bend under tension. Use the 2 tie strings to secure the first post to the support post or fence. Keep the net end post(s) at least 2" away from anything that is conductive (metal, wood, concrete).

## 5. UNFOLDING THE NET



Grip all remaining posts as a group and lift them up in front of you. Then walk backwards along the intended fence line, dropping each post as it's pulled from your hands, thereby unfolding the netting. To reduce the risk of tangling the netting, try to drop or toss each post in sequence, helping to free it from the other posts you are still holding. Unfold entire roll of netting along the fence line.

## 6. INSTALLING LINE POSTS



Starting at the first post, walk along fence line, picking up each post in turn and pushing it into the ground. Apply only enough sideways tension to each post to keep the netting erect and straight. A trick is to use your boot to pull against the stake until you feel quite a bit of tension and the bottom wire is pulled taught. Stretch netting is just tight enough to stand up well. If there are changes in terrain then this must be catered for whilst tensioning the fence by using pegs to pull the bottom strand into the hollows.

## 7. JOINING 2 ROLLS OF STANDARD NET



Start the second roll by placing its first end post next to the last end post of the first net. Use the 2 tie strings to tie them

## 8. WIRE HANGING SYSTEM

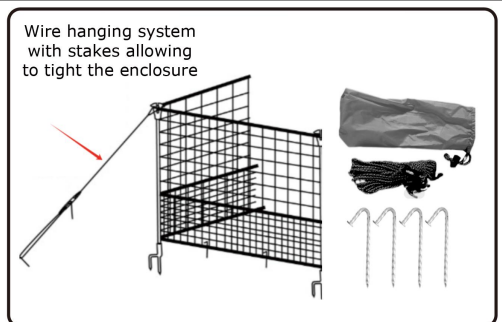

A wire hanging system with stakes allows for tightening the enclosure.

together.

### 9. JOINING 2 ROLLS ELECTRICALLY



To join one roll of standard netting to the next to provide an electrical connection, simply slide the built-in, stainless-steel male/female "power" connectors together by hand at one end. Do not use pliers to force them. The 2 pieces of metal only need to make and maintain contact.

### 10. CONNECT ENERGIZER TO STANDARD NET

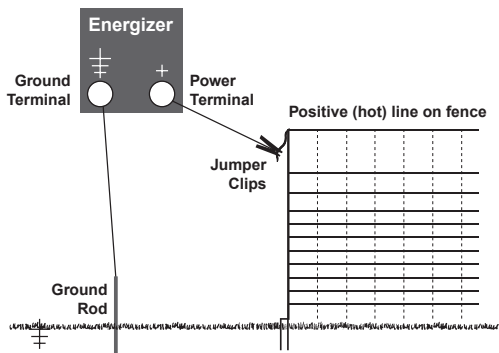

To electrify, install a ground rod and use jumper clips to connect the net to an energizer or to an existing electric fence. For either a battery (DC) or plug-in (AC mains) energizer, attach the lead wire from the fence terminal on energizer top clip at one end of the net.

### 11. CHECKING VOLTAGE

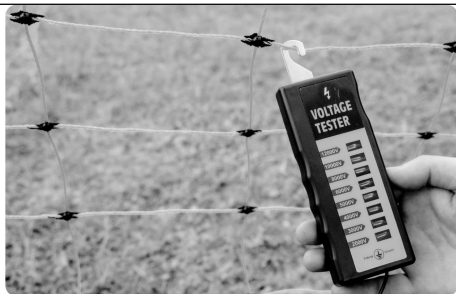

Never put animals into an electric fence enclosure without first checking for adequate voltage with an electric fence tester. Touch the fence tester to the clip at the end of the fence. Testers with ground probes will need their probe inserted into the ground, prior to contacting the fence. Voltage on a newly installed fence should exceed 3,000v. As time passes, grass will grow and touch the fence, causing the voltage to drop. Never allow it to drop below 2,000v.



## 12.FINISH INSTALLATION

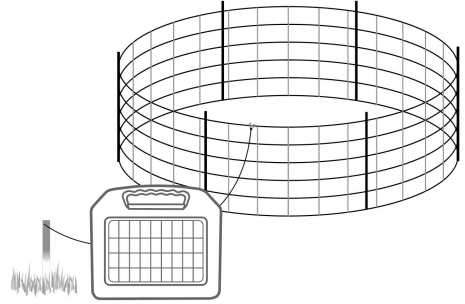
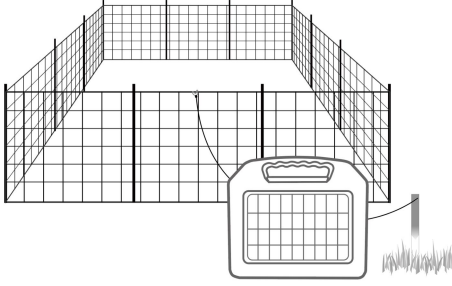

**NOTE:**Select the appropriate mode according to your needs(Including but not limited to the above two shapes).

**NOTE:**USE WITH ANY LOW IMPEDANCE, .25 JOULE, 10 MILE, 10 ACRE ENERGIZER PER 120 FT. OF NETTING

**WHEN CONNECTING 2 OR MORE NETS PLEASE REFER TO CHART:**

<b>NO.OF NETS FEET RECOMMENDED ENERGIZER</b>		
<b>1</b>	120 ft.	10 Mile, 10 Acre
<b>2</b>	240 ft.	20 Mile, 20 Acre
<b>3</b>	360 ft.	30 Mile, 30 Acre
<b>4</b>	480 ft.	40 Mile, 40 Acre

## HOW TO DISMANTLE ELECTRIC NETTING



**IMPORTANT:**

**TURN OFF THE ENERGIZER BEFORE DISMANTLING ELECTRIC NETTING**



1. Untie the end posts and pull up remaining posts, laying each section of netting flat on the ground.



3. Finally re-tie the bundle with the green strings.

2. After the length of netting is folded up, pick up the posts as a group and shake the net a bit. This allows the folded pleats to straighten themselves. Then lay netting on the ground and roll up the folds. Start at the end without posts and roll toward the posts. This will produce a roll much like it began all the posts on outside and the folds of net rolled up inside.

#### NORMAL RAINFALL AREAS (ALL LINES ELECTRIFIED)

To electrify all horizontal lines, connect jumper clip from power terminal of the energizer to the built-in stainless steel power connectors. Connect ground stake to ground terminal on energizer using the other jumper clip provided.

#### NORMAL RAINFALL AREAS (ALL LINES ELECTRIFIED)

To join a second roll, repeat steps 1-3 (tie the first post of the additional net to the last post of the already installed net). Insert the post with the strings next to the last post of the first fence and tie it together. Connect the stainless steel clips together. This is the only electrical connection from fence to fence and automatically electrifies all lines in the net. Any post along the line can be a corner post for directional changes. If erecting the net in a rectangular shape, it may be necessary to add extra support posts for additional support. When using a standard net (all wires energized), any excess can be folded back against itself. When using a positive/ negative net, any excess should be erected but not doubled along itself. If you are connecting the net to an existing, energized fence, be careful not to allow the connection clips or any part of the net to contact the existing fence until - 5 - your set up is complete. If using the nets as a stand-alone system, position the first post where you want to enter the enclosure.

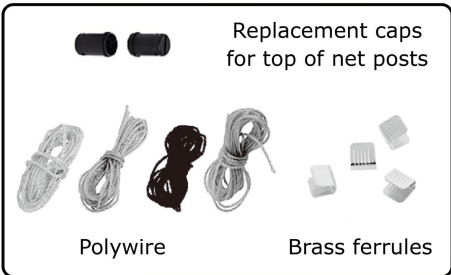
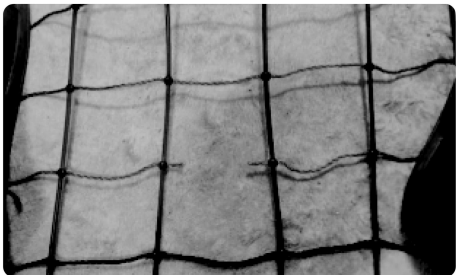
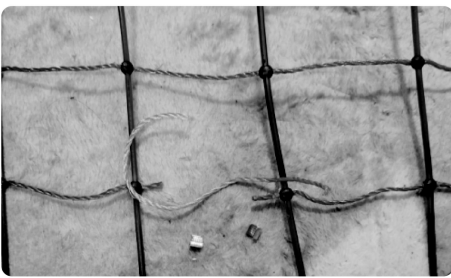
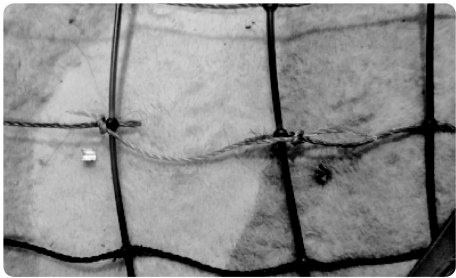
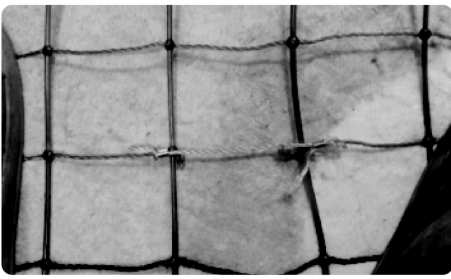
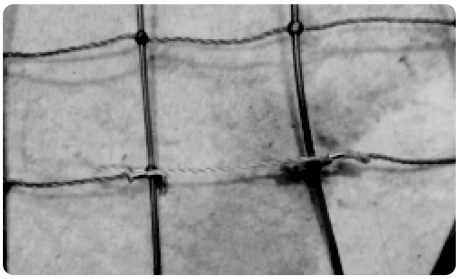

## REPAIRING DAMAGED NET

 <p>Replacement caps for top of net posts</p> <p>Polywire</p> <p>Brass ferrules</p>	
<p>Net Repair Kit (included with each net)</p>	<p>1. Use scissors to cut out the damaged portion of the horizontal wire</p>
	
<p>2. Measure out an appropriate amount of the replacement conductive or non conductive material.</p>	<p>3. Tie the replacement material to one side of the break with a square knot. (If possible, twist together the metal filaments of the original material and the splicing material before tying the knot.)</p>
	
<p>4. Repeat step #4 on the other side of the break. Place a brass ferrule over each of the square knots and clamp together with pliers.</p>	<p>5. Place a brass ferrule over each of the square knots and clamp together with pliers.</p>

The function for plastic pins:When The ground is uneven or sunken and you can use the plastic pins to fix the bottom wire to ground. (Net Repair Kit including 10 pcs plastic pins)



## TROUBLESHOOTING

First, use a voltage tester to test the voltage output on the net. To determine where the problem lies, disconnect the insulated energizer power lead from the fence and hold it away from the ground rod and turn on the energizer. If the energizer is functioning, a spark will appear or it will register high on the tester. If the battery is functioning properly, the pulse rate of the energizer will be between 50 and 60 pulses per minute. DO NOT let the battery go dead. If the fence is not working or not electrifying properly, check each of the following until the problem is corrected.

### ENERGIZER

- Check voltage on energizer with net disconnected
- Make sure the fence is connected properly
- Make sure the battery is fully charged
- Check for proper grounding
- Check for faults
- Be sure the charger is capable of electrifying the number of nets connected to it. (minimum of .25 joule per net; e.g. - 4 nets connected together need a 1 joule energizer)

### FENCE

- Check for joined connectors to transfer current from fence to fence
- Check metal spike on step-in posts to ensure there is no contact with electric wire strands
- Clear or remove excessive vegetation on fence

## **RULES OF ELECTRIC NETTING**

1. Electrify your fence! Electric fence is a pain barrier, not a physical barrier. If you do not keep the fence energized at all times, your animals will lose fear of it. Then they will go over, under or through it-risking entanglement (and possibly death). Retraining is difficult.
2. Ensure the voltage is at least 3000V at the end of the fence line. (150 ft of netting typically requires at least 0.25 joules of output.) Energized fences last longer and require less maintenance-because animals do not crowd, rub or scratch on them.
3. Introduce animals new to electric fence by first installing the properly electrified temporary net inside a permanent corral. The permanent barrier will prevent them from jumping forward when they check it with their sensitive noses and receive a memorable electric shock. The pain encourages the animals to avoid future contact.

### **WARNING:**

Ignoring the rules may result in escaped or entangled animals. On a % basis, entanglement is very rare. But it does occur and may result in death. Properly installing, electrifying and training animals reduces this risk. Remember! If animals are scared or starved it will not keep them in.

**Manufacturer:** Shanghaimuxinmuyeyouxiangongsi

**Address:** Shuangchenglu 803nong11hao1602A-1609shi, baoshanqu  
, shanghai 200000 CN.

**Imported to AUS:** SIHAO PTY LTD. 1 ROKEVA STREETEASTWOOD  
NSW 2122 Australia

**Imported to USA:** Sanven Technology Ltd. Suite 250, 9166 Anaheim  
Place, Rancho Cucamonga, CA 91730



E-CrossStu GmbH.  
Mainzer Landstr.69, 60329 Frankfurt am Main.



YH CONSULTING LIMITED.  
C/O YH Consulting Limited Office 147, Centurion House,  
London Road, Staines-upon-Thames, Surrey, TW18 4AX

**Made In China**



**VEVOR**<sup>®</sup>

**TOUGH TOOLS, HALF PRICE**

**Technical Support and E-Warranty Certificate**

**[www.vevor.com/support](http://www.vevor.com/support)**

# **ELECTRIC FENCE ENERGIZER USER MANUAL**

## **WARNING: READ ALL INSTRUCTIONS**

If you suspect that the unit is not working, follow these steps:

1. Disconnect the unit from the fence and check that the indicator light is flashing.
2. Check the battery connection and voltage.
3. Check that the voltage between the live and ground terminals is greater than 7000 V, using a fence voltage tester.
4. If these tests are OK, you have an installation problem.

**Consult your user manual for installation  
and operating instructions**

# **CONTENTS**

Product Details	01
Key to symbols on the unit	03
Description	05
Installation	05
Battery information	07
Positioning the unit	10
Safety considerations	11
Troubleshooting	17
Servicing	19
Warranty	19



## Product Details

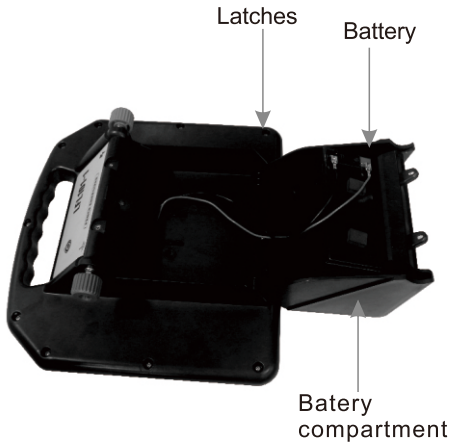
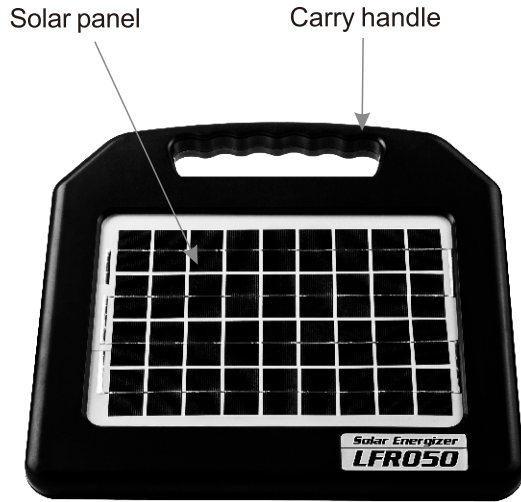

## Product Details

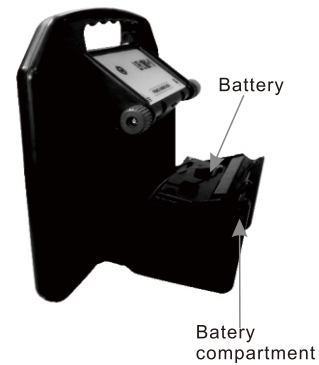
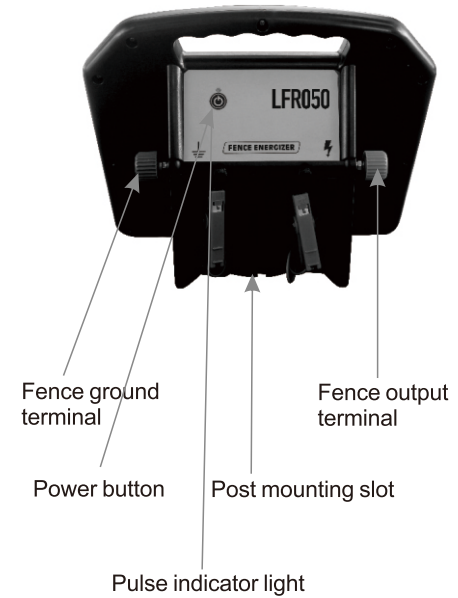

## Key to symbols on the unit

 Fence ground terminal (green). Connect the fence ground terminal to the ground system.

 Fence output terminal (red). Connect the fence output terminal to the fence.



Risk of electric shock! This unit should be opened or repaired only by qualified personnel. No user serviceable parts.



Read full instructions before use.



This symbol on the product or its packaging indicates that this product must not be disposed of with other waste. Instead, it is your responsibility to dispose of your waste equipment by handing it over to a designated collection point for the recycling of waste electrical and electronic equipment. The separate collection and recycling of your waste equipment at the time of disposal will help conserve natural resources and ensure that it is recycled in a manner that protects human health and the environment. For more information about where you can drop off your waste equipment for recycling, please contact your local city recycling office or the dealer from whom you purchased the product.

## Before first use

Units may be supplied with or without a battery, depending on your region. If a battery has been supplied, it will be inside the battery compartment with the positive terminal disconnected.

Before using the unit for the first time, you must:

- 1 Insert a battery into the battery compartment (if necessary).
- 2 Connect the battery terminals.
- 3 Charge the battery by placing the unit in full sunlight for three days with the solar panel facing true south in the northern hemisphere and true north in the southern hemisphere.

## LFR050-Battery

1. Place the unit on a flat surface (handle downwards as shown). Open the battery compartment by unscrewing the screws on the back.



2. Insert a battery (if necessary).
3. Connect the positive (red) lead to the positive (+) terminal on the battery. Connect the negative (black) lead to the negative (-) terminal on the battery (if necessary).
4. Close the battery compartment, ensuring that the latches are securely fastened.

**Caution!** When connecting the battery, be careful not to short circuit the supply terminals.

## Description

---

Power output at 500 ohms: 0.5J  
Delivered power vacuum: 0.63J  
Effective square meter: 50 Acres  
Effective length: 20 Miles  
Solar Consumption: 47 mA  
Voltage Vacuum: 10KV Max  
Waterproof Rating: IP65 Outdoor Use  
Power Source Battery: DC 12V/8AH(including)  
Operates Days without Sunlight: UP 2 weeks  
Polysilicon Solar Panel Voltage Output(Vmp): DC 18V  
Polysilicon Solar Panel Current Output(Imp): 0.28A  
Polysilicon Solar Panel Power Output(Pmax): 5W  
Solar Panel Size: 303\*213mm  
Plastic case Dimensions: 37.5\*22\*30cm  
G.W.: 3KGS  
Product including one AC/DC adapter,two alligator clips

## Installation

### Positioning the unit

---

Install the unit:

- adjacent to the electric fence
- preferably in the middle of the electric fence
- where it will receive the most daily sun throughout the season
- where a good ground can be obtained
- away from flooding and out of reach of animals and children (inside a protective fence, if required)
- with the solar panel facing true south in the northern hemisphere and true north in the southern hemisphere.

### Mounting the unit

---

The unit may be placed directly onto a flat surface or mounted directly onto a steel Y-post or T-post using the post-mounting slot.

## Connecting to an electric fence

## Pulse indicator light

---

The pulse indicator light indicates the output pulse speed. The pulse speed varies according to the battery charge level:

Battery charge level	Typical pulse speed
Normal	A pulse every 1.5 seconds
Low	A pulse every 3 seconds

## Standby mode

---

An intelligent battery management feature puts the unit into Standby mode when battery charge falls below a 'safe operating level'. When in Standby mode, the unit is still on, but it will not deliver a pulse to the electric fence.

The unit will resume delivering pulses when the solar panel has charged the battery so that it is above 'safe operating level'.

When operation resumes, the battery charge level will still be low, so the unit will deliver one pulse every 3 seconds. Once the battery reaches normal charge level, the pulse will revert to one pulse every 1.5 seconds.

# Battery information

## Battery charging

---

The solar panel can fully charge a flat battery in two weeks, provided the unit is switched off and there is adequate sunlight. A battery charger may also be used to charge the battery. Use a battery charger suitable for charging sealed, lead-acid batteries.

## Battery charger details

---

Warning! The battery must be disconnected and removed from the unit before connecting it to a battery charger.

Model	Battery type being charged	Battery charger requirements
LFR050	12 V	13.8 V, $\leq 1$ A

When fully charged, the battery should be able to power the unit for up to three weeks. To fit into the battery box, battery Dimensions should be within 15\*6.5\*9.5 cm / L\*W\*H

## Replacing the battery

---

If a replacement battery is required, use a sealed lead-acid battery.

Warning! Do not use a non-rechargeable battery.

### Replacement battery details

Model	Suitable battery type
-------	-----------------------

LFR050 12 V, 8 Ah battery

Do not dispose of the battery in a land-fill or in a fire.

In the event of a spill or leakage from a sealed lead-acid battery:

- Contain small spills with dry sand, soil and vermiculite. Do not use combustible materials. If possible, carefully neutralize spilled electrolyte with soda ash, sodium bicarbonate, lime, etc.
- Wear acid-resistant clothing, boots, gloves and a face shield.
- Do not let un-neutralised acid get into the sewerage system.

Neutralized acid must be managed in accordance with approved local, state and federal requirements. Consult your state environmental agency and/or federal EPA.

## Maintenance

Clean the solar panel regularly with a soft cloth using glass cleaner or a mild solution of detergent and water. This will ensure the solar panel functions efficiently.

When transporting the unit, protect the solar panel to prevent the glass surface from being damaged.

## Storage

If the unit is stored for extended periods, the battery can discharge and become damaged.

The unit should be stored inside, next to a window, where sunlight can shine on the unit each day.

If the unit cannot be stored in a sunny position, it should be kept in a cool place. The battery should be fully charged and disconnected from the unit. The battery should be recharged manually every six months using a suitable battery charger.

## Positioning the unit

A temporary fence can be quickly erected and easily moved allowing the farmer to:

- Make smaller paddocks (fields)
- Keep herds of animals separated
- Ration feed

*Note:* Use more wires for smaller animals and wild animals. Polytape should be used when greater visibility is required (e.g. horses).

An example of a temporary fence is shown below.

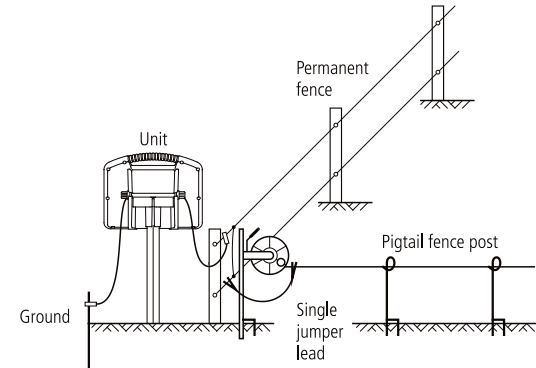

## Safety considerations

### *Warning!*

- Do not connect to mains-operated or line-operated equipment.
- Remove the battery from the unit before using an external battery charger to recharge the battery.
- Switch the unit off before installation or performing any work on the fence.
- Read all the safety considerations carefully.
- Check your installation to ensure that it complies with all local safety regulations.
- Do not connect simultaneously to a fence and to any other device such as a cattle trainer or a poultry trainer. Otherwise, lightning striking your fence will be conducted to all other devices.

### *Notes:*

- This product has been designed for use with electric animal fences.
- Keep these instructions in a handy location.

## Safe electric fence construction

### *Warning!* Read before use.

An electric fence can be hazardous when there is a risk of entrapment or entanglement, or other hazards exist. Serious injury or death may result. Take all steps to avoid the risk of entrapment or entanglement.

The adapter and battery cannot be used at the same time, When using battery, adapter cannot be inserted; When using adapter, Need to unplug the battery

## Danger

- Do not climb through or under an electric fence. If it is necessary to cross an electric fence use a gate or specially designed crossing point.
- Do not allow young or infirm persons to use this unit without supervision. Do not allow young children to play with this unit or near an electric fence or electrified wires.
- Do not electrify barbed wire.
- Do not support off-set electrified wires less than 6" (150 mm) from the vertical plane of a barbed wire fence.
- Do not electrify any fence construction which could lead to entanglement of persons or animals. We recommend for instance, that no more than one electrified off-set wire be supported on either side of a barbed wire or mesh fence.
- Do not supply an electric fence from two units.
- Do not allow electrified wires from two units on the same or adjacent properties to be less than 8' (2.5 m) apart.
- Do not place the unit's ground rod within 33' (10 m) of any part of a power supply ground system or telecommunications ground system.
- Do not run electric fence wires above or close to overhead power or communication lines.

### Cautions :

1. Feature: 2 dew holes at the bottom of the plastic box prevent water from accumulating.
2. When not use, the battery clip should be removed to prevent power consumption.
3. When use AC power, disconnect the battery clips to prevent battery from burning out.
4. When wire clips connect battery, the side with the spring faces up enable remove easily.

## Duty to the public

---

A warning sign shall be fitted to every point where persons may gain ready access to the conductors.

Where an electric animal fence crosses a public pathway, a non-electrified gate shall be incorporated in the electric animal fence at that point or a crossing by means of stiles shall be provided. At any such crossing, the adjacent electrified wires shall carry warning signs.

Any part of an electric animal fence that is installed along a public road or pathway shall be identified at frequent intervals by warning signs securely fastened to the fence posts or firmly clamped to the fence wires.

- The size of the warning sign shall be at least 4x8" (100x200 mm).
- The background colour of both sides of the warning sign shall be yellow. The inscription on the sign shall be black and shall be either:

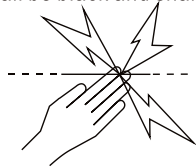

or the substance of "CAUTION: Electric fence".

- The inscription shall be indelible, inscribed on both sides of the warning sign and have a height of at least 1" (25 mm).

## Definition of special terms

---

Unit/Charger/Energizer – An appliance that is intended to periodically deliver voltage impulses to a fence connected to it.

Fence – A barrier for animals or for the purpose of security, comprising one or more conductors such as metal wires, rods or rails.

Electric fence – A barrier which includes one or more electric conductors, insulated from ground, to which electric pulses are applied by a unit.

Ground rod – Metal structure that is driven into the soil near a unit and connected electrically to the Fence ground terminal of the unit, and that is independent of other grounding arrangements.

Connecting lead – An electric conductor, used to connect the unit to the electric fence or the ground rod.

## Requirements for electric animal fences

---

Electric animal fences and their ancillary equipment shall be installed, operated and maintained in a manner that minimises danger to persons, animals or their surroundings.

Warning! Avoid contacting electric fence wires especially with the head, neck or torso. Do not climb over, through or under a multi-wire electric fence. Use a gate or a specially designed crossing point.

This unit is not intended for use by persons (including children) with reduced physical, sensory or mental capabilities, or lack of experience and knowledge, unless they have been given supervision or instruction concerning use of the unit by a person responsible for their safety.

Children should be supervised to ensure that they do not play with the unit. Electric animal fence constructions that are likely to lead to the entanglement of animals or persons shall be avoided.

An electric animal fence shall not be supplied from two separate units or from independent fence circuits of the same unit.

For any two separate electric animal fences, each supplied from a separate unit independently timed, the distance between the wires of the two electric animal fences shall be at least 8' (2.5 m). If this gap is to be closed, this shall be effected by means of electrically non-conductive material or an isolated metal barrier. Barbed wire or razor wire shall not be electrified by a unit.

A non-electrified fence incorporating barbed wire or razor wire may be used to support one or more off-set electrified wires of an electric animal fence.

supporting devices for the electrified wires shall be constructed so as to ensure that these wires are positioned at a minimum distance of 6" (150 mm) from the vertical plane of the non-electrified wires. The barbed wire and razor wire shall be grounded at regular intervals.

A distance of at least 33' (10 m) shall be maintained between the unit's ground rod and any other grounding system connected parts such as the grounding system for the power supply or the telecommunication system.

Connecting leads that are run inside buildings shall be effectively insulated from the grounded structural parts of the building. This may be achieved by using insulated high voltage cable.

Connecting leads that are run underground shall be run in conduit of insulating material or else insulated high voltage cable shall be used. Care must be taken to avoid damage to the connecting leads due to the effects of animal hooves or vehicle wheels sinking into the ground.

Connecting leads shall not be installed in the same conduit as the AC supply wiring, communication cables or data cables.

Connecting leads and electric animal fence wires shall not cross above overhead power or communication lines.

Crossings with overhead power lines shall be avoided wherever possible. If such a crossing cannot be avoided it shall be made underneath the power line and as nearly as possible at right angles to it.

If connecting leads and electric animal fence wires are installed near an overhead power line, the clearances shall not be less than those shown in the table below.

*Minimum clearances from power lines for electric animal fences*

<u>Power line voltage</u>	<u>Clearance</u>
≤1000 V	10' (3 m)
>1000 V to ≤33,000 V	13' (4 m)
>33,000 V	27' (8 m)

If connecting leads and electric animal fence wires are installed near an overhead power line, their height above the ground shall not exceed 10' (3 m). This height applies to either side of the orthogonal projection of the outermost conductors of the power line on the ground surface, for a distance of:

- 6'6" (2 m) for power lines operating at a nominal voltage not exceeding 1000 V.
- 50' (15 m) for power lines operating at a nominal voltage exceeding 1000 V.

Electric animal fences intended for deterring birds, household pet containment or training animals such as cows need only be supplied from low output units to obtain satisfactory and safe performance.

In electric animal fences intended for deterring birds from roosting on buildings, no electric fence wire shall be connected to the unit's ground rod.

Ensure that all line-operated, ancillary equipment connected to the electric animal fence circuit provides a degree of isolation between the fence circuit and the supply mains equivalent to that provided by the unit.

Protection from the weather shall be provided for the ancillary equipment unless this equipment is certified by the manufacturer as being suitable for use outdoors, and is of a type with a minimum degree of protection IP66.



# Troubleshooting

Problem	Action
The pulse indicator light is flashing, but the electric shock delivered by the fence is weak.	<p>Check that all connections in the fence and ground system are firm and secure. If necessary, clean away any corrosion. Check that the ground rod is pushed firmly into firm ground. Check for faults in the fence-line caused by trees or vegetation. If necessary, remove obstructions and mend the fence.</p> <p>Check that the unit (charger) rating is adequate for the length of the fence. If necessary, reduce the length of the fence or reduce the number of fence wires. Alternatively, divide the fence-line into smaller zones, with each zone powered by a separate unit.</p>
The pulse indicator light is no flashing.	<p>Check that the unit is switched on.</p> <p>If there has been insufficient sunlight to charge the battery, the unit may be in Standby mode. Charge the battery by placing the unit in full sunlight with the solar panel facing true south in the northern hemisphere and true north in the southern hemisphere.</p> <p>Ensure the battery is connected correctly with the positive (red) lead to the positive (+) terminal on the battery and the negative (black) lead to the negative (-) terminal on the battery.</p> <p>Try charging the battery manually using a suitable battery charger. See Battery charging on page 9.</p> <p>Replace the battery with a new battery. Before installing a new battery, charge it fully using a suitable battery charger. If the pulse indicator light is still not flashing, please contact us.</p>

The battery needs frequent replacement.

Check that the solar panel is clean and is not damaged. See Maintenance on page 9.

Make sure the unit is positioned to receive maximum sunlight. If necessary, remove any objects or vegetation that might be casting a shadow on the unit. See Positioning the unit on page 6, or for more detailed information on solar installations.

After the unit is switched on, the pulse indicator light gives three long flashes (2 seconds) then the unit appears to be off.

The unit is in Standby mode because there has been insufficient sunlight to charge the battery. Charge the battery by placing the unit in full sunlight with the solar panel facing true south in the northern hemisphere and true north in the southern hemisphere.

The pulse indicator light flashes quickly several times and then there is a pause.

There may be a problem with the unit. Return the unit to a service agent appointed by

# Servicing

Please contact your local store.

*Note: If you suspect the unit is not working, always check the battery connection and voltage before proceeding.*

# Warranty

This warranty does not cover defects caused by:

- Incorrect input voltage or polarity
- Damage to external wiring
- Physical mishandling
- Water immersion
- Vermin or insect damage

---

*Note:* This product has been manufactured to comply with international safety standards.

---

This product is warranted against faulty material and workmanship for a period of 2 years from date of purchase.

If a warranted defect occurs, return this product with proof of purchase to an authorised service centre.

Note:

- No responsibility is accepted for any accident or damage caused subsequent to any tampering with or modification to or misuse of this product, including (but not limited to) alterations made by anyone other than
- To the maximum extent permitted by law, this warranty is exclusive, personal to you and in lieu of all other warranties, representations or conditions relating to this product (whether express or implied and whenever arising) whether originating by statute, law, trade, custom or otherwise.
- The product warranty is only valid in the original country of purchase. Any claims made in another country may incur full repair costs at the owner's expense.

**VEVOR**®  
**TOUGH TOOLS, HALF PRICE**



**VEVOR**<sup>®</sup>  
TOUGH TOOLS, HALF PRICE

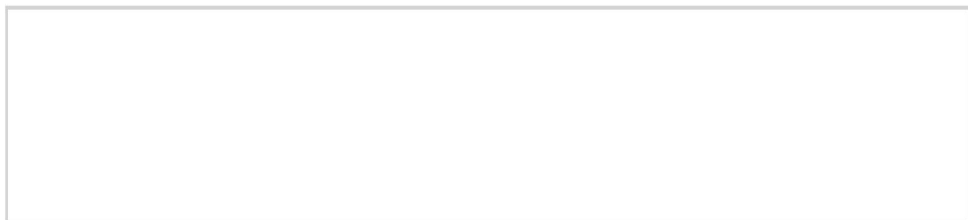



Electric Netting (1pc)



Net Repair Kit (1set)



Wire Hanging Kit (2sets)



Warning Sign (1pc)



Solar Energizer (1pc)



Alligator clips (1set)



12KV Lead-acid battery



12KV Fence Tester (1pc)



Earth Rod (1pc)





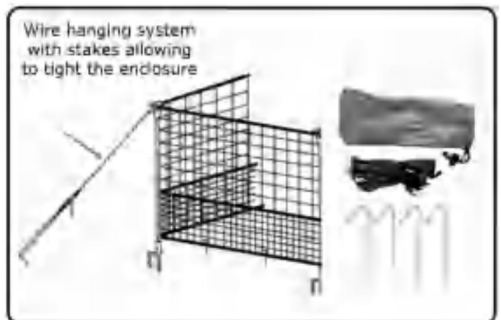

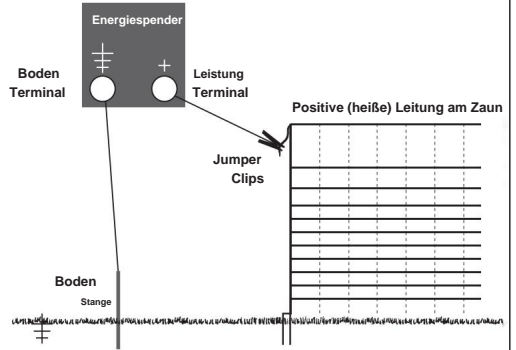

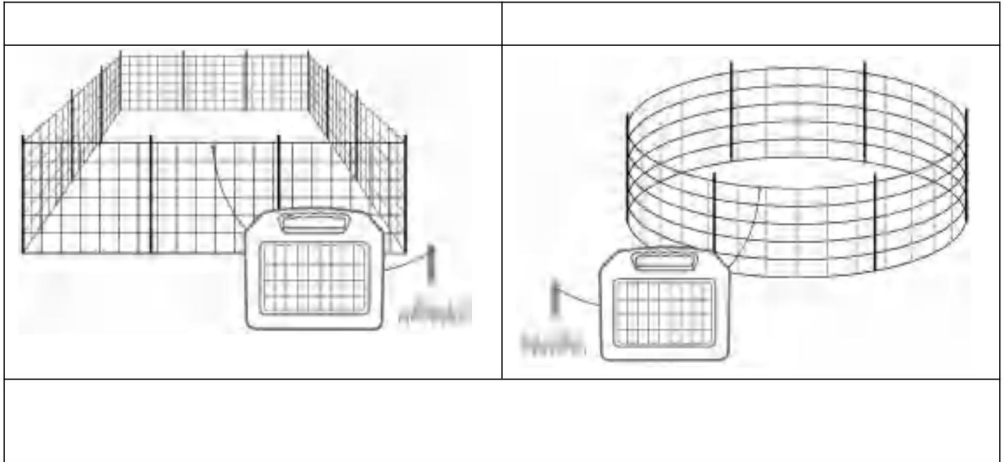

### ANZAHL DER NETZE FUSS EMPFOHLENES ENERGIZER

1	120 Fuß.	10 Meilen, 10 Acre
2	240 Fuß	20 Meilen, 20 Acre
3	360 Fuß.	30 Meilen, 30 Acre
4	480 Fuß.	40 Meilen, 40 Acre



VORSICHT





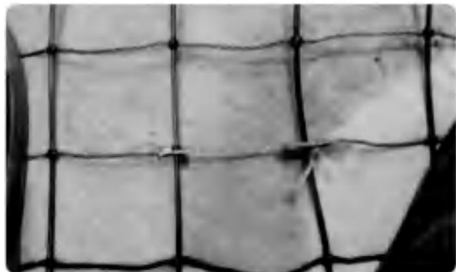
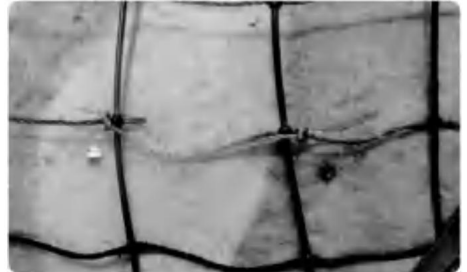
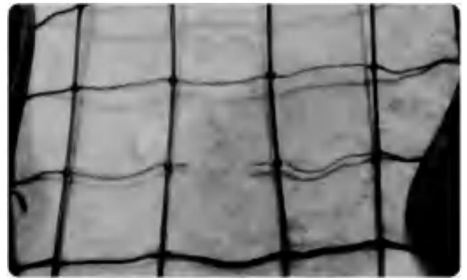
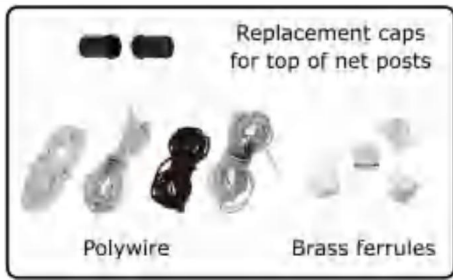





: Shuangchenglu 803nong11hao1602A-1609shi, baoshanqu  
, Shanghai, 200.000 CN.

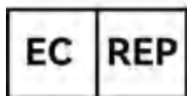

E-CrossStu GmbH.  
Mainzer Landstr.69, 60329 Frankfurt am Main.

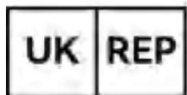

YH CONSULTING LIMITED.  
C/O YH Consulting Limited Office 147, Centurion House,  
London Road, Staines-upon-Thames, Surrey, TW18 4AX





**VEVOR**<sup>®</sup>  
TOUGH TOOLS, HALF PRICE

# **ELECTRIC FENCE ENERGIZER USER MANUAL**

## **WARNING: READ ALL INSTRUCTIONS**

If you suspect that the unit is not working, follow these steps:

1. Disconnect the unit from the fence and check that the indicator light is flashing.
2. Check the battery connection and voltage.
3. Check that the voltage between the live and ground terminals is greater than 7000 V, using a fence voltage tester.
4. If these tests are OK, you have an installation problem.

**Consult your user manual for installation  
and operating instructions**

# **CONTENTS**

Product Details	01
Key to symbols on the unit	03
Description	05
Installation	05
Battery information	07
Positioning the unit	10
Safety considerations	11
Troubleshooting	17
Servicing	19
Warranty	19

# Product Details

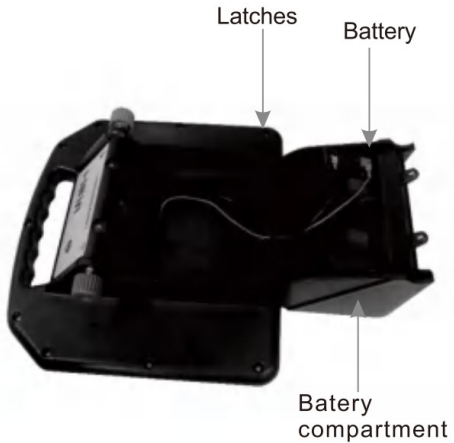
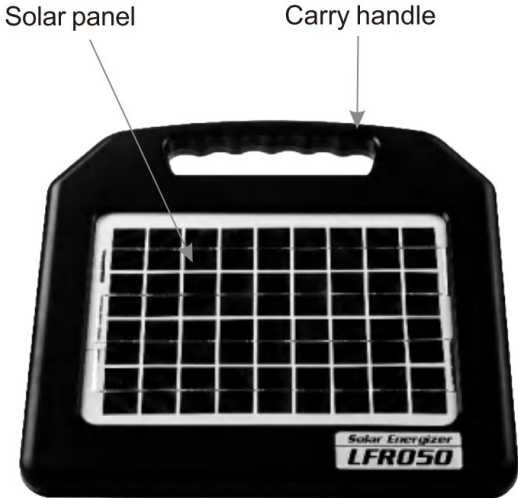

# Product Details

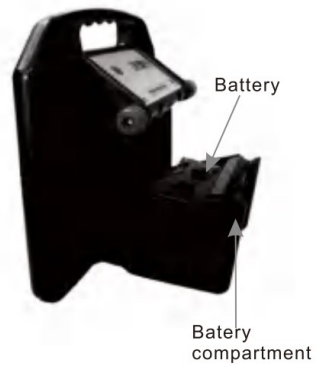
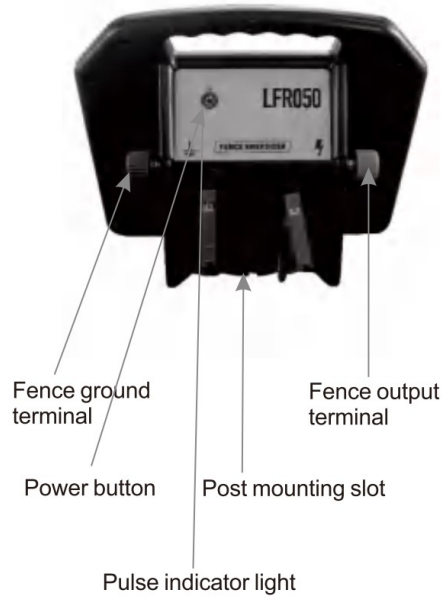

## Key to symbols on the unit

 Fence ground terminal (green). Connect the fence ground terminal to the ground system.

 Fence output terminal (red). Connect the fence output terminal to the fence.

 Risk of electric shock! This unit should be opened or repaired only by qualified personnel. No user serviceable parts.

 Read full instructions before use.



This symbol on the product or its packaging indicates that this product must not be disposed of with other waste. Instead, it is your responsibility to dispose of your waste equipment by handing it over to a designated collection point for the recycling of waste electrical and electronic equipment. The separate collection and recycling of your waste equipment at the time of disposal will help conserve natural resources and ensure that it is recycled in a manner that protects human health and the environment. For more information about where you can drop off your waste equipment for recycling, please contact your local city recycling office or the dealer from whom you purchased the product.

## Before first use

Units may be supplied with or without a battery, depending on your region. If a battery has been supplied, it will be inside the battery compartment with the positive terminal disconnected.

Before using the unit for the first time, you must:

- 1 Insert a battery into the battery compartment (if necessary).
- 2 Connect the battery terminals.
- 3 Charge the battery by placing the unit in full sunlight for three days with the solar panel facing true south in the northern hemisphere and true north in the southern hemisphere.

## LFR050-Battery

1. Place the unit on a flat surface (handle downwards as shown). Open the battery compartment by unscrewing the screws on the back.



2. Insert a battery (if necessary).
3. Connect the positive (red) lead to the positive (+) terminal on the battery. Connect the negative (black) lead to the negative (-) terminal on the battery (if necessary).
4. Close the battery compartment, ensuring that the latches are securely fastened.

**Caution!** When connecting the battery, be careful not to short circuit the supply terminals.

## Description

---

Power output at 500 ohms: 0.5J  
Delivered power vacuum: 0.63J  
Effective square meter: 50 Acres  
Effective length: 20 Miles  
Solar Consumption: 47 mA  
Voltage Vacuum: 10KV Max  
Waterproof Rating: IP65 Outdoor Use  
Power Source Battery: DC 12V/8AH(including)  
Operates Days without Sunlight: UP 2 weeks  
Polysilicon Solar Panel Voltage Output(Vmp): DC 18V  
Polysilicon Solar Panel Current Output(Imp): 0.28A  
Polysilicon Solar Panel Power Output(Pmax): 5W  
Solar Panel Size: 303\*213mm  
Plastic case Dimensions: 37.5\*22\*30cm  
G.W.: 3KGS  
Product including one AC/DC adapter,two alligator clips

## Installation

### Positioning the unit

---

Install the unit:

- adjacent to the electric fence
- preferably in the middle of the electric fence
- where it will receive the most daily sun throughout the season
- where a good ground can be obtained
- away from flooding and out of reach of animals and children (inside a protective fence, if required)
- with the solar panel facing true south in the northern hemisphere and true north in the southern hemisphere.

### Mounting the unit

---

The unit may be placed directly onto a flat surface or mounted directly onto a steel Y-post or T-post using the post-mounting slot.

## Connecting to an electric fence

## Pulse indicator light

The pulse indicator light indicates the output pulse speed. The pulse speed varies according to the battery charge level:

Battery charge level	Typical pulse speed
Normal	A pulse every 1.5 seconds
Low	A pulse every 3 seconds

## Standby mode

An intelligent battery management feature puts the unit into Standby mode when battery charge falls below a 'safe operating level'. When in Standby mode, the unit is still on, but it will not deliver a pulse to the electric fence.

The unit will resume delivering pulses when the solar panel has charged the battery so that it is above 'safe operating level'.

When operation resumes, the battery charge level will still be low, so the unit will deliver one pulse every 3 seconds. Once the battery reaches normal charge level, the pulse will revert to one pulse every 1.5 seconds.

## Battery information

### Battery charging

The solar panel can fully charge a flat battery in two weeks, provided the unit is switched off and there is adequate sunlight. A battery charger may also be used to charge the battery. Use a battery charger suitable for charging sealed, lead-acid batteries.

## Battery charger details

Warning! The battery must be disconnected and removed from the unit before connecting it to a battery charger.

Model	Battery type being charged	Battery charger requirements
LFR050	12 V	13.8 V, $\leq 1$ A

When fully charged, the battery should be able to power the unit for up to three weeks. To fit into the battery box, battery dimensions should be within 15\*6.5\*9.5 cm / L\*W\*H

## Replacing the battery

If a replacement battery is required, use a sealed lead-acid battery.

Warning! Do not use a non-rechargeable battery.

### Replacement battery details

Model	Suitable battery type
-------	-----------------------

LFR050 12 V, 8 Ah battery

Do not dispose of the battery in a land-fill or in a fire.

In the event of a spill or leakage from a sealed lead-acid battery:

- Contain small spills with dry sand, soil and vermiculite. Do not use combustible materials. If possible, carefully neutralize spilled electrolyte with soda ash, sodium bicarbonate, lime, etc.
- Wear acid-resistant clothing, boots, gloves and a face shield.
- Do not let un-neutralised acid get into the sewerage system.



Neutralized acid must be managed in accordance with approved local, state and federal requirements. Consult your state environmental agency and/or federal EPA.

## Maintenance

Clean the solar panel regularly with a soft cloth using glass cleaner or a mild solution of detergent and water. This will ensure the solar panel functions efficiently.

When transporting the unit, protect the solar panel to prevent the glass surface from being damaged.

## Storage

If the unit is stored for extended periods, the battery can discharge and become damaged.

The unit should be stored inside, next to a window, where sunlight can shine on the unit each day.

If the unit cannot be stored in a sunny position, it should be kept in a cool place. The battery should be fully charged and disconnected from the unit. The battery should be recharged manually every six months using a suitable battery charger.

## Positioning the unit

A temporary fence can be quickly erected and easily moved allowing the farmer to:

- Make smaller paddocks (fields)
- Keep herds of animals separated
- Ration feed

*Note:* Use more wires for smaller animals and wild animals. Polytape should be used when greater visibility is required (e.g. horses).

An example of a temporary fence is shown below.

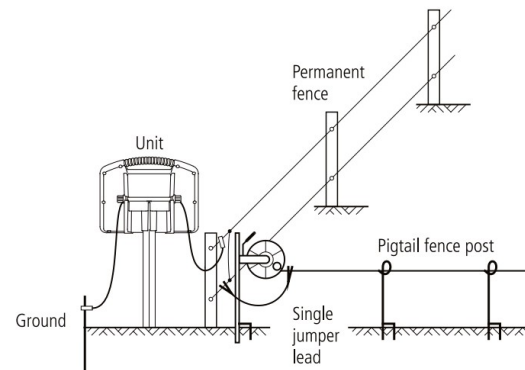

## Safety considerations

### Warning!

- Do not connect to mains-operated or line-operated equipment.
- Remove the battery from the unit before using an external battery charger to recharge the battery.
- Switch the unit off before installation or performing any work on the fence.
- Read all the safety considerations carefully.
- Check your installation to ensure that it complies with all local safety regulations.
- Do not connect simultaneously to a fence and to any other device such as a cattle trainer or a poultry trainer. Otherwise, lightning striking your fence will be conducted to all other devices.

### Notes:

- This product has been designed for use with electric animal fences.
- Keep these instructions in a handy location.

## Safe electric fence construction

### Warning! Read before use.

An electric fence can be hazardous when there is a risk of entrapment or entanglement, or other hazards exist. Serious injury or death may result. Take all steps to avoid the risk of entrapment or entanglement.

The adapter and battery cannot be used at the same time, When using battery, adapter cannot be inserted; When using adapter, Need to unplug the battery

## Danger

- Do not climb through or under an electric fence. If it is necessary to cross an electric fence use a gate or specially designed crossing point.
- Do not allow young or infirm persons to use this unit without supervision. Do not allow young children to play with this unit or near an electric fence or electrified wires.
- Do not electrify barbed wire.
- Do not support off-set electrified wires less than 6" (150 mm) from the vertical plane of a barbed wire fence.
- Do not electrify any fence construction which could lead to entanglement of persons or animals. We recommend for instance, that no more than one electrified off-set wire be supported on either side of a barbed wire or mesh fence.
- Do not supply an electric fence from two units.
- Do not allow electrified wires from two units on the same or adjacent properties to be less than 8' (2.5 m) apart.
- Do not place the unit's ground rod within 33' (10 m) of any part of a power supply ground system or telecommunications ground system.
- Do not run electric fence wires above or close to overhead power or communication lines.

### Cautions :

1. Feature: 2 dew holes at the bottom of the plastic box prevent water from accumulating.
2. When not use, the battery clip should be removed to prevent power consumption.
3. When use AC power, disconnect the battery clips to prevent battery from burning out.
4. When wire clips connect battery, the side with the spring faces up enable remove easily.

## Duty to the public

A warning sign shall be fitted to every point where persons may gain ready access to the conductors.

Where an electric animal fence crosses a public pathway, a non-electrified gate shall be incorporated in the electric animal fence at that point or a crossing by means of stiles shall be provided. At any such crossing, the adjacent electrified wires shall carry warning signs.

Any part of an electric animal fence that is installed along a public road or pathway shall be identified at frequent intervals by warning signs securely fastened to the fence posts or firmly clamped to the fence wires.

- The size of the warning sign shall be at least 4x8" (100x200 mm).
- The background colour of both sides of the warning sign shall be yellow. The inscription on the sign shall be black and shall be either:

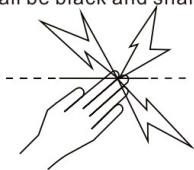

or the substance of "CAUTION: Electric fence".

- The inscription shall be indelible, inscribed on both sides of the warning sign and have a height of at least 1" (25 mm).

## Definition of special terms

Unit/Charger/Energizer – An appliance that is intended to periodically deliver voltage impulses to a fence connected to it.

Fence – A barrier for animals or for the purpose of security, comprising one or more conductors such as metal wires, rods or rails.

Electric fence – A barrier which includes one or more electric conductors, insulated from ground, to which electric pulses are applied by a unit.

Ground rod – Metal structure that is driven into the soil near a unit and connected electrically to the Fence ground terminal of the unit, and that is independent of other grounding arrangements.

Connecting lead – An electric conductor, used to connect the unit to the electric fence or the ground rod.

## Requirements for electric animal fences

Electric animal fences and their ancillary equipment shall be installed, operated and maintained in a manner that minimises danger to persons, animals or their surroundings.

**Warning! Avoid contacting electric fence wires especially with the head, neck or torso. Do not climb over, through or under a multi-wire electric fence. Use a gate or a specially designed crossing point.**

This unit is not intended for use by persons (including children) with reduced physical, sensory or mental capabilities, or lack of experience and knowledge, unless they have been given supervision or instruction concerning use of the unit by a person responsible for their safety.

Children should be supervised to ensure that they do not play with the unit. Electric animal fence constructions that are likely to lead to the entanglement of animals or persons shall be avoided.

An electric animal fence shall not be supplied from two separate units or from independent fence circuits of the same unit.

For any two separate electric animal fences, each supplied from a separate unit independently timed, the distance between the wires of the two electric animal fences shall be at least 8' (2.5 m). If this gap is to be closed, this shall be effected by means of electrically non-conductive material or an isolated metal barrier. Barbed wire or razor wire shall not be electrified by a unit.

A non-electrified fence incorporating barbed wire or razor wire may be used to support one or more off-set electrified wires of an electric animal fence.

supporting devices for the electrified wires shall be constructed so as to ensure that these wires are positioned at a minimum distance of 6" (150 mm) from the vertical plane of the non-electrified wires. The barbed wire and razor wire shall be grounded at regular intervals.

A distance of at least 33' (10 m) shall be maintained between the unit's ground rod and any other grounding system connected parts such as the grounding system for the power supply or the telecommunication system.

Connecting leads that are run inside buildings shall be effectively insulated from the grounded structural parts of the building. This may be achieved by using insulated high voltage cable.

Connecting leads that are run underground shall be run in conduit of insulating material or else insulated high voltage cable shall be used. Care must be taken to avoid damage to the connecting leads due to the effects of animal hooves or vehicle wheels sinking into the ground.

Connecting leads shall not be installed in the same conduit as the AC supply wiring, communication cables or data cables.

Connecting leads and electric animal fence wires shall not cross above overhead power or communication lines.

Crossings with overhead power lines shall be avoided wherever possible. If such a crossing cannot be avoided it shall be made underneath the power line and as nearly as possible at right angles to it.

If connecting leads and electric animal fence wires are installed near an overhead power line, the clearances shall not be less than those shown in the table below.

*Minimum clearances from power lines for electric animal fences*

Power line voltage	Clearance
≤1000 V	10' (3 m)
>1000 V to ≤33,000 V	13' (4 m)
>33,000 V	27' (8 m)

If connecting leads and electric animal fence wires are installed near an overhead power line, their height above the ground shall not exceed 10' (3 m). This height applies to either side of the orthogonal projection of the outermost conductors of the power line on the ground surface, for a distance of:

- 6'6" (2 m) for power lines operating at a nominal voltage not exceeding 1000 V.
- 50' (15 m) for power lines operating at a nominal voltage exceeding 1000 V.

Electric animal fences intended for deterring birds, household pet containment or training animals such as cows need only be supplied from low output units to obtain satisfactory and safe performance.

In electric animal fences intended for deterring birds from roosting on buildings, no electric fence wire shall be connected to the unit's ground rod.

Ensure that all line-operated, ancillary equipment connected to the electric animal fence circuit provides a degree of isolation between the fence circuit and the supply mains equivalent to that provided by the unit.

Protection from the weather shall be provided for the ancillary equipment unless this equipment is certified by the manufacturer as being suitable for use outdoors, and is of a type with a minimum degree of protection IP66.



## Troubleshooting

Problem	Action
The pulse indicator light is flashing, but the electric shock delivered by the fence is weak.	<p>Check that all connections in the fence and ground system are firm and secure. If necessary, clean away any corrosion. Check that the ground rod is pushed firmly into firm ground. Check for faults in the fence-line caused by trees or vegetation. If necessary, remove obstructions and mend the fence.</p> <p>Check that the unit (charger) rating is adequate for the length of the fence. If necessary, reduce the length of the fence or reduce the number of fence wires. Alternatively, divide the fence-line into smaller zones, with each zone powered by a separate unit.</p>
The pulse indicator light is no flashing.	<p>Check that the unit is switched on.</p> <p>If there has been insufficient sunlight to charge the battery, the unit may be in Standby mode. Charge the battery by placing the unit in full sunlight with the solar panel facing true south in the northern hemisphere and true north in the southern hemisphere.</p> <p>Ensure the battery is connected correctly with the positive (red) lead to the positive (+) terminal on the battery and the negative (black) lead to the negative (-) terminal on the battery.</p> <p>Try charging the battery manually using a suitable battery charger. See Battery charging on page 9.</p> <p>Replace the battery with a new battery. Before installing a new battery, charge it fully using a suitable battery charger. If the pulse indicator light is still not flashing, please contact us.</p>

The battery needs frequent replacement.

Check that the solar panel is clean and is not damaged. See Maintenance on page 9.

Make sure the unit is positioned to receive maximum sunlight. If necessary, remove any objects or vegetation that might be casting a shadow on the unit. See Positioning the unit on page 6, or for more detailed information on solar installations.

After the unit is switched on, the pulse indicator light gives three long flashes (2 seconds) then the unit appears to be off.

The unit is in Standby mode because there has been insufficient sunlight to charge the battery. Charge the battery by placing the unit in full sunlight with the solar panel facing true south in the northern hemisphere and true north in the southern hemisphere.

The pulse indicator light flashes quickly several times and then there is a pause.

There may be a problem with the unit. Return the unit to a service agent appointed by

## **Servicing**

*Please contact your local store.*

*Note: If you suspect the unit is not working, always check the battery connection and voltage before proceeding.*

## **Warranty**

This warranty does not cover defects caused by:

- Incorrect input voltage or polarity
- Damage to external wiring
- Physical mishandling
- Water immersion
- Vermin or insect damage

---

*Note:* This product has been manufactured to comply with international safety standards.

---

This product is warranted against faulty material and workmanship for a period of 2 years from date of purchase.

If a warranted defect occurs, return this product with proof of purchase to an authorised service centre.

Note:

- No responsibility is accepted for any accident or damage caused subsequent to any tampering with or modification to or misuse of this product, including (but not limited to) alterations made by anyone other than
- To the maximum extent permitted by law, this warranty is exclusive, personal to you and in lieu of all other warranties, representations or conditions relating to this product (whether express or implied and whenever arising) whether originating by statute, law, trade, custom or otherwise.
- The product warranty is only valid in the original country of purchase. Any claims made in another country may incur full repair costs at the owner's expense.

**VEVOR<sup>®</sup>**  
**TOUGH TOOLS, HALF PRICE**





**VEVOR**<sup>®</sup>  
TOUGH TOOLS, HALF PRICE

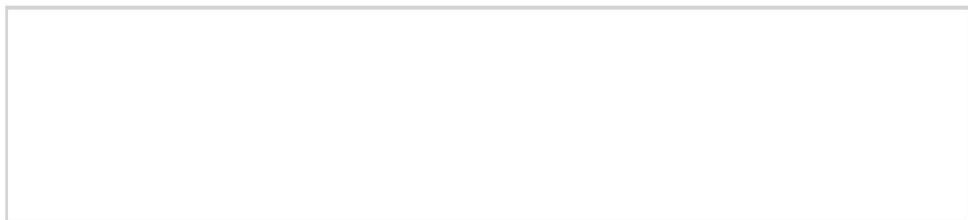



Electric Netting (1pc)



Net Repair Kit (1set)



Wire Hanging Kit (2sets)



Warning Sign (1pc)



Solar Energizer (1pc)



Alligator clips (1set)



12KV Lead-acid battery



12KV Fence Tester (1pc)



Earth Rod (1pc)



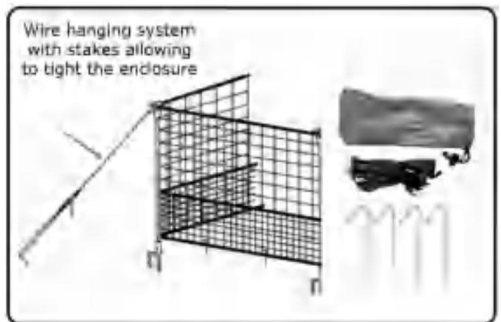

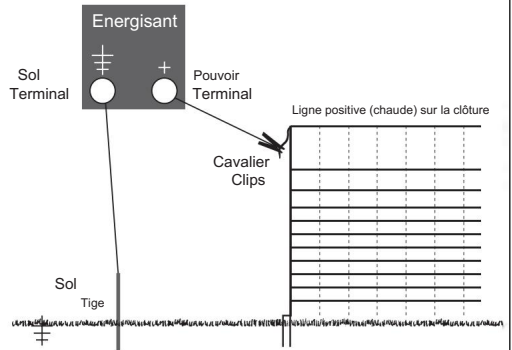

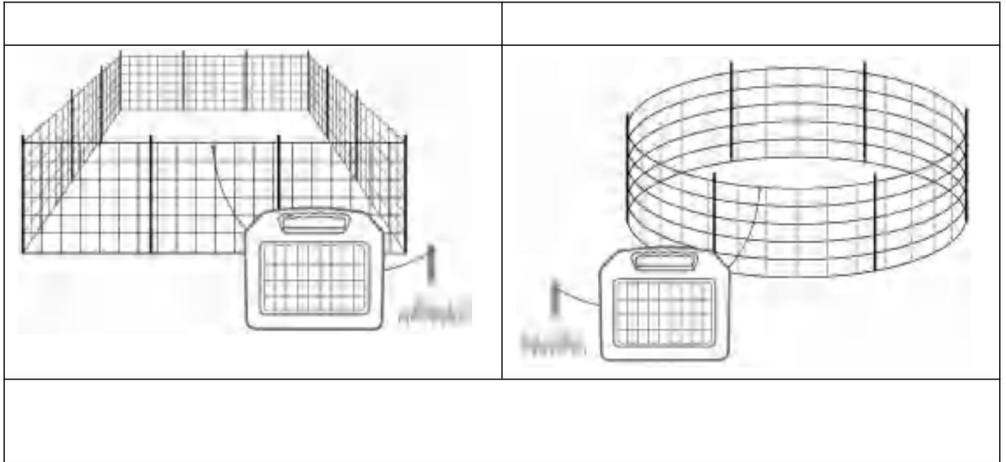

NOMBRE DE PIEDS DE FILETS ÉNERGISANT RECOMMANDÉ		
1	120 pieds	10 milles, 10 acres
2	240 pieds	20 milles, 20 acres
3	360 pieds	30 milles, 30 acres
4	480 pieds	40 milles, 40 acres



PRUDENCE







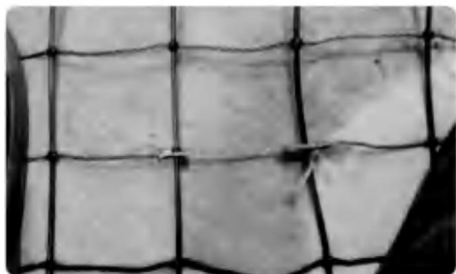
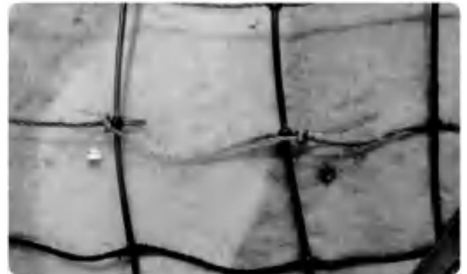
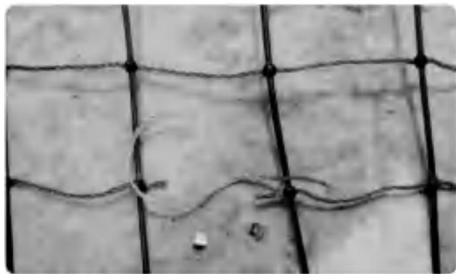
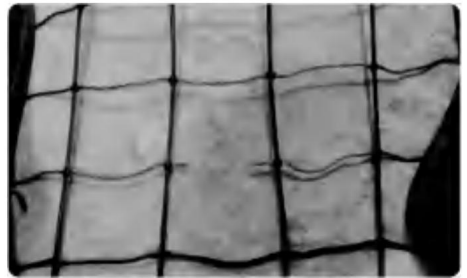
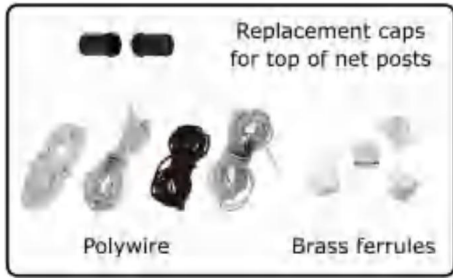

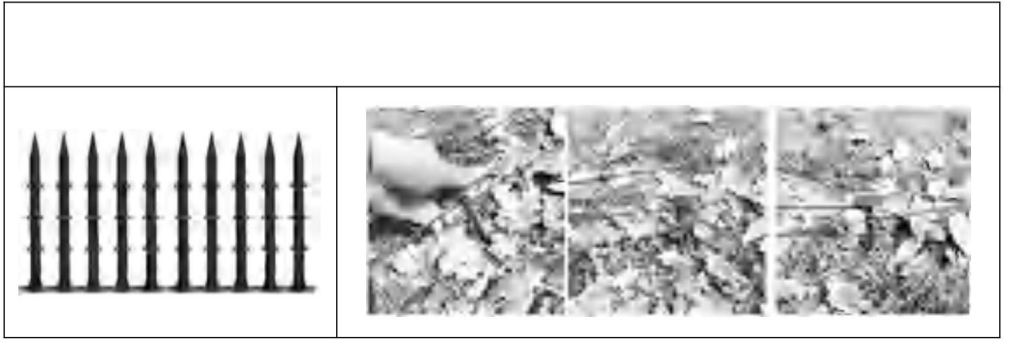



: Shuangchenglu 803nong11hao1602A-1609shi, baoshanqu  
, Shanghai 200 000 CN.

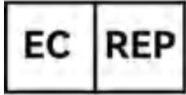

E-CrossStu GmbH.  
Mainzer Landstr.69, 60329 Francfort-sur-le-Main.



YH CONSULTING LIMITÉE.  
C/O YH Consulting Limited Bureau 147, Centurion House,  
Route de Londres, Staines-upon-Thames, Surrey, TW18 4AX



**VEVOR**®  
TOUGH TOOLS, HALF PRICE

# **ELECTRIC FENCE ENERGIZER USER MANUAL**

## **WARNING: READ ALL INSTRUCTIONS**

If you suspect that the unit is not working, follow these steps:

1. Disconnect the unit from the fence and check that the indicator light is flashing.
2. Check the battery connection and voltage.
3. Check that the voltage between the live and ground terminals is greater than 7000 V, using a fence voltage tester.
4. If these tests are OK, you have an installation problem.

**Consult your user manual for installation and operating instructions**

# **CONTENTS**

Product Details	01
Key to symbols on the unit	03
Description	05
Installation	05
Battery information	07
Positioning the unit	10
Safety considerations	11
Troubleshooting	17
Servicing	19
Warranty	19



# Product Details

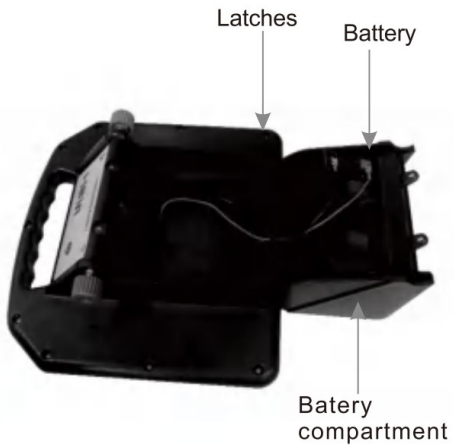
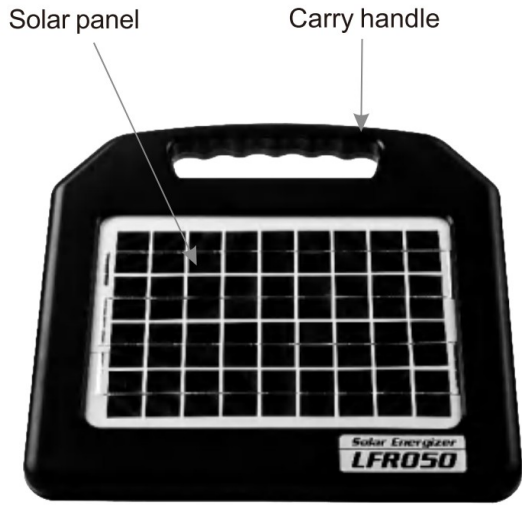

# Product Details

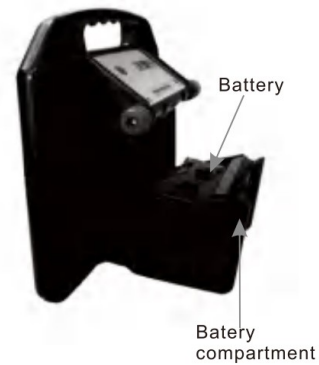
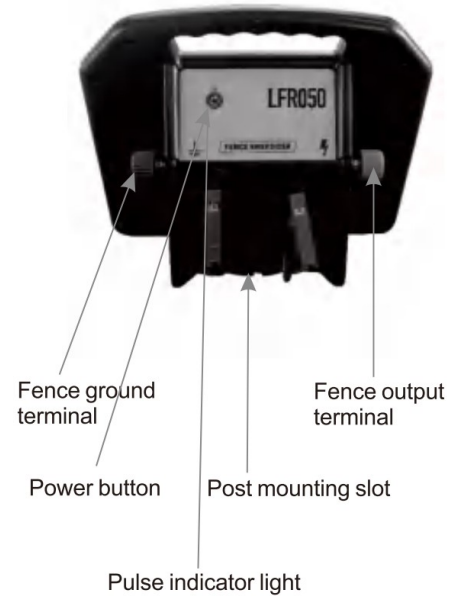

## Key to symbols on the unit

 Fence ground terminal (green). Connect the fence ground terminal to the ground system.

 Fence output terminal (red). Connect the fence output terminal to the fence.

 Risk of electric shock! This unit should be opened or repaired only by qualified personnel. No user serviceable parts.

 Read full instructions before use.



This symbol on the product or its packaging indicates that this product must not be disposed of with other waste. Instead, it is your responsibility to dispose of your waste equipment by handing it over to a designated collection point for the recycling of waste electrical and electronic equipment. The separate collection and recycling of your waste equipment at the time of disposal will help conserve natural resources and ensure that it is recycled in a manner that protects human health and the environment. For more information about where you can drop off your waste equipment for recycling, please contact your local city recycling office or the dealer from whom you purchased the product.

## Before first use

Units may be supplied with or without a battery, depending on your region. If a battery has been supplied, it will be inside the battery compartment with the positive terminal disconnected.

Before using the unit for the first time, you must:

- 1 Insert a battery into the battery compartment (if necessary).
- 2 Connect the battery terminals.
- 3 Charge the battery by placing the unit in full sunlight for three days with the solar panel facing true south in the northern hemisphere and true north in the southern hemisphere.

## LFR050-Battery

1. Place the unit on a flat surface (handle downwards as shown). Open the battery compartment by unscrewing the screws on the back.



2. Insert a battery (if necessary).
3. Connect the positive (red) lead to the positive (+) terminal on the battery. Connect the negative (black) lead to the negative (-) terminal on the battery (if necessary).
4. Close the battery compartment, ensuring that the latches are securely fastened.

**Caution!** When connecting the battery, be careful not to short circuit the supply terminals.

## Description

---

Power output at 500 ohms: 0.5J  
Delivered power vacuum: 0.63J  
Effective square meter: 50 Acres  
Effective length: 20 Miles  
Solar Consumption: 47 mA  
Voltage Vacuum: 10KV Max  
Waterproof Rating: IP65 Outdoor Use  
Power Source Battery: DC 12V/8AH(including)  
Operates Days without Sunlight: UP 2 weeks  
Polysilicon Solar Panel Voltage Output(Vmp): DC 18V  
Polysilicon Solar Panel Current Output(Imp): 0.28A  
Polysilicon Solar Panel Power Output(Pmax): 5W  
Solar Panel Size: 303\*213mm  
Plastic case Dimensions: 37.5\*22\*30cm  
G.W.: 3KGS  
Product including one AC/DC adapter,two alligator clips

## Installation

### Positioning the unit

---

Install the unit:

- adjacent to the electric fence
- preferably in the middle of the electric fence
- where it will receive the most daily sun throughout the season
- where a good ground can be obtained
- away from flooding and out of reach of animals and children (inside a protective fence, if required)
- with the solar panel facing true south in the northern hemisphere and true north in the southern hemisphere.

### Mounting the unit

---

The unit may be placed directly onto a flat surface or mounted directly onto a steel Y-post or T-post using the post-mounting slot.

## Connecting to an electric fence

## Pulse indicator light

The pulse indicator light indicates the output pulse speed. The pulse speed varies according to the battery charge level:

Battery charge level	Typical pulse speed
Normal	A pulse every 1.5 seconds
Low	A pulse every 3 seconds

## Standby mode

An intelligent battery management feature puts the unit into Standby mode when battery charge falls below a 'safe operating level'. When in Standby mode, the unit is still on, but it will not deliver a pulse to the electric fence.

The unit will resume delivering pulses when the solar panel has charged the battery so that it is above 'safe operating level'.

When operation resumes, the battery charge level will still be low, so the unit will deliver one pulse every 3 seconds. Once the battery reaches normal charge level, the pulse will revert to one pulse every 1.5 seconds.

## Battery information

### Battery charging

The solar panel can fully charge a flat battery in two weeks, provided the unit is switched off and there is adequate sunlight. A battery charger may also be used to charge the battery. Use a battery charger suitable for charging sealed, lead-acid batteries.

## Battery charger details

Warning! The battery must be disconnected and removed from the unit before connecting it to a battery charger.

Model	Battery type being charged	Battery charger requirements
LFR050	12 V	13.8 V, $\leq 1$ A

When fully charged, the battery should be able to power the unit for up to three weeks. To fit into the battery box, battery dimensions should be within 15\*6.5\*9.5 cm / L\*W\*H

## Replacing the battery

If a replacement battery is required, use a sealed lead-acid battery.

Warning! Do not use a non-rechargeable battery.

### Replacement battery details

Model	Suitable battery type
LFR050	12 V, 8 Ah battery

Do not dispose of the battery in a land-fill or in a fire.

In the event of a spill or leakage from a sealed lead-acid battery:

- Contain small spills with dry sand, soil and vermiculite. Do not use combustible materials. If possible, carefully neutralize spilled electrolyte with soda ash, sodium bicarbonate, lime, etc.
- Wear acid-resistant clothing, boots, gloves and a face shield.
- Do not let un-neutralised acid get into the sewerage system.

Neutralized acid must be managed in accordance with approved local, state and federal requirements. Consult your state environmental agency and/or federal EPA.

## Maintenance

Clean the solar panel regularly with a soft cloth using glass cleaner or a mild solution of detergent and water. This will ensure the solar panel functions efficiently.

When transporting the unit, protect the solar panel to prevent the glass surface from being damaged.

## Storage

If the unit is stored for extended periods, the battery can discharge and become damaged.

The unit should be stored inside, next to a window, where sunlight can shine on the unit each day.

If the unit cannot be stored in a sunny position, it should be kept in a cool place. The battery should be fully charged and disconnected from the unit. The battery should be recharged manually every six months using a suitable battery charger.

## Positioning the unit

A temporary fence can be quickly erected and easily moved allowing the farmer to:

- Make smaller paddocks (fields)
- Keep herds of animals separated
- Ration feed

*Note:* Use more wires for smaller animals and wild animals. Polytape should be used when greater visibility is required (e.g. horses).

An example of a temporary fence is shown below.

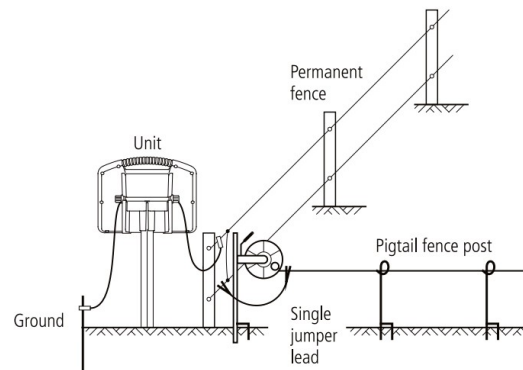



## Safety considerations

### *Warning!*

- Do not connect to mains-operated or line-operated equipment.
- Remove the battery from the unit before using an external battery charger to recharge the battery.
- Switch the unit off before installation or performing any work on the fence.
- Read all the safety considerations carefully.
- Check your installation to ensure that it complies with all local safety regulations.
- Do not connect simultaneously to a fence and to any other device such as a cattle trainer or a poultry trainer. Otherwise, lightning striking your fence will be conducted to all other devices.

### *Notes:*

- This product has been designed for use with electric animal fences.
- Keep these instructions in a handy location.

## Safe electric fence construction

### *Warning!* Read before use.

An electric fence can be hazardous when there is a risk of entrapment or entanglement, or other hazards exist. Serious injury or death may result. Take all steps to avoid the risk of entrapment or entanglement.

The adapter and battery cannot be used at the same time, When using battery, adapter cannot be inserted; When using adapter, Need to unplug the battery

## Danger

- Do not climb through or under an electric fence. If it is necessary to cross an electric fence use a gate or specially designed crossing point.
- Do not allow young or infirm persons to use this unit without supervision. Do not allow young children to play with this unit or near an electric fence or electrified wires.
- Do not electrify barbed wire.
- Do not support off-set electrified wires less than 6" (150 mm) from the vertical plane of a barbed wire fence.
- Do not electrify any fence construction which could lead to entanglement of persons or animals. We recommend for instance, that no more than one electrified off-set wire be supported on either side of a barbed wire or mesh fence.
- Do not supply an electric fence from two units.
- Do not allow electrified wires from two units on the same or adjacent properties to be less than 8' (2.5 m) apart.
- Do not place the unit's ground rod within 33' (10 m) of any part of a power supply ground system or telecommunications ground system.
- Do not run electric fence wires above or close to overhead power or communication lines.

### Cautions :

1. Feature: 2 dew holes at the bottom of the plastic box prevent water from accumulating.
2. When not use, the battery clip should be removed to prevent power consumption.
3. When use AC power, disconnect the battery clips to prevent battery from burning out.
4. When wire clips connect battery, the side with the spring faces up enable remove easily.

## Duty to the public

A warning sign shall be fitted to every point where persons may gain ready access to the conductors.

Where an electric animal fence crosses a public pathway, a non-electrified gate shall be incorporated in the electric animal fence at that point or a crossing by means of stiles shall be provided. At any such crossing, the adjacent electrified wires shall carry warning signs.

Any part of an electric animal fence that is installed along a public road or pathway shall be identified at frequent intervals by warning signs securely fastened to the fence posts or firmly clamped to the fence wires.

- The size of the warning sign shall be at least 4x8" (100x200 mm).
- The background colour of both sides of the warning sign shall be yellow. The inscription on the sign shall be black and shall be either:

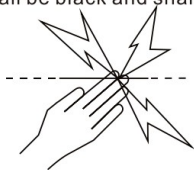

or the substance of "CAUTION: Electric fence".

- The inscription shall be indelible, inscribed on both sides of the warning sign and have a height of at least 1" (25 mm).

## Definition of special terms

Unit/Charger/Energizer – An appliance that is intended to periodically deliver voltage impulses to a fence connected to it.

Fence – A barrier for animals or for the purpose of security, comprising one or more conductors such as metal wires, rods or rails.

Electric fence – A barrier which includes one or more electric conductors, insulated from ground, to which electric pulses are applied by a unit.

Ground rod – Metal structure that is driven into the soil near a unit and connected electrically to the Fence ground terminal of the unit, and that is independent of other grounding arrangements.

Connecting lead – An electric conductor, used to connect the unit to the electric fence or the ground rod.

## Requirements for electric animal fences

Electric animal fences and their ancillary equipment shall be installed, operated and maintained in a manner that minimises danger to persons, animals or their surroundings.

**Warning! Avoid contacting electric fence wires especially with the head, neck or torso. Do not climb over, through or under a multi-wire electric fence. Use a gate or a specially designed crossing point.**

This unit is not intended for use by persons (including children) with reduced physical, sensory or mental capabilities, or lack of experience and knowledge, unless they have been given supervision or instruction concerning use of the unit by a person responsible for their safety.

Children should be supervised to ensure that they do not play with the unit. Electric animal fence constructions that are likely to lead to the entanglement of animals or persons shall be avoided.

An electric animal fence shall not be supplied from two separate units or from independent fence circuits of the same unit.

For any two separate electric animal fences, each supplied from a separate unit independently timed, the distance between the wires of the two electric animal fences shall be at least 8' (2.5 m). If this gap is to be closed, this shall be effected by means of electrically non-conductive material or an isolated metal barrier. Barbed wire or razor wire shall not be electrified by a unit.

A non-electrified fence incorporating barbed wire or razor wire may be used to support one or more off-set electrified wires of an electric animal fence.

supporting devices for the electrified wires shall be constructed so as to ensure that these wires are positioned at a minimum distance of 6" (150 mm) from the vertical plane of the non-electrified wires. The barbed wire and razor wire shall be grounded at regular intervals.

A distance of at least 33' (10 m) shall be maintained between the unit's ground rod and any other grounding system connected parts such as the grounding system for the power supply or the telecommunication system.

Connecting leads that are run inside buildings shall be effectively insulated from the grounded structural parts of the building. This may be achieved by using insulated high voltage cable.

Connecting leads that are run underground shall be run in conduit of insulating material or else insulated high voltage cable shall be used. Care must be taken to avoid damage to the connecting leads due to the effects of animal hooves or vehicle wheels sinking into the ground.

Connecting leads shall not be installed in the same conduit as the AC supply wiring, communication cables or data cables.

Connecting leads and electric animal fence wires shall not cross above overhead power or communication lines.

Crossings with overhead power lines shall be avoided wherever possible. If such a crossing cannot be avoided it shall be made underneath the power line and as nearly as possible at right angles to it.

If connecting leads and electric animal fence wires are installed near an overhead power line, the clearances shall not be less than those shown in the table below.

*Minimum clearances from power lines for electric animal fences*

Power line voltage	Clearance
≤1000 V	10' (3 m)
>1000 V to ≤33,000 V	13' (4 m)
>33,000 V	27' (8 m)

If connecting leads and electric animal fence wires are installed near an overhead power line, their height above the ground shall not exceed 10' (3 m). This height applies to either side of the orthogonal projection of the outermost conductors of the power line on the ground surface, for a distance of:

- 6'6" (2 m) for power lines operating at a nominal voltage not exceeding 1000 V.
- 50' (15 m) for power lines operating at a nominal voltage exceeding 1000 V.

Electric animal fences intended for deterring birds, household pet containment or training animals such as cows need only be supplied from low output units to obtain satisfactory and safe performance.

In electric animal fences intended for deterring birds from roosting on buildings, no electric fence wire shall be connected to the unit's ground rod.

Ensure that all line-operated, ancillary equipment connected to the electric animal fence circuit provides a degree of isolation between the fence circuit and the supply mains equivalent to that provided by the unit.

Protection from the weather shall be provided for the ancillary equipment unless this equipment is certified by the manufacturer as being suitable for use outdoors, and is of a type with a minimum degree of protection IP66.



## Troubleshooting

Problem	Action
The pulse indicator light is flashing, but the electric shock delivered by the fence is weak.	<p>Check that all connections in the fence and ground system are firm and secure. If necessary, clean away any corrosion. Check that the ground rod is pushed firmly into firm ground. Check for faults in the fence-line caused by trees or vegetation. If necessary, remove obstructions and mend the fence.</p> <p>Check that the unit (charger) rating is adequate for the length of the fence. If necessary, reduce the length of the fence or reduce the number of fence wires. Alternatively, divide the fence-line into smaller zones, with each zone powered by a separate unit.</p>
The pulse indicator light is no flashing.	<p>Check that the unit is switched on.</p> <p>If there has been insufficient sunlight to charge the battery, the unit may be in Standby mode. Charge the battery by placing the unit in full sunlight with the solar panel facing true south in the northern hemisphere and true north in the southern hemisphere.</p> <p>Ensure the battery is connected correctly with the positive (red) lead to the positive (+) terminal on the battery and the negative (black) lead to the negative (-) terminal on the battery.</p> <p>Try charging the battery manually using a suitable battery charger. See Battery charging on page 9.</p> <p>Replace the battery with a new battery. Before installing a new battery, charge it fully using a suitable battery charger. If the pulse indicator light is still not flashing, please contact us.</p>

The battery needs frequent replacement.

Check that the solar panel is clean and is not damaged. See Maintenance on page 9.

Make sure the unit is positioned to receive maximum sunlight. If necessary, remove any objects or vegetation that might be casting a shadow on the unit. See Positioning the unit on page 6, or for more detailed information on solar installations.

After the unit is switched on, the pulse indicator light gives three long flashes (2 seconds) then the unit appears to be off.

The unit is in Standby mode because there has been insufficient sunlight to charge the battery. Charge the battery by placing the unit in full sunlight with the solar panel facing true south in the northern hemisphere and true north in the southern hemisphere.

The pulse indicator light flashes quickly several times and then there is a pause.

There may be a problem with the unit. Return the unit to a service agent appointed by

## **Servicing**

*Please contact your local store.*

*Note: If you suspect the unit is not working, always check the battery connection and voltage before proceeding.*

## **Warranty**

This warranty does not cover defects caused by:

- Incorrect input voltage or polarity
- Damage to external wiring
- Physical mishandling
- Water immersion
- Vermin or insect damage

---

*Note:* This product has been manufactured to comply with international safety standards.

---

This product is warranted against faulty material and workmanship for a period of 2 years from date of purchase.

If a warranted defect occurs, return this product with proof of purchase to an authorised service centre.

Note:

- No responsibility is accepted for any accident or damage caused subsequent to any tampering with or modification to or misuse of this product, including (but not limited to) alterations made by anyone other than
- To the maximum extent permitted by law, this warranty is exclusive, personal to you and in lieu of all other warranties, representations or conditions relating to this product (whether express or implied and whenever arising) whether originating by statute, law, trade, custom or otherwise.
- The product warranty is only valid in the original country of purchase. Any claims made in another country may incur full repair costs at the owner's expense.

**VEVOR<sup>®</sup>**  
**TOUGH TOOLS, HALF PRICE**



**VEVOR**<sup>®</sup>  
TOUGH TOOLS, HALF PRICE

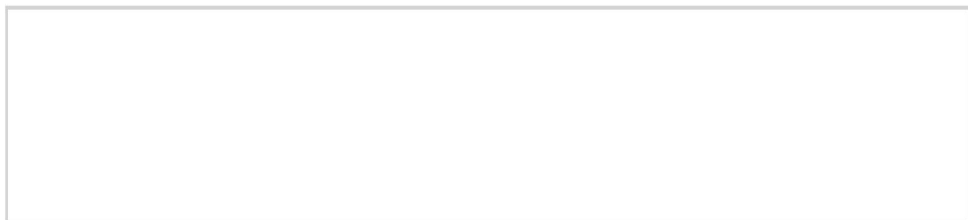



Electric Netting (1pc)



Net Repair Kit (1set)



Wire Hanging Kit (2sets)



Warning Sign (1pc)



Solar Energizer (1pc)



Alligator clips (1set)



12KV Lead-acid battery



12KV Fence Tester (1pc)



Earth Rod (1pc)





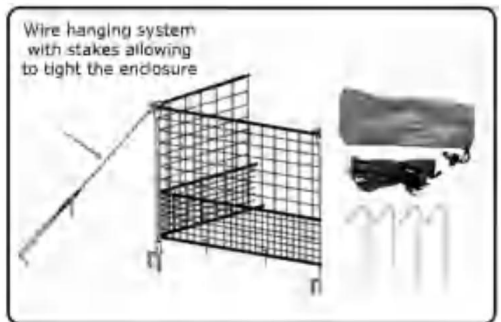

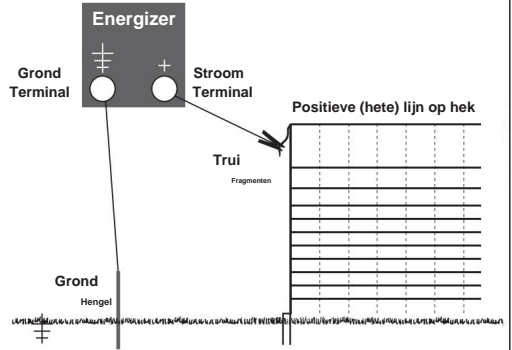

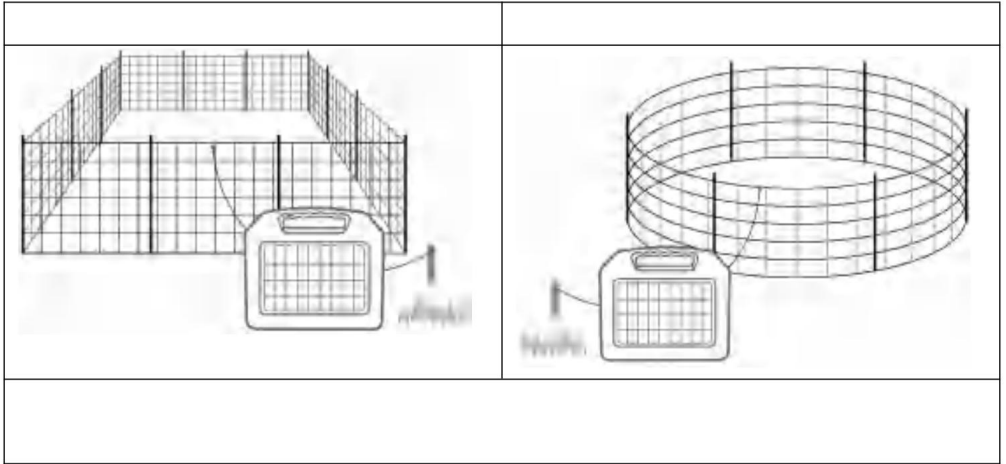

### AANTAL NETTEN VOET AANBEVOLEN ENERGIZER

1	120 voet.	10 mijl, 10 hectare
2	240 voet.	20 mijl, 20 hectare
3	110 meter	30 mijl, 30 hectare
4	146 meter	40 mijl, 40 hectare



VOORZICHTIGHEID





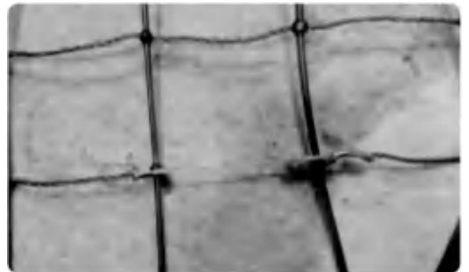
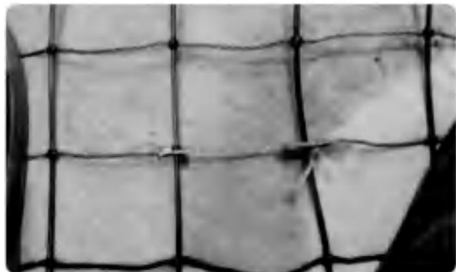
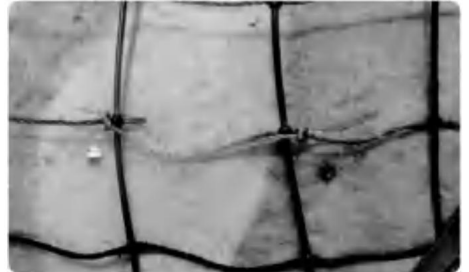
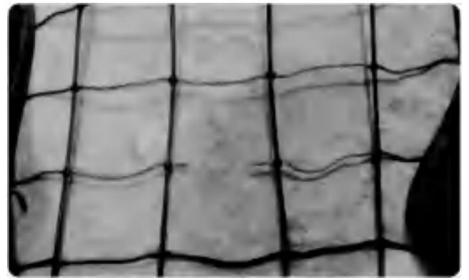
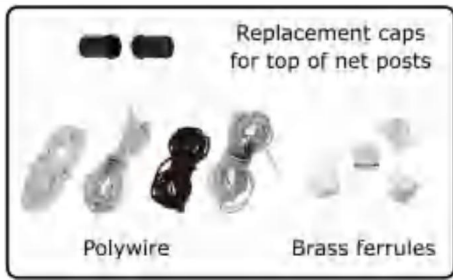





: Shuangchenglu 803nong11hao1602A-1609shi, baoshanqu  
, Sjanghai 200000 CN.

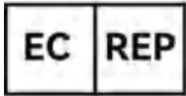

E-CrossStu GmbH.  
Mainzer Landstr.69, 60329 Frankfurt am Main.

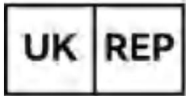

YH CONSULTING LIMITED.  
C/O YH Consulting Limited Kantoor 147, Centurion House,  
Londen Road, Staines-upon-Thames, Surrey, TW18 4AX





**VEVOR**<sup>®</sup>  
TOUGH TOOLS, HALF PRICE

# **ELECTRIC FENCE ENERGIZER USER MANUAL**

## **WARNING: READ ALL INSTRUCTIONS**

If you suspect that the unit is not working, follow these steps:

1. Disconnect the unit from the fence and check that the indicator light is flashing.
2. Check the battery connection and voltage.
3. Check that the voltage between the live and ground terminals is greater than 7000 V, using a fence voltage tester.
4. If these tests are OK, you have an installation problem.

**Consult your user manual for installation  
and operating instructions**

# **CONTENTS**

Product Details	01
Key to symbols on the unit	03
Description	05
Installation	05
Battery information	07
Positioning the unit	10
Safety considerations	11
Troubleshooting	17
Servicing	19
Warranty	19

# Product Details

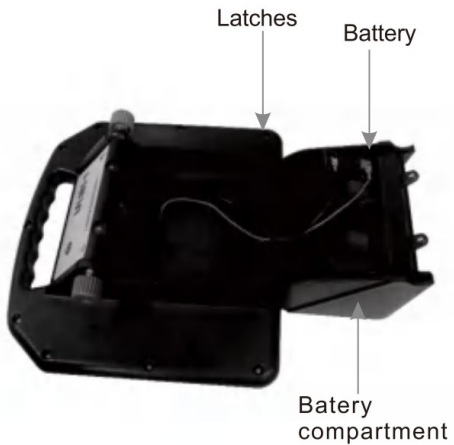
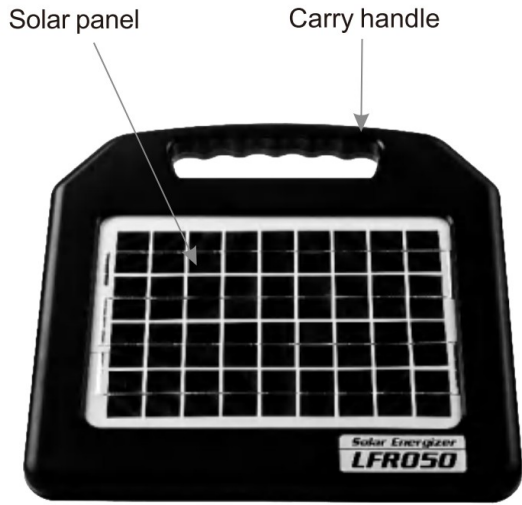

# Product Details

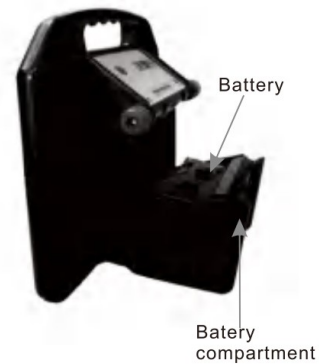
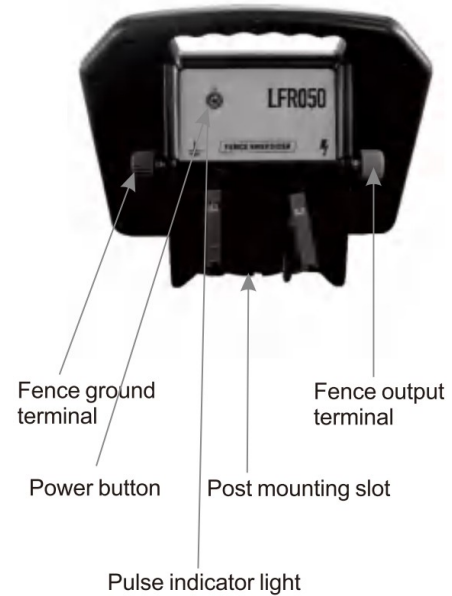

## Key to symbols on the unit

 Fence ground terminal (green). Connect the fence ground terminal to the ground system.

 Fence output terminal (red). Connect the fence output terminal to the fence.



Risk of electric shock! This unit should be opened or repaired only by qualified personnel. No user serviceable parts.



Read full instructions before use.



This symbol on the product or its packaging indicates that this product must not be disposed of with other waste. Instead, it is your responsibility to dispose of your waste equipment by handing it over to a designated collection point for the recycling of waste electrical and electronic equipment. The separate collection and recycling of your waste equipment at the time of disposal will help conserve natural resources and ensure that it is recycled in a manner that protects human health and the environment. For more information about where you can drop off your waste equipment for recycling, please contact your local city recycling office or the dealer from whom you purchased the product.

## Before first use

Units may be supplied with or without a battery, depending on your region. If a battery has been supplied, it will be inside the battery compartment with the positive terminal disconnected.

Before using the unit for the first time, you must:

- 1 Insert a battery into the battery compartment (if necessary).
- 2 Connect the battery terminals.
- 3 Charge the battery by placing the unit in full sunlight for three days with the solar panel facing true south in the northern hemisphere and true north in the southern hemisphere.

## LFR050-Battery

1. Place the unit on a flat surface (handle downwards as shown). Open the battery compartment by unscrewing the screws on the back.



2. Insert a battery (if necessary).
3. Connect the positive (red) lead to the positive (+) terminal on the battery. Connect the negative (black) lead to the negative (-) terminal on the battery (if necessary).
4. Close the battery compartment, ensuring that the latches are securely fastened.

**Caution!** When connecting the battery, be careful not to short circuit the supply terminals.

## Description

---

Power output at 500 ohms: 0.5J  
Delivered power vacuum: 0.63J  
Effective square meter: 50 Acres  
Effective length: 20 Miles  
Solar Consumption: 47 mA  
Voltage Vacuum: 10KV Max  
Waterproof Rating: IP65 Outdoor Use  
Power Source Battery: DC 12V/8AH(including)  
Operates Days without Sunlight: UP 2 weeks  
Polysilicon Solar Panel Voltage Output(Vmp): DC 18V  
Polysilicon Solar Panel Current Output(Imp): 0.28A  
Polysilicon Solar Panel Power Output(Pmax): 5W  
Solar Panel Size: 303\*213mm  
Plastic case Dimensions: 37.5\*22\*30cm  
G.W.: 3KGS  
Product including one AC/DC adapter,two alligator clips

## Installation

### Positioning the unit

---

Install the unit:

- adjacent to the electric fence
- preferably in the middle of the electric fence
- where it will receive the most daily sun throughout the season
- where a good ground can be obtained
- away from flooding and out of reach of animals and children (inside a protective fence, if required)
- with the solar panel facing true south in the northern hemisphere and true north in the southern hemisphere.

### Mounting the unit

---

The unit may be placed directly onto a flat surface or mounted directly onto a steel Y-post or T-post using the post-mounting slot.

## Connecting to an electric fence

## Pulse indicator light

The pulse indicator light indicates the output pulse speed. The pulse speed varies according to the battery charge level:

Battery charge level	Typical pulse speed
Normal	A pulse every 1.5 seconds
Low	A pulse every 3 seconds

## Standby mode

An intelligent battery management feature puts the unit into Standby mode when battery charge falls below a 'safe operating level'. When in Standby mode, the unit is still on, but it will not deliver a pulse to the electric fence.

The unit will resume delivering pulses when the solar panel has charged the battery so that it is above 'safe operating level'.

When operation resumes, the battery charge level will still be low, so the unit will deliver one pulse every 3 seconds. Once the battery reaches normal charge level, the pulse will revert to one pulse every 1.5 seconds.

## Battery information

### Battery charging

The solar panel can fully charge a flat battery in two weeks, provided the unit is switched off and there is adequate sunlight. A battery charger may also be used to charge the battery. Use a battery charger suitable for charging sealed, lead-acid batteries.

## Battery charger details

Warning! The battery must be disconnected and removed from the unit before connecting it to a battery charger.

Model	Battery type being charged	Battery charger requirements
LFR050	12 V	13.8 V, $\leq 1$ A

When fully charged, the battery should be able to power the unit for up to three weeks. To fit into the battery box, battery dimensions should be within 15\*6.5\*9.5 cm / L\*W\*H

## Replacing the battery

If a replacement battery is required, use a sealed lead-acid battery.

Warning! Do not use a non-rechargeable battery.

### Replacement battery details

Model	Suitable battery type
-------	-----------------------

LFR050 12 V, 8 Ah battery

Do not dispose of the battery in a land-fill or in a fire.

In the event of a spill or leakage from a sealed lead-acid battery:

- Contain small spills with dry sand, soil and vermiculite. Do not use combustible materials. If possible, carefully neutralize spilled electrolyte with soda ash, sodium bicarbonate, lime, etc.
- Wear acid-resistant clothing, boots, gloves and a face shield.
- Do not let un-neutralised acid get into the sewerage system.



Neutralized acid must be managed in accordance with approved local, state and federal requirements. Consult your state environmental agency and/or federal EPA.

## Maintenance

Clean the solar panel regularly with a soft cloth using glass cleaner or a mild solution of detergent and water. This will ensure the solar panel functions efficiently.

When transporting the unit, protect the solar panel to prevent the glass surface from being damaged.

## Storage

If the unit is stored for extended periods, the battery can discharge and become damaged.

The unit should be stored inside, next to a window, where sunlight can shine on the unit each day.

If the unit cannot be stored in a sunny position, it should be kept in a cool place. The battery should be fully charged and disconnected from the unit. The battery should be recharged manually every six months using a suitable battery charger.

## Positioning the unit

A temporary fence can be quickly erected and easily moved allowing the farmer to:

- Make smaller paddocks (fields)
- Keep herds of animals separated
- Ration feed

*Note:* Use more wires for smaller animals and wild animals. Polytape should be used when greater visibility is required (e.g. horses).

An example of a temporary fence is shown below.

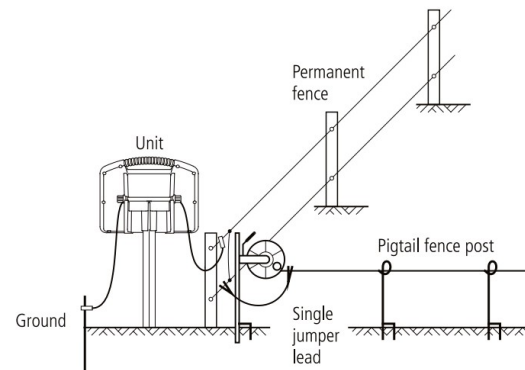

## Safety considerations

### Warning!

- Do not connect to mains-operated or line-operated equipment.
- Remove the battery from the unit before using an external battery charger to recharge the battery.
- Switch the unit off before installation or performing any work on the fence.
- Read all the safety considerations carefully.
- Check your installation to ensure that it complies with all local safety regulations.
- Do not connect simultaneously to a fence and to any other device such as a cattle trainer or a poultry trainer. Otherwise, lightning striking your fence will be conducted to all other devices.

### Notes:

- This product has been designed for use with electric animal fences.
- Keep these instructions in a handy location.

## Safe electric fence construction

### Warning! Read before use.

An electric fence can be hazardous when there is a risk of entrapment or entanglement, or other hazards exist. Serious injury or death may result. Take all steps to avoid the risk of entrapment or entanglement.

The adapter and battery cannot be used at the same time, When using battery, adapter cannot be inserted; When using adapter, Need to unplug the battery

## Danger

- Do not climb through or under an electric fence. If it is necessary to cross an electric fence use a gate or specially designed crossing point.
- Do not allow young or infirm persons to use this unit without supervision. Do not allow young children to play with this unit or near an electric fence or electrified wires.
- Do not electrify barbed wire.
- Do not support off-set electrified wires less than 6" (150 mm) from the vertical plane of a barbed wire fence.
- Do not electrify any fence construction which could lead to entanglement of persons or animals. We recommend for instance, that no more than one electrified off-set wire be supported on either side of a barbed wire or mesh fence.
- Do not supply an electric fence from two units.
- Do not allow electrified wires from two units on the same or adjacent properties to be less than 8' (2.5 m) apart.
- Do not place the unit's ground rod within 33' (10 m) of any part of a power supply ground system or telecommunications ground system.
- Do not run electric fence wires above or close to overhead power or communication lines.

### Cautions :

1. Feature: 2 dew holes at the bottom of the plastic box prevent water from accumulating.
2. When not use, the battery clip should be removed to prevent power consumption.
3. When use AC power, disconnect the battery clips to prevent battery from burning out.
4. When wire clips connect battery, the side with the spring faces up enable remove easily.

## Duty to the public

A warning sign shall be fitted to every point where persons may gain ready access to the conductors.

Where an electric animal fence crosses a public pathway, a non-electrified gate shall be incorporated in the electric animal fence at that point or a crossing by means of stiles shall be provided. At any such crossing, the adjacent electrified wires shall carry warning signs.

Any part of an electric animal fence that is installed along a public road or pathway shall be identified at frequent intervals by warning signs securely fastened to the fence posts or firmly clamped to the fence wires.

- The size of the warning sign shall be at least 4x8" (100x200 mm).
- The background colour of both sides of the warning sign shall be yellow. The inscription on the sign shall be black and shall be either:

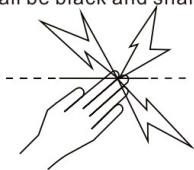

or the substance of "CAUTION: Electric fence".

- The inscription shall be indelible, inscribed on both sides of the warning sign and have a height of at least 1" (25 mm).

## Definition of special terms

Unit/Charger/Energizer – An appliance that is intended to periodically deliver voltage impulses to a fence connected to it.

Fence – A barrier for animals or for the purpose of security, comprising one or more conductors such as metal wires, rods or rails.

Electric fence – A barrier which includes one or more electric conductors, insulated from ground, to which electric pulses are applied by a unit.

Ground rod – Metal structure that is driven into the soil near a unit and connected electrically to the Fence ground terminal of the unit, and that is independent of other grounding arrangements.

Connecting lead – An electric conductor, used to connect the unit to the electric fence or the ground rod.

## Requirements for electric animal fences

Electric animal fences and their ancillary equipment shall be installed, operated and maintained in a manner that minimises danger to persons, animals or their surroundings.

**Warning! Avoid contacting electric fence wires especially with the head, neck or torso. Do not climb over, through or under a multi-wire electric fence. Use a gate or a specially designed crossing point.**

This unit is not intended for use by persons (including children) with reduced physical, sensory or mental capabilities, or lack of experience and knowledge, unless they have been given supervision or instruction concerning use of the unit by a person responsible for their safety.

Children should be supervised to ensure that they do not play with the unit. Electric animal fence constructions that are likely to lead to the entanglement of animals or persons shall be avoided.

An electric animal fence shall not be supplied from two separate units or from independent fence circuits of the same unit.

For any two separate electric animal fences, each supplied from a separate unit independently timed, the distance between the wires of the two electric animal fences shall be at least 8' (2.5 m). If this gap is to be closed, this shall be effected by means of electrically non-conductive material or an isolated metal barrier. Barbed wire or razor wire shall not be electrified by a unit.

A non-electrified fence incorporating barbed wire or razor wire may be used to support one or more off-set electrified wires of an electric animal fence.

supporting devices for the electrified wires shall be constructed so as to ensure that these wires are positioned at a minimum distance of 6" (150 mm) from the vertical plane of the non-electrified wires. The barbed wire and razor wire shall be grounded at regular intervals.

A distance of at least 33' (10 m) shall be maintained between the unit's ground rod and any other grounding system connected parts such as the grounding system for the power supply or the telecommunication system.

Connecting leads that are run inside buildings shall be effectively insulated from the grounded structural parts of the building. This may be achieved by using insulated high voltage cable.

Connecting leads that are run underground shall be run in conduit of insulating material or else insulated high voltage cable shall be used. Care must be taken to avoid damage to the connecting leads due to the effects of animal hooves or vehicle wheels sinking into the ground.

Connecting leads shall not be installed in the same conduit as the AC supply wiring, communication cables or data cables.

Connecting leads and electric animal fence wires shall not cross above overhead power or communication lines.

Crossings with overhead power lines shall be avoided wherever possible. If such a crossing cannot be avoided it shall be made underneath the power line and as nearly as possible at right angles to it.

If connecting leads and electric animal fence wires are installed near an overhead power line, the clearances shall not be less than those shown in the table below.

*Minimum clearances from power lines for electric animal fences*

Power line voltage	Clearance
≤1000 V	10' (3 m)
>1000 V to ≤33,000 V	13' (4 m)
>33,000 V	27' (8 m)

If connecting leads and electric animal fence wires are installed near an overhead power line, their height above the ground shall not exceed 10' (3 m). This height applies to either side of the orthogonal projection of the outermost conductors of the power line on the ground surface, for a distance of:

- 6'6" (2 m) for power lines operating at a nominal voltage not exceeding 1000 V.
- 50' (15 m) for power lines operating at a nominal voltage exceeding 1000 V.

Electric animal fences intended for deterring birds, household pet containment or training animals such as cows need only be supplied from low output units to obtain satisfactory and safe performance.

In electric animal fences intended for deterring birds from roosting on buildings, no electric fence wire shall be connected to the unit's ground rod.

Ensure that all line-operated, ancillary equipment connected to the electric animal fence circuit provides a degree of isolation between the fence circuit and the supply mains equivalent to that provided by the unit.

Protection from the weather shall be provided for the ancillary equipment unless this equipment is certified by the manufacturer as being suitable for use outdoors, and is of a type with a minimum degree of protection IP66.



## Troubleshooting

Problem	Action
The pulse indicator light is flashing, but the electric shock delivered by the fence is weak.	<p>Check that all connections in the fence and ground system are firm and secure. If necessary, clean away any corrosion. Check that the ground rod is pushed firmly into firm ground. Check for faults in the fence-line caused by trees or vegetation. If necessary, remove obstructions and mend the fence.</p> <p>Check that the unit (charger) rating is adequate for the length of the fence. If necessary, reduce the length of the fence or reduce the number of fence wires. Alternatively, divide the fence-line into smaller zones, with each zone powered by a separate unit.</p>
The pulse indicator light is no flashing.	<p>Check that the unit is switched on.</p> <p>If there has been insufficient sunlight to charge the battery, the unit may be in Standby mode. Charge the battery by placing the unit in full sunlight with the solar panel facing true south in the northern hemisphere and true north in the southern hemisphere.</p> <p>Ensure the battery is connected correctly with the positive (red) lead to the positive (+) terminal on the battery and the negative (black) lead to the negative (-) terminal on the battery.</p> <p>Try charging the battery manually using a suitable battery charger. See Battery charging on page 9.</p> <p>Replace the battery with a new battery. Before installing a new battery, charge it fully using a suitable battery charger. If the pulse indicator light is still not flashing, please contact us.</p>

The battery needs frequent replacement.

Check that the solar panel is clean and is not damaged. See Maintenance on page 9.

Make sure the unit is positioned to receive maximum sunlight. If necessary, remove any objects or vegetation that might be casting a shadow on the unit. See Positioning the unit on page 6, or for more detailed information on solar installations.

After the unit is switched on, the pulse indicator light gives three long flashes (2 seconds) then the unit appears to be off.

The unit is in Standby mode because there has been insufficient sunlight to charge the battery. Charge the battery by placing the unit in full sunlight with the solar panel facing true south in the northern hemisphere and true north in the southern hemisphere.

The pulse indicator light flashes quickly several times and then there is a pause.

There may be a problem with the unit. Return the unit to a service agent appointed by

## **Servicing**

*Please contact your local store.*

*Note: If you suspect the unit is not working, always check the battery connection and voltage before proceeding.*

## **Warranty**

This warranty does not cover defects caused by:

- Incorrect input voltage or polarity
- Damage to external wiring
- Physical mishandling
- Water immersion
- Vermin or insect damage

---

*Note:* This product has been manufactured to comply with international safety standards.

---

This product is warranted against faulty material and workmanship for a period of 2 years from date of purchase.

If a warranted defect occurs, return this product with proof of purchase to an authorised service centre.

Note:

- No responsibility is accepted for any accident or damage caused subsequent to any tampering with or modification to or misuse of this product, including (but not limited to) alterations made by anyone other than
- To the maximum extent permitted by law, this warranty is exclusive, personal to you and in lieu of all other warranties, representations or conditions relating to this product (whether express or implied and whenever arising) whether originating by statute, law, trade, custom or otherwise.
- The product warranty is only valid in the original country of purchase. Any claims made in another country may incur full repair costs at the owner's expense.

**VEVOR**®  
**TOUGH TOOLS, HALF PRICE**





**VEVOR**<sup>®</sup>  
TOUGH TOOLS, HALF PRICE

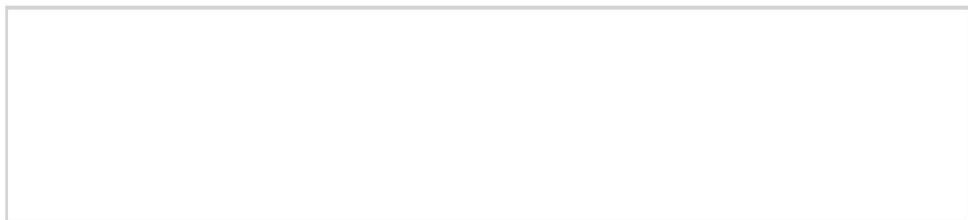



Electric Netting (1pc)



Net Repair Kit (1set)



Wire Hanging Kit (2sets)



Warning Sign (1pc)



Solar Energizer (1pc)



Alligator clips (1set)



12KV Lead-acid battery



12KV Fence Tester (1pc)



Earth Rod (1pc)



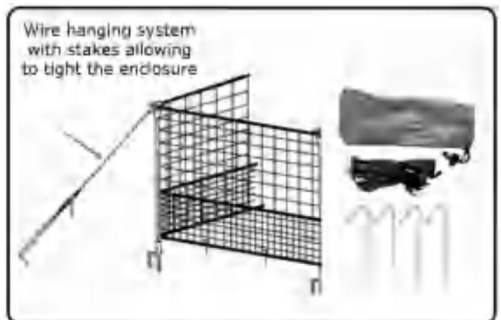

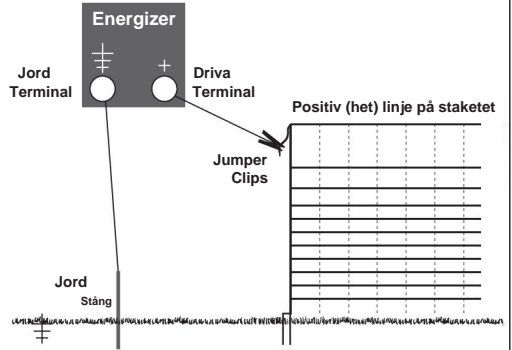

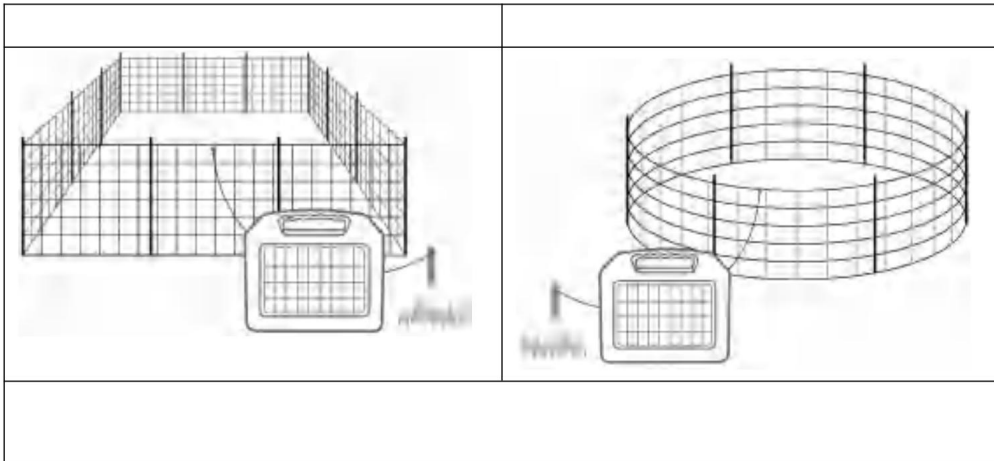

ANTAL NET FÖTTER REKOMMENDERAD ENERGIZER		
1	120 fot	10 Mile, 10 Acre
2	240 fot	20 Mile, 20 Acre
3	360 fot	30 Mile, 30 Acre
4	480 fot	40 Mile, 40 Acre



FÖRSIKTIGHET







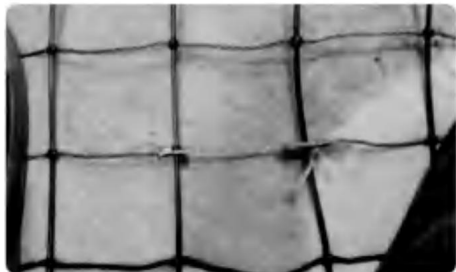
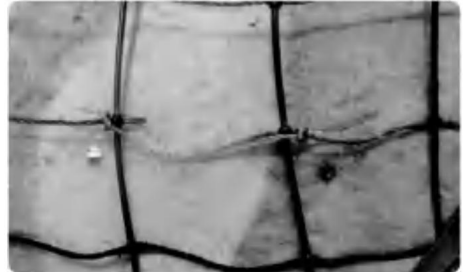
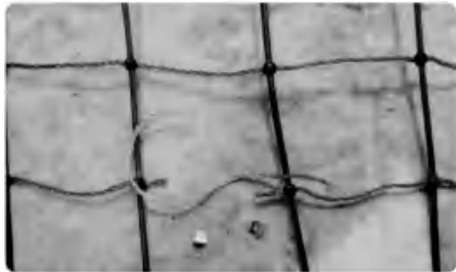
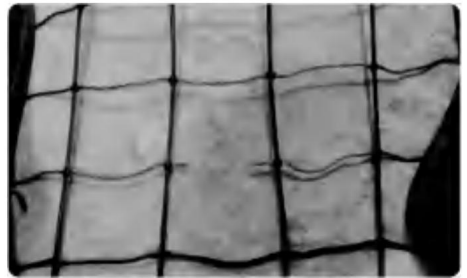
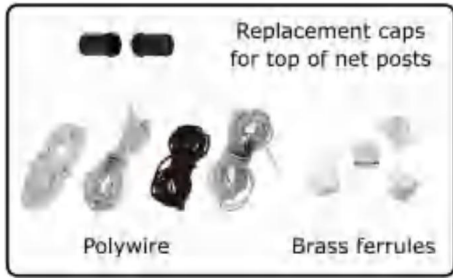

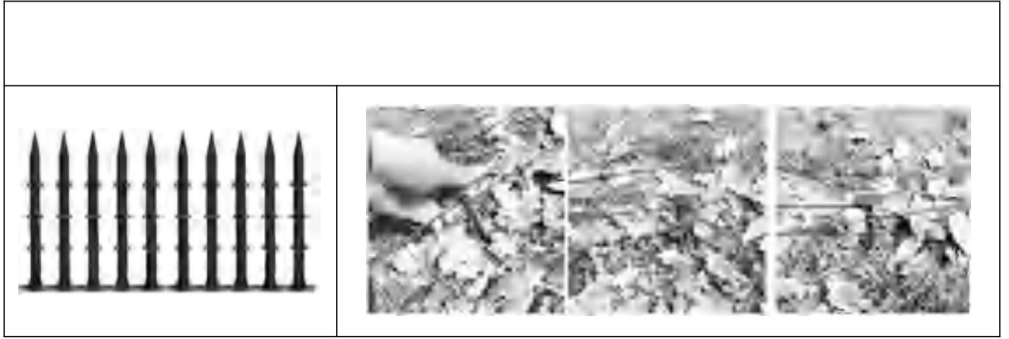



: Shuangchenglu 803nong11hao1602A-1609shi, baoshanqu  
, shanghai 200 000 CN.

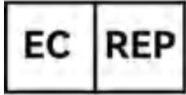

E-CrossStu GmbH.  
Mainzer Landstr.69, 60329 Frankfurt am Main.



YH CONSULTING LIMITED.  
C/O YH Consulting Limited Office 147, Centurion House,  
London Road, Staines-upon-Thames, Surrey, TW18 4AX



**VEVOR**<sup>®</sup>  
TOUGH TOOLS, HALF PRICE

# **ELECTRIC FENCE ENERGIZER USER MANUAL**

## **WARNING: READ ALL INSTRUCTIONS**

If you suspect that the unit is not working, follow these steps:

1. Disconnect the unit from the fence and check that the indicator light is flashing.
2. Check the battery connection and voltage.
3. Check that the voltage between the live and ground terminals is greater than 7000 V, using a fence voltage tester.
4. If these tests are OK, you have an installation problem.

**Consult your user manual for installation  
and operating instructions**

# **CONTENTS**

Product Details	01
Key to symbols on the unit	03
Description	05
Installation	05
Battery information	07
Positioning the unit	10
Safety considerations	11
Troubleshooting	17
Servicing	19
Warranty	19



# Product Details

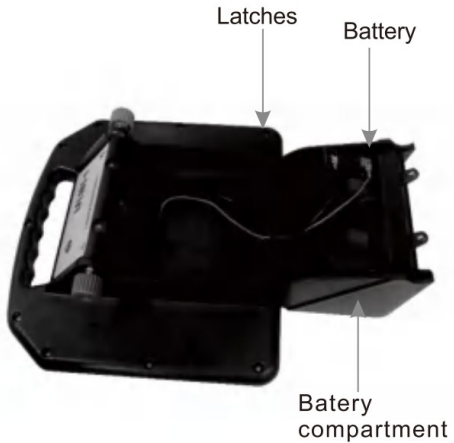
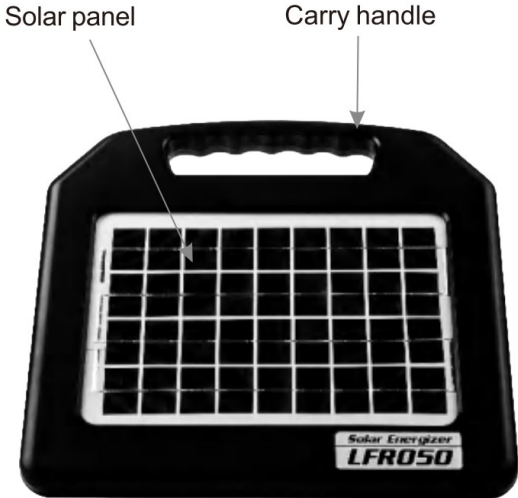

# Product Details

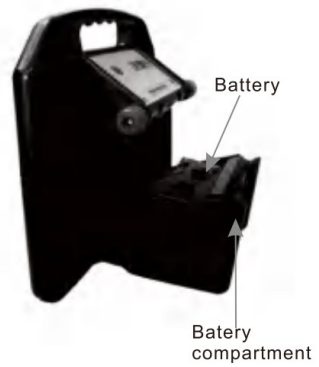
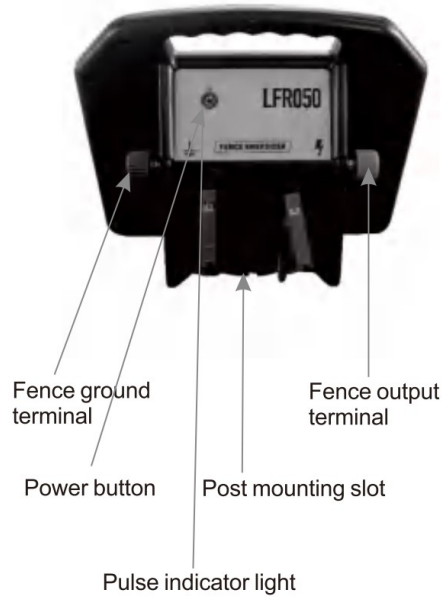

## Key to symbols on the unit

 Fence ground terminal (green). Connect the fence ground terminal to the ground system.

 Fence output terminal (red). Connect the fence output terminal to the fence.

 Risk of electric shock! This unit should be opened or repaired only by qualified personnel. No user serviceable parts.

 Read full instructions before use.



This symbol on the product or its packaging indicates that this product must not be disposed of with other waste. Instead, it is your responsibility to dispose of your waste equipment by handing it over to a designated collection point for the recycling of waste electrical and electronic equipment. The separate collection and recycling of your waste equipment at the time of disposal will help conserve natural resources and ensure that it is recycled in a manner that protects human health and the environment. For more information about where you can drop off your waste equipment for recycling, please contact your local city recycling office or the dealer from whom you purchased the product.

## Before first use

Units may be supplied with or without a battery, depending on your region. If a battery has been supplied, it will be inside the battery compartment with the positive terminal disconnected.

Before using the unit for the first time, you must:

- 1 Insert a battery into the battery compartment (if necessary).
- 2 Connect the battery terminals.
- 3 Charge the battery by placing the unit in full sunlight for three days with the solar panel facing true south in the northern hemisphere and true north in the southern hemisphere.

## LFR050-Battery

1. Place the unit on a flat surface (handle downwards as shown). Open the battery compartment by unscrewing the screws on the back.



2. Insert a battery (if necessary).
3. Connect the positive (red) lead to the positive (+) terminal on the battery. Connect the negative (black) lead to the negative (-) terminal on the battery (if necessary).
4. Close the battery compartment, ensuring that the latches are securely fastened.

**Caution!** When connecting the battery, be careful not to short circuit the supply terminals.

## Description

---

Power output at 500 ohms: 0.5J  
Delivered power vacuum: 0.63J  
Effective square meter: 50 Acres  
Effective length: 20 Miles  
Solar Consumption: 47 mA  
Voltage Vacuum: 10KV Max  
Waterproof Rating: IP65 Outdoor Use  
Power Source Battery: DC 12V/8AH(including)  
Operates Days without Sunlight: UP 2 weeks  
Polysilicon Solar Panel Voltage Output(Vmp): DC 18V  
Polysilicon Solar Panel Current Output(Imp): 0.28A  
Polysilicon Solar Panel Power Output(Pmax): 5W  
Solar Panel Size: 303\*213mm  
Plastic case Dimensions: 37.5\*22\*30cm  
G.W.: 3KGS  
Product including one AC/DC adapter,two alligator clips

## Installation

### Positioning the unit

---

Install the unit:

- adjacent to the electric fence
- preferably in the middle of the electric fence
- where it will receive the most daily sun throughout the season
- where a good ground can be obtained
- away from flooding and out of reach of animals and children (inside a protective fence, if required)
- with the solar panel facing true south in the northern hemisphere and true north in the southern hemisphere.

### Mounting the unit

---

The unit may be placed directly onto a flat surface or mounted directly onto a steel Y-post or T-post using the post-mounting slot.

## Connecting to an electric fence

## Pulse indicator light

The pulse indicator light indicates the output pulse speed. The pulse speed varies according to the battery charge level:

Battery charge level	Typical pulse speed
Normal	A pulse every 1.5 seconds
Low	A pulse every 3 seconds

## Standby mode

An intelligent battery management feature puts the unit into Standby mode when battery charge falls below a 'safe operating level'. When in Standby mode, the unit is still on, but it will not deliver a pulse to the electric fence.

The unit will resume delivering pulses when the solar panel has charged the battery so that it is above 'safe operating level'.

When operation resumes, the battery charge level will still be low, so the unit will deliver one pulse every 3 seconds. Once the battery reaches normal charge level, the pulse will revert to one pulse every 1.5 seconds.

## Battery information

### Battery charging

The solar panel can fully charge a flat battery in two weeks, provided the unit is switched off and there is adequate sunlight. A battery charger may also be used to charge the battery. Use a battery charger suitable for charging sealed, lead-acid batteries.

## Battery charger details

Warning! The battery must be disconnected and removed from the unit before connecting it to a battery charger.

Model	Battery type being charged	Battery charger requirements
LFR050	12 V	13.8 V, $\leq 1$ A

When fully charged, the battery should be able to power the unit for up to three weeks. To fit into the battery box, battery dimensions should be within 15\*6.5\*9.5 cm / L\*W\*H

## Replacing the battery

If a replacement battery is required, use a sealed lead-acid battery.

Warning! Do not use a non-rechargeable battery.

### Replacement battery details

Model	Suitable battery type
LFR050	12 V, 8 Ah battery

Do not dispose of the battery in a land-fill or in a fire.

In the event of a spill or leakage from a sealed lead-acid battery:

- Contain small spills with dry sand, soil and vermiculite. Do not use combustible materials. If possible, carefully neutralize spilled electrolyte with soda ash, sodium bicarbonate, lime, etc.
- Wear acid-resistant clothing, boots, gloves and a face shield.
- Do not let un-neutralised acid get into the sewerage system.

Neutralized acid must be managed in accordance with approved local, state and federal requirements. Consult your state environmental agency and/or federal EPA.

## Maintenance

Clean the solar panel regularly with a soft cloth using glass cleaner or a mild solution of detergent and water. This will ensure the solar panel functions efficiently.

When transporting the unit, protect the solar panel to prevent the glass surface from being damaged.

## Storage

If the unit is stored for extended periods, the battery can discharge and become damaged.

The unit should be stored inside, next to a window, where sunlight can shine on the unit each day.

If the unit cannot be stored in a sunny position, it should be kept in a cool place. The battery should be fully charged and disconnected from the unit. The battery should be recharged manually every six months using a suitable battery charger.

## Positioning the unit

A temporary fence can be quickly erected and easily moved allowing the farmer to:

- Make smaller paddocks (fields)
- Keep herds of animals separated
- Ration feed

*Note:* Use more wires for smaller animals and wild animals. Polytape should be used when greater visibility is required (e.g. horses).

An example of a temporary fence is shown below.

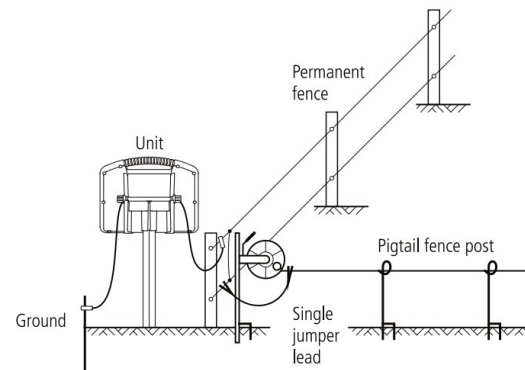



## Safety considerations

### Warning!

- Do not connect to mains-operated or line-operated equipment.
- Remove the battery from the unit before using an external battery charger to recharge the battery.
- Switch the unit off before installation or performing any work on the fence.
- Read all the safety considerations carefully.
- Check your installation to ensure that it complies with all local safety regulations.
- Do not connect simultaneously to a fence and to any other device such as a cattle trainer or a poultry trainer. Otherwise, lightning striking your fence will be conducted to all other devices.

### Notes:

- This product has been designed for use with electric animal fences.
- Keep these instructions in a handy location.

## Safe electric fence construction

### Warning! Read before use.

An electric fence can be hazardous when there is a risk of entrapment or entanglement, or other hazards exist. Serious injury or death may result. Take all steps to avoid the risk of entrapment or entanglement.

The adapter and battery cannot be used at the same time, When using battery, adapter cannot be inserted; When using adapter, Need to unplug the battery

## Danger

- Do not climb through or under an electric fence. If it is necessary to cross an electric fence use a gate or specially designed crossing point.
- Do not allow young or infirm persons to use this unit without supervision. Do not allow young children to play with this unit or near an electric fence or electrified wires.
- Do not electrify barbed wire.
- Do not support off-set electrified wires less than 6" (150 mm) from the vertical plane of a barbed wire fence.
- Do not electrify any fence construction which could lead to entanglement of persons or animals. We recommend for instance, that no more than one electrified off-set wire be supported on either side of a barbed wire or mesh fence.
- Do not supply an electric fence from two units.
- Do not allow electrified wires from two units on the same or adjacent properties to be less than 8' (2.5 m) apart.
- Do not place the unit's ground rod within 33' (10 m) of any part of a power supply ground system or telecommunications ground system.
- Do not run electric fence wires above or close to overhead power or communication lines.

### Cautions :

1. Feature: 2 dew holes at the bottom of the plastic box prevent water from accumulating.
2. When not use, the battery clip should be removed to prevent power consumption.
3. When use AC power, disconnect the battery clips to prevent battery from burning out.
4. When wire clips connect battery, the side with the spring faces up enable remove easily.

## Duty to the public

A warning sign shall be fitted to every point where persons may gain ready access to the conductors.

Where an electric animal fence crosses a public pathway, a non-electrified gate shall be incorporated in the electric animal fence at that point or a crossing by means of stiles shall be provided. At any such crossing, the adjacent electrified wires shall carry warning signs.

Any part of an electric animal fence that is installed along a public road or pathway shall be identified at frequent intervals by warning signs securely fastened to the fence posts or firmly clamped to the fence wires.

- The size of the warning sign shall be at least 4x8" (100x200 mm).
- The background colour of both sides of the warning sign shall be yellow. The inscription on the sign shall be black and shall be either:

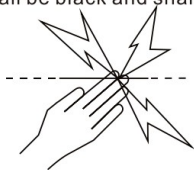

or the substance of "CAUTION: Electric fence".

- The inscription shall be indelible, inscribed on both sides of the warning sign and have a height of at least 1" (25 mm).

## Definition of special terms

Unit/Charger/Energizer – An appliance that is intended to periodically deliver voltage impulses to a fence connected to it.

Fence – A barrier for animals or for the purpose of security, comprising one or more conductors such as metal wires, rods or rails.

Electric fence – A barrier which includes one or more electric conductors, insulated from ground, to which electric pulses are applied by a unit.

Ground rod – Metal structure that is driven into the soil near a unit and connected electrically to the Fence ground terminal of the unit, and that is independent of other grounding arrangements.

Connecting lead – An electric conductor, used to connect the unit to the electric fence or the ground rod.

## Requirements for electric animal fences

Electric animal fences and their ancillary equipment shall be installed, operated and maintained in a manner that minimises danger to persons, animals or their surroundings.

**Warning! Avoid contacting electric fence wires especially with the head, neck or torso. Do not climb over, through or under a multi-wire electric fence. Use a gate or a specially designed crossing point.**

This unit is not intended for use by persons (including children) with reduced physical, sensory or mental capabilities, or lack of experience and knowledge, unless they have been given supervision or instruction concerning use of the unit by a person responsible for their safety.

Children should be supervised to ensure that they do not play with the unit. Electric animal fence constructions that are likely to lead to the entanglement of animals or persons shall be avoided.

An electric animal fence shall not be supplied from two separate units or from independent fence circuits of the same unit.

For any two separate electric animal fences, each supplied from a separate unit independently timed, the distance between the wires of the two electric animal fences shall be at least 8' (2.5 m). If this gap is to be closed, this shall be effected by means of electrically non-conductive material or an isolated metal barrier. Barbed wire or razor wire shall not be electrified by a unit.

A non-electrified fence incorporating barbed wire or razor wire may be used to support one or more off-set electrified wires of an electric animal fence.

supporting devices for the electrified wires shall be constructed so as to ensure that these wires are positioned at a minimum distance of 6" (150 mm) from the vertical plane of the non-electrified wires. The barbed wire and razor wire shall be grounded at regular intervals.

A distance of at least 33' (10 m) shall be maintained between the unit's ground rod and any other grounding system connected parts such as the grounding system for the power supply or the telecommunication system.

Connecting leads that are run inside buildings shall be effectively insulated from the grounded structural parts of the building. This may be achieved by using insulated high voltage cable.

Connecting leads that are run underground shall be run in conduit of insulating material or else insulated high voltage cable shall be used. Care must be taken to avoid damage to the connecting leads due to the effects of animal hooves or vehicle wheels sinking into the ground.

Connecting leads shall not be installed in the same conduit as the AC supply wiring, communication cables or data cables.

Connecting leads and electric animal fence wires shall not cross above overhead power or communication lines.

Crossings with overhead power lines shall be avoided wherever possible. If such a crossing cannot be avoided it shall be made underneath the power line and as nearly as possible at right angles to it.

If connecting leads and electric animal fence wires are installed near an overhead power line, the clearances shall not be less than those shown in the table below.

*Minimum clearances from power lines for electric animal fences*

Power line voltage	Clearance
≤1000 V	10' (3 m)
>1000 V to ≤33,000 V	13' (4 m)
>33,000 V	27' (8 m)

If connecting leads and electric animal fence wires are installed near an overhead power line, their height above the ground shall not exceed 10' (3 m). This height applies to either side of the orthogonal projection of the outermost conductors of the power line on the ground surface, for a distance of:

- 6'6" (2 m) for power lines operating at a nominal voltage not exceeding 1000 V.
- 50' (15 m) for power lines operating at a nominal voltage exceeding 1000 V.

Electric animal fences intended for deterring birds, household pet containment or training animals such as cows need only be supplied from low output units to obtain satisfactory and safe performance.

In electric animal fences intended for deterring birds from roosting on buildings, no electric fence wire shall be connected to the unit's ground rod.

Ensure that all line-operated, ancillary equipment connected to the electric animal fence circuit provides a degree of isolation between the fence circuit and the supply mains equivalent to that provided by the unit.

Protection from the weather shall be provided for the ancillary equipment unless this equipment is certified by the manufacturer as being suitable for use outdoors, and is of a type with a minimum degree of protection IP66.



## Troubleshooting

Problem	Action
The pulse indicator light is flashing, but the electric shock delivered by the fence is weak.	<p>Check that all connections in the fence and ground system are firm and secure. If necessary, clean away any corrosion. Check that the ground rod is pushed firmly into firm ground. Check for faults in the fence-line caused by trees or vegetation. If necessary, remove obstructions and mend the fence.</p> <p>Check that the unit (charger) rating is adequate for the length of the fence. If necessary, reduce the length of the fence or reduce the number of fence wires. Alternatively, divide the fence-line into smaller zones, with each zone powered by a separate unit.</p>
The pulse indicator light is no flashing.	<p>Check that the unit is switched on.</p> <p>If there has been insufficient sunlight to charge the battery, the unit may be in Standby mode. Charge the battery by placing the unit in full sunlight with the solar panel facing true south in the northern hemisphere and true north in the southern hemisphere.</p> <p>Ensure the battery is connected correctly with the positive (red) lead to the positive (+) terminal on the battery and the negative (black) lead to the negative (-) terminal on the battery.</p> <p>Try charging the battery manually using a suitable battery charger. See Battery charging on page 9.</p> <p>Replace the battery with a new battery. Before installing a new battery, charge it fully using a suitable battery charger. If the pulse indicator light is still not flashing, please contact us.</p>

The battery needs frequent replacement.

Check that the solar panel is clean and is not damaged. See Maintenance on page 9.

Make sure the unit is positioned to receive maximum sunlight. If necessary, remove any objects or vegetation that might be casting a shadow on the unit. See Positioning the unit on page 6, or for more detailed information on solar installations.

After the unit is switched on, the pulse indicator light gives three long flashes (2 seconds) then the unit appears to be off.

The unit is in Standby mode because there has been insufficient sunlight to charge the battery. Charge the battery by placing the unit in full sunlight with the solar panel facing true south in the northern hemisphere and true north in the southern hemisphere.

The pulse indicator light flashes quickly several times and then there is a pause.

There may be a problem with the unit. Return the unit to a service agent appointed by

## **Servicing**

*Please contact your local store.*

*Note: If you suspect the unit is not working, always check the battery connection and voltage before proceeding.*

## **Warranty**

This warranty does not cover defects caused by:

- Incorrect input voltage or polarity
- Damage to external wiring
- Physical mishandling
- Water immersion
- Vermin or insect damage

---

*Note:* This product has been manufactured to comply with international safety standards.

---

This product is warranted against faulty material and workmanship for a period of 2 years from date of purchase.

If a warranted defect occurs, return this product with proof of purchase to an authorised service centre.

Note:

- No responsibility is accepted for any accident or damage caused subsequent to any tampering with or modification to or misuse of this product, including (but not limited to) alterations made by anyone other than
- To the maximum extent permitted by law, this warranty is exclusive, personal to you and in lieu of all other warranties, representations or conditions relating to this product (whether express or implied and whenever arising) whether originating by statute, law, trade, custom or otherwise.
- The product warranty is only valid in the original country of purchase. Any claims made in another country may incur full repair costs at the owner's expense.

**VEVOR<sup>®</sup>**

**TOUGH TOOLS, HALF PRICE**



**VEVOR**<sup>®</sup>  
TOUGH TOOLS, HALF PRICE

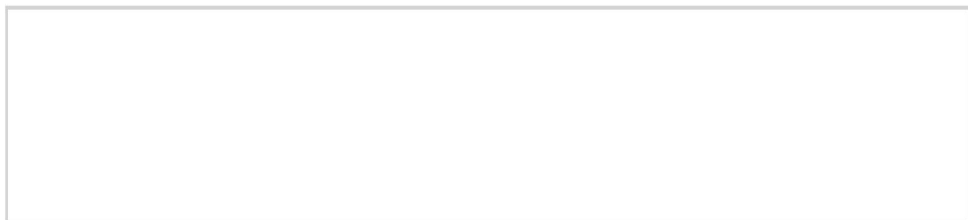



Electric Netting (1pc)



Net Repair Kit (1set)



Wire Hanging Kit (2sets)



Warning Sign (1pc)



Solar Energizer (1pc)



Alligator clips (1set)



12KV Lead-acid battery



12KV Fence Tester (1pc)



Earth Rod (1pc)





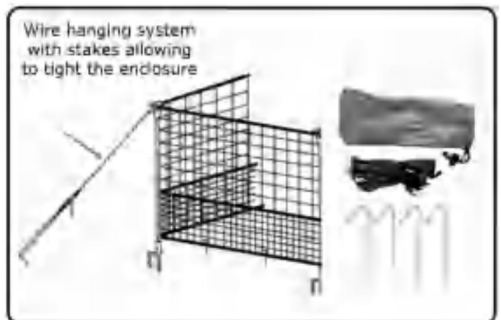

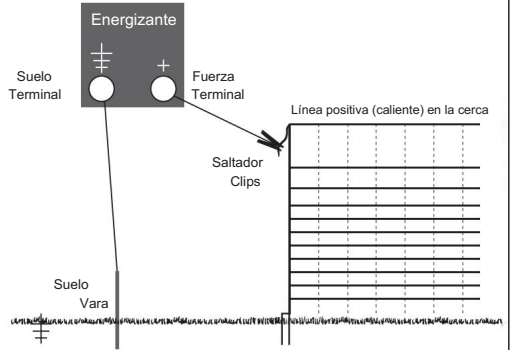

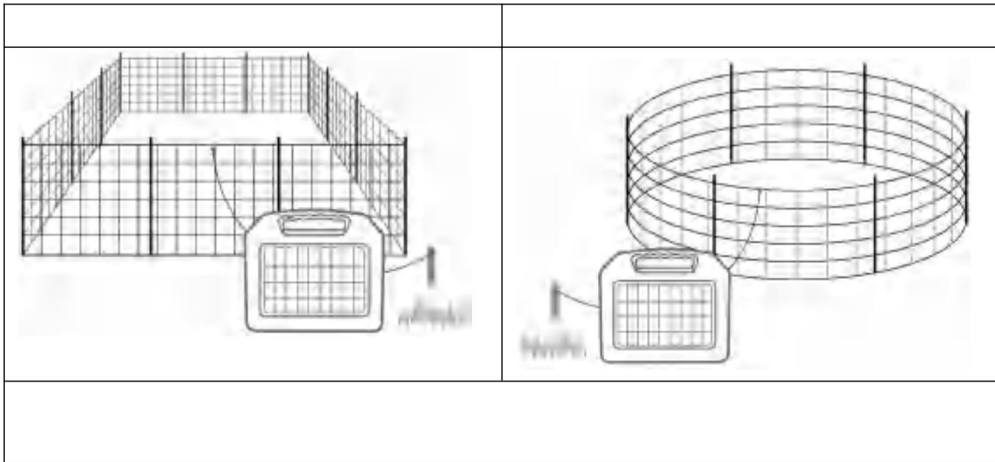

**NÚMERO DE REDES PIES ENERGIZANTE RECOMENDADO**

1	120 pies.	10 millas, 10 acres
2	240 pies.	20 millas, 20 acres
3	360 pies.	30 millas, 30 acres
4	480 pies.	40 millas, 40 acres



PRECAUCIÓN





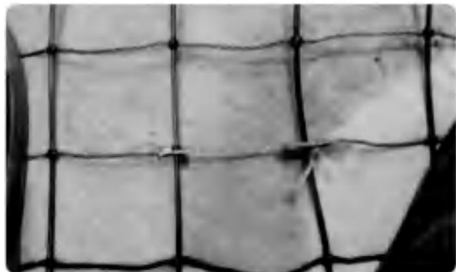
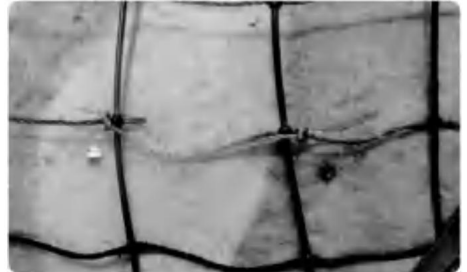
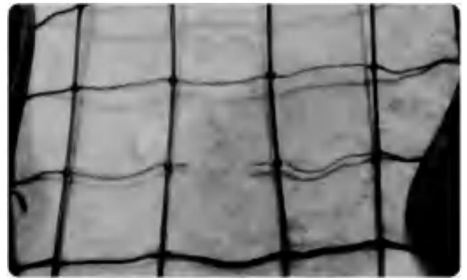
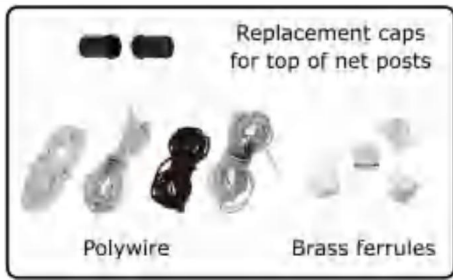





: Shuangchenglu 803nong11hao1602A-1609shi, baoshanqu  
, Shanghai 200000 CN.

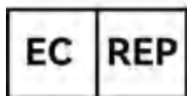

Empresa E-CrossStu GmbH.  
Mainzer Landstr.69, 60329 Fráncfort del Meno.

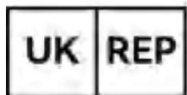

YH CONSULTING LIMITADA.  
C/O YH Consulting Limited Oficina 147, Centurion House,  
Carretera de Londres, Staines-upon-Thames, Surrey, TW18 4AX





**VEVOR**®  
TOUGH TOOLS, HALF PRICE

# **ELECTRIC FENCE ENERGIZER USER MANUAL**

## **WARNING: READ ALL INSTRUCTIONS**

If you suspect that the unit is not working, follow these steps:

1. Disconnect the unit from the fence and check that the indicator light is flashing.
2. Check the battery connection and voltage.
3. Check that the voltage between the live and ground terminals is greater than 7000 V, using a fence voltage tester.
4. If these tests are OK, you have an installation problem.

**Consult your user manual for installation  
and operating instructions**

# **CONTENTS**

Product Details	01
Key to symbols on the unit	03
Description	05
Installation	05
Battery information	07
Positioning the unit	10
Safety considerations	11
Troubleshooting	17
Servicing	19
Warranty	19

# Product Details

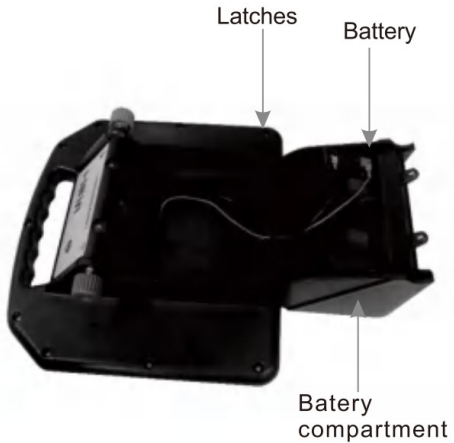
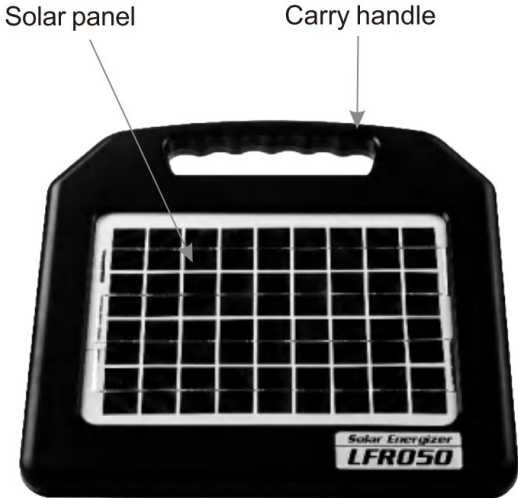

# Product Details

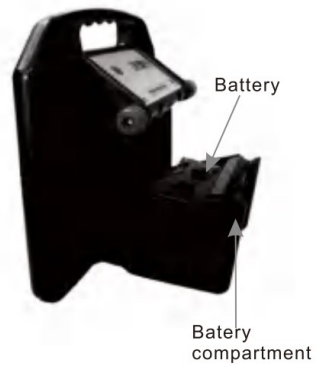
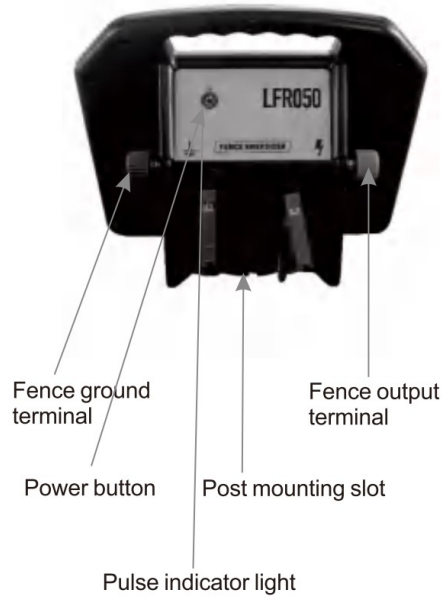

## Key to symbols on the unit

 Fence ground terminal (green). Connect the fence ground terminal to the ground system.

 Fence output terminal (red). Connect the fence output terminal to the fence.



Risk of electric shock! This unit should be opened or repaired only by qualified personnel. No user serviceable parts.



Read full instructions before use.



This symbol on the product or its packaging indicates that this product must not be disposed of with other waste. Instead, it is your responsibility to dispose of your waste equipment by handing it over to a designated collection point for the recycling of waste electrical and electronic equipment. The separate collection and recycling of your waste equipment at the time of disposal will help conserve natural resources and ensure that it is recycled in a manner that protects human health and the environment. For more information about where you can drop off your waste equipment for recycling, please contact your local city recycling office or the dealer from whom you purchased the product.

## Before first use

Units may be supplied with or without a battery, depending on your region. If a battery has been supplied, it will be inside the battery compartment with the positive terminal disconnected.

Before using the unit for the first time, you must:

- 1 Insert a battery into the battery compartment (if necessary).
- 2 Connect the battery terminals.
- 3 Charge the battery by placing the unit in full sunlight for three days with the solar panel facing true south in the northern hemisphere and true north in the southern hemisphere.

## LFR050-Battery

1. Place the unit on a flat surface (handle downwards as shown). Open the battery compartment by unscrewing the screws on the back.



2. Insert a battery (if necessary).
3. Connect the positive (red) lead to the positive (+) terminal on the battery. Connect the negative (black) lead to the negative (-) terminal on the battery (if necessary).
4. Close the battery compartment, ensuring that the latches are securely fastened.

**Caution!** When connecting the battery, be careful not to short circuit the supply terminals.

## Description

---

Power output at 500 ohms: 0.5J  
Delivered power vacuum: 0.63J  
Effective square meter: 50 Acres  
Effective length: 20 Miles  
Solar Consumption: 47 mA  
Voltage Vacuum: 10KV Max  
Waterproof Rating: IP65 Outdoor Use  
Power Source Battery: DC 12V/8AH(including)  
Operates Days without Sunlight: UP 2 weeks  
Polysilicon Solar Panel Voltage Output(Vmp): DC 18V  
Polysilicon Solar Panel Current Output(Imp): 0.28A  
Polysilicon Solar Panel Power Output(Pmax): 5W  
Solar Panel Size: 303\*213mm  
Plastic case Dimensions: 37.5\*22\*30cm  
G.W.: 3KGS  
Product including one AC/DC adapter,two alligator clips

## Installation

### Positioning the unit

---

Install the unit:

- adjacent to the electric fence
- preferably in the middle of the electric fence
- where it will receive the most daily sun throughout the season
- where a good ground can be obtained
- away from flooding and out of reach of animals and children (inside a protective fence, if required)
- with the solar panel facing true south in the northern hemisphere and true north in the southern hemisphere.

### Mounting the unit

---

The unit may be placed directly onto a flat surface or mounted directly onto a steel Y-post or T-post using the post-mounting slot.

## Connecting to an electric fence

## Pulse indicator light

The pulse indicator light indicates the output pulse speed. The pulse speed varies according to the battery charge level:

Battery charge level	Typical pulse speed
Normal	A pulse every 1.5 seconds
Low	A pulse every 3 seconds

## Standby mode

An intelligent battery management feature puts the unit into Standby mode when battery charge falls below a 'safe operating level'. When in Standby mode, the unit is still on, but it will not deliver a pulse to the electric fence.

The unit will resume delivering pulses when the solar panel has charged the battery so that it is above 'safe operating level'.

When operation resumes, the battery charge level will still be low, so the unit will deliver one pulse every 3 seconds. Once the battery reaches normal charge level, the pulse will revert to one pulse every 1.5 seconds.

## Battery information

### Battery charging

The solar panel can fully charge a flat battery in two weeks, provided the unit is switched off and there is adequate sunlight. A battery charger may also be used to charge the battery. Use a battery charger suitable for charging sealed, lead-acid batteries.

## Battery charger details

Warning! The battery must be disconnected and removed from the unit before connecting it to a battery charger.

Model	Battery type being charged	Battery charger requirements
LFR050	12 V	13.8 V, $\leq 1$ A

When fully charged, the battery should be able to power the unit for up to three weeks. To fit into the battery box, battery dimensions should be within 15\*6.5\*9.5 cm / L\*W\*H

## Replacing the battery

If a replacement battery is required, use a sealed lead-acid battery.

Warning! Do not use a non-rechargeable battery.

### Replacement battery details

Model	Suitable battery type
-------	-----------------------

LFR050 12 V, 8 Ah battery

Do not dispose of the battery in a land-fill or in a fire.

In the event of a spill or leakage from a sealed lead-acid battery:

- Contain small spills with dry sand, soil and vermiculite. Do not use combustible materials. If possible, carefully neutralize spilled electrolyte with soda ash, sodium bicarbonate, lime, etc.
- Wear acid-resistant clothing, boots, gloves and a face shield.
- Do not let un-neutralised acid get into the sewerage system.



Neutralized acid must be managed in accordance with approved local, state and federal requirements. Consult your state environmental agency and/or federal EPA.

## Maintenance

Clean the solar panel regularly with a soft cloth using glass cleaner or a mild solution of detergent and water. This will ensure the solar panel functions efficiently.

When transporting the unit, protect the solar panel to prevent the glass surface from being damaged.

## Storage

If the unit is stored for extended periods, the battery can discharge and become damaged.

The unit should be stored inside, next to a window, where sunlight can shine on the unit each day.

If the unit cannot be stored in a sunny position, it should be kept in a cool place. The battery should be fully charged and disconnected from the unit. The battery should be recharged manually every six months using a suitable battery charger.

## Positioning the unit

A temporary fence can be quickly erected and easily moved allowing the farmer to:

- Make smaller paddocks (fields)
- Keep herds of animals separated
- Ration feed

*Note:* Use more wires for smaller animals and wild animals. Polytape should be used when greater visibility is required (e.g. horses).

An example of a temporary fence is shown below.

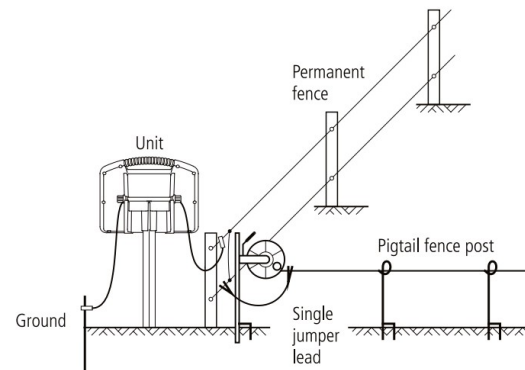

## Safety considerations

### Warning!

- Do not connect to mains-operated or line-operated equipment.
- Remove the battery from the unit before using an external battery charger to recharge the battery.
- Switch the unit off before installation or performing any work on the fence.
- Read all the safety considerations carefully.
- Check your installation to ensure that it complies with all local safety regulations.
- Do not connect simultaneously to a fence and to any other device such as a cattle trainer or a poultry trainer. Otherwise, lightning striking your fence will be conducted to all other devices.

### Notes:

- This product has been designed for use with electric animal fences.
- Keep these instructions in a handy location.

## Safe electric fence construction

### Warning! Read before use.

An electric fence can be hazardous when there is a risk of entrapment or entanglement, or other hazards exist. Serious injury or death may result. Take all steps to avoid the risk of entrapment or entanglement.

The adapter and battery cannot be used at the same time, When using battery, adapter cannot be inserted; When using adapter, Need to unplug the battery

## Danger

- Do not climb through or under an electric fence. If it is necessary to cross an electric fence use a gate or specially designed crossing point.
- Do not allow young or infirm persons to use this unit without supervision. Do not allow young children to play with this unit or near an electric fence or electrified wires.
- Do not electrify barbed wire.
- Do not support off-set electrified wires less than 6" (150 mm) from the vertical plane of a barbed wire fence.
- Do not electrify any fence construction which could lead to entanglement of persons or animals. We recommend for instance, that no more than one electrified off-set wire be supported on either side of a barbed wire or mesh fence.
- Do not supply an electric fence from two units.
- Do not allow electrified wires from two units on the same or adjacent properties to be less than 8' (2.5 m) apart.
- Do not place the unit's ground rod within 33' (10 m) of any part of a power supply ground system or telecommunications ground system.
- Do not run electric fence wires above or close to overhead power or communication lines.

### Cautions :

1. Feature: 2 dew holes at the bottom of the plastic box prevent water from accumulating.
2. When not use, the battery clip should be removed to prevent power consumption.
3. When use AC power, disconnect the battery clips to prevent battery from burning out.
4. When wire clips connect battery, the side with the spring faces up enable remove easily.

## Duty to the public

A warning sign shall be fitted to every point where persons may gain ready access to the conductors.

Where an electric animal fence crosses a public pathway, a non-electrified gate shall be incorporated in the electric animal fence at that point or a crossing by means of stiles shall be provided. At any such crossing, the adjacent electrified wires shall carry warning signs.

Any part of an electric animal fence that is installed along a public road or pathway shall be identified at frequent intervals by warning signs securely fastened to the fence posts or firmly clamped to the fence wires.

- The size of the warning sign shall be at least 4x8" (100x200 mm).
- The background colour of both sides of the warning sign shall be yellow. The inscription on the sign shall be black and shall be either:

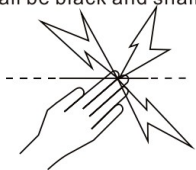

or the substance of "CAUTION: Electric fence".

- The inscription shall be indelible, inscribed on both sides of the warning sign and have a height of at least 1" (25 mm).

## Definition of special terms

Unit/Charger/Energizer – An appliance that is intended to periodically deliver voltage impulses to a fence connected to it.

Fence – A barrier for animals or for the purpose of security, comprising one or more conductors such as metal wires, rods or rails.

Electric fence – A barrier which includes one or more electric conductors, insulated from ground, to which electric pulses are applied by a unit.

Ground rod – Metal structure that is driven into the soil near a unit and connected electrically to the Fence ground terminal of the unit, and that is independent of other grounding arrangements.

Connecting lead – An electric conductor, used to connect the unit to the electric fence or the ground rod.

## Requirements for electric animal fences

Electric animal fences and their ancillary equipment shall be installed, operated and maintained in a manner that minimises danger to persons, animals or their surroundings.

**Warning! Avoid contacting electric fence wires especially with the head, neck or torso. Do not climb over, through or under a multi-wire electric fence. Use a gate or a specially designed crossing point.**

This unit is not intended for use by persons (including children) with reduced physical, sensory or mental capabilities, or lack of experience and knowledge, unless they have been given supervision or instruction concerning use of the unit by a person responsible for their safety.

Children should be supervised to ensure that they do not play with the unit. Electric animal fence constructions that are likely to lead to the entanglement of animals or persons shall be avoided.

An electric animal fence shall not be supplied from two separate units or from independent fence circuits of the same unit.

For any two separate electric animal fences, each supplied from a separate unit independently timed, the distance between the wires of the two electric animal fences shall be at least 8' (2.5 m). If this gap is to be closed, this shall be effected by means of electrically non-conductive material or an isolated metal barrier. Barbed wire or razor wire shall not be electrified by a unit.

A non-electrified fence incorporating barbed wire or razor wire may be used to support one or more off-set electrified wires of an electric animal fence.

supporting devices for the electrified wires shall be constructed so as to ensure that these wires are positioned at a minimum distance of 6" (150 mm) from the vertical plane of the non-electrified wires. The barbed wire and razor wire shall be grounded at regular intervals.

A distance of at least 33' (10 m) shall be maintained between the unit's ground rod and any other grounding system connected parts such as the grounding system for the power supply or the telecommunication system.

Connecting leads that are run inside buildings shall be effectively insulated from the grounded structural parts of the building. This may be achieved by using insulated high voltage cable.

Connecting leads that are run underground shall be run in conduit of insulating material or else insulated high voltage cable shall be used. Care must be taken to avoid damage to the connecting leads due to the effects of animal hooves or vehicle wheels sinking into the ground.

Connecting leads shall not be installed in the same conduit as the AC supply wiring, communication cables or data cables.

Connecting leads and electric animal fence wires shall not cross above overhead power or communication lines.

Crossings with overhead power lines shall be avoided wherever possible. If such a crossing cannot be avoided it shall be made underneath the power line and as nearly as possible at right angles to it.

If connecting leads and electric animal fence wires are installed near an overhead power line, the clearances shall not be less than those shown in the table below.

*Minimum clearances from power lines for electric animal fences*

Power line voltage	Clearance
≤1000 V	10' (3 m)
>1000 V to ≤33,000 V	13' (4 m)
>33,000 V	27' (8 m)

If connecting leads and electric animal fence wires are installed near an overhead power line, their height above the ground shall not exceed 10' (3 m). This height applies to either side of the orthogonal projection of the outermost conductors of the power line on the ground surface, for a distance of:

- 6'6" (2 m) for power lines operating at a nominal voltage not exceeding 1000 V.
- 50' (15 m) for power lines operating at a nominal voltage exceeding 1000 V.

Electric animal fences intended for deterring birds, household pet containment or training animals such as cows need only be supplied from low output units to obtain satisfactory and safe performance.

In electric animal fences intended for deterring birds from roosting on buildings, no electric fence wire shall be connected to the unit's ground rod.

Ensure that all line-operated, ancillary equipment connected to the electric animal fence circuit provides a degree of isolation between the fence circuit and the supply mains equivalent to that provided by the unit.

Protection from the weather shall be provided for the ancillary equipment unless this equipment is certified by the manufacturer as being suitable for use outdoors, and is of a type with a minimum degree of protection IP66.



## Troubleshooting

Problem	Action
The pulse indicator light is flashing, but the electric shock delivered by the fence is weak.	<p>Check that all connections in the fence and ground system are firm and secure. If necessary, clean away any corrosion. Check that the ground rod is pushed firmly into firm ground. Check for faults in the fence-line caused by trees or vegetation. If necessary, remove obstructions and mend the fence.</p> <p>Check that the unit (charger) rating is adequate for the length of the fence. If necessary, reduce the length of the fence or reduce the number of fence wires. Alternatively, divide the fence-line into smaller zones, with each zone powered by a separate unit.</p>
The pulse indicator light is no flashing.	<p>Check that the unit is switched on.</p> <p>If there has been insufficient sunlight to charge the battery, the unit may be in Standby mode. Charge the battery by placing the unit in full sunlight with the solar panel facing true south in the northern hemisphere and true north in the southern hemisphere.</p> <p>Ensure the battery is connected correctly with the positive (red) lead to the positive (+) terminal on the battery and the negative (black) lead to the negative (-) terminal on the battery.</p> <p>Try charging the battery manually using a suitable battery charger. See Battery charging on page 9.</p> <p>Replace the battery with a new battery. Before installing a new battery, charge it fully using a suitable battery charger. If the pulse indicator light is still not flashing, please contact us.</p>

The battery needs frequent replacement.

Check that the solar panel is clean and is not damaged. See Maintenance on page 9.

Make sure the unit is positioned to receive maximum sunlight. If necessary, remove any objects or vegetation that might be casting a shadow on the unit. See Positioning the unit on page 6, or for more detailed information on solar installations.

After the unit is switched on, the pulse indicator light gives three long flashes (2 seconds) then the unit appears to be off.

The unit is in Standby mode because there has been insufficient sunlight to charge the battery. Charge the battery by placing the unit in full sunlight with the solar panel facing true south in the northern hemisphere and true north in the southern hemisphere.

The pulse indicator light flashes quickly several times and then there is a pause.

There may be a problem with the unit. Return the unit to a service agent appointed by

## **Servicing**

*Please contact your local store.*

*Note: If you suspect the unit is not working, always check the battery connection and voltage before proceeding.*

## **Warranty**

This warranty does not cover defects caused by:

- Incorrect input voltage or polarity
- Damage to external wiring
- Physical mishandling
- Water immersion
- Vermin or insect damage

---

*Note:* This product has been manufactured to comply with international safety standards.

---

This product is warranted against faulty material and workmanship for a period of 2 years from date of purchase.

If a warranted defect occurs, return this product with proof of purchase to an authorised service centre.

Note:

- No responsibility is accepted for any accident or damage caused subsequent to any tampering with or modification to or misuse of this product, including (but not limited to) alterations made by anyone other than
- To the maximum extent permitted by law, this warranty is exclusive, personal to you and in lieu of all other warranties, representations or conditions relating to this product (whether express or implied and whenever arising) whether originating by statute, law, trade, custom or otherwise.
- The product warranty is only valid in the original country of purchase. Any claims made in another country may incur full repair costs at the owner's expense.

**VEVOR<sup>®</sup>**  
**TOUGH TOOLS, HALF PRICE**





**VEVOR**<sup>®</sup>  
TOUGH TOOLS, HALF PRICE

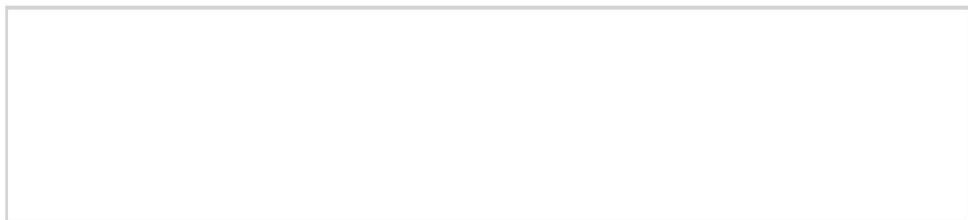



Electric Netting (1pc)



Net Repair Kit (1set)



Wire Hanging Kit (2sets)



Warning Sign (1pc)



Solar Energizer (1pc)



Alligator clips (1set)



12KV Lead-acid battery



12KV Fence Tester (1pc)



Earth Rod (1pc)



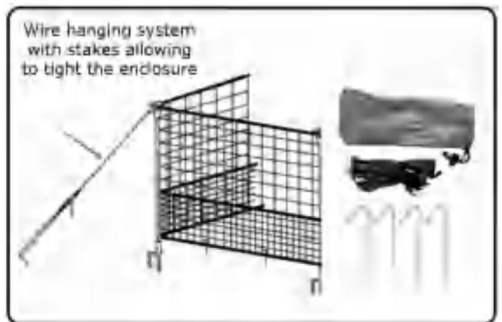

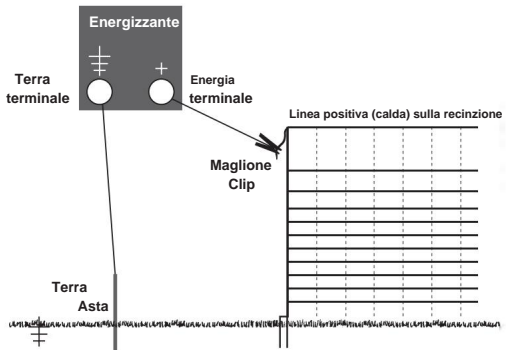

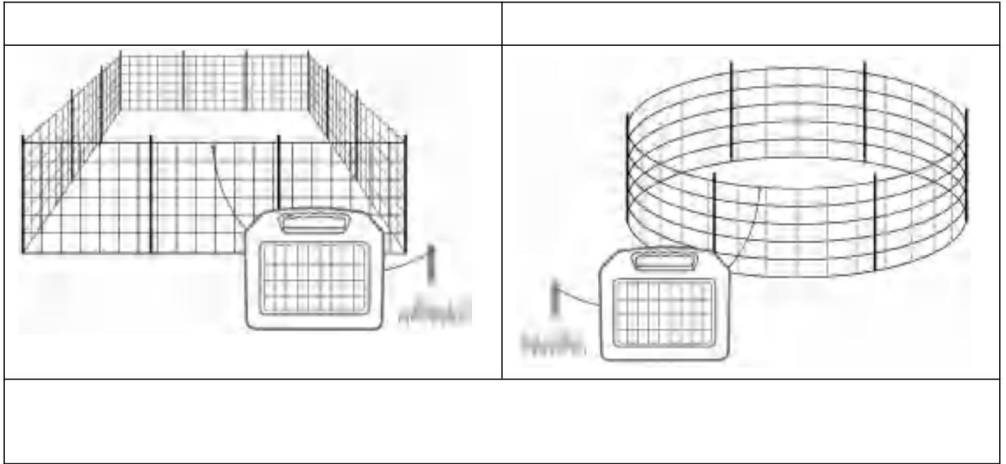

NUMERO DI RETI PIEDI ENERGIZER CONSIGLIATO		
1	120 piedi	10 miglia, 10 acri
2	240 piedi	20 miglia, 20 acri
3	360 piedi	30 miglia, 30 acri
4	480 piedi	40 miglia, 40 acri



ATTENZIONE







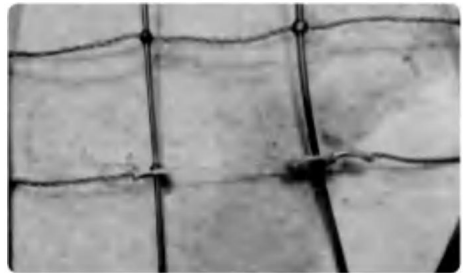
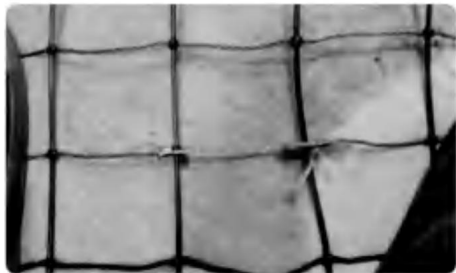
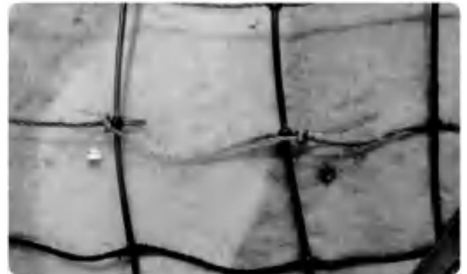
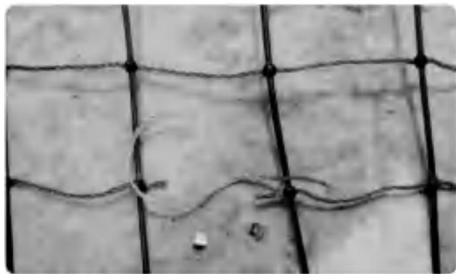
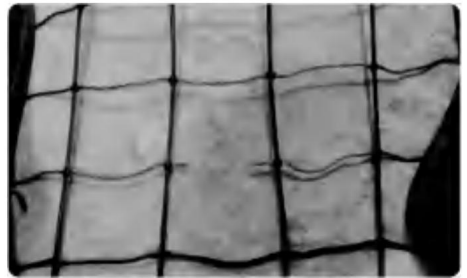
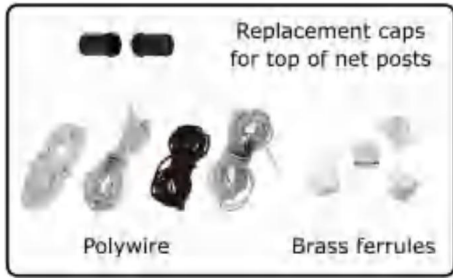

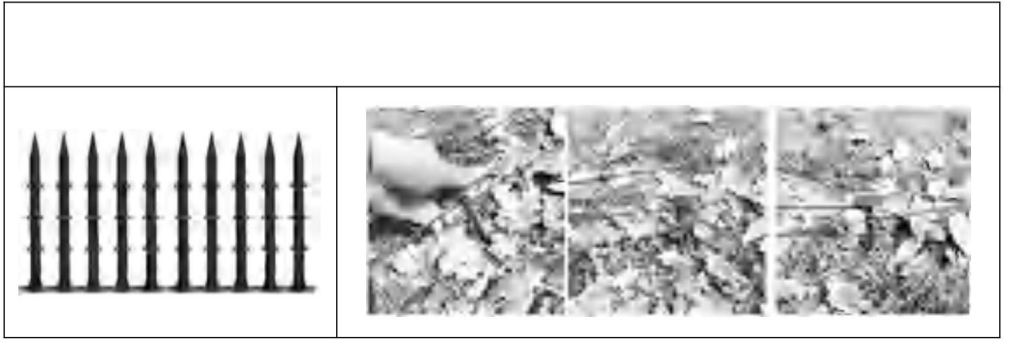



: Shuangchenglu 803nong11hao1602A-1609shi, baoshanqu  
, shanghai 200000 CN.

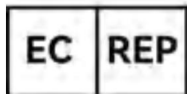

Azienda: E-CrossStu GmbH.  
Mainzer Landstr.69, 60329 Francoforte sul Meno.

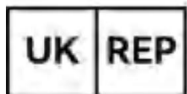

CONSULENZA YH LIMITATA.  
C/O YH Consulting Limited Ufficio 147, Centurion House,  
Via Roma, 101, 00186 Roma, Italia



**VEVOR**<sup>®</sup>  
TOUGH TOOLS, HALF PRICE

# **ELECTRIC FENCE ENERGIZER USER MANUAL**

## **WARNING: READ ALL INSTRUCTIONS**

If you suspect that the unit is not working, follow these steps:

1. Disconnect the unit from the fence and check that the indicator light is flashing.
2. Check the battery connection and voltage.
3. Check that the voltage between the live and ground terminals is greater than 7000 V, using a fence voltage tester.
4. If these tests are OK, you have an installation problem.

**Consult your user manual for installation and operating instructions**

# **CONTENTS**

Product Details	01
Key to symbols on the unit	03
Description	05
Installation	05
Battery information	07
Positioning the unit	10
Safety considerations	11
Troubleshooting	17
Servicing	19
Warranty	19



# Product Details

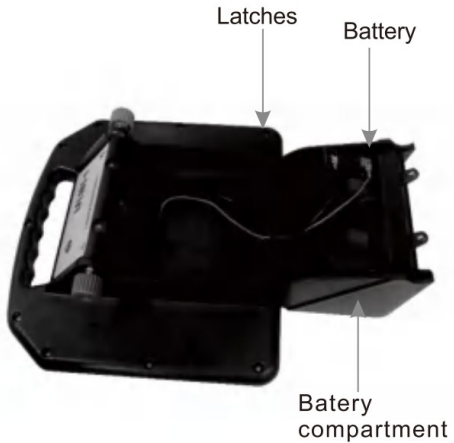
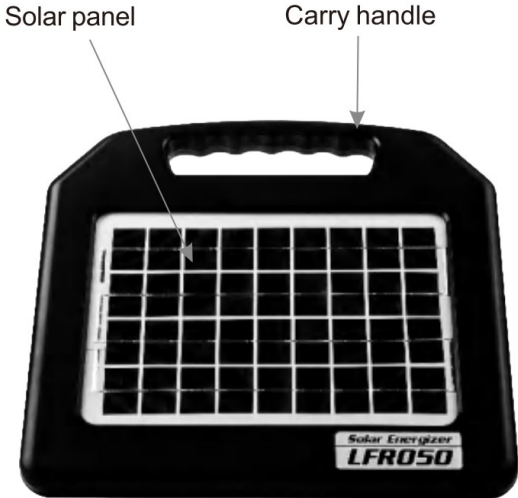

# Product Details

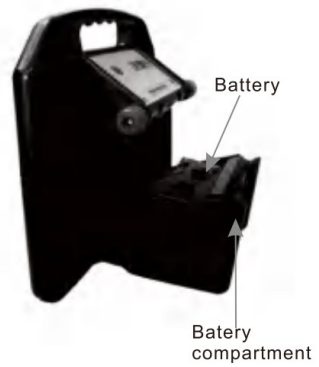
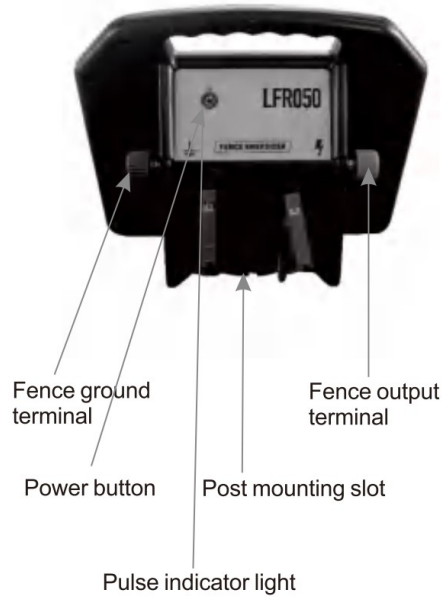

## Key to symbols on the unit

 Fence ground terminal (green). Connect the fence ground terminal to the ground system.

 Fence output terminal (red). Connect the fence output terminal to the fence.

 Risk of electric shock! This unit should be opened or repaired only by qualified personnel. No user serviceable parts.

 Read full instructions before use.



 This symbol on the product or its packaging indicates that this product must not be disposed of with other waste. Instead, it is your responsibility to dispose of your waste equipment by handing it over to a designated collection point for the recycling of waste electrical and electronic equipment. The separate collection and recycling of your waste equipment at the time of disposal will help conserve natural resources and ensure that it is recycled in a manner that protects human health and the environment. For more information about where you can drop off your waste equipment for recycling, please contact your local city recycling office or the dealer from whom you purchased the product.

## Before first use

Units may be supplied with or without a battery, depending on your region. If a battery has been supplied, it will be inside the battery compartment with the positive terminal disconnected.

Before using the unit for the first time, you must:

- 1 Insert a battery into the battery compartment (if necessary).
- 2 Connect the battery terminals.
- 3 Charge the battery by placing the unit in full sunlight for three days with the solar panel facing true south in the northern hemisphere and true north in the southern hemisphere.

## LFR050-Battery

1. Place the unit on a flat surface (handle downwards as shown). Open the battery compartment by unscrewing the screws on the back.



2. Insert a battery (if necessary).
3. Connect the positive (red) lead to the positive (+) terminal on the battery. Connect the negative (black) lead to the negative (-) terminal on the battery (if necessary).
4. Close the battery compartment, ensuring that the latches are securely fastened.

**Caution!** When connecting the battery, be careful not to short circuit the supply terminals.

## Description

---

Power output at 500 ohms: 0.5J  
Delivered power vacuum: 0.63J  
Effective square meter: 50 Acres  
Effective length: 20 Miles  
Solar Consumption: 47 mA  
Voltage Vacuum: 10KV Max  
Waterproof Rating: IP65 Outdoor Use  
Power Source Battery: DC 12V/8AH(including)  
Operates Days without Sunlight: UP 2 weeks  
Polysilicon Solar Panel Voltage Output(Vmp): DC 18V  
Polysilicon Solar Panel Current Output(Imp): 0.28A  
Polysilicon Solar Panel Power Output(Pmax): 5W  
Solar Panel Size: 303\*213mm  
Plastic case Dimensions: 37.5\*22\*30cm  
G.W.: 3KGS  
Product including one AC/DC adapter,two alligator clips

## Installation

### Positioning the unit

---

Install the unit:

- adjacent to the electric fence
- preferably in the middle of the electric fence
- where it will receive the most daily sun throughout the season
- where a good ground can be obtained
- away from flooding and out of reach of animals and children (inside a protective fence, if required)
- with the solar panel facing true south in the northern hemisphere and true north in the southern hemisphere.

### Mounting the unit

---

The unit may be placed directly onto a flat surface or mounted directly onto a steel Y-post or T-post using the post-mounting slot.

## Connecting to an electric fence

## Pulse indicator light

The pulse indicator light indicates the output pulse speed. The pulse speed varies according to the battery charge level:

Battery charge level	Typical pulse speed
Normal	A pulse every 1.5 seconds
Low	A pulse every 3 seconds

## Standby mode

An intelligent battery management feature puts the unit into Standby mode when battery charge falls below a 'safe operating level'. When in Standby mode, the unit is still on, but it will not deliver a pulse to the electric fence.

The unit will resume delivering pulses when the solar panel has charged the battery so that it is above 'safe operating level'.

When operation resumes, the battery charge level will still be low, so the unit will deliver one pulse every 3 seconds. Once the battery reaches normal charge level, the pulse will revert to one pulse every 1.5 seconds.

## Battery information

### Battery charging

The solar panel can fully charge a flat battery in two weeks, provided the unit is switched off and there is adequate sunlight. A battery charger may also be used to charge the battery. Use a battery charger suitable for charging sealed, lead-acid batteries.

## Battery charger details

Warning! The battery must be disconnected and removed from the unit before connecting it to a battery charger.

Model	Battery type being charged	Battery charger requirements
LFR050	12 V	13.8 V, $\leq 1$ A

When fully charged, the battery should be able to power the unit for up to three weeks. To fit into the battery box, battery dimensions should be within 15\*6.5\*9.5 cm / L\*W\*H

## Replacing the battery

If a replacement battery is required, use a sealed lead-acid battery.

Warning! Do not use a non-rechargeable battery.

### Replacement battery details

Model	Suitable battery type
-------	-----------------------

LFR050 12 V, 8 Ah battery

Do not dispose of the battery in a land-fill or in a fire.

In the event of a spill or leakage from a sealed lead-acid battery:

- Contain small spills with dry sand, soil and vermiculite. Do not use combustible materials. If possible, carefully neutralize spilled electrolyte with soda ash, sodium bicarbonate, lime, etc.
- Wear acid-resistant clothing, boots, gloves and a face shield.
- Do not let un-neutralised acid get into the sewerage system.

Neutralized acid must be managed in accordance with approved local, state and federal requirements. Consult your state environmental agency and/or federal EPA.

## Maintenance

Clean the solar panel regularly with a soft cloth using glass cleaner or a mild solution of detergent and water. This will ensure the solar panel functions efficiently.

When transporting the unit, protect the solar panel to prevent the glass surface from being damaged.

## Storage

If the unit is stored for extended periods, the battery can discharge and become damaged.

The unit should be stored inside, next to a window, where sunlight can shine on the unit each day.

If the unit cannot be stored in a sunny position, it should be kept in a cool place. The battery should be fully charged and disconnected from the unit. The battery should be recharged manually every six months using a suitable battery charger.

## Positioning the unit

A temporary fence can be quickly erected and easily moved allowing the farmer to:

- Make smaller paddocks (fields)
- Keep herds of animals separated
- Ration feed

*Note:* Use more wires for smaller animals and wild animals. Polytape should be used when greater visibility is required (e.g. horses).

An example of a temporary fence is shown below.

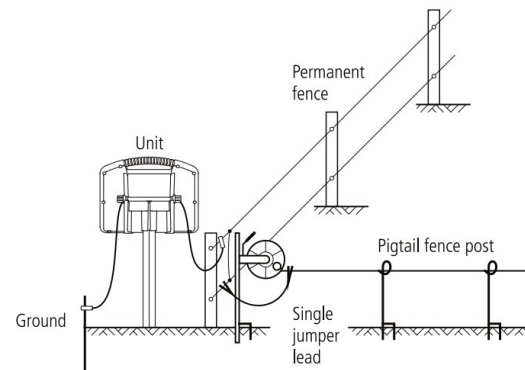



## Safety considerations

### Warning!

- Do not connect to mains-operated or line-operated equipment.
- Remove the battery from the unit before using an external battery charger to recharge the battery.
- Switch the unit off before installation or performing any work on the fence.
- Read all the safety considerations carefully.
- Check your installation to ensure that it complies with all local safety regulations.
- Do not connect simultaneously to a fence and to any other device such as a cattle trainer or a poultry trainer. Otherwise, lightning striking your fence will be conducted to all other devices.

### Notes:

- This product has been designed for use with electric animal fences.
- Keep these instructions in a handy location.

## Safe electric fence construction

### Warning! Read before use.

An electric fence can be hazardous when there is a risk of entrapment or entanglement, or other hazards exist. Serious injury or death may result. Take all steps to avoid the risk of entrapment or entanglement.

The adapter and battery cannot be used at the same time, When using battery, adapter cannot be inserted; When using adapter, Need to unplug the battery

## Danger

- Do not climb through or under an electric fence. If it is necessary to cross an electric fence use a gate or specially designed crossing point.
- Do not allow young or infirm persons to use this unit without supervision. Do not allow young children to play with this unit or near an electric fence or electrified wires.
- Do not electrify barbed wire.
- Do not support off-set electrified wires less than 6" (150 mm) from the vertical plane of a barbed wire fence.
- Do not electrify any fence construction which could lead to entanglement of persons or animals. We recommend for instance, that no more than one electrified off-set wire be supported on either side of a barbed wire or mesh fence.
- Do not supply an electric fence from two units.
- Do not allow electrified wires from two units on the same or adjacent properties to be less than 8' (2.5 m) apart.
- Do not place the unit's ground rod within 33' (10 m) of any part of a power supply ground system or telecommunications ground system.
- Do not run electric fence wires above or close to overhead power or communication lines.

### Cautions :

1. Feature: 2 dew holes at the bottom of the plastic box prevent water from accumulating.
2. When not use, the battery clip should be removed to prevent power consumption.
3. When use AC power, disconnect the battery clips to prevent battery from burning out.
4. When wire clips connect battery, the side with the spring faces up enable remove easily.

## Duty to the public

A warning sign shall be fitted to every point where persons may gain ready access to the conductors.

Where an electric animal fence crosses a public pathway, a non-electrified gate shall be incorporated in the electric animal fence at that point or a crossing by means of stiles shall be provided. At any such crossing, the adjacent electrified wires shall carry warning signs.

Any part of an electric animal fence that is installed along a public road or pathway shall be identified at frequent intervals by warning signs securely fastened to the fence posts or firmly clamped to the fence wires.

- The size of the warning sign shall be at least 4x8" (100x200 mm).
- The background colour of both sides of the warning sign shall be yellow. The inscription on the sign shall be black and shall be either:

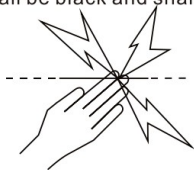

or the substance of "CAUTION: Electric fence".

- The inscription shall be indelible, inscribed on both sides of the warning sign and have a height of at least 1" (25 mm).

## Definition of special terms

Unit/Charger/Energizer – An appliance that is intended to periodically deliver voltage impulses to a fence connected to it.

Fence – A barrier for animals or for the purpose of security, comprising one or more conductors such as metal wires, rods or rails.

Electric fence – A barrier which includes one or more electric conductors, insulated from ground, to which electric pulses are applied by a unit.

Ground rod – Metal structure that is driven into the soil near a unit and connected electrically to the Fence ground terminal of the unit, and that is independent of other grounding arrangements.

Connecting lead – An electric conductor, used to connect the unit to the electric fence or the ground rod.

## Requirements for electric animal fences

Electric animal fences and their ancillary equipment shall be installed, operated and maintained in a manner that minimises danger to persons, animals or their surroundings.

**Warning! Avoid contacting electric fence wires especially with the head, neck or torso. Do not climb over, through or under a multi-wire electric fence. Use a gate or a specially designed crossing point.**

This unit is not intended for use by persons (including children) with reduced physical, sensory or mental capabilities, or lack of experience and knowledge, unless they have been given supervision or instruction concerning use of the unit by a person responsible for their safety.

Children should be supervised to ensure that they do not play with the unit. Electric animal fence constructions that are likely to lead to the entanglement of animals or persons shall be avoided.

An electric animal fence shall not be supplied from two separate units or from independent fence circuits of the same unit.

For any two separate electric animal fences, each supplied from a separate unit independently timed, the distance between the wires of the two electric animal fences shall be at least 8' (2.5 m). If this gap is to be closed, this shall be effected by means of electrically non-conductive material or an isolated metal barrier. Barbed wire or razor wire shall not be electrified by a unit.

A non-electrified fence incorporating barbed wire or razor wire may be used to support one or more off-set electrified wires of an electric animal fence.

supporting devices for the electrified wires shall be constructed so as to ensure that these wires are positioned at a minimum distance of 6" (150 mm) from the vertical plane of the non-electrified wires. The barbed wire and razor wire shall be grounded at regular intervals.

A distance of at least 33' (10 m) shall be maintained between the unit's ground rod and any other grounding system connected parts such as the grounding system for the power supply or the telecommunication system.

Connecting leads that are run inside buildings shall be effectively insulated from the grounded structural parts of the building. This may be achieved by using insulated high voltage cable.

Connecting leads that are run underground shall be run in conduit of insulating material or else insulated high voltage cable shall be used. Care must be taken to avoid damage to the connecting leads due to the effects of animal hooves or vehicle wheels sinking into the ground.

Connecting leads shall not be installed in the same conduit as the AC supply wiring, communication cables or data cables.

Connecting leads and electric animal fence wires shall not cross above overhead power or communication lines.

Crossings with overhead power lines shall be avoided wherever possible. If such a crossing cannot be avoided it shall be made underneath the power line and as nearly as possible at right angles to it.

If connecting leads and electric animal fence wires are installed near an overhead power line, the clearances shall not be less than those shown in the table below.

*Minimum clearances from power lines for electric animal fences*

Power line voltage	Clearance
≤1000 V	10' (3 m)
>1000 V to ≤33,000 V	13' (4 m)
>33,000 V	27' (8 m)

If connecting leads and electric animal fence wires are installed near an overhead power line, their height above the ground shall not exceed 10' (3 m). This height applies to either side of the orthogonal projection of the outermost conductors of the power line on the ground surface, for a distance of:

- 6'6" (2 m) for power lines operating at a nominal voltage not exceeding 1000 V.
- 50' (15 m) for power lines operating at a nominal voltage exceeding 1000 V.

Electric animal fences intended for deterring birds, household pet containment or training animals such as cows need only be supplied from low output units to obtain satisfactory and safe performance.

In electric animal fences intended for deterring birds from roosting on buildings, no electric fence wire shall be connected to the unit's ground rod.

Ensure that all line-operated, ancillary equipment connected to the electric animal fence circuit provides a degree of isolation between the fence circuit and the supply mains equivalent to that provided by the unit.

Protection from the weather shall be provided for the ancillary equipment unless this equipment is certified by the manufacturer as being suitable for use outdoors, and is of a type with a minimum degree of protection IP66.



## Troubleshooting

Problem	Action
The pulse indicator light is flashing, but the electric shock delivered by the fence is weak.	<p>Check that all connections in the fence and ground system are firm and secure. If necessary, clean away any corrosion. Check that the ground rod is pushed firmly into firm ground. Check for faults in the fence-line caused by trees or vegetation. If necessary, remove obstructions and mend the fence.</p> <p>Check that the unit (charger) rating is adequate for the length of the fence. If necessary, reduce the length of the fence or reduce the number of fence wires. Alternatively, divide the fence-line into smaller zones, with each zone powered by a separate unit.</p>
The pulse indicator light is no flashing.	<p>Check that the unit is switched on.</p> <p>If there has been insufficient sunlight to charge the battery, the unit may be in Standby mode. Charge the battery by placing the unit in full sunlight with the solar panel facing true south in the northern hemisphere and true north in the southern hemisphere.</p> <p>Ensure the battery is connected correctly with the positive (red) lead to the positive (+) terminal on the battery and the negative (black) lead to the negative (-) terminal on the battery.</p> <p>Try charging the battery manually using a suitable battery charger. See Battery charging on page 9.</p> <p>Replace the battery with a new battery. Before installing a new battery, charge it fully using a suitable battery charger. If the pulse indicator light is still not flashing, please contact us.</p>

The battery needs frequent replacement.

Check that the solar panel is clean and is not damaged. See Maintenance on page 9.

Make sure the unit is positioned to receive maximum sunlight. If necessary, remove any objects or vegetation that might be casting a shadow on the unit. See Positioning the unit on page 6, or for more detailed information on solar installations.

After the unit is switched on, the pulse indicator light gives three long flashes (2 seconds) then the unit appears to be off.

The unit is in Standby mode because there has been insufficient sunlight to charge the battery. Charge the battery by placing the unit in full sunlight with the solar panel facing true south in the northern hemisphere and true north in the southern hemisphere.

The pulse indicator light flashes quickly several times and then there is a pause.

There may be a problem with the unit. Return the unit to a service agent appointed by

## **Servicing**

*Please contact your local store.*

*Note: If you suspect the unit is not working, always check the battery connection and voltage before proceeding.*

## **Warranty**

This warranty does not cover defects caused by:

- Incorrect input voltage or polarity
- Damage to external wiring
- Physical mishandling
- Water immersion
- Vermin or insect damage

---

*Note:* This product has been manufactured to comply with international safety standards.

---

This product is warranted against faulty material and workmanship for a period of 2 years from date of purchase.

If a warranted defect occurs, return this product with proof of purchase to an authorised service centre.

Note:

- No responsibility is accepted for any accident or damage caused subsequent to any tampering with or modification to or misuse of this product, including (but not limited to) alterations made by anyone other than
- To the maximum extent permitted by law, this warranty is exclusive, personal to you and in lieu of all other warranties, representations or conditions relating to this product (whether express or implied and whenever arising) whether originating by statute, law, trade, custom or otherwise.
- The product warranty is only valid in the original country of purchase. Any claims made in another country may incur full repair costs at the owner's expense.

**VEVOR**®  
TOUGH TOOLS, HALF PRICE



**VEVOR**<sup>®</sup>  
TOUGH TOOLS, HALF PRICE

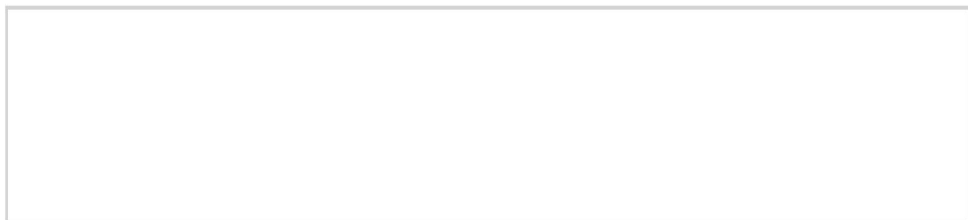



Electric Netting (1pc)



Net Repair Kit (1set)



Wire Hanging Kit (2sets)



Warning Sign (1pc)



Solar Energizer (1pc)



Alligator clips (1set)



12KV Lead-acid battery



12KV Fence Tester (1pc)



Earth Rod (1pc)





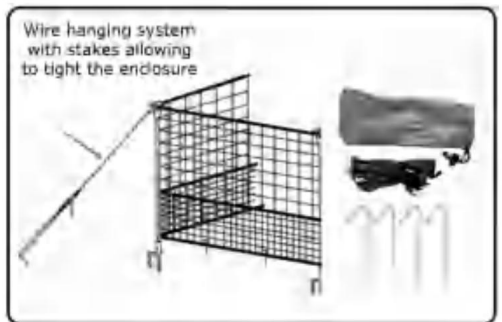

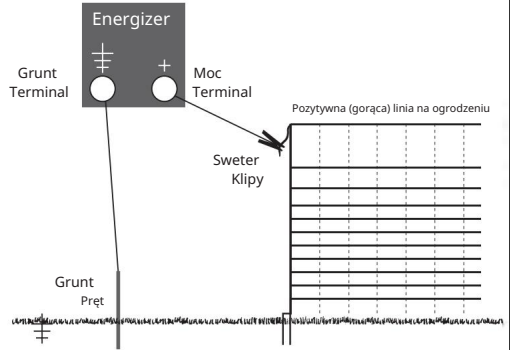

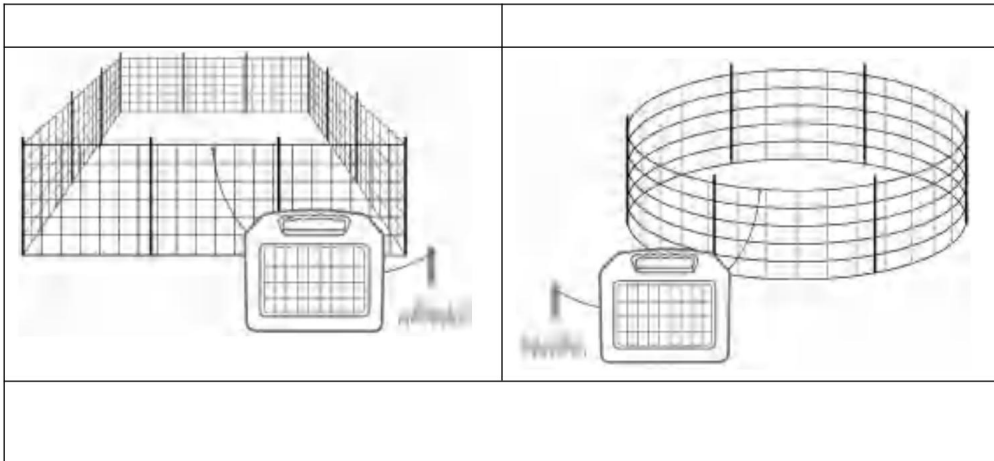

ILOŚĆ SIECI STOPY ZALECANY ENERGIZER		
1	120 stóp.	10 mil, 10 akrów
2	240 stóp.	20 mil, 20 akrów
3	360 stóp.	30 mil, 30 akrów
4	480 stóp.	40 mil, 40 akrów



OSTROŻNOŚĆ





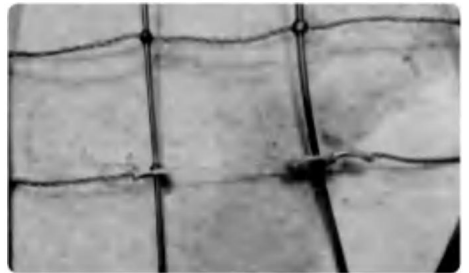
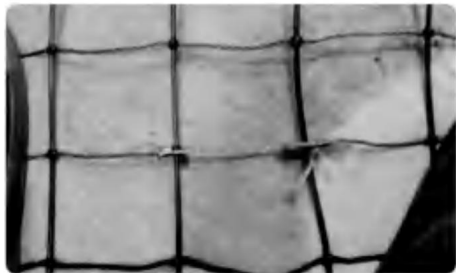
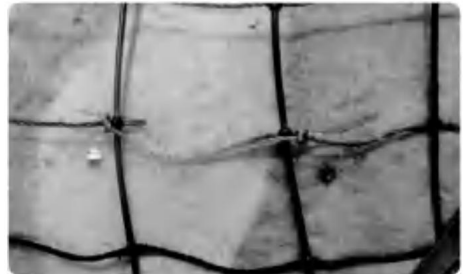
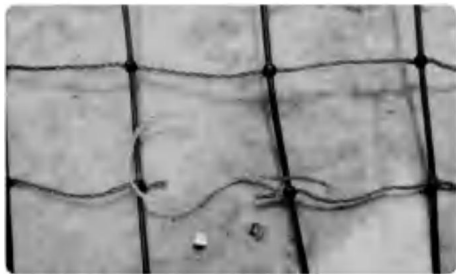
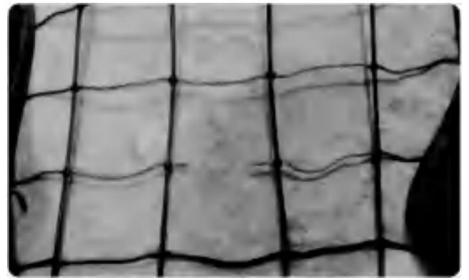
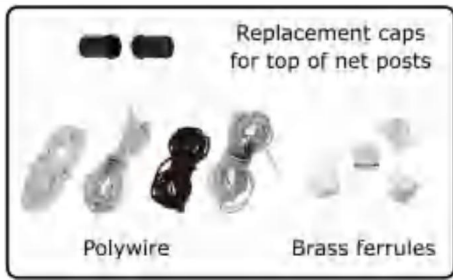





: Shuangchenglu 803nong11hao1602A-1609shi, baoshanqu  
, Szanghaj 200000 CN.

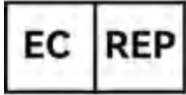

Firma E-CrossStu GmbH.  
Mainzer Landstr.69, 60329 Frankfurt nad Menem.



YH CONSULTING LIMITED.  
C/O YH Consulting Limited Biuro 147, Centurion House,  
London Road, Staines-upon-Thames, Surrey, TW18 4AX





**VEVOR**<sup>®</sup>  
TOUGH TOOLS, HALF PRICE

# **ELECTRIC FENCE ENERGIZER USER MANUAL**

## **WARNING: READ ALL INSTRUCTIONS**

If you suspect that the unit is not working, follow these steps:

1. Disconnect the unit from the fence and check that the indicator light is flashing.
2. Check the battery connection and voltage.
3. Check that the voltage between the live and ground terminals is greater than 7000 V, using a fence voltage tester.
4. If these tests are OK, you have an installation problem.

**Consult your user manual for installation  
and operating instructions**

# **CONTENTS**

Product Details	01
Key to symbols on the unit	03
Description	05
Installation	05
Battery information	07
Positioning the unit	10
Safety considerations	11
Troubleshooting	17
Servicing	19
Warranty	19

# Product Details

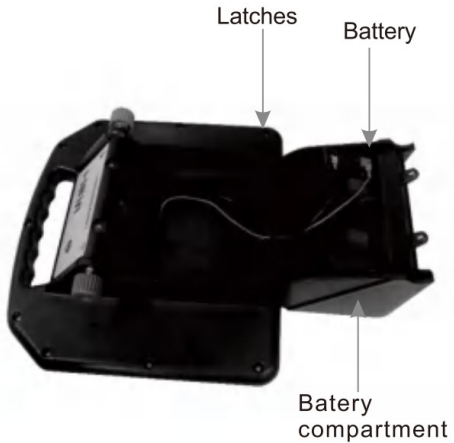
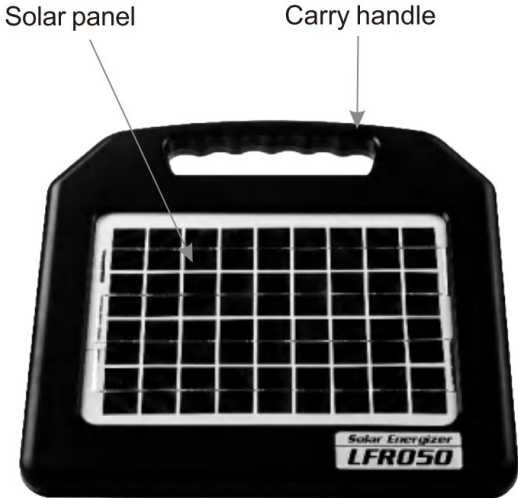

# Product Details

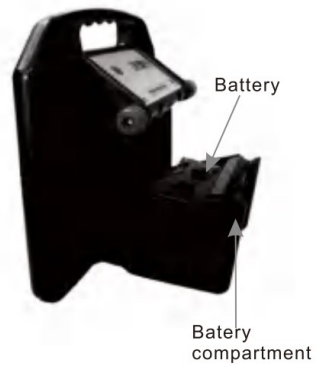
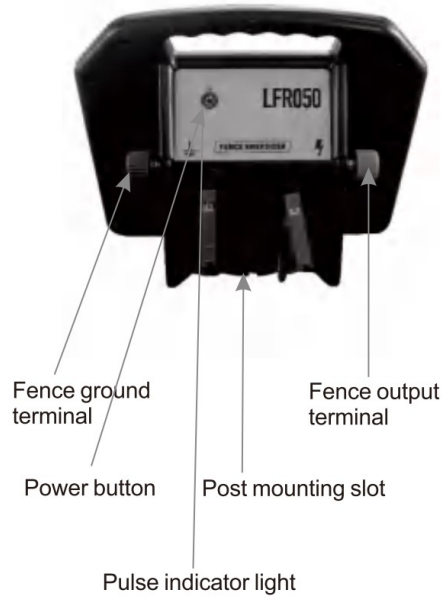

## Key to symbols on the unit

 Fence ground terminal (green). Connect the fence ground terminal to the ground system.

 Fence output terminal (red). Connect the fence output terminal to the fence.



Risk of electric shock! This unit should be opened or repaired only by qualified personnel. No user serviceable parts.



Read full instructions before use.



This symbol on the product or its packaging indicates that this product must not be disposed of with other waste. Instead, it is your responsibility to dispose of your waste equipment by handing it over to a designated collection point for the recycling of waste electrical and electronic equipment. The separate collection and recycling of your waste equipment at the time of disposal will help conserve natural resources and ensure that it is recycled in a manner that protects human health and the environment. For more information about where you can drop off your waste equipment for recycling, please contact your local city recycling office or the dealer from whom you purchased the product.

## Before first use

Units may be supplied with or without a battery, depending on your region. If a battery has been supplied, it will be inside the battery compartment with the positive terminal disconnected.

Before using the unit for the first time, you must:

- 1 Insert a battery into the battery compartment (if necessary).
- 2 Connect the battery terminals.
- 3 Charge the battery by placing the unit in full sunlight for three days with the solar panel facing true south in the northern hemisphere and true north in the southern hemisphere.

## LFR050-Battery

1. Place the unit on a flat surface (handle downwards as shown). Open the battery compartment by unscrewing the screws on the back.



2. Insert a battery (if necessary).
3. Connect the positive (red) lead to the positive (+) terminal on the battery. Connect the negative (black) lead to the negative (-) terminal on the battery (if necessary).
4. Close the battery compartment, ensuring that the latches are securely fastened.

**Caution!** When connecting the battery, be careful not to short circuit the supply terminals.

## Description

---

Power output at 500 ohms: 0.5J  
Delivered power vacuum: 0.63J  
Effective square meter: 50 Acres  
Effective length: 20 Miles  
Solar Consumption: 47 mA  
Voltage Vacuum: 10KV Max  
Waterproof Rating: IP65 Outdoor Use  
Power Source Battery: DC 12V/8AH(including)  
Operates Days without Sunlight: UP 2 weeks  
Polysilicon Solar Panel Voltage Output(Vmp): DC 18V  
Polysilicon Solar Panel Current Output(Imp): 0.28A  
Polysilicon Solar Panel Power Output(Pmax): 5W  
Solar Panel Size: 303\*213mm  
Plastic case Dimensions: 37.5\*22\*30cm  
G.W.: 3KGS  
Product including one AC/DC adapter,two alligator clips

## Installation

### Positioning the unit

---

Install the unit:

- adjacent to the electric fence
- preferably in the middle of the electric fence
- where it will receive the most daily sun throughout the season
- where a good ground can be obtained
- away from flooding and out of reach of animals and children (inside a protective fence, if required)
- with the solar panel facing true south in the northern hemisphere and true north in the southern hemisphere.

### Mounting the unit

---

The unit may be placed directly onto a flat surface or mounted directly onto a steel Y-post or T-post using the post-mounting slot.

## Connecting to an electric fence

## Pulse indicator light

The pulse indicator light indicates the output pulse speed. The pulse speed varies according to the battery charge level:

Battery charge level	Typical pulse speed
Normal	A pulse every 1.5 seconds
Low	A pulse every 3 seconds

## Standby mode

An intelligent battery management feature puts the unit into Standby mode when battery charge falls below a 'safe operating level'. When in Standby mode, the unit is still on, but it will not deliver a pulse to the electric fence.

The unit will resume delivering pulses when the solar panel has charged the battery so that it is above 'safe operating level'.

When operation resumes, the battery charge level will still be low, so the unit will deliver one pulse every 3 seconds. Once the battery reaches normal charge level, the pulse will revert to one pulse every 1.5 seconds.

## Battery information

### Battery charging

The solar panel can fully charge a flat battery in two weeks, provided the unit is switched off and there is adequate sunlight. A battery charger may also be used to charge the battery. Use a battery charger suitable for charging sealed, lead-acid batteries.

## Battery charger details

Warning! The battery must be disconnected and removed from the unit before connecting it to a battery charger.

Model	Battery type being charged	Battery charger requirements
LFR050	12 V	13.8 V, $\leq 1$ A

When fully charged, the battery should be able to power the unit for up to three weeks. To fit into the battery box, battery dimensions should be within 15\*6.5\*9.5 cm / L\*W\*H

## Replacing the battery

If a replacement battery is required, use a sealed lead-acid battery.

Warning! Do not use a non-rechargeable battery.

### Replacement battery details

Model	Suitable battery type
-------	-----------------------

LFR050 12 V, 8 Ah battery

Do not dispose of the battery in a land-fill or in a fire.

In the event of a spill or leakage from a sealed lead-acid battery:

- Contain small spills with dry sand, soil and vermiculite. Do not use combustible materials. If possible, carefully neutralize spilled electrolyte with soda ash, sodium bicarbonate, lime, etc.
- Wear acid-resistant clothing, boots, gloves and a face shield.
- Do not let un-neutralised acid get into the sewerage system.



Neutralized acid must be managed in accordance with approved local, state and federal requirements. Consult your state environmental agency and/or federal EPA.

## Maintenance

Clean the solar panel regularly with a soft cloth using glass cleaner or a mild solution of detergent and water. This will ensure the solar panel functions efficiently.

When transporting the unit, protect the solar panel to prevent the glass surface from being damaged.

## Storage

If the unit is stored for extended periods, the battery can discharge and become damaged.

The unit should be stored inside, next to a window, where sunlight can shine on the unit each day.

If the unit cannot be stored in a sunny position, it should be kept in a cool place. The battery should be fully charged and disconnected from the unit. The battery should be recharged manually every six months using a suitable battery charger.

## Positioning the unit

A temporary fence can be quickly erected and easily moved allowing the farmer to:

- Make smaller paddocks (fields)
- Keep herds of animals separated
- Ration feed

*Note:* Use more wires for smaller animals and wild animals. Polytape should be used when greater visibility is required (e.g. horses).

An example of a temporary fence is shown below.

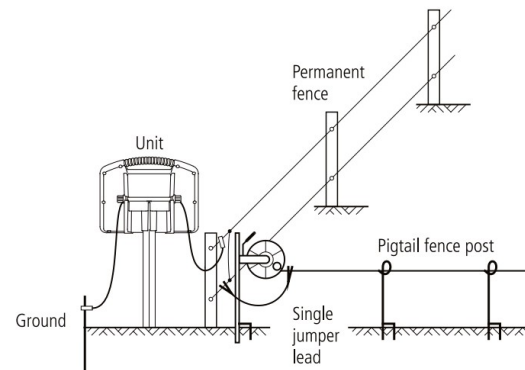

## Safety considerations

### *Warning!*

- Do not connect to mains-operated or line-operated equipment.
- Remove the battery from the unit before using an external battery charger to recharge the battery.
- Switch the unit off before installation or performing any work on the fence.
- Read all the safety considerations carefully.
- Check your installation to ensure that it complies with all local safety regulations.
- Do not connect simultaneously to a fence and to any other device such as a cattle trainer or a poultry trainer. Otherwise, lightning striking your fence will be conducted to all other devices.

### *Notes:*

- This product has been designed for use with electric animal fences.
- Keep these instructions in a handy location.

## Safe electric fence construction

### *Warning!* Read before use.

An electric fence can be hazardous when there is a risk of entrapment or entanglement, or other hazards exist. Serious injury or death may result. Take all steps to avoid the risk of entrapment or entanglement.

The adapter and battery cannot be used at the same time, When using battery, adapter cannot be inserted; When using adapter, Need to unplug the battery

## Danger

- Do not climb through or under an electric fence. If it is necessary to cross an electric fence use a gate or specially designed crossing point.
- Do not allow young or infirm persons to use this unit without supervision. Do not allow young children to play with this unit or near an electric fence or electrified wires.
- Do not electrify barbed wire.
- Do not support off-set electrified wires less than 6" (150 mm) from the vertical plane of a barbed wire fence.
- Do not electrify any fence construction which could lead to entanglement of persons or animals. We recommend for instance, that no more than one electrified off-set wire be supported on either side of a barbed wire or mesh fence.
- Do not supply an electric fence from two units.
- Do not allow electrified wires from two units on the same or adjacent properties to be less than 8' (2.5 m) apart.
- Do not place the unit's ground rod within 33' (10 m) of any part of a power supply ground system or telecommunications ground system.
- Do not run electric fence wires above or close to overhead power or communication lines.

### Cautions :

1. Feature: 2 dew holes at the bottom of the plastic box prevent water from accumulating.
2. When not use, the battery clip should be removed to prevent power consumption.
3. When use AC power, disconnect the battery clips to prevent battery from burning out.
4. When wire clips connect battery, the side with the spring faces up enable remove easily.

## Duty to the public

A warning sign shall be fitted to every point where persons may gain ready access to the conductors.

Where an electric animal fence crosses a public pathway, a non-electrified gate shall be incorporated in the electric animal fence at that point or a crossing by means of stiles shall be provided. At any such crossing, the adjacent electrified wires shall carry warning signs.

Any part of an electric animal fence that is installed along a public road or pathway shall be identified at frequent intervals by warning signs securely fastened to the fence posts or firmly clamped to the fence wires.

- The size of the warning sign shall be at least 4x8" (100x200 mm).
- The background colour of both sides of the warning sign shall be yellow. The inscription on the sign shall be black and shall be either:

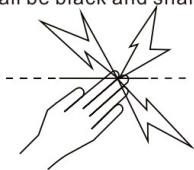

or the substance of "CAUTION: Electric fence".

- The inscription shall be indelible, inscribed on both sides of the warning sign and have a height of at least 1" (25 mm).

## Definition of special terms

Unit/Charger/Energizer – An appliance that is intended to periodically deliver voltage impulses to a fence connected to it.

Fence – A barrier for animals or for the purpose of security, comprising one or more conductors such as metal wires, rods or rails.

Electric fence – A barrier which includes one or more electric conductors, insulated from ground, to which electric pulses are applied by a unit.

Ground rod – Metal structure that is driven into the soil near a unit and connected electrically to the Fence ground terminal of the unit, and that is independent of other grounding arrangements.

Connecting lead – An electric conductor, used to connect the unit to the electric fence or the ground rod.

## Requirements for electric animal fences

Electric animal fences and their ancillary equipment shall be installed, operated and maintained in a manner that minimises danger to persons, animals or their surroundings.

**Warning! Avoid contacting electric fence wires especially with the head, neck or torso. Do not climb over, through or under a multi-wire electric fence. Use a gate or a specially designed crossing point.**

This unit is not intended for use by persons (including children) with reduced physical, sensory or mental capabilities, or lack of experience and knowledge, unless they have been given supervision or instruction concerning use of the unit by a person responsible for their safety.

Children should be supervised to ensure that they do not play with the unit. Electric animal fence constructions that are likely to lead to the entanglement of animals or persons shall be avoided.

An electric animal fence shall not be supplied from two separate units or from independent fence circuits of the same unit.

For any two separate electric animal fences, each supplied from a separate unit independently timed, the distance between the wires of the two electric animal fences shall be at least 8' (2.5 m). If this gap is to be closed, this shall be effected by means of electrically non-conductive material or an isolated metal barrier. Barbed wire or razor wire shall not be electrified by a unit.

A non-electrified fence incorporating barbed wire or razor wire may be used to support one or more off-set electrified wires of an electric animal fence.

supporting devices for the electrified wires shall be constructed so as to ensure that these wires are positioned at a minimum distance of 6" (150 mm) from the vertical plane of the non-electrified wires. The barbed wire and razor wire shall be grounded at regular intervals.

A distance of at least 33' (10 m) shall be maintained between the unit's ground rod and any other grounding system connected parts such as the grounding system for the power supply or the telecommunication system.

Connecting leads that are run inside buildings shall be effectively insulated from the grounded structural parts of the building. This may be achieved by using insulated high voltage cable.

Connecting leads that are run underground shall be run in conduit of insulating material or else insulated high voltage cable shall be used. Care must be taken to avoid damage to the connecting leads due to the effects of animal hooves or vehicle wheels sinking into the ground.

Connecting leads shall not be installed in the same conduit as the AC supply wiring, communication cables or data cables.

Connecting leads and electric animal fence wires shall not cross above overhead power or communication lines.

Crossings with overhead power lines shall be avoided wherever possible. If such a crossing cannot be avoided it shall be made underneath the power line and as nearly as possible at right angles to it.

If connecting leads and electric animal fence wires are installed near an overhead power line, the clearances shall not be less than those shown in the table below.

*Minimum clearances from power lines for electric animal fences*

Power line voltage	Clearance
≤1000 V	10' (3 m)
>1000 V to ≤33,000 V	13' (4 m)
>33,000 V	27' (8 m)

If connecting leads and electric animal fence wires are installed near an overhead power line, their height above the ground shall not exceed 10' (3 m). This height applies to either side of the orthogonal projection of the outermost conductors of the power line on the ground surface, for a distance of:

- 6'6" (2 m) for power lines operating at a nominal voltage not exceeding 1000 V.
- 50' (15 m) for power lines operating at a nominal voltage exceeding 1000 V.

Electric animal fences intended for deterring birds, household pet containment or training animals such as cows need only be supplied from low output units to obtain satisfactory and safe performance.

In electric animal fences intended for deterring birds from roosting on buildings, no electric fence wire shall be connected to the unit's ground rod.

Ensure that all line-operated, ancillary equipment connected to the electric animal fence circuit provides a degree of isolation between the fence circuit and the supply mains equivalent to that provided by the unit.

Protection from the weather shall be provided for the ancillary equipment unless this equipment is certified by the manufacturer as being suitable for use outdoors, and is of a type with a minimum degree of protection IP66.



## Troubleshooting

Problem	Action
The pulse indicator light is flashing, but the electric shock delivered by the fence is weak.	<p>Check that all connections in the fence and ground system are firm and secure. If necessary, clean away any corrosion. Check that the ground rod is pushed firmly into firm ground. Check for faults in the fence-line caused by trees or vegetation. If necessary, remove obstructions and mend the fence.</p> <p>Check that the unit (charger) rating is adequate for the length of the fence. If necessary, reduce the length of the fence or reduce the number of fence wires. Alternatively, divide the fence-line into smaller zones, with each zone powered by a separate unit.</p>
The pulse indicator light is no flashing.	<p>Check that the unit is switched on.</p> <p>If there has been insufficient sunlight to charge the battery, the unit may be in Standby mode. Charge the battery by placing the unit in full sunlight with the solar panel facing true south in the northern hemisphere and true north in the southern hemisphere.</p> <p>Ensure the battery is connected correctly with the positive (red) lead to the positive (+) terminal on the battery and the negative (black) lead to the negative (-) terminal on the battery.</p> <p>Try charging the battery manually using a suitable battery charger. See Battery charging on page 9.</p> <p>Replace the battery with a new battery. Before installing a new battery, charge it fully using a suitable battery charger. If the pulse indicator light is still not flashing, please contact us.</p>

The battery needs frequent replacement.

Check that the solar panel is clean and is not damaged. See Maintenance on page 9.

Make sure the unit is positioned to receive maximum sunlight. If necessary, remove any objects or vegetation that might be casting a shadow on the unit. See Positioning the unit on page 6, or for more detailed information on solar installations.

After the unit is switched on, the pulse indicator light gives three long flashes (2 seconds) then the unit appears to be off.

The unit is in Standby mode because there has been insufficient sunlight to charge the battery. Charge the battery by placing the unit in full sunlight with the solar panel facing true south in the northern hemisphere and true north in the southern hemisphere.

The pulse indicator light flashes quickly several times and then there is a pause.

There may be a problem with the unit. Return the unit to a service agent appointed by

## **ELETTRICO RECINZIONE ENERGIZZANTE**

# **UTENTE MANUALE**

### **ATTENZIONE: LEGGERE TUTTE LE ISTRUZIONI**

Se Voi sospettare Quello IL unità È non lavorando, segui questi passaggi:

1. Disconnetti IL unità da IL recinzione E controllo  
Quello IL indicatore leggero È lampeggiante.
2. Controllare il collegamento e la tensione della batteria.
3. Controllare Quello IL voltaggio fra IL vivere \_ E terra  
terminali È maggiore di 7000 V, utilizzando UN recinzione  
voltaggio tester. 4. Se questi test Sono Ok tu Avere UN  
installazione \_ problema.

**Consultare il manuale utente per  
l'installazione e operativo Istruzioni**

## **Servicing**

*Please contact your local store.*

*Note: If you suspect the unit is not working, always check the battery connection and voltage before proceeding.*

## **Warranty**

This warranty does not cover defects caused by:

- Incorrect input voltage or polarity
- Damage to external wiring
- Physical mishandling
- Water immersion
- Vermin or insect damage

---

*Note:* This product has been manufactured to comply with international safety standards.

---

This product is warranted against faulty material and workmanship for a period of 2 years from date of purchase.

If a warranted defect occurs, return this product with proof of purchase to an authorised service centre.

Note:

- No responsibility is accepted for any accident or damage caused subsequent to any tampering with or modification to or misuse of this product, including (but not limited to) alterations made by anyone other than
- To the maximum extent permitted by law, this warranty is exclusive, personal to you and in lieu of all other warranties, representations or conditions relating to this product (whether express or implied and whenever arising) whether originating by statute, law, trade, custom or otherwise.
- The product warranty is only valid in the original country of purchase. Any claims made in another country may incur full repair costs at the owner's expense.