

# **VEVOR<sup>®</sup>**

**TOUGH TOOLS, HALF PRICE**

Technical Support and E-Warranty Certificate [www.vevor.com/support](http://www.vevor.com/support)

## **SALON CART USER MANUAL**

**MODEL NO.: T-0100C**

We continue to be committed to provide you tools with competitive price.

"Save Half", "Half Price" or any other similar expressions used by us only represents an estimate of savings you might benefit from buying certain tools with us compared to the major top brands and does not necessarily mean to cover all categories of tools offered by us. You are kindly reminded to verify carefully when you are placing an order with us if you are actually saving half in comparison with the top major brands.



# VEVOR<sup>®</sup>

TOUGH TOOLS, HALF PRICE

## Salon Cart

MODEL NO.: T-100C

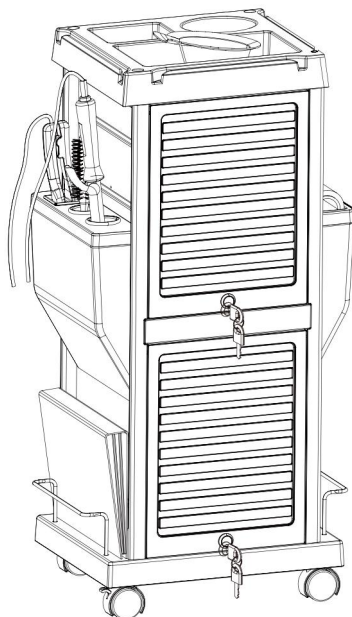

### NEED HELP? CONTACT US!

Have product questions? Need technical support? Please feel free to contact us:

**Technical Support and E-Warranty Certificate**  
**[www.vevor.com/support](http://www.vevor.com/support)**

This is the original instruction, please read all manual instructions carefully before operating. VEVOR reserves a clear interpretation of our user manual. The appearance of the product shall be subject to the product you received. Please forgive us that we won't inform you again if there are any technology or software updates on our product.

 **WARNING:**

**Please read this manual carefully before using the product. Failure to do so may result in serious injury.**

## **ASSEMBLY PRECAUTIONS**

1. Assemble only according to these instructions. Improper assembly can create hazards.
2. Wear ANSI-approved safety goggles and heavy-duty work gloves during assembly.
3. Keep the assembly area clean and well-lit.
4. Keep bystanders out of the area during assembly.
5. Do not assemble when tired or when under the influence of alcohol, drugs or medication.
6. The product capabilities apply to properly and completely assembled products only.
7. Assemble on a flat, level, hard and smooth surface capable of safely supporting the Salon Cart.
8. For additional information regarding the parts listed in the following pages, please refer to the Assembly Diagram of this manual. Unwrap and separate all parts in a clean work area.

**SAVE THESE INSTRUCTIONS**

# USE PRECAUTIONS

## TO PREVENT SERIOUS INJURY AND DEATH FROM TIPPING:

### 1. DO NOT SIT OR STAND ON THIS ITEM.

2. This product is not a toy Do not allow children to play with or near this item.

3. Do not exceed weight capacities, Empty lab cart before moving.

4. Use only on a flat, level, hard and smooth surface capable of safely supporting a fully loaded Salon Cart.

5. Use as intended only.







Inspect before every use; do not use if parts are loose or damaged.

## TECHNICAL SPECIFICATIONS

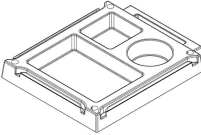
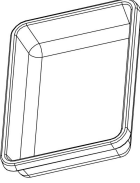
Model	T-100C
Color	Black
Product Dimensions(LxWxH)	370*420*855 mm
Packing Size(LxWxH)	835*255*450mm
Net Weight (kg)	About 8.41kg
Gross Weight (kg)	About 10kg

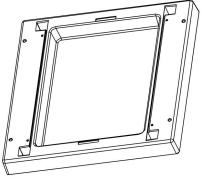
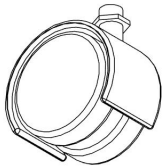
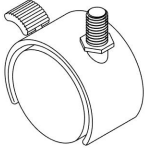
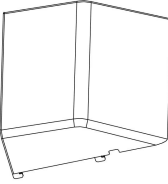
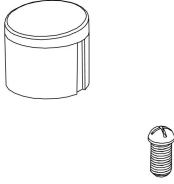
\*Products such as specifications, appearance, and design are subject to modification without prior notice.

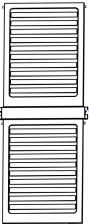
## PACKAGE CONTENTS

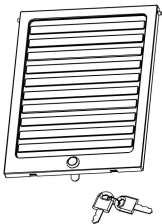
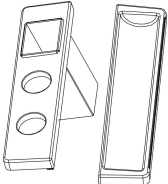
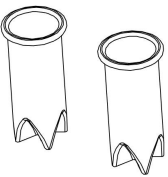
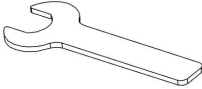
<b>A:Top tray</b>	<b>B:Removable tray</b>	<b>C:Side panel</b>	<b>D:Bottom tray</b>
<b>1PCS</b>	<b>6PCS</b>	<b>2PCS</b>	<b>1PCS</b>
			
<b>E:Wheel</b>	<b>F:Wheels with locks</b>	<b>G:Side compartment</b>	<b>H:Bolt and cap</b>
<b>2PCS</b>	<b>2PCS</b>	<b>2PCS</b>	<b>4SETS</b>
			
<b>I:Front connector with screws</b>	<b>J:Back panel</b>	<b>K:Balustrade</b>	<b>L:Front door with lock</b>
<b>1PCS</b>	<b>1SETS</b>	<b>2PCS</b>	<b>2PCS</b>
			
<b>M:Compartment cover</b>	<b>N: Appliance holders</b>	<b>O:Tool</b>	
<b>1SETS</b>	<b>1SETS</b>	<b>1PCS</b>	
			

## ASSEMBLY STEPS

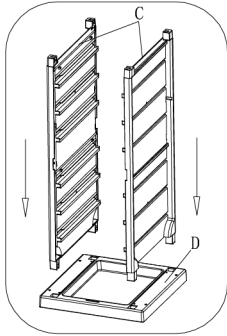

STEP 1

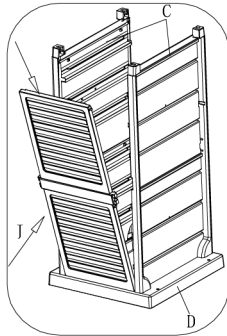

STEP 2

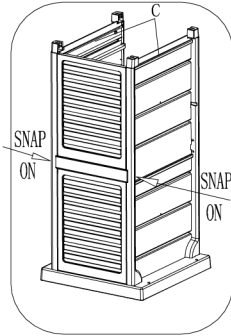

STEP 3

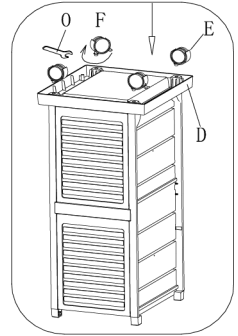

STEP 4

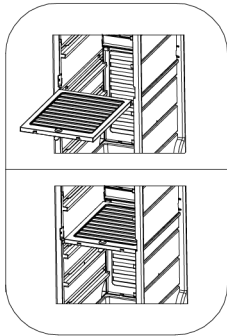

STEP 5

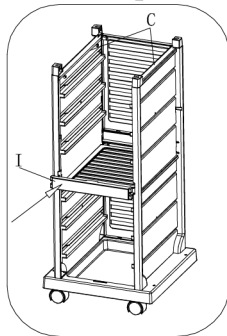

STEP 6

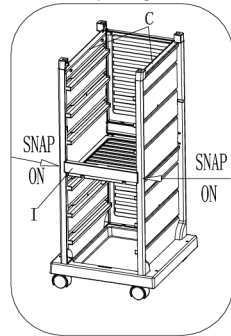

STEP 7

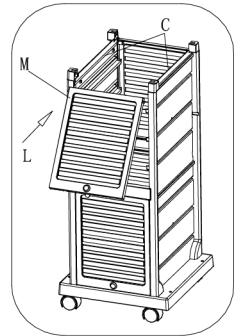

STEP 8

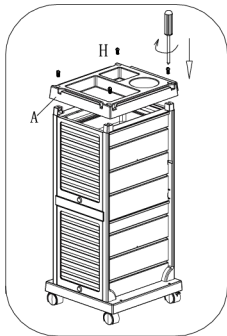

STEP 9

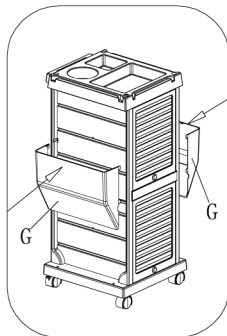

STEP 10

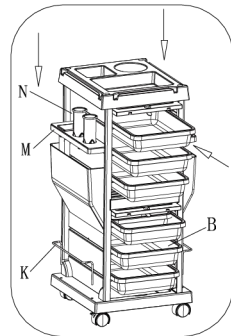

STEP 11

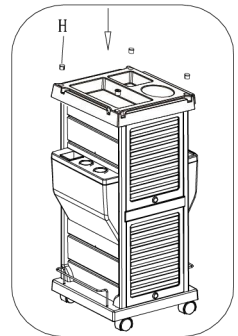

STEP 12

STEP 1: Insert the 2 side panels(C) into the bottom tray(D),  
STEP 2-3: Position the Back Panel(J) between the 2 Side Panels(C), and snap on  
in the middle section of the side panels.

STEP 4: Screw the 4 Wheels(E&F) into the threads in the bottom of the side panels, and fasten with the tool(O). Make sure the wheels are securely fasten.

STEP 5: Insert one of the Front Doors(M) into the rails in the middle of the side panels, and completely slide in.

STEP 6-7: Position the Front Connector(I) between middle section of the 2 Side Panels(C), and snap on.

STEP 8: Insert another Front Door(M) in to the rails in the top of side panels.

STEP 9: Cover the Top Tray(A) onto the top of side panels, and fasten with the 4 bolts/enclosed).Please DO NOT cover the Screw Hole Caps(H) at this moment.

STEP 10: Attach the Side Compartments(G) to the side panels. Make sure all the 4 hooks were aligned correctly to the slots in the side panels.

STEP 11: Put the Compartment Covers(M) and the Appliance Holders(N) onto the top of Side Compartments(G).Slide in the 4 Removable Trays(B), install the Blow Dryer Holder(K) and 2 Balusters(L).

STEP 12: If the above steps were successfully done, put on the Screw Hole Caps(H) into the 4 holes in the Top Tray.



## FEATURES

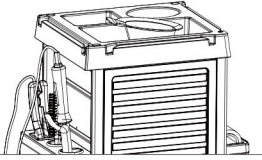

With holders for various hairdressing tools



With build-in metal appliance holders



With holder and saw cutter for foil rollers

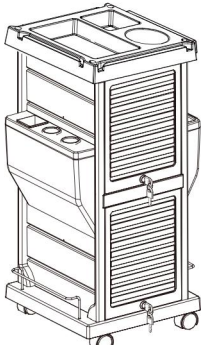

With 2 lockable doors that really work.  
Universal key for both

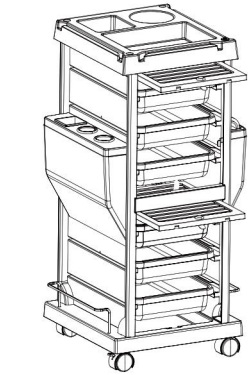

The door slips smoothly into the cabinet and "disappears"

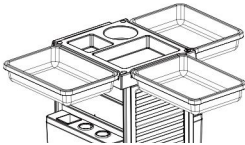

Removable trays can be clipped to both sides of the top, triple your working space



Adequate space for large bottles



Comfortably accommodate your Color Charts or Magazines

**Manufacturer:** Shanghaimuxinmuyeyouxiangongsi

**Address:** Baoshanqu Shuangchenglu 803long 11hao 1602A-1609shi  
Shanghai

**Imported to AUS:** SIHAO PTY LTD. 1 ROKEVA STREETEASTWOOD  
NSW 2122 Australia

**Imported to USA:** Sanven Technology Ltd.

Suite 250,9166 Anaheim Place, Rancho Cucamonga, CA 91730



SHUNSHUN GmbH

Römeräcker 9 Z2021,76351

Linkenheim-Hochstetten,Germany

euvertreter@gmail.com

+49 1727041930



Pooledas Group Ltd

Unit 5 Albert Edward House, The

Pavilions Preston, United Kingdom

pooledas123@gmail.com

Tel: 01772418127

**Made In China**



**VEVOR<sup>®</sup>**

**TOUGH TOOLS, HALF PRICE**

**Technical Support and E-Warranty Certificate**

**[www.vevor.com/support](http://www.vevor.com/support)**

# **VEVOR<sup>®</sup>**

**TOUGH TOOLS, HALF PRICE**

Techniczny Certyfikat wsparcia i e-gwarancji [www.vevor.com/support](http://www.vevor.com/support)

## **WÓZEK SALONOWY INSTRUKCJA OBSŁUGI \_**

**MODEL NR.: T-0 100C**

We continue to be committed to provide you tools with competitive price.

"Save Half", "Half Price" or any other similar expressions used by us only represents an estimate of savings you might benefit from buying certain tools with us compared to the major top brands and does not necessarily mean to cover all categories of tools offered by us. You are kindly reminded to verify carefully when you are placing an order with us if you are actually saving half in comparison with the top major brands.



# VEVOR<sup>®</sup>

TOUGH TOOLS, HALF PRICE

## Salon Cart

NR MODELU: T-100C

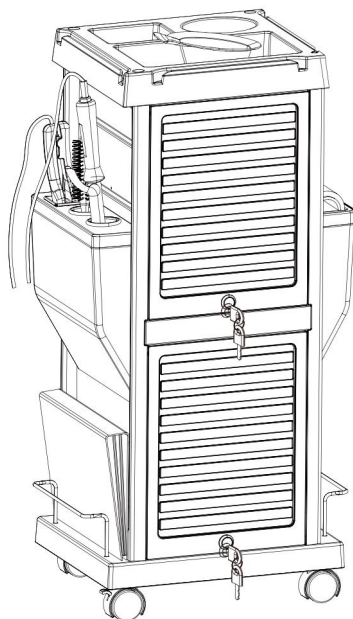

### NEED HELP? CONTACT US!

Have product questions? Need technical support? Please feel free to contact us:

**Technical Support and E-Warranty Certificate**  
**[www.vevor.com/support](http://www.vevor.com/support)**

This is the original instruction, please read all manual instructions carefully before operating. VEVOR reserves a clear interpretation of our user manual. The appearance of the product shall be subject to the product you received. Please forgive us that we won't inform you again if there are any technology or software updates on our product.

## OSTRZEŻENIE:

Przed użyciem produktu prosimy o dokładne zapoznanie się z niniejszą instrukcją. Niezastosowanie się do tego może spowodować poważne obrażenia.

## ŚRODKI OSTROŻNOŚCI PRZY MONTAŻU

9. Montaż wyłącznie zgodnie z niniejszą instrukcją. Nieprawidłowy montaż może stworzyć zagrożenie.
10. Podczas montażu należy nosić okulary ochronne i wytrzymałe rękawice robocze zatwierdzone przez ANSI.
11. Utrzymuj miejsce zbiórki w czystości i dobrze oświetlone.
12. Podczas montażu trzymaj osoby postronne z dala od obszaru.
13. Nie należy montować, gdy jest się zmęczonym lub pod wpływem alkoholu, narkotyków lub leków.
14. Możliwości produktu dotyczą wyłącznie produktów prawidłowo i całkowicie zmontowanych.
15. Zmontuj na płaskiej, poziomej, twardej i gładkiej powierzchni, która może bezpiecznie utrzymać wózek salonowy.
16. Dodatkowe informacje dotyczące części wymienionych na kolejnych stronach można znaleźć w schemacie montażu w niniejszej instrukcji. Rozpakuj i oddziel wszystkie części w czystym miejscu pracy.

ZACHOWAJ TE INSTRUKCJE



# STOSOWAĆ ŚRODKI OSTROŻNOŚCI

ABY ZAPOBIEC POWAŻNYM OBRAŻENIOM LUB ŚMIERCI W PRZYPADKU WYWROTU:

## 6. NIE SIEDŹ ANI NIE STAJ NA TYM PRZEDMIOCIE.

7. Ten produkt nie jest zabawką. Nie pozwalaj dzieciom bawić się tym przedmiotem lub w jego pobliżu.

8. Nie przekraczaj dopuszczalnej masy. Opróżnij wózek laboratoryjny przed przeniesieniem.

9. Używaj wyłącznie na płaskiej, równej, twardej i gładkiej powierzchni, która może bezpiecznie utrzymać w pełni załadowany wózek salonowy.

10. Używaj wyłącznie zgodnie z przeznaczeniem.







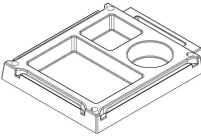
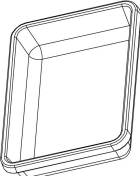

Sprawdź przed każdym użyciem; nie używać, jeśli części są luźne lub uszkodzone.

## TECHNICAL SPECIFICATIONS

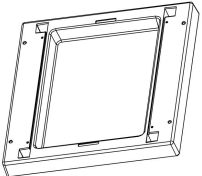
Model	T -100C
Kolor	Czarny _
Wymiary produktu (DxSxW)	370*420*855mm
Rozmiar opakowania (DxSxW)	835*255* 450mm
Masa netto (kg)	Okolo 8,41 kg
Masa brutto (kg)	Okolo 10 kg

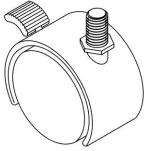
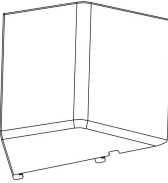
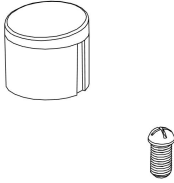
\*Produkty takie jak dane techniczne, wygląd i konstrukcja mogą podlegać modyfikacjom bez wcześniejszego powiadomienia.

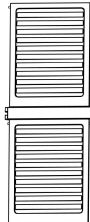
## PACKAGE CONTENTS

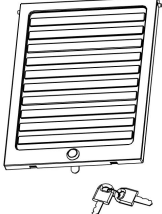
Odp.: Górna taca	B: Wyjmowana taca	C: Panel boczny	D: Dolna taca
1 szt. S	6szt	2szt	1 szt. S
			
E: Hej l	F: Koła z blokadami	G: Przedział boczny	H: Śruba i czapka
2szt	2szt	2szt	4ZESTAWY
			
I: Złącze przednie ze śrubami	J: Panel tylny	K: Balustrada	L: Prząd drzwi z zamkiem
1 szt. S	1ZESTAWY	2szt	2szt
			
M: Pokrywa przedziału	N: Uchwyty na urządzenia	O: Narzędzie	
1ZESTAWY	1ZESTAWY	1 szt	

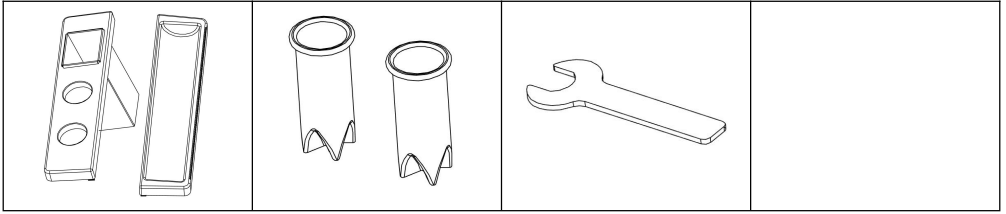

**ASSEMBLY STEPS**

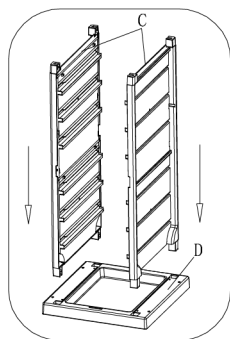

STEP 1

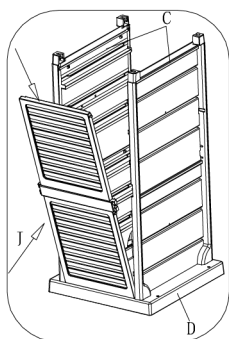

STEP 2

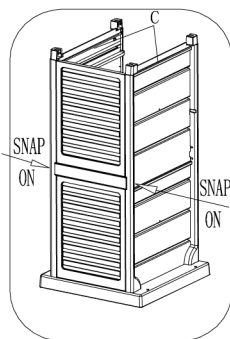

STEP 3

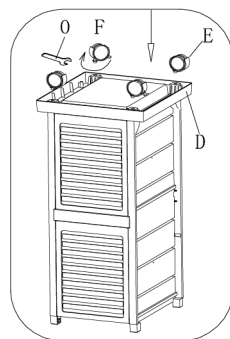

STEP 4

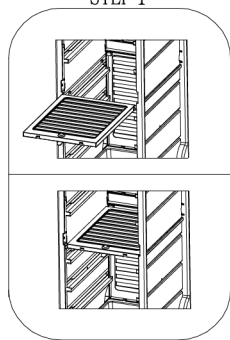

STEP 5

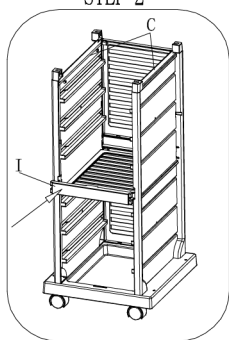

STEP 6

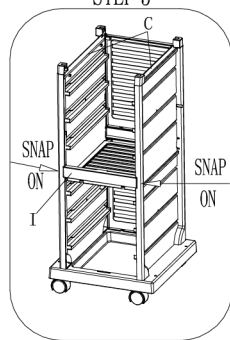

STEP 7

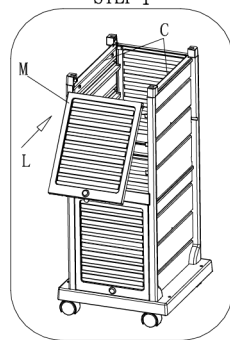

STEP 8

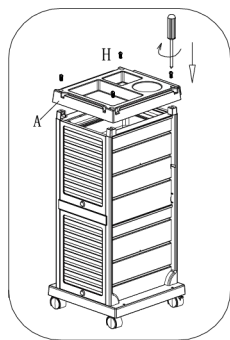

STEP 9

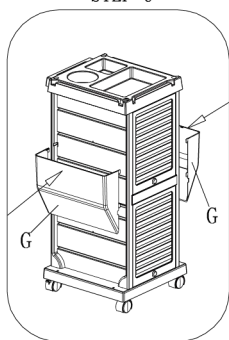

STEP 10

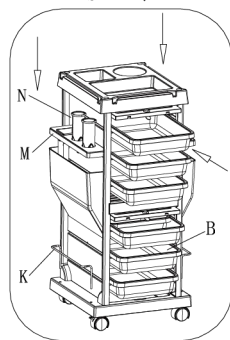

STEP 11

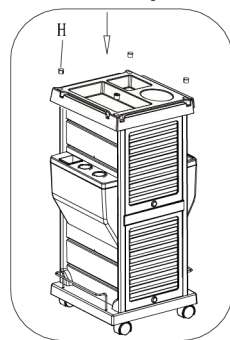

STEP 12

**KROK 1 :** Włóż 2 panele boczne (C) do dolnej tacy (D),  
**KROK 2-3:** Umieść panel tylny (J) pomiędzy 2 panelami bocznymi (C) i zatrzaśnij w środkowej części paneli bocznych .  
**KROK 4:** Wkręć 4 koła (E i F ) w gwinty w dolnej części paneli bocznych i przymocuj za pomocą narzędzia ( O ). Upewnij się, że koła są dobrze zamocowane.

KROK 5: Włóż jedne z drzwi przednich (M) w szyny pośrodku paneli bocznych i wsuń je całkowicie.

KROK 6-7: Umieść złącze przednie ( I ) pomiędzy środkową częścią 2 paneli bocznych (C) i zatrzaśnij .

KROK 8: Włóż kolejne drzwi przednie (M) do szyn w górnej części paneli bocznych.

KROK 9: Przykryj górną tacę ( A ) na górze paneli bocznych i przymocuj 4 śrubami/w zestawie). W tym momencie NIE zakrywaj zaślepek otworów na śruby (H) .

KROK 10: Przymocuj przedziały boczne (G) do paneli bocznych. Upewnij się, że wszystkie 4 haczyki zostały prawidłowo dopasowane do szczelin w panelach bocznych.

11 : Załóż pokrywy przegród (M ) i uchwyty na urządzenia (N ) na górę przegród bocznych (G). Wsuń 4 wyjmowane tace (B), zamontuj Uchwyt suszarki (K) i 2 tralki (L).

KROK 12: Jeśli powyższe kroki zostały pomyślnie wykonane, załóż zaślepki na śruby (H) w 4 otwory w górnej tacy.

## FEATURES

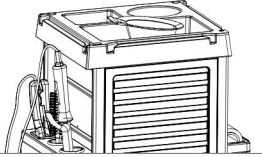

With holders for various hairdressing tools



With build-in metal appliance holders



With holder and saw cutter for foil rollers

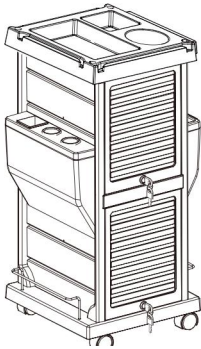

With 2 lockable doors that really work.  
Universal key for both

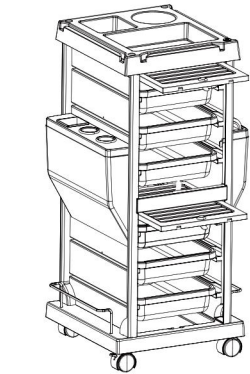

The door slips smoothly into the cabinet and "disappears"

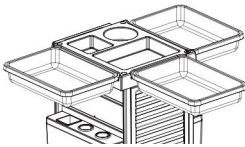

Removable trays can be clipped to both sides of the top, triple your working space



Adequate space for large bottles



Comfortably accommodate your Color Charts or Magazines

**Producent:** Shanghaimuxinmuyeyouxiangongsi

**Adres:** Baoshanqu Shuangchenglu 803long 11hao 1602A-1609shi  
Szanghaj

**Import do AUS:** SIHAO PTY LTD . 1 ROKEVA STREETEASTWOOD  
NSW 2122 Australia

**Import do USA:** Sanven Technology Ltd.

Apartament 250 , 9166 Anaheim Place, Rancho Cucamonga, Kalifornia  
91730



SHUNSHUN GmbH  
Römeräcker 9 Z2021,76351  
Linkenheim-Hochstetten, Germany  
euvertreter@gmail.com  
+49 1727041930



Pooledas Group Ltd  
Unit 5 Albert Edward House, The  
Pavilions Preston, United Kingdom  
pooledas123@gmail.com  
Tel: 01772418127

**Wyprodukowano w Chinach**





**VEVOR**<sup>®</sup>

**TOUGH TOOLS, HALF PRICE**

**Techniczny Certyfikat wsparcia i e-gwarancji**

**[www.vevor.com/support](http://www.vevor.com/support)**

# **VEVOR<sup>®</sup>**

**TOUGH TOOLS, HALF PRICE**

Technisch Support- und E-Garantie-Zertifikat [www.vevor.com/support](http://www.vevor.com/support)

## **SALONWAGEN**

## **BENUTZERHANDBUCH \_ \_**

**MODELL NR.: T-0 100C**

We continue to be committed to provide you tools with competitive price.

"Save Half", "Half Price" or any other similar expressions used by us only represents an estimate of savings you might benefit from buying certain tools with us compared to the major top brands and does not necessarily mean to cover all categories of tools offered by us. You are kindly reminded to verify carefully when you are placing an order with us if you are actually saving half in comparison with the top major brands.



# VEVOR<sup>®</sup>

TOUGH TOOLS, HALF PRICE

## Salon Cart

MODELL-NR.: T-100C

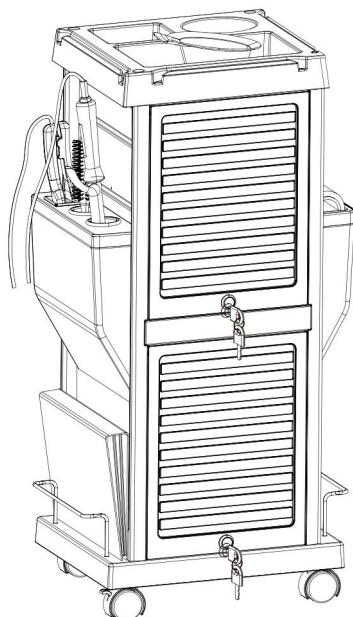

### NEED HELP? CONTACT US!

Have product questions? Need technical support? Please feel free to contact us:

**Technical Support and E-Warranty Certificate**  
**[www.vevor.com/support](http://www.vevor.com/support)**

This is the original instruction, please read all manual instructions carefully before operating. VEVOR reserves a clear interpretation of our user manual. The appearance of the product shall be subject to the product you received. Please forgive us that we won't inform you again if there are any technology or software updates on our product.

 **WARNUNG:**

**Bitte lesen Sie dieses Handbuch sorgfältig durch, bevor Sie das Produkt verwenden. Andernfalls kann es zu schweren Verletzungen kommen.**

## **VORSICHTSMASSNAHMEN BEI DER MONTAGE**

17. Montieren Sie es nur gemäß dieser Anleitung. Durch unsachgemäße Montage können Gefahren entstehen.
18. Tragen Sie während der Montage eine ANSI-zugelassene Schutzbrille und strapazierfähige Arbeitshandschuhe.
19. Halten Sie den Montagebereich sauber und gut beleuchtet.
20. Halten Sie Unbeteiligte während der Montage vom Bereich fern.
21. Nicht aufbauen, wenn Sie müde sind oder unter dem Einfluss von Alkohol, Drogen oder Medikamenten stehen.
22. Die Produkteigenschaften gelten nur für ordnungsgemäß und vollständig montierte Produkte.
23. Auf einer flachen, ebenen, harten und glatten Oberfläche montieren, die den Salonwagen sicher tragen kann.
24. Weitere Informationen zu den auf den folgenden Seiten aufgeführten Teilen finden Sie im Montagediagramm dieser Anleitung. Packen Sie alle Teile aus und trennen Sie sie an einem sauberen Arbeitsplatz.

**ANLEITUNG AUFBEWAHREN \_**

# VORSICHTSMASSNAHMEN VERWENDEN

UM SCHWERE VERLETZUNGEN UND TOD DURCH UMKIPPEN ZU VERMEIDEN:

11. SITZEN ODER STEHEN SIE NICHT AUF DIESEM ARTIKEL.

12. Dieses Produkt ist kein Spielzeug. Erlauben Sie Kindern nicht, mit oder in der Nähe dieses Artikels zu spielen.

13. Überschreiten Sie nicht die Gewichtskapazität. Leeren Sie den Laborwagen, bevor Sie ihn bewegen.

14. Nur auf einer flachen, ebenen, harten und glatten Oberfläche verwenden, die einen voll beladenen Salonwagen sicher tragen kann.

15. Nur bestimmungsgemäß verwenden.

Vor jedem Gebrauch prüfen; Nicht verwenden, wenn Teile lose oder beschädigt sind.







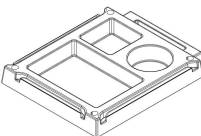
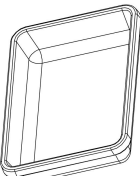

## TECHNICAL SPECIFICATIONS

Modell	T- 100C
Farbe	Schwarz _
Produktabmessungen (LxBxH)	370*420*855 mm
Verpackungsgröße (LxBxH)	835*255*450 mm
Nettogewicht / kg)	Ungefähr 8,41 kg
Bruttogewicht (kg)	Etwa 10 kg

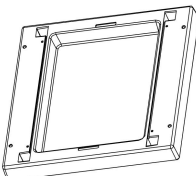
\*Produkte wie Spezifikationen, Aussehen und Design können ohne

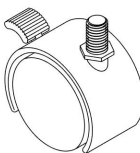
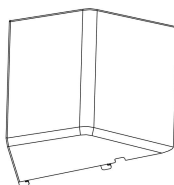
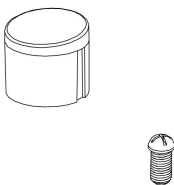
vorherige Ankündigung geändert werden.

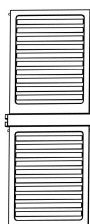
## PACKAGE CONTENTS

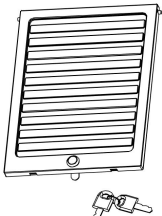
A: Oberes Fach	B: Abnehmbares Fach	C:Seitenwand	D: Unteres Fach
1 STÜCK	6 Stück	2 STÜCK	1 STÜCK
			
E: Wheel I	F: Räder mit Schlössern	G:Seitenfach	H: Bolzen und Deckel
2 STÜCK	2 STÜCK	2 STÜCK	4 SETS
			
I: Frontstecker mit Schrauben	J: Rückwand	K: Balusterade	L: Vorne Tür mit Schloss
1 STÜCK	1 SETS	2 STÜCK	2 STÜCK
			
M: Fachabdeckung	N: Gerätehalter	O: Werkzeug	

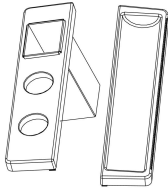
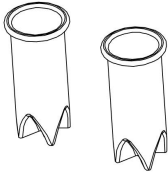
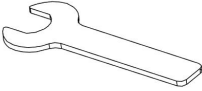
1 SETS	1 SETS	1 STÜCK	
			

## ASSEMBLY STEPS



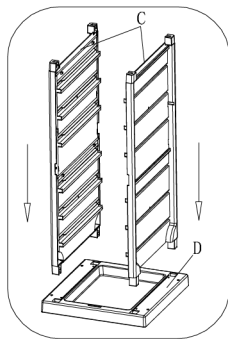

STEP 1

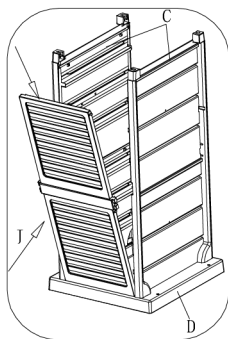

STEP 2

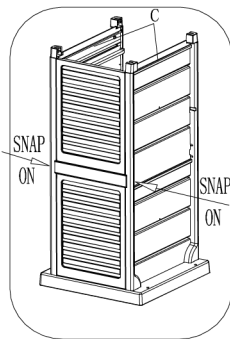

STEP 3

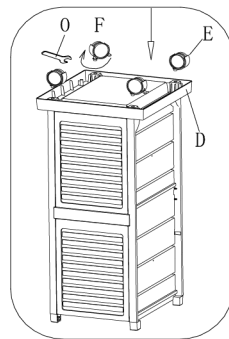

STEP 4

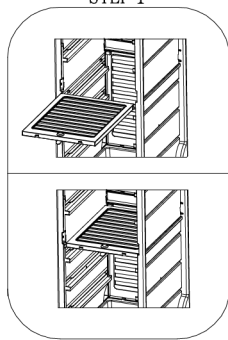

STEP 5

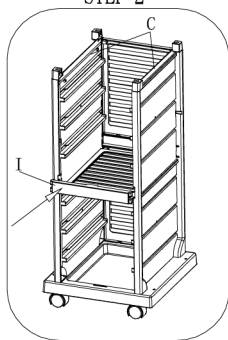

STEP 6

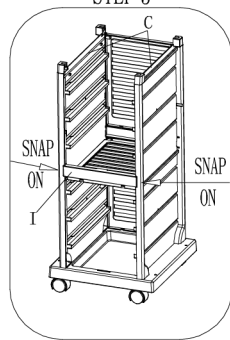

STEP 7

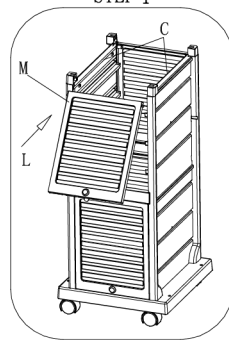

STEP 8

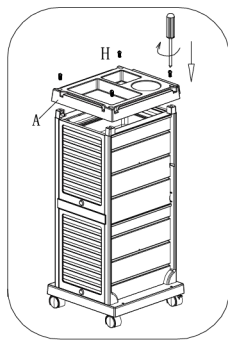

STEP 9

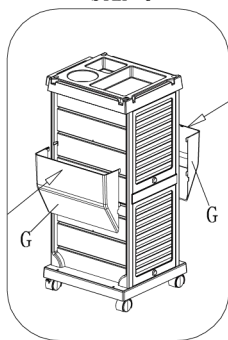

STEP 10

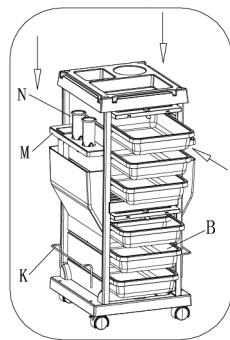

STEP 11

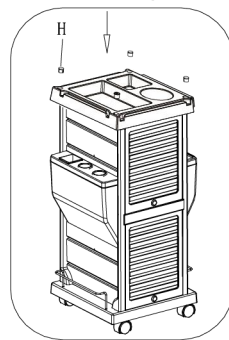

STEP 12

**SCHRITT 1 :** Setzen Sie die beiden Seitenwände (C) in die untere Ablage (D) ein.

**SCHRITT 2-3:** Positionieren Sie die Rückwand (J) zwischen den beiden Seitenwänden (C) und lassen Sie sie im Mittelteil der Seitenwände einrasten .

**SCHRITT 4:** Schrauben Sie die 4 Räder (E und F) in die Gewinde an der Unterseite der Seitenwände und befestigen Sie sie mit dem Werkzeug ( O ). Stellen Sie sicher, dass die Räder sicher befestigt sind.

SCHRITT 5: Setzen Sie eine der Vordertüren (M) in die Schienen in der Mitte der Seitenwände ein und schieben Sie sie vollständig hinein.

SCHRITT 6-7: Positionieren Sie den Frontstecker ( I ) zwischen dem Mittelteil der beiden Seitenwände (C) und lassen Sie ihn einrasten .

SCHRITT 8: Setzen Sie eine weitere Vordertür (M) in die Schienen oben in den Seitenwänden ein.

SCHRITT 9: Decken Sie die obere Ablage ( A) auf die Oberseite der Seitenwände ab und befestigen Sie sie mit den 4 beiliegenden Schrauben. Bitte decken Sie die Schraubenlochkappen (H) zu diesem Zeitpunkt NICHT ab .

SCHRITT 10: Befestigen Sie die Seitenfächer (G) an den Seitenwänden. Stellen Sie sicher, dass alle 4 Haken richtig an den Schlitzten in den Seitenwänden ausgerichtet sind.

SCHRITT 11: Setzen Sie die Fachabdeckungen (M ) und die Gerätehalter (N ) auf die Oberseite der Seitenfächer (G). Schieben Sie die 4 herausnehmbaren Ablagen (B) hinein und installieren Sie sie Föhnhalter (K) und 2 Baluster (L).

SCHRITT 12: Wenn die oben genannten Schritte erfolgreich durchgeführt wurden, stecken Sie die Schraublochkappen (H) in die 4 Löcher in der oberen Ablage.

## FEATURES

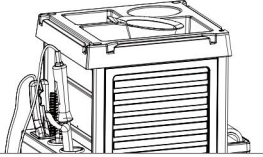

With holders for various hairdressing tools



With build-in metal appliance holders



With holder and saw cutter for foil rollers

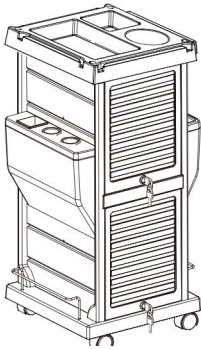

With 2 lockable doors that really work.  
Universal key for both

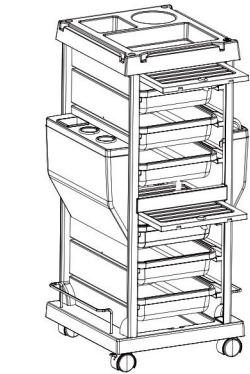

The door slips smoothly into the cabinet and "disappears"

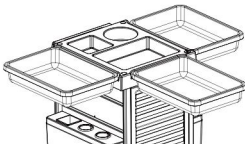

Removable trays can be clipped to both sides of the top, triple your working space



Adequate space for large bottles



Comfortably accommodate your Color Charts or Magazines

**Hersteller:** Shanghaimuxinmuyeyouxiangongsi

**Adresse:** Baoshanqu Shuangchenglu 803long 11hao 1602A-1609shi  
Shanghai

**Importiert nach AUS:** SIHAO PTY LTD . 1 ROKEVA  
STREETEASTWOOD NSW 2122 Australien

**Importiert in die USA:** Sanven Technology Ltd.  
Suite 250 , 9166 Anaheim Place, Rancho Cucamonga, CA 91730



SHUNSHUN GmbH  
Römeräcker 9 Z2021,76351  
Linkenheim-Hochstetten,Germany  
euvertreter@gmail.com  
+49 1727041930



Pooledas Group Ltd  
Unit 5 Albert Edward House, The  
Pavilions Preston, United Kingdom  
pooledas123@gmail.com  
Tel: 01772418127

**In China hergestellt**



**VEVOR<sup>®</sup>**

**TOUGH TOOLS, HALF PRICE**

**Technisch Support- und E-Garantiezertifikat**

**[www.vevor.com/support](http://www.vevor.com/support)**

# **VEVOR<sup>®</sup>**

**TOUGH TOOLS, HALF PRICE**

Technique Assistance et certificat de garantie électronique

[www.vevor.com/support](http://www.vevor.com/support)

## **CHARIOT DE SALON**

### **MANUEL DE L'UTILISATEUR**

**N° DE MODÈLE : T-0 100C**

We continue to be committed to provide you tools with competitive price.

"Save Half", "Half Price" or any other similar expressions used by us only represents an estimate of savings you might benefit from buying certain tools with us compared to the major top brands and does not necessarily mean to cover all categories of tools offered by us. You are kindly reminded to verify carefully when you are placing an order with us if you are actually saving half in comparison with the top major brands.





# VEVOR<sup>®</sup>

TOUGH TOOLS, HALF PRICE

## Salon Cart

Numéro de modèle : T-100C

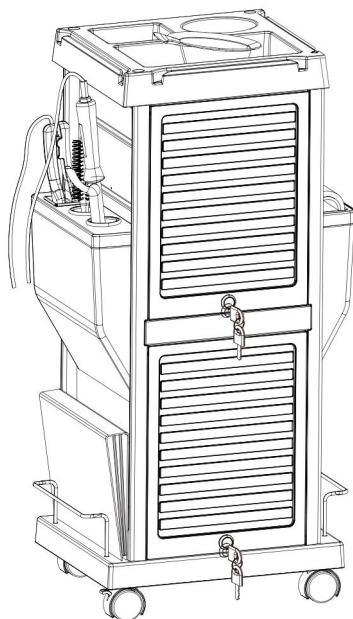

### NEED HELP? CONTACT US!

Have product questions? Need technical support? Please feel free to contact us:

**Technical Support and E-Warranty Certificate**  
**[www.vevor.com/support](http://www.vevor.com/support)**

This is the original instruction, please read all manual instructions carefully before operating. VEVOR reserves a clear interpretation of our user manual. The appearance of the product shall be subject to the product you received. Please forgive us that we won't inform you again if there are any technology or software updates on our product.

 **AVERTISSEMENT:**

**Veillez lire attentivement ce manuel avant d'utiliser le produit. Ne pas le faire pourrait entraîner des blessures graves.**

## **PRÉCAUTIONS DE MONTAGE**

25. Assemblez uniquement selon ces instructions. Un assemblage incorrect peut créer des dangers.
26. Portez des lunettes de sécurité approuvées par l'ANSI et des gants de travail robustes pendant l'assemblage.
27. Gardez la zone de rassemblement propre et bien éclairée.
28. Gardez les spectateurs hors de la zone pendant l' assemblage.
29. Ne vous rassemblez pas lorsque vous êtes fatigué ou sous l' influence de l' alcool, de drogues ou de médicaments.
30. Les capacités du produit s'appliquent uniquement aux produits correctement et complètement assemblés.
31. Assemblez-le sur une surface plane, nivelée, dure et lisse, capable de supporter le chariot de salon en toute sécurité.
32. Pour plus d'informations concernant les pièces répertoriées dans les pages suivantes, veuillez vous référer au schéma d'assemblage de ce manuel. Déballez et séparez toutes les pièces dans une zone de travail propre.

**CONSERVEZ CES INSTRUCTIONS**

# PRÉCAUTIONS D'UTILISATION

**POUR ÉVITER DES BLESSURES GRAVES ET LA MORT PAR BASCULEMENT :**

**16. NE PAS ÊTRE ASSIS OU DEBOUT SUR CET ARTICLE.**

17. Ce produit n'est pas un jouet. Ne laissez pas les enfants jouer avec ou à proximité de cet article.

18. Ne dépassez pas les capacités de poids. Videz le chariot de laboratoire avant de le déplacer.

19. Utiliser uniquement sur une surface plane, nivelée, dure et lisse, capable de supporter en toute sécurité un chariot de salon entièrement chargé.

20. Utiliser uniquement comme prévu.







Inspectez avant chaque utilisation ; ne pas utiliser si les pièces sont desserrées ou endommagées.

## TECHNICAL SPECIFICATIONS

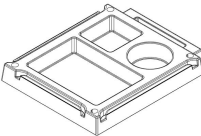
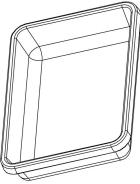
Modèle	T -100C
Couleur	Noir _
Dimensions du produit (LxlxH)	370*420*855 millimètres
Taille de l'emballage (LxlxH)	835*255*450 millimètres
Poids net / kg)	Environ 8,41kg _
Poids brut (kg)	Environ 10 kg

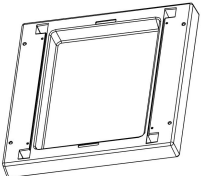
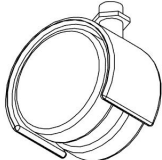
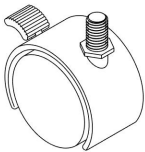
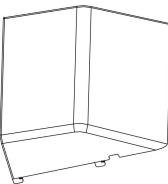
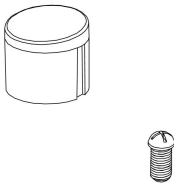
\*Les produits tels que les spécifications, l'apparence et la conception sont sujets à modification sans préavis.

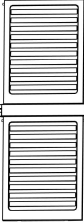
## PACKAGE CONTENTS

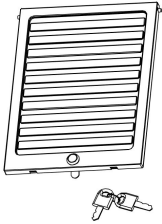
R : Plateau supérieur	B : Plateau amovible	C : panneau latéral	D : bac inférieur
1 PCS	6 pièces	2 pièces	1 PCS
			
E:Roue l	F : Roues avec verrous	G: Compartiment latéral	H : Boulon et casquette
2 pièces	2 pièces	2 pièces	4 ENSEMBLES
			
I : connecteur avant avec des vis	J : panneau arrière	K : Balustrade	L:Avant porte avec serrure
1 PCS	1SETS	2 pièces	2 pièces
			
M : couvercle du compartiment	N : Supports pour appareils	O:Outil	

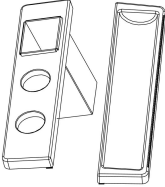
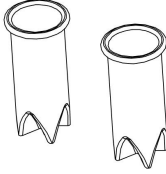
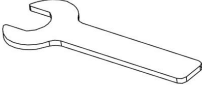
	électroménagers		
1SETS	1SETS	1 PCS	
			

## ASSEMBLY STEPS

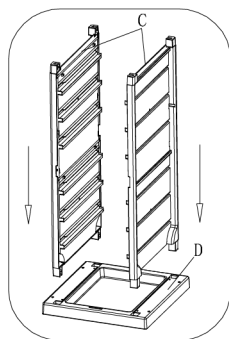

STEP 1

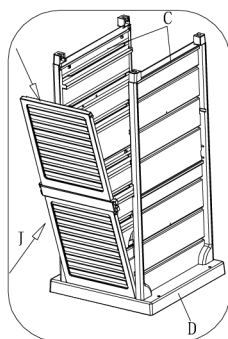

STEP 2

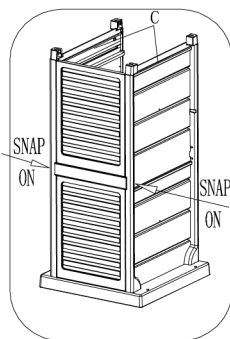

STEP 3

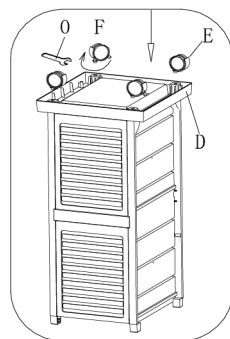

STEP 4

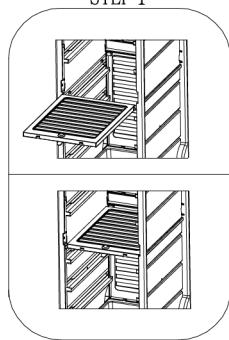

STEP 5

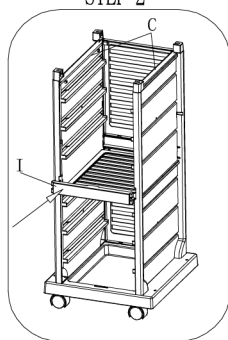

STEP 6

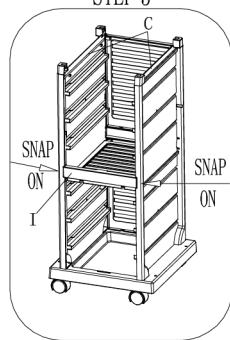

STEP 7

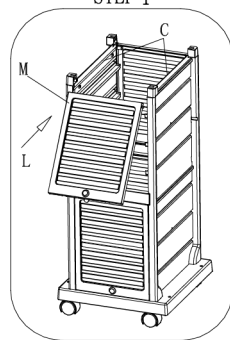

STEP 8

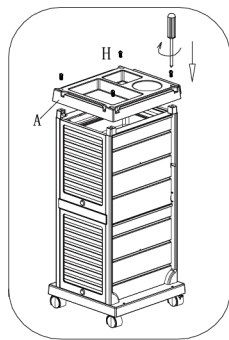

STEP 9

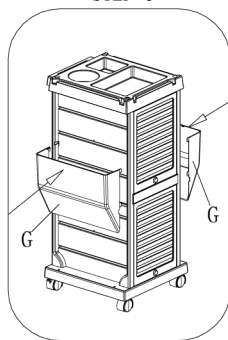

STEP 10

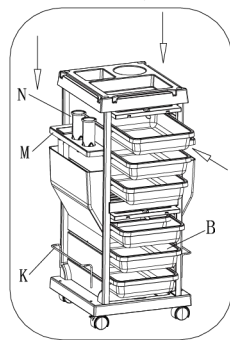

STEP 11

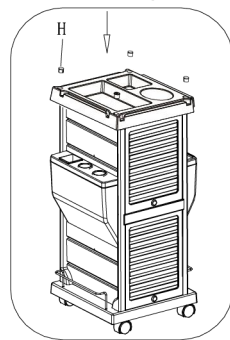

STEP 12

ÉTAPE 1 : Insérez les 2 panneaux latéraux(C) dans le plateau inférieur(D),  
 ÉTAPE 2-3 : Positionnez le panneau arrière (J) entre les 2 panneaux latéraux (C)  
 et enclenchez-le dans la section centrale des panneaux latéraux .  
 ÉTAPE 4 : Vissez les 4 roues (E et F ) dans les filetages en bas des panneaux  
 latéraux et fixez avec l'outil ( O ). Assurez-vous que les roues sont solidement  
 fixées.

ÉTAPE 5 : Insérez l'une des portes avant (M) dans les rails au milieu des panneaux latéraux et faites-la glisser complètement.

ÉTAPE 6-7 : Positionnez le connecteur avant ( I ) entre la section centrale des 2 panneaux latéraux (C) et enclenchez-le .

ÉTAPE 8 : Insérez une autre porte avant (M) dans les rails en haut des panneaux latéraux.

ÉTAPE 9 : Couvrez le plateau supérieur ( A ) sur le dessus des panneaux latéraux et fixez-le avec les 4 boulons/fournis). Veuillez NE PAS couvrir les capuchons des trous de vis (H) pour le moment .

ÉTAPE 10 : Fixez les compartiments latéraux (G) aux panneaux latéraux.

Assurez-vous que les 4 crochets sont correctement alignés sur les fentes des panneaux latéraux.

ÉTAPE 11 : Placez les couvercles des compartiments (M ) et les supports d'appareils (N ) sur le dessus des compartiments latéraux (G). Faites glisser les 4 plateaux amovibles (B), installez le Support pour sèche-cheveux (K) et 2 balustres (L).

ÉTAPE 12 : Si les étapes ci-dessus ont été effectuées avec succès, placez les capuchons de trou de vis (H) dans les 4 trous du plateau supérieur.

## FEATURES

---



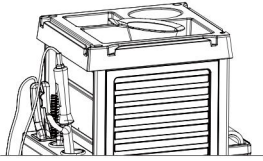

With holders for various hairdressing tools



With build-in metal appliance holders

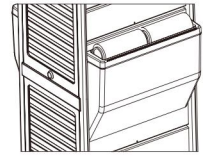

With holder and saw cutter for foil rollers

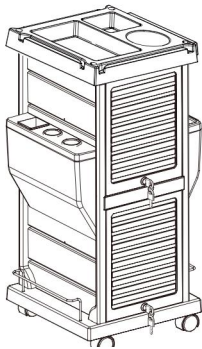

With 2 lockable doors that really work.  
Universal key for both



The door slips smoothly into the cabinet and "disappears"

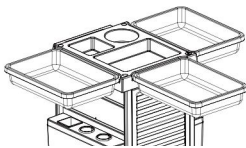

Removable trays can be clipped to both sides of the top, triple your working space



Adequate space for large bottles



Comfortably accommodate your Color Charts or Magazines

**Fabricant :** Shanghaimuxinmuyeyouxiangongsi

**Adresse :** Baoshanqu Shuangchenglu 803long 11hao 1602A-1609shi  
Shanghai

**Importé en Australie** : SIHAO PTY LTD . 1 ROKEVA STREETASTWOOD  
NSW 2122 Australie

**Importé aux États-Unis** : Sanven Technology Ltd.  
Suite 250 , 9166 Anaheim Place, Rancho Cucamonga, CA 91730



SHUNSHUN GmbH  
Römeräcker 9 Z2021,76351  
Linkenheim-Hochstetten, Germany  
euvertreter@gmail.com  
+49 1727041930



Pooledas Group Ltd  
Unit 5 Albert Edward House, The  
Pavilions Preston, United Kingdom  
pooledas123@gmail.com  
Tel: 01772418127

**Fabriqué en Chine**



**VEVOR**<sup>®</sup>

**TOUGH TOOLS, HALF PRICE**

**Technique Assistance et certificat de garantie électronique**

**[www.vevor.com/support](http://www.vevor.com/support)**

# **VEVOR<sup>®</sup>**

**TOUGH TOOLS, HALF PRICE**

Technisch Ondersteuning en e-garantiecertificaat [www.vevor.com/support](http://www.vevor.com/support)

## **SALONWAGEN**

## **HANDLEIDING \_ \_**

**MODELNR.: T-0 100C**

We continue to be committed to provide you tools with competitive price.

"Save Half", "Half Price" or any other similar expressions used by us only represents an estimate of savings you might benefit from buying certain tools with us compared to the major top brands and does not necessarily mean to cover all categories of tools offered by us. You are kindly reminded to verify carefully when you are placing an order with us if you are actually saving half in comparison with the top major brands.



# VEVOR<sup>®</sup>

TOUGH TOOLS, HALF PRICE

## Salon Cart

MODELNR.: T-100C

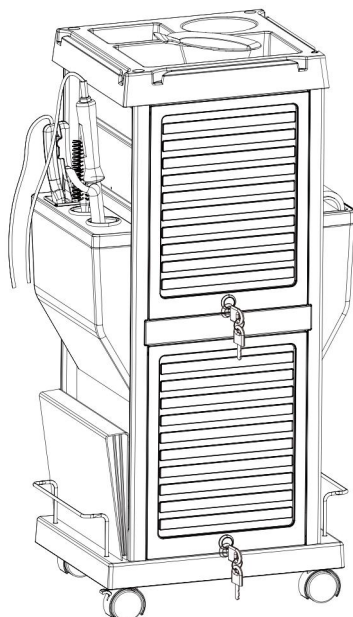

### NEED HELP? CONTACT US!

Have product questions? Need technical support? Please feel free to contact us:

**Technical Support and E-Warranty Certificate**  
**[www.vevor.com/support](http://www.vevor.com/support)**

This is the original instruction, please read all manual instructions carefully before operating. VEVOR reserves a clear interpretation of our user manual. The appearance of the product shall be subject to the product you received. Please forgive us that we won't inform you again if there are any technology or software updates on our product.

## **WAARSCHUWING:**

**Lees deze handleiding zorgvuldig door voordat u het product gebruikt. Als u dit niet doet, kan dit leiden tot ernstig letsel.**

## **MONTAGEVOORZORGSMATREGELEN**

33. Monteer uitsluitend volgens deze instructies. Onjuiste montage kan gevaren veroorzaken.
34. Draag tijdens de montage een ANSI-goedgekeurde veiligheidsbril en stevige werkhandschoenen.
35. Houd de verzamelplaats schoon en goed verlicht.
36. Houd omstanders tijdens de montage uit de buurt.
37. Niet monteren als u moe bent of onder invloed bent van alcohol, drugs of medicijnen.
38. De productmogelijkheden zijn alleen van toepassing op correct en volledig gemonteerde producten.
39. Monteer op een vlakke, vlakke, harde en gladde ondergrond die de Salonwagen veilig kan ondersteunen.
40. Voor aanvullende informatie over de onderdelen die op de volgende pagina's worden vermeld, verwijzen wij u naar het montageschema van deze handleiding. Pak alle onderdelen uit en scheid ze van elkaar op een schone werkplek.

**BEWAAR DEZE INSTRUCTIES**



# GEBRUIK VOORZORGSMAATREGELEN

OM ERNSTIG LETSEL EN DE DOOD DOOR KANTELEN TE VOORKOMEN:

21. ZIT OF STA NIET OP DIT ITEM.

22. Dit product is geen speelgoed. Laat kinderen niet met of in de buurt van dit artikel spelen.

23. Overschrijd het gewicht niet. Maak de laboratoriumwagen leeg voordat u hem verplaatst.

24. Alleen gebruiken op een vlakke, vlakke, harde en gladde ondergrond die een volledig beladen salonwagen veilig kan ondersteunen.

25. Alleen gebruiken zoals bedoeld.

Inspecteer vóór elk gebruik; niet gebruiken als onderdelen los of beschadigd zijn.

## TECHNICAL SPECIFICATIONS

Model	T- 100C
Kleur	B gebrek
Productafmetingen (LxBxH)	370*420*855 mm
Verpakkingsgrootte (LxBxH)	835*255*450 mm
Netto gewicht / kg)	Ongeveer 8,41kg _
Bruto gewicht (kg)	Ongeveer 10kg _

\*Producten zoals specificaties, uiterlijk en ontwerp kunnen zonder voorafgaande kennisgeving worden gewijzigd.

## PACKAGE CONTENTS

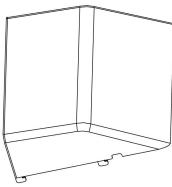
A: Bovenste lade	B: Verwijderbare lade	C: Zijpaneel	D: Onderbak
1 STUK	6 STUKS	2 STUKS	1 STUK
			
E: Wie I	F: Wielen met sloten	G: Zijvak	H: Bout en dop
2 STUKS	2 STUKS	2 STUKS	4SETS
			
I: Frontconnector met schroeven	J: Achterpaneel	K: Balustrade	L: Voorkant deur met slot
1 STUK	1SETS	2 STUKS	2 STUKS
			
M: Compartimentafdekkings	N: Apparaathouders	O: Gereedschap	
1SETS	1SETS	1 STUK	

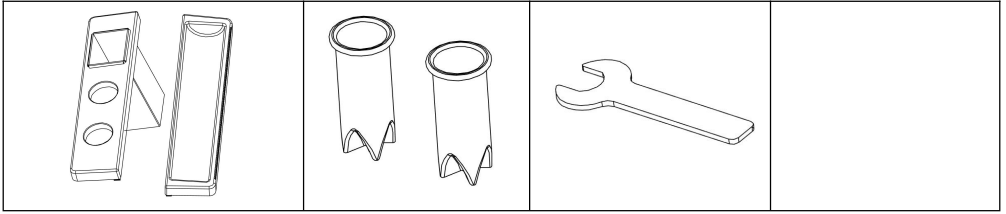

**ASSEMBLY STEPS**

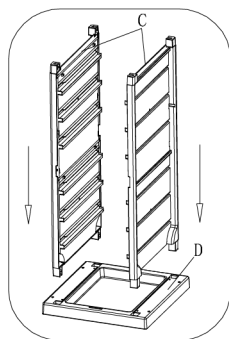

STEP 1

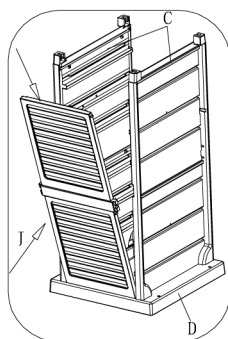

STEP 2

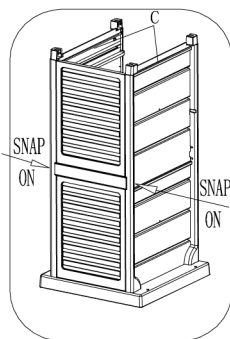

STEP 3

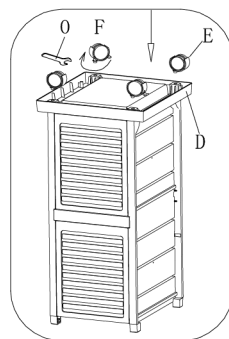

STEP 4

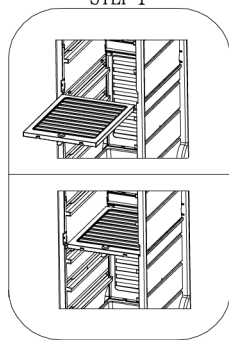

STEP 5

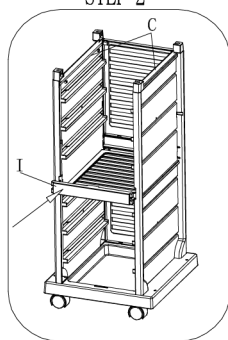

STEP 6

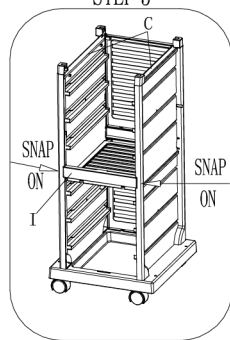

STEP 7

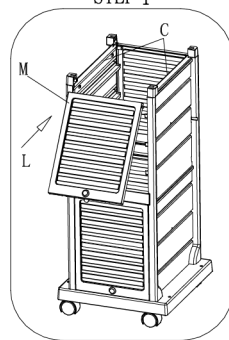

STEP 8

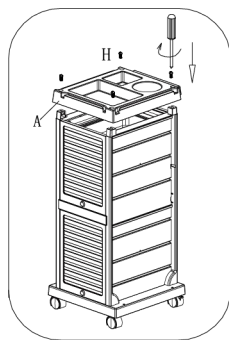

STEP 9

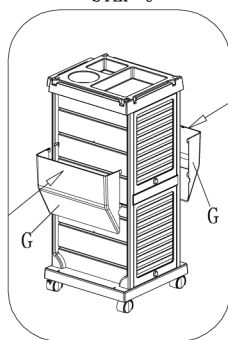

STEP 10

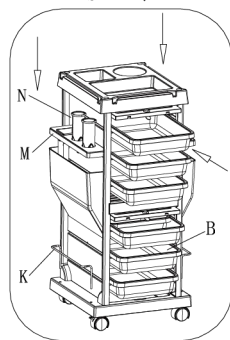

STEP 11

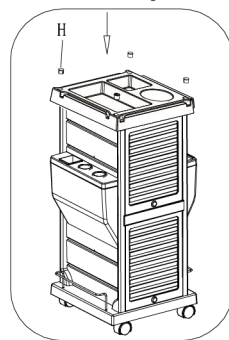

STEP 12

STAP 1 : Plaats de 2 zijpanelen (C) in de onderste lade (D),  
 STAP 2-3: Plaats het achterpaneel (J) tussen de 2 zijpanelen (C) en klik het vast in het middengedeelte van de zijpanelen .  
 STAP 4: Schroef de 4 wielen (E & F) in de schroefdraad aan de onderkant van de zijpanelen en zet ze vast met het gereedschap ( O ). Zorg ervoor dat de wielen stevig vastzitten.

STAP 5: Steek een van de voordeuren (M) in de rails in het midden van de zijpanelen en schuif deze volledig naar binnen.

STAP 6-7: Plaats de voorste connector ( I ) tussen het middengedeelte van de 2 zijpanelen (C) en klik deze vast .

STAP 8: Steek nog een voordeur (M) in de rails bovenaan de zijpanelen.

STAP 9: Bedek de bovenste lade ( A ) op de bovenkant van de zijpanelen en zet deze vast met de 4 bouten/meegeleverd). Bedek de schroefgatdoppen (H) op dit moment NIET .

STAP 10: Bevestig de zijvakken (G) aan de zijpanelen. Zorg ervoor dat alle vier de haken correct zijn uitgelijnd met de sleuven in de zijpanelen.

STAP 11: Plaats de compartimentafdekkingen (M ) en de apparaathouders (N ) op de bovenkant van de zijcompartimenten (G). Schuif de 4 verwijderbare laden (B) erin, installeer de Föhnhouder (K) en 2 balusters (L).

STAP 12: Als de bovenstaande stappen met succes zijn uitgevoerd, plaatst u de schroefgatdoppen (H) in de 4 gaten in de bovenste lade.

## FEATURES

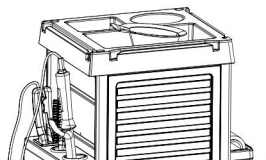

With holders for various hairdressing tools



With build-in metal appliance holders



With holder and saw cutter for foil rollers

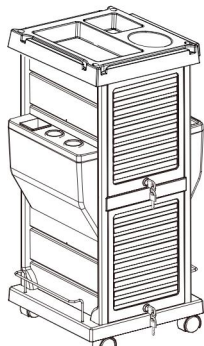

With 2 lockable doors that really work.  
Universal key for both

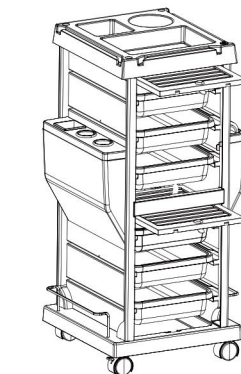

The door slips smoothly into the cabinet and "disappears"

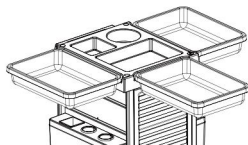

Removable trays can be clipped to both sides of the top, triple your working space



Adequate space for large bottles



Comfortably accommodate your Color Charts or Magazines

**Fabrikant:** Shanghaimuxinmuyeyouxiangongsi

**Adres:** Baoshanqu Shuangchenglu 803long 11hao 1602A-1609shi  
Shanghai

**Geïmporteerd naar AUS:** SIHAO PTY LTD . 1 ROKEVA  
STREETEASTWOOD NSW 2122 Australië

**Geïmporteerd naar de VS:** Sanven Technology Ltd.  
Suite 250 , 9166 Anaheim Place, Rancho Cucamonga, CA 91730



SHUNSHUN GmbH  
Römeräcker 9 Z2021,76351  
Linkenheim-Hochstetten, Germany  
euvertreter@gmail.com  
+49 1727041930



Pooledas Group Ltd  
Unit 5 Albert Edward House, The  
Pavilions Preston, United Kingdom  
pooledas123@gmail.com  
Tel: 01772418127

**Gemaakt in China**





**VEVOR**<sup>®</sup>

**TOUGH TOOLS, HALF PRICE**

**Technisch Ondersteuning en e-garantiecertificaat**

**[www.vevor.com/support](http://www.vevor.com/support)**

# **VEVOR<sup>®</sup>**

**TOUGH TOOLS, HALF PRICE**

Teknisk Support och e-garanticertifikat [www.vevor.com/support](http://www.vevor.com/support)

## **SALONGSVAGN**

# **ANVÄNDARMANUAL \_ \_**

**MODELL NR.: T-0 100C**

We continue to be committed to provide you tools with competitive price.

"Save Half", "Half Price" or any other similar expressions used by us only represents an estimate of savings you might benefit from buying certain tools with us compared to the major top brands and does not necessarily mean to cover all categories of tools offered by us. You are kindly reminded to verify carefully when you are placing an order with us if you are actually saving half in comparison with the top major brands.



# VEVOR<sup>®</sup>

TOUGH TOOLS, HALF PRICE

## Salon Cart

MODELLNR: T-100C

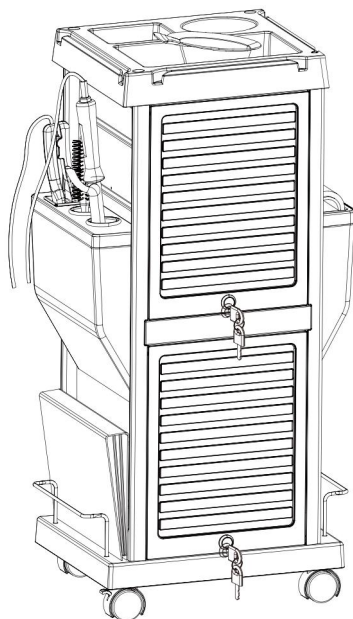

### NEED HELP? CONTACT US!

Have product questions? Need technical support? Please feel free to contact us:

**Technical Support and E-Warranty Certificate**  
**[www.vevor.com/support](http://www.vevor.com/support)**

This is the original instruction, please read all manual instructions carefully before operating. VEVOR reserves a clear interpretation of our user manual. The appearance of the product shall be subject to the product you received. Please forgive us that we won't inform you again if there are any technology or software updates on our product.

 **VARNING:**

**Läs denna bruksanvisning noggrant innan du använder produkten. Underlåtenhet att göra det kan leda till allvarliga skador.**

## **FÖRSIKTIGHETSÅTGÄRDER FÖR MONTERING**

41. Montera endast enligt dessa instruktioner. Felaktig montering kan skapa faror.
42. Använd ANSI-godkända skyddsglasögon och kraftiga arbetshandskar vid montering.
43. Håll monteringsområdet rent och väl upplyst.
44. Håll åskådare borta från området under monteringen.
45. Sätt dig inte ihop när du är trött eller påverkad av alkohol, droger eller mediciner.
46. Produktegenskaperna gäller endast för korrekt och färdigmonterade produkter.
47. Montera på en plan, jämn, hård och slät yta som säkert kan stödja salongvagnen.
48. För ytterligare information om delarna som listas på följande sidor, se monteringsdiagrammet i denna manual. Packa upp och separera alla delar på ett rent arbetsområde.

**SPARA DESSA E INSTRUKTIONER**

# ANVÄND FÖRSIKTIGHETSÅTGÄRDER

FÖR ATT FÖRHINDRA ALLVARLIGA SKADA OCH DÖDSFALL VID VÄLLNING:

26. SIT ELLER STÅ INTE PÅ DETTA FÖREMÅL.

27. Denna produkt är inte en leksak. Tillåt inte barn att leka med eller i närheten av detta föremål.

28. Överskrid inte viktkapaciteten, Töm labbvagnen innan du flyttar.

29. Använd endast på en plan, jämn, hård och slät yta som säkert kan bära en fullastad salongsvagn.

30. Använd endast som avsett.





Inspektera före varje användning; Använd inte om delar är lösa eller skadade.

## TECHNICAL SPECIFICATIONS

Modell	T- 100C
Färg	B brist
Produktmått (LxBxH)	370*420*855 mm
Förpackningsstorlek (LxBxH)	835*255*450 mm
Nettovikt (kg)	Ca 8,41 kg
Bruttovikt (kg)	Ca 10 kg

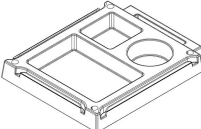
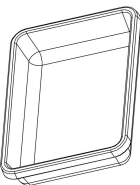
\*Produkter som specifikationer, utseende och design kan ändras utan föregående meddelande.

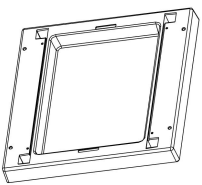
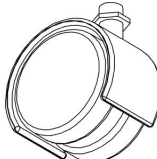
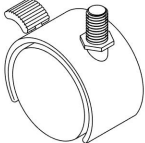
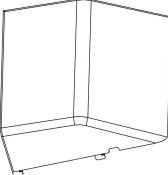
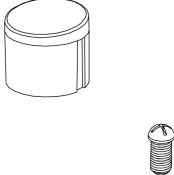
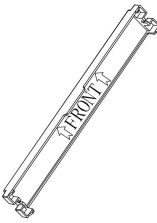
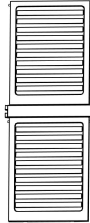
## PACKAGE CONTENTS

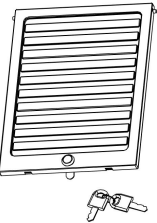
<b>A: Övre fack</b>	<b>B: Avtagbar bricka</b>	<b>C: Sidopanel</b>	<b>D: Nedre fack</b>
1 ST	6 st	2 st	1 ST
			
<b>E: Whee I</b>	<b>F: Hjul med lås</b>	<b>G: Sidofack</b>	<b>H: Bolt och keps</b>
2 st	2 st	2 st	4 SET
			
<b>I: Främre kontakt med skruvar</b>	<b>J: Bakpanel</b>	<b>K: Balusterade</b>	<b>L: Framsidan dörr med lås</b>
1 ST	1 SET	2 st	2 st
			
<b>M: Facksydd</b>	<b>N: Apparathållare</b>	<b>O: Verktyg</b>	
1 SET	1 SET	1 ST	

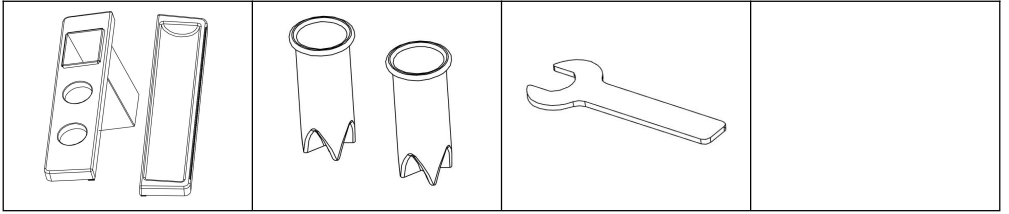

**ASSEMBLY STEPS**



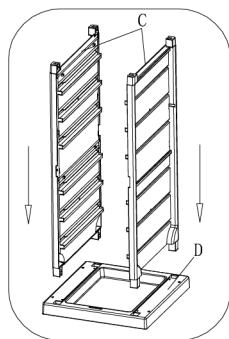

STEP 1

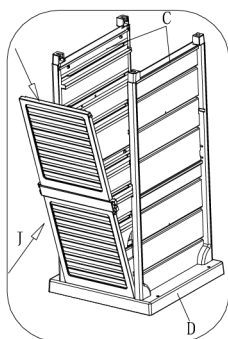

STEP 2

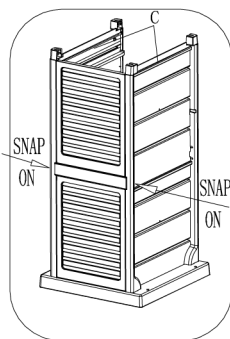

STEP 3

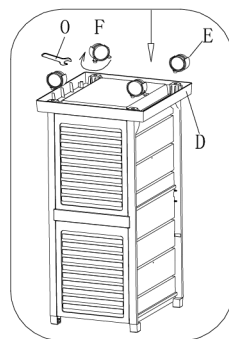

STEP 4

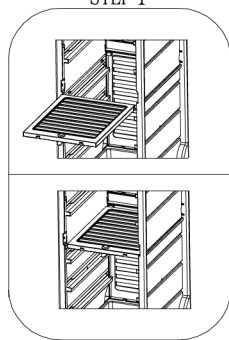

STEP 5

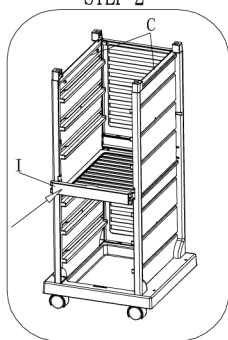

STEP 6

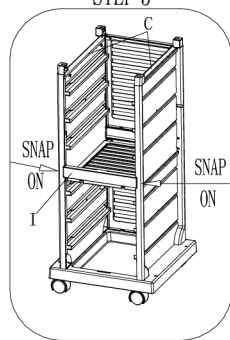

STEP 7

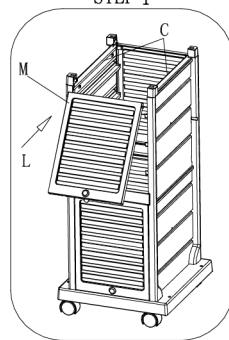

STEP 8

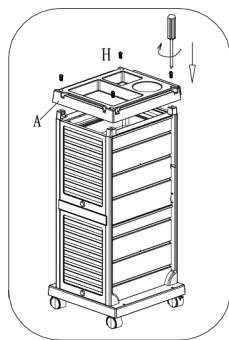

STEP 9

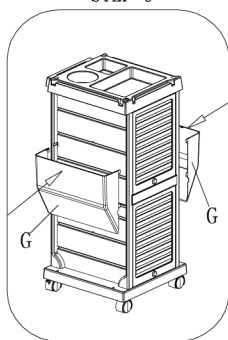

STEP 10

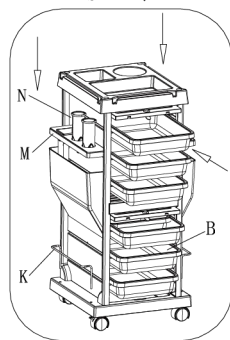

STEP 11

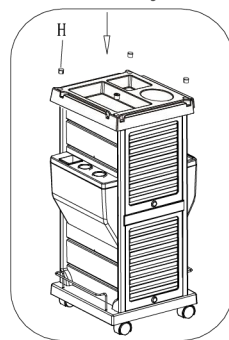

STEP 12

STEG 1 : Sätt in de två sidopanelerna (C) i det nedre facket (D),

STEG 2-3: Placera bakpanelen (J) mellan de två sidopanelerna (C) och snäpp fast i mittsektionen av sidopanelerna .

STEG 4: Skruva fast de 4 hjulen (E & F ) i gängorna i botten av sidopanelerna och fäst med verktyget ( O ). Se till att hjulen är ordentligt fastsatta.

STEG 5: Sätt in en av framdörrarna(M) i skenorna i mitten av sidopanelerna och skjut in helt.

STEG 6-7: Placera den främre kontakten ( I ) mellan mittsektionen av de 2 sidopanelerna (C) och snäpp fast .

STEG 8: Sätt in ytterligare en främre dörr(M) i skenorna i toppen av sidopanelerna.

STEG 9: Täck toppbrickan ( A ) på ovansidan av sidopanelerna och fäst med de 4 bultarna/bifogade). Täck INTE över skruvhålslocken(H) just nu .

STEG 10: Fäst sidofacken (G) på sidopanelerna. Se till att alla 4 krokarna var rätt inriktade mot skåror i sidopanelerna.

STEG 11: Sätt facklocken ( M ) och apparathållarna ( N ) på ovansidan av sidofacken (G). Skjut in de 4 avtagbara brickorna (B) , installera Fönshållare (K) och 2 balustrar (L).

STEG 12: Om ovanstående steg lyckades, sätt på skruvhålslocken(H) i de fyra hålen i det övre facket.

## FEATURES

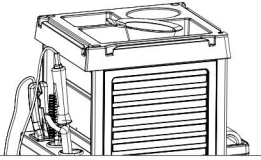

With holders for various hairdressing tools



With build-in metal appliance holders

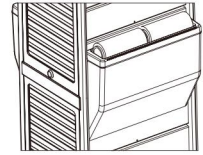

With holder and saw cutter for foil rollers

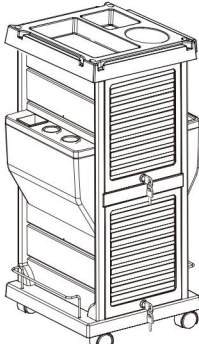

With 2 lockable doors that really work.  
Universal key for both



The door slips smoothly into the cabinet and "disappears"

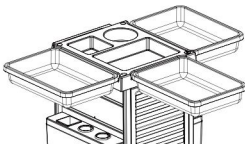

Removable trays can be clipped to both sides of the top, triple your working space



Adequate space for large bottles



Comfortably accommodate your Color Charts or Magazines

**Tillverkare:** Shanghai muxin muyeyouxiangongsi

**Adress:** Baoshanqu Shuangchenglu 803long 11hao 1602A-1609shi  
Shanghai

**Importerad till AUS:** SIHAO PTY LTD . 1 ROKEVA STREETEASTWOOD  
NSW 2122 Australien

**Importerad till USA:** Sanven Technology Ltd.  
Suite 250 , 9166 Anaheim Place, Rancho Cucamonga, CA 91730



SHUNSHUN GmbH  
Römeräcker 9 Z2021,76351  
Linkenheim-Hochstetten, Germany  
euvertreter@gmail.com  
+49 1727041930



Pooledas Group Ltd  
Unit 5 Albert Edward House, The  
Pavilions Preston, United Kingdom  
pooledas123@gmail.com  
Tel: 01772418127

**Tillverkad i Kina**



**VEVOR<sup>®</sup>**

**TOUGH TOOLS, HALF PRICE**

**Teknisk Support och e-garanticertifikat**

**[www.vevor.com/support](http://www.vevor.com/support)**

# **VEVOR<sup>®</sup>**

**TOUGH TOOLS, HALF PRICE**

Técnico Soporte y certificado de garantía electrónica [www.vevor.com/support](http://www.vevor.com/support)

## **CARRO DE SALÓN**

### **MANUAL DE USUARIO**

**N ° DE MODELO.: T-0 100C**

We continue to be committed to provide you tools with competitive price.

"Save Half", "Half Price" or any other similar expressions used by us only represents an estimate of savings you might benefit from buying certain tools with us compared to the major top brands and does not necessarily mean to cover all categories of tools offered by us. You are kindly reminded to verify carefully when you are placing an order with us if you are actually saving half in comparison with the top major brands.





# VEVOR<sup>®</sup>

TOUGH TOOLS, HALF PRICE

## Salon Cart

NÚMERO DE MODELO: T-100C

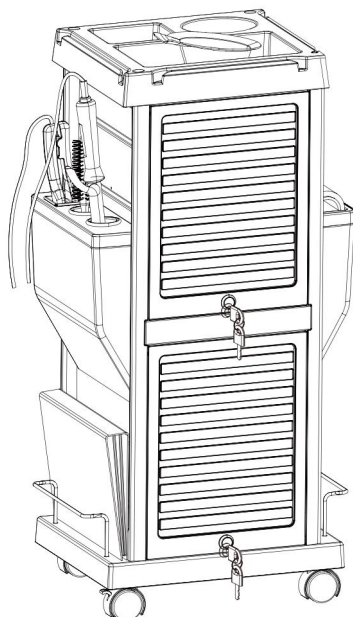

### NEED HELP? CONTACT US!

Have product questions? Need technical support? Please feel free to contact us:

**Technical Support and E-Warranty Certificate**  
**[www.vevor.com/support](http://www.vevor.com/support)**

This is the original instruction, please read all manual instructions carefully before operating. VEVOR reserves a clear interpretation of our user manual. The appearance of the product shall be subject to the product you received. Please forgive us that we won't inform you again if there are any technology or software updates on our product.

 **ADVERTENCIA:**

**Lea atentamente este manual antes de utilizar el producto. De lo contrario, podrían producirse lesiones graves.**

## **PRECAUCIONES DE MONTAJE**

49. Ensamble únicamente de acuerdo con estas instrucciones. Un montaje inadecuado puede crear peligros.
50. Use gafas de seguridad aprobadas por ANSI y guantes de trabajo resistentes durante el montaje.
51. Mantenga el área de reunión limpia y bien iluminada.
52. Mantenga a los transeúntes fuera del área durante el montaje.
53. No se reúna cuando esté cansado o bajo la influencia de alcohol, drogas o medicamentos.
54. Las capacidades del producto se aplican únicamente a productos ensamblados de manera adecuada y completa.
55. Ensamble sobre una superficie plana, nivelada, dura y lisa capaz de soportar de manera segura el carrito del salón.
56. Para obtener información adicional sobre las piezas enumeradas en las siguientes páginas, consulte el diagrama de montaje de este manual. Desenvuelva y separe todas las piezas en un área de trabajo limpia.

**GUARDA ESTAS INSTRUCCIONES**

# PRECAUCIONES DE USO

## PARA EVITAR LESIONES GRAVES Y LA MUERTE POR VUELCO:

**31. NO SE SIENTE NI SE PARE SOBRE ESTE ARTÍCULO.**

32. Este producto no es un juguete. No permita que los niños jueguen con este artículo o cerca de él.

33. No exceda la capacidad de peso. Vacíe el carro del laboratorio antes de moverlo.

34. Úselo únicamente sobre una superficie plana, nivelada, dura y lisa capaz de soportar de manera segura un carrito de salón completamente cargado.

35. Úselo únicamente según lo previsto.

Inspeccionar antes de cada uso; no lo utilice si las piezas están sueltas o dañadas.

## TECHNICAL SPECIFICATIONS

Modelo	T- 100C
Color	Negro _
Dimensiones del producto (largo x ancho x alto)	370*420*855 milímetros
Tamaño del embalaje (largo x ancho x alto)	835*255*450 milímetros
Peso neto / kg)	Alrededor de 8,41 kilos
Peso bruto (kg)	Unos 10 kilos

\*Productos como especificaciones, apariencia y diseño están

sujetos a modificaciones sin previo aviso.

## PACKAGE CONTENTS

R: bandeja superior	B: bandeja extraíble	C: panel lateral	D: bandeja inferior
PC 1	6 uds.	2 piezas	PC 1
			
E: Rueda I	F: Ruedas con bloqueos	G: compartimento lateral	H: Perno y gorra
2 piezas	2 piezas	2 piezas	4 juegos
			
Yo: conector frontal con tornillos	J: panel trasero	K: balaustrada	L: Frente puerta con cerradura
PC 1	1 JUEGOS	2 piezas	2 piezas
			

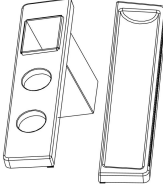
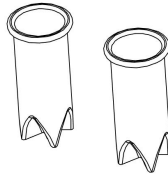
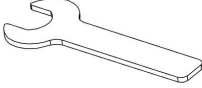
M: tapa del compartimento	N: Porta electrodomésticos	O: herramienta	
1 JUEGOS	1 JUEGOS	PC 1	
			

## ASSEMBLY STEPS

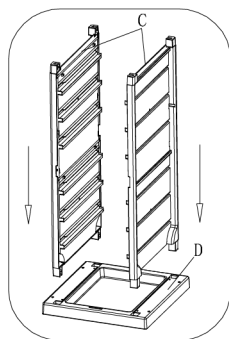

STEP 1

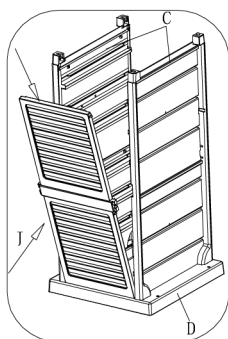

STEP 2

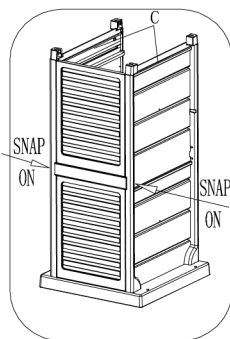

STEP 3

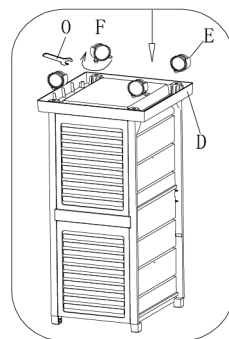

STEP 4

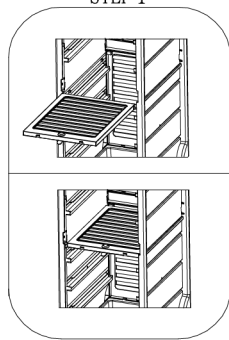

STEP 5

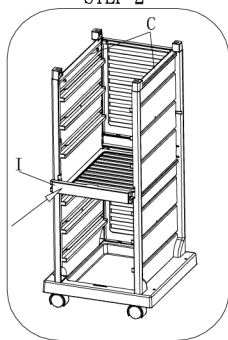

STEP 6

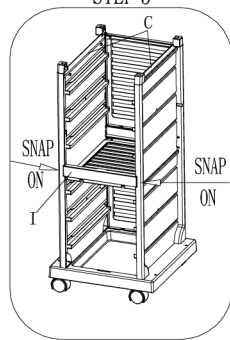

STEP 7

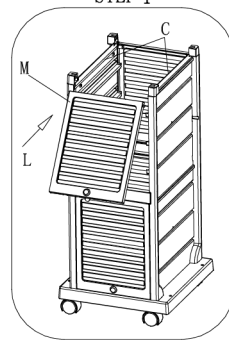

STEP 8

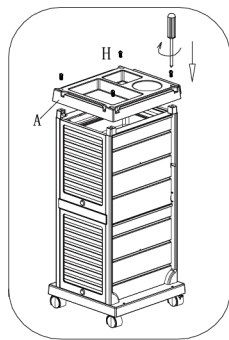

STEP 9

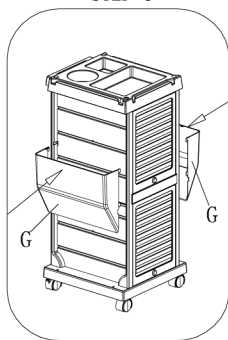

STEP 10

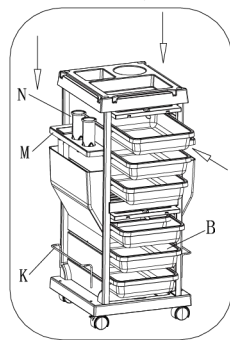

STEP 11

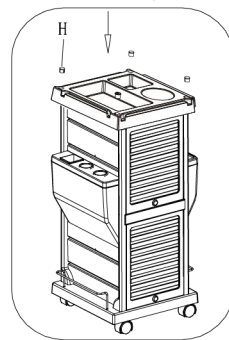

STEP 12

PASO 1 : Inserte los 2 paneles laterales (C) en la bandeja inferior (D),  
PASO 2-3: Coloque el panel trasero (J) entre los 2 paneles laterales (C) y colóquelo en la sección central de los paneles laterales .  
PASO 4: Atornille las 4 ruedas (E y F ) en las roscas en la parte inferior de los paneles laterales y fijelas con la herramienta ( O ). Asegúrese de que las ruedas estén bien sujetas.

PASO 5: Inserte una de las puertas delanteras (M) en los rieles en el medio de los paneles laterales y deslícela completamente.

PASO 6-7: Coloque el conector frontal ( I ) entre la sección central de los 2 paneles laterales (C) y encájelo .

PASO 8: Inserte otra puerta frontal (M) en los rieles en la parte superior de los paneles laterales.

PASO 9: Cubra la bandeja superior ( A ) en la parte superior de los paneles laterales y fíjela con los 4 pernos adjuntos). NO cubra las tapas de los orificios de los tornillos (H) en este momento .

PASO 10: Fije los compartimentos laterales (G) a los paneles laterales. Asegúrese de que los 4 ganchos estén alineados correctamente con las ranuras de los paneles laterales.

PASO 11: Coloque las cubiertas de los compartimentos (M ) y los soportes para electrodomésticos (N ) en la parte superior de los compartimentos laterales (G). Deslice las 4 bandejas extraíbles (B), instale las Soporte para secador de pelo (K) y 2 balaustres (L).

PASO 12: Si los pasos anteriores se realizaron correctamente, coloque las tapas de los orificios para tornillos (H) en los 4 orificios de la bandeja superior.

## FEATURES

---



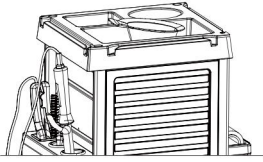

With holders for various hairdressing tools



With build-in metal appliance holders

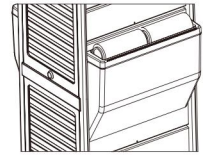

With holder and saw cutter for foil rollers

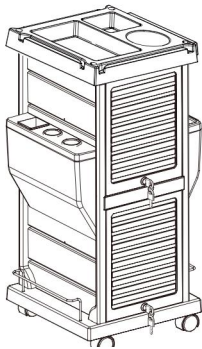

With 2 lockable doors that really work.  
Universal key for both



The door slips smoothly into the cabinet and "disappears"

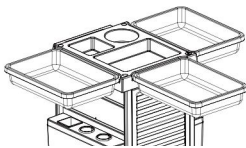

Removable trays can be clipped to both sides of the top, triple your working space



Adequate space for large bottles



Comfortably accommodate your Color Charts or Magazines

**Fabricante:** Shanghai muxinmuyeyouxiangongsi

**Dirección:** Baoshanqu Shuangchenglu 803long 11hao 1602A-1609shi  
Shanghai

**Importado a AUS:** SIHAO PTY LTD . 1 ROKEVA STREET ASTWOOD  
NSW 2122 Australia

**Importado a EE. UU.:** Sanven Technology Ltd.  
Suite 250 , 9166 Anaheim Place, Rancho Cucamonga, CA 91730

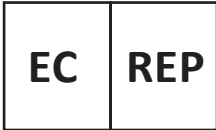

SHUNSHUN GmbH  
Römeräcker 9 Z2021,76351  
Linkenheim-Hochstetten, Germany  
euvertreter@gmail.com  
+49 1727041930



Pooledas Group Ltd  
Unit 5 Albert Edward House, The  
Pavilions Preston, United Kingdom  
pooledas123@gmail.com  
Tel: 01772418127

**Hecho en china**



**VEVOR**<sup>®</sup>

**TOUGH TOOLS, HALF PRICE**

**Técnico Certificado de soporte y garantía electrónica**

**[www.vevor.com/support](http://www.vevor.com/support)**

# **VEVOR<sup>®</sup>**

**TOUGH TOOLS, HALF PRICE**

Tecnico Supporto e certificato di garanzia elettronica [www.vevor.com/support](http://www.vevor.com/support)

## **CARRELLO DEL SALONE**

### **MANUALE D' USO**

**MODELLO NUMERO.: T-0 100C**

We continue to be committed to provide you tools with competitive price.

"Save Half", "Half Price" or any other similar expressions used by us only represents an estimate of savings you might benefit from buying certain tools with us compared to the major top brands and does not necessarily mean to cover all categories of tools offered by us. You are kindly reminded to verify carefully when you are placing an order with us if you are actually saving half in comparison with the top major brands.



# VEVOR<sup>®</sup>

TOUGH TOOLS, HALF PRICE

## Salon Cart

MODELLO N.: T-100C

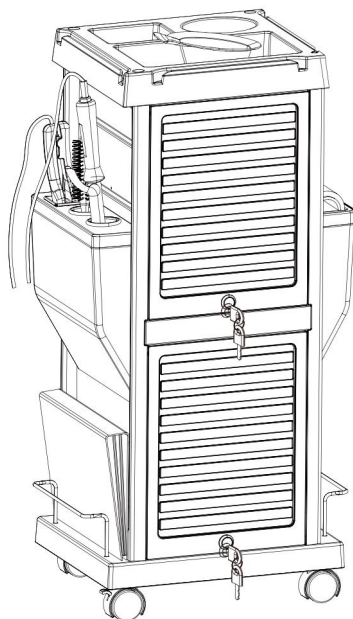

### NEED HELP? CONTACT US!

Have product questions? Need technical support? Please feel free to contact us:

**Technical Support and E-Warranty Certificate**  
**[www.vevor.com/support](http://www.vevor.com/support)**

This is the original instruction, please read all manual instructions carefully before operating. VEVOR reserves a clear interpretation of our user manual. The appearance of the product shall be subject to the product you received. Please forgive us that we won't inform you again if there are any technology or software updates on our product.

 **AVVERTIMENTO:**

**Si prega di leggere attentamente questo manuale prima di utilizzare il prodotto. In caso contrario, si potrebbero causare lesioni gravi.**

## **PRECAUZIONI DI MONTAGGIO**

57. Assemblare solo secondo queste istruzioni. Un montaggio improprio può creare pericoli.
58. Indossare occhiali di sicurezza approvati ANSI e guanti da lavoro pesanti durante il montaggio.
59. Mantenere l'area di assemblaggio pulita e ben illuminata.
60. Tenere gli astanti lontani dall'area durante il montaggio.
61. Non montare in caso di stanchezza o sotto l'effetto di alcol, droghe o farmaci.
62. Le funzionalità del prodotto si applicano solo ai prodotti correttamente e completamente assemblati.
63. Montare su una superficie piana, livellata, dura e liscia in grado di sostenere in sicurezza il carrello del salone.
64. Per ulteriori informazioni riguardanti le parti elencate nelle pagine seguenti, fare riferimento allo Schema di Montaggio di questo manuale. Scartare e separare tutte le parti in un'area di lavoro pulita.

**CONSERVARE QUESTE ISTRUZIONI**



# USARE LE PRECAUZIONI

**PER PREVENIRE LESIONI GRAVI E MORTE DOVUTE AL RIBALTAMENTO:**

**36. NON SEDERSI O STARE IN PIEDI SU QUESTO ARTICOLO.**

37. Questo prodotto non è un giocattolo. Non permettere ai bambini di giocare con o vicino a questo articolo.

38. Non superare le capacità di peso. Svuotare il carrello da laboratorio prima di spostarlo.

39. Utilizzare solo su una superficie piana, livellata, dura e liscia in grado di sostenere in sicurezza un carrello del salone a pieno carico.

40. Utilizzare solo come previsto.







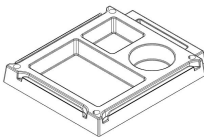
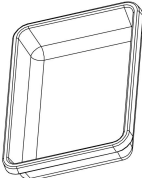

Ispezionare prima di ogni utilizzo; non utilizzare se le parti sono allentate o danneggiate.

## TECHNICAL SPECIFICATIONS

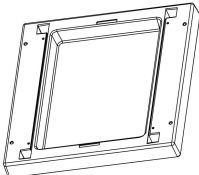
Modello	T -100C
Colore	Nero _
Dimensioni del prodotto (LxLxA)	370*420*855mm
Dimensioni imballo (LxLxA)	835*255* 450mm
Peso netto (kg)	Circa 8,41 kg
Peso lordo (kg)	Circa 10 kg

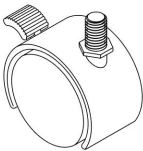
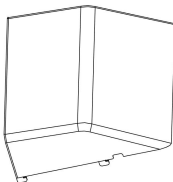
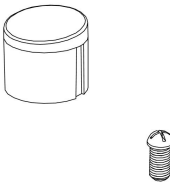
\*Prodotti quali specifiche, aspetto e design sono soggetti a modifiche senza preavviso.

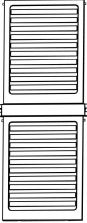
## PACKAGE CONTENTS

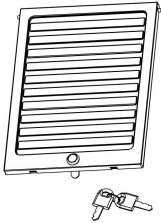
R: Vassoio superiore	B: Vassoio rimovibile	C: Pannello laterale	D: Vassoio inferiore
1 pezzo S	6 pezzi	2 pezzi	1 pezzo S
			
E: Ruota I	F: Ruote con bloccaggio	G: Scomparto laterale	H: Bullone e berretto
2 pezzi	2 pezzi	2 pezzi	4SET
			
I: Connettore frontale con viti	J: Pannello posteriore	K: Balaustrata	L: Davanti porta con serratura
1 pezzo S	1SET	2 pezzi	2 pezzi
			
M: Coperchio del vano	N: Porta elettrodomestici	O: Strumento	
1SET	1SET	1 pezzo	

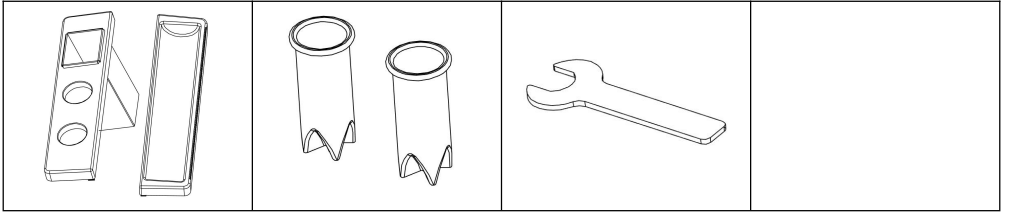

**ASSEMBLY STEPS**

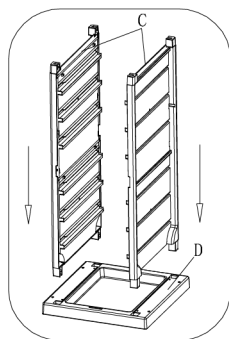

STEP 1

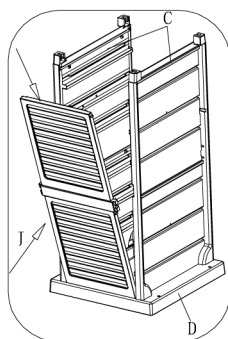

STEP 2

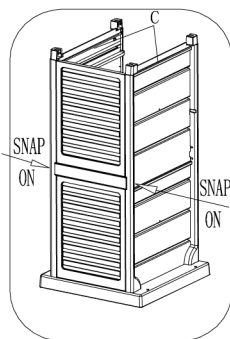

STEP 3

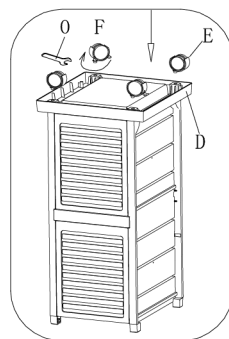

STEP 4

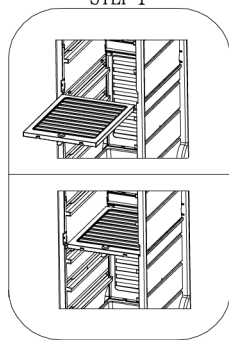

STEP 5

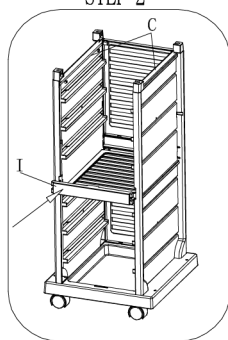

STEP 6

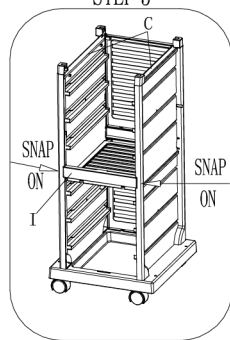

STEP 7

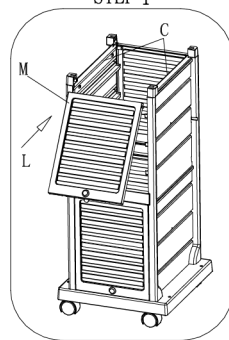

STEP 8

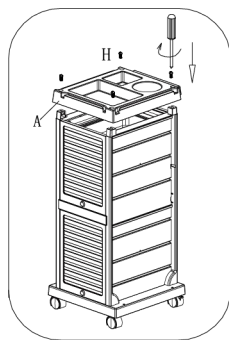

STEP 9

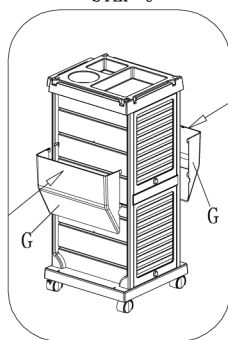

STEP 10

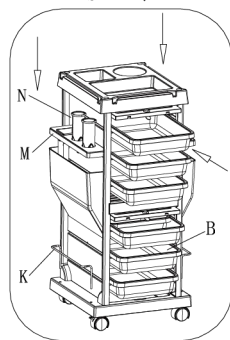

STEP 11

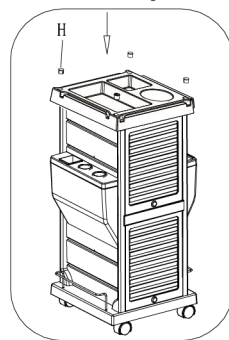

STEP 12

FASE 1 : inserire i 2 pannelli laterali (C) nel vassoio inferiore (D),

FASE 2-3: Posizionare il pannello posteriore (J) tra i 2 pannelli laterali (C) e agganciarlo nella sezione centrale dei pannelli laterali .

FASE 4: Avvitare le 4 ruote (E e F ) nelle filettature nella parte inferiore dei pannelli laterali e fissarle con lo strumento ( O ). Assicurarsi che le ruote siano fissate saldamente.

PASSO 5: Inserisci uno degli sportelli anteriori (M) nei binari al centro dei pannelli laterali e inseriscilo completamente.

FASE 6-7: Posizionare il connettore anteriore ( I ) tra la sezione centrale dei 2 pannelli laterali (C) e agganciarlo .

FASE 8: inserire un'altra porta anteriore (M) nei binari nella parte superiore dei pannelli laterali.

PASSO 9: Coprire il vassoio superiore ( A ) sulla parte superiore dei pannelli laterali e fissarlo con i 4 bulloni/inclusi). Si prega di NON coprire i tappi dei fori delle viti (H) in questo momento .

FASE 10: Attaccare gli scomparti laterali (G) ai pannelli laterali. Assicurarsi che tutti e 4 i ganci siano stati allineati correttamente alle fessure nei pannelli laterali.

FASE 11: Posizionare i coperchi degli scomparti (M ) e i supporti degli elettrodomestici (N ) sulla parte superiore degli scomparti laterali (G). Far scorrere i 4 vassoi rimovibili (B), installare i Supporto per asciugacapelli (K) e 2 colonnine (L).

PASSO 12: Se i passaggi precedenti sono stati eseguiti correttamente, inserire i tappi dei fori delle viti (H) nei 4 fori del vassoio superiore.

## FEATURES

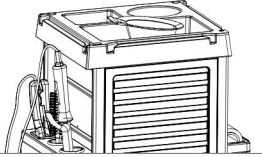

With holders for various hairdressing tools



With build-in metal appliance holders



With holder and saw cutter for foil rollers

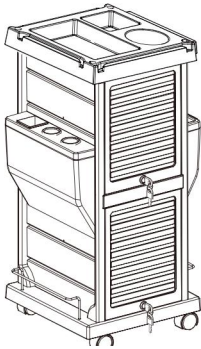

With 2 lockable doors that really work.  
Universal key for both

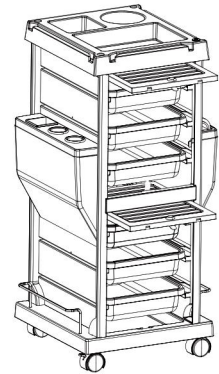

The door slips smoothly into the cabinet and "disappears"

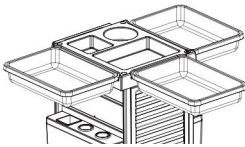

Removable trays can be clipped to both sides of the top, triple your working space



Adequate space for large bottles



Comfortably accommodate your Color Charts or Magazines

**Produttore:** Shanghai muxinmuyeyouxiangongsi

**Indirizzo:** Baoshanqu Shuangchenglu 803long 11hao 1602A-1609shi  
Shanghai

**Importato in AUS:** SIHAO PTY LTD . 1 ROKEVA STREETEASTWOOD  
NSW 2122 Australia

**Importato negli Stati Uniti:** Sanven Technology Ltd.  
Suite 250 , 9166 Anaheim Place, Rancho Cucamonga, CA 91730



SHUNSHUN GmbH  
Römeräcker 9 Z2021,76351  
Linkenheim-Hochstetten, Germany  
euvertreter@gmail.com  
+49 1727041930



Pooledas Group Ltd  
Unit 5 Albert Edward House, The  
Pavilions Preston, United Kingdom  
pooledas123@gmail.com  
Tel: 01772418127

**Made in China**





**VEVOR**<sup>®</sup>

**TOUGH TOOLS, HALF PRICE**

**Tecnico Supporto e certificato di garanzia elettronica**

**[www.vevor.com/support](http://www.vevor.com/support)**