

VEVOR[®]

TOUGH TOOLS, HALF PRICE

Technical Support and E-Warranty Certificate www.vevor.com/support

CAT EXERCISE WHEEL USER MANUAL

We continue to be committed to provide you tools with competitive price.

"Save Half", "Half Price" or any other similar expressions used by us only represents an estimate of savings you might benefit from buying certain tools with us compared to the major top brands and does not necessarily mean to cover all categories of tools offered by us. You are kindly reminded to verify carefully when you are placing an order with us if you are actually saving half in comparison with the top major brands.

VEVOR[®]

TOUGH TOOLS, HALF PRICE

CAT EXERCISE WHEEL

Model: 4.0 XS 4.0 M 4.0 XL 4.0 XXL

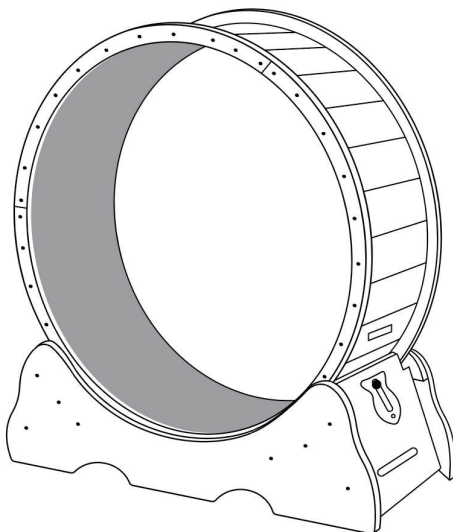

NEED HELP? CONTACT US!

Have product questions? Need technical support? Please feel free to contact us:

Technical Support and E-Warranty Certificate
www.vevor.com/support

This is the original instruction, please read all manual instructions carefully before operating. VEVOR reserves a clear interpretation of our user manual. The appearance of the product shall be subject to the product you received. Please forgive us that we won't inform you again if there are any technology or software updates on our product.

SPECIFICATIONS

Model	4.0 XS
Product Size	750×320×800mm
Color	Natural







Model	4.0 M
Product Size	910×320×970mm
Color	Natural

Model	4.0 XL
Product Size	1105×345×1170mm
Color	Black

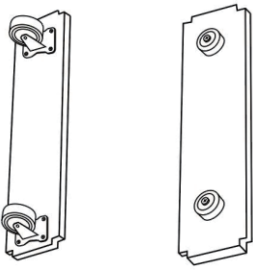
Model	4.0 XL
Product Size	1105×345×1170mm
Color	White

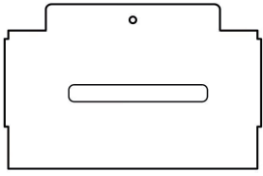
Model	4.0 XXL
Product Size	1320×340×1415mm
Color	Natural

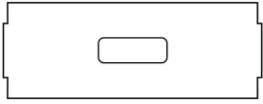
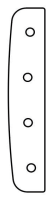
COMPONENTS

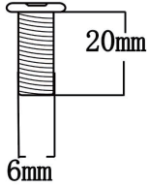
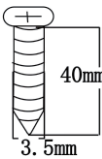
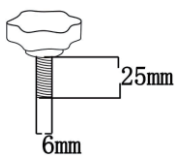
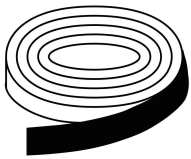
 <p>A×2 P×2</p>	 <p>B×2</p>	 <p>*C a plank with only one screw hole</p> <p>C×2</p>
 <p>D×6</p>	<p>* three pieces of E have double holes on the side.</p>  <p>4.0XS /4.0M E×17 4.0XL/4.0XXL E×23</p>	 <p>F×1</p>
 <p>G×6</p>	 <p>H×1</p>	 <p>K×24</p>
 <p>4.0XS /4.0M L×58 4.0XL/4.0XXL L×70</p>	 <p>N×1</p>	 <p>M×1</p>
<p>* Components A, C, E, F, P have been pre installed with plastic solenoids.</p> <p>* Each set comes with a screwdriver, cat teaser, gloves and sandpaper.</p>		

Assembly Instructions

Instructions hint:

Do not tighten the mounting screws to the end at one time, and tighten them again after a single component is installed and formed!

STEP1

Base installation

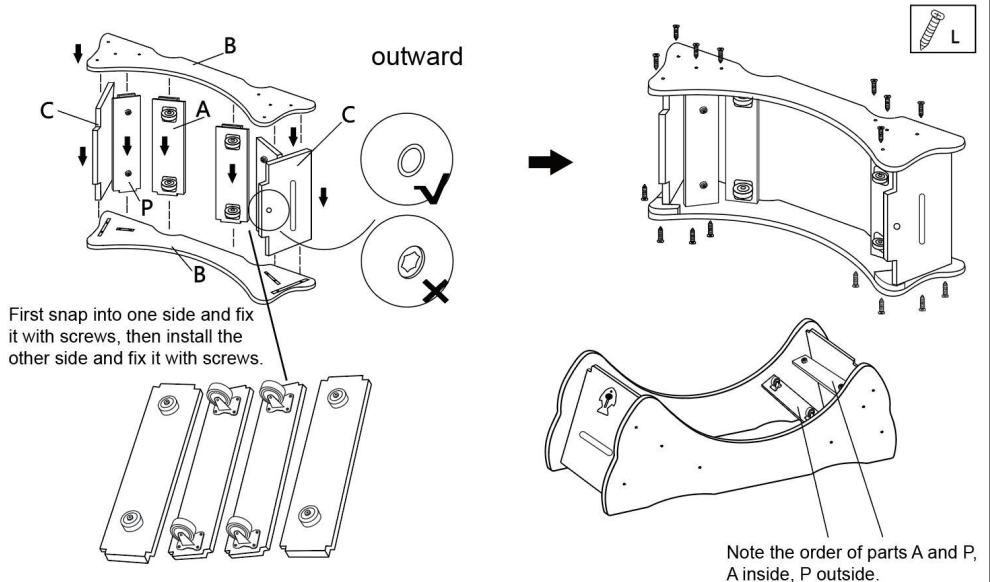

STEP2

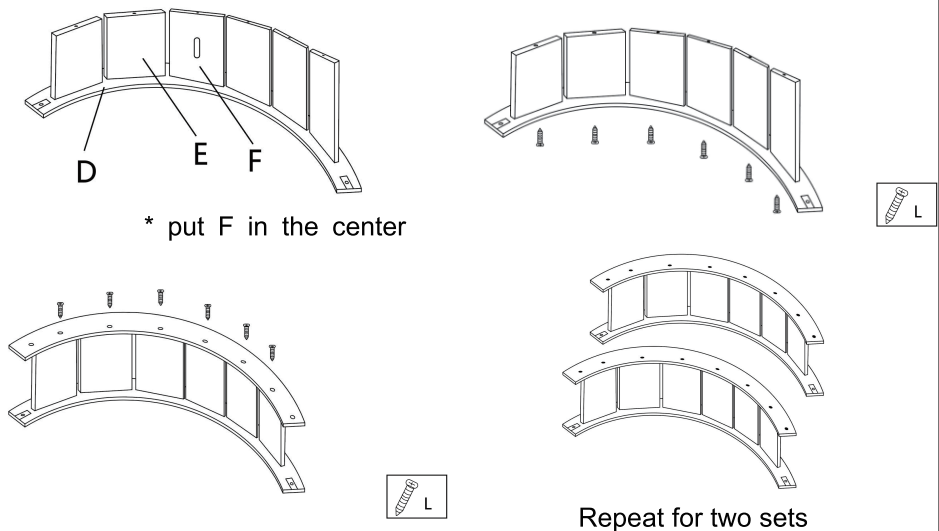

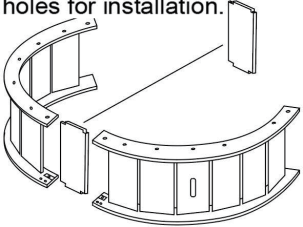
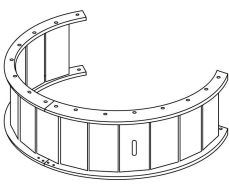
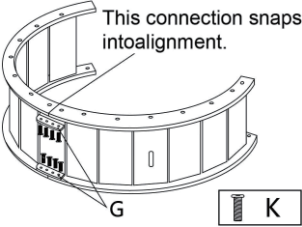
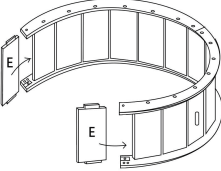
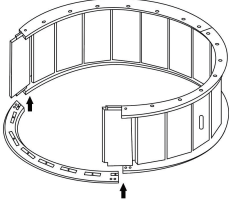
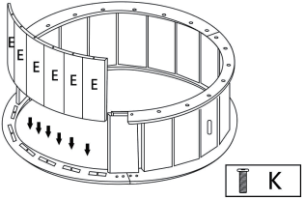
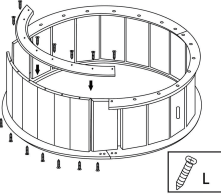
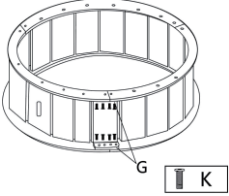
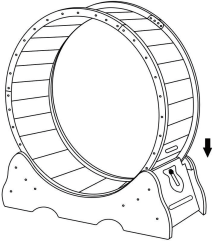
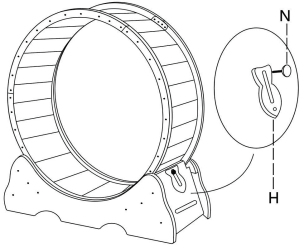
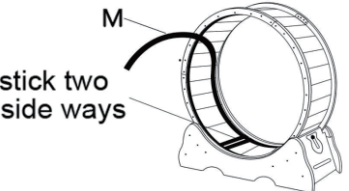
<p>STEP3</p> <p>Here, use E with double holes for installation.</p> 	<p>STEP4</p> 	<p>STEP5</p> <p>This connection snaps into alignment.</p> 
<p>STEP6</p> 	<p>STEP7</p> 	<p>STEP8</p> 
<p>STEP9</p> 	<p>STEP10</p> 	<p>STEP11</p>  <p>Place the rollers on the base.</p>
<p>STEP12</p>  <p>Connect the lock plate H with the screw N and fix it on the plate with holes C.</p>	<p>STEP13</p> <p>Please paste the black buckle as shown in the figure below.</p>  <p>stick two side ways</p> <p>Put black belt back glue mother-in-law Tear off the top layer paper, along the Roller fixed one circle.(Wipe the rollers clean first!)</p> <p>The Velcro of the accessories is sent out in one piece, which needs to be cut according to the length of the runway.</p>	

STEP14

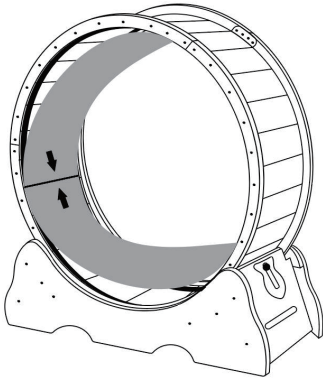

STEP15

Finished

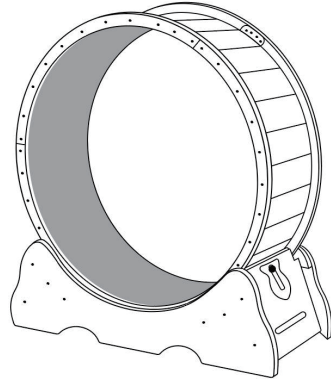

Lock it when not in use.

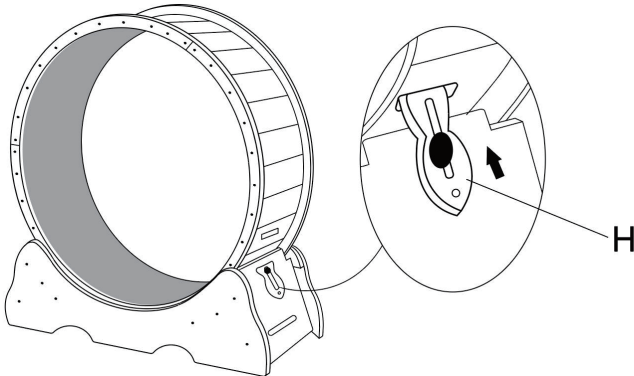

* H wooden lock is inserted into the card slot and locked.

TIPS:

1. The number of screws marked above is the actual number used during installation. When the product is shipped, 1~3 more screws of each type will be given as spares.
2. During the use of the product, children are prohibited from approaching without the company of adults.
3. The edge of the product is a bit sharp, and you need to wear gloves for installation; at the same time, it comes with sandpaper, so you can polish the edge again by yourself; without gloves, be careful when touching the running wheel.

Address: Shuangchenglu 803nong11hao1602A-1609shi, baoshanqu, shanghai 200000 CN.

Imported to AUS: SIHAO PTY LTD, 1 ROKEVA STREETEASTWOOD NSW 2122 Australia

Imported to USA: Sanven Technology Ltd.Suite 250, 9166 Anaheim Place, Rancho Cucamonga, CA 91730

EC	REP
-----------	------------

E-CrossStu GmbH.

Mainzer Landstr.69, 60329 Frankfurt am Main.

UK	REP
-----------	------------

YH CONSULTING LIMITED.

C/O YH Consulting Limited Office 147, Centurion House,
London Road, Staines-upon-Thames, Surrey, TW18 4AX.

VEVOR[®]

TOUGH TOOLS, HALF PRICE

Technical Support and E-Warranty Certificate

www.vevor.com/support

VEVOR®

TOUGH TOOLS, HALF PRICE

Teknisk Support och e-garanticertifikat www.vevor.com/support

KATT UTÖVA HJUL ANVÄNDARE MANUELL

Vi fortsätter att vara engagerade i att ge dig verktyg till konkurrenskraftiga priser.

"Spara hälften", "halva priset" eller andra liknande uttryck som används av oss representerar bara en uppskattning av besparingar du kan dra nytta av att köpa vissa verktyg hos oss jämfört med de stora toppmärkena och betyder inte nödvändigtvis att täcka alla kategorier av verktyg som erbjuds av oss. Du påminns vänligen om att noggrant kontrollera när du gör en beställning hos oss om du faktiskt sparar hälften i jämförelse med de främsta stora varumärkena.

Modell : 4.0 XS 4.0 M 4.0 XL 4.0 XXL

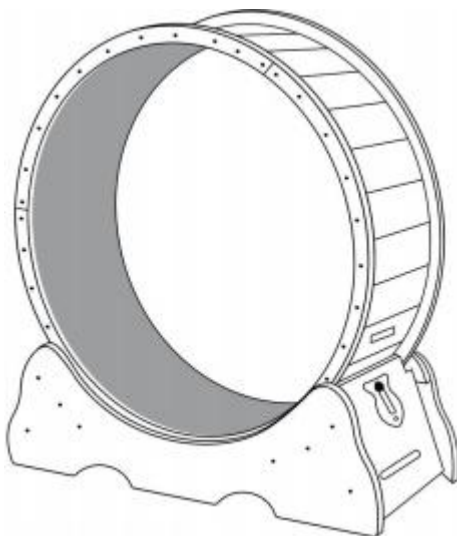

BEHOV HJÄLP? KONTAKTA USA!

Ha produkt fråga s? Behov teknisk stöd? Behaga känsla gratis att kontakta oss :

Teknisk support och E- garanticertifikat
www.vevor.se/support

Detta är de original instruktion , behaga läsa alla manuell instruktioner noggrant innan användning. VEVOR reserv s a rensa tolkning av våra bruksanvisning . De utseende av de produkt ska vara föremål för de produkt dig mottagen. snälla förlåt oss th vi kommer inte informera dig igen om det finns någon teknik eller programvara uppdateringar på vår produkt.

SPECIFIKATIONER

Modell	4.0 XS
produktstorlek	750 x 320 x 800 mm
färg	Naturlig









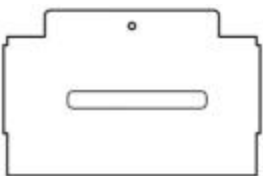

Modell	4.0 M
produktstorlek	910×320×970mm
färg	Natural

Modell	4.0 XL
produktstorlek	1105×345×1170mm
färg	Black

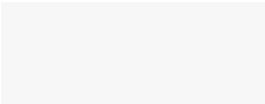
Modell	4.0 XL
produktstorlek	1105×345×1170mm
färg	White

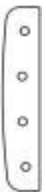
Modell	4.0 XXL
produktstorlek	1320×340×1415mm
färg	Natural

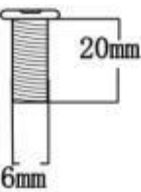
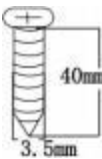
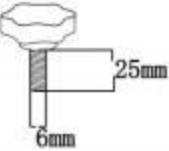
KOMPONENTER

 <p>Axe 2 Px 2</p>	 <p>Bx 2</p>	 <p>*c a planka med endast en skruvhål</p> <p>Cx 2</p>
 <p>Dx 6</p>	<p>* tre bitar av E har dubbelt hål på sidan.</p>  <p>4 . oXS /4 . OM Ex 17 4 . OXL /4 . OXXL Ex 23</p>	 <p>Fx 1</p>
 <p>Gx 6</p>	 <p>Hx 1</p>	 <p>20mm</p> <p>6mm</p> <p>Kx 24</p>
 <p>4 . oXS /4 . OM Lx 58 4 . OXL /4 . OXXL Lx 70</p>	 <p>25mm</p> <p>6mm</p> <p>Nx 1</p>	 <p>Mx 1</p>
<p>* komponenter A, C, E, F, P har bi n pre installerad med plast solenoider. * Varje set kommer med en skruvmejsel, ca t teaser, handskar och</p>		

sandpapper.

Montering Instruktioner

Instruktionstips:

Do dra inte åt monteringskruvarna till ena änden tid, och spänna dem igen efter en enskild komponent är installerad och formad!

STEG 1 Bas installation

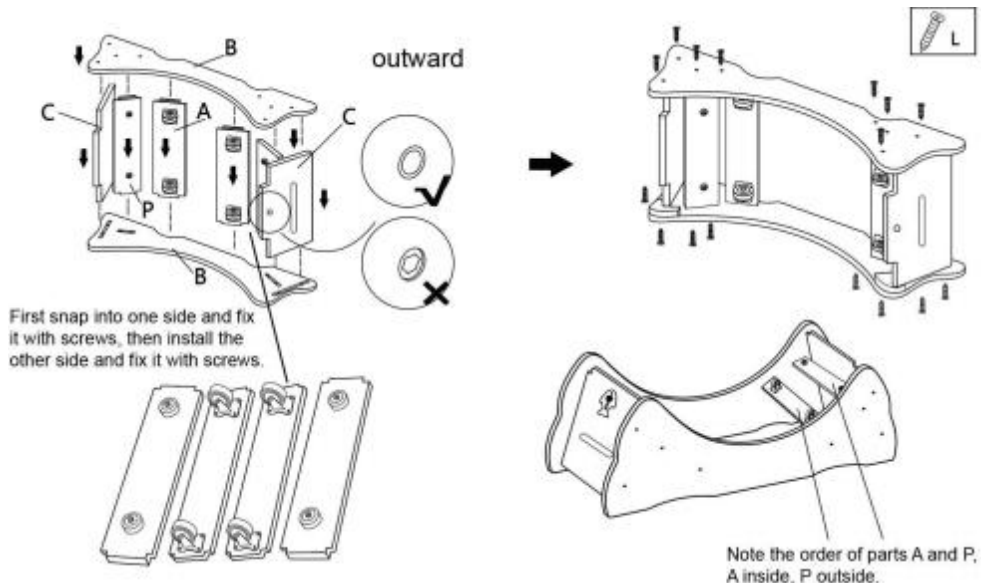

STEG 2

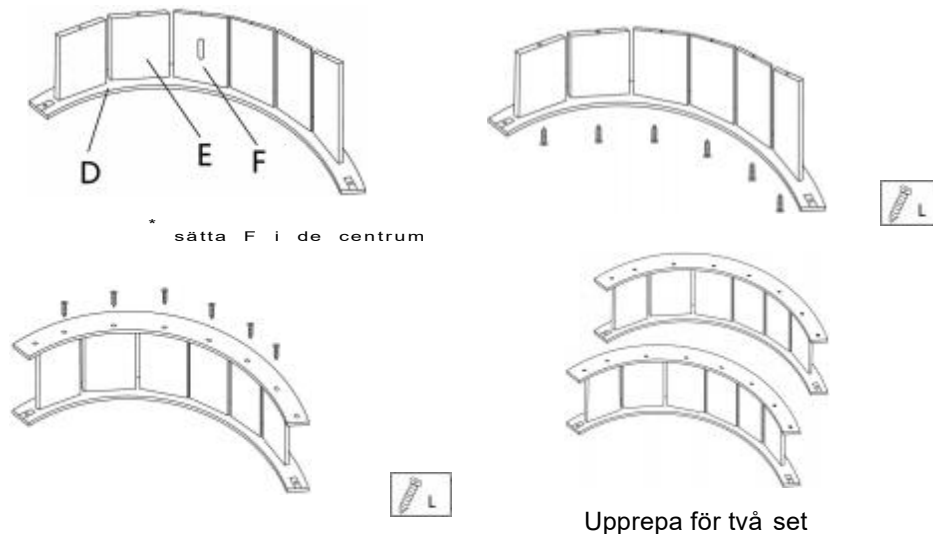

STEG 3

Here, use E with double holes for installation.



STEG 4



STEG 5

This connection snaps into alignment.

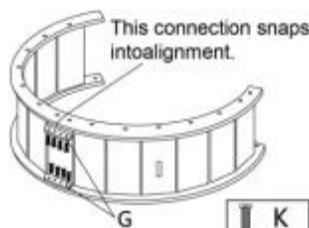

STEG 6

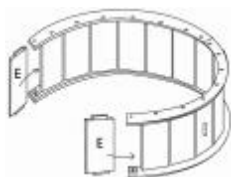

STEG 7



STEG 8

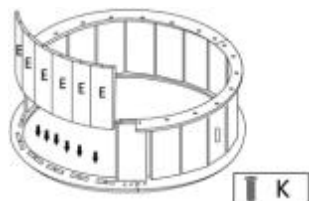

STEG 9

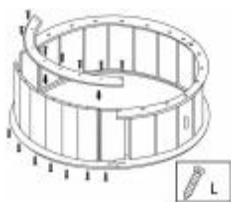

STEG 10



STEG 11



placera rullar på de bas.

STEG 12

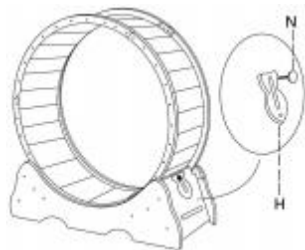

ansluta låsplatta H med th de skruv N och fixera det på de tallrik med hål C .

STEG 13

behaga klistra in svart spänne som sh egna i figuren nedan.

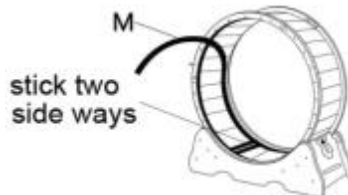

sätta svart bälte bak lim svärmor Riv av toppen lager papper, tillsammans de Rull fixerad en cirkel. (torka av rullar städa först !)

Kardborrbandet av tillbehören är skickas ut i en bit, som behöver skäras enligt till längd av landningsbanan.

STEG 14



STEG 15 Avslutat

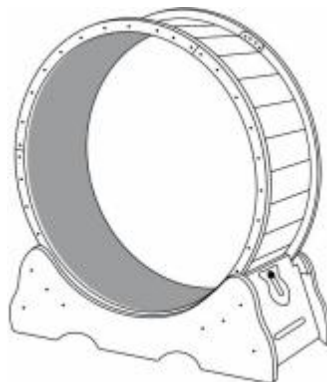

Låsa det när inte i använda .

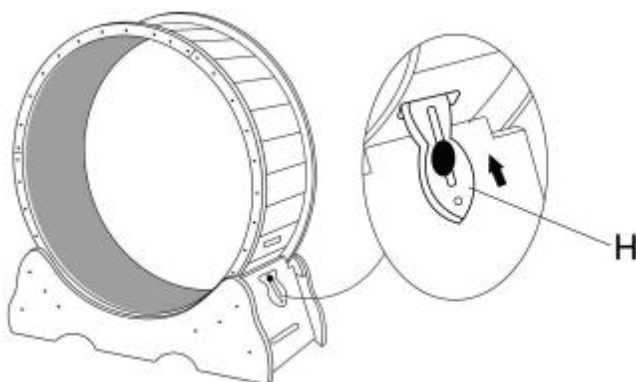

* H Trä låsa är insatt till de kort spår och låst .

TIPS :

- 1 .De antal av skruvar markant ovan är de faktisk antal begagnad under installation . när de produkt är skickas , 1 ~ 3 mer skruvar av varje typ vilja få som reservdelar .
2. Under använda av produkt, barn är förbjudna från annalkande utan de sällskap av en dults.
3. De kant av de produkt är a b det skarp, och du behov till bära handskar för installation ; på de samma tid, det kommer med sandpapper , Så du burk polska de kant igen själv; utan handskar , vara försiktig när röra vid spring hjul .

Tillverkare: Shanghaimuxinmuyeyouxiangongsi

Adress: Shuangchenglu 803nong11hao1602A-1609shi, baoshanqu,
shanghai 200000 CN.

EC REP: E-CrossStu GmbH.

Mainzer Landstr.69, 60329 Frankfurt am Main.

UK REP: YH CONSULTING LIMITED.

C/O YH Consulting Limited Office 147, Centurion House, London Road,
Staines-upon-Thames, Surrey, TW18 4AX

Importerad till AUS: SIHAO PTY LTD.

1 ROKEVA STREETEASTWOOD NSW 2122 Australien

Importerad till USA: Sanven Technology Ltd.

Suite 250, 9166 Anaheim Place, Rancho Cucamonga, CA 9173 0

VEVOR[®]

TOUGH TOOLS, HALF PRICE

Teknisk Support och e-garanticertifikat

www.vevor.com/support

VEVOR®

TOUGH TOOLS, HALF PRICE

Técnico Soporte y certificado de garantía electrónica
www.vevor.com/support

GATO EJERCICIO RUEDA USUARIO MANUAL

Seguimos comprometidos a brindarle herramientas a precios competitivos. "Ahorre la mitad", "mitad de precio" o cualquier otra expresión similar que utilicemos solo representa una estimación del ahorro que podría obtener al comprar ciertas herramientas con nosotros en comparación con las principales marcas y no necesariamente significa que cubra todas las categorías de herramientas que ofrecemos. Le recordamos que, al realizar un pedido con nosotros, verifique cuidadosamente si realmente está ahorrando la mitad en comparación con las principales marcas.

VEVOR[®]
TOUGH TOOLS, HALF PRICE

CAT EXERCISE
WHEEL

Modelo : 4.0 Talla XS 4.0 METRO 4.0 XL4 .0 XXL

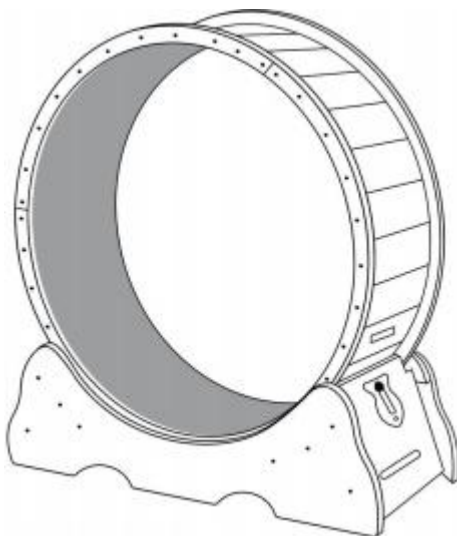

NECESIDAD ¿AYUDA? CONTACTO ¡A
NOSOTROS!

Tener producto ¿ preguntas ? Necesidad técnico ¿apoyo? Por favor sentir gratis Para contactar a nosotros :

certificado de garantía electrónica
[Www.vevor.com/soporte](http://www.vevor.com/soporte)

Este es el original instrucción , por favor leer todo manual instrucciones
Tenga cuidado antes de operar. VEVOR se reserva el derecho de
modificarlo . a claro interpretación De nuestro manual de usuario . El
Apariencia de el El producto deberá estar sujeto a el
producto tu recibió. Por favor perdona nosotros que no lo haremos

informarle de nuevo si ¿Existe alguna tecnología o software?
actualizaciones en Nuestro producto.

PRESUPUESTO

Modelo	4.0 XS
Tamaño del producto	750 x 320 incógnita 800 milímetros
color	Natural









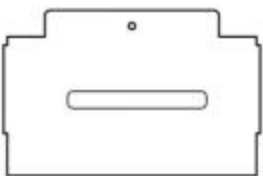

Modelo	4.0 M
Tamaño del producto	910×320×970mm
color	Natural

Modelo	4.0 XL
Tamaño del producto	1105×345×1170mm
color	Black

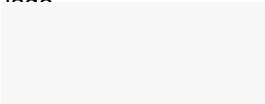
Modelo	4.0 XL
Tamaño del producto	1105×345×1170mm
color	White

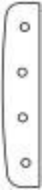
Modelo	4.0 XXL
Tamaño del producto	1320×340×1415mm
color	Natural

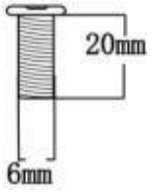
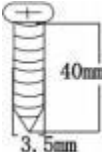
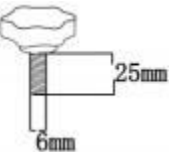
COMPONENTES

 <p>Hacha 2 Px 2</p>	 <p>Caja 2</p>	 <p>*do a tablón con solo uno agujero de tornillo Cx2</p>
 <p>Dx6</p>	<p>* tres piezas de mi tener doble agujeros en el lado</p>  <p>4 . oXS /4 .OM Ejemplo 17 4 .OXL / 4 .OXXL Ejemplo 23</p>	 <p>Efecto 1</p>
 <p>Gx6</p>	 <p>Hx1</p>	 <p>Kx24</p>
 <p>4 . oXS /4 .OMA Lx58 4 .OXL / 4 .OXXL Lx70</p>	 <p>Nx 1</p>	 <p>Mx1</p>

* componentes A, DO, MI, F, P tiene estado pre instalado con Solenoides de plástico. * Cada juego viene con un destornillador, adelanto de gato, guantes y papel de lija.

Asamblea Instrucciones

Sugerencia de instrucciones:

Hacer No apriete los tornillos de montaje hasta el final de una sola vez. tiempo, y apretar a ellos de nuevo después de que un solo componente es ¡Instalado y formado!

PASO 1 Base instalación

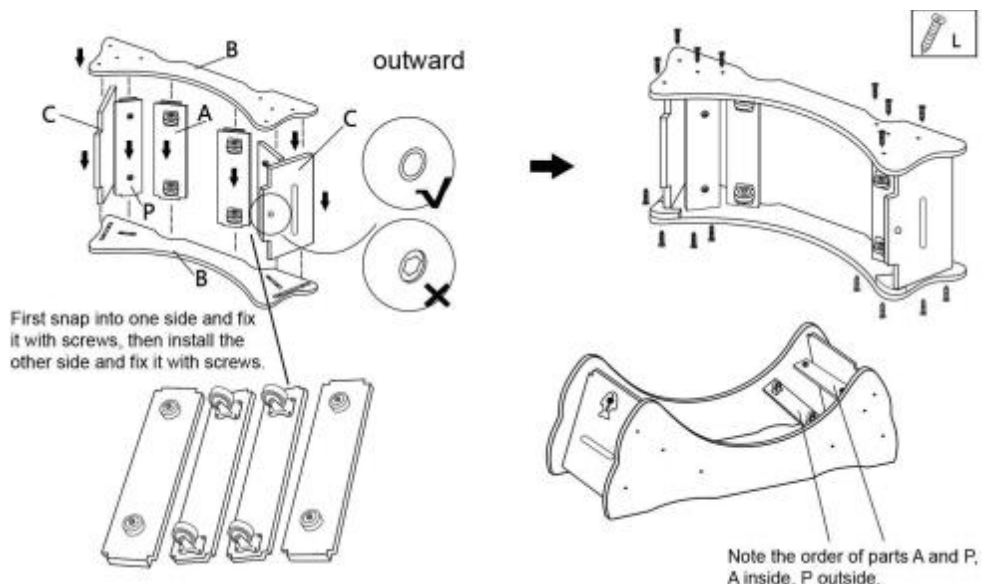

PASO 2

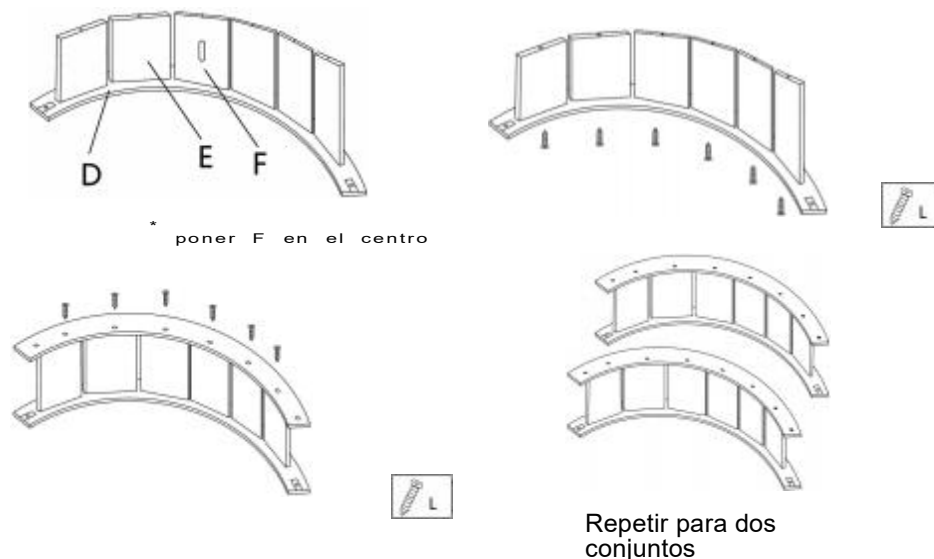

PASO 3

Here, use E with double holes for installation.



PASO 4



PASO 5

This connection snaps into alignment.

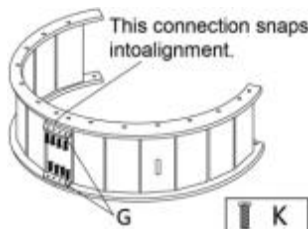

PASO 6

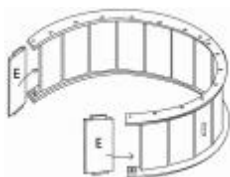

PASO 7



PASO 8

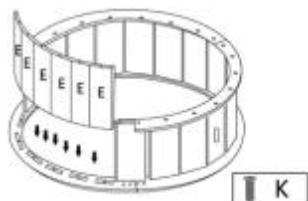

PASO 9

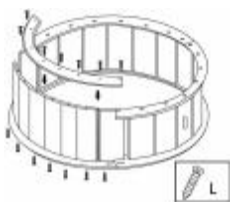

PASO 10



PASO 11



Coloque el Rodillos en el base.

PASO 12

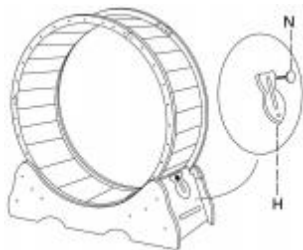

Conectar el placa de bloqueo H Con el el tornillo N y arreglar él en el lámina con agujeros C .

PASO 13

por favor pegar el hebilla negra como sh propio en La figura abajo.

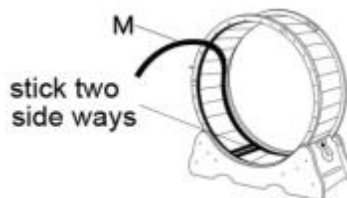

poner Pegamento para la espalda para cinturón negro suegra Arranca la parte superior capa papel, a lo largo el Rodillo fijo un círculo (limpiar el Rodillos ¡limpia primero !)

El velcro De los accesorios es Enviado en uno pedazo, cual necesita ser cortado de acuerdo hacia longitud del pista.

PASO 14



PASO 15 Terminado

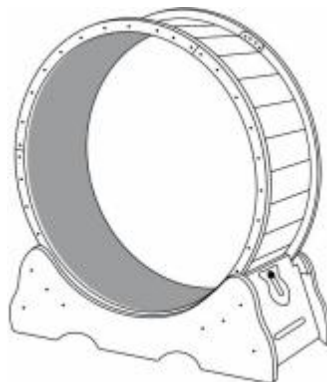

Cerrar Es cuando no en usar .

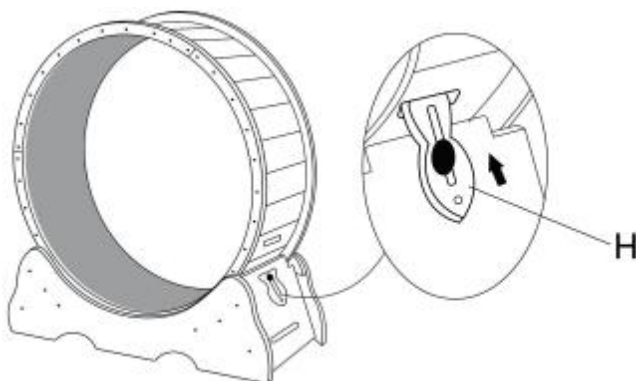

* yo De madera cerrar esta insertado en el tarjeta ranura y bloqueado .

CONSEJOS :

1 . El número de tornillos marcado arriba es el actual número usado durante Instalación . cuando el producto es enviado , 1 ~3 más tornillos de cada tipo voluntad ser dado como repuestos .

2. Durante el usar del producto , niños tienen prohibido que se acerca sin el Compañía de un adulto .

3. El borde de el producto es a poco afilado , y tú necesidad a tener puesto guantes para

Instalación ; en el mismo tiempo , él llega con papel de lija , Entonces tú poder polaco el borde de nuevo por ti mismo ; Sin guantes , ten cuidado cuando tocando el correr rueda .

Fabricante: Shanghaimuxinmuyeyouxiangongsi

Dirección: Shuangchenglu 803nong11hao1602A-1609shi, baoshanqu, shanghai 200000 CN.

REPRESENTANTE CE: E-CrossStu GmbH.

Mainzer Landstr.69, 60329 Fráncfort del Meno.

REPRESENTANTE DEL REINO UNIDO: YH CONSULTING LIMITED.

C/O YH Consulting Limited Oficina 147, Centurion House, London Road, Staines-upon-Thames, Surrey, TW18 4AX

Importado a AUS: SIHAO PTY LTD.

1 ROKEVA STREET EASTWOOD NSW 2122 Australia

Importado a EE. UU.: Sanven Technology Ltd.

Suite 250, 9166 Anaheim Place, Rancho Cucamonga, CA 9173 0

VEVOR[®]

TOUGH TOOLS, HALF PRICE

Técnico Certificado de soporte y garantía electrónica

www.vevor.com/support

VEVOR®

TOUGH TOOLS, HALF PRICE

Tecnico Supporto e certificato di garanzia elettronica
www.vevor.com/support

GATTO ESERCIZIO RUOTA UTENTE MANUALE

Continuiamo a impegnarci per fornirvi strumenti a prezzi competitivi. "Risparmia la metà", "Metà prezzo" o qualsiasi altra espressione simile da noi utilizzata rappresenta solo una stima del risparmio che potresti ottenere acquistando determinati utensili con noi rispetto ai principali marchi principali e non significa necessariamente coprire tutte le categorie di utensili da noi offerti. Ti ricordiamo gentilmente di verificare attentamente quando effettui un ordine con noi se stai effettivamente risparmiando la metà rispetto ai principali marchi principali.

VEVOR[®]
TOUGH TOOLS, HALF PRICE

CAT EXERCISE
WHEEL

Modello : 4.0 Taglia XS4.0 M 4.0 4XLarge .0 Grandezza

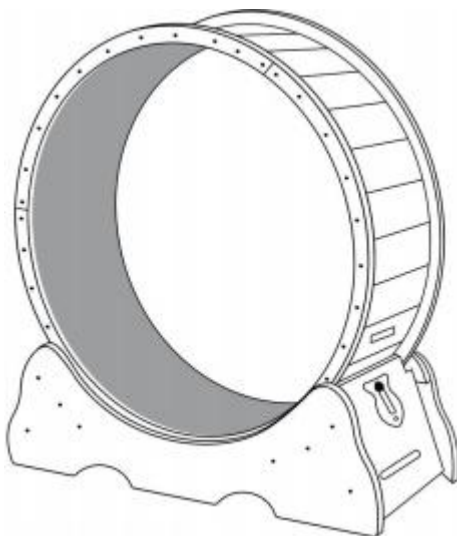

BISOGNO AIUTO? CONTATTO NOI!

Avere prodotto domande ? Bisogno tecnico supporto? Per favore
Tatto gratuito contattare noi :

certificato di garanzia elettronica
[Www.vevor.com/support](http://www.vevor.com/support)

Questo È IL originale istruzione , Per favore Leggere Tutto manuale
istruzioni

attentamente prima di operare. VEVOR si riserva UN chiaro
interpretazione del nostro manuale utente . IL aspetto di IL il prodotto
deve essere soggetto a IL

prodotto tu ricevuto. per favore perdonami noi che non lo faremo

informarti Ancora Se ci sono tecnologie o software aggiornamenti su il nostro prodotto.

SPECIFICHE

Modello	4.0 Taglia XS
dimensione del prodotto	750x320 X 800 millimetri
colore	Naturale









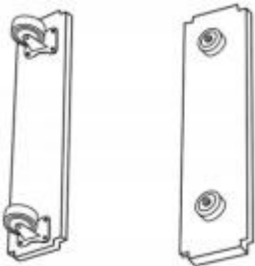

Modello	4.0 M
dimensione del prodotto	910×320×970mm
colore	Natural

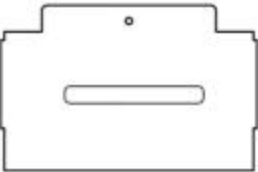
Modello	4.0 XL
dimensione del prodotto	1105×345×1170mm
colore	Black

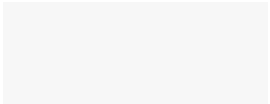
Modello	4.0 XL
dimensione del prodotto	1105×345×1170mm
colore	White

Modello	4.0 XXL
dimensione del prodotto	1320×340×1415mm
colore	Natural

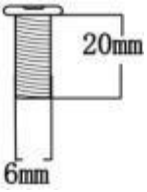
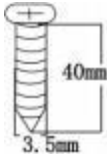
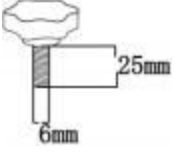
COMPONENTI

 <p>Ascia 2 Px 2</p>	 <p>Bx2</p>	 <p>*C UN tavola con soltanto uno foro per vite Cx2</p>
 <p>Domanda 6</p>	<p>* tre pezzi Di E avere doppio buchi SU il lato.</p>  <p>4 . OXS /4 . OMS Es 17 4 . OX /4 . Taglia unica Es 23</p>	 <p>Effetto 1</p>
 <p>Gx6</p>	 <p>Ax 1</p>	 <p>Bambini 24</p>
 <p>4 . OXS (oXS-tipo) /4 . OM Lx58 4 . OX /4 . Taglia unica Lx70</p>	 <p>Numero 1</p>	 <p>Mx1</p>

* componenti A, C, E, F, P hanno stato pre installato con solenoidi di plastica. * Ogni set è dotato di un cacciavite, teaser di gatto, guanti E carta vetrata.

Assemblea Istruzioni

Suggerimento per le istruzioni:

Fare non stringere le viti di montaggio fino in fondo in una tempo, E stringere loro Ancora dopo che un singolo componente è installato e formato!

PASSO 1 Base installazione

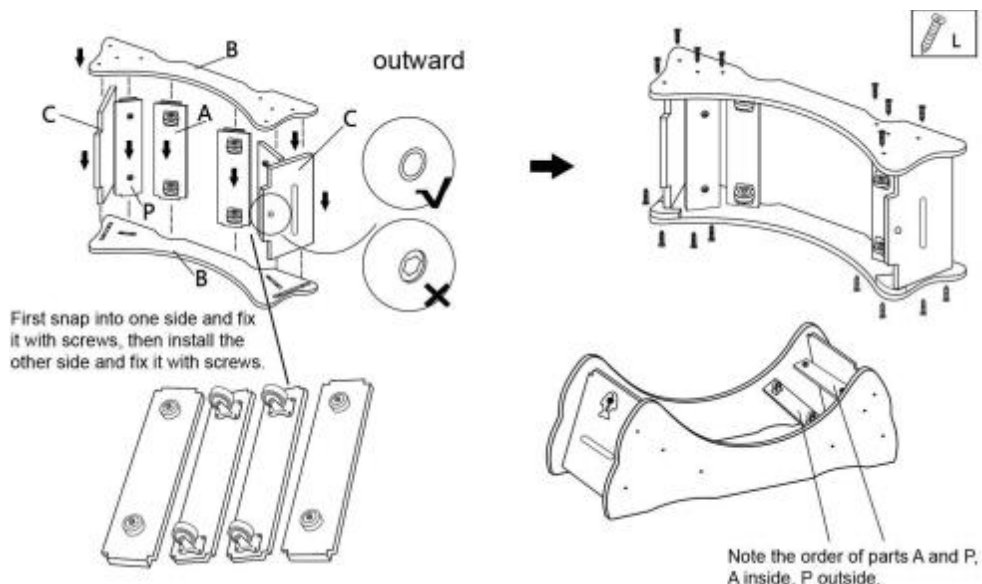

PASSO 2

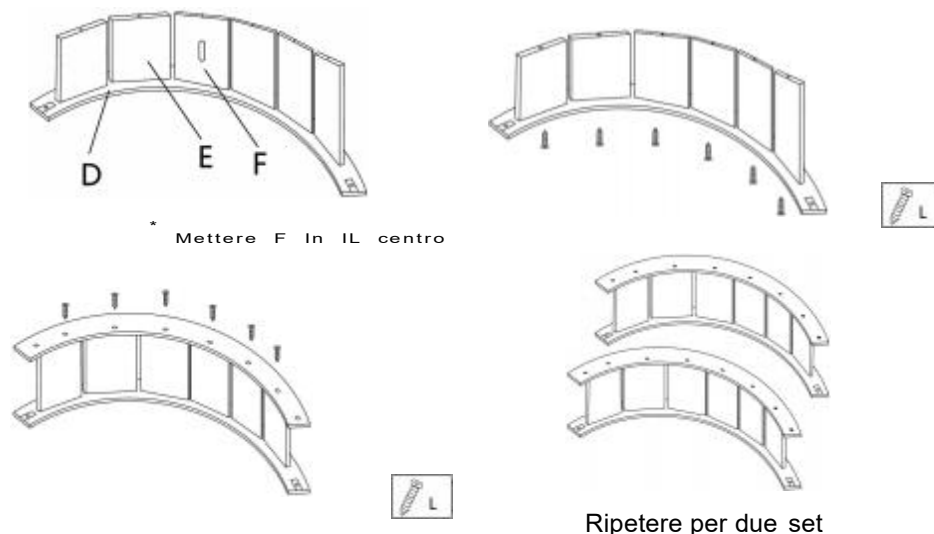

PASSO 3

Here, use E with double holes for installation.

**PASSO 4****PASSO 5**

This connection snaps into alignment.

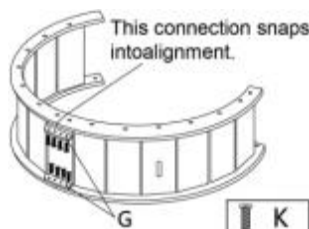
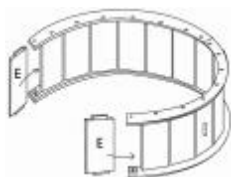
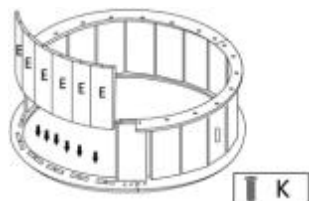
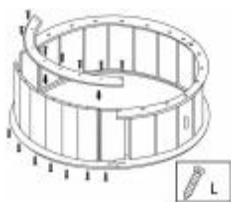
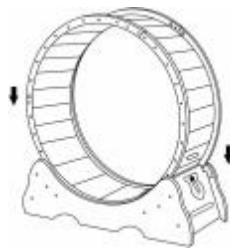
**PASSO 6****PASSO 7****PASSO 8****PASSO 9****PASSO 10****PASSO 11**

posizionare il rulli SU IL base.

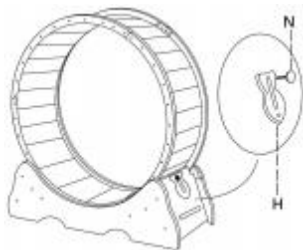
PASSO 12

collegare il piastra di bloccaggio H Con IL vite N E aggiustare Esso SU IL piatto con buchi C .

PASSO 13

Per favore incollare il fibbia nera come possedere In la figura sotto.

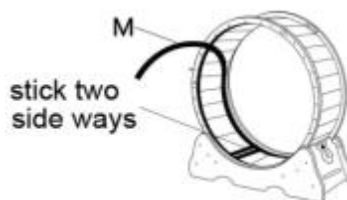

Mettere cintura nera indietro g lue suocera Strappare la parte superiore strato carta, lungo IL Rullo fisso un cerchio. (pulisci il rulli (prima pulisci !)

Il velcro degli accessori È inviato In uno pezzo, Quale ha bisogno di essere tagliato secondo al lunghezza del pista.

PASSO 14



FASE 15 Finito

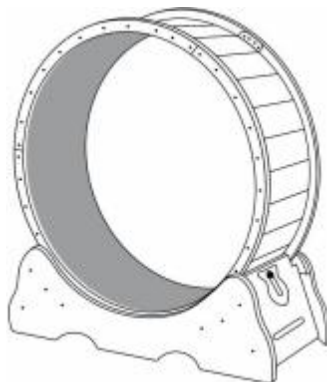

Serratura quando non In utilizzo .

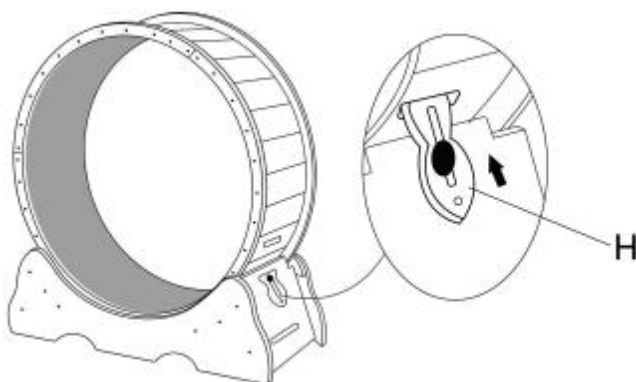

* H Di legno serratura è inserito in IL carta fessura E bloccato .

SUGGERIMENTI :

- 1 . IL numero Di viti segnato Sopra È IL attuale numero usato durante installazione . Quando IL prodotto È spedito , 1 ~3 Di più viti Di ogni tipo Volere essere dato COME pezzi di ricambio .
2. Durante il utilizzo del prodotto, bambini sono proibiti da avvicinandosi senza IL compagnia di adulti.
3. IL bordo Di IL prodotto È UN morso affilato , E Voi Bisogno A Indossare guanti per installazione ; A IL Stesso tempo , Esso viene con carta vetrata , COSÌ Voi Potere polacco IL di nuovo il bordo da solo; senza guanti , stai attento Quando toccando il corsa ruota .

Produttore: Shanghaimuxinmuyeyouxiangongsi

Indirizzo: Shuangchenglu 803nong11hao1602A-1609shi, baoshanqu,
shanghai 200000 CN.

RAPPRESENTANTE CE: E-CrossStu GmbH.

Mainzer Landstr.69, 60329 Francoforte sul Meno.

RAPPRESENTANTE DEL REGNO UNITO: YH CONSULTING LIMITED.

C/O YH Consulting Limited Ufficio 147, Centurion House, London Road,
Staines-upon-Thames, Surrey, TW18 4AX

Importato in AUS: SIHAO PTY LTD.

1 ROKEVA STREET EASTWOOD NSW 2122 Australia

Importato negli USA: Sanven Technology Ltd.

Suite 250, 9166 Anaheim Place, Rancho Cucamonga, CA 91730

VEVOR[®]

TOUGH TOOLS, HALF PRICE

Tecnico Supporto e certificato di garanzia elettronica

www.vevor.com/support

VEVOR®

TOUGH TOOLS, HALF PRICE

Techniczny Wsparcie i certyfikat gwarancji elektronicznej
www.vevor.com/support

KOT ĆWICZENIA KOŁO UŻYTKOWNIK PODRĘCZNIK

Nadal staramy się oferować Państwu narzędzia w konkurencyjnych cenach. „Oszczędź połowę”, „Połowa ceny” lub inne podobne wyrażenia używane przez nas stanowią jedynie szacunkowe oszczędności, jakie możesz uzyskać, kupując u nas określone narzędzia w porównaniu z głównymi markami i niekoniecznie oznaczają one objęcie wszystkich kategorii narzędzi oferowanych przez nas. Uprzejmie przypominamy, aby dokładnie sprawdzić, czy składając u nas zamówienie faktycznie oszczędzasz połowę w porównaniu z głównymi markami.

VEVOR[®]
TOUGH TOOLS, HALF PRICE

CAT EXERCISE
WHEEL

Modelka : 4.0 XS4 .0 M 4.0 XL4 .0 XXL

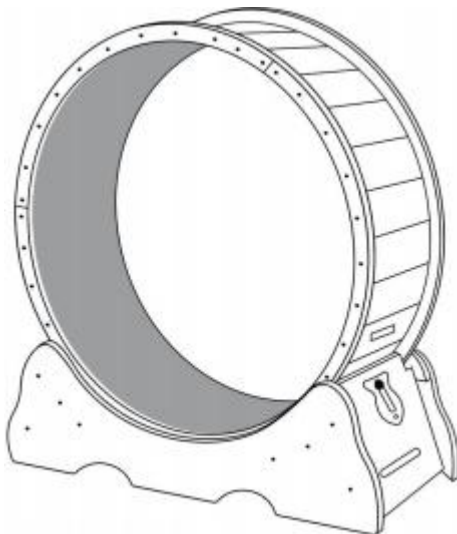

POTRZEBOWAĆ POMOC? KONTAKT NAS!

Mieć produkt pytania s? Potrzebować techniczny wsparcie? Proszę
czuć bezpłatny skontaktować się nas :

Wsparcie techniczne i certyfikat e-
gwarancji [Www.vevor.
com/wsparcie](http://www.vevor.com/wsparcie)

Ten Jest ten oryginalny instrukcja , Proszę Czytać Wszystko podręcznik instrukcje

ostrożnie przed operacją. VEVOR rezerwuje A jasne interpretacja naszego instrukcja obsługi . Ten wygląd ten produkt powinien podlegać ten

produkt ty otrzymane. proszę wybaczyć my, że nie będziemy poinformować cię Ponownie Jeśli czy istnieje jakaś technologia lub oprogramowanie aktualizacje na temat Nasz produkt.

SPECYFIKACJE

Model	4.0 XS
rozmiar produktu	750x320 X 800 mm
kolor	Naturalny









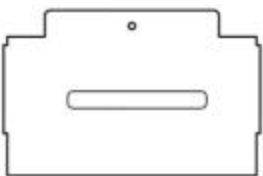

Model	4.0 M
rozmiar produktu	910×320×970mm
kolor	Natural

Model	4.0 XL
rozmiar produktu	1105×345×1170mm
kolor	Black

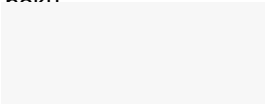
Model	4.0 XL
rozmiar produktu	1105×345×1170mm
kolor	White

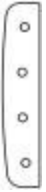
Model	4.0 XXL
rozmiar produktu	1320×340×1415mm
kolor	Natural

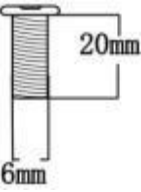
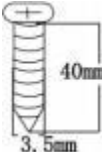
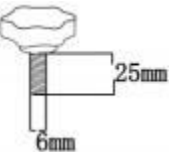
SKŁADNIKI

 <p>Siekiera 2 Px 2</p>	 <p>Bx2</p>	 <p>*C A deska z tylko jeden otwór na śrubę CX 2</p>
 <p>Dx6</p>	<p>* trzy sztuki z mi mieć podwójne dziury NA z boku</p>  <p>4 . oXS /4 .OM Przykład 17 4 . OX /4 . OXXL Przykład 23</p>	 <p>Efekt 1</p>
 <p>Gx6</p>	 <p>Wysokość 1</p>	 <p>Kx24</p>
 <p>4 . oXS /4 .Om Lx58 4 . OX /4 . OXXL Lx70</p>	 <p>Nx1</p>	 <p>Mx1</p>

* składniki A, C, MI, F, P mam zostać przed zainstalowany z elektromagnesy plastikowe. * Każdy zestaw zawiera śrubokręt, teaser kota , rękawice I papier ścierny.

Montaż Instrukcje

Wskazówka dotycząca instrukcji:

Do nie dokręcaj śrub montażowych do końca czas, I dokręcać ich Ponownie po tym jak pojedynczy składnik jest zainstalowane i uformowane!

KROK 1 Opierać instalacja

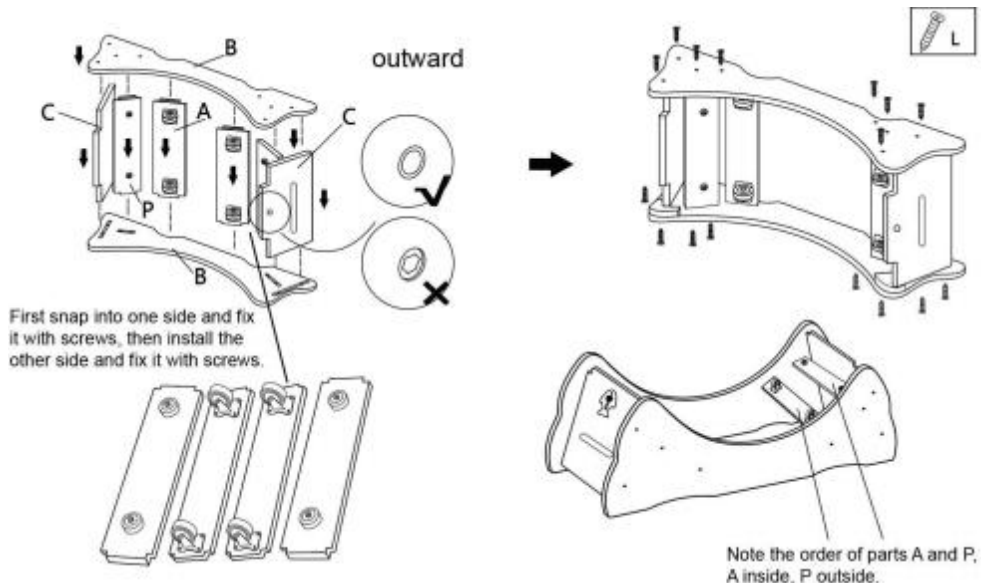

KROK 2

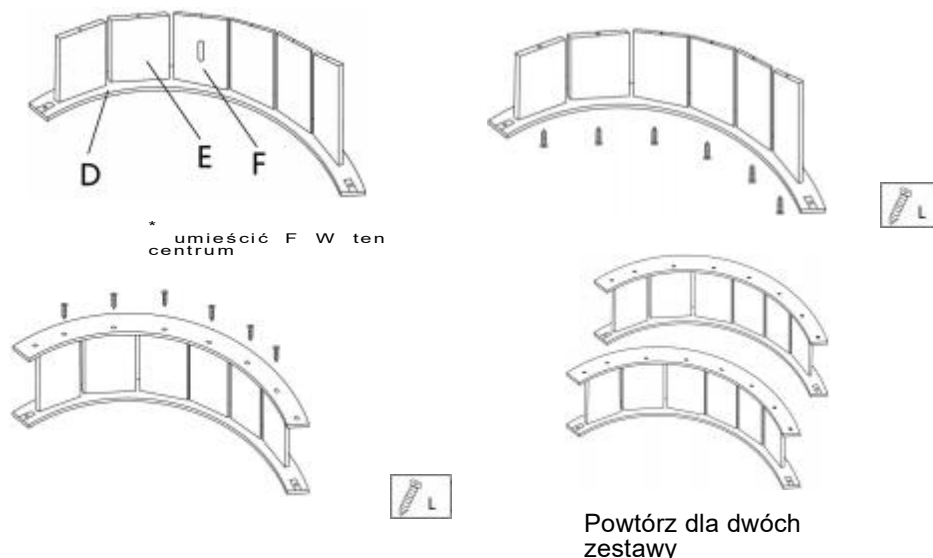

KROK 3

Here, use E with double holes for installation.

**KROK 4****KROK 5**

This connection snaps into alignment.

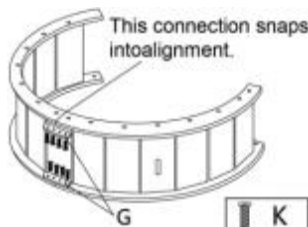
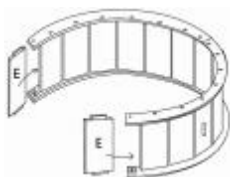
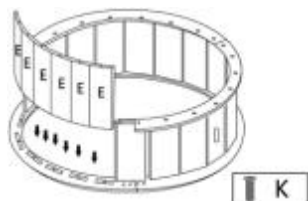
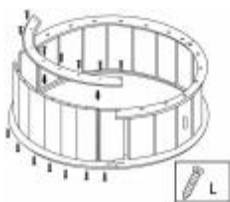
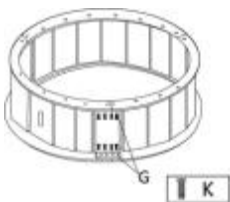
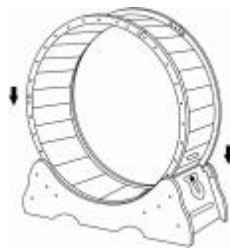
**KROK 6****KROK 7****KROK 8****KROK 9****KROK 1 0****KROK 1 1**

umieścić wałki NA ten opierać.

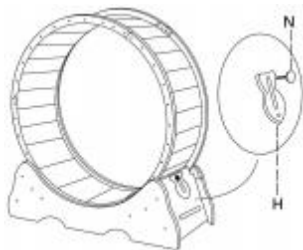
KROK 12

połączyć płyta zamka H Z ten śruba N i naprawić To NA ten płyta z dziury C .

KROK 13

Proszę wklej czarna klamra jako mieć własne W postać poniżej.

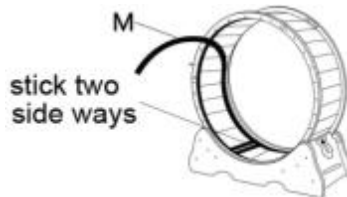

umieścić czarna pas klej do pleców teściowa Oderwij górę warstwa papier, wzdłuż ten Wałek stały jedno koło. (wytrzyj wałki (najpierw wyczyść !)

Rzep akcesoriów Jest wysłany W jeden sztuka, Który potrzebuje być ciętym zgodnie do długość z pas startowy.

KROK 14



KROK 15 Zakończony

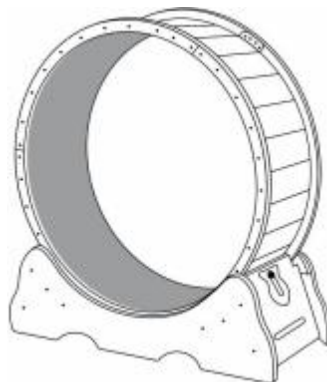

Zamek to kiedy nie W używać .

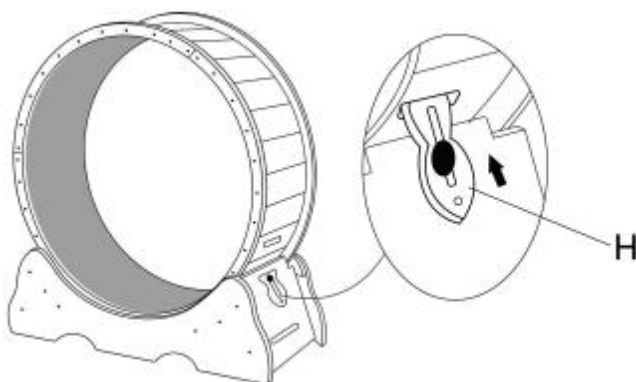

* H Drewniany zamek jest wstawiony do ten karta szczelina I zamknięty .

PORADY :

1 . Ten numer z śruby wyraźny powyżej Jest ten rzeczywisty numer używany podczas

instalacja . Kiedy ten produkt Jest wysłany , 1 ~3 więcej śruby z każdy typ będzie być danym Jak części zamienne .

2 . Podczas używać z produkt , dzieci są zabronione zbliżający się bez ten towarzystwo dorosłych .

3 . Ten krawędź z ten produkt Jest A fragment ostry , I Ty potrzebować Do nosić rękawice Do

instalacja ; Na ten To samo czas , To komes z papier ścierny Więc Ty Móc polski ten krawędź ponownie samemu; bez rękawiczek , bądź ostrożny Kiedy dotykając działanie koło .

Producent: Shanghaimuxinmuyeyouxiangongsi

Adres: Shuangchenglu 803nong11hao1602A-1609shi, baoshanqu,
szanghaj 200000 CN.

Przedstawiciel KE: E-CrossStu GmbH.

Mainzer Landstr.69, 60329 Frankfurt nad Menem.

ODPOWIEDZIALNOŚĆ W WIELKIEJ BRYTANII: YH CONSULTING
LIMITED.

C/O YH Consulting Limited Biuro 147, Centurion House, London Road,
Staines-upon-Thames, Surrey, TW18 4AX

Importowane do AUS: SIHAO PTY LTD.

1 ROKEVA STREETEASTWOOD NSW 2122 Australia

Importowane do USA: Sanven Technology Ltd.

Apartament 250, 9166 Anaheim Place, Rancho Cucamonga, CA 91730

VEVOR[®]

TOUGH TOOLS, HALF PRICE

Techniczny Wsparcie i certyfikat e-gwarancji

www.vevor.com/support

VEVOR®

TOUGH TOOLS, HALF PRICE

Technisch Support und E-Garantie-Zertifikat www.vevor.com/support

KATZE ÜBUNG RAD BENUTZER HANDBUCH

Wir sind weiterhin bestrebt, Ihnen Werkzeuge zu wettbewerbsfähigen Preisen anzubieten.

„Sparen Sie die Hälfte“, „Halber Preis“ oder andere ähnliche Ausdrücke, die wir verwenden, stellen nur eine Schätzung der Ersparnis dar, die Sie beim Kauf bestimmter Werkzeuge bei uns im Vergleich zu den großen Topmarken erzielen können, und decken nicht unbedingt alle von uns angebotenen Werkzeugkategorien ab. Wir möchten Sie freundlich daran erinnern, bei Ihrer Bestellung bei uns sorgfältig zu prüfen, ob Sie im Vergleich zu den großen Topmarken tatsächlich die Hälfte sparen.

VEVOR[®]
TOUGH TOOLS, HALF PRICE

CAT EXERCISE
WHEEL

Modell : 4.0 Größe XS 4.0 M 4.0 XL 4.0 XXL

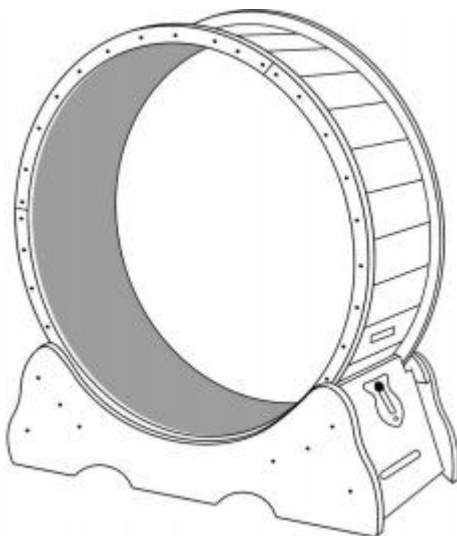

BRAUCHEN HELFEN? KONTAKT UNS!

Haben Produkt Fragen ? Brauchen technisch Unterstützung? Bitte fühlen frei Kontaktieren Sie uns :

Technischer Support und E-Garantie-
Zertifikat www.vevor.com/support

Das Ist Die Original Anweisung , Bitte lesen alle Handbuch Anweisungen durch , bevor Sie es in Betrieb nehmen. VEVOR Reserven A klar Interpretation unserer Benutzerhandbuch . Der Aussehen von Die Das Produkt soll unterliegen Die

Produkt Sie erhalten. bitte verzeihen uns, dass wir nicht informieren Sie wieder Wenn es gibt jede Technologie oder Software Updates auf unser

Produkt.

Spezifikationen

Modell	4.0 Größe
Produktgröße	750 x 320 X 800 mm
Farbe	Natürlich







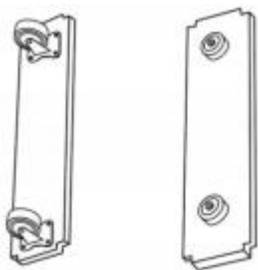

Modell	4.0 M
Produktgröße	910×320×970mm
Farbe	Natural

Modell	4.0 XL
Produktgröße	1105×345×1170mm
Farbe	Black

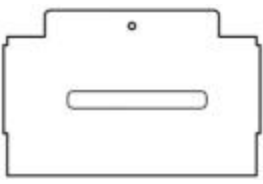
Modell	4.0 XL
Produktgröße	1105×345×1170mm
Farbe	White

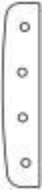
Modell	4.0 XXL
Produktgröße	1320×340×1415mm
Farbe	Natural

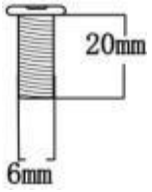
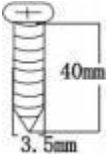
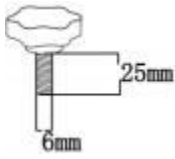
KOMPONENTEN

 <p>Axt 2 Px 2</p>	 <p>Buch 2</p>	 <p>*C A Planke mit nur eins Schraubenloch Cx 2</p>
 <p>Dx 6</p>	<p>* drei Stücke von E habe doppelt Löcher An die Seite</p> <p>4.oXS / 4. OM Ex 17 4. OXL / 4.OXXL 2. Mose 23</p>	 <p>Effekt 1</p>
 <p>Gx 6</p>	 <p>Hx 1</p>	 <p>Kx 24</p>
 <p>4.oXS / 4. OM Lx 58 4. OXL / 4.OXXL Lx 70</p>	 <p>Nx 1</p>	 <p>Mx 1</p>

* Komponenten A, C, E, F, P haben gewesen Vor installiert mit Kunststoffsolenoide. * Jedes Set enthält einen Schraubendreher, Katzentaser , Handschuhe Und Sandpapier.

Montage Anweisungen

Anleitungshinweis:

Tun die Befestigungsschrauben nicht bis zum Anschlag anziehen. Zeit, Und anziehen ihnen wieder nachdem eine einzelne Komponente installiert und geformt!

SCHRITT 1 Base Installation

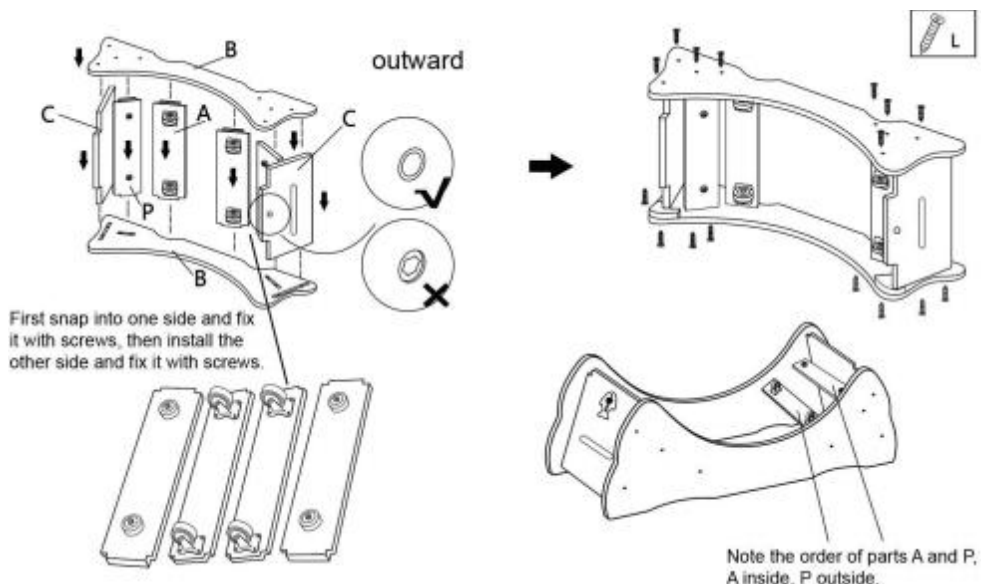

SCHRITT 2

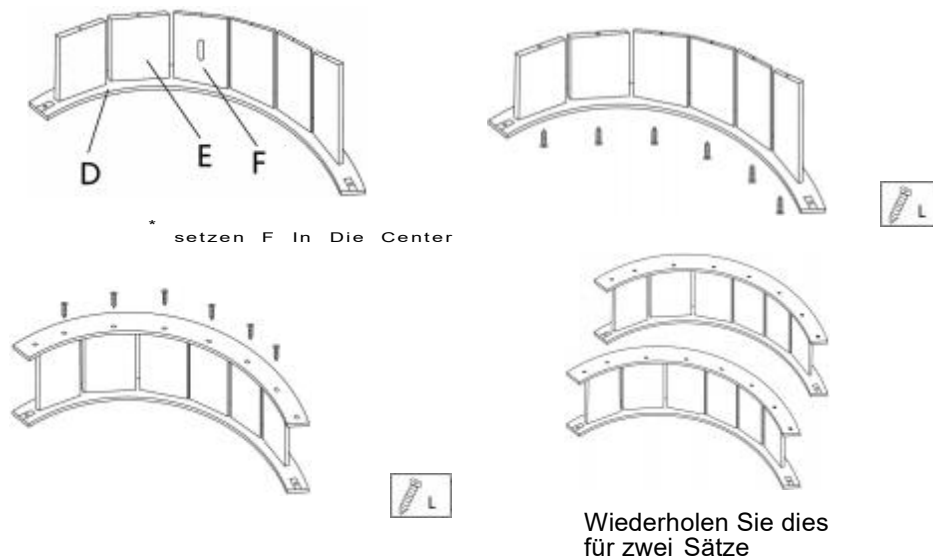

SCHRITT 3

Here, use E with double holes for installation.

**SCHRITT 4****SCHRITT 5**

This connection snaps into alignment.

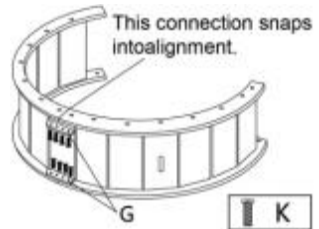
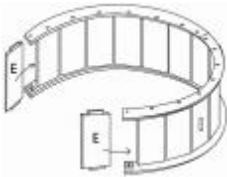
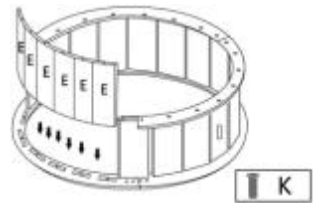
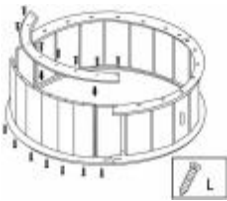
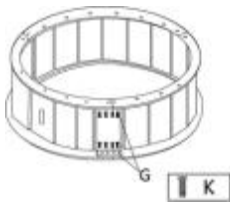
**SCHRITT 6****SCHRITT 7****SCHRITT 8****SCHRITT 9****SCHRITT 10****SCHRITT 11**

Platzieren Sie die Rollen An Die Base.

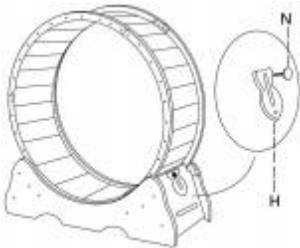
SCHRITT 12

Verbinden Sie die Schlossplatte H Mit Die screw [ˈsɛn] VERB trans Und Fix Es An Die Platte mit Löcher C .

SCHRITT 13

Bitte fügen Sie den schwarze Schnalle als sie besitzt In die Figur unten.

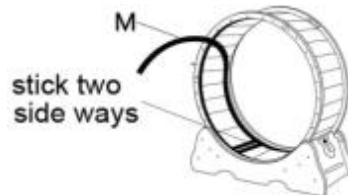

setzen schwarzer Gürtelrückenkleber Schwiagemutter
Reißen Sie die Spitze ab Schicht Papier, zusammen Die Rolle feststehend ein Kreis. (wischen Sie die Rollen erstmal sauber machen !)

Der Klettverschluss des Zubehörs Ist ausgesandt In eins

	<p>Stück, welche muss zugeschnitten werden zur Länge der Runway.</p>
--	--

SCHRITT 14



SCHRITT 15 Fertig

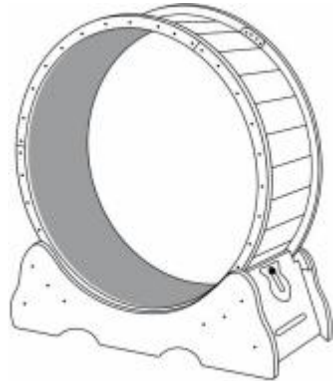

Sperren es wenn nicht In verwenden .

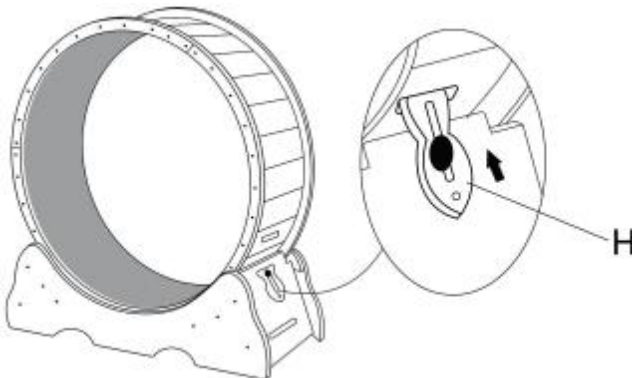

* H Aus Holz sperren wird eingefügt hinein Die Karte Slot Und gesperrt .

TIPPS :

1 . Der Nummer von Schrauben markiert über Ist Die tatsächlich Nummer gebraucht während

Installation . Wann Die Produkt Ist versendet , 1 ~3 mehr Schrauben von jede Typ Wille gegeben werden als Ersatzteile .

2 . Während der verwenden der Produkt, Kinder ist verboten, nähert sich ohne Die Gesellschaft eines Erwachsenen.

3 . Der Rand von Die Produkt Ist A bisschen scharf, Und Du brauchen Zu tragen Handschuhe für

Installation ; bei Die Dasselbe Zeit, Es kommt mit Schleifpapier , Also Du dürfen polieren Die wieder rand alleine; ohne Handschuhe , Seien Sie vorsichtig Wann Berühren der läuft Rad .

Hersteller: Shanghaimuxinmuyeyouxiangongsi

Adresse: Shuangchenglu 803nong11hao1602A-1609shi, baoshanqu,
Shanghai 200000 CN.

EG-Vertreter: E-CrossStu GmbH.

Mainzer Landstr.69, 60329 Frankfurt am Main.

UK-VERTRETER: YH CONSULTING LIMITED.

C/O YH Consulting Limited Office 147, Centurion House, London Road,
Staines-upon-Thames, Surrey, TW18 4AX

Nach AUS importiert: SIHAO PTY LTD.

1 ROKEVA STREETEASTWOOD NSW 2122 Australien

In die USA importiert: Sanven Technology Ltd.

Suite 250, 9166 Anaheim Place, Rancho Cucamonga, CA 91730

VEVOR[®]

TOUGH TOOLS, HALF PRICE
Technisch Support und E-Garantie-Zertifikat
www.vevor.com/support

VEVOR®

TOUGH TOOLS, HALF PRICE

Technique Certificat d'assistance et de garantie électronique
www.vevor.com/support

CHAT EXERCICE ROUE UTILISATEUR MANUEL

Nous continuons à nous engager à vous fournir des outils à des prix compétitifs. « Économisez la moitié », « Moitié prix » ou toute autre expression similaire utilisée par nous ne représente qu'une estimation des économies que vous pourriez réaliser en achetant certains outils chez nous par rapport aux grandes marques et ne couvre pas nécessairement toutes les catégories d'outils que nous proposons. Nous vous rappelons de bien vouloir vérifier soigneusement lorsque vous passez une commande chez nous si vous économisez réellement la moitié par rapport aux grandes marques.

Modèle : 4.0 XS 4.0 M 4.0 XL 4.0 XXL

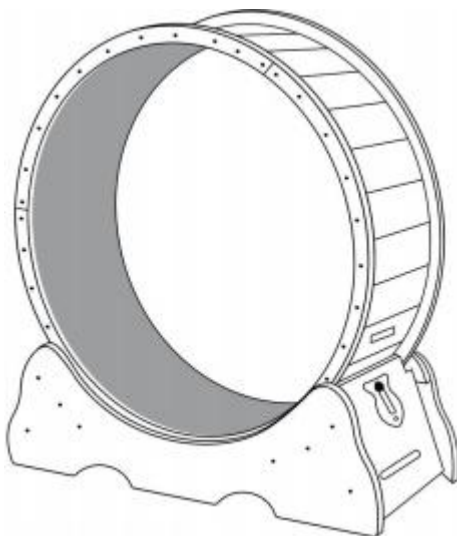

BESOIN AIDE? CONTACT NOUS!

Avoir produit des questions ? Besoin technique soutien? S'il te plaît sentir gratuit pour contacter nous :

certificat de garantie électronique
www.vevor.com/support

Ce est le original instruction , s'il te plaît lire tous manuel instructions soigneusement avant d'utiliser. VEVOR se réserve un clair interprétation de notre Manuel d'utilisation . Le apparition de le le produit doit être soumis à le produit vous reçu. S'il te plaît, pardonne nous que nous ne le ferons pas vous informer encore si il existe une technologie ou un logiciel mises à

jour sur notre produit.

CARACTÉRISTIQUES

Modèle	4.0 XS
taille du produit	750 x 320 x 800 mm
couleur	Naturel









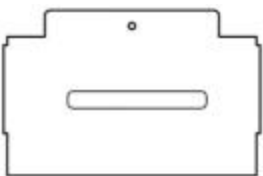

Modèle	4.0 M
taille du produit	910×320×970mm
couleur	Natural

Modèle	4.0 XL
taille du produit	1105×345×1170mm
couleur	Black

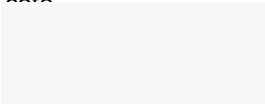
Modèle	4.0 XL
taille du produit	1105×345×1170mm
couleur	White

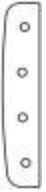
Modèle	4.0 XXL
taille du produit	1320×340×1415mm
couleur	Natural

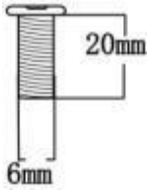
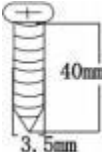
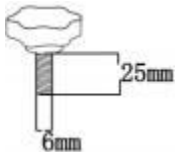
COMPOSANTS

 <p>Hache 2 Px 2</p>	 <p>Bx 2</p>	 <p>*c un planche avec seulement un trou de vis CX 2</p>
 <p>Dx 6</p>	<p>* trois pièces de E avoir le double trous sur le côté</p>  <p>4 . oXS /4 . OM Ex 17 4 . OXL /4 .OXXL Exe 23</p>	 <p>Effet 1</p>
 <p>Gx6</p>	 <p>Hx 1</p>	 <p>Kx 24</p>
 <p>4 . oXS /4 . OM Lx 58 4 . OXL /4 .OXXL Lx70</p>	 <p>Nx 1</p>	 <p>MX 1</p>

* composants A, C, E, F, P a a été pré installé avec solénoïdes en plastique. * Chaque ensemble est livré avec un tournevis, teaser de chat, gants et papier de verre.

Assemblée Instructions

Astuce d'instructions :

Faire ne serrez pas les vis de montage à fond d' un seul coup temps, et serrer eux encore après qu'un seul composant soit installé et formé !

ÉTAPE 1 Base installation

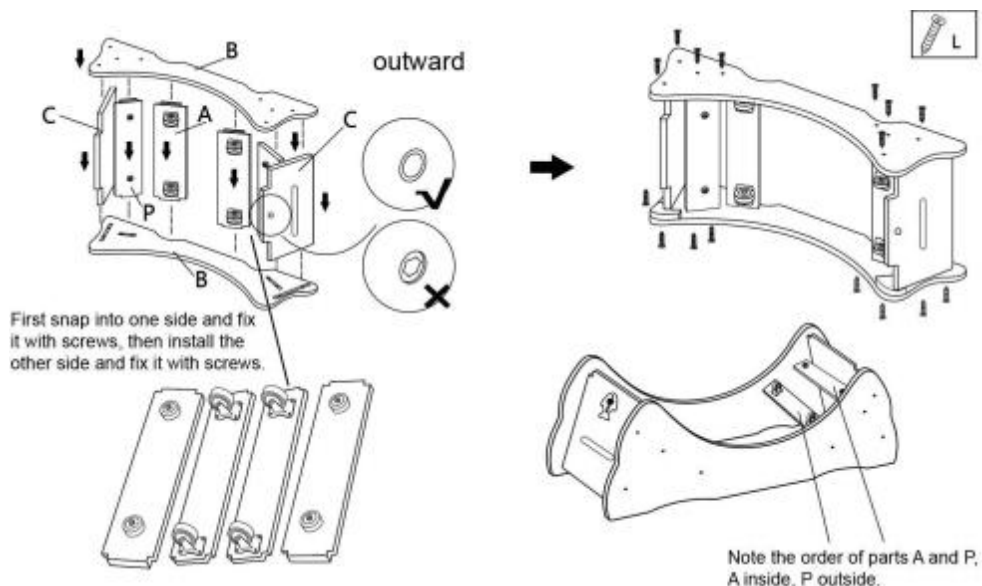

ÉTAPE 2

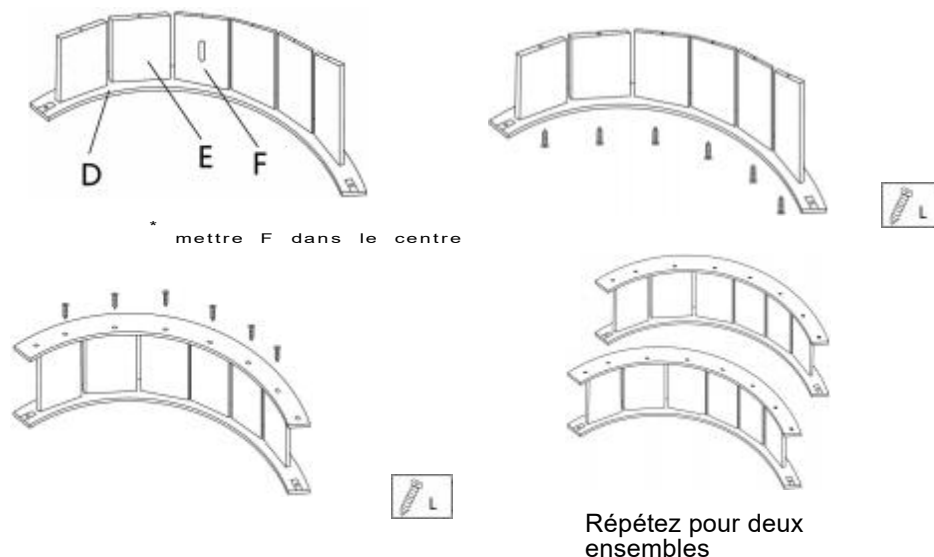

ÉTAPE 3

Here, use E with double holes for installation.



ÉTAPE 4



ÉTAPE 5

This connection snaps into alignment.

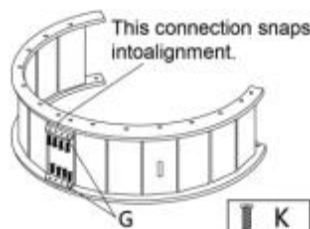

ÉTAPE 6

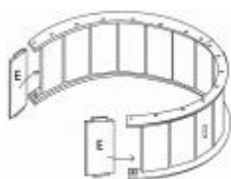

ÉTAPE 7



ÉTAPE 8

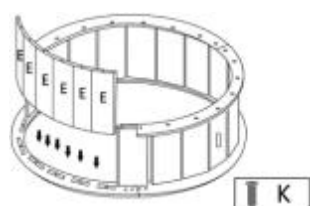

ÉTAPE 9

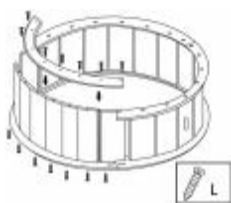

ÉTAPE 10



ÉTAPE 11



placez le rouleaux sur le base.

ÉTAPE 12

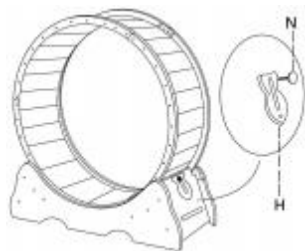

connecter le plaque de verrouillage H
Avec le vis N et réparer il sur le plaque
avec trous C .

ÉTAPE 13

s'il te plaît coller le boucle noire comme elle possède dans la
figure ci-dessous.

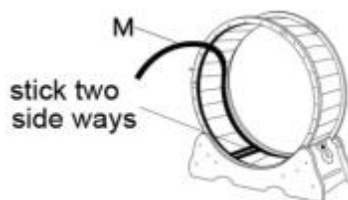

mettre colle arrière pour ceinture noire belle-mère Arrache
le haut couche papier, le long de le Rouleau fixe un cercle.
(essuyer le rouleaux nettoyer d'abord !)

Le velcro des accessoires est envoyé dans un morceau,
lequel a besoin de être coupé selon au longueur de la

	piste.
--	--------

ÉTAPE 14



ÉTAPE 15 Terminé

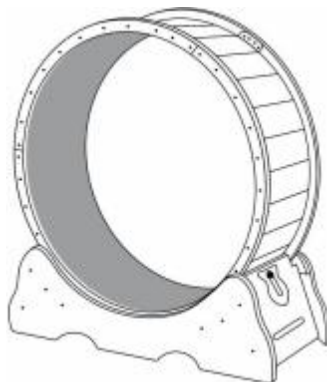

Verrouillage c'est quand pas dans utiliser .

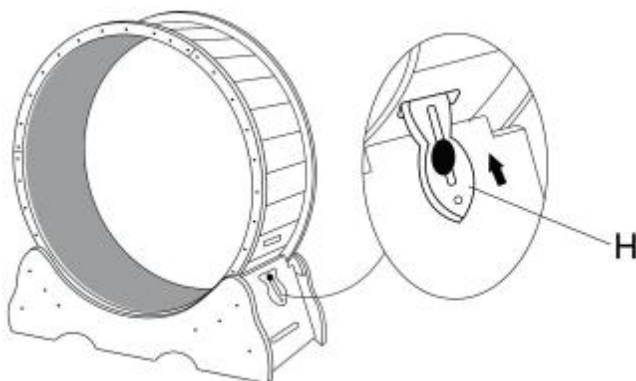

* H En bois verrouillage est inséré dans le carte fente et fermé .

CONSEILS :

- 1 . Le nombre de vis marqué au-dessus de est le réel nombre utilisé pendant montage . quand le produit est expédié , 1 ~ 3 plus vis de chaque taper volonté être donné comme pièces de rechange .
2. Pendant la utiliser de la produit , enfants sont interdits de approchant sans le compagnie d' adultes.
3. Le bord de le produit est un peu pointu , et toi besoin à porter gants pour installation ; à le même temps , il vient avec papier de verre , Donc toi peut polonais le bord à nouveau par toi-même; sans gants , sois prudent quand toucher le en cours d'exécution roue .

Fabricant : Shanghaimuxinmuyeyouxiangongsi

Adresse : Shuangchenglu 803nong11hao1602A-1609shi, baoshanqu,
Shanghai 200000 CN.

CE REP : E-CrossStu GmbH.

Mainzer Landstr.69, 60329 Francfort-sur-le-Main.

REPRÉSENTANT AU ROYAUME-UNI : YH CONSULTING LIMITED.

A/S YH Consulting Limited Bureau 147, Centurion House, London Road,
Staines-upon-Thames, Surrey, TW18 4AX

Importé en AUS : SIHAO PTY LTD.

1 ROKEVA STREET EASTWOOD NSW 2122 Australie

Importé aux États-Unis : Sanven Technology Ltd.

Suite 250, 9166 Anaheim Place, Rancho Cucamonga, CA 9173 0

VEVOR[®]

TOUGH TOOLS, HALF PRICE

Technique Certificat d'assistance et de garantie électronique

www.vevor.com/support

VEVOR®

TOUGH TOOLS, HALF PRICE

Technisch Ondersteuning en E-garantiecertificaat
www.vevor.com/support

KAT OEFENING WIEL GEBRUIKER HANDMATIG

Wij streven er voortdurend naar om u gereedschappen tegen concurrerende prijzen te leveren.

"Save Half", "Half Price" of andere soortgelijke uitdrukkingen die wij gebruiken, geven alleen een schatting van de besparingen die u kunt behalen door bepaalde gereedschappen bij ons te kopen in vergelijking met de grote topmerken en betekent niet noodzakelijkerwijs dat alle categorieën gereedschappen die wij aanbieden, worden gedekt. Wij herinneren u eraan om zorgvuldig te controleren of u daadwerkelijk de helft bespaart in vergelijking met de grote topmerken wanneer u een bestelling bij ons plaatst.

VEVOR[®]
TOUGH TOOLS, HALF PRICE

CAT EXERCISE
WHEEL

Model : 4.0 Maat XS 4.0 M 4.0 XL 4.0 XXL

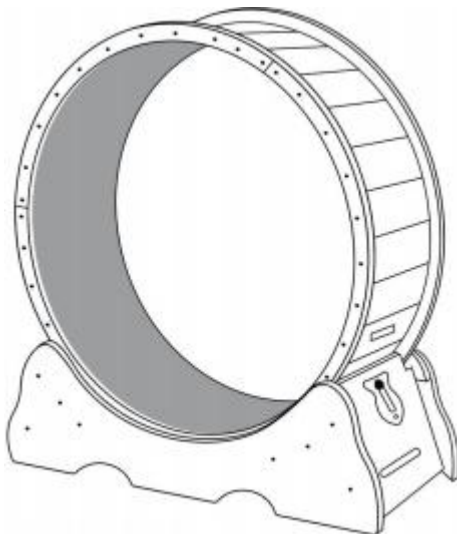

BEHOEFTE HULP? CONTACT ONS!

Hebben product vragen ? Behoeftte technisch steun? Alsjeblieft
gevoel vrij contact opnemen ons :

Technische ondersteuning en E-garantie
certificaat [www.vevor.
com/ondersteuning](http://www.vevor.com/ondersteuning)

Dit is de origineel instructie , Alsjeblieft lezen alle handmatig instructies zorgvuldig door voordat u gaat gebruiken. VEVOR behoudt zich het recht voor A duidelijk interpretatie van onze gebruikershandleiding . De verschijning van de product zal onderworpen zijn aan de product jij ontvangen. vergeef me alsjeblieft ons dat we niet zullen u informeren opnieuw als er is enige technologie of software updates over ons product.

SPECIFICATIES

Model	4.0 XS
productgrootte	750x320 X 800mm
kleur	Natuurlijk









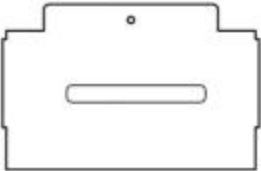

Model	4.0 M
productgrootte	910×320×970mm
kleur	Natural

Model	4.0 XL
productgrootte	1105×345×1170mm
kleur	Black

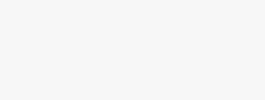
Model	4.0 XL
productgrootte	1105×345×1170mm
kleur	White

Model	4.0 XXL
productgrootte	1320×340×1415mm
kleur	Natural

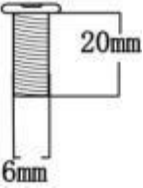
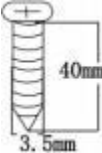
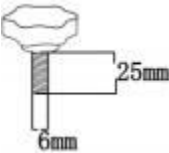
COMPONENTEN

 <p>Bijl 2 Px 2</p>	 <p>Bx2</p>	 <p>*C A plank met alleen een schroefgat Cx2</p>
 <p>Dx6</p>	<p>* drie stukken van lk hebben dubbel gaten op de zijkant</p>  <p>4 . oXS /4 .OM Bijv . 17 4 . OXL /4 .OXXL Bijv . 23</p>	 <p>Fx1</p>
 <p>Gx6</p>	 <p>Hx1</p>	 <p>Kx24</p>
 <p>4 . oXS /4 .OM Lx58 4 . OXL /4 .OXXL Breedte 70</p>	 <p>Nummer 1</p>	 <p>MX1</p>

* componenten A, C, Ik, F, P hebben geweest pre geïnstalleerd met kunststof solenoïden. * Elke set wordt geleverd met een schroevendraaier, kat teaser, handschoenen En schuurpapier.

Montage Instructies

Instructies:

Doen draai de bevestigingsschroeven niet tot het einde vast op één tijd, En aanspannen hen opnieuw nadat een enkel onderdeel is geïnstalleerd en gevormd!

STAP 1 Baseren installatie

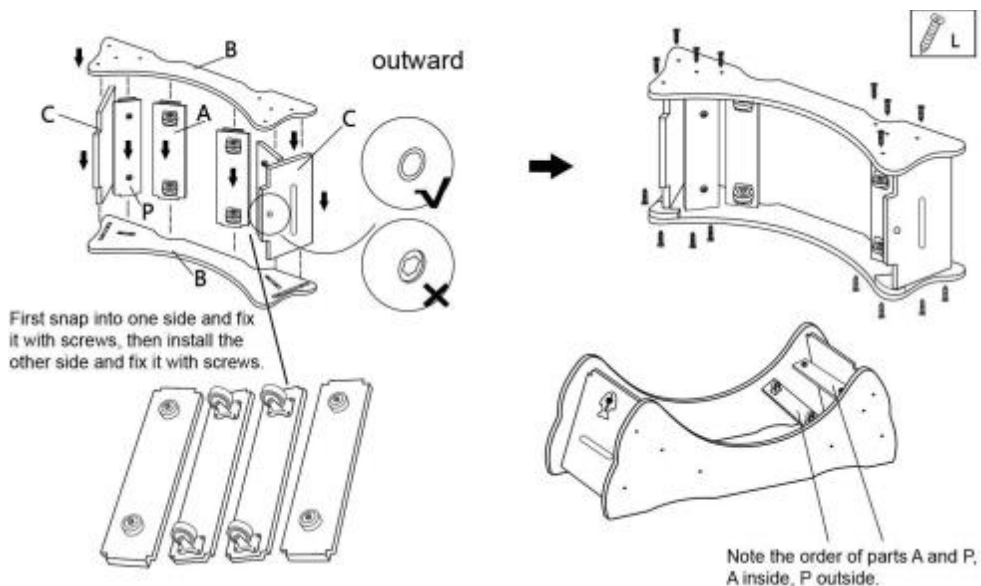

STAP 2

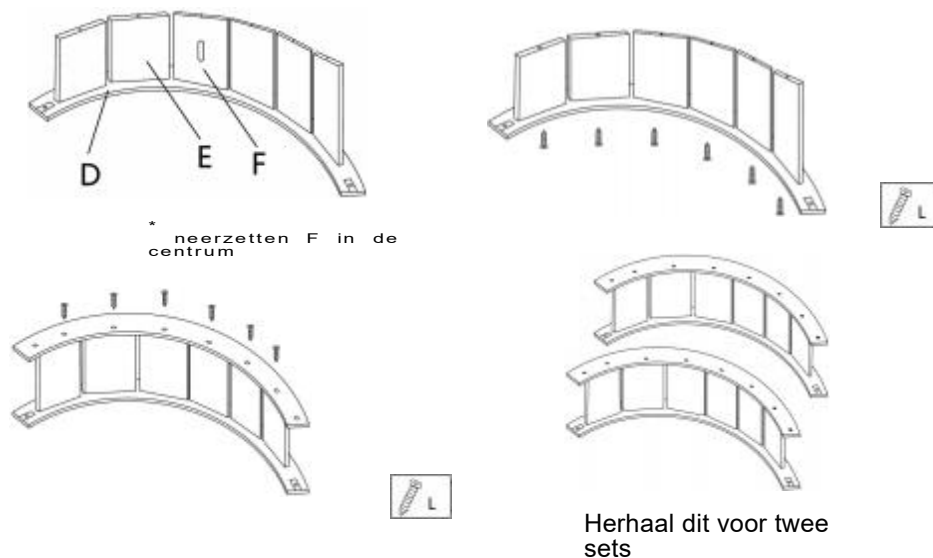

STAP 3

Here, use E with double holes for installation.



STAP 4



STAP 5

This connection snaps into alignment.

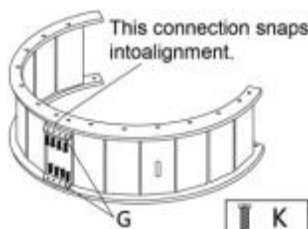

STAP 6

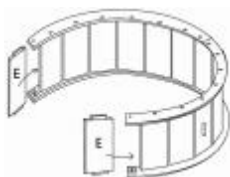

STAP 7



STAP 8

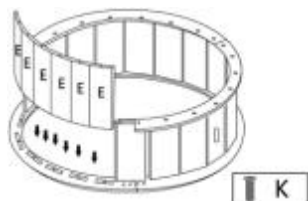

STAP 9

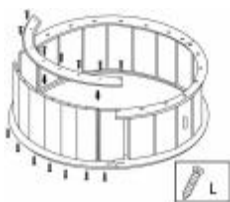

STAP 10



STAP 11

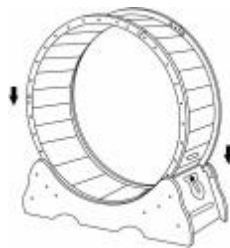

plaats de rollen op de baseren.

STAP 12

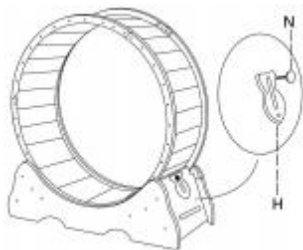

verbind de slotplaat H Met de de schroef N En repareren Het op de bord met gaten C .

STAP 13

Alsjeblift plak de zwarte gesp als sh eigen in het cijfer onderstaand.

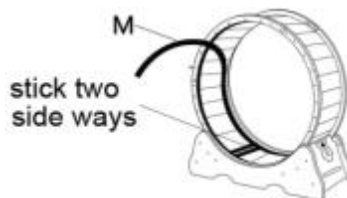

neerzetten zwarte band rug g lue schoonmoeder Scheur de bovenkant eraf laag papier, langs de Rol vast één cirkel. (veeg de rollen eerst schoonmaken !)

Het klittenband van de accessoires is verzonden in een deel, welke moet worden gesneden volgens naar de lengte

	van de landingsbaan.
--	----------------------

STAP 14



STAP 15 Afgerond

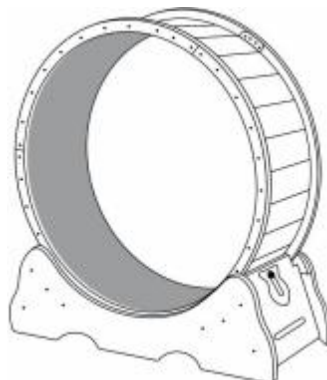

Slot het wanneer niet in gebruik.

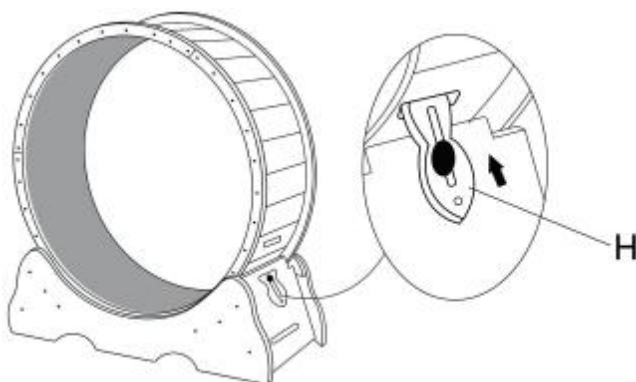

* H Houten slot is ingevoegd naar binnen de kaart sleuf En vergrendeld.

TIPS :

1 .De nummer van schroeven gemarkeerd boven is de actueel nummer gebruikt tijdens

installatie . wanneer de product is verzonden , 1 ~3 meer schroeven van elk type zullen gegeven worden als reserveonderdelen .

2. Tijdens de gebruik van de product, kinderen zijn verboden van naderend zonder de gezelschap van volwassenen.

3. De rand van de product is A b het scherp, En Jij behoefte naar dragen handschoenen voor

installatie ; bij de dezelfde tijd , Het komt met schuurpapier , Dus Jij kan Pools de rand opnieuw alleen; zonder handschoenen , wees voorzichtig wanneer aanraken van de rennen wiel .

Fabrikant: Shanghaimuxinmuyeyouxiangongsi

Adres: Shuangchenglu 803nong11hao1602A-1609shi, baoshanqu,
shanghai 200000 CN.

EG-REP: E-CrossStu GmbH.

Mainzer Landstr.69, 60329 Frankfurt am Main.

VK VERTEGENWOORDIGING: YH CONSULTING LIMITED.

C/O YH Consulting Limited Kantoor 147, Centurion House, London Road,
Staines-upon-Thames, Surrey, TW18 4AX

Geïmporteerd naar AUS: SIHAO PTY LTD.

1 ROKEVA STRAAT EASTWOOD NSW 2122 Australië

Geïmporteerd naar de VS: Sanven Technology Ltd.

Suite 250, 9166 Anaheim Place, Rancho Cucamonga, CA 91730

VEVOR[®]

TOUGH TOOLS, HALF PRICE

Technisch Ondersteuning en E-garantiecertificaat

www.vevor.com/support

