

VEVOR[®]

TOUGH TOOLS, HALF PRICE

Technical Support and E-Warranty Certificate www.vevor.com/support

DEEP WATER CULTURE BUCKET SYSTEM USER MANUAL

We continue to be committed to provide you tools with competitive price.

"Save Half", "Half Price" or any other similar expressions used by us only represents an estimate of savings you might benefit from buying certain tools with us compared to the major top brands and does not necessarily mean to cover all categories of tools offered by us. You are kindly reminded to verify carefully when you are placing an order with us if you are actually saving half in comparison with the top major brands.

VEVOR[®]

TOUGH TOOLS, HALF PRICE

DEEP WATER CULTURE BUCKET SYSTEM

MODEL: EHW0004C-DR

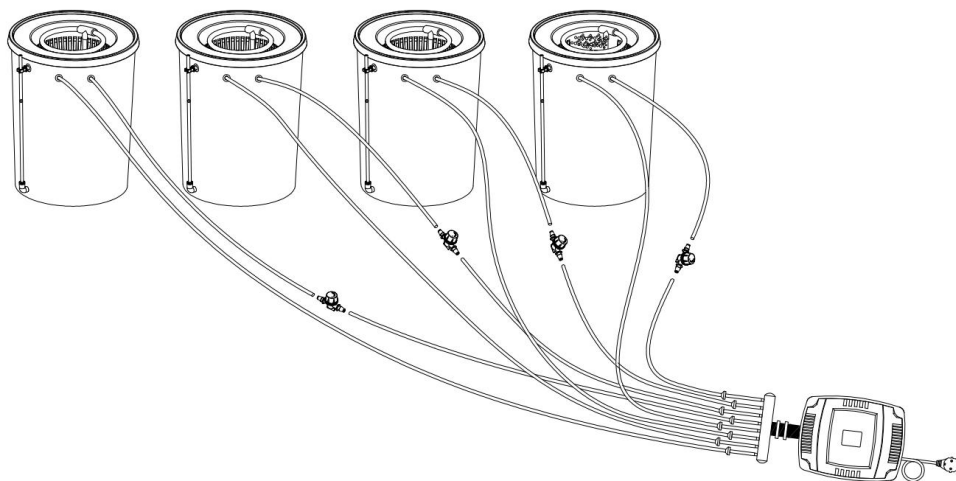

NEED HELP? CONTACT US!

Have product questions? Need technical support? Please feel free to contact us:

Technical Support and E-Warranty Certificate
www.vevor.com/support

This is the original instruction, please read all manual instructions carefully before operating. VEVOR reserves a clear interpretation of our user manual. The appearance of the product shall be subject to the product you received. Please forgive us that we won't inform you again if there are any technology or software updates on our product.



Thank you very much for choosing this product. Please read all of the instructions before using it. The information will help you achieve the best possible results.

	<p>Warning-To reduce the risk of injury, user must read instructions manual carefully.</p>
	<p>CORRECT DISPOSAL</p> <p>This product is subject to the provision of European Directive 2012/19/EC. The symbol showing a wheellie bin crossed through indicates that the product requires separate refuse collection in the European Union. This applies to the product and all accessories marked with this symbol. Products marked as such may not be discarded with normal domestic waste, but must be taken to a collection point for recycling electrical and electronic devices.</p>

SAFETY INSTRUCTION

WARNING:

Read all safety warnings, instructions, illustrations and specifications provided with this air pump. Failure to follow all instructions listed below may result in electric shock, fire and/or serious injury.

Basic Safety Information:

1. This product is for planting only.
2. Pulling or dragging the product with power line is not allowed.
3. When pulling out the plug, please hold the plug itself; do not pull the Power line.

4. Do not cut and replace the power plug by yourself, otherwise serious Consequence may incur.
5. Operation of the product is not allowed in case of damage with power line or the shell.
6. Disassembling and dismantling of the product by lay-people is not allowed.
7. In case the air pump drops into water, please cut off power supply before dredging it out. Then it should be handed over to professionals for check and maintenance.
8. Electrical shock hazard: Do not touch the air pump with wet hands or while standing on a wet surface. Always use the air pump in a dry environment and plug it into a properly grounded outlet.
9. Fire hazard: Do not use the air pump near flammable or combustible materials. Keep the air pump away from sources of heat or sparks, such as flames, cigarettes, or electrical appliances.
10. Explosion hazard: Do not use the air pump with gases that are flammable, explosive, or poisonous. Always check the safety data sheet (SDS) of the gas before using it with the air pump. Additionally, do not exceed the specified pressure range for the air pump.
11. Corrosion hazard: Do not use the air pump with gases that can corrode metals or exert chemical charges. Check the compatibility of the gas with the materials of the air pump and its accessories. Always use protective gloves and eyewear when handling corrosive materials.
12. Do not use a damaged plug or outlet, as this can cause electrical shock or fire.
13. If the supply cord is damaged, it must be replaced by the manufacturer, its service agent or similarly qualified persons in order to avoid a hazard.
14. This appliance can be used by children aged from 8 years and above and persons with reduced physical, sensory or mental capabilities or lack of experience and knowledge if they have been given supervision or instruction concerning use of the appliance in a safe way and understand the hazards involved. Children shall not play with the appliance. Cleaning

and user maintenance shall not be made by children without supervision.

15. Do not cut and replace the power plug by yourself, otherwise serious Consequence may incur.











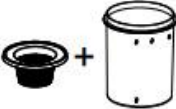

16. Operation of the product is not allowed in case of damage with power line or the shell.

17. Disassembling and dismounting of the product by lay-people is not allowed.

18. In case the air pump drops into water, please cut off power supply before dredging it out. Then it should be handed over to professionals for check and maintenance.

SAVE THESE INSTRUCTIONS

PARTS LIST

	Description	Picture	Quantity
A	Planting buckets		4
C	Red ball		4
D	Buckle		4
E	Seal ring		16
F	Water level tube340		4
G	In line check valve		8
H	Air stone		4
I	Black feeding Air hose(4x6)		12m
J	Air pump-8pin		1
K	Drip irrigation pipe-333-545		4
L	Water inlet tube-270		4
M	Air flow regulator		4
X	Clay pebbles-3		4bag

INSTALLATION

Friendly tips-tools required for installation:

1. Scissors
2. Hot hair dryer(Heating air hose for easy insertion)

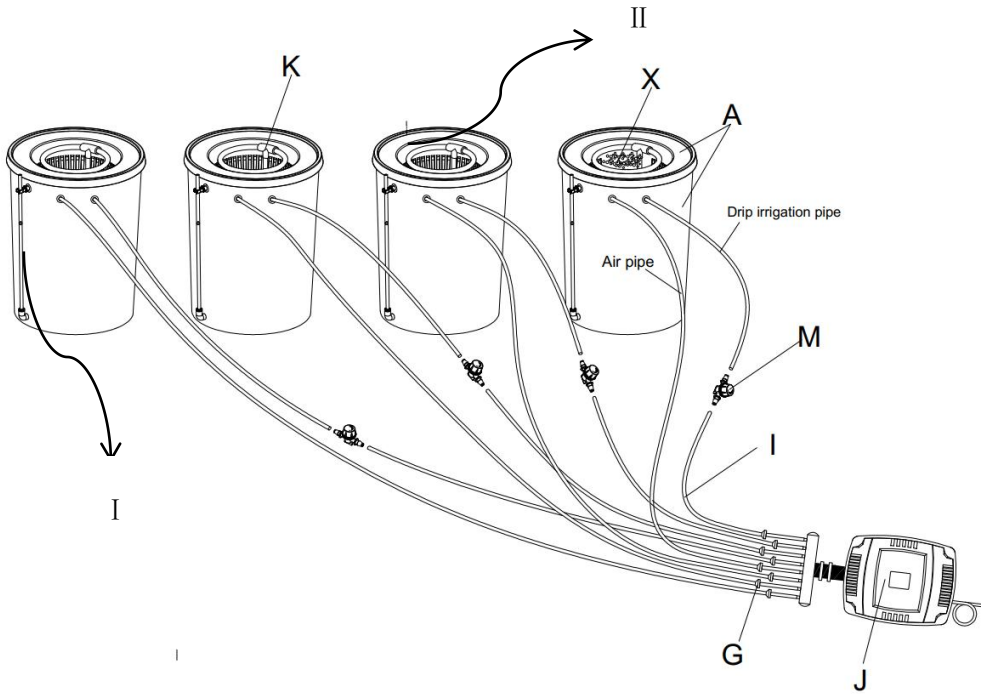

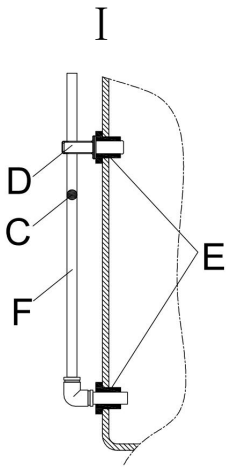

Connect F to the bucket as shown

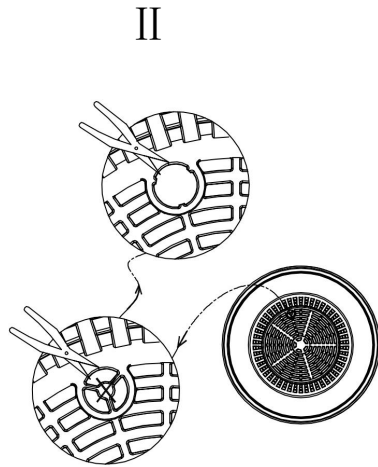

Cut off the plastic at the bottom of the basket of part A, as shown in the picture on the right, and then put it into the bucket

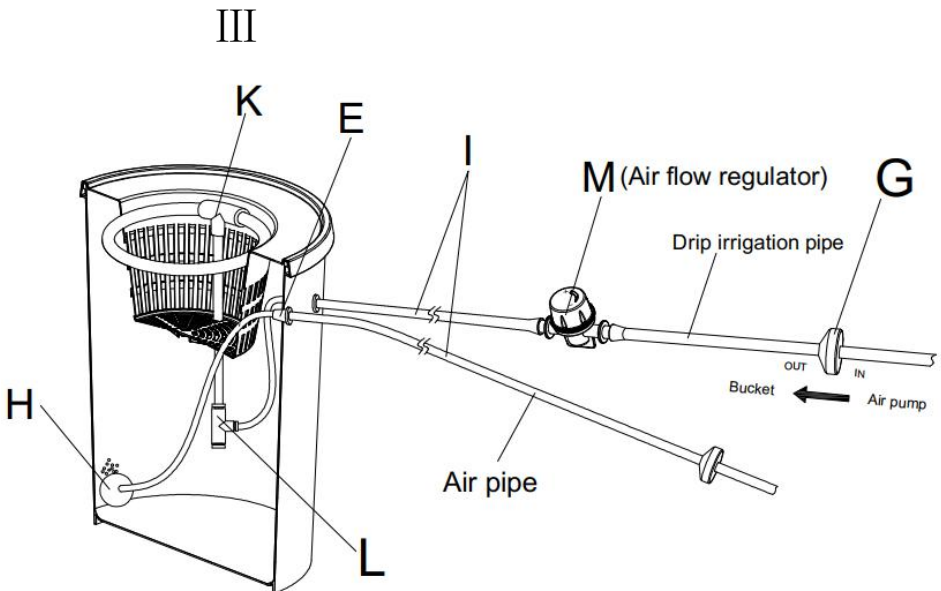

Use Tips:

Air Stone(H)



-Before connecting and assembling the gas stone please fully immerse it in water for 10 seconds to fill the inside of the gas stone with water, which is conducive to the generation of bubbles

Clay pebbles(X)

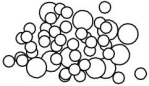

-It is recommended to clean the ceramic particles with water before use to remove dust and impurities.

OPTIONAL ACCESSORIES:

Air flow regulators(M,2pcs):

For adjusting and balancing of drip and bubbles from air stone on each bucket.

SETUP:Set regulators ON THE DRIP IRRIGATION PIPE of each bucket as the left drawing shows.

OPERATION:

Rotate the cap of regulator to adjust air outlet for drip irrigation. Turn down (-) to add air bubbles from the air stone and decrease drip flow of each bucket.

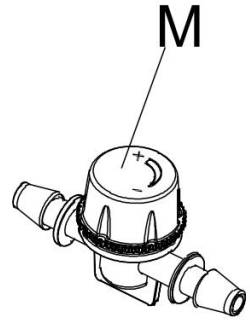

SPECIFICATIONS

Model	EHW0004C-DR		
Power	15W	15W	15W
Input Voltage	AC 110~120V 60Hz	AC 220V~240V 50Hz	AC 220V~240V 50Hz
Plug type	American plug	European plug	Australian plug

Address: Shuangchenglu 803nong11hao1602A-1609shi, baoshanqu, shanghai 200000 CN.

Imported to AUS: SIHAO PTY LTD. 1 ROKEVA STREETEASTWOOD NSW 2122 Australia

Imported to USA: Sanven Technology Ltd. Suite 250, 9166 Anaheim Place, Rancho Cucamonga, CA 91730



E-CrossStu GmbH

Mainzer Landstr.69, 60329 Frankfurt am Main.



YH CONSULTING LIMITED.

C/O YH Consulting Limited Office 147, Centurion House,
London Road, Staines-upon-Thames, Surrey, TW18 4AX

VEVOR[®]
TOUGH TOOLS, HALF PRICE

Technical Support and E-Warranty Certificate
www.vevor.com/support

VEVOR[®]

TOUGH TOOLS, HALF PRICE

Technische ondersteuning en e-garantiecertificaat www.vevor.com/support

DIEPWATERCULTUUREMMERSYSTEEM

HANDLEIDING

We continue to be committed to provide you tools with competitive price.

"Save Half", "Half Price" or any other similar expressions used by us only represents an estimate of savings you might benefit from buying certain tools with us compared to the major top brands and does not necessarily mean to cover all categories of tools offered by us. You are kindly reminded to verify carefully when you are placing an order with us if you are actually saving half in comparison with the top major brands.

VEVOR®

TOUGH TOOLS, HALF PRICE

DEEP WATER CULTURE BUCKET SYSTEM

MODEL: EHW0004C-DR

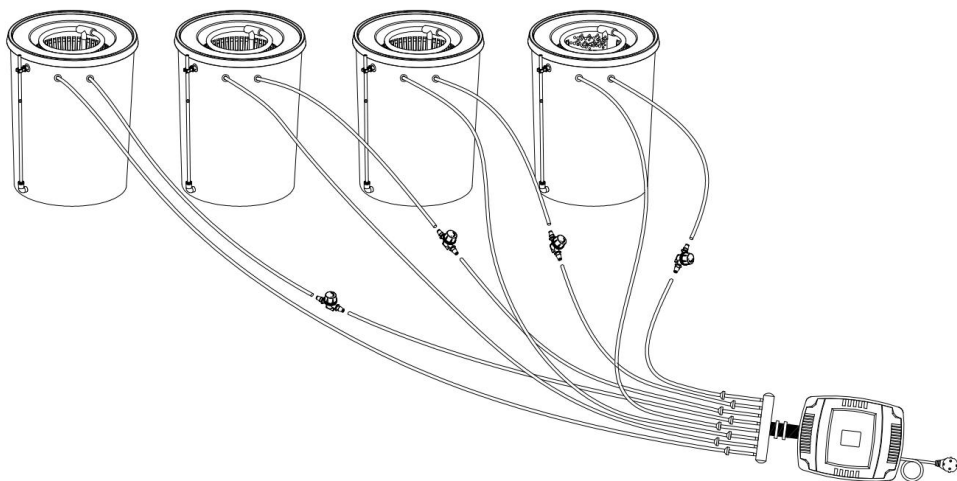

NEED HELP? CONTACT US!

Have product questions? Need technical support? Please feel free to contact us:

Technical Support and E-Warranty Certificate
www.vevor.com/support

This is the original instruction, please read all manual instructions carefully before operating. VEVOR reserves a clear interpretation of our user manual. The appearance of the product shall be subject to the product you received. Please forgive us that we won't inform you again if there are any technology or software updates on our product.



Hartelijk dank voor het kiezen van dit product . Lees alle instructies voordat u het gebruikt. De informatie zal u helpen de best mogelijke resultaten te bereiken.

	<p>Waarschuwing-Om het risico op letsel te verminderen, moet de gebruiker de handleiding zorgvuldig lezen.</p>
	<p>CORRECTE VERWIJDERING</p> <p>Dit product valt onder de bepalingen van de Europese richtlijn 2012/19/EG. Het symbool met een doorgestreepte afvalcontainer geeft aan dat het product in de Europese Unie een aparte afvalinzameling vereist. Dit geldt voor het product en alle accessoires die met dit symbool zijn gemarkeerd.</p> <p>Producten die als zodanig zijn gemarkeerd, mogen niet bij het normale huisvuil worden weggegooid, maar moeten worden ingeleverd bij een inzamelpunt voor recycling van elektrische en elektronische apparaten .</p>

SAFETY INSTRUCTION

WAARSCHUWING:

Lees alle veiligheidswaarschuwingen, instructies, illustraties en specificaties die bij deze luchtpomp worden geleverd. Het niet opvolgen van alle onderstaande instructies kan leiden tot elektrische schokken, brand en/of ernstig letsel.

Basisveiligheidsinformatie :

6. Dit product is alleen bedoeld voor planten.
7. Het is niet toegestaan om het product met een stroomkabel te trekken of te slepen.
8. Houd bij het uittrekken van de stekker de stekker zelf vast; trek niet aan

de voedingskabel.

9. Knip en vervang de stekker niet zelf, anders ernstig

Er kunnen gevolgen optreden.

10. Bediening van het product is niet toegestaan in geval van schade door stroom

lijn of de schaal.

8. Het demonteren en demonteren van het product door leken is niet toegestaan.

9. Als de luchtpomp in het water valt, sluit dan eerst de stroomtoevoer af het uitbaggeren. Vervolgens moet het ter controle aan professionals worden overgedragen En onderhoud.

8. Gevaar voor elektrische schokken: Raak de luchtpomp niet aan met natte handen of terwijl u op een nat oppervlak staat. Gebruik de luchtpomp altijd in een droge omgeving en steek de stekker in een goed geaard stopcontact.

9. Brandgevaar: Gebruik de luchtpomp niet in de buurt van ontvlambare of brandbare materialen. Houd de luchtpomp uit de buurt van hittebronnen of vonken, zoals vlammen, sigaretten of elektrische apparaten.

10. Explosiegevaar: Gebruik de luchtpomp niet met gassen die ontvlambaar, explosief of giftig zijn. Controleer altijd het veiligheidsinformatieblad (SDS) van het gas voordat u het met de luchtpomp gebruikt . Bovendien mag u het gespecificeerde drukbereik voor de luchtpomp niet overschrijden .

11. Corrosiegevaar: Gebruik de luchtpomp niet met gassen die metalen kunnen aantasten of chemische ladingen kunnen veroorzaken. Controleer de compatibiliteit van het gas met de materialen van de luchtpomp en de accessoires ervan. Gebruik altijd beschermende handschoenen en een veiligheidsbril bij het hanteren van corrosieve materialen.

12. Gebruik geen beschadigde stekker of stopcontact, aangezien dit een elektrische schok of brand kan veroorzaken.

13. Als het netsnoer beschadigd is, moet het worden vervangen door de fabrikant, zijn serviceagent of vergelijkbaar gekwalificeerde personen om

gevaar te voorkomen.

14. Dit apparaat kan worden gebruikt door kinderen van 8 jaar en ouder en door personen met verminderde lichamelijke, zintuiglijke of geestelijke vermogens of een gebrek aan ervaring en kennis, als zij onder toezicht staan of instructies hebben gekregen over het veilige gebruik van het apparaat en de de gevaren die daarmee gepaard gaan. Kinderen mogen niet met het apparaat spelen. Reiniging en gebruikersonderhoud mogen niet door kinderen zonder toezicht worden uitgevoerd.

15. Knip en vervang de stekker niet zelf, anders ernstig

Er kunnen gevolgen optreden.

19. Bediening van het product is niet toegestaan in geval van schade door stroom











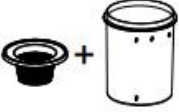

lijn of de schaal.

20. Het demonteren en demonteren van het product door leken is niet toegestaan.

21. Als de luchtpomp in het water valt, sluit dan eerst de stroomtoevoer af het uitbaggeren. Vervolgens moet het ter controle aan professionals worden overgedragen En onderhoud.

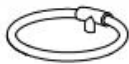
BEWAAR DEZE INSTRUCTIES

PARTS LIST

	Description	Picture	Quantity
A	Planting buckets		4
C	Red ball		4
D	Buckle		4
E	Seal ring		16
F	Water level tube340		4
G	In line check valve		8
H	Air stone		4
I	Black feeding Air hose(4x6)		12m
J	Air pump-8pin		1
K	Drip irrigation pipe-333-545		4
L	Water inlet tube-270		4
M	Air flow regulator		4
X	Clay pebbles-3		4bag

INSTALLATION

Vriendelijke tips-tools vereist voor installatie:

3. Schaar

4. Hete föhn (verwarmingsluchtslang voor eenvoudig inbrengen)

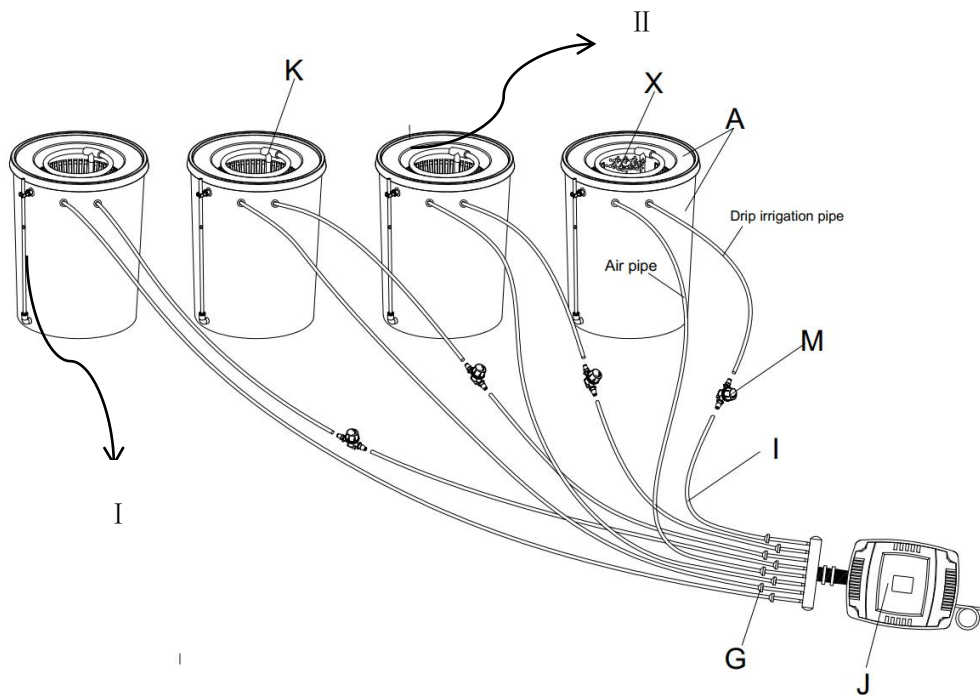

I II

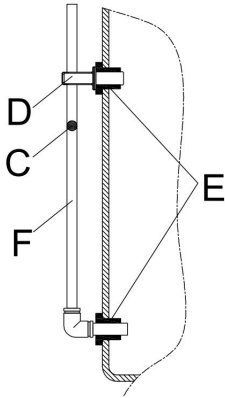

Connect F to the bucket as shown

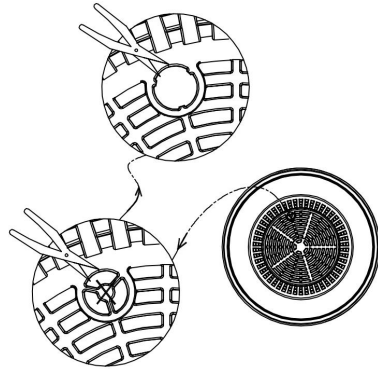

Cut off the plastic at the bottom of the basket of part A, as shown in the picture on the right, and then put it into the bucket

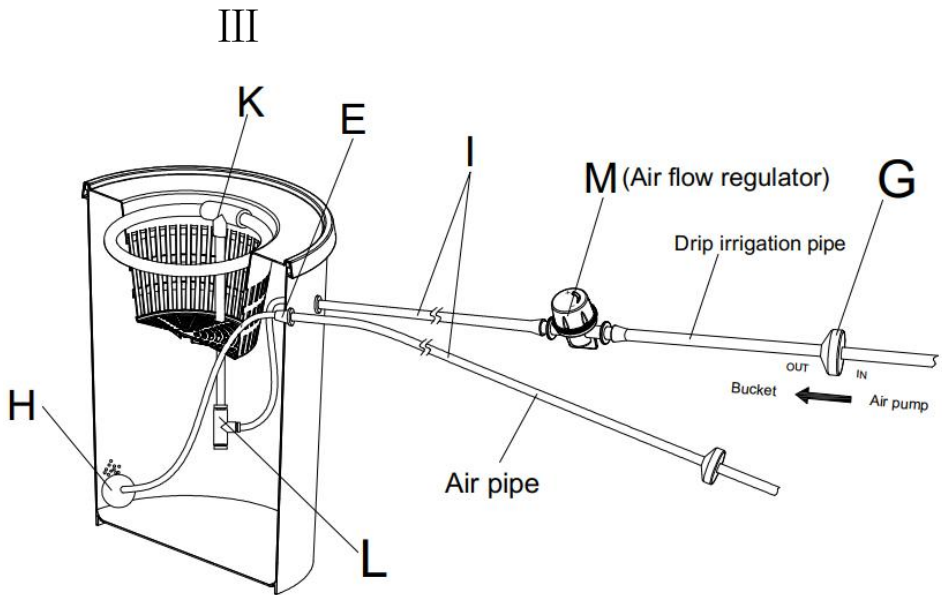

Gebruikstips:
Luchtsteen (H)



-Voordat u de gassteen aansluit en monteert Dompel hem gedurende 10 seconden volledig onder in water om te vullen de binnenkant van de gassteen met water, dat is bevorderlijk voor het ontstaan van bubbels

Kleikiezels (X)



- Het wordt aanbevolen om de behuizing schoon te maken keramische deeltjes met water vooraf gebruiken om stof en onzuiverheden te verwijderen.

OPTIONELE ACCESOIRES:

Luchtstroomregelaars (M,2 stuks) :

Voor het afstellen en balanceren van het druppelsysteem en belletjes uit luchtsteen op elke emmer.

OPSTELLING: Zet de regelaars op de druppelirrigatieleiding van elke emmer zoals de linkertekening laat zien.

OPERATIE:

Draai de dop van de regelaar om de luchtuitlaat aan te passen voor druppelirrigatie. Draai naar beneden (-) om luchtballen uit de luchtsteen toe te voegen en de druppelstroom van elk te verminderen emmer.

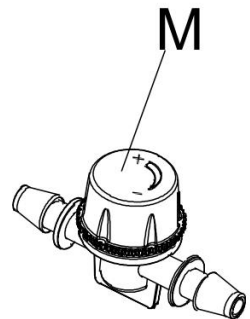

SPECIFICATIONS

Model	EHW0004C-DR		
Stroom	15W	15W	15W
Ingangsspanning	Wisselstroom 110~120V 60 Hz	Wisselstroom 220V~240V 50Hz	Wisselstroom 220V~240V 50Hz

Stekkertype	Amerikaanse stekker	Europese stekker	Australische stekker
-------------	---------------------	------------------	----------------------

Adres: Shuangchenglu 803nong11hao1602A-1609shi, baoshanqu, shanghai 200000 CN.

Geïmporteerd naar AUS: SIHAO PTY LTD. 1 ROKEVA STREETEASTWOOD NSW 2122 Australië

Geïmporteerd in de VS: Sanven Technology Ltd. Suite 250, 9166 Anaheim

Plaats, Rancho Cucamonga, CA 91730



E-CrossStu GmbH
Mainzer Landstr.69, 60329 Frankfurt am Main.



YH CONSULTING LIMITED.
C/O YH Consulting Limited Office 147, Centurion House,
London Road, Staines-upon-Thames, Surrey, TW18 4AX

VEVOR[®]

TOUGH TOOLS, HALF PRICE

Technisch Ondersteuning en e-garantiecertificaat

www.vevor.com/support

VEVOR[®]

TOUGH TOOLS, HALF PRICE

Teknisk support och e-garanticertifikat www.vevor.com/support

DEEP WATER CULTURE HINKSYSTEM

ANVÄNDARMANUAL

We continue to be committed to provide you tools with competitive price.

"Save Half", "Half Price" or any other similar expressions used by us only represents an estimate of savings you might benefit from buying certain tools with us compared to the major top brands and does not necessarily mean to cover all categories of tools offered by us. You are kindly reminded to verify carefully when you are placing an order with us if you are actually saving half in comparison with the top major brands.

VEVOR®

TOUGH TOOLS, HALF PRICE

DEEP WATER CULTURE BUCKET SYSTEM

MODELL: EHW0004C-DR

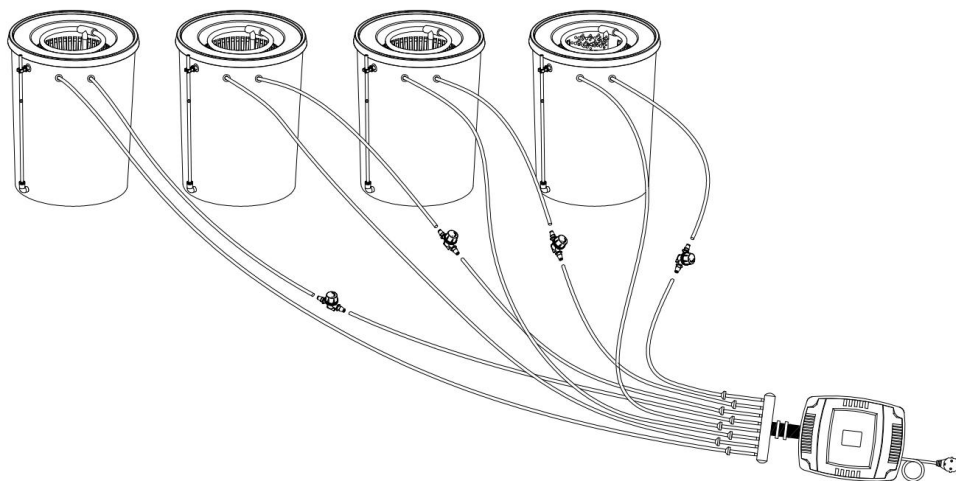

NEED HELP? CONTACT US!

Have product questions? Need technical support? Please feel free to contact us:

Technical Support and E-Warranty Certificate
www.vevor.com/support

This is the original instruction, please read all manual instructions carefully before operating. VEVOR reserves a clear interpretation of our user manual. The appearance of the product shall be subject to the product you received. Please forgive us that we won't inform you again if there are any technology or software updates on our product.



Tack så mycket för att du valde denna produkt . Läs alla instruktioner innan du använder den. Informationen hjälper dig att uppnå bästa möjliga resultat.

	<p>Varning - För att minska risken för skada måste användaren läsa instruktionerna noggrant.</p>
	<p>KORREKT AVFALLSHANTERING</p> <p>Denna produkt omfattas av bestämmelserna i det europeiska direktivet 2012/19/EC. Symbolen som visar en soptunna korsad anger att produkten kräver separat sophämtning i EU. Detta gäller för produkten och alla tillbehör märkta med denna symbol. Produkter märkta som sådana får inte kasseras tillsammans med vanligt hushållsavfall, utan måste lämnas till en samlingsplats för återvinning av elektriska och elektroniska apparater .</p>

SAFETY INSTRUCTION

WARNING:

Läs alla säkerhetsvarningar, instruktioner, illustrationer och specifikationer som medföljer denna luftpump. Underlåtenhet att följa alla instruktioner som anges nedan kan resultera i elektriska stötar, brand och/eller allvarliga skador.

Grundläggande säkerhetsinformation :

11. Denna produkt är endast avsedd för plantering.
12. Det är inte tillåtet att dra eller dra produkten med elledning.
13. När du drar ut kontakten, håll i själva kontakten; dra inte i kraftledningen.

14. Klipp och byt inte ut stickkontakten själv, annars allvarligt

Konsekvens kan få.

15. Användning av produkten är inte tillåten i händelse av skada med ström
lina eller skalet.

10. Demontering och demontering av produkten av lekmän är inte tillåtet.

11. Om luftpumpen faller i vatten, vänligen stäng av strömförsörjningen
innan muddrar ut den. Sedan ska det lämnas över till proffs för kontroll och
underhåll.

8. Risk för elektriska stötar: Rör inte luftpumpen med våta händer eller när
du står på en våt yta. Använd alltid luftpumpen i en torr miljö och anslut den
till ett ordentligt jordat uttag.

9. Brandrisk: Använd inte luftpumpen i närheten av brandfarliga eller
brännbara material. Håll luftpumpen borta från värmekällor eller gnistor,
såsom lågor, cigaretter eller elektriska apparater.

10. Explosionsrisk: Använd inte luftpumpen med gaser som är brandfarliga,
explosiva eller giftiga. Kontrollera alltid säkerhetsdatabladet (SDS) för
gasen innan du använder den med luftpumpen . Dessutom, överskrid inte
det specificerade tryckintervallet för luftpumpen .

11. Korrosionsrisk: Använd inte luftpumpen med gaser som kan korrodera
metaller eller utöva kemiska laddningar. Kontrollera gasens kompatibilitet
med materialen i luftpumpen och dess tillbehör. Använd alltid
skyddshandskar och glasögon vid hantering av frätande material.

12. Använd inte en skadad kontakt eller ett skadat uttag, eftersom det kan
orsaka elektriska stötar eller brand.

13. Om nätsladden är skadad måste den bytas ut av tillverkaren, dess
servicerepresentant eller liknande kvalificerade personer för att undvika
fara.

14. Denna apparat kan användas av barn från 8 år och uppåt och personer
med nedsatta fysiska, sensoriska eller mentala förmågor eller bristande
erfarenhet och kunskap om de har fått övervakning eller instruktioner
angående användning av apparaten på ett säkert sätt och förstår de
inblandade farorna. Barn får inte leka med apparaten. Rengöring och

användarunderhåll får inte utföras av barn utan tillsyn.

15. Klipp och byt inte ut stickkontakten själv, annars allvarligt

Konsekvens kan få.

22. Användning av produkten är inte tillåten i händelse av skada med ström











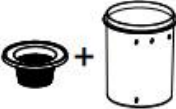

lina eller skalet.

23. Demontering och demontering av produkten av lekmän är inte tillåtet.

24. Om luftpumpen faller i vatten, vänligen stäng av strömförsörjningen innan muddrar ut den. Sedan ska det lämnas över till proffs för kontroll och underhåll.

SPARA DESSA INSTRUKTIONER

PARTS LIST

	Description	Picture	Quantity
A	Planting buckets		4
C	Red ball		4
D	Buckle		4
E	Seal ring		16
F	Water level tube340		4
G	In line check valve		8
H	Air stone		4
I	Black feeding Air hose(4x6)		12m
J	Air pump-8pin		1
K	Drip irrigation pipe-333-545		4
L	Water inlet tube-270		4
M	Air flow regulator		4
X	Clay pebbles-3		4bag

INSTALLATION

Vänliga tips-verktyg som krävs för installation:

5. Sax
6. Varm hårtork (värmeluftslang för enkel insättning)

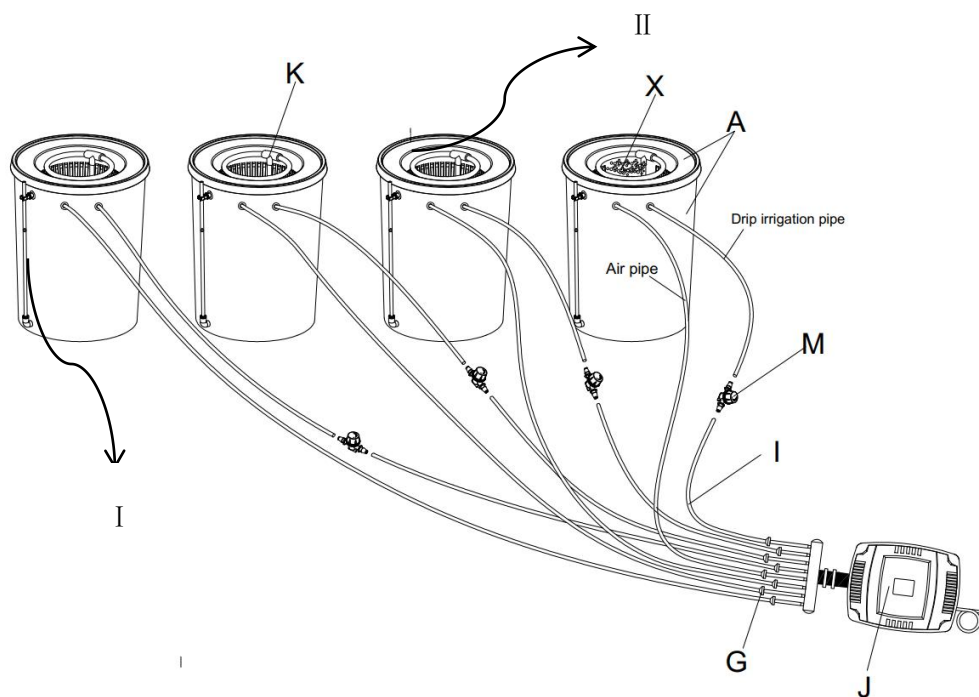

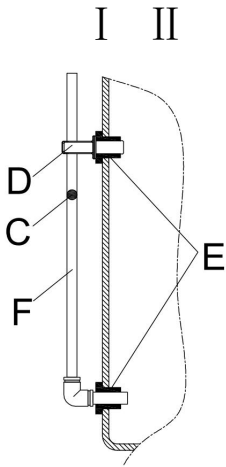

Connect F to the bucket as shown

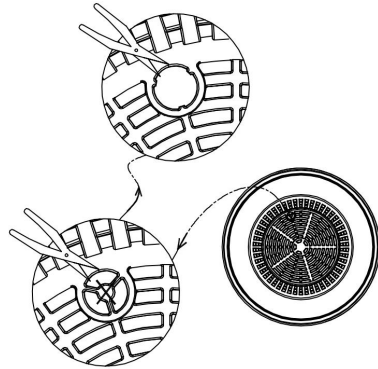

Cut off the plastic at the bottom of the basket of part A, as shown in the picture on the right, and then put it into the bucket

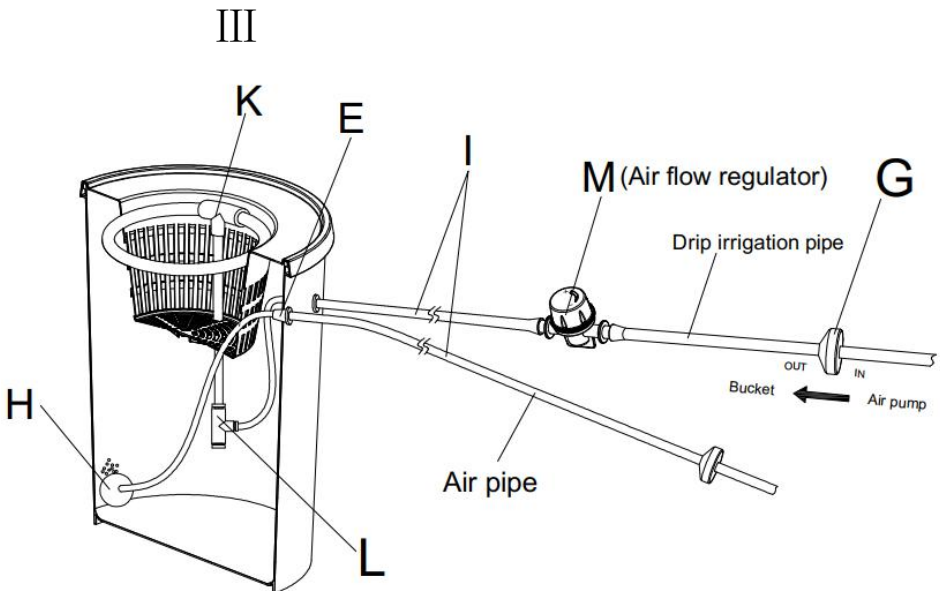

Använd tips:

Air Stone(H)



-Innan du ansluter och monterar gasstenen sänk den helt i vatten i 10 sekunder för att fylla den insidan av gasstenen med vatten, vilket är främjar genereringen av bubblor

Lersten (X)



- Jag t rekommenderas att rengöra keramiska partiklar med vatten innan används för att ta bort damm och föroreningar.

VALFRITT TILLBEHÖR:

Luftflödesregulatorer (M,2 st) :

F or justering och balansering av dropp och bubblor från luftsten på varje hink.

INSTÄLLNING: Ställ in regulatorer PÅ

DROPPBEVATTNINGSRÖREN av varje hink som den vänstra ritningen visar.

DRIFT:

Vrid locket på regulatorn för att justera luftutloppet för droppbevattning. Vrid ned (-) för att lägga till

luftbubblor från luftstenen och minska droppflödet för varje hink.

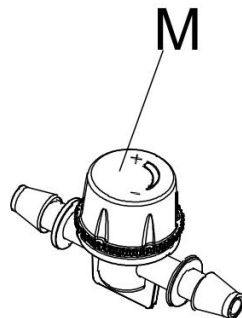

SPECIFICATIONS

Modell	EHW0004C-DR		
Kraft	15W	15W	15W
Inspänning	AC 110~120V 60 Hz	AC 220V~240V 50Hz	AC 220V~240V 50Hz
Plugg typ	Amerikansk plugg	Europeisk kontakt	Australisk kontakt

Adress: Shuangchenglu 803nong11hao1602A-1609shi, baoshanqu, shanghai 200000 CN.

Importerad till AUS: SIHAO PTY LTD. 1 ROKEVA STREETEASTWOOD NSW 2122 Australien

Importerad till USA: Sanven Technology Ltd. Suite 250, 9166 Anaheim Place, Rancho Cucamonga, CA 91730

EC	REP
-----------	------------

E-CrossStu GmbH
Mainzer Landstr.69, 60329 Frankfurt am Main.

UK	REP
-----------	------------

YH CONSULTING LIMITED.
C/O YH Consulting Limited Office 147, Centurion House,
London Road, Staines-upon-Thames, Surrey, TW18 4AX

VEVOR[®]

TOUGH TOOLS, HALF PRICE

Teknisk Support och e-garanticertifikat

www.vevor.com/support

VEVOR[®]

TOUGH TOOLS, HALF PRICE

Soporte técnico y certificado de garantía electrónica www.vevor.com/support

SISTEMA DE CUBO DE CULTIVO EN AGUAS PROFUNDAS MANUAL DE USUARIO

We continue to be committed to provide you tools with competitive price.

"Save Half", "Half Price" or any other similar expressions used by us only represents an estimate of savings you might benefit from buying certain tools with us compared to the major top brands and does not necessarily mean to cover all categories of tools offered by us. You are kindly reminded to verify carefully when you are placing an order with us if you are actually saving half in comparison with the top major brands.

VEVOR®

TOUGH TOOLS, HALF PRICE

DEEP WATER CULTURE BUCKET SYSTEM

MODELO: EHW0004C-DR

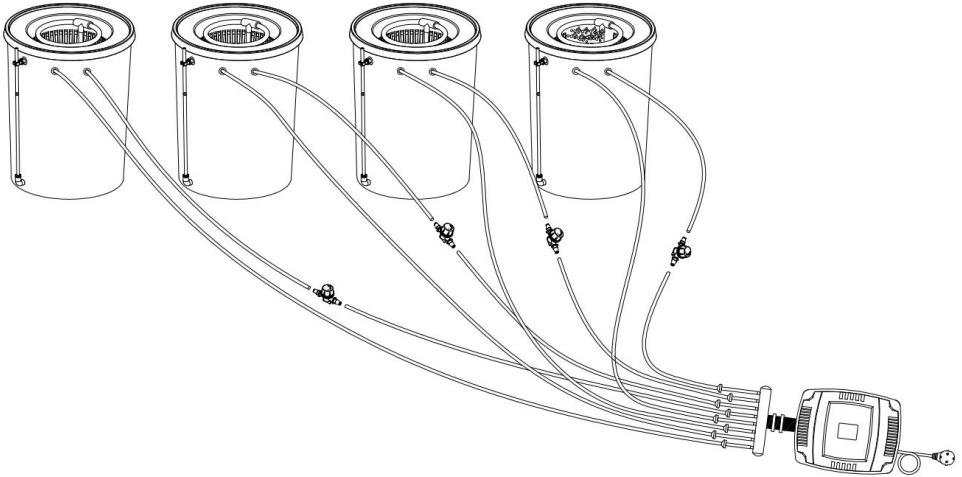

NEED HELP? CONTACT US!

Have product questions? Need technical support? Please feel free to contact us:

Technical Support and E-Warranty Certificate
www.vevor.com/support

This is the original instruction, please read all manual instructions carefully before operating. VEVOR reserves a clear interpretation of our user manual. The appearance of the product shall be subject to the product you received. Please forgive us that we won't inform you again if there are any technology or software updates on our product.



Muchas gracias por elegir este producto . Lea todas las instrucciones antes de usarlo. La información le ayudará a lograr los mejores resultados posibles.

	Advertencia: para reducir el riesgo de lesiones, el usuario debe leer atentamente el manual de instrucciones.
	ELIMINACIÓN CORRECTA Este producto está sujeto a las disposiciones de la Directiva Europea 2012/19/CE. El símbolo que muestra un contenedor con ruedas tachado indica que el producto requiere recogida selectiva de basura en la Unión Europea. Esto se aplica al producto y a todos los accesorios marcados con este símbolo. Los productos marcados como tales no podrán desecharse con la basura doméstica normal, sino que deberán llevarse a un punto de recogida para el reciclaje de aparatos eléctricos y electrónicos .

SAFETY INSTRUCTION

ADVERTENCIA:

Lea todas las advertencias de seguridad, instrucciones, ilustraciones y especificaciones proporcionadas con esta bomba de aire. No seguir todas las instrucciones enumeradas a continuación puede provocar una descarga eléctrica, un incendio y/o lesiones graves.

Información básica de seguridad :

16. Este producto es sólo para plantar.
17. No se permite tirar o arrastrar el producto con la línea eléctrica.
18. Al desconectar el enchufe, sostenga el enchufe; no tire del cable eléctrico.

19.No corte ni reemplace el enchufe usted mismo, de lo contrario, Puede haber consecuencias.

20.No se permite el funcionamiento del producto en caso de daño con energía.

línea o el caparazón.

12.No está permitido el desmontaje y desmontaje del producto por parte de personas no profesionales.

13.En caso de que la bomba de aire caiga al agua, corte el suministro de energía antes dragándolo. Luego debe entregarse a profesionales para que lo revisen. y mantenimiento.

8. Peligro de descarga eléctrica: No toque la bomba de aire con las manos mojadas o mientras esté parado sobre una superficie mojada. Utilice siempre la bomba de aire en un ambiente seco y conéctela a un tomacorriente con conexión a tierra adecuada.

9. Peligro de incendio: No utilice la bomba de aire cerca de materiales inflamables o combustibles. Mantenga la bomba de aire alejada de fuentes de calor o chispas, como llamas, cigarrillos o aparatos eléctricos.

10. Peligro de explosión: No utilice la bomba de aire con gases que sean inflamables, explosivos o venenosos. Consulte siempre la ficha de datos de seguridad (SDS) del gas antes de utilizarlo con la bomba de aire . Además, no exceda el rango de presión especificado para la bomba de aire .

11. Peligro de corrosión: No utilice la bomba de aire con gases que puedan corroer metales o ejercer cargas químicas. Verificar la compatibilidad del gas con los materiales de la bomba de aire y sus accesorios. Utilice siempre guantes y gafas protectoras cuando manipule materiales corrosivos.

12. No utilice un enchufe o toma de corriente dañado, ya que esto puede provocar una descarga eléctrica o un incendio.

13. Si el cable de alimentación está dañado, debe ser reemplazado por el fabricante, su agente de servicio o personas igualmente calificadas para evitar riesgos.

14. Este aparato puede ser utilizado por niños a partir de 8 años y personas con capacidades físicas, sensoriales o mentales reducidas o con falta de experiencia y conocimiento si han recibido supervisión o instrucciones sobre el uso del aparato de forma segura y comprenden los peligros involucrados. Los niños no deben jugar con el aparato. La limpieza y el mantenimiento del usuario no deben ser realizados por niños sin supervisión.

15. No corte ni reemplace el enchufe usted mismo, de lo contrario, Puede haber consecuencias.

25. No se permite el funcionamiento del producto en caso de daño con energía.











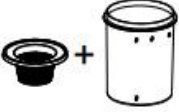

línea o el caparazón.

26. No está permitido el desmontaje y desmontaje del producto por parte de personas no profesionales.

27. En caso de que la bomba de aire caiga al agua, corte el suministro de energía antes dragándolo. Luego debe entregarse a profesionales para que lo revisen. y mantenimiento.

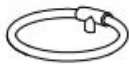
GUARDA ESTAS INSTRUCCIONES

PARTS LIST

	Description	Picture	Quantity
A	Planting buckets		4
C	Red ball		4
D	Buckle		4
E	Seal ring		16
F	Water level tube340		4
G	In line check valve		8
H	Air stone		4
I	Black feeding Air hose(4x6)		12m
J	Air pump-8pin		1
K	Drip irrigation pipe-333-545		4
L	Water inlet tube-270		4
M	Air flow regulator		4
X	Clay pebbles-3		4bag

INSTALLATION

Consejos-herramientas amigables necesarias para la instalación:

7. Tijeras

8. Secador de pelo caliente (manguera de aire caliente para una fácil inserción)

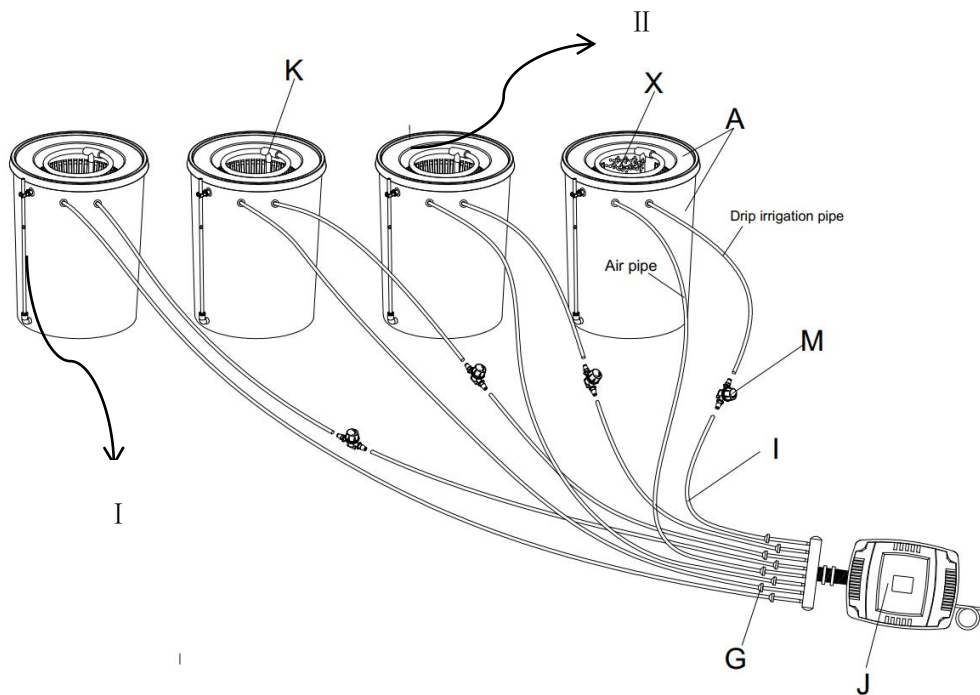

I II

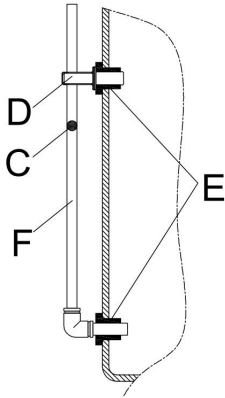

Connect F to the bucket as shown

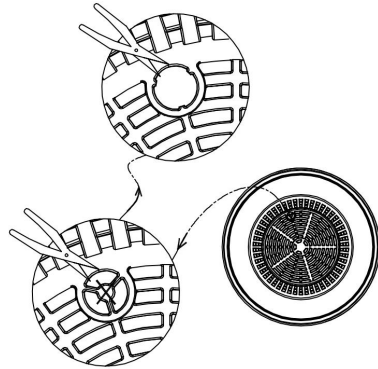

Cut off the plastic at the bottom of the basket of part A, as shown in the picture on the right, and then put it into the bucket

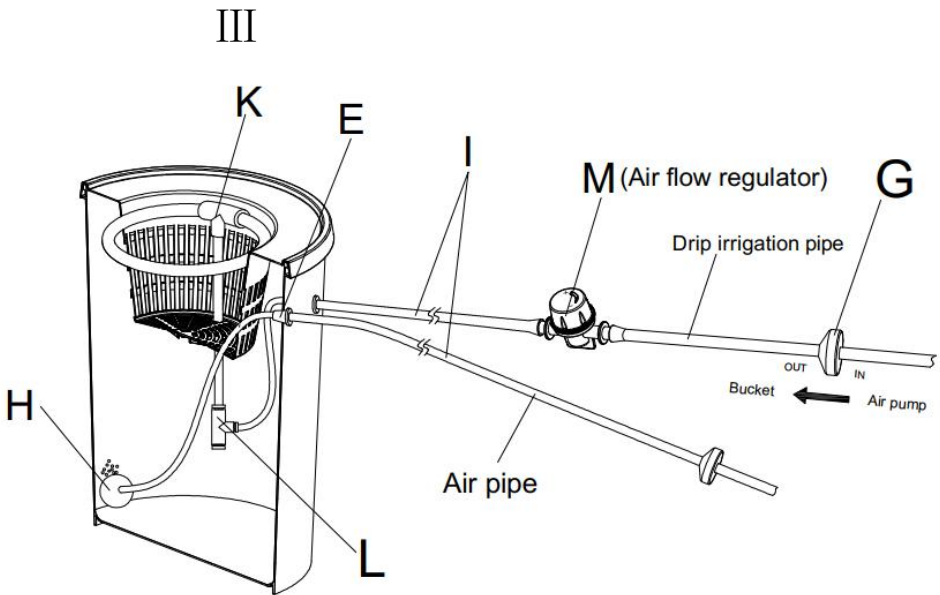

Consejos de uso:
Piedra de aire (H)



burbujas

-Antes de conectar y montar la piedra de gas. sumérgelo completamente en agua durante 10 segundos para llenarlo el interior de la piedra de gas con agua, que se propicio para la generación de

Guijarros de arcilla (X)

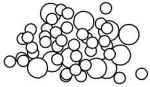

- Se recomienda limpiar el partículas cerámicas con agua antes Úselo para eliminar el polvo y las impurezas.

ACCESORIOS OPCIONALES:

Reguladores de flujo de aire (M,2 piezas) :

Para ajustar y equilibrar el goteo y burbujas de piedra difusora en cada cubo.

CONFIGURACIÓN: Configure los reguladores EN LA TUBERÍA DE RIEGO POR GOTEO de cada cubo como muestra el dibujo de la izquierda.

OPERACIÓN:

Gire la tapa del regulador para ajustar la salida de aire para riego por goteo. Gire hacia abajo (-) para agregar burbujas de aire de la piedra difusora y disminuir el flujo de goteo de cada una. balde.

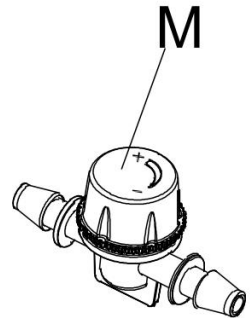

SPECIFICATIONS

Modelo	EHW0004C-DR		
Fuerza	15W	15W	15W
Voltaje de entrada	CA 110~120V 60Hz	CA 220 V ~ 240 V 50 Hz	CA 220 V ~ 240 V 50 Hz
Tipo de enchufe	enchufe americano	enchufe europeo	enchufe australiano

Dirección: Shuangchenglu 803nong11hao1602A-1609shi, baoshanqu, shanghai 200000 CN.

Importado a AUS: SIHAO PTY LTD. 1 ROKEVA STREET ASTWOOD NSW 2122 Australia

Importado a EE. UU.: Sanven Technology Ltd. Suite 250, 9166 Anaheim Lugar, Rancho Cucamonga, CA 91730

EC	REP
-----------	------------

E-CrossStu GmbH
Mainzer Landstr.69, 60329 Frankfurt am Main.

UK	REP
-----------	------------

YH CONSULTING LIMITED.
C/O YH Consulting Limited Office 147, Centurion House,
London Road, Staines-upon-Thames, Surrey, TW18 4AX

VEVOR[®]
TOUGH TOOLS, HALF PRICE

Técnico Certificado de soporte y garantía electrónica
www.vevor.com/support

VEVOR[®]

TOUGH TOOLS, HALF PRICE

Supporto tecnico e certificato di garanzia elettronica www.vevor.com/support

SISTEMA DI BENNE PER COLTURE IN ACQUE PROFONDE MANUALE D'USO

We continue to be committed to provide you tools with competitive price.

"Save Half", "Half Price" or any other similar expressions used by us only represents an estimate of savings you might benefit from buying certain tools with us compared to the major top brands and does not necessarily mean to cover all categories of tools offered by us. You are kindly reminded to verify carefully when you are placing an order with us if you are actually saving half in comparison with the top major brands.

VEVOR®

TOUGH TOOLS, HALF PRICE

DEEP WATER CULTURE BUCKET SYSTEM

MODELLO: EHW0004C-DR

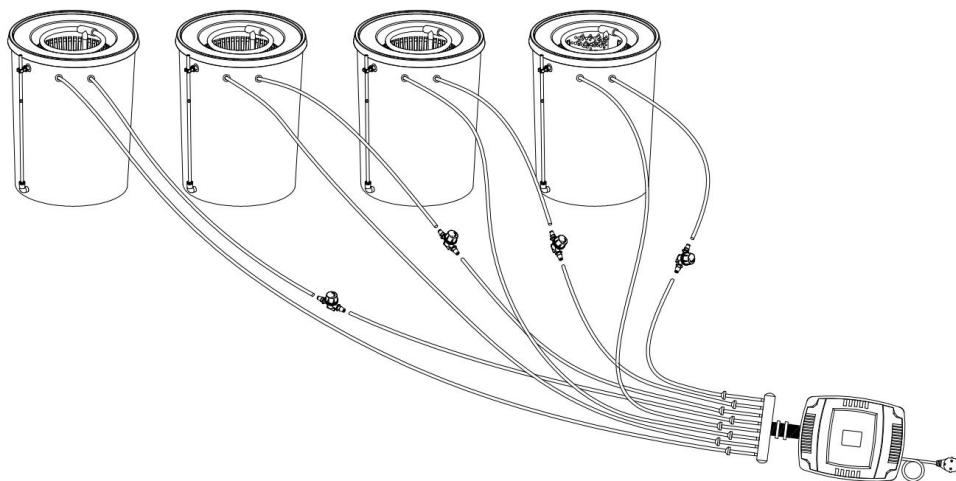

NEED HELP? CONTACT US!

Have product questions? Need technical support? Please feel free to contact us:

Technical Support and E-Warranty Certificate
www.vevor.com/support

This is the original instruction, please read all manual instructions carefully before operating. VEVOR reserves a clear interpretation of our user manual. The appearance of the product shall be subject to the product you received. Please forgive us that we won't inform you again if there are any technology or software updates on our product.



Grazie mille per aver scelto questo prodotto . Si prega di leggere tutte le istruzioni prima di utilizzarlo. Le informazioni ti aiuteranno a ottenere i migliori risultati possibili.

	Avvertenza: per ridurre il rischio di lesioni, l'utente deve leggere attentamente il manuale di istruzioni.
	CORRETTO SMALTIMENTO Questo prodotto è soggetto alle disposizioni della Direttiva Europea 2012/19/CE. Il simbolo del bidone della spazzatura barrato indica che nell'Unione Europea il prodotto richiede la raccolta differenziata dei rifiuti. Ciò vale per il prodotto e tutti gli accessori contrassegnati da questo simbolo. I prodotti contrassegnati come tali non possono essere smaltiti con i normali rifiuti domestici, ma devono essere portati in un punto di raccolta per il riciclaggio di dispositivi elettrici ed elettronici .

SAFETY INSTRUCTION

AVVERTIMENTO:

Leggere tutti gli avvisi di sicurezza, le istruzioni, le illustrazioni e le specifiche fornite con questa pompa ad aria. La mancata osservanza di tutte le istruzioni elencate di seguito può provocare scosse elettriche, incendi e/o lesioni gravi.

Informazioni di base sulla sicurezza :

21. Questo prodotto è solo per la semina.
22. Non è consentito tirare o trascinare il prodotto con la linea elettrica.
23. Quando si stacca la spina, tenere la spina stessa; non tirare la linea elettrica.

24. Non tagliare e sostituire da soli la spina di alimentazione, altrimenti è grave

Potrebbero esserci delle conseguenze.

25. Il funzionamento del prodotto non è consentito in caso di danni all'alimentazione

linea o la shell.

14. Non è consentito lo smontaggio e lo smontaggio del prodotto da parte di persone non autorizzate.

15. Nel caso in cui la pompa dell'aria cada nell'acqua, interrompere prima l'alimentazione dragandolo. Quindi dovrebbe essere consegnato ai professionisti per il controllo E manutenzione.

8. Pericolo di scossa elettrica: non toccare la pompa dell'aria con le mani bagnate o stando in piedi su una superficie bagnata. Utilizzare sempre la pompa dell'aria in un ambiente asciutto e collegarla a una presa adeguatamente messa a terra.

9. Pericolo di incendio: non utilizzare la pompa dell'aria vicino a materiali infiammabili o combustibili. Tenere la pompa dell'aria lontana da fonti di calore o scintille, come fiamme, sigarette o apparecchi elettrici.

10. Pericolo di esplosione: non utilizzare la pompa dell'aria con gas infiammabili, esplosivi o velenosi. Controllare sempre la scheda dati di sicurezza (SDS) del gas prima di utilizzarlo con la pompa ad aria. Inoltre, non superare l'intervallo di pressione specificato per la pompa dell'aria.

11. Pericolo di corrosione: non utilizzare la pompa dell'aria con gas che possono corrodere i metalli o esercitare cariche chimiche. Verificare la compatibilità del gas con i materiali della pompa dell'aria e dei suoi accessori. Utilizzare sempre guanti e occhiali protettivi quando si maneggiano materiali corrosivi.

12. Non utilizzare una spina o una presa danneggiata, poiché ciò potrebbe causare scosse elettriche o incendi.

13. Se il cavo di alimentazione è danneggiato, deve essere sostituito dal produttore, dal suo agente di assistenza o da persone similmente qualificate per evitare pericoli.

14. Questo apparecchio può essere utilizzato da bambini di età pari o superiore a 8 anni e da persone con ridotte capacità fisiche, sensoriali o mentali o con mancanza di esperienza e conoscenza se hanno ricevuto supervisione o istruzioni relative all'uso dell'apparecchio in modo sicuro e hanno compreso i rischi connessi. I bambini non devono giocare con l'apparecchio. La pulizia e la manutenzione da parte dell'utente non devono essere effettuate da bambini senza supervisione.

15. Non tagliare e sostituire da soli la spina di alimentazione, altrimenti gravi conseguenze

Potrebbero esserci delle conseguenze.

28. Il funzionamento del prodotto non è consentito in caso di danni all'alimentazione











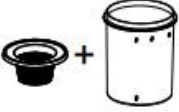

linea o la shell.

29. Non è consentito lo smontaggio e lo smontaggio del prodotto da parte di persone non autorizzate.

30. Nel caso in cui la pompa dell'aria cada nell'acqua, interrompere prima l'alimentazione dragandolo. Quindi dovrebbe essere consegnato ai professionisti per il controllo E manutenzione.

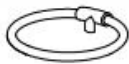
CONSERVA QUESTE ISTRUZIONI

PARTS LIST

	Description	Picture	Quantity
A	Planting buckets		4
C	Red ball		4
D	Buckle		4
E	Seal ring		16
F	Water level tube340		4
G	In line check valve		8
H	Air stone		4
I	Black feeding Air hose(4x6)		12m
J	Air pump-8pin		1
K	Drip irrigation pipe-333-545		4
L	Water inlet tube-270		4
M	Air flow regulator		4
X	Clay pebbles-3		4bag

INSTALLATION

Suggerimenti-strumenti amichevoli richiesti per l'installazione:

9. Forbici

10. Asciugacapelli caldo (tubo dell'aria riscaldante per un facile inserimento)

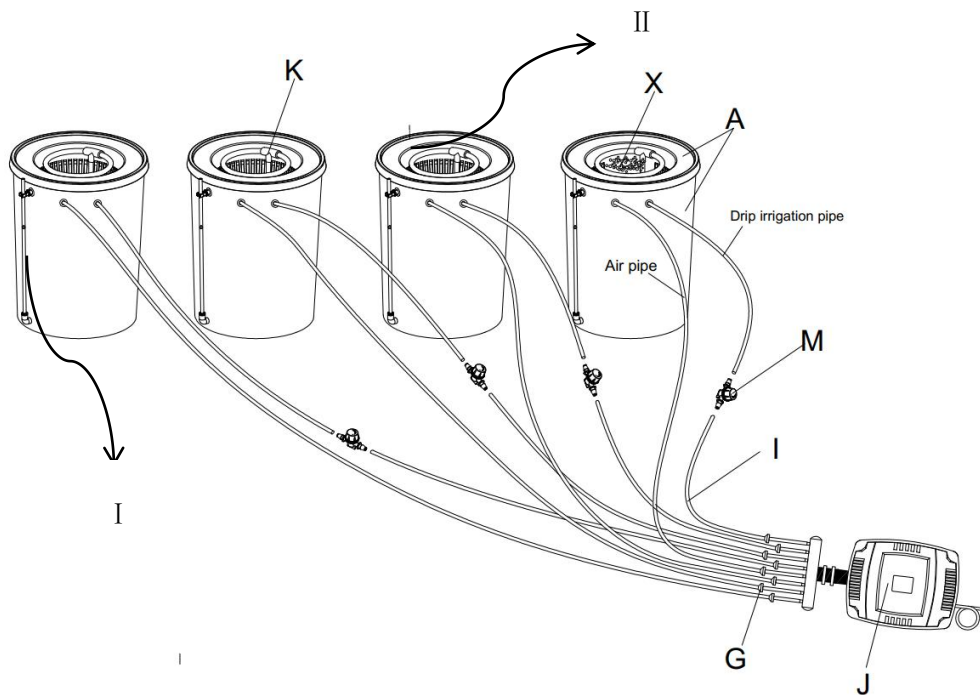

I II

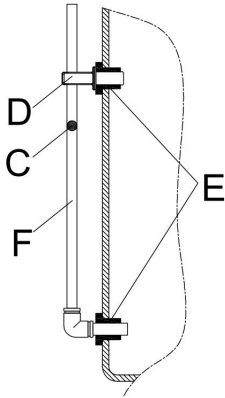

Connect F to the bucket as shown

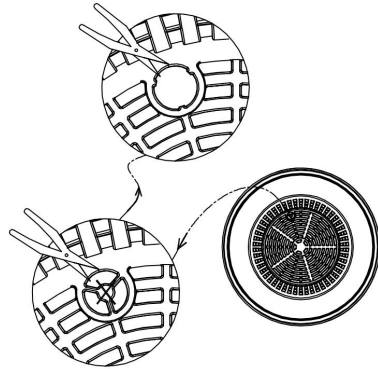

Cut off the plastic at the bottom of the basket of part A, as shown in the picture on the right, and then put it into the bucket

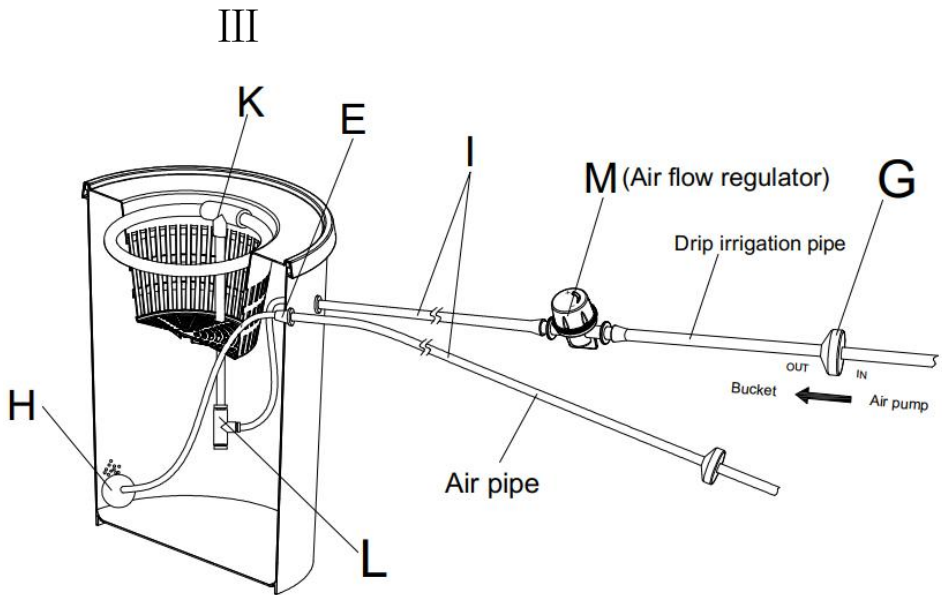

Suggerimenti per l'uso:
Pietra porosa(H)



-Prima di collegare e montare la pietra a gas immergerlo completamente in acqua per 10 secondi per riempirlo l'interno della pietra gassosa con acqua, che è favorevole alla generazione di bolle

Ciottoli di argilla (X)



- Si consiglia di pulire il particelle di ceramica con acqua prima utilizzare per rimuovere polvere e impurità.

ACCESSORI OPZIONALI:

Regolatori del flusso d'aria (M, 2 pezzi) :

Per la regolazione ed il bilanciamento del gocciolamento e bolle dalla pietra porosa su ogni secchio.

CONFIGURAZIONE: Impostare i regolatori SUL TUBO DI IRRIGAZIONE A GOCCIA di ciascun secchio come mostra il disegno a sinistra.

OPERAZIONE:

Ruotare il cappuccio del regolatore per regolare l'uscita dell'aria per l'irrigazione a goccia. Abbassare (-) per aggiungere bolle d'aria dalla pietra porosa e diminuire il flusso di gocciolamento di ciascuna secchio.

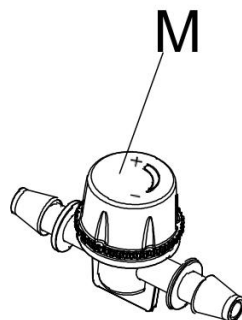

SPECIFICATIONS

Modello	EHW0004C-DR		
Energia	15 W	15 W	15 W
Tensione di ingresso	CA 110~120 V 60Hz	CA 220 V~240 V 50 Hz	CA 220 V~240 V 50 Hz
Tipo di spina	Spina americana	Spina europea	Spina australiana

Indirizzo: Shuangchenglu 803nong11hao1602A-1609shi, baoshanqu, shanghai 200000 CN.

Importato in AUS: SIHAO PTY LTD. 1 ROKEVA STREETEASTWOOD NSW 2122 Australia

Importato negli Stati Uniti: Sanven Technology Ltd. Suite 250, 9166 Anaheim

Luogo, Rancho Cucamonga, CA 91730

EC	REP
-----------	------------

E-CrossStu GmbH

Mainzer Landstr.69, 60329 Frankfurt am Main.

UK	REP
-----------	------------

YH CONSULTING LIMITED.

C/O YH Consulting Limited Office 147, Centurion House,
London Road, Staines-upon-Thames, Surrey, TW18 4AX

VEVOR[®]

TOUGH TOOLS, HALF PRICE

Tecnico Supporto e certificato di garanzia elettronica

www.vevor.com/support

VEVOR®

TOUGH TOOLS, HALF PRICE

Wsparcie techniczne i certyfikat e-gwarancji www.vevor.com/support

SYSTEM WIADER DO HODOWLI GŁĘBOKOWODNYCH INSTRUKCJA OBSŁUGI

We continue to be committed to provide you tools with competitive price.

"Save Half", "Half Price" or any other similar expressions used by us only represents an estimate of savings you might benefit from buying certain tools with us compared to the major top brands and does not necessarily mean to cover all categories of tools offered by us. You are kindly reminded to verify carefully when you are placing an order with us if you are actually saving half in comparison with the top major brands.

VEVOR®

TOUGH TOOLS, HALF PRICE

DEEP WATER CULTURE BUCKET SYSTEM

MODEL: EHW0004C-DR

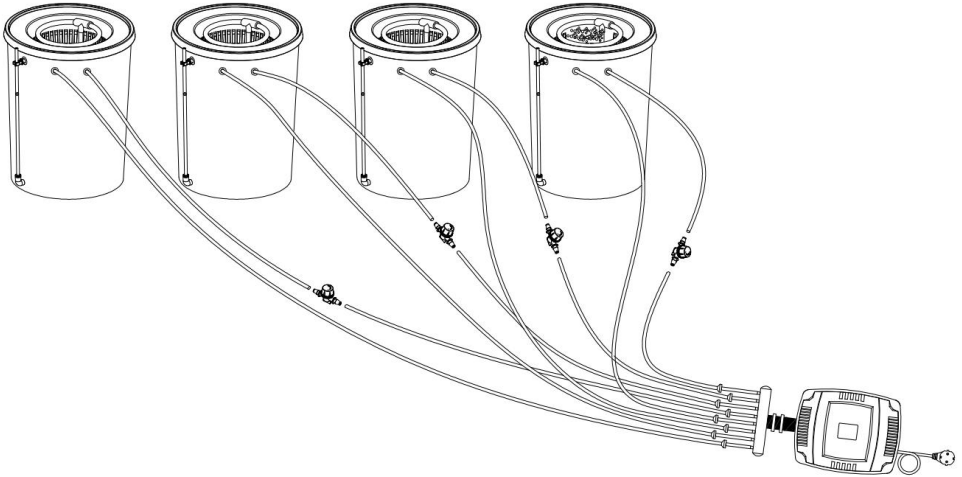

NEED HELP? CONTACT US!

Have product questions? Need technical support? Please feel free to contact us:

Technical Support and E-Warranty Certificate
www.vevor.com/support

This is the original instruction, please read all manual instructions carefully before operating. VEVOR reserves a clear interpretation of our user manual. The appearance of the product shall be subject to the product you received. Please forgive us that we won't inform you again if there are any technology or software updates on our product.



Dziękuję bardzo za wybór tego produktu . Przed użyciem przeczytaj całą instrukcję. Informacje te pomogą Ci osiągnąć najlepsze możliwe rezultaty.

	<p>Ostrzeżenie — aby zmniejszyć ryzyko obrażeń, użytkownik musi uważnie przeczytać instrukcję obsługi.</p>
	<p>PRAWIDŁOWA UTYLIZACJA Ten produkt podlega przepisom Dyrektywy Europejskiej 2012/19/EC. Symbol przekreślonego kosza na śmieci oznacza, że produkt wymaga selektywnej zbiórki śmieci na terenie Unii Europejskiej. Dotyczy to produktu i wszystkich akcesoriów oznaczonych tym symbolem. Produktów oznaczonych jako takie nie można wyrzucać razem ze zwykłymi odpadami domowymi, lecz należy je oddać do punktu zbiórki w celu recyklingu urządzeń elektrycznych i elektronicznych .</p>

SAFETY INSTRUCTION

OSTRZEŻENIE:

Przeczytaj wszystkie ostrzeżenia dotyczące bezpieczeństwa, instrukcje, ilustracje i specyfikacje dołączone do tej pompy powietrza. Niezastosowanie się do wszystkich instrukcji wymienionych poniżej może spowodować porażenie prądem, pożar i/lub poważne obrażenia.

Podstawowe informacje dotyczące bezpieczeństwa :

26. Ten produkt służy wyłącznie do sadzenia.

27. Ciągnięcie lub ciągnięcie produktu za przewód zasilający jest niedozwolone.

28. Wyciągając wtyczkę, należy trzymać wtyczkę; nie ciągnij za przewód

zasilający.

29. Nie przecinaj ani nie wymieniaj wtyczki samodzielnie, gdyż jest to poważne

Konsekwencje mogą wystąpić.

30. Eksploatacja produktu jest niedozwolona w przypadku uszkodzenia zasilania

linia lub skorupa.

16. Niedopuszczalny jest demontaż i demontaż produktu przez osoby laickie.

17. W przypadku wpadnięcia pompy powietrza do wody należy wcześniej odłączyć zasilanie pogłębianie go. Następnie należy przekazać go profesjonalistom w celu sprawdzenia i konserwacja.

8. Niebezpieczeństwo porażenia prądem: Nie dotykaj pompy powietrza mokrymi rękami lub stojąc na mokrej powierzchni. Zawsze używaj pompy powietrza w suchym środowisku i podłączaj ją do prawidłowo uziemionego gniazdka.

9. Zagrożenie pożarowe: Nie używaj pompy powietrza w pobliżu materiałów łatwopalnych lub palnych. Trzymaj pompę powietrza z dala od źródeł ciepła lub iskier, takich jak płomień, papierosy lub urządzenia elektryczne.

10. Niebezpieczeństwo wybuchu: Nie używaj pompy powietrza z gazami łatwopalnymi, wybuchowymi lub trującymi. Zawsze sprawdź kartę charakterystyki (SDS) gazu przed użyciem go z pompą powietrza . Ponadto nie należy przekraczać określonego zakresu ciśnienia dla pompy powietrza .

11. Niebezpieczeństwo korozji: Nie używaj pompy powietrza z gazami, które mogą powodować korozję metali lub wywierać ładunki chemiczne. Sprawdź kompatybilność gazu z materiałami pompy powietrza i jej akcesoriów. Podczas pracy z materiałami żrącymi należy zawsze nosić rękawice i okulary ochronne.

12. Nie używaj uszkodzonej wtyczki lub gniazdka, gdyż może to spowodować porażenie prądem lub pożar.

13. Jeżeli przewód zasilający jest uszkodzony, musi on zostać wymieniony przez producenta, jego przedstawiciela serwisowego lub osobę o podobnych kwalifikacjach, aby uniknąć zagrożenia.

14. Z tego urządzenia mogą korzystać dzieci w wieku od 8 lat i starsze oraz osoby o ograniczonych zdolnościach fizycznych, sensorycznych lub umysłowych lub nieposiadające doświadczenia i wiedzy, jeśli znajdują się pod nadzorem lub zostały pouczone dotyczące bezpiecznego użytkowania urządzenia i rozumieją związane z tym zagrożenia. Dzieciom nie wolno bawić się urządzeniem. Czyszczenie i konserwacja nie mogą być wykonywane przez dzieci bez nadzoru.

15. Nie przecinaj i nie wymieniaj wtyczki samodzielnie, gdyż jest to poważne

Konsekwencje mogą wystąpić.

31. Eksploatacja produktu jest niedozwolona w przypadku uszkodzenia zasilania











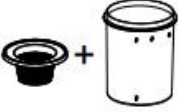

linia lub skorupa.

32. Niedopuszczalny jest demontaż i demontaż produktu przez osoby laickie.

33. W przypadku wpadnięcia pompy powietrza do wody należy wcześniej odłączyć zasilanie pogłębienie go. Następnie należy przekazać go profesjonalistom w celu sprawdzenia i konserwacja.

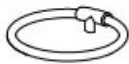
ZACHOWAJ TE INSTRUKCJE

PARTS LIST

	Description	Picture	Quantity
A	Planting buckets		4
C	Red ball		4
D	Buckle		4
E	Seal ring		16
F	Water level tube340		4
G	In line check valve		8
H	Air stone		4
I	Black feeding Air hose(4x6)		12m
J	Air pump-8pin		1
K	Drip irrigation pipe-333-545		4
L	Water inlet tube-270		4
M	Air flow regulator		4
X	Clay pebbles-3		4bag

INSTALLATION

Przyjazne wskazówki-narzędzia wymagane do instalacji:

11. Nożyce

12. Gorąca suszarka do włosów (wąż powietrza grzewczego ułatwiający wkładanie)

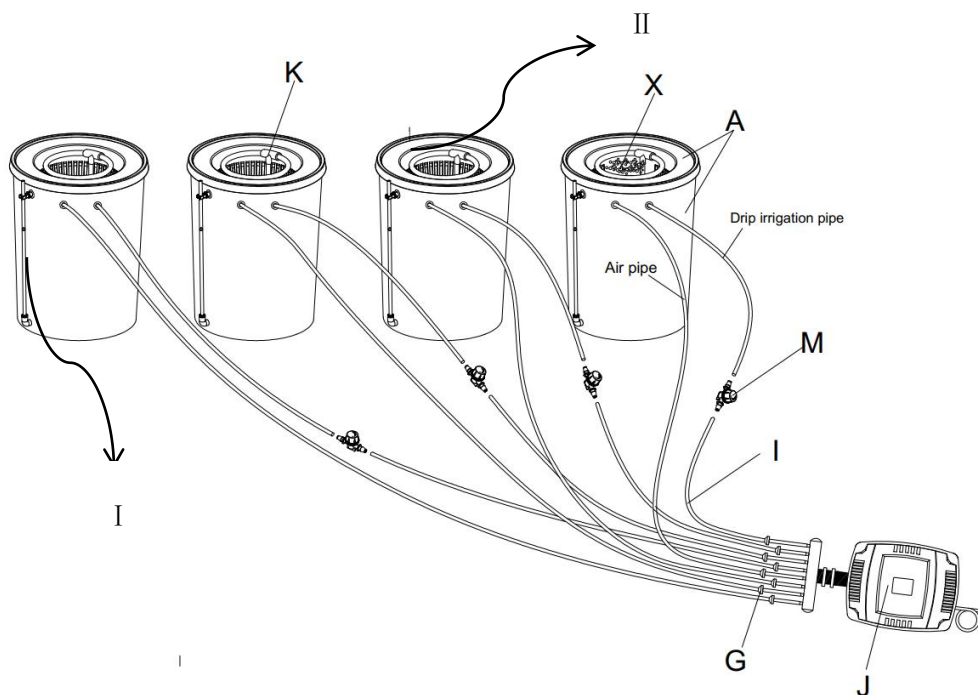

I II

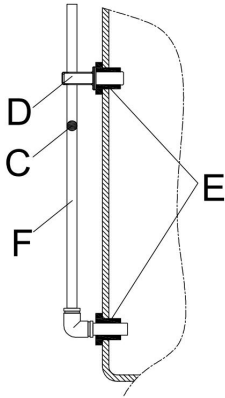

Connect F to the bucket as shown

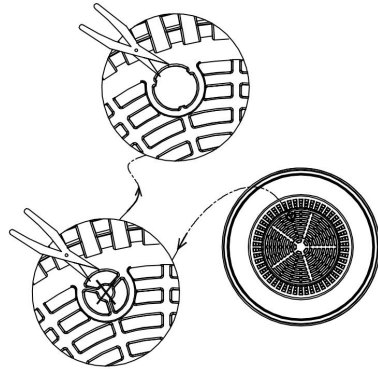

Cut off the plastic at the bottom of the basket of part A, as shown in the picture on the right, and then put it into the bucket

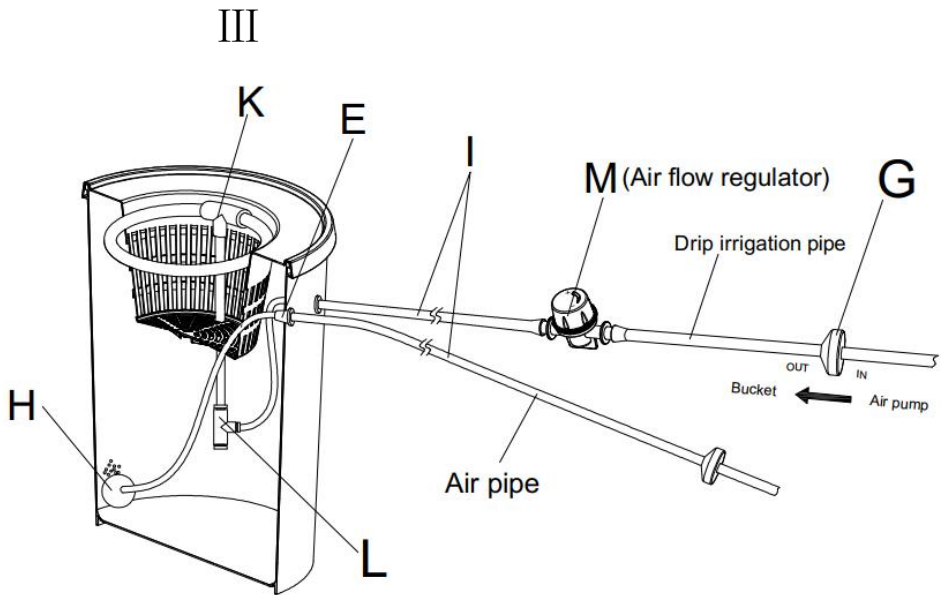

Skorzystaj ze wskazówek:

Kamień Powietrzny (H)



-Przed podłączeniem i montażem kamienia gazowego Proszę całkowicie zanurzyć go w wodzie na 10 sekund, aby napęścić wnętrze kamienia gazowego wodą, tj sprzyja tworzeniu się bąbelków

Kamyczki gliniane (X)



- Zaleca się czyszczenie cząstki ceramiczne wodą wcześniej stosować do usuwania kurzu i zanieczyszczeń.

AKCESORIA OPCJONALNE:

Regulatory przepływu powietrza (M,2 szt.) :

Do regulacji i równoważenia kropłówki i bąbelki z kamienia powietrznego na każdym wiadrze.

USTAWIENIE: Ustawić regulatory NA RURZE

NAWADNIAJĄCEJ każdego wiadra jak pokazano na lewym rysunku.

OPERACJA:

Obróć nasadkę regulatora, aby wyregulować wylot powietrza do nawadniania kropłowego. Obróć w dół

(-), aby dodać pęcherzyki powietrza z kamienia napowietrzającego i zmniejszyć przepływ kropel każdego z nich wiaderko.

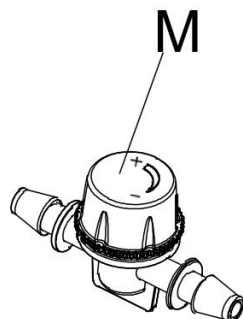

SPECIFICATIONS

Model	EHW0004C-DR		
Moc	15W	15W	15W
Napięcie wejściowe	AC 110 ~ 120 V 60 Hz	AC 220 V ~ 240 V 50 Hz	AC 220 V ~ 240 V 50 Hz

Typ wtyczki	Wtyczka amerykańska	Wtyczka europejska	Wtyczka australijska
-------------	---------------------	--------------------	----------------------

Adres: Shuangchenglu 803nong11hao1602A-1609shi, baoshanqu, szanghaj 200000 CN.

Import do AUS: SIHAO PTY LTD. 1 ROKEVA STREETEASTWOOD NSW 2122 Australia

Import do USA: Sanven Technology Ltd. Suite 250, 9166 Anaheim Place, Rancho Cucamonga, Kalifornia 91730

EC	REP
-----------	------------

E-CrossStu GmbH
Mainzer Landstr.69, 60329 Frankfurt am Main.

UK	REP
-----------	------------

YH CONSULTING LIMITED.
C/O YH Consulting Limited Office 147, Centurion House,
London Road, Staines-upon-Thames, Surrey, TW18 4AX

VEVOR[®]

TOUGH TOOLS, HALF PRICE

Techniczny Certyfikat wsparcia i e-gwarancji

www.vevor.com/support

VEVOR[®]

TOUGH TOOLS, HALF PRICE

Technischer Support und E-Garantie-Zertifikat www.vevor.com/support

TIEFWASSER-KULTUREIMERSYSTEM

BENUTZERHANDBUCH

We continue to be committed to provide you tools with competitive price.

"Save Half", "Half Price" or any other similar expressions used by us only represents an estimate of savings you might benefit from buying certain tools with us compared to the major top brands and does not necessarily mean to cover all categories of tools offered by us. You are kindly reminded to verify carefully when you are placing an order with us if you are actually saving half in comparison with the top major brands.

VEVOR[®]

TOUGH TOOLS, HALF PRICE

DEEP WATER CULTURE BUCKET SYSTEM

MODELL: EHW0004C-DR

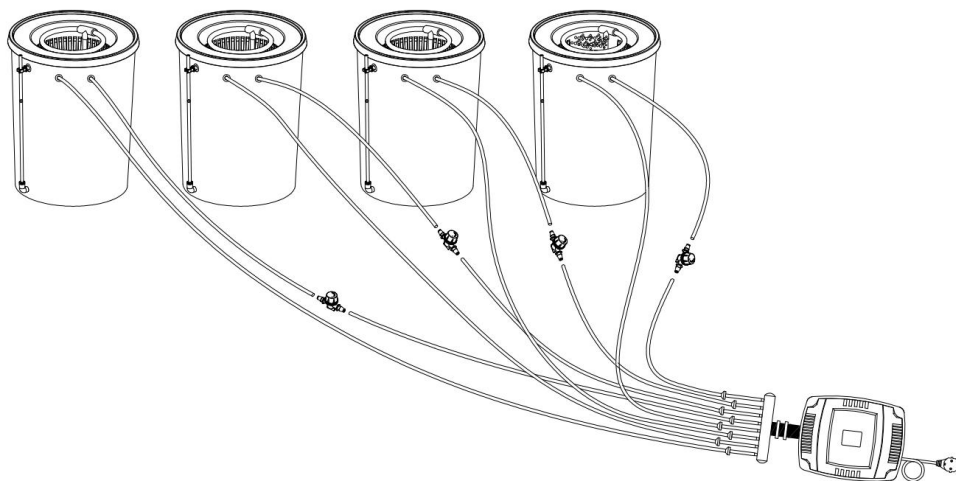

NEED HELP? CONTACT US!

Have product questions? Need technical support? Please feel free to contact us:

Technical Support and E-Warranty Certificate
www.vevor.com/support

This is the original instruction, please read all manual instructions carefully before operating. VEVOR reserves a clear interpretation of our user manual. The appearance of the product shall be subject to the product you received. Please forgive us that we won't inform you again if there are any technology or software updates on our product.



Vielen Dank, dass Sie sich für dieses Produkt entschieden haben . Bitte lesen Sie vor der Anwendung alle Hinweise sorgfältig durch. Die Informationen helfen Ihnen, die bestmöglichen Ergebnisse zu erzielen.

	<p>Warnung: Um das Verletzungsrisiko zu verringern, muss der Benutzer die Bedienungsanleitung sorgfältig lesen.</p>
	<p>KORREKTE ENTSORGUNG Dieses Produkt unterliegt den Bestimmungen der europäischen Richtlinie 2012/19/EU. Das Symbol einer durchgestrichenen Mülltonne weist darauf hin, dass dieses Produkt in der Europäischen Union einer getrennten Müllentsorgung unterliegt. Dies gilt für das Produkt und alle mit diesem Symbol gekennzeichneten Zubehörteile. So gekennzeichnete Produkte dürfen nicht im normalen Hausmüll entsorgt werden, sondern müssen an einer Sammelstelle für das Recycling von elektrischen und elektronischen Geräten abgegeben werden .</p>

SAFETY INSTRUCTION

WARNUNG:

Lesen Sie alle Sicherheitshinweise, Anweisungen, Abbildungen und technischen Daten, die dieser Luftpumpe beiliegen. Die Nichtbeachtung aller unten aufgeführten Anweisungen kann zu Stromschlag, Brand und/oder schweren Verletzungen führen.

Grundlegende Sicherheitsinformationen :

31. Dieses Produkt ist nur zum Anpflanzen bestimmt.

32. Das Ziehen oder Ziehen des Produkts an der Stromleitung ist nicht gestattet.

33. Halten Sie beim Herausziehen des Steckers bitte den Stecker selbst fest; Ziehen Sie nicht am Stromkabel.

34. Schneiden Sie den Netzstecker nicht selbst ab und ersetzen Sie ihn nicht, sonst kann es zu schwerwiegenden Schäden kommen

Es kann zu Konsequenzen kommen.

35. Bei Schäden mit Strom ist der Betrieb des Produkts nicht gestattet
Linie oder die Schale.

18. Eine Demontage und Demontage des Produkts durch Laien ist nicht gestattet.

19. Falls die Luftpumpe ins Wasser fällt, unterbrechen Sie bitte vorher die Stromversorgung es ausbaggern. Dann sollte es zur Kontrolle einem Fachmann übergeben werden Und Wartung.

8. Stromschlaggefahr: Berühren Sie die Luftpumpe nicht mit nassen Händen oder wenn Sie auf einer nassen Oberfläche stehen. Verwenden Sie die Luftpumpe immer in einer trockenen Umgebung und stecken Sie sie in eine ordnungsgemäß geerdete Steckdose.

9. Brandgefahr: Verwenden Sie die Luftpumpe nicht in der Nähe von entflammbar oder brennbaren Materialien. Halten Sie die Luftpumpe von Wärme- oder Funkenquellen wie Flammen, Zigaretten oder Elektrogeräten fern.

10. Explosionsgefahr: Verwenden Sie die Luftpumpe nicht mit brennbaren, explosiven oder giftigen Gasen. Lesen Sie immer das Sicherheitsdatenblatt (SDS) des Gases, bevor Sie es mit der Luftpumpe verwenden . Überschreiten Sie außerdem nicht den angegebenen Druckbereich für die Luftpumpe .

11. Korrosionsgefahr: Benutzen Sie die Luftpumpe nicht mit Gasen, die Metalle angreifen oder chemische Ladungen erzeugen können.

Überprüfen Sie die Verträglichkeit des Gases mit den Materialien der Luftpumpe und ihres Zubehörs. Tragen Sie beim Umgang mit ätzenden Materialien immer Schutzhandschuhe und eine Schutzbrille.

12. Verwenden Sie keinen beschädigten Stecker oder eine beschädigte Steckdose, da dies zu Stromschlägen oder Bränden führen kann.

13. Wenn das Netzkabel beschädigt ist, muss es vom Hersteller, seinem Kundendienst oder ähnlich qualifizierten Personen ersetzt werden, um Gefahren zu vermeiden.

14. Dieses Gerät kann von Kindern ab 8 Jahren und von Personen mit eingeschränkten körperlichen, sensorischen oder geistigen Fähigkeiten oder mangelnder Erfahrung und Wissen verwendet werden, wenn sie beaufsichtigt werden oder in die sichere Verwendung des Geräts eingewiesen werden und diese verstehen welche Gefahren damit verbunden sind. Kinder dürfen nicht mit dem Gerät spielen. Reinigung und Benutzerwartung dürfen nicht von Kindern ohne Aufsicht durchgeführt werden.

15. Schneiden und ersetzen Sie den Netzstecker nicht selbst, sonst kann es zu schwerwiegenden Schäden kommen

Es kann zu Konsequenzen kommen.











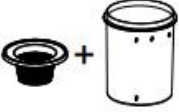

34. Bei Schäden mit Strom ist der Betrieb des Produkts nicht gestattet
Linie oder die Schale.

35. Eine Demontage und Demontage des Produkts durch Laien ist nicht gestattet.

36. Sollte die Luftpumpe ins Wasser fallen, unterbrechen Sie bitte vor dem Ausbaggern. Dann sollte es zur Überprüfung an Fachleute übergeben werden Und Wartung.

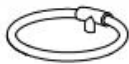
ANLEITUNG AUFBEWAHREN

PARTS LIST

	Description	Picture	Quantity
A	Planting buckets		4
C	Red ball		4
D	Buckle		4
E	Seal ring		16
F	Water level tube340		4
G	In line check valve		8
H	Air stone		4
I	Black feeding Air hose(4x6)		12m
J	Air pump-8pin		1
K	Drip irrigation pipe-333-545		4
L	Water inlet tube-270		4
M	Air flow regulator		4
X	Clay pebbles-3		4bag

INSTALLATION

Freundliche Tipps - Für die Installation erforderliche Tools:

13. Schere

14. Heißer Haartrockner (Heizluftschlauch für einfaches Einführen)

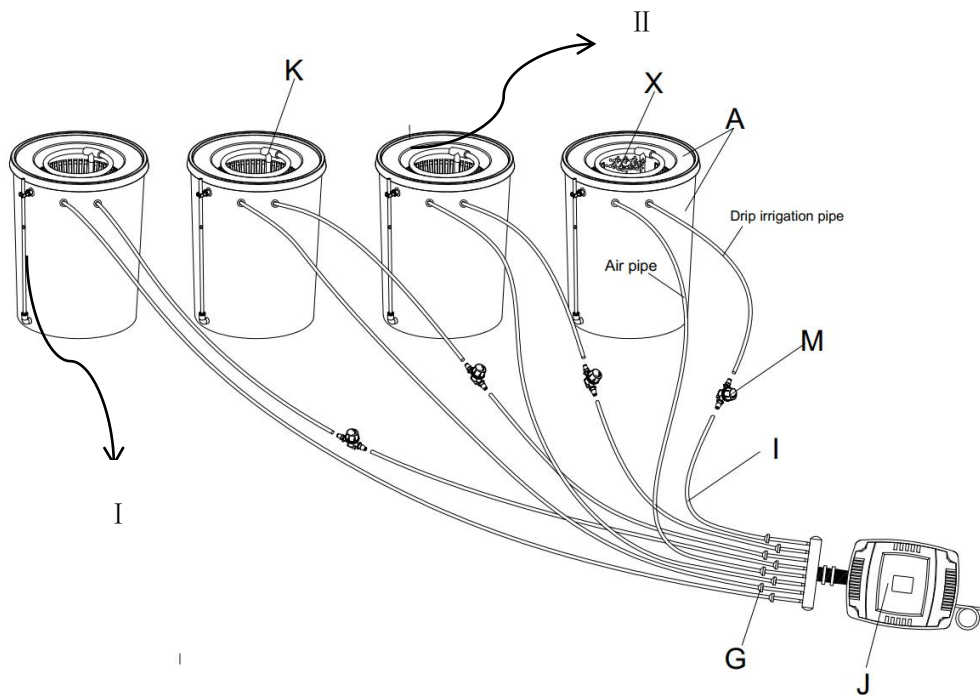

I II

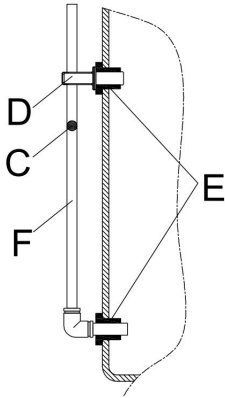

Connect F to the bucket as shown

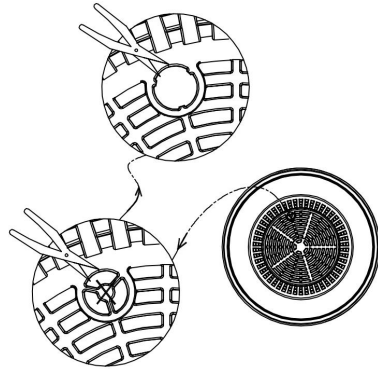

Cut off the plastic at the bottom of the basket of part A, as shown in the picture on the right, and then put it into the bucket

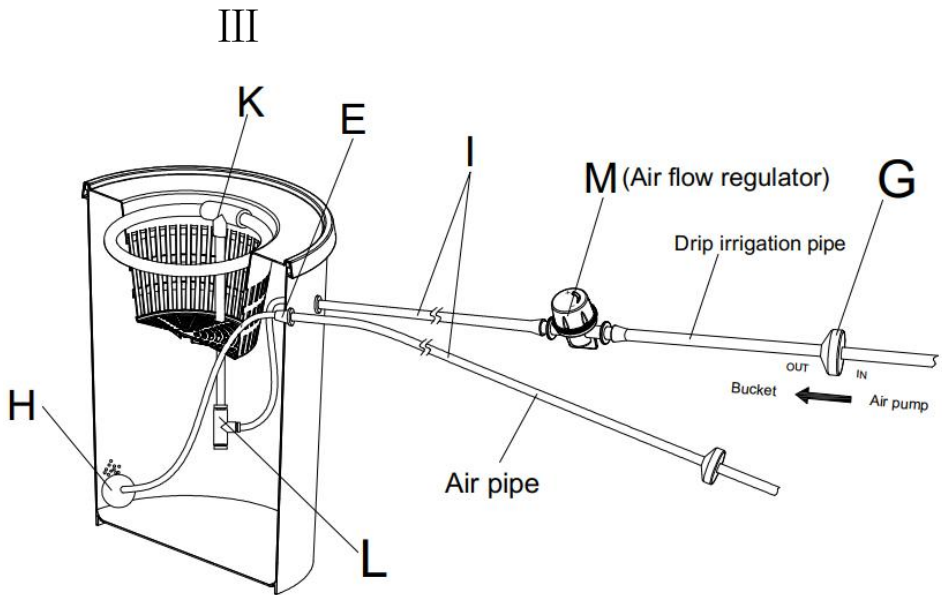

Tipps zur Verwendung:
Luftstein (H)



-Vor dem Anschließen und Zusammenbauen des Gassteins Bitte tauchen Sie es zum Befüllen 10 Sekunden lang vollständig in Wasser das Innere des Gassteins mit Wasser, das ist begünstigt die

Blasenbildung

Tonkiesel (X)



- Es wird empfohlen, das zu reinigen Keramikpartikel vorher mit Wasser befeuchten Zum Entfernen von Staub und Verunreinigungen verwenden.

OPTIONALES ZUBEHÖR:

Luftstromregler (M, 2 Stück) :

Zum Einstellen und Ausgleichen des Tropfens und Blasen aus Luftsteinen auf jedem Eimer.

EINRICHTUNG: Stellen Sie die Regler AM TROPFBEWÄSSERUNGSROHR ein von jedem Eimer wie die linke Zeichnung zeigt.

BETRIEB:

Drehen Sie die Kappe des Reglers, um den Luftauslass für die Tropfbewässerung einzustellen.

Drehen Sie nach unten (-), um Luftblasen aus dem Luftstein hinzuzufügen und den Tropffluss von jedem zu verringern Eimer.

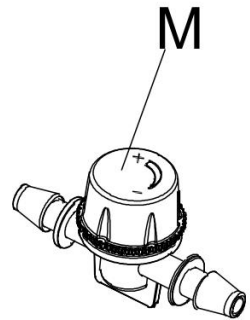

SPECIFICATIONS

Modell	EHW0004C-DR		
Leistung	15W	15W	15W
Eingangsspannung	Wechselstrom 110 ~ 120 V 60Hz	Wechselstrom 220 V ~ 240 V, 50 Hz	Wechselstrom 220 V ~ 240 V, 50 Hz

Steckertyp	Amerikanischer Stecker	Europäischer Stecker	Australischer Stecker
------------	------------------------	----------------------	-----------------------

Adresse: Shuangchenglu 803nong11hao1602A-1609shi, Baoshanqu, Shanghai 200000 CN.

Nach AUS importiert: SIHAO PTY LTD. 1 ROKEVA
STREETEASTWOOD NSW 2122 Australien

Importiert in die USA: Sanven Technology Ltd. Suite 250, 9166 Anaheim Ort, Rancho Cucamonga, CA 91730

EC	REP
-----------	------------

E-CrossStu GmbH
Mainzer Landstr.69, 60329 Frankfurt am Main.

UK	REP
-----------	------------

YH CONSULTING LIMITED.
C/O YH Consulting Limited Office 147, Centurion House,
London Road, Staines-upon-Thames, Surrey, TW18 4AX

VEVOR[®]

TOUGH TOOLS, HALF PRICE

Technisch Support und E-Garantie-Zertifikat

www.vevor.com/support

VEVOR[®]

TOUGH TOOLS, HALF PRICE

Assistance technique et certificat de garantie électronique www.vevor.com/support

SYSTÈME DE SEAU DE CULTURE EN EAU PROFONDE MANUEL DE L'UTILISATEUR

We continue to be committed to provide you tools with competitive price.

"Save Half", "Half Price" or any other similar expressions used by us only represents an estimate of savings you might benefit from buying certain tools with us compared to the major top brands and does not necessarily mean to cover all categories of tools offered by us. You are kindly reminded to verify carefully when you are placing an order with us if you are actually saving half in comparison with the top major brands.

VEVOR[®]

TOUGH TOOLS, HALF PRICE

DEEP WATER CULTURE BUCKET SYSTEM

MODÈLE: EHW0004C-DR

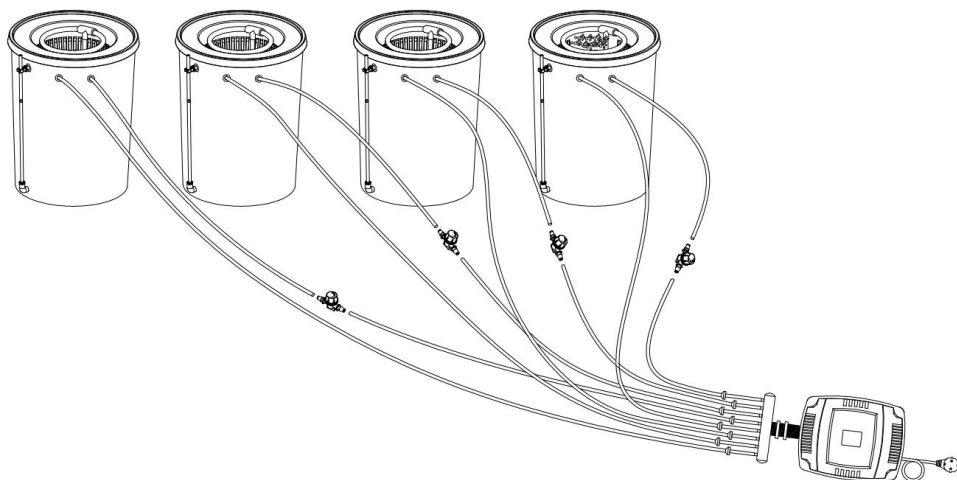

NEED HELP? CONTACT US!

Have product questions? Need technical support? Please feel free to contact us:

Technical Support and E-Warranty Certificate
www.vevor.com/support

This is the original instruction, please read all manual instructions carefully before operating. VEVOR reserves a clear interpretation of our user manual. The appearance of the product shall be subject to the product you received. Please forgive us that we won't inform you again if there are any technology or software updates on our product.



Merci beaucoup d'avoir choisi ce produit . Veuillez lire toutes les instructions avant de l'utiliser. Les informations vous aideront à obtenir les meilleurs résultats possibles.

	Avertissement : Pour réduire le risque de blessure, l'utilisateur doit lire attentivement le manuel d'instructions.
	ÉLIMINATION CORRECTE Ce produit est soumis aux dispositions de la directive européenne 2012/19/CE. Le symbole représentant une poubelle barrée indique que le produit nécessite une collecte sélective des déchets dans l'Union européenne. Ceci s'applique au produit et à tous les accessoires marqués de ce symbole. Les produits marqués comme tels ne peuvent pas être jetés avec les ordures ménagères normales, mais doivent être déposés dans un point de collecte pour le recyclage des appareils électriques et électroniques .

SAFETY INSTRUCTION

AVERTISSEMENT:

Lisez tous les avertissements de sécurité, instructions, illustrations et spécifications fournis avec cette pompe à air. Le non-respect de toutes les instructions énumérées ci-dessous peut entraîner un choc électrique, un incendie et/ou des blessures graves.

sur la sécurité :

36.Ce produit est destiné uniquement à la plantation.

37.Tirer ou faire glisser le produit avec une ligne électrique n'est pas autorisé.

38.Lorsque vous retirez la fiche, veuillez tenir la fiche elle-même ; ne tirez

pas sur la ligne électrique.

39. Ne coupez pas et ne remplacez pas la fiche d'alimentation par vous-même, sinon cela pourrait être grave

Des conséquences peuvent en résulter.

40. Le fonctionnement du produit n'est pas autorisé en cas de dommage dû au courant

ligne ou la coquille.

20. Le démontage et le remontage du produit par des profanes ne sont pas autorisés.

21. Si la pompe à air tombe dans l'eau, veuillez couper l'alimentation électrique avant le draguer. Ensuite, il doit être remis à des professionnels pour contrôle et entretien.

8. Risque de choc électrique : Ne touchez pas la pompe à air avec les mains mouillées ou en vous tenant debout sur une surface mouillée. Utilisez toujours la pompe à air dans un environnement sec et branchez-la dans une prise correctement mise à la terre.

9. Risque d'incendie : N'utilisez pas la pompe à air à proximité de matériaux inflammables ou combustibles. Gardez la pompe à air éloignée des sources de chaleur ou d'étincelles, telles que des flammes, des cigarettes ou des appareils électriques.

10. Risque d'explosion : N'utilisez pas la pompe à air avec des gaz inflammables, explosifs ou toxiques. Vérifiez toujours la fiche de données de sécurité (FDS) du gaz avant de l'utiliser avec la pompe à air. De plus, ne dépassez pas la plage de pression spécifiée pour la pompe à air.

11. Risque de corrosion : N'utilisez pas la pompe à air avec des gaz susceptibles de corroder les métaux ou d'exercer des charges chimiques. Vérifiez la compatibilité du gaz avec les matériaux de la pompe à air et de ses accessoires. Utilisez toujours des gants et des lunettes de protection lorsque vous manipulez des matériaux corrosifs.

12. N'utilisez pas de fiche ou de prise endommagée, car cela pourrait provoquer un choc électrique ou un incendie.

13. Si le cordon d'alimentation est endommagé, il doit être remplacé par le

fabricant, son agent de service ou des personnes de qualification similaire afin d'éviter tout danger.

14. Cet appareil peut être utilisé par des enfants âgés de 8 ans et plus et des personnes ayant des capacités physiques, sensorielles ou mentales réduites ou un manque d'expérience et de connaissances s'ils ont reçu une supervision ou des instructions concernant l'utilisation de l'appareil en toute sécurité et comprennent les dangers encourus. Les enfants ne doivent pas jouer avec l'appareil. Le nettoyage et l'entretien par l'utilisateur ne doivent pas être effectués par des enfants sans surveillance.

15. Ne coupez pas et ne remplacez pas la fiche d'alimentation par vous-même, sinon cela pourrait être grave

Des conséquences peuvent en résulter.











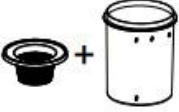

37. Le fonctionnement du produit n'est pas autorisé en cas de dommage dû au courant ligne ou la coquille.

38. Le démontage et le remontage du produit par des profanes ne sont pas autorisés.

39. Si la pompe à air tombe dans l'eau, veuillez couper l'alimentation électrique avant le draguer. Ensuite, il doit être remis à des professionnels pour contrôle. et entretien.

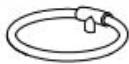
CONSERVEZ CES INSTRUCTIONS

PARTS LIST

	Description	Picture	Quantity
A	Planting buckets		4
C	Red ball		4
D	Buckle		4
E	Seal ring		16
F	Water level tube340		4
G	In line check valve		8
H	Air stone		4
I	Black feeding Air hose(4x6)		12m
J	Air pump-8pin		1
K	Drip irrigation pipe-333-545		4
L	Water inlet tube-270		4
M	Air flow regulator		4
X	Clay pebbles-3		4bag

INSTALLATION

Conseils conviviaux-outils requis pour l'installation :

15. Ciseaux

16. Sèche-cheveux chaud (tuyau d'air chauffant pour une insertion facile)

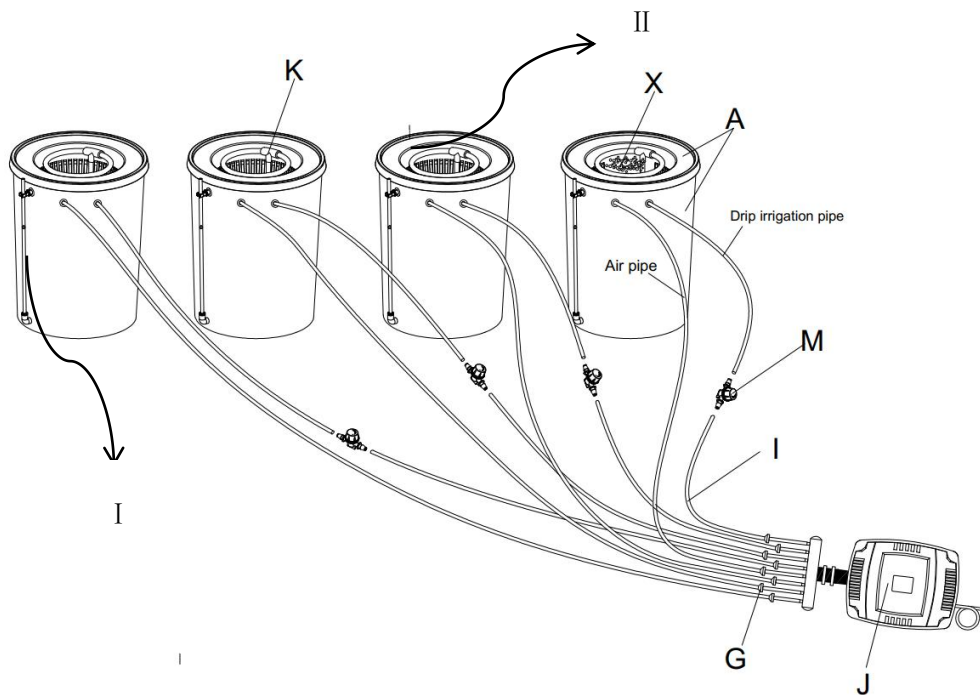

I II

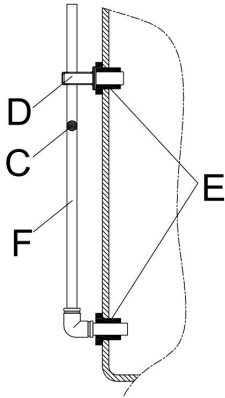

Connect F to the bucket as shown

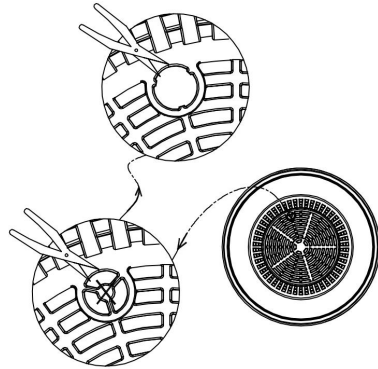

Cut off the plastic at the bottom of the basket of part A, as shown in the picture on the right, and then put it into the bucket

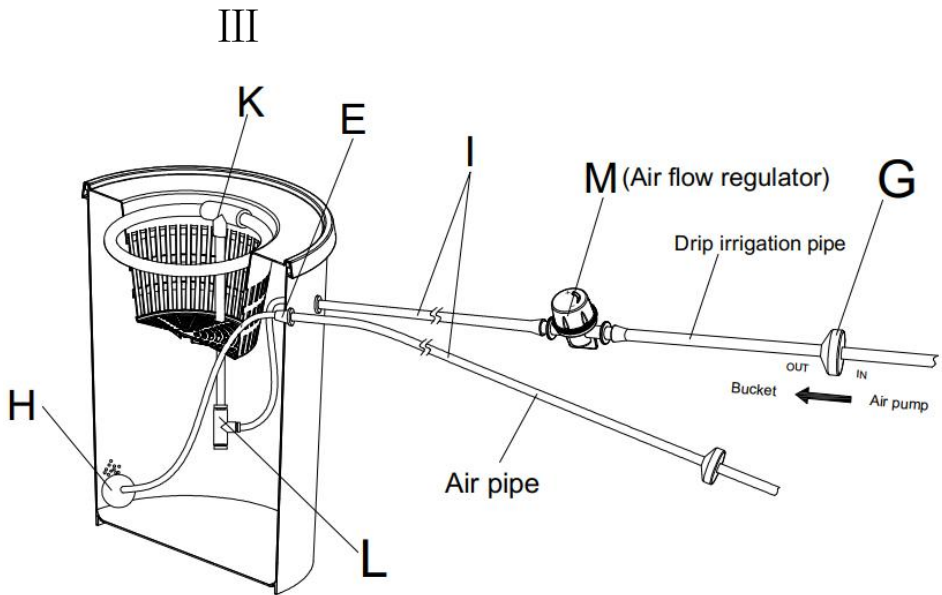

Conseils d'utilisation :
Pierre d'air (H)



-Avant de connecter et d'assembler la pierre à gaz veuillez le plonger complètement dans l'eau pendant 10 secondes pour le remplir l'intérieur de la pierre à gaz avec de l'eau, qui est propice à la génération de bulles

Galets d'argile (X)



- Il est recommandé de nettoyer les particules de céramique avec de l'eau avant utilisation pour éliminer la poussière et les impuretés.

ACCESSOIRES OPTIONNELS:

Régulateurs de débit d'air (M,2 pcs) :

Pour le réglage et l'équilibrage du goutte-à-goutte et des bulles de pierre à air sur chaque seau.

CONFIGURATION : Réglez les régulateurs SUR LE TUYAU D'IRRIGATION GOUTTE À GOUTTE de chaque seau comme le montre le dessin de gauche.

OPÉRATION:

Faites pivoter le capuchon du régulateur pour régler la sortie d'air pour l'irrigation goutte à goutte. Baissez (-) pour ajouter des bulles d'air de la pierre à air et diminuer le débit goutte à goutte de chaque seau.

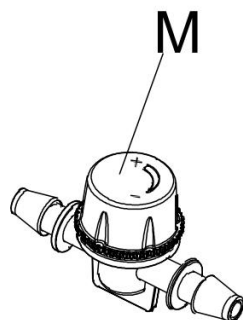

SPECIFICATIONS

Modèle	EHW0004C-DR		
Pouvoir	15W	15W	15W
Tension d'entrée	C.A. 110 ~ 120 V 60Hz	C.A. 220 V ~ 240 V 50 Hz	C.A. 220 V ~ 240 V 50 Hz
Type de connecteur	prise américaine	Prise européenne	Prise australienne

Adresse : Shuangchenglu 803nong11hao1602A-1609shi, baoshanqu, Shanghai 200000 CN.

Importé en Australie : SIHAO PTY LTD. 1 ROKEVA STREETASTWOOD NSW 2122 Australie

Importé aux États-Unis : Sanven Technology Ltd. Suite 250, 9166 Anaheim

Lieu, Rancho Cucamonga, CA 91730

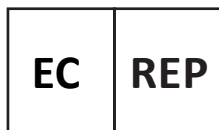

E-CrossStu GmbH

Mainzer Landstr.69, 60329 Frankfurt am Main.



YH CONSULTING LIMITED.

C/O YH Consulting Limited Office 147, Centurion House, London Road, Staines-upon-Thames, Surrey, TW18 4AX

VEVOR[®]

TOUGH TOOLS, HALF PRICE

Technique Assistance et certificat de garantie électronique

www.vevor.com/support