

VEVOR[®]

TOUGH TOOLS, HALF PRICE

Technical Support and E-Warranty Certificate www.vevor.com/support

PORCH SWING USER MANUAL

We continue to be committed to provide you tools with competitive price.

"Save Half", "Half Price" or any other similar expressions used by us only represents an estimate of savings you might benefit from buying certain tools with us compared to the major top brands and does not necessarily mean to cover all categories of tools offered by us. You are kindly reminded to verify carefully when you are placing an order with us if you are actually saving half in comparison with the top major brands.

VEVOR[®]

TOUGH TOOLS, HALF PRICE

PORCH SWING

MODEL:YQ-117B

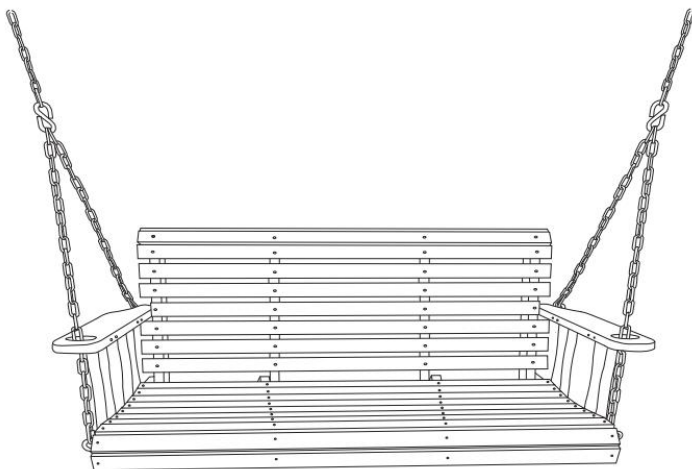

NEED HELP? CONTACT US!

Have product questions? Need technical support? Please feel free to contact us:

Technical Support and E-Warranty Certificate
www.vevor.com/support

This is the original instruction, please read all manual instructions carefully before operating. VEVOR reserves a clear interpretation of our user manual. The appearance of the product shall be subject to the product you received. Please forgive us that we won't inform you again if there are any technology or software updates on our product.

SAFETY INSTRUCTIONS

WARNING:

Read this instructions carefully before using this product. Failure to do so can result in serious injury.

Assembly precautions











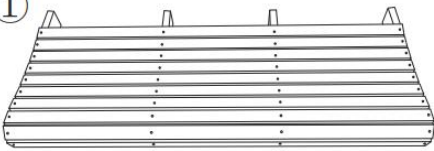

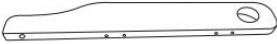



1. Assemble only should be according to these instructions. Improper assembly can result in hazards.
2. Wear ANSI-approved safety goggles and heavy-duty work gloves during assembly.
3. Keep the assembly area clean and well-lit.
4. Keep bystanders out of the area during assembly.
5. Do not assemble when tired or when under the influence of alcohol, drugs or medication.
6. The product capabilities apply to properly and completely assembled products only.
7. Assemble on a flat, level, hard and smooth surface capable of safely supporting the porch swing.
8. For additional information regarding the parts listed in the following pages, please refer to the Assembly Diagram of this manual. Unwrap and separate all parts in a clean work area.

Use precautions

1. Do not exceed weight capacities.
2. Use only on a flat, level and hard surface capable of safely supporting a fully loaded porch swing.
3. Use as intended only.
4. Inspect before every use; do not use if parts are loose or damaged.

SAVE THESE INSTRUCTIONS

PARTS LIST

 <p>1</p> <p style="text-align: center;">1PCS</p>	 <p>2</p> <p style="text-align: center;">1PCS</p>		
 <p>3</p> <p style="text-align: center;">1PCS</p>	 <p>4</p> <p style="text-align: center;">1PCS</p>		
 <p>5</p> <p style="text-align: center;">4PCS</p>	 <p>6</p> <p style="text-align: center;">2PCS</p>		
<p>A</p>  <p style="text-align: center;">12PCS</p>	<p>B</p>  <p style="text-align: center;">12PCS</p>	<p>C</p>  <p style="text-align: center;">12PCS</p>	<p>D</p>  <p style="text-align: center;">8PCS</p>
<p>E</p>  <p style="text-align: center;">2PCS</p>	<p>F</p>  <p style="text-align: center;">2PCS</p>	<p>G</p>  <p style="text-align: center;">8PCS</p>	<p>H</p>  <p style="text-align: center;">4PCS</p>
<p>I</p>  <p style="text-align: center;">4PCS</p>	<p>J</p>  <p style="text-align: center;">1PCS</p>	<p>K</p>  <p style="text-align: center;">1PCS</p>	

ASSEMBLY STEP

STEP1

Install support plates 5 on seat 1 with parts A, B and C.

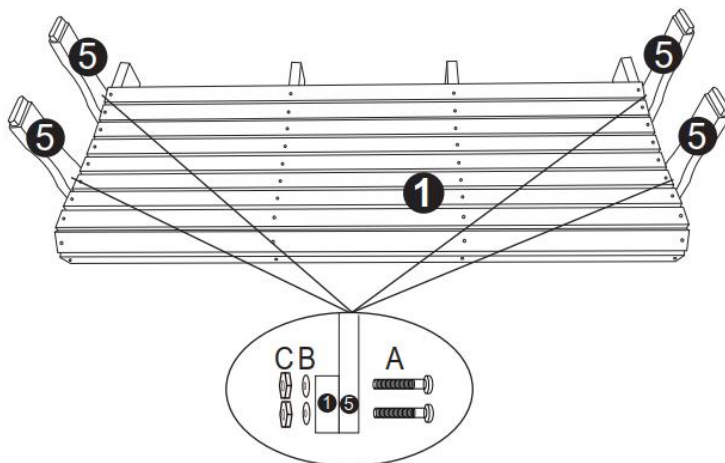

STEP2

Install the left and right handrails 3,4 on the support plate 5 and tighten them with screw D. In order to install a perfect swing, we recommended you to tighten D after completing step3.

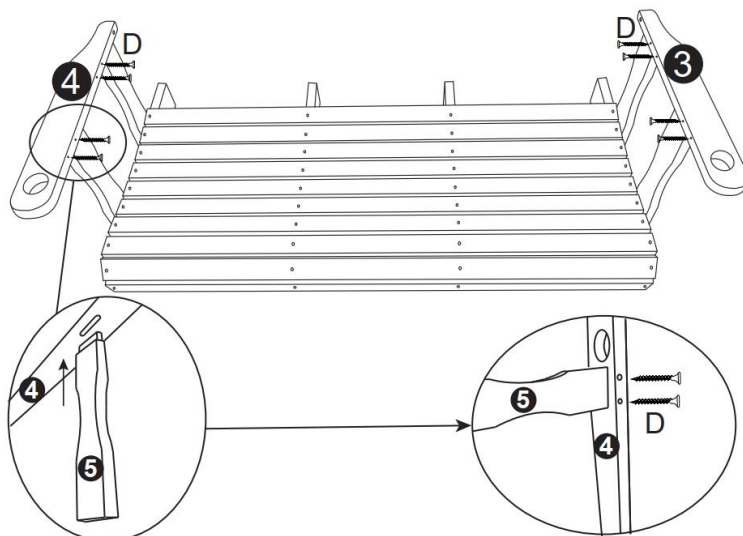

STEP3

Connect the backrest 2 to the seat 1 with parts A, B, and C.

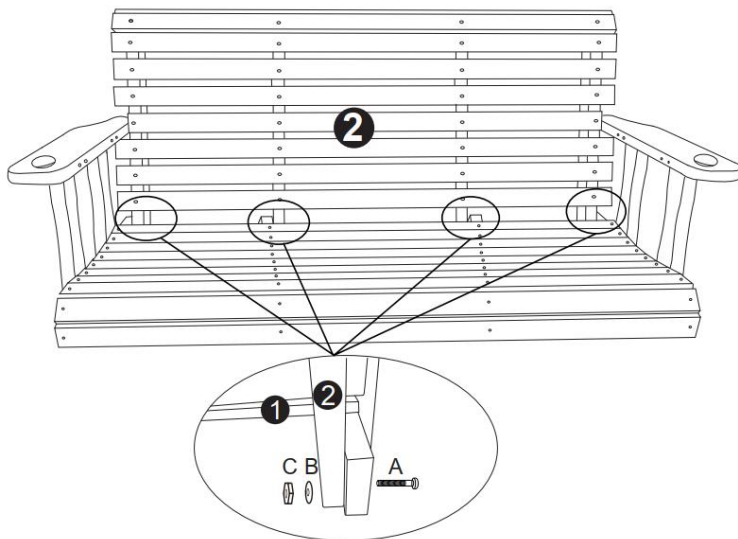

STEP4

Connect armrests 3,4 to backrest 2 with parts F,G,H, and E,G,H to the front hole of the seat noting that the holes of parts E and F facing forward. Then part E and F hang ring I on respectively.

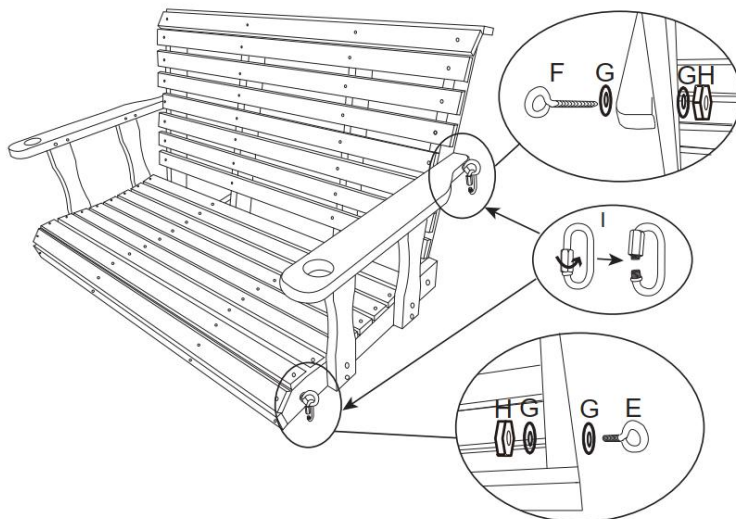

STEP5

Chains 6 is connected to parts E and F through hanging ring I, and part I is tightened according to the figure to complete the installation.

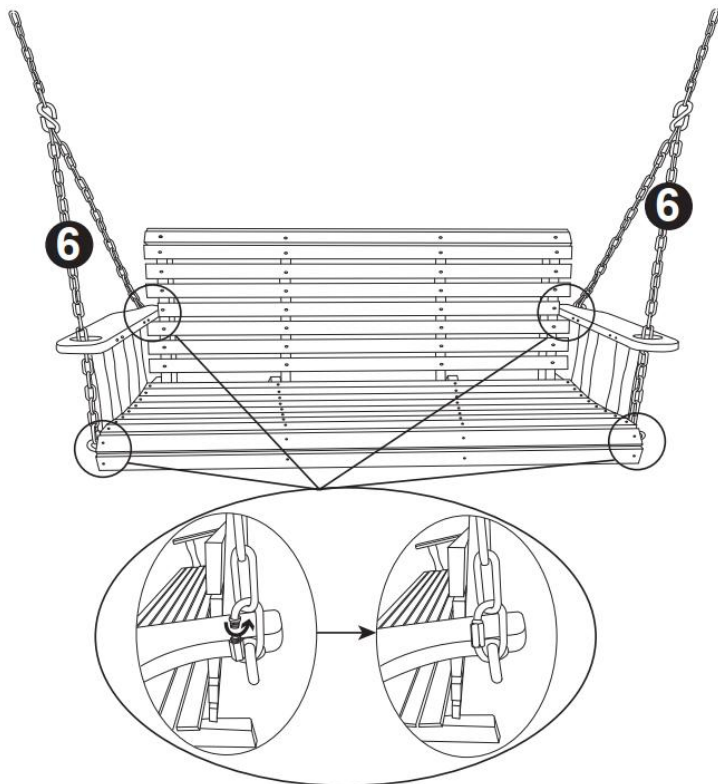

PRODUCT PARAMETER

Specification	54*25.6 inch(seat size)
Size (mm)	1370*710*600
Colour	White
	Carbonizing color
Type	4.5ft
Main material	China fir

Address: Baoshanqu Shuangchenglu 803long 11hao 1602A-1609shi
Shanghai

Imported to AUS: SIHAO PTY LTD, 1 ROKEVA STREETEASTWOOD
NSW 2122 Australia

Imported to USA: Sanven Technology Ltd., Suite 250, 9166 Anaheim
Place, Rancho Cucamonga, CA 91730



SHUNSHUN GmbH
Römeräcker 9 Z2021,76351
Linkenheim-Hochstetten, Germany
euvertreter@gmail.com
+49 1727041930



Pooledas Group Ltd
Unit 5 Albert Edward House, The
Pavilions Preston, United Kingdom
pooledas123@gmail.com
Tel: 01772418127

Made In China

VEVOR[®]

TOUGH TOOLS, HALF PRICE

Technical Support and E-Warranty Certificate

www.vevor.com/support

VEVOR[®]

TOUGH TOOLS, HALF PRICE

Técnico Soporte y certificado de garantía electrónica www.vevor.com/support

MANUAL DE USUARIO DEL COLUMPIO PARA PORCHE

We continue to be committed to provide you tools with competitive price.

"Save Half", "Half Price" or any other similar expressions used by us only represents an estimate of savings you might benefit from buying certain tools with us compared to the major top brands and does not necessarily mean to cover all categories of tools offered by us. You are kindly reminded to verify carefully when you are placing an order with us if you are actually saving half in comparison with the top major brands.

VEVOR®

TOUGH TOOLS, HALF PRICE

PORCH SWING

MODELO: YQ-117B

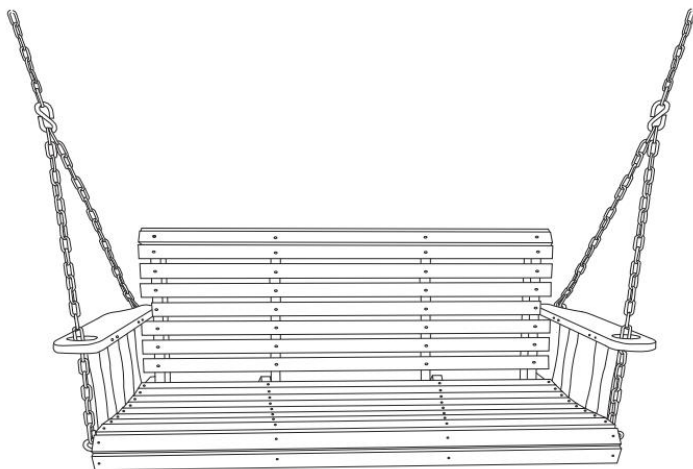

NEED HELP? CONTACT US!

Have product questions? Need technical support? Please feel free to contact us:

Technical Support and E-Warranty Certificate
www.vevor.com/support

This is the original instruction, please read all manual instructions carefully before operating. VEVOR reserves a clear interpretation of our user manual. The appearance of the product shall be subject to the product you received. Please forgive us that we won't inform you again if there are any technology or software updates on our product.

SAFETY INSTRUCTIONS

ADVERTENCIA:

Lea atentamente estas instrucciones antes de utilizar este producto. De lo contrario, se pueden producir lesiones graves.

Precauciones de montaje







9. El montaje únicamente debe realizarse de acuerdo con estas instrucciones. Un montaje inadecuado puede provocar peligros.
10. Use gafas de seguridad aprobadas por ANSI y guantes de trabajo resistentes durante el montaje.
11. Mantenga el área de reunión limpia y bien iluminada.
12. Mantenga a los transeúntes fuera del área durante el montaje.
13. No se reúna cuando esté cansado o bajo la influencia de alcohol, drogas o medicamentos.
14. Las capacidades del producto se aplican únicamente a productos ensamblados de manera adecuada y completa.
15. Ensamble sobre una superficie plana, nivelada, dura y lisa capaz de soportar de manera segura el columpio del porche.
16. Para obtener información adicional sobre las piezas enumeradas en las siguientes páginas, consulte el diagrama de montaje de este manual. Desenvuelva y separe todas las piezas en un área de trabajo limpia.



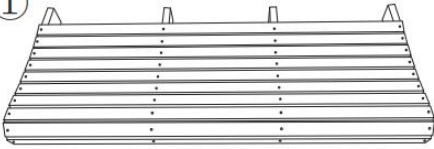





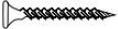

Use precauciones

5. No exceda las capacidades de peso.
6. Úselo únicamente sobre una superficie plana, nivelada y dura capaz de soportar de manera segura un columpio de porche completamente cargado.
7. Úselo únicamente según lo previsto.
8. Inspeccionar antes de cada uso; no lo utilice si las piezas están sueltas o dañadas.

GUARDA ESTAS INSTRUCCIONES

PARTS LIST

 <p>1</p> <p>1PCS</p>	 <p>2</p> <p>1PCS</p>
 <p>3</p> <p>1PCS</p>	 <p>4</p> <p>1PCS</p>
 <p>5</p> <p>4PCS</p>	 <p>6</p> <p>2PCS</p>

 <p>A</p> <p>12PCS</p>	 <p>B</p> <p>12PCS</p>	 <p>C</p> <p>12PCS</p>	 <p>D</p> <p>8PCS</p>
 <p>E</p> <p>2PCS</p>	 <p>F</p> <p>2PCS</p>	 <p>G</p> <p>8PCS</p>	 <p>H</p> <p>4PCS</p>
 <p>I</p> <p>4PCS</p>	 <p>J</p> <p>1PCS</p>	 <p>K</p> <p>1PCS</p>	

ASSEMBLY STEP

PASO 1

Instale las placas de soporte 5 en el asiento 1 con las piezas A, B y C.

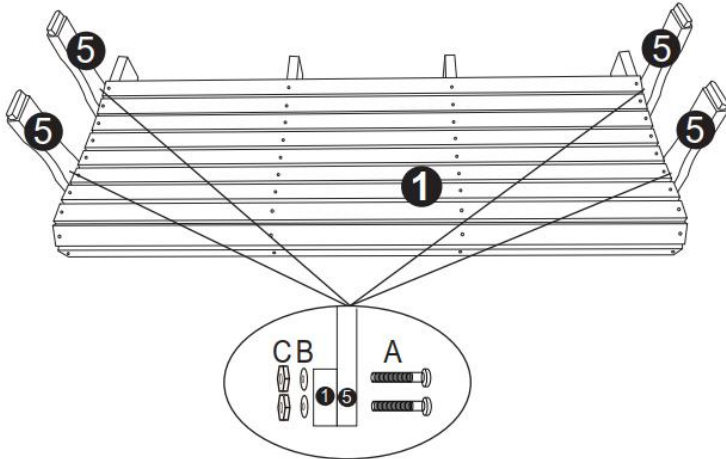

PASO 2

Instale los pasamanos izquierdo y derecho 3,4 en la placa de soporte 5 y apriételos con el tornillo D. Para instalar un giro perfecto, le recomendamos apretar D después de completar el paso 3 .

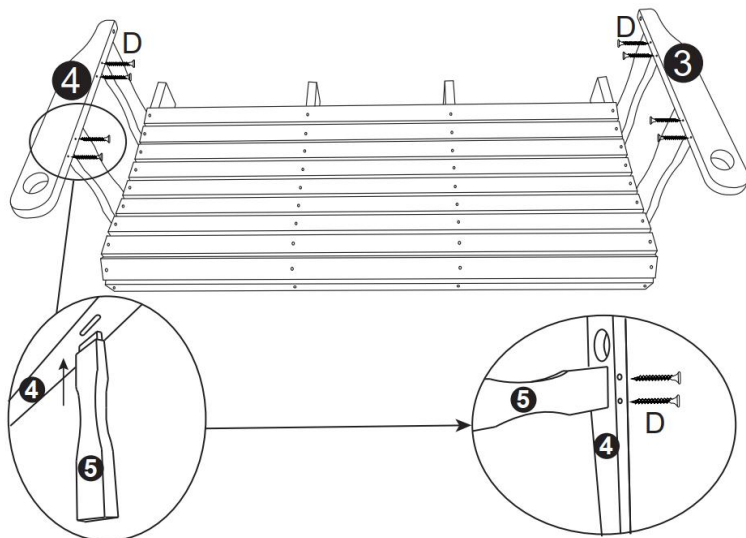

PASO 3

Conecte el respaldo 2 al asiento 1 con las piezas A, B y C.

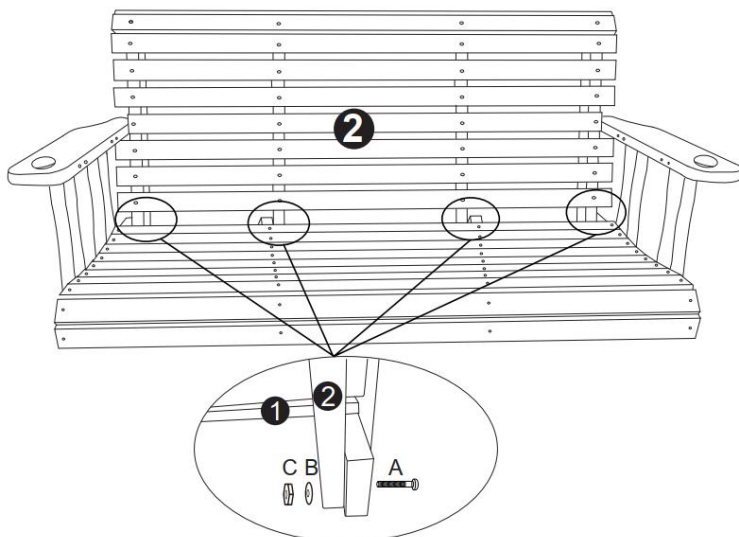

ETAPA 4

Conecte los reposabrazos 3,4 al respaldo 2 con las piezas F,G,H y E,G,H al orificio delantero del asiento teniendo en cuenta que los orificios de las piezas E y F miran hacia adelante. Luego las partes E y F cuelgan el anillo I respectivamente.

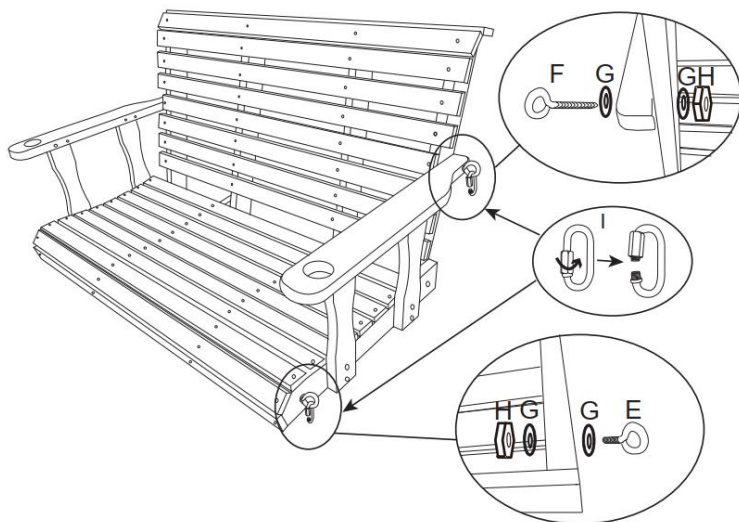

PASO 5

Las cadenas 6 se conectan a las partes E y F a través del anillo colgante I, y la parte I se aprieta según la figura para completar la instalación.

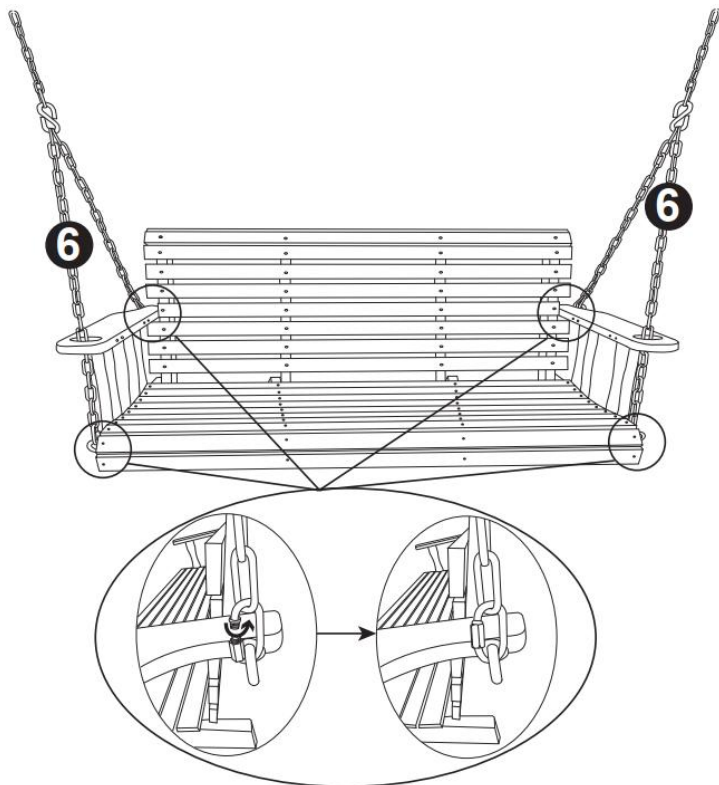

PRODUCT PARAMETER

Especificación	54*25,6 pulgadas (tamaño del asiento)
Tamaño (mm)	1370*710*600
Color	Blanco
	color carbonizante
Amable	4,5 pies
Material principal	abeto chino

Dirección: Baoshanqu Shuangchenglu 803long 11hao 1602A-1609shi
Shanghai

Importado a AUS: SIHAO PTY LTD, 1 ROKEVA STREET EASTWOOD
NSW 2122 Australia

Importado a EE. UU.: Sanven Technology Ltd., Suite 250, 9166 Anaheim
Place, Rancho Cucamonga, CA 91730



SHUNSHUN GmbH
Römeräcker 9 Z2021,76351
Linkenheim-Hochstetten, Germany
euvertreter@gmail.com
+49 1727041930



Pooledas Group Ltd
Unit 5 Albert Edward House, The
Pavilions Preston, United Kingdom
pooledas123@gmail.com
Tel: 01772418127

Hecho en china

VEVOR[®]

TOUGH TOOLS, HALF PRICE

Técnico Certificado de soporte y garantía electrónica

www.vevor.com/support

VEVOR[®]

TOUGH TOOLS, HALF PRICE

Tecnico Supporto e certificato di garanzia elettronica www.vevor.com/support

ALTALENA PER PORTICO MANUALE UTENTE

We continue to be committed to provide you tools with competitive price.

"Save Half", "Half Price" or any other similar expressions used by us only represents an estimate of savings you might benefit from buying certain tools with us compared to the major top brands and does not necessarily mean to cover all categories of tools offered by us. You are kindly reminded to verify carefully when you are placing an order with us if you are actually saving half in comparison with the top major brands.

VEVOR®

TOUGH TOOLS, HALF PRICE

PORCH SWING

MODELLO: YQ-117B

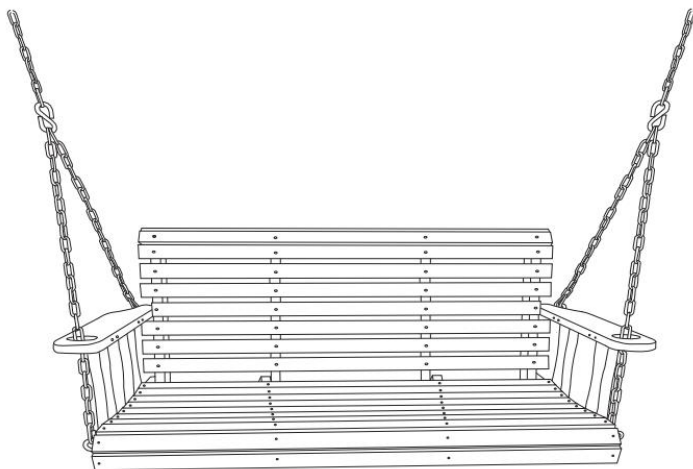

NEED HELP? CONTACT US!

Have product questions? Need technical support? Please feel free to contact us:

Technical Support and E-Warranty Certificate
www.vevor.com/support

This is the original instruction, please read all manual instructions carefully before operating. VEVOR reserves a clear interpretation of our user manual. The appearance of the product shall be subject to the product you received. Please forgive us that we won't inform you again if there are any technology or software updates on our product.

SAFETY INSTRUCTIONS

AVVERTIMENTO:

Leggere attentamente queste istruzioni prima di utilizzare questo prodotto. In caso contrario si potrebbero causare lesioni gravi.

Precauzioni per il montaggio











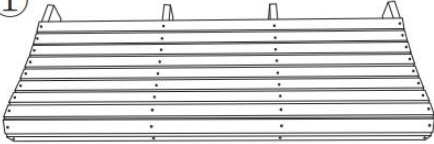



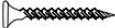

17. Solo il montaggio deve avvenire secondo queste istruzioni. Un montaggio improprio può causare pericoli.
18. Indossare occhiali di sicurezza approvati ANSI e guanti da lavoro pesanti durante il montaggio.
19. Mantenere l'area di assemblaggio pulita e ben illuminata.
20. Tenere gli astanti lontani dall'area durante il montaggio.
21. Non montare in caso di stanchezza o sotto l'effetto di alcol, droghe o farmaci.
22. Le funzionalità del prodotto si applicano solo ai prodotti correttamente e completamente assemblati.
23. Montare su una superficie piana, livellata, dura e liscia in grado di sostenere in sicurezza il dondolo.
24. Per ulteriori informazioni riguardanti le parti elencate nelle pagine seguenti, fare riferimento allo Schema di Montaggio di questo manuale. Scartare e separare tutte le parti in un'area di lavoro pulita.

Usare precauzioni

9. Non superare le capacità di peso.
10. Utilizzare solo su una superficie piana, livellata e dura in grado di sostenere in sicurezza un dondolo da veranda a pieno carico.
11. Utilizzare solo come previsto.
12. Ispezionare prima di ogni utilizzo; non utilizzare se le parti sono allentate o danneggiate.

CONSERVA QUESTE ISTRUZIONI

PARTS LIST

 <p>1</p> <p>1PCS</p>	 <p>2</p> <p>1PCS</p>		
 <p>3</p> <p>1PCS</p>	 <p>4</p> <p>1PCS</p>		
 <p>5</p> <p>4PCS</p>	 <p>6</p> <p>2PCS</p>		
<p>A</p>  <p>12PCS</p>	<p>B</p>  <p>12PCS</p>	<p>C</p>  <p>12PCS</p>	<p>D</p>  <p>8PCS</p>
<p>E</p>  <p>2PCS</p>	<p>F</p>  <p>2PCS</p>	<p>G</p>  <p>8PCS</p>	<p>H</p>  <p>4PCS</p>
<p>I</p>  <p>4PCS</p>	<p>J</p>  <p>1PCS</p>	<p>K</p>  <p>1PCS</p>	

ASSEMBLY STEP

PASSO 1

Installare le piastre di supporto 5 sul sedile 1 con le parti A, B e C.

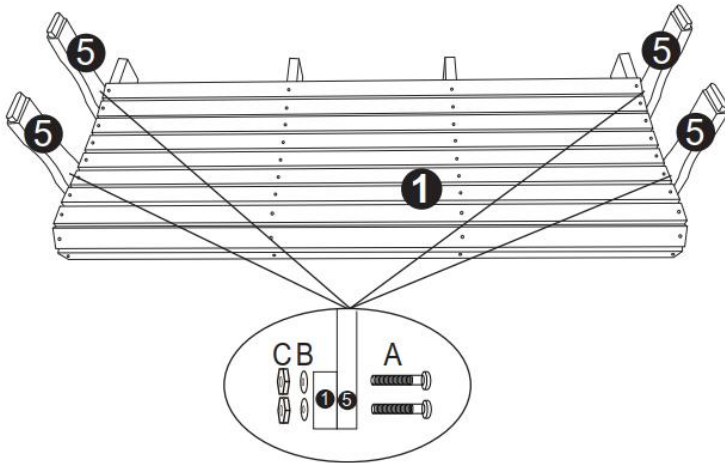

PASSO 2

Installare i corrimano sinistro e destro 3,4 sulla piastra di supporto 5 e serrarli con la vite D. Per installare un'oscillazione perfetta, si consiglia di serrare D dopo aver completato il passaggio 3 .

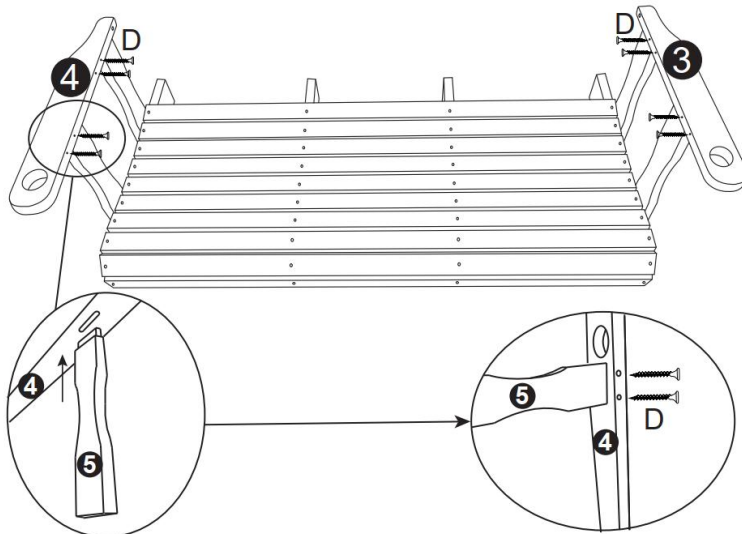

PASSO3

Collega lo schienale 2 al sedile 1 con le parti A, B e C.

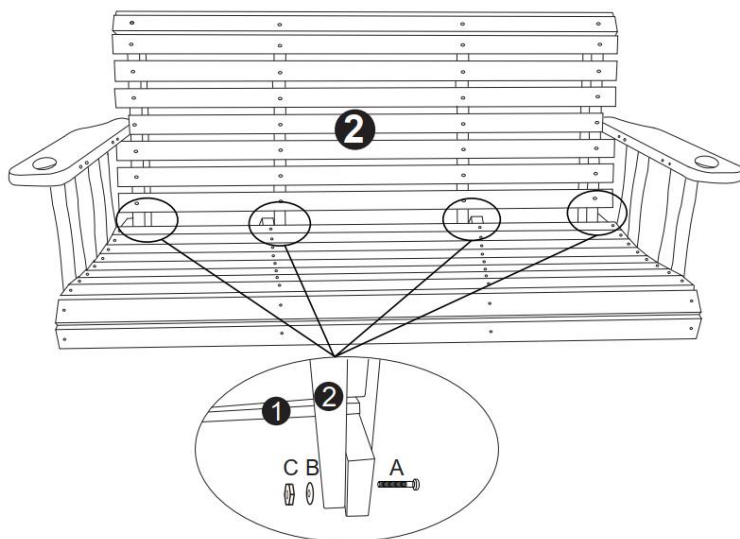

PASSO4

Collegare i braccioli 3,4 allo schienale 2 con le parti F,G,H ed E,G,H al foro anteriore del sedile notando che i fori delle parti E ed F sono rivolti in avanti. Quindi le parti E e F appendono rispettivamente l'anello I.

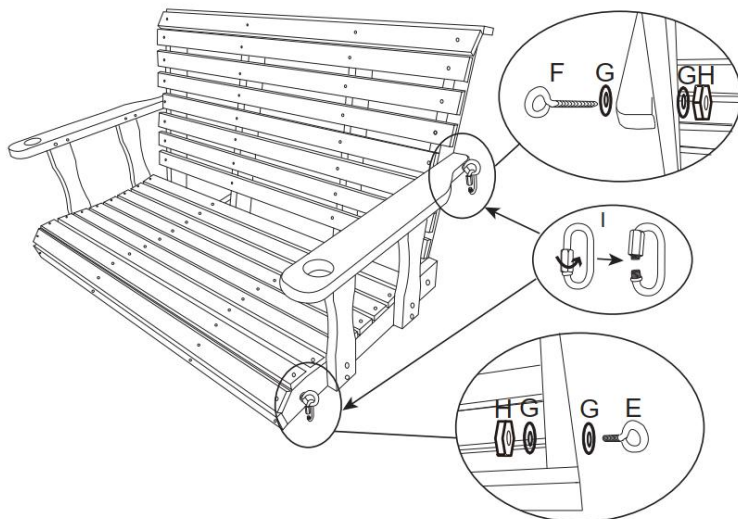

PASSO5

Le catene 6 sono collegate alle parti E ed F tramite l'anello di sospensione I, e la parte I viene serrata secondo la figura per completare l'installazione.

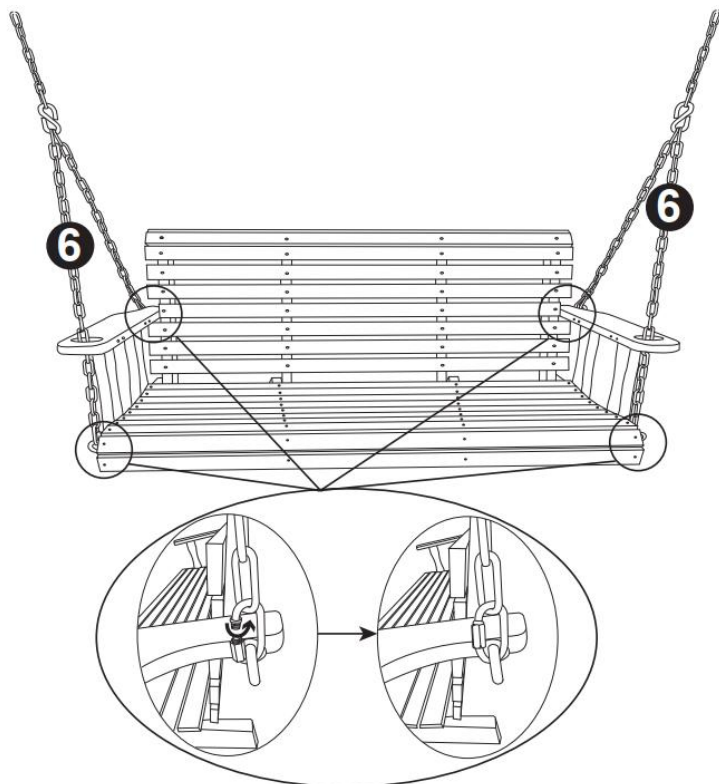

PRODUCT PARAMETER

Specifica	54*25,6 pollici (dimensione del sedile)
Dimensioni (mm)	1370*710*600
Colore	Bianco
	Colore carbonizzante
Tipo	4,5 piedi
Materiale principale	Abete della Cina

Indirizzo: Baoshanqu Shuangchenglu 803long 11hao 1602A-1609shi
Shanghai

Importato in AUS: SIHAO PTY LTD, 1 ROKEVA STREETEASTWOOD
NSW 2122 Australia

Importato negli Stati Uniti: Sanven Technology Ltd., Suite 250, 9166
Anaheim Place, Rancho Cucamonga, CA 91730



SHUNSHUN GmbH
Römeräcker 9 Z2021,76351
Linkenheim-Hochstetten, Germany
euvertreter@gmail.com
+49 1727041930



Pooledas Group Ltd
Unit 5 Albert Edward House, The
Pavilions Preston, United Kingdom
pooledas123@gmail.com
Tel: 01772418127

Made in China

VEVOR[®]

TOUGH TOOLS, HALF PRICE

Tecnico Supporto e certificato di garanzia elettronica

www.vevor.com/support

VEVOR[®]

TOUGH TOOLS, HALF PRICE

Techniczny Certyfikat wsparcia i e-gwarancji www.vevor.com/support

HUŚTAWKA P ORCH INSTRUKCJA OBSŁUGI

We continue to be committed to provide you tools with competitive price.

"Save Half", "Half Price" or any other similar expressions used by us only represents an estimate of savings you might benefit from buying certain tools with us compared to the major top brands and does not necessarily mean to cover all categories of tools offered by us. You are kindly reminded to verify carefully when you are placing an order with us if you are actually saving half in comparison with the top major brands.

VEVOR®

TOUGH TOOLS, HALF PRICE

PORCH SWING

MODEL: YQ-117B

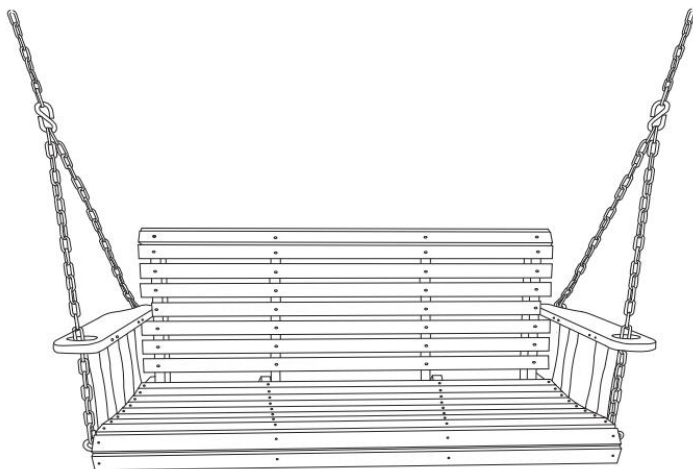

NEED HELP? CONTACT US!

Have product questions? Need technical support? Please feel free to contact us:

Technical Support and E-Warranty Certificate
www.vevor.com/support

This is the original instruction, please read all manual instructions carefully before operating. VEVOR reserves a clear interpretation of our user manual. The appearance of the product shall be subject to the product you received. Please forgive us that we won't inform you again if there are any technology or software updates on our product.

SAFETY INSTRUCTIONS

OSTRZEŻENIE:

Przeczytaj uważnie niniejszą instrukcję przed użyciem tego produktu. Niezastosowanie się do tego może spowodować poważne obrażenia.

Środki ostrożności podczas montażu











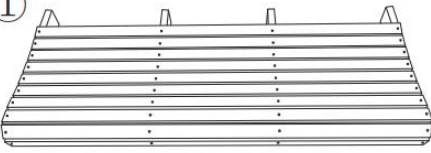

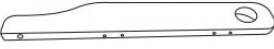

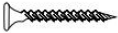

25. Montaż powinien odbywać się wyłącznie zgodnie z niniejszą instrukcją. Nieprawidłowy montaż może powodować zagrożenia.
26. Podczas montażu należy nosić okulary ochronne i wytrzymałe rękawice robocze zatwierdzone przez ANSI.
27. Utrzymuj miejsce zbiórki w czystości i dobrze oświetlone.
28. Podczas montażu trzymaj osoby postronne z dala od obszaru.
29. Nie należy montować, gdy jest się zmęczonym lub pod wpływem alkoholu, narkotyków lub leków.
30. Możliwości produktu dotyczą wyłącznie produktów prawidłowo i całkowicie zmontowanych.
31. Montaż na płaskiej, równej, twardej i gładkiej powierzchni, która może bezpiecznie podeprzeć huśtawkę werandową.
32. Dodatkowe informacje dotyczące części wymienionych na kolejnych stronach można znaleźć w schemacie montażu w niniejszej instrukcji. Rozpakuj i oddziel wszystkie części w czystym miejscu pracy.

Stosuj środki ostrożności

13. Nie przekraczaj udźwigu.
14. Używaj wyłącznie na płaskiej, poziomej i twardej powierzchni, która może bezpiecznie utrzymać w pełni obciążoną huśtawkę na ganku.
15. Używaj wyłącznie zgodnie z przeznaczeniem.
16. Sprawdź przed każdym użyciem; nie używać, jeśli części są luźne lub uszkodzone.

ZACHOWAJ TE INSTRUKCJE

PARTS LIST

<p>①</p>  <p>1PCS</p>	<p>②</p>  <p>1PCS</p>		
<p>③</p>  <p>1PCS</p>	<p>④</p>  <p>1PCS</p>		
<p>⑤</p>  <p>4PCS</p>	<p>⑥</p>  <p>2PCS</p>		
<p>A</p>  <p>12PCS</p>	<p>B</p>  <p>12PCS</p>	<p>C</p>  <p>12PCS</p>	<p>D</p>  <p>8PCS</p>
<p>E</p>  <p>2PCS</p>	<p>F</p>  <p>2PCS</p>	<p>G</p>  <p>8PCS</p>	<p>H</p>  <p>4PCS</p>
<p>I</p>  <p>4PCS</p>	<p>J</p>  <p>1PCS</p>	<p>K</p>  <p>1PCS</p>	

ASSEMBLY STEP

KROK 1

Zamontuj płyty wsporcze 5 na gnieździe 1 z częściami A, B i C.

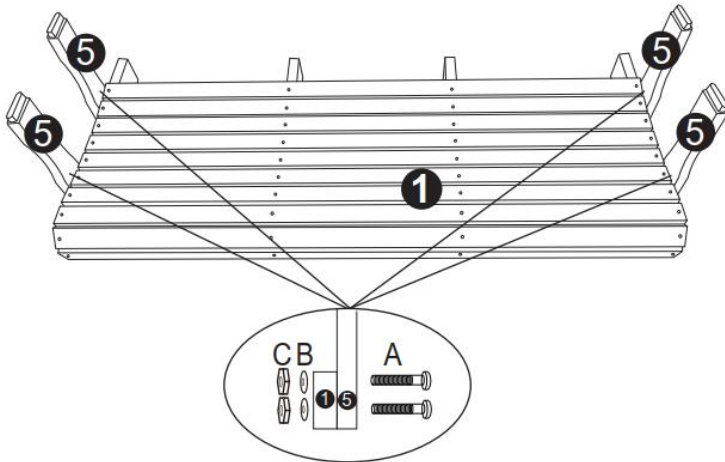

KROK 2

Zamontuj lewą i prawą poręcz 3,4 na płycie nośnej 5 i dokręć je śrubą D. Aby zamontować idealną huśtawkę, zalecamy dokręcenie D po wykonaniu kroku 3.

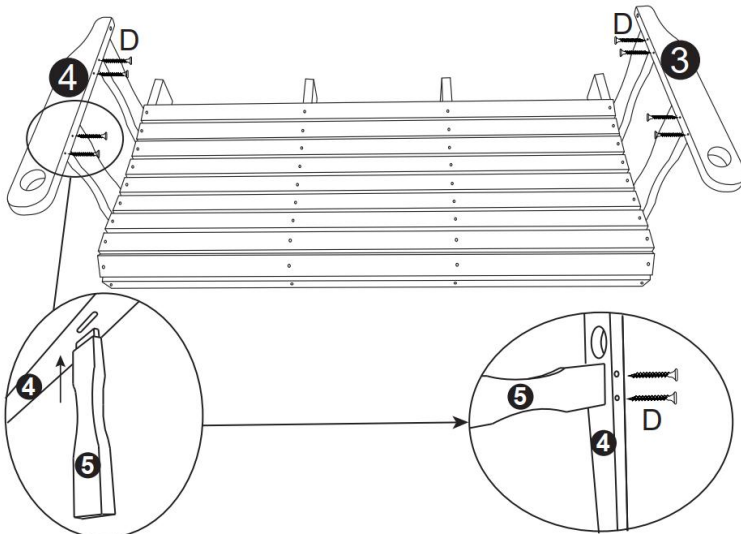

KROK 3

Połącz oparcie 2 z siedziskiem 1 za pomocą części A, B i C.

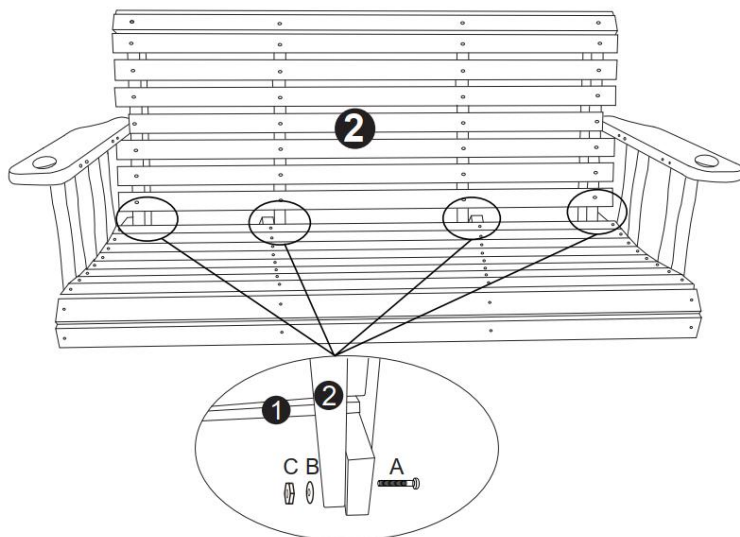

KROK 4

Połącz podłokietniki 3,4 z oparciem 2 częściami F, G, H i E, G, H z przednim otworem siedziska, zwracając uwagę, aby otwory części E i F były skierowane do przodu. Następnie części E i F powiesić odpowiednio na pierścieniu I.

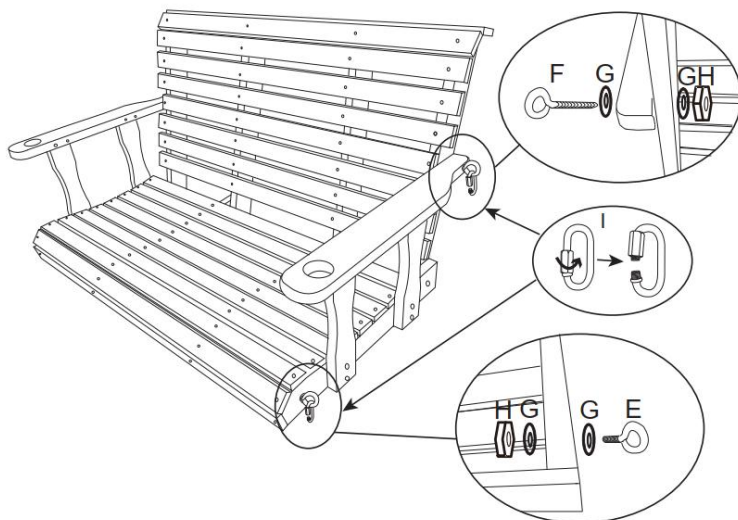

KROK 5

Łańcuchy 6 są połączone z częściami E i F poprzez pierścień do zawieszania I, a część I jest dokręcona zgodnie z rysunkiem, aby zakończyć instalację.

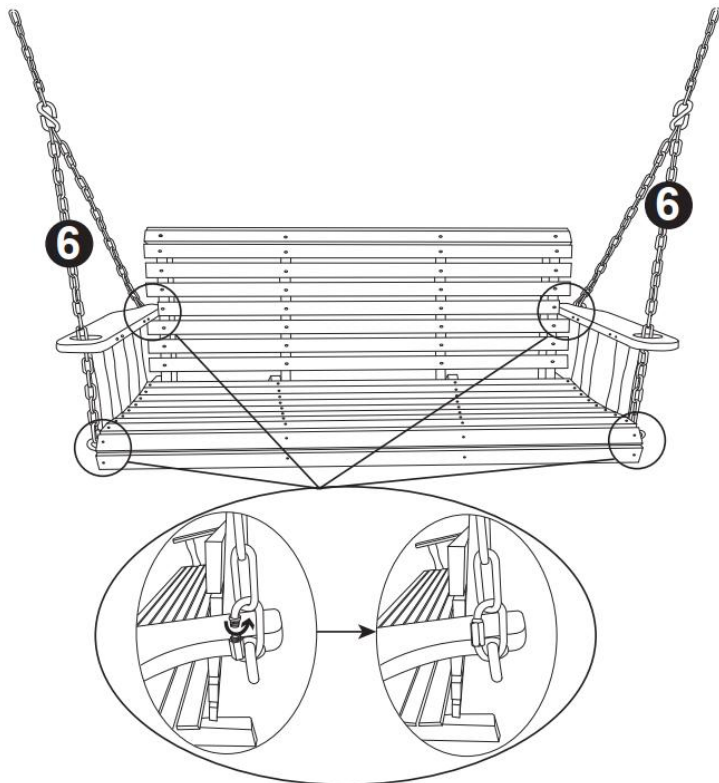

PRODUCT PARAMETER

Specyfikacja	54*25,6 cale (rozmiar siedziska)
Rozmiar (mm)	1370*710*600
Kolor	Biały
	Kolor karbonizujący
Typ	4,5 stopy
Główny materiał	Jodła chińska

Adres: Baoshanqu Shuangchenglu 803long 11hao 1602A-1609shi

Szanghaj

Import do AUS: SIHAO PTY LTD, 1 ROKEVA STREET EASTWOOD NSW
2122 Australia

Import do USA: Sanven Technology Ltd., Suite 250, 9166 Anaheim Place,
Rancho Cucamonga, CA 91730



SHUNSHUN GmbH
Römeräcker 9 Z2021,76351
Linkenheim-Hochstetten, Germany
euvertreter@gmail.com
+49 1727041930



Pooledas Group Ltd
Unit 5 Albert Edward House, The
Pavilions Preston, United Kingdom
pooledas123@gmail.com
Tel: 01772418127

Wyprodukowano w Chinach

VEVOR[®]

TOUGH TOOLS, HALF PRICE

Techniczny Certyfikat wsparcia i e-gwarancji

www.vevor.com/support

VEVOR[®]

TOUGH TOOLS, HALF PRICE

Technisch Support- und E-Garantie-Zertifikat www.vevor.com/support

VERANDA - SCHAUKEL BEDIENUNGSANLEITUNG

We continue to be committed to provide you tools with competitive price.

"Save Half", "Half Price" or any other similar expressions used by us only represents an estimate of savings you might benefit from buying certain tools with us compared to the major top brands and does not necessarily mean to cover all categories of tools offered by us. You are kindly reminded to verify carefully when you are placing an order with us if you are actually saving half in comparison with the top major brands.

VEVOR®

TOUGH TOOLS, HALF PRICE

PORCH SWING

MODELL: YQ-117B

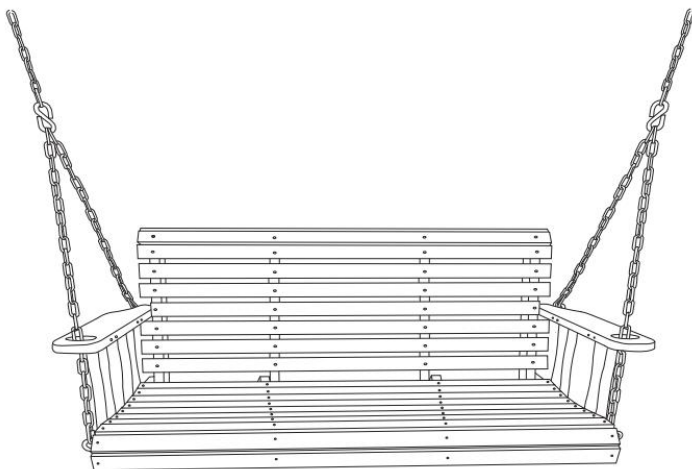

NEED HELP? CONTACT US!

Have product questions? Need technical support? Please feel free to contact us:

Technical Support and E-Warranty Certificate
www.vevor.com/support

This is the original instruction, please read all manual instructions carefully before operating. VEVOR reserves a clear interpretation of our user manual. The appearance of the product shall be subject to the product you received. Please forgive us that we won't inform you again if there are any technology or software updates on our product.

SAFETY INSTRUCTIONS

WARNUNG:

Lesen Sie diese Anweisungen sorgfältig durch, bevor Sie dieses Produkt verwenden. Andernfalls kann es zu schweren Verletzungen kommen.

Vorsichtsmaßnahmen bei der Montage











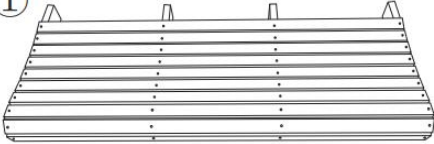



33. Der Zusammenbau sollte nur gemäß dieser Anleitung erfolgen. Durch unsachgemäße Montage können Gefahren entstehen.
34. Tragen Sie während der Montage eine ANSI-zugelassene Schutzbrille und strapazierfähige Arbeitshandschuhe.
35. Halten Sie den Montagebereich sauber und gut beleuchtet.
36. Halten Sie Unbeteiligte während der Montage vom Bereich fern.
37. Nicht aufbauen, wenn Sie müde sind oder unter dem Einfluss von Alkohol, Drogen oder Medikamenten stehen.
38. Die Produkteigenschaften gelten nur für ordnungsgemäß und vollständig montierte Produkte.
39. Montage auf einer flachen, ebenen, harten und glatten Oberfläche, die die Hollywoodschaukel sicher tragen kann.
40. Weitere Informationen zu den auf den folgenden Seiten aufgeführten Teilen finden Sie im Montagediagramm dieser Anleitung. Packen Sie alle Teile aus und trennen Sie sie an einem sauberen Arbeitsplatz.

Treffen Sie Vorsichtsmaßnahmen

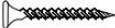
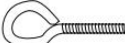
17. Überschreiten Sie nicht die Gewichtskapazität.
18. Nur auf einer flachen, ebenen und harten Oberfläche verwenden, die eine voll beladene Hollywoodschaukel sicher tragen kann.
19. Nur bestimmungsgemäß verwenden.
20. Vor jedem Gebrauch prüfen; Nicht verwenden, wenn Teile lose oder beschädigt sind.

ANLEITUNG AUFBEWAHREN

PARTS LIST

 <p>1</p> <p style="text-align: center;">1PCS</p>	 <p>2</p> <p style="text-align: center;">1PCS</p>		
 <p>3</p> <p style="text-align: center;">1PCS</p>	 <p>4</p> <p style="text-align: center;">1PCS</p>		
 <p>5</p> <p style="text-align: center;">4PCS</p>	 <p>6</p> <p style="text-align: center;">2PCS</p>		
<p>A</p>  <p style="text-align: center;">12PCS</p>	<p>B</p>  <p style="text-align: center;">12PCS</p>	<p>C</p>  <p style="text-align: center;">12PCS</p>	<p>D</p>  <p style="text-align: center;">8PCS</p>
<p>E</p>  <p style="text-align: center;">2PCS</p>	<p>F</p>  <p style="text-align: center;">2PCS</p>	<p>G</p>  <p style="text-align: center;">8PCS</p>	<p>H</p>  <p style="text-align: center;">4PCS</p>
<p>I</p>  <p style="text-align: center;">4PCS</p>	<p>J</p>  <p style="text-align: center;">1PCS</p>	<p>K</p>  <p style="text-align: center;">1PCS</p>	

ASSEMBLY STEP

SCHRITT 1

Stützplatten 5 am Sitz 1 mit den Teilen A, B und C montieren.

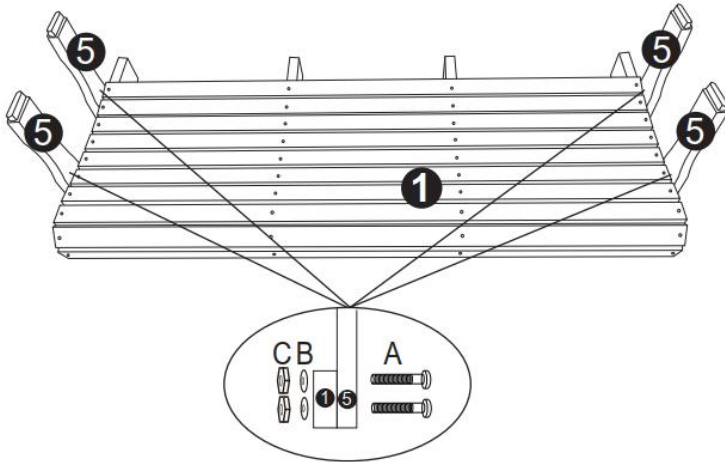

SCHRITT 2

Montieren Sie den linken und rechten Handlauf 3,4 auf der Stützplatte 5 und ziehen Sie sie mit der Schraube D fest. Um eine perfekte Schaukel zu installieren, empfehlen wir Ihnen, D nach Abschluss von Schritt 3 festzuziehen.

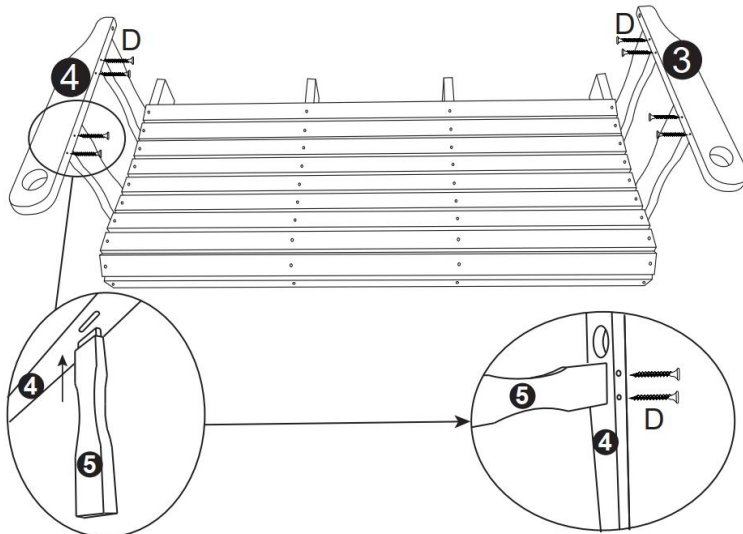

SCHRITT 3

Verbinden Sie die Rückenlehne 2 mit dem Sitz 1 mit den Teilen A, B und C.

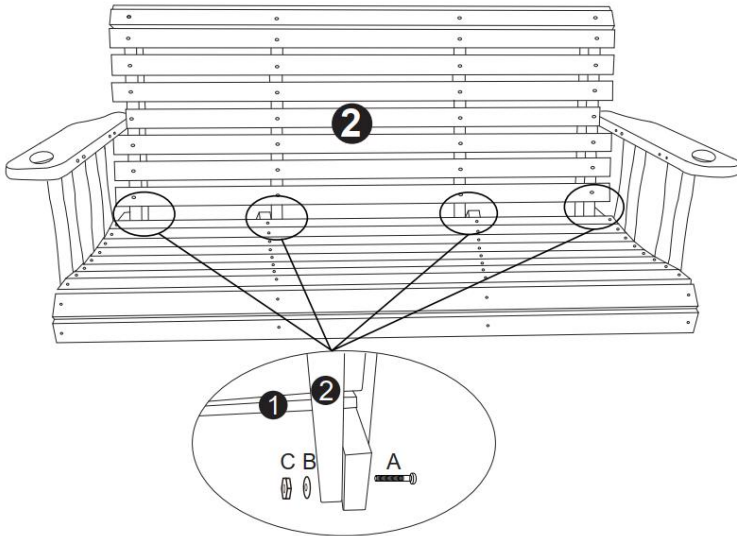

SCHRITT 4

Verbinden Sie die Armlehnen 3,4 mit der Rückenlehne 2, wobei die Teile F,G,H und E,G,H mit dem vorderen Loch des Sitzes verbunden werden. Achten Sie dabei darauf, dass die Löcher der Teile E und F nach vorne zeigen. Dann hängen Teil E und F den Ring I jeweils ein.

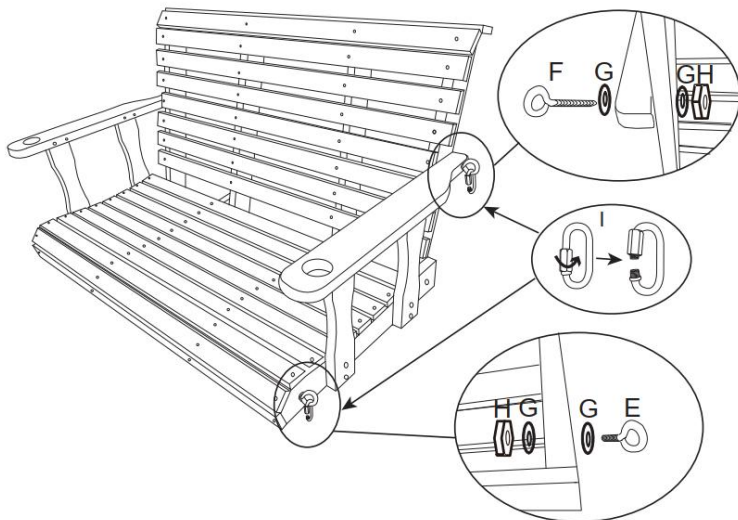

SCHRITT5

Die Ketten 6 werden über den Aufhänger I mit den Teilen E und F verbunden und Teil I wird gemäß der Abbildung festgezogen, um die Installation abzuschließen.

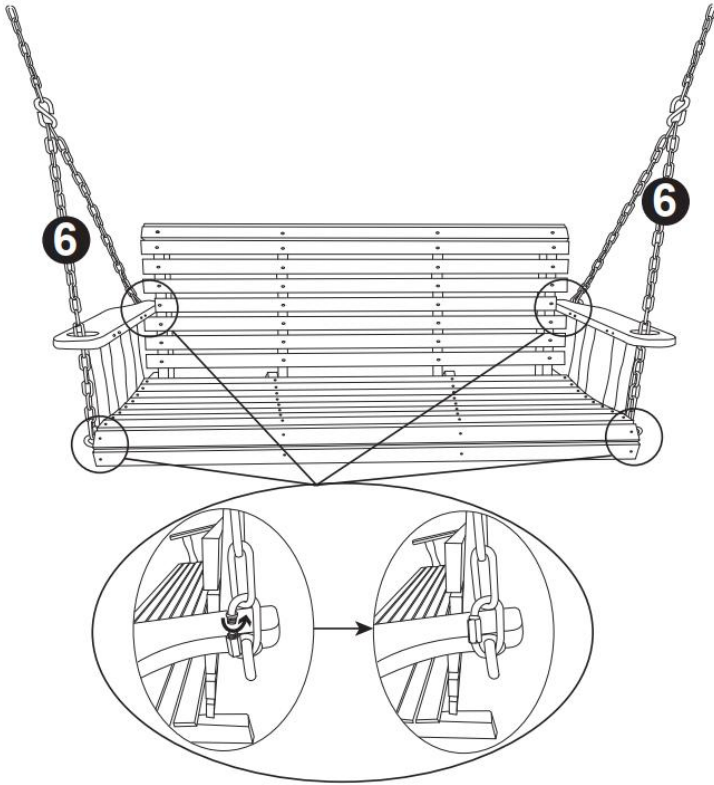

PRODUCT PARAMETER

Spezifikation	54*25,6 Zoll (Sitzgröße)
Größe (mm)	1370*710*600
Farbe	Wei
	Karbonisierende Farbe
Typ	4,5 Fu
Hauptmaterial	China-Tanne

Adresse: Baoshanqu Shuangchenglu 803long 11hao 1602A-1609shi
Shanghai

Importiert nach AUS: SIHAO PTY LTD, 1 ROKEVA STREETEASTWOOD

NSW 2122 Australien

In die USA importiert: Sanven Technology Ltd., Suite 250, 9166 Anaheim Place, Rancho Cucamonga, CA 91730



SHUNSHUN GmbH
Römeräcker 9 Z2021,76351
Linkenheim-Hochstetten, Germany
euvertreter@gmail.com
+49 1727041930



Pooledas Group Ltd
Unit 5 Albert Edward House, The Pavilions Preston, United Kingdom
pooledas123@gmail.com
Tel: 01772418127

In China hergestellt

VEVOR[®]

TOUGH TOOLS, HALF PRICE

Technisch Support- und E-Garantiezertifikat

www.vevor.com/support

VEVOR[®]

TOUGH TOOLS, HALF PRICE

Technique Assistance et certificat de garantie électronique

www.vevor.com/support

BALANÇOIRE DE PORCHE MANUEL D'UTILISATION

We continue to be committed to provide you tools with competitive price.

"Save Half", "Half Price" or any other similar expressions used by us only represents an estimate of savings you might benefit from buying certain tools with us compared to the major top brands and does not necessarily mean to cover all categories of tools offered by us. You are kindly reminded to verify carefully when you are placing an order with us if you are actually saving half in comparison with the top major brands.

VEVOR®

TOUGH TOOLS, HALF PRICE

PORCH SWING

MODÈLE : YQ-117B

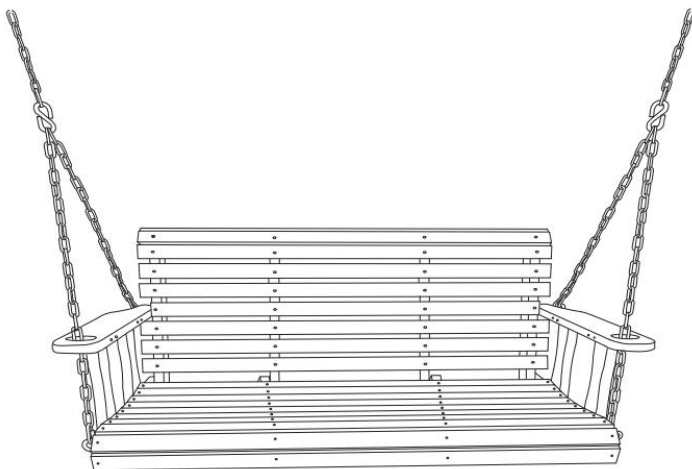

NEED HELP? CONTACT US!

Have product questions? Need technical support? Please feel free to contact us:

Technical Support and E-Warranty Certificate
www.vevor.com/support

This is the original instruction, please read all manual instructions carefully before operating. VEVOR reserves a clear interpretation of our user manual. The appearance of the product shall be subject to the product you received. Please forgive us that we won't inform you again if there are any technology or software updates on our product.

SAFETY INSTRUCTIONS

AVERTISSEMENT:

Lisez attentivement ces instructions avant d'utiliser ce produit. Ne pas le faire peut entraîner des blessures graves.

Précautions de montage







41. L'assemblage doit uniquement être effectué conformément à ces instructions. Un assemblage incorrect peut entraîner des dangers.
42. Portez des lunettes de sécurité approuvées par l'ANSI et des gants de travail robustes pendant l'assemblage.
43. Gardez la zone de rassemblement propre et bien éclairée.
44. Gardez les spectateurs hors de la zone pendant l'assemblage.
45. Ne vous rassemblez pas lorsque vous êtes fatigué ou sous l'influence de l'alcool, de drogues ou de médicaments.
46. Les capacités du produit s'appliquent uniquement aux produits correctement et complètement assemblés.
47. Assemblage sur une surface plane, de niveau, dure et lisse, capable de supporter la balancelle en toute sécurité.
48. Pour plus d'informations concernant les pièces répertoriées dans les pages suivantes, veuillez vous référer au schéma d'assemblage de ce manuel. Déballez et séparez toutes les pièces dans une zone de travail propre.



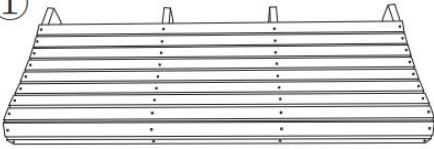





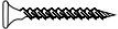

Utiliser des précautions

21. Ne dépassez pas les capacités de poids.
22. Utiliser uniquement sur une surface plane, nivelée et dure, capable de supporter en toute sécurité une balançoire de porche entièrement chargée.
23. Utiliser uniquement comme prévu.
24. Inspectez avant chaque utilisation ; ne pas utiliser si les pièces sont desserrées ou endommagées.

CONSERVEZ CES INSTRUCTIONS

PARTS LIST

 1 1PCS	 2 1PCS
 3 1PCS	 4 1PCS
 5 4PCS	 6 2PCS

A  12PCS	B  12PCS	C  12PCS	D  8PCS
E  2PCS	F  2PCS	G  8PCS	H  4PCS
I  4PCS	J  1PCS	K  1PCS	

ASSEMBLY STEP

ÉTAPE 1

Installer les plaques de support 5 sur le siège 1 avec les pièces A, B et C.

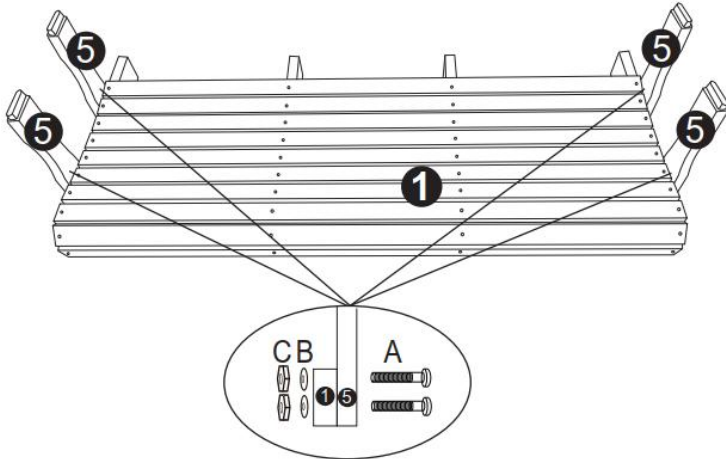

ÉTAPE 2

Installez les mains courantes gauche et droite 3,4 sur la plaque support 5 et serrez-les avec la vis D. Afin d'installer une balançoire parfaite, nous vous recommandons de serrer D après avoir terminé l'étape 3 .

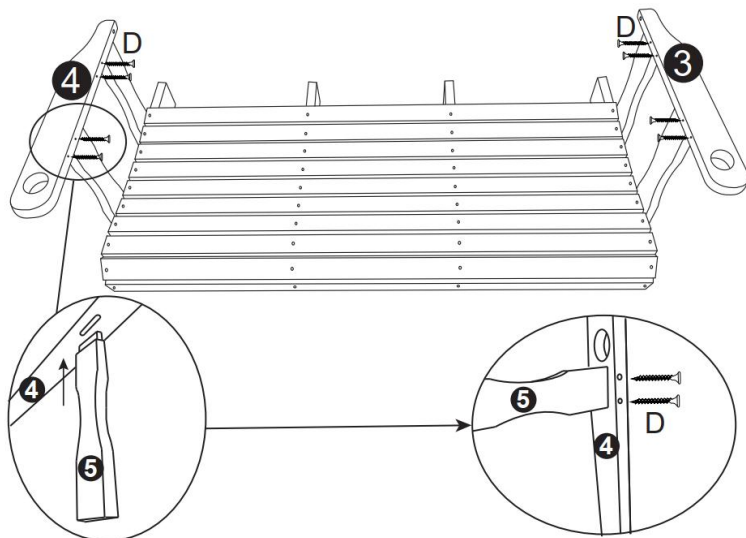

ÉTAPE 3

Connectez le dossier 2 au siège 1 avec les pièces A, B et C.

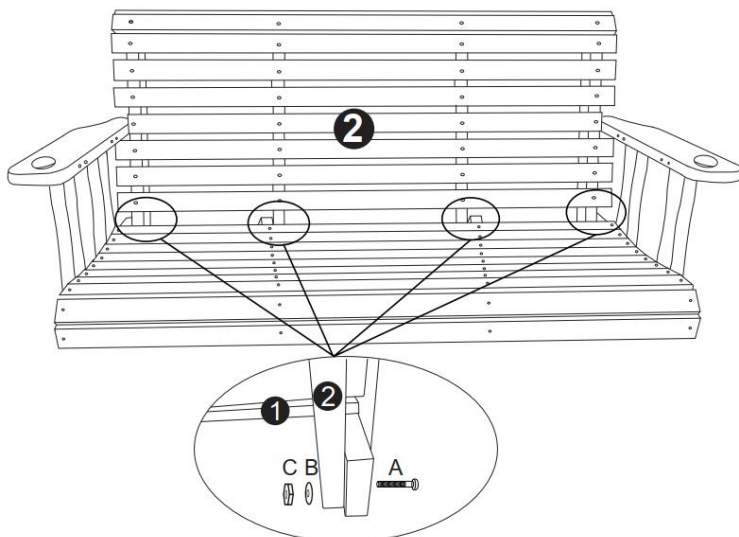

ÉTAPE 4

Connectez les accoudoirs 3,4 au dossier 2 avec les pièces F, G, H et E, G, H au trou avant du siège en notant que les trous des pièces E et F sont orientés vers l'avant. Ensuite, les parties E et F accrochent respectivement l'anneau I.

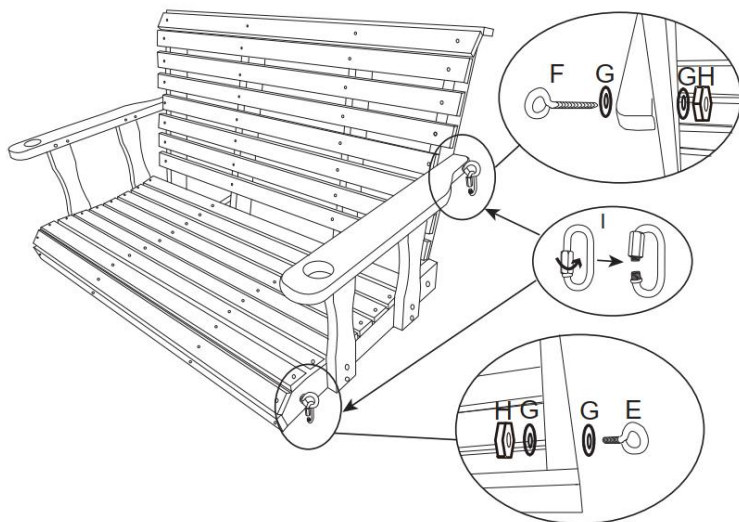

ÉTAPE5

Les chaînes 6 sont reliées aux pièces E et F via l'anneau de suspension I, et la pièce I est serrée selon la figure pour terminer l'installation.

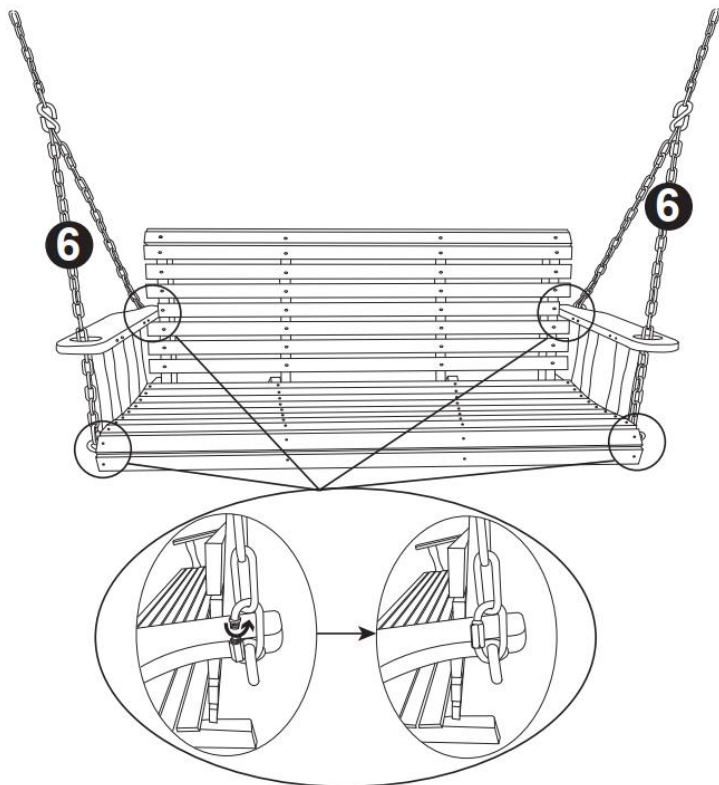

PRODUCT PARAMETER

spécification	54*25.6 pouces (taille du siège)
Taille (mm)	1370*710*600
Couleur	Blanc
	Couleur carbonisante
Taper	4,5 pieds
Matériau principal	Sapin de Chine

Adresse : Baoshanqu Shuangchenglu 803long 11hao 1602A-1609shi
Shanghai

Importé en Australie : SIHAO PTY LTD, 1 ROKEVA STREETASTWOOD

NSW 2122 Australie

Importé aux États-Unis : Sanven Technology Ltd., Suite 250, 9166
Anaheim Place, Rancho Cucamonga, CA 91730



SHUNSHUN GmbH
Römeräcker 9 Z2021,76351
Linkenheim-Hochstetten, Germany
euvertreter@gmail.com
+49 1727041930



Pooledas Group Ltd
Unit 5 Albert Edward House, The
Pavilions Preston, United Kingdom
pooledas123@gmail.com
Tel: 01772418127

Fabriqué en Chine

VEVOR[®]

TOUGH TOOLS, HALF PRICE

Technique Assistance et certificat de garantie électronique

www.vevor.com/support

VEVOR[®]

TOUGH TOOLS, HALF PRICE

Technisch Ondersteuning en e-garantiecertificaat www.vevor.com/support

VERANDASCHOMMEL GEBRUIKERSHANDLEIDING _ _

We continue to be committed to provide you tools with competitive price.

"Save Half", "Half Price" or any other similar expressions used by us only represents an estimate of savings you might benefit from buying certain tools with us compared to the major top brands and does not necessarily mean to cover all categories of tools offered by us. You are kindly reminded to verify carefully when you are placing an order with us if you are actually saving half in comparison with the top major brands.

VEVOR®

TOUGH TOOLS, HALF PRICE

PORCH SWING

MODEL: YQ-117B

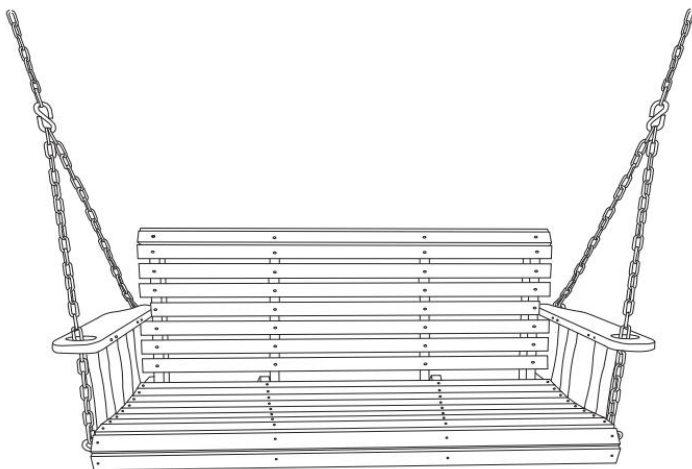

NEED HELP? CONTACT US!

Have product questions? Need technical support? Please feel free to contact us:

Technical Support and E-Warranty Certificate
www.vevor.com/support

This is the original instruction, please read all manual instructions carefully before operating. VEVOR reserves a clear interpretation of our user manual. The appearance of the product shall be subject to the product you received. Please forgive us that we won't inform you again if there are any technology or software updates on our product.

SAFETY INSTRUCTIONS

WAARSCHUWING:

Lees deze instructies zorgvuldig door voordat u dit product gebruikt. Als u dit niet doet, kan dit leiden tot ernstig letsel.

Voorzorgsmaatregelen voor montage

49. Alleen de montage dient volgens deze instructies te gebeuren.

Onjuiste montage kan tot gevaren leiden.

50. Draag tijdens de montage een ANSI-goedgekeurde veiligheidsbril en stevige werkhandschoenen.

51. Houd de verzamelplaats schoon en goed verlicht.

52. Houd omstanders tijdens de montage uit de buurt.

53. Niet monteren als u moe bent of onder invloed bent van alcohol, drugs of medicijnen.

54. De productmogelijkheden zijn alleen van toepassing op correct en volledig gemonteerde producten.

55. Monteer op een vlakke, vlakke, harde en gladde ondergrond die de schommelbank veilig kan ondersteunen.

56. Voor aanvullende informatie over de onderdelen die op de volgende pagina's worden vermeld, verwijzen wij u naar het montageschema van deze handleiding. Pak alle onderdelen uit en scheid ze van elkaar op een schone werkplek.

Gebruik voorzorgsmaatregelen

25. Overschrijd de gewichtscapaciteiten niet.







26. Uitsluitend gebruiken op een vlakke, vlakke en harde ondergrond die een volledig beladen schommelbank veilig kan ondersteunen.



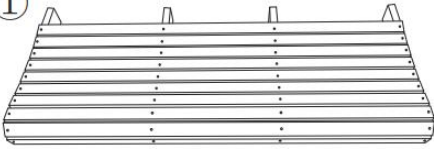





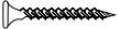

27. Alleen gebruiken zoals bedoeld.

28. Inspecteer vóór elk gebruik; niet gebruiken als onderdelen los of beschadigd zijn.

BEWAAR DEZE INSTRUCTIES

PARTS LIST

 <p>1</p> <p>1PCS</p>	 <p>2</p> <p>1PCS</p>
 <p>3</p> <p>1PCS</p>	 <p>4</p> <p>1PCS</p>
 <p>5</p> <p>4PCS</p>	 <p>6</p> <p>2PCS</p>

 <p>A</p> <p>12PCS</p>	 <p>B</p> <p>12PCS</p>	 <p>C</p> <p>12PCS</p>	 <p>D</p> <p>8PCS</p>
 <p>E</p> <p>2PCS</p>	 <p>F</p> <p>2PCS</p>	 <p>G</p> <p>8PCS</p>	 <p>H</p> <p>4PCS</p>
 <p>I</p> <p>4PCS</p>	 <p>J</p> <p>1PCS</p>	 <p>K</p> <p>1PCS</p>	

ASSEMBLY STEP

STAP 1

Installeer steunplaten 5 op stoel 1 met onderdelen A, B en C.

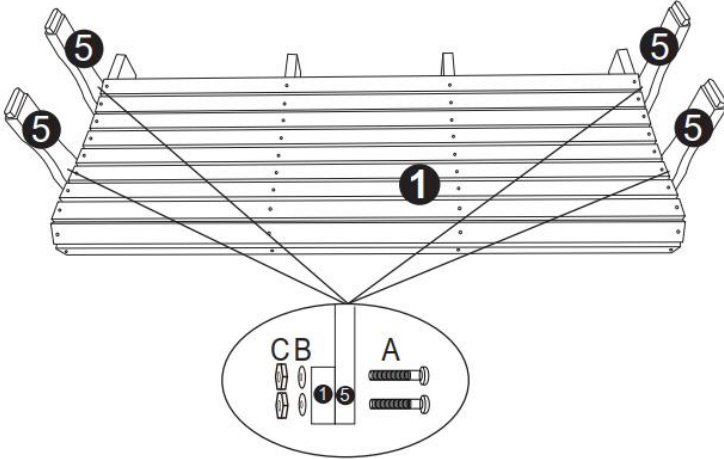

STAP 2

Monteer de linker en rechter leuningen 3,4 op de steunplaat 5 en draai ze vast met schroef D. Om een perfecte schommel te installeren, raden wij u aan om D na het voltooiën van stap 3 vast te draaien .

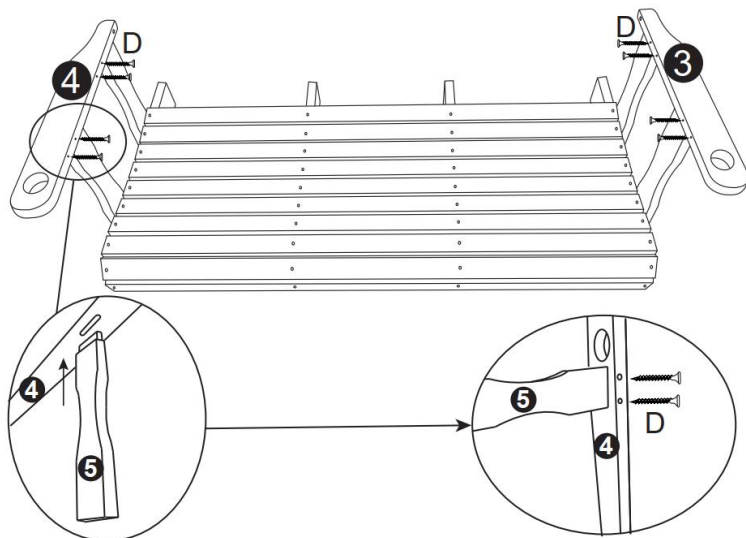

STAP 3

Verbind de rugleuning 2 met de zitting 1 met delen A, B en C.

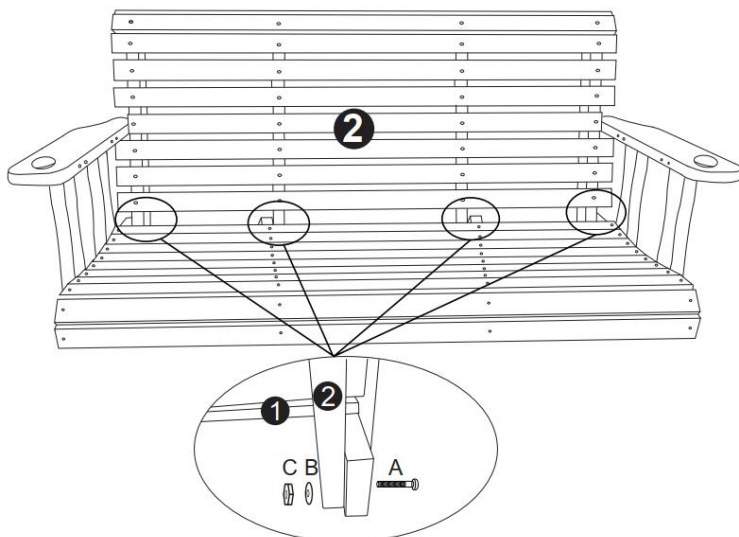

STAP 4

Sluit de arMLEUNINGEN 3,4 aan op de rugleuning 2 met de onderdelen F,G,H en E,G,H aan het voorste gat van de stoel, waarbij u erop let dat de gaten van de onderdelen E en F naar voren wijzen. Vervolgens hangen onderdeel E en F ring I

respectievelijk aan.

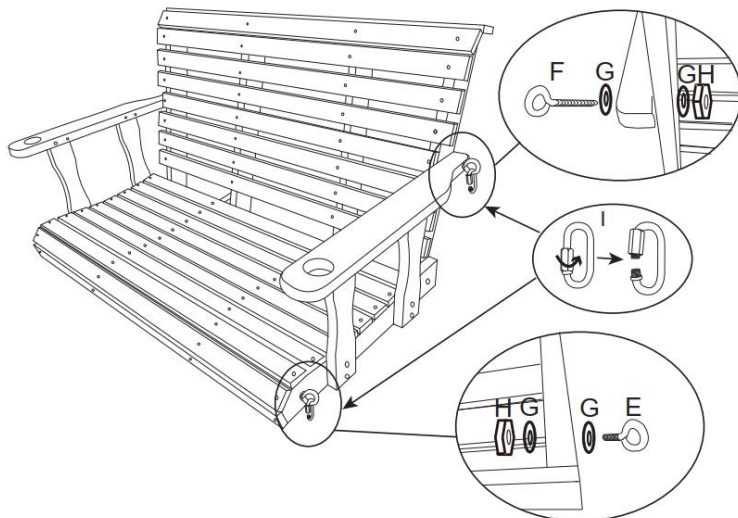

STAP 5

Kettingen 6 zijn verbonden met delen E en F via ophangring I, en deel I wordt vastgezet volgens de figuur om de installatie te voltooien.

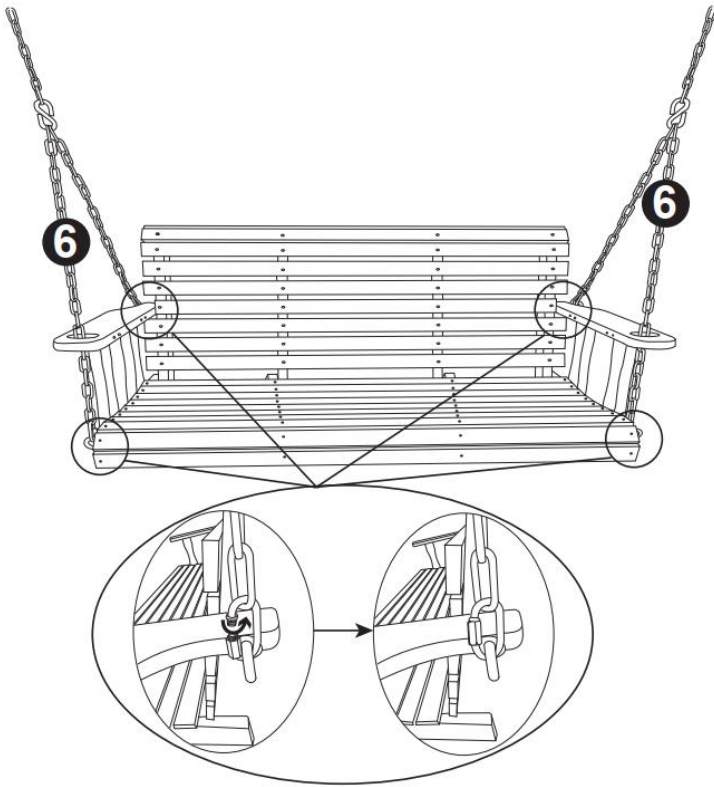

PRODUCT PARAMETER

Specificatie	54*25,6 inch (zitmaat)
Grootte (mm)	1370*710*600
Kleur	Wit
	Carboniserende kleur
Vriendelijk	4,5ft
Hoofd materiaal	Chinese spar

Adres: Baoshanqu Shuangchenglu 803long 11hao 1602A-1609shi
Shanghai

Geïmporteerd naar AUS: SIHAO PTY LTD, 1 ROKEVA

STREETEASTWOOD NSW 2122 Australië

Geïmporteerd naar de VS: Sanven Technology Ltd., Suite 250, 9166
Anaheim Place, Rancho Cucamonga, CA 91730



SHUNSHUN GmbH
Römeräcker 9 Z2021,76351
Linkenheim-Hochstetten, Germany
euvertreter@gmail.com
+49 1727041930



Pooledas Group Ltd
Unit 5 Albert Edward House, The
Pavilions Preston, United Kingdom
pooledas123@gmail.com
Tel: 01772418127

Gemaakt in China

VEVOR[®]

TOUGH TOOLS, HALF PRICE

Technisch Ondersteuning en e-garantiecertificaat

www.vevor.com/support

VEVOR[®]

TOUGH TOOLS, HALF PRICE

Teknisk Support och e-garanticertifikat www.vevor.com/support

P ORCH SWING ANVÄNDARMANUAL

We continue to be committed to provide you tools with competitive price.

"Save Half", "Half Price" or any other similar expressions used by us only represents an estimate of savings you might benefit from buying certain tools with us compared to the major top brands and does not necessarily mean to cover all categories of tools offered by us. You are kindly reminded to verify carefully when you are placing an order with us if you are actually saving half in comparison with the top major brands.

VEVOR®

TOUGH TOOLS, HALF PRICE

PORCH SWING

MODELL: YQ-117B

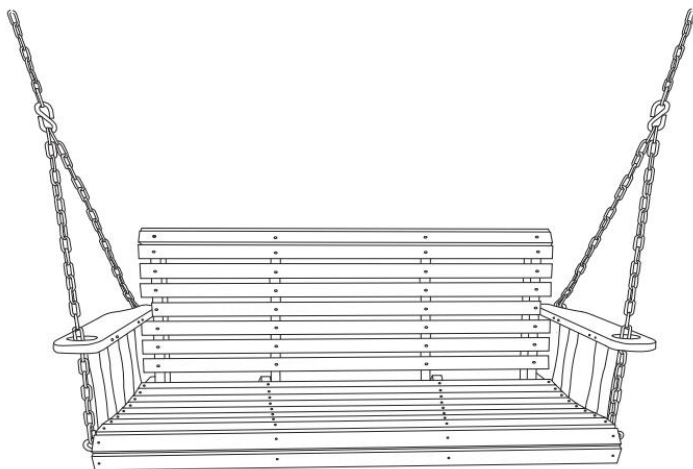

NEED HELP? CONTACT US!

Have product questions? Need technical support? Please feel free to contact us:

Technical Support and E-Warranty Certificate
www.vevor.com/support

This is the original instruction, please read all manual instructions carefully before operating. VEVOR reserves a clear interpretation of our user manual. The appearance of the product shall be subject to the product you received. Please forgive us that we won't inform you again if there are any technology or software updates on our product.

SAFETY INSTRUCTIONS

VARNING:

Läs dessa instruktioner noggrant innan du använder denna produkt. Underlåtenhet att göra det kan resultera i allvarliga skador.

Försiktighetsåtgärder vid montering











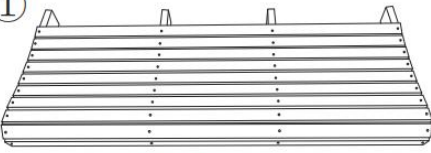

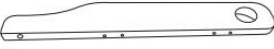

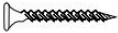

57. Endast montering ska ske enligt dessa instruktioner. Felaktig montering kan leda till faror.
58. Använd ANSI-godkända skyddsglasögon och kraftiga arbetshandskar vid montering.
59. Håll monteringsområdet rent och väl upplyst.
60. Håll åskådare borta från området under monteringen.
61. Sätt dig inte ihop när du är trött eller påverkad av alkohol, droger eller mediciner.
62. Produktegenskaperna gäller endast för korrekt och färdigmonterade produkter.
63. Montera på en plan, jämn, hård och slät yta som säkert kan stödja verandagungan.
64. För ytterligare information om delarna som listas på följande sidor, se monteringsdiagrammet i denna manual. Packa upp och separera alla delar på ett rent arbetsområde.

Använd försiktighetsåtgärder

29. Överskrid inte viktkapaciteten.
30. Använd endast på en plan, jämn och hård yta som säkert kan stödja en fullastad verandagunga.
31. Använd endast som avsett.
32. Inspektera före varje användning; Använd inte om delar är lösa eller skadade.

SPARA DESSA INSTRUKTIONER

PARTS LIST

<p>①</p>  <p style="text-align: center;">1PCS</p>	<p>②</p>  <p style="text-align: center;">1PCS</p>		
<p>③</p>  <p style="text-align: center;">1PCS</p>	<p>④</p>  <p style="text-align: center;">1PCS</p>		
<p>⑤</p>  <p style="text-align: center;">4PCS</p>	<p>⑥</p>  <p style="text-align: center;">2PCS</p>		
<p>A</p>  <p style="text-align: center;">12PCS</p>	<p>B</p>  <p style="text-align: center;">12PCS</p>	<p>C</p>  <p style="text-align: center;">12PCS</p>	<p>D</p>  <p style="text-align: center;">8PCS</p>
<p>E</p>  <p style="text-align: center;">2PCS</p>	<p>F</p>  <p style="text-align: center;">2PCS</p>	<p>G</p>  <p style="text-align: center;">8PCS</p>	<p>H</p>  <p style="text-align: center;">4PCS</p>
<p>I</p>  <p style="text-align: center;">4PCS</p>	<p>J</p>  <p style="text-align: center;">1PCS</p>	<p>K</p>  <p style="text-align: center;">1PCS</p>	

ASSEMBLY STEP

STEG 1

Montera stödplattor 5 på säte 1 med delarna A, B och C.

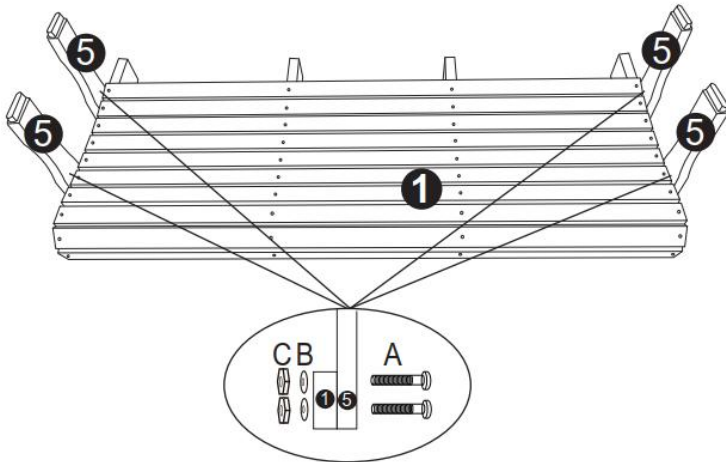

STEG 2

Montera vänster och höger ledstänger 3,4 på stödplattan 5 och dra åt dem med skruv D. För att installera en perfekt svängning rekommenderar vi att du drar åt D efter att ha slutfört steg 3 .

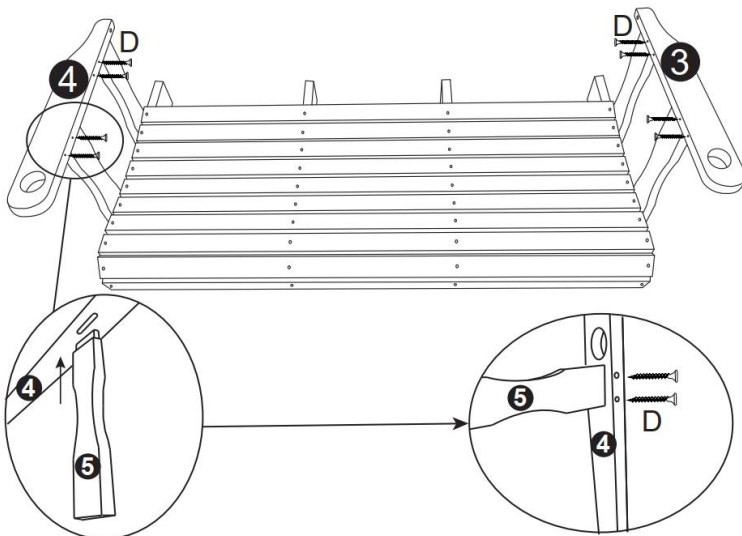

STEG 3

Anslut ryggsätet 2 till sätet 1 med delarna A, B och C.

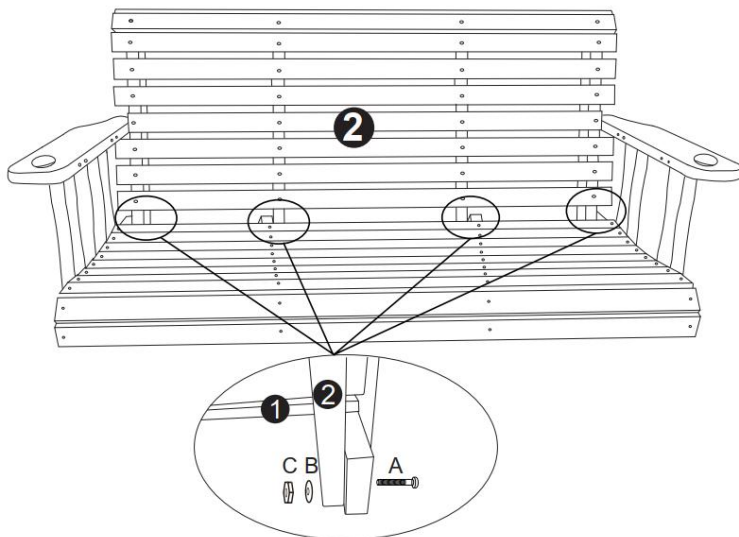

STEG 4

Anslut armstöd 3,4 till ryggsätet 2 med delarna F,G,H och E,G,H till det främre hålet på sätet och notera att hålen i delarna E och F är vända framåt. Sedan hänger del E och F ring I på respektive.

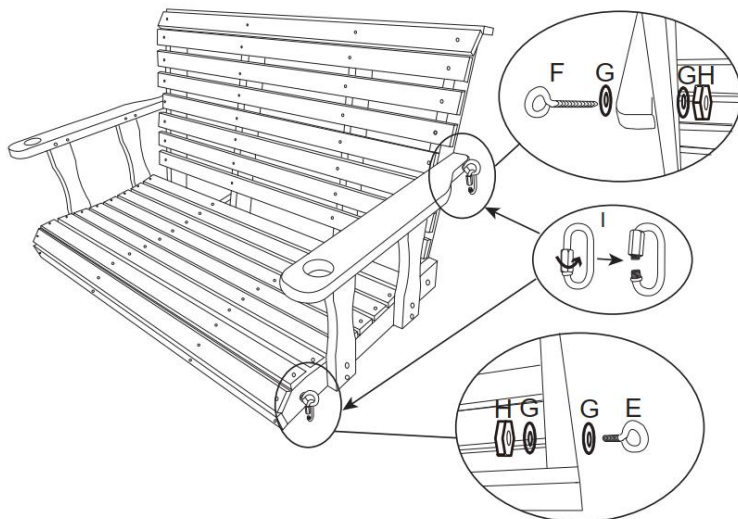

STEG 5

Kedjorna 6 är anslutna till delarna E och F genom hängringen I, och del I dras åt enligt figuren för att slutföra installationen.

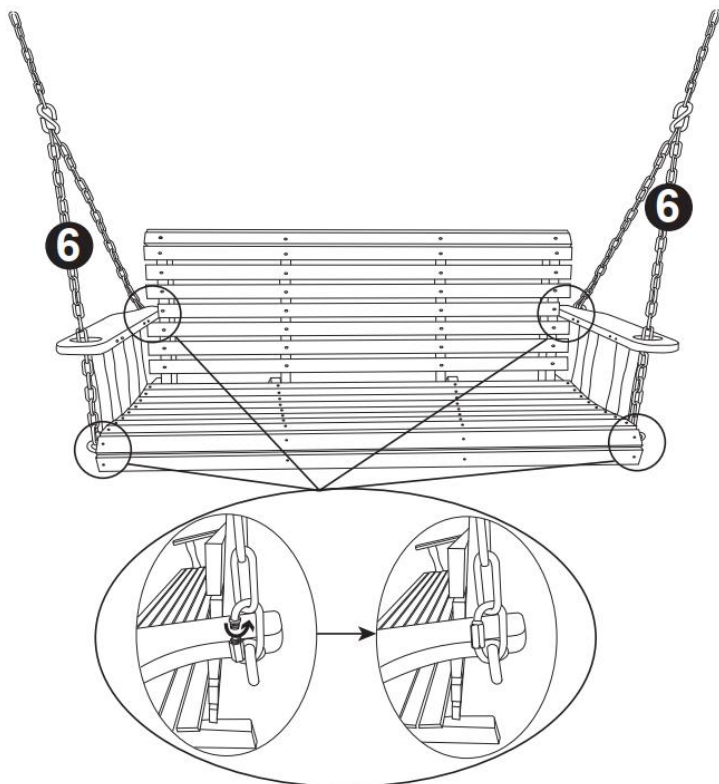

PRODUCT PARAMETER

Specifikation	54*25,6 tum (sitsstorlek)
Storlek (mm)	1370*710*600
Färg	Vit
	Karboniserande färg
Snäll	4,5 fot
Huvudmaterial	Kinagran

Adress: Baoshanqu Shuangchenglu 803long 11hao 1602A-1609shi
Shanghai

Importerad till AUS: SIHAO PTY LTD, 1 ROKEVA STREETEASTWOOD
NSW 2122 Australien

Importerad till USA: Sanven Technology Ltd., Suite 250, 9166 Anaheim
Place, Rancho Cucamonga, CA 91730



SHUNSHUN GmbH
Römeräcker 9 Z2021,76351
Linkenheim-Hochstetten, Germany
euvertreter@gmail.com
+49 1727041930



Pooledas Group Ltd
Unit 5 Albert Edward House, The
Pavilions Preston, United Kingdom
pooledas123@gmail.com
Tel: 01772418127

Tillverkad i Kina

VEVOR[®]

TOUGH TOOLS, HALF PRICE

Teknisk Support och e-garanticertifikat

www.vevor.com/support