

# **VEVOR<sup>®</sup>**

**TOUGH TOOLS, HALF PRICE**

Technical Support and E-Warranty Certificate [www.vevor.com/support](http://www.vevor.com/support)

## **HAMMOCK CHAIR**

### **USER MANUAL**

We continue to be committed to provide you tools with competitive price.

"Save Half", "Half Price" or any other similar expressions used by us only represents an estimate of savings you might benefit from buying certain tools with us compared to the major top brands and does not necessarily mean to cover all categories of tools offered by us. You are kindly reminded to verify carefully when you are placing an order with us if you are actually saving half in comparison with the top major brands.

# VEVOR<sup>®</sup>

TOUGH TOOLS, HALF PRICE

## HAMMOCK CHAIR

LYY006 /LYY007 /LYY008



### NEED HELP? CONTACT US!

Have product questions? Need technical support? Please feel free to contact us:

**Technical Support and E-Warranty Certificate**  
[www.vevor.com/support](http://www.vevor.com/support)

This is the original instruction, please read all manual instructions carefully before operating. VEVOR reserves a clear interpretation of our user manual. The appearance of the product shall be subject to the product you received. Please forgive us that we won't inform you again if there are any technology or software updates on our product.

# Safety precautions

## WARNING:

**Read this instructions** before using this product. Failure to do so can result in serious injury. the basic precautions should always be followed,including the following:











- Reconfirm that all nuts,bolts,and screws are tight and secure.
- Grease hardware and hanging points regularly.
- Check hardware and hanging points for rust which could affect their strength.

Replace if necessary.



- Check seat,air cushion,and tent for excessive wear and tear.
- Check ropes for fraying,wear,or breakage.Replace if necessary.
- Do not leave the tent swing outdoors for an extended period of time.
- In winter season,it is recommended that the tent swing is stored indoors.
- To clean,wipe down with a damp cloth.
- Store in a dry place away from direct sunlight.
- Cover or store in a bag if unused for an extended period of time.

## SAVE THESE INSTRUCTIONS

# Product List

Name	Parts	Quantity
Pod Swing		1
PVC Inflatable Cushion		1
Nylon Strap		1
Snap Hook		1
Ceiling Mount		1
Screws (For Concrete Ceiling)		4
Screws (For Wooden Ceiling)		4
Inflator		1
1/4 Round tube		4
Sponge tubes		4

# Product Parameter

Model	Body color	Hemming color	Picture	Load-bearing
LYY009	Purple powder	Blue		120lb/54kg
LYY010	Blue	Fruit green		120lb/54kg
LYY011	Fruit green	Grass green		120lb/54kg

**Please keep the air cushion inflated once every half a month.**

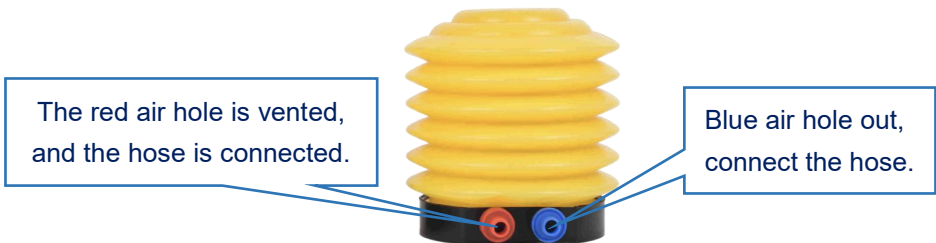

## Usage Scenario

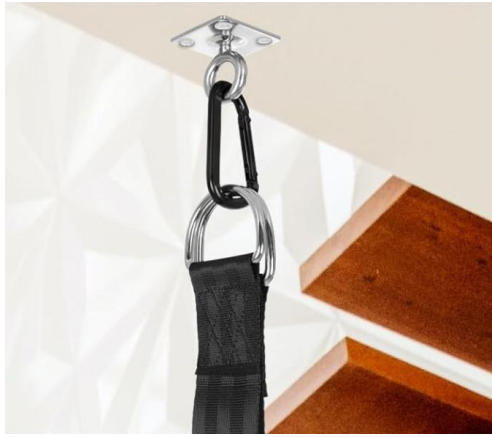

Concrete Ceiling



Wooden Ceiling



Hammock Stands



Tree

## Concrete Ceiling Installation procedure

A

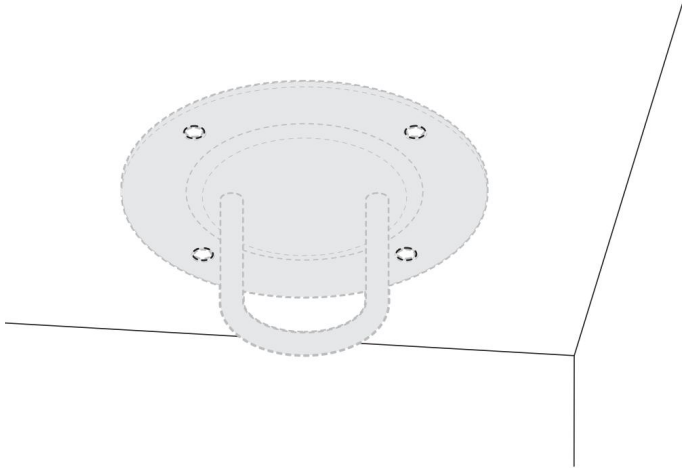

Line up the ceiling mount and use a pencil to mark the desired mounting location.

B

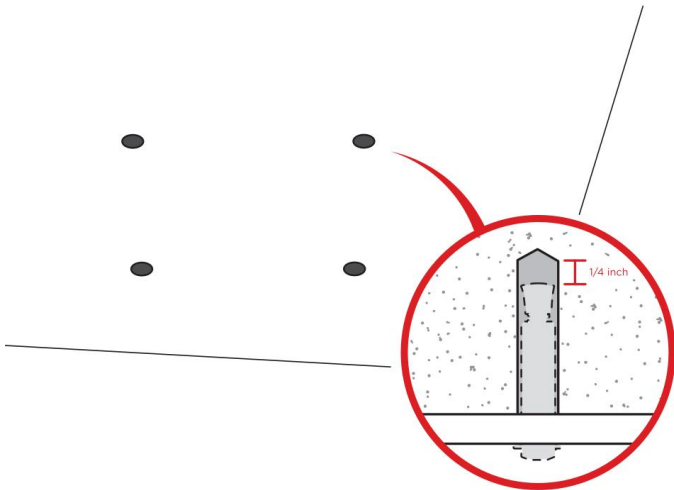

Drill four holes at the mounting location.

NOTE: Drill approximately a 1/4" deeper than the length of the sleeve anchor.

C

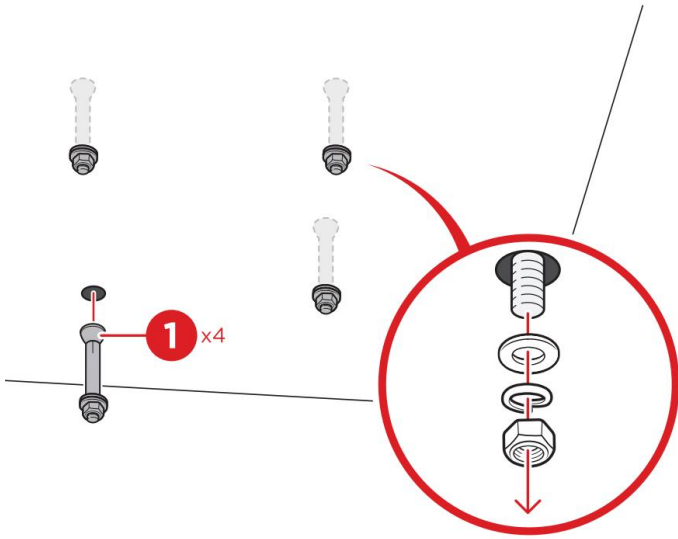

Insert four part 1 sleeve anchors into the holes. Use a hammer if necessary. Remove the nuts/washers from the sleeve anchors.

D

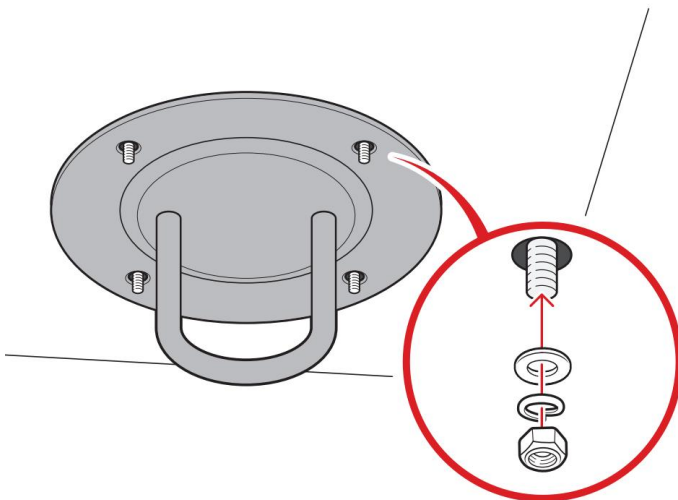

Place the mount, then tighten the nuts to secure the mount.



## Installation procedure

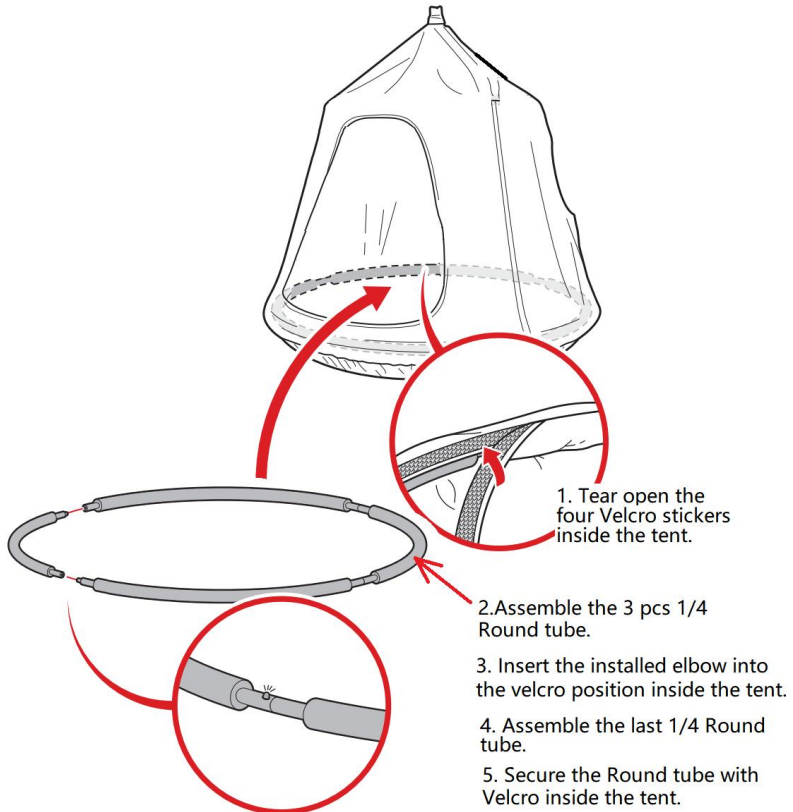

1. Inflate the cushion up to 60%~80%.
2. Pull the zipper inside the tent.
3. Tuck the air mattress into the tent.
4. Pull the zipper inside the tent.

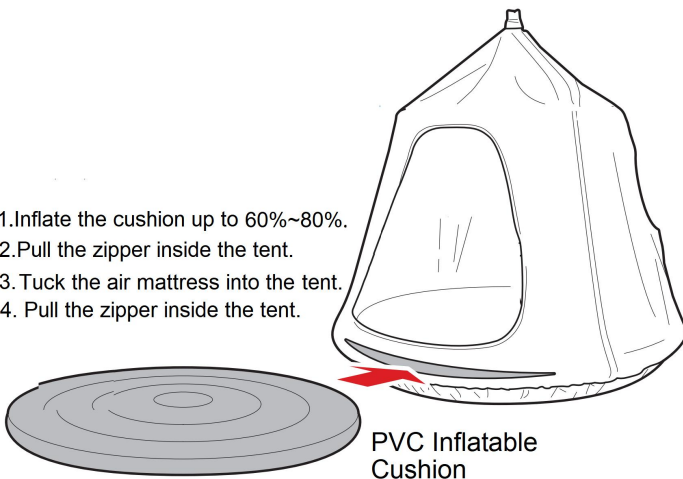

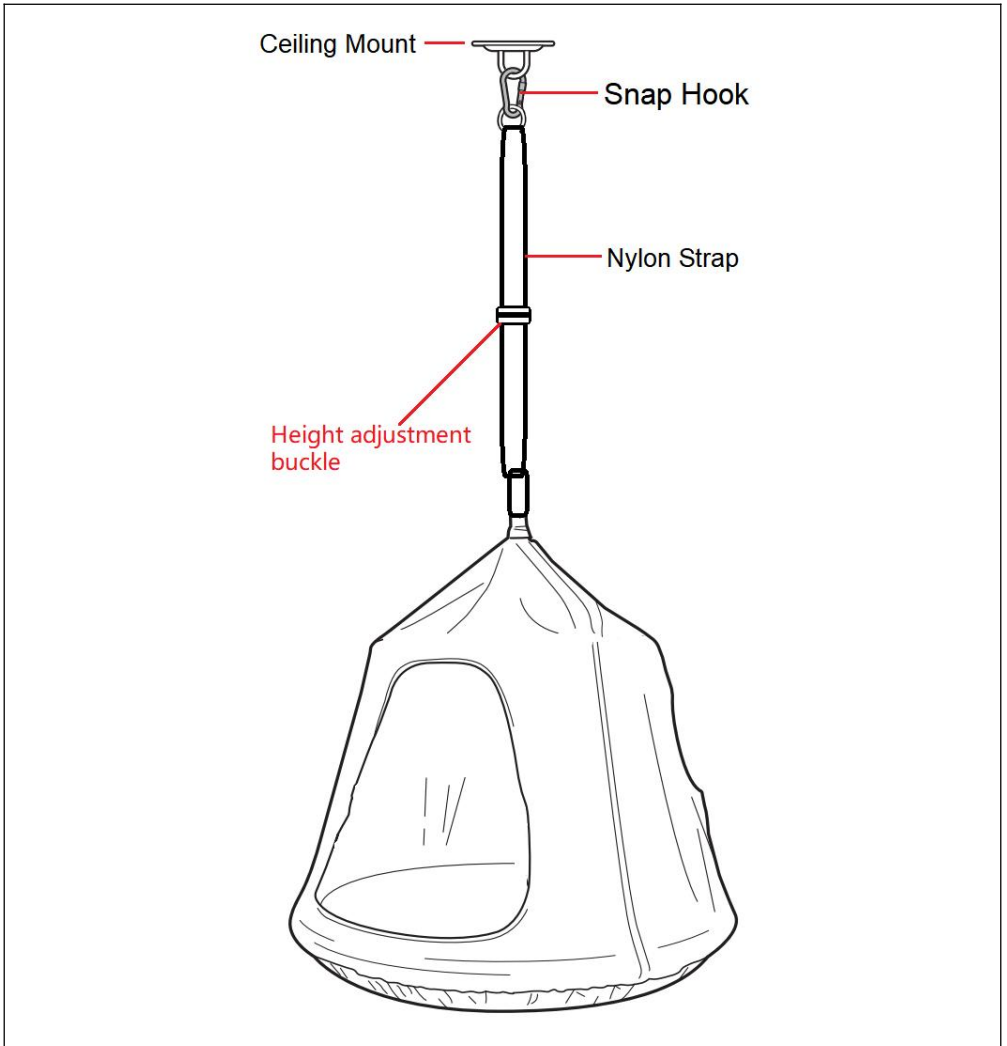

## **INSTALLATION TIPS**

- Make sure overhead structure can support a minimum of 250lbs. If hanging from a tree,diameter of tree limb should be 10 inches.
- Have adults test the overhead structure by pulling down or sitting in the swing.
- Do not install over concrete,asphalt,or hard ground.
- Swing should have a fall zone surrounding of the swing.
- Fall zone should extend a minimum of 18 inches on each side and twice the swing

height on the front/back.

- Place soft padding around the swing if ground is too hard.
- Do not use in a place with excessive sunlight. In warm weather, make sure that the tent swing surface is not too hot. Swing height should be 12 to 18 inches above the ground.
- Swing must have at least 6.5 feet of overhead and side clearance from any structure or obstruction such as a fence, garage, house, branches, wires, etc.
- Install in an area clear of wires, walls, structures, furniture, etc.

**Address:** Baoshanqu Shuangchenglu 803long 11hao 1602A-1609shi  
Shanghai

**Imported to AUS:** SIHAO PTY LTD, 1 ROKEVA STREET EASTWOOD  
NSW 2122 Australia

**Imported to USA:** Sanven Technology Ltd., Suite 250, 9166 Anaheim  
Place, Rancho Cucamonga, CA 91730



Pooledas Group Ltd  
Unit 5 Albert Edward House, The Pavilions  
Preston, United Kingdom



SHUNSHUN GmbH  
Römeräcker 9 Z2021, 76351  
Linkenheim-Hochstetten, Germany

**Made In China**

**VEVOR<sup>®</sup>**

**TOUGH TOOLS, HALF PRICE**

**Technical Support and E-Warranty Certificate**

**[www.vevor.com/support](http://www.vevor.com/support)**

# **VEVOR<sup>®</sup>**

## **TOUGH TOOLS, HALF PRICE**

Technique Assistance et certificat de garantie électronique

[www.vevor.com/support](http://www.vevor.com/support)

## **CHAISE HAMAC**

## **MANUEL DE L'UTILISATEUR**

We continue to be committed to provide you tools with competitive price.

"Save Half", "Half Price" or any other similar expressions used by us only represents an estimate of savings you might benefit from buying certain tools with us compared to the major top brands and does not necessarily mean to cover all categories of tools offered by us. You are kindly reminded to verify carefully when you are placing an order with us if you are actually saving half in comparison with the top major brands.

# VEVOR<sup>®</sup>

TOUGH TOOLS, HALF PRICE

## HAMMOCK CHAIR

LYY006 /LYY007 /LYY008



**NEED HELP? CONTACT US!**

Have product questions? Need technical support? Please feel free to contact us:

**Technical Support and E-Warranty Certificate**  
**[www.vevor.com/support](http://www.vevor.com/support)**

This is the original instruction, please read all manual instructions carefully before operating. VEVOR reserves a clear interpretation of our user manual. The appearance of the product shall be subject to the product you received. Please forgive us that we won't inform you again if there are any technology or software updates on our product.

## Précautions de sécurité

### AVERTISSEMENT:

**Lisez ces instructions** avant d'utiliser ce produit. Ne pas le faire peut entraîner des blessures graves. Les précautions de base doivent toujours être suivies, notamment les suivantes :

- Confirmez à nouveau que tous les écrous, boulons et vis sont serrés et sécurisés.
- Graissez régulièrement la quincaillerie et les points de suspension.
- Vérifiez la quincaillerie et les points de suspension pour détecter de la rouille qui pourrait affecter leur force. Remplacez si nécessaire.
- Vérifiez le siège, le coussin d'air et la tente pour détecter toute usure excessive.
- Vérifiez que les cordes ne sont pas effilochées, usées ou cassées.







Remplacez-les si nécessaire.

- Ne laissez pas la balançoire de la tente à l'extérieur pendant une période prolongée.
- En hiver, il est recommandé de ranger la balançoire de la tente à l'intérieur.
- Pour nettoyer, essuyez avec un chiffon humide.





- Conserver dans un endroit sec, à l'abri de la lumière directe du soleil.
- Couvrir ou conserver dans un sac en cas d'inutilisation pendant une période prolongée.

## CONSERVEZ CES INSTRUCTIONS



### Liste de produits

Nom	les pièces	Q uantité
Balançoire du module		1
Coussin gonflable en PVC		1
Sangle en nylon		1
Mousqueton		1
Montage au plafond		1
Des vis ( Pour plafond en béton )		4



Des vis ( Pour plafond en bois )		4
Je gonfle		1
Tube rond 1/4		4
Tubes éponge		4

## Paramètre du produit

Modèle	Couleur du corps	Couleur de l'ourlet	Photo _	Portant _
<b>LYY009</b>	Poudre violette	Bleu		1 20 lb / 54 kg
<b>LYY010</b>	Bleu	Fruit vert		1 20 lb / 54 kg

<p><b>LYY011</b></p>	<p>Fruit vert</p>	<p>Vert herbe</p>		<p>1 20 lb / 54 kg</p>
----------------------	-------------------	-------------------	--	----------------------------

**Veillez garder le coussin d'air gonflé une fois tous les six mois.**

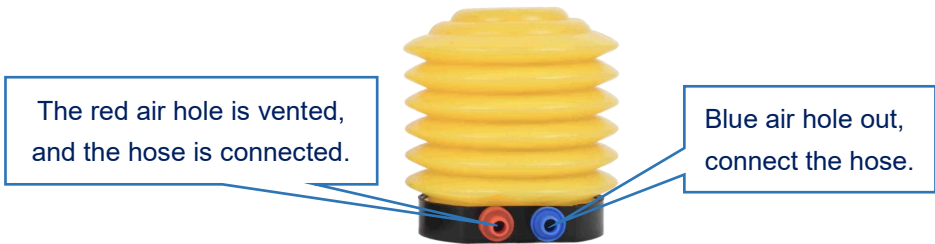

### Scénario U sage S

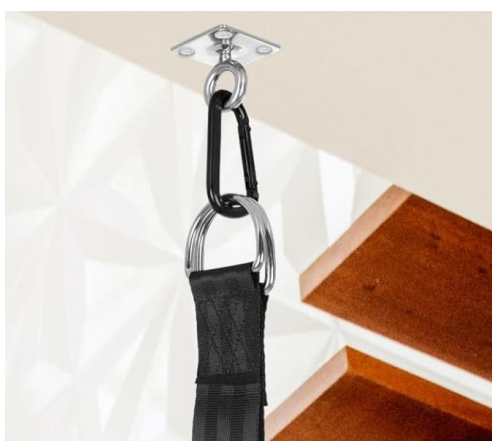

Plafond en béton



Plafond en bois



Supports pour hamacs



Arbre

## Procédure d'installation du plafond en béton

UN

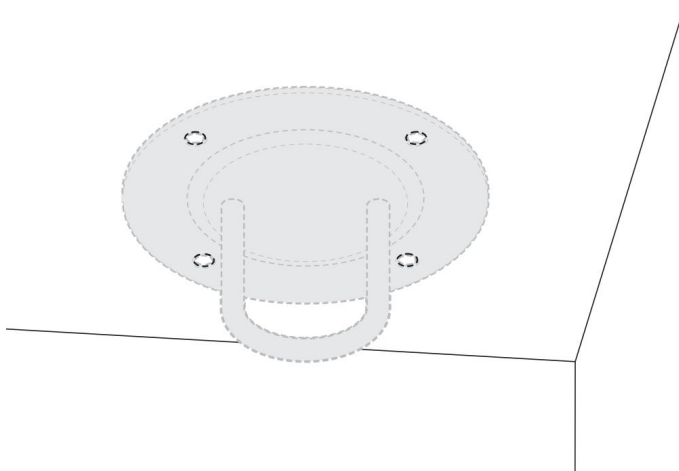

Alignez le support de plafond et utilisez un crayon pour marquer l'emplacement de montage souhaité.

B

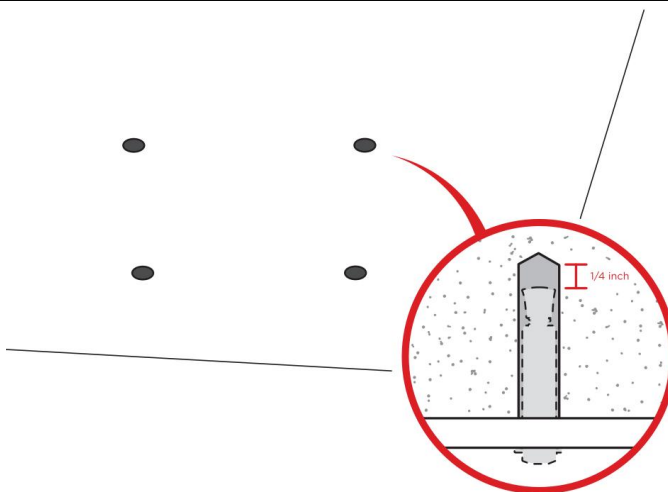

Percez quatre trous à l'emplacement de montage.

REMARQUE : Percez environ 1/4" plus profond que la longueur du manchon d'ancrage.

C

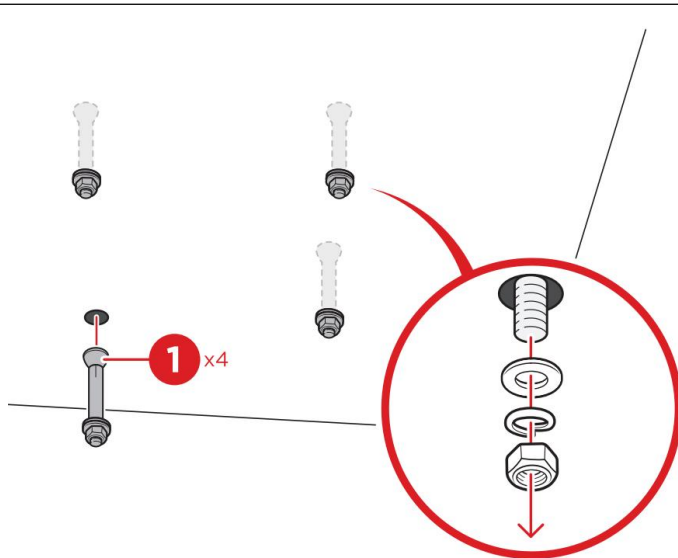

Insérez quatre ancrages à manchon en partie 1 dans les trous. Utilisez un marteau si nécessaire. Retirez les écrous/rondelles des ancrages du manchon.

D

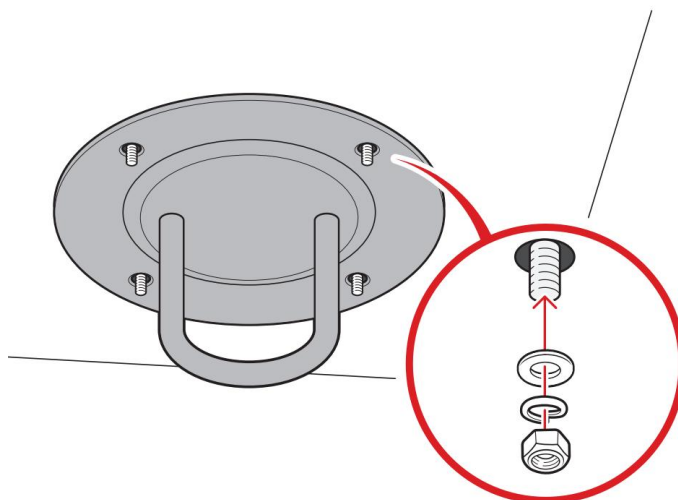

Placez le support, puis serrez les écrous pour fixer le support.

## Procédure d'installation

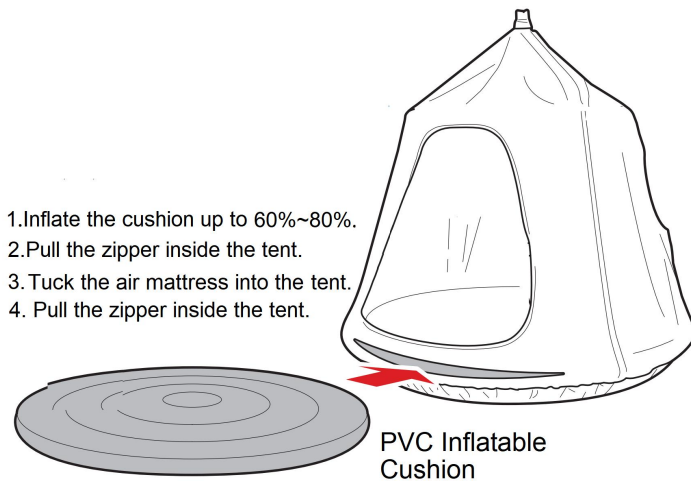
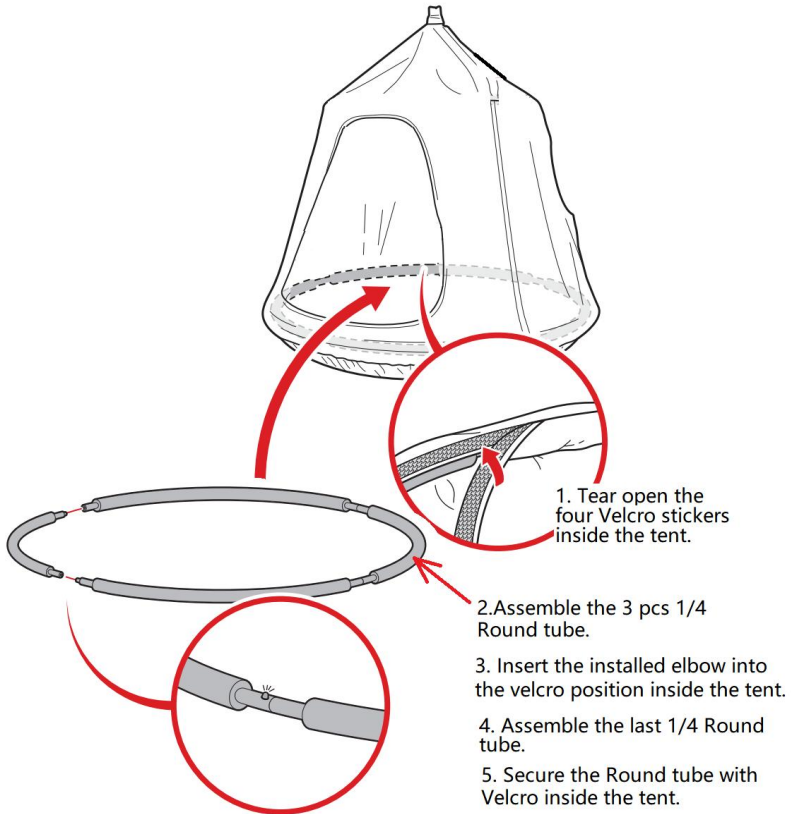

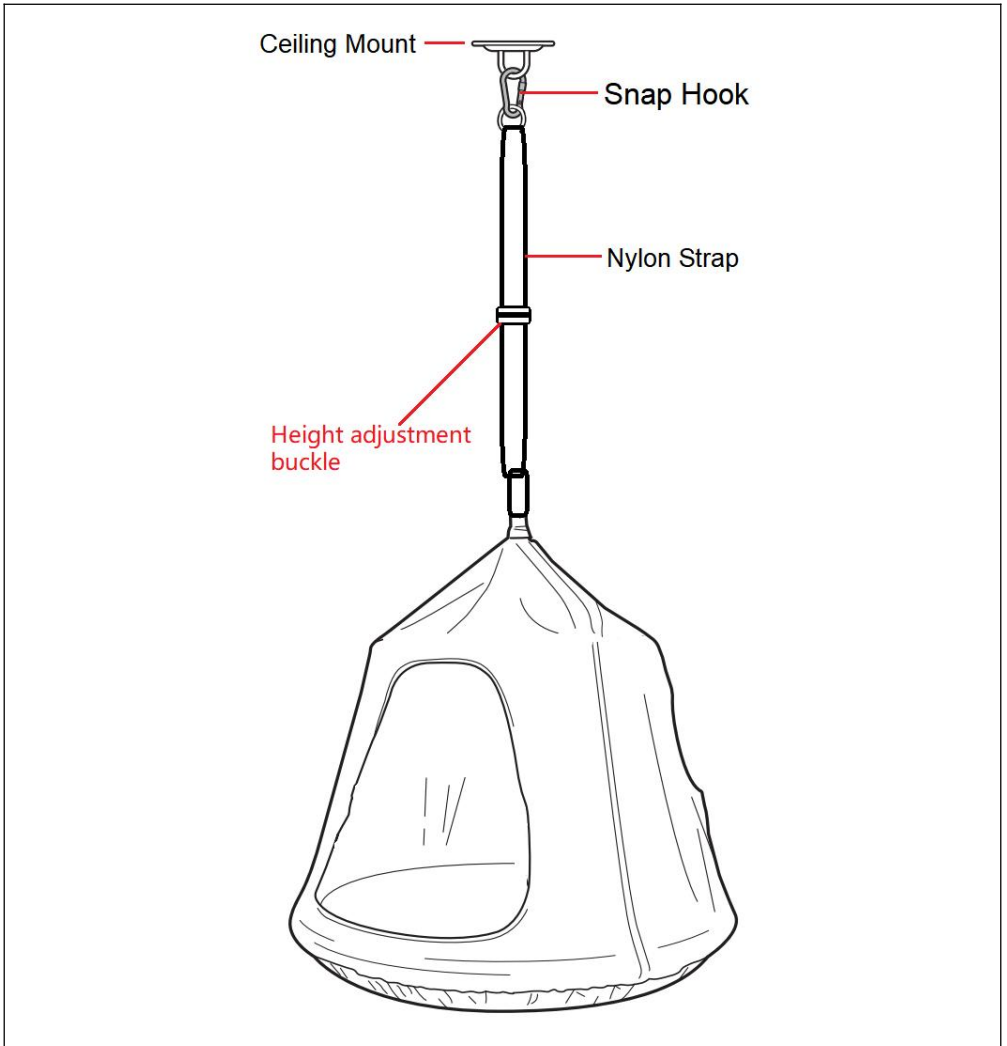

## **CONSEILS D'INSTALLATION**

- Assurez-vous que la structure aérienne peut supporter un minimum de 250 lb. S'il est suspendu à un arbre, le diamètre de la branche de l'arbre doit être de 10 pouces.
- Demandez aux adultes de tester la structure supérieure en tirant vers le bas ou en s'asseyant sur la balançoire.
- Ne pas installer sur du béton, de l'asphalte ou un sol dur.

- La balançoire doit être entourée d'une zone de chute.
- La zone de chute doit s'étendre sur un minimum de 18 pouces sur chaque côté et deux fois la hauteur de balancement à l'avant/à l'arrière.
- Placez un rembourrage doux autour de la balançoire si le sol est trop dur.
- Ne pas utiliser dans un endroit trop ensoleillé. Par temps chaud , assurez-vous que la surface de balancement de la tente n'est pas trop chaude. La hauteur de balançoire doit être de 12 à 18 pouces au-dessus du sol.
- Le swing doit avoir au au moins 6,5 pieds de dégagement aérien et latéral à partir de toute structure ou obstacle tel qu'une clôture , un garage , une maison , des branches , des fils , etc.
- Installer dans une zone exempte de fils , murs , structures , meubles , etc .

**Adresse :** Baoshanqu Shuangchenglu 803long 11hao 1602A-1609shi  
Shanghai

**Importé en Australie :** SIHAO PTY LTD, 1 ROKEVA STREETASTWOOD  
NSW 2122 Australie

**Importé aux États-Unis :** Sanven Technology Ltd., Suite 250, 9166  
Anaheim Place, Rancho Cucamonga, CA 91730



Pooledas Group Ltd  
Unit 5 Albert Edward House, The Pavilions  
Preston, United Kingdom



SHUNSHUN GmbH  
Römeräcker 9 Z2021, 76351  
Linkenheim-Hochstetten, Germany

**Fabriqué en Chine**



**VEVOR<sup>®</sup>**

**TOUGH TOOLS, HALF PRICE**

**Technique Assistance et certificat de garantie électronique**

**[www.vevor.com/support](http://www.vevor.com/support)**

# **VEVOR<sup>®</sup>**

**TOUGH TOOLS, HALF PRICE**

Technisch Support- und E-Garantie-Zertifikat [www.vevor.com/support](http://www.vevor.com/support)

## **HÄNGEMATTENSTUHL**

### **BENUTZERHANDBUCH**

We continue to be committed to provide you tools with competitive price.

"Save Half", "Half Price" or any other similar expressions used by us only represents an estimate of savings you might benefit from buying certain tools with us compared to the major top brands and does not necessarily mean to cover all categories of tools offered by us. You are kindly reminded to verify carefully when you are placing an order with us if you are actually saving half in comparison with the top major brands.

# VEVOR<sup>®</sup>

TOUGH TOOLS, HALF PRICE

## HAMMOCK CHAIR

LYY006 /LYY007 /LYY008



**NEED HELP? CONTACT US!**

Have product questions? Need technical support? Please feel free to contact us:

**Technical Support and E-Warranty Certificate**  
**[www.vevor.com/support](http://www.vevor.com/support)**

This is the original instruction, please read all manual instructions carefully before operating. VEVOR reserves a clear interpretation of our user manual. The appearance of the product shall be subject to the product you received. Please forgive us that we won't inform you again if there are any technology or software updates on our product.

## Sicherheitsvorkehrungen

### WARNUNG:

**Lesen Sie diese Anweisungen**, bevor Sie dieses Produkt verwenden.







Andernfalls kann es zu schweren Verletzungen kommen. Die grundlegenden Vorsichtsmaßnahmen sollten immer befolgt werden , einschließlich der folgenden:





- Stellen Sie sicher, dass alle Muttern , Bolzen und Schrauben fest angezogen und sicher sind.
- Beschläge und Aufhängepunkte regelmäßig einfetten.
- Überprüfen Sie die Hardware und die Aufhängepunkte auf Rost, der sie beeinträchtigen könnte Stärke. Bei Bedarf austauschen.
- Überprüfen Sie Sitz , Luftkissen und Zelt auf übermäßige Abnutzung.
- Überprüfen Sie die Seile auf Ausfransungen , Abnutzung oder Brüche und ersetzen Sie sie bei Bedarf.
- Lassen Sie die Zeltschaukel nicht für längere Zeit im Freien stehen.
- Im Winter wird empfohlen , die Zeltschaukel drinnen aufzubewahren.
- Zum Reinigen mit einem feuchten Tuch abwischen.

- An einem trockenen Ort ohne direkte Sonneneinstrahlung lagern.
- Bei längerem Nichtgebrauch abdecken oder in einer Tasche aufbewahren.



## ANLEITUNG AUFBEWAHREN

### Produktliste

Name	Teile	Menge _
Pod Swing		1
Aufblasbares PVC-Kissen		1
Nylonband		1
Karabinerhaken		1
Deckenmontage		1
Schrauben ( Für Betondecken )		4

Schrauben ( Für Holzdecken )		4
Ich nflator		1
1/4 Rundrohr		4
Schwammrohre		4

## Produktparameter

Modell	Körperfarbe	Saumfarbe	Bild _	Tragfähig _
<b>LYY009</b>	Lila Pulver	Blau		1 20 Pfund / 54 kg
<b>LYY010</b>	Blau	Fruchtgrün		1 20 Pfund / 54 kg

<p><b>LYY011</b></p>	<p>Fruchtgrün</p>	<p>Gras-Grün</p>		<p>1 20 Pfund / 54 kg</p>
----------------------	-------------------	------------------	--	-------------------------------

**Bitte halten Sie das Luftkissen einmal im halben Monat aufgeblasen.**

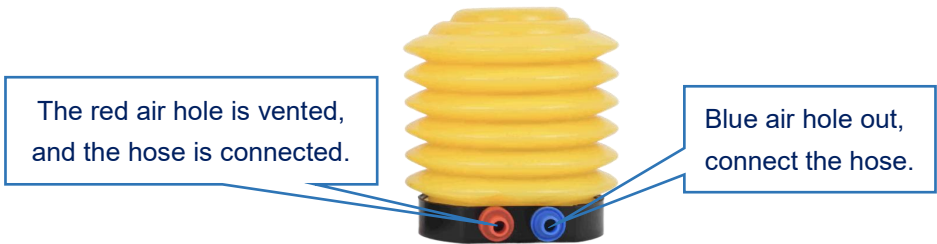

### U sage S -Szenario

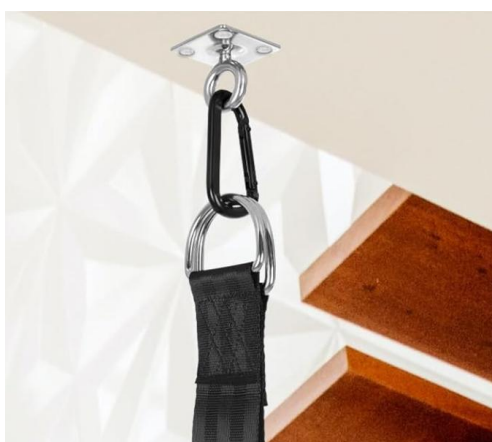

Betondecke



Holzdecke



Hängemattenständer



Baum

**Vorgehensweise bei der Installation einer Betondecke**



A

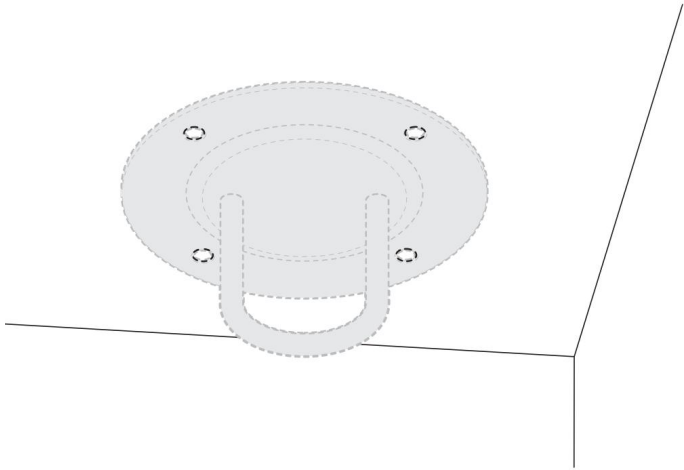

Richten Sie die Deckenhalterung aus und markieren Sie mit einem Bleistift den gewünschten Montageort.

B

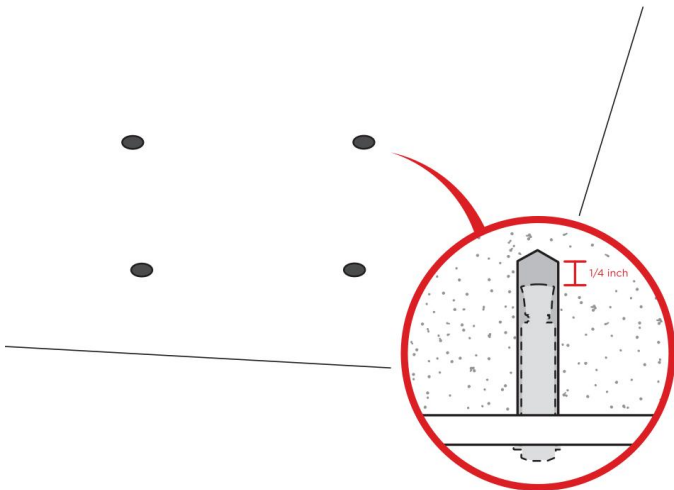

Bohren Sie am Montageort vier Löcher.

HINWEIS: Bohren Sie etwa 1/4 Zoll tiefer als die Länge des Hülsenankers.

C

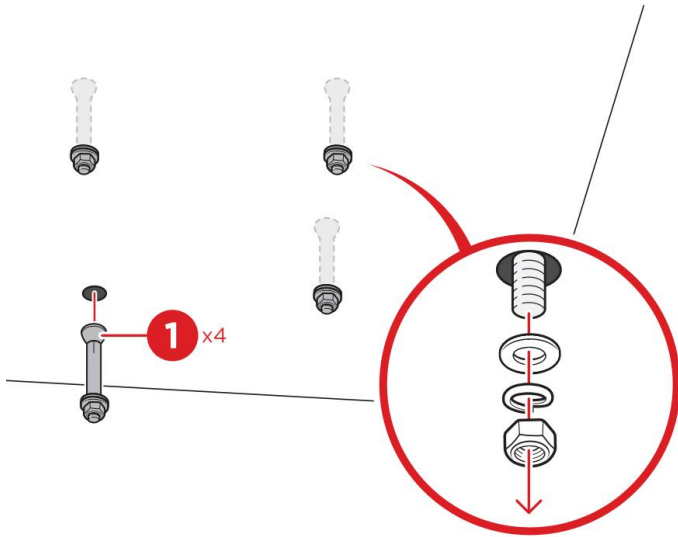

Setzen Sie vier Hülseanker Teil 1 in die Löcher ein. Benutzen Sie bei Bedarf einen Hammer. Entfernen Sie die Muttern/Unterlegscheiben von den Hülseankern.

D

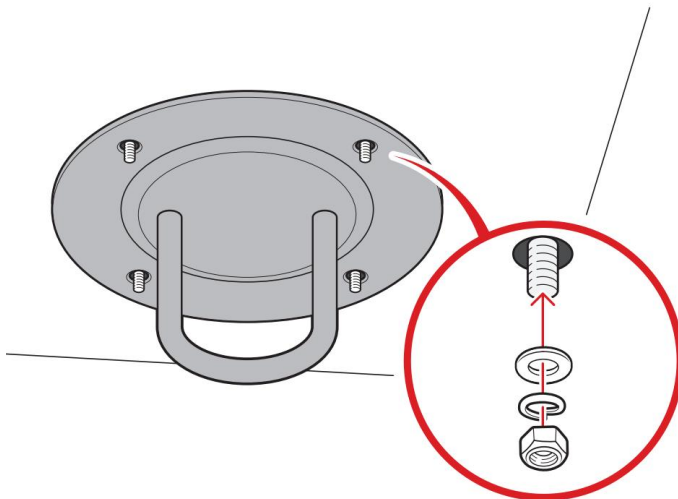

Platzieren Sie die Halterung und ziehen Sie dann die Muttern fest, um die Halterung zu befestigen.

# Installationsvorgang

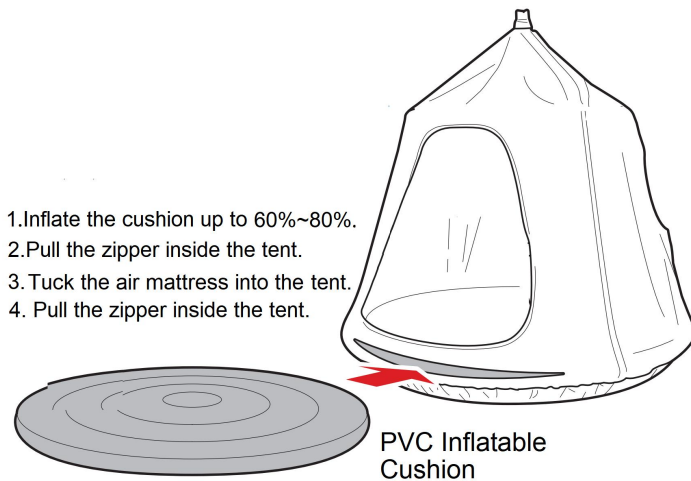
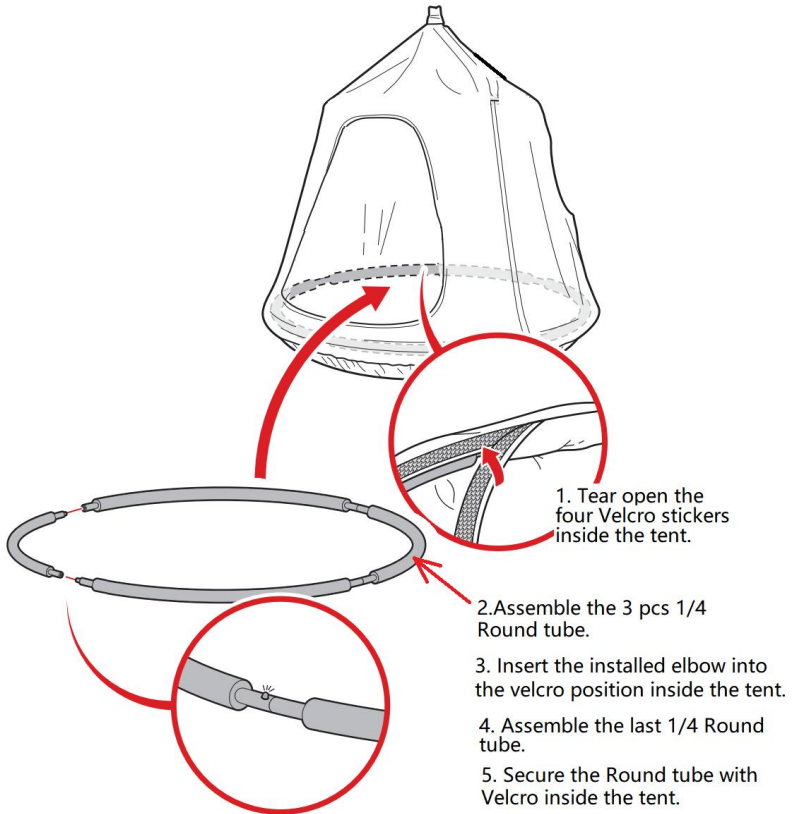

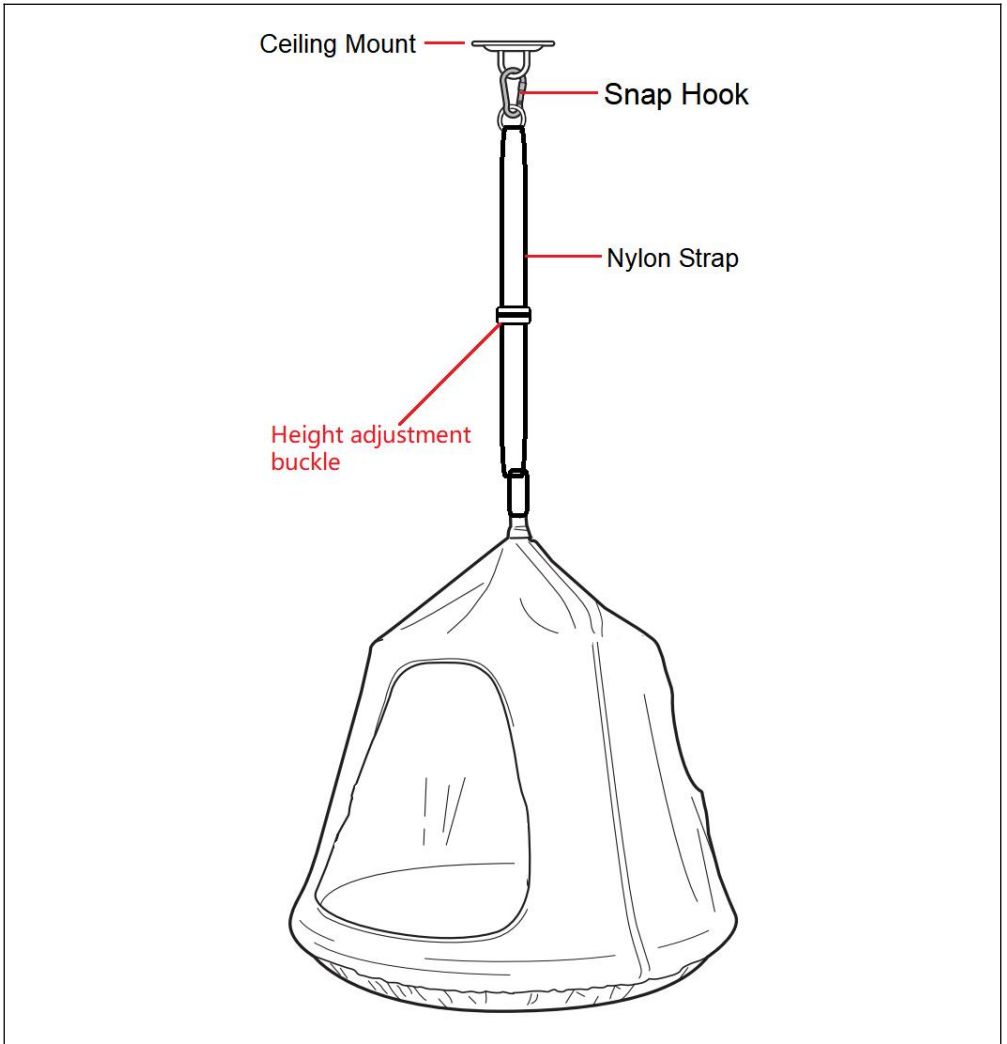

## **INSTALLATIONSTIPPS**

- Stellen Sie sicher, dass die Deckenkonstruktion mindestens 250 Pfund tragen kann. Wenn es an einem Baum hängt, sollte der Durchmesser des Asts 10 Zoll betragen.
- Lassen Sie Erwachsene die Überkopfkonstruktion testen, indem sie die Schaukel herunterziehen oder sich darauf setzen.
- Nicht auf Beton, Asphalt oder hartem Boden installieren.

- Die Schaukel sollte eine Absturzzone rund um die Schaukel haben.  
-Die Fallzone sollte mindestens 18 betragen Zoll An jede seitlich und doppelte Schwunghöhe vorne/hinten.
- Wenn der Boden zu hart ist, legen Sie eine weiche Polsterung um die Schaukel.
- Nicht an Orten mit übermäßiger Sonneneinstrahlung verwenden. Achten Sie bei warmem Wetter darauf , dass die Schaukelfläche des Zelt es nicht zu heiß ist. Die Schaukelhöhe sollte 12 bis 18 Zoll über dem Boden liegen.
- Schaukel muss vorhanden sein mindestens 6,5 Fuß von Überkopf- und Seitenfreiheit von Alle Strukturen oder Hindernisse wie Zäune , Garagen , Häuser , Äste , Drähte usw.
- Installieren Sie das Gerät an einem Ort, der frei von Kabeln , Wänden , Strukturen , Möbeln usw. ist .

**Adresse:** Baoshanqu Shuangchenglu 803long 11hao 1602A-1609shi  
Shanghai

**Importiert nach AUS:** SIHAO PTY LTD, 1 ROKEVA STREETEASTWOOD  
NSW 2122 Australien

**In die USA importiert:** Sanven Technology Ltd., Suite 250, 9166 Anaheim  
Place, Rancho Cucamonga, CA 91730



Pooledas Group Ltd  
Unit 5 Albert Edward House, The Pavilions  
Preston, United Kingdom



SHUNSHUN GmbH  
Römeräcker 9 Z2021, 76351  
Linkenheim-Hochstetten, Germany

**In China hergestellt**

**VEVOR**<sup>®</sup>

**TOUGH TOOLS, HALF PRICE**

**Technisch Support- und E-Garantiezertifikat**

**[www.vevor.com/support](http://www.vevor.com/support)**

# **VEVOR<sup>®</sup>**

**TOUGH TOOLS, HALF PRICE**

Tecnico Supporto e certificato di garanzia elettronica [www.vevor.com/support](http://www.vevor.com/support)

## **SEDIA AMACA**

### **MANUALE D'USO**

We continue to be committed to provide you tools with competitive price.

"Save Half", "Half Price" or any other similar expressions used by us only represents an estimate of savings you might benefit from buying certain tools with us compared to the major top brands and does not necessarily mean to cover all categories of tools offered by us. You are kindly reminded to verify carefully when you are placing an order with us if you are actually saving half in comparison with the top major brands.

# VEVOR<sup>®</sup>

TOUGH TOOLS, HALF PRICE

## HAMMOCK CHAIR

LYY006 /LYY007 /LYY008



**NEED HELP? CONTACT US!**

Have product questions? Need technical support? Please feel free to contact us:

**Technical Support and E-Warranty Certificate**  
**[www.vevor.com/support](http://www.vevor.com/support)**



This is the original instruction, please read all manual instructions carefully before operating. VEVOR reserves a clear interpretation of our user manual. The appearance of the product shall be subject to the product you received. Please forgive us that we won't inform you again if there are any technology or software updates on our product.

## Misure di sicurezza

### AVVERTIMENTO:

**Leggere queste istruzioni** prima di utilizzare questo prodotto. In caso contrario, si potrebbero verificare lesioni gravi. È necessario seguire sempre le precauzioni di base , incluse le seguenti:





- Riconfermare che tutti i dadi , i bulloni e le viti siano serrati e fissati.
- Lubrificare regolarmente la ferramenta e i punti di sospensione.
- Controllare l'eventuale presenza di ruggine sull'hardware e sui punti di sospensione che potrebbero comprometterli forza. Sostituire se necessario.
- Controllare che il sedile , il cuscino d'aria e la tenda non siano eccessivamente usurati.
- Controllare che le corde non siano sfilacciate , usurate o rotte. Sostituirle se necessario.
- Non lasciare l'altalena all'aperto per un lungo periodo di tempo.
- Nella stagione invernale , si consiglia di riporre l'altalena della tenda al chiuso.
- Per pulire , strofinare con un panno umido.

- Conservare in un luogo asciutto, lontano dalla luce solare diretta.
- Coprire o conservare in una borsa se non utilizzato per un lungo periodo di tempo.



## CONSERVA QUESTE ISTRUZIONI

### Elenco prodotti

Nome	Parti	Quantità _
Altalena del baccello		1
Cuscino gonfiabile in PVC		1
Cinturino in nylon		1
Moschettone		1
Montaggio a soffitto		1
Viti ( Per soffitto in cemento )		4

Viti ( Per soffitto in legno )		4
Gonfiatore _		1
Tubo tondo da 1/4		4
Tubi di spugna		4

## Parametro del prodotto

Modello	Colore del corpo	Colore dell'orlo	Immagine _	Portante _
<b>LYY009</b>	Polvere viola	Blu		1 20 libbre / 54 kg
<b>LYY010</b>	Blu	Frutta verde		1 20 libbre / 54 kg

<p><b>LYY011</b></p>	<p>Frutta verde</p>	<p>Erba verde</p>		<p>1 20 libbre / 54 kg</p>
----------------------	---------------------	-------------------	--	--------------------------------

**Si prega di tenere gonfiato il cuscino d'aria una volta ogni mezzo mese.**

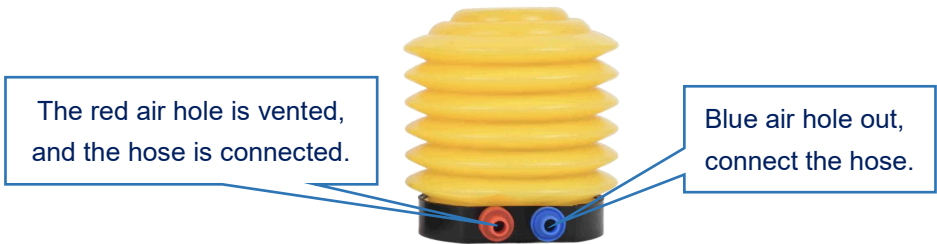

### Scenario di utilizzo \_

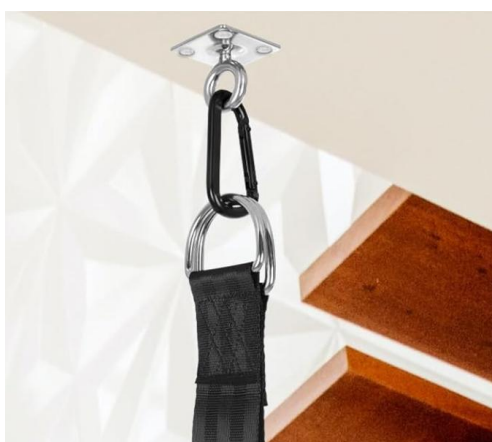

Soffitto in cemento



Soffitto in legno

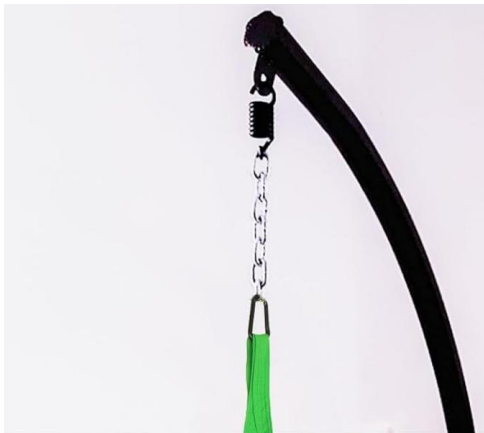

Supporti per amache



Albero

**Procedura di installazione del soffitto in cemento**

UN

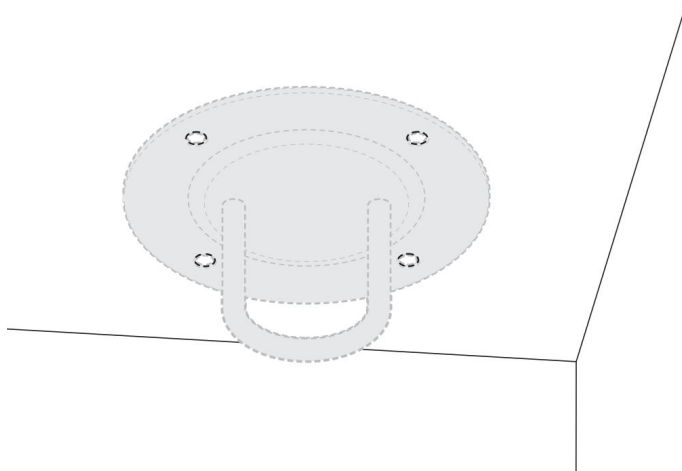

Allineare il supporto a soffitto e utilizzare una matita per contrassegnare la posizione di montaggio desiderata.

B

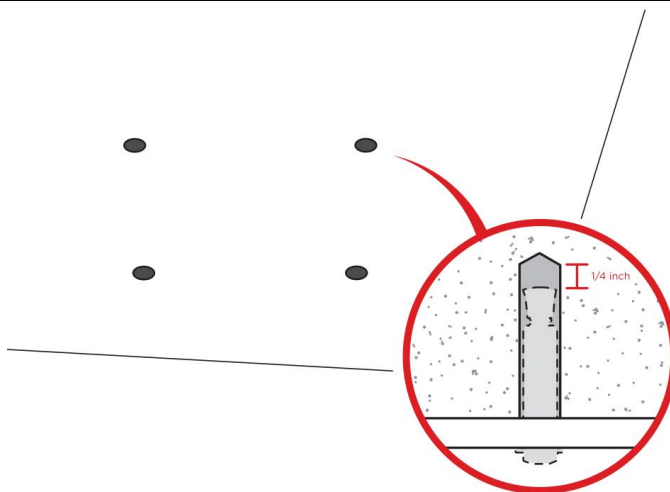

Praticare quattro fori nella posizione di montaggio.

NOTA: forare circa 1/4" più in profondità della lunghezza del manicotto di ancoraggio.

C

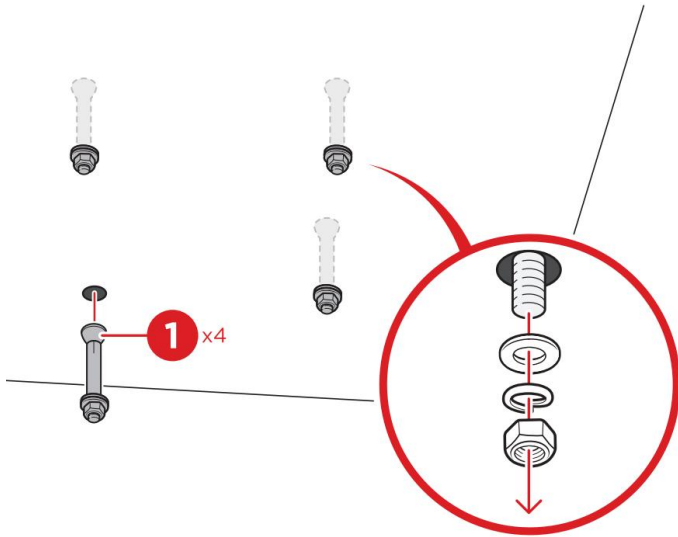

Inserire quattro tasselli a manicotto della parte 1 nei fori. Se necessario, utilizzare un martello. Rimuovere i dadi/rondelle dagli ancoraggi del manicotto.

D

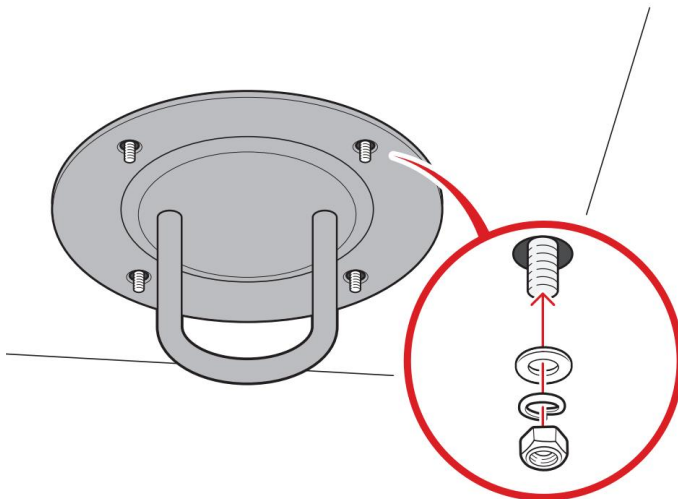

Posizionare il supporto, quindi serrare i dadi per fissare il supporto.

## Procedura d'installazione

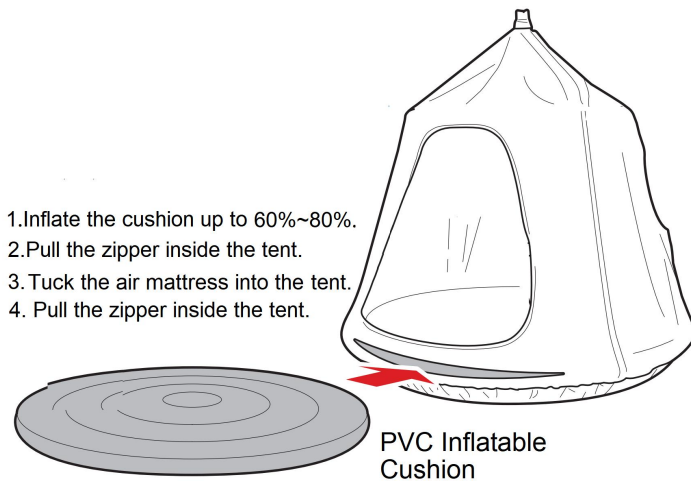
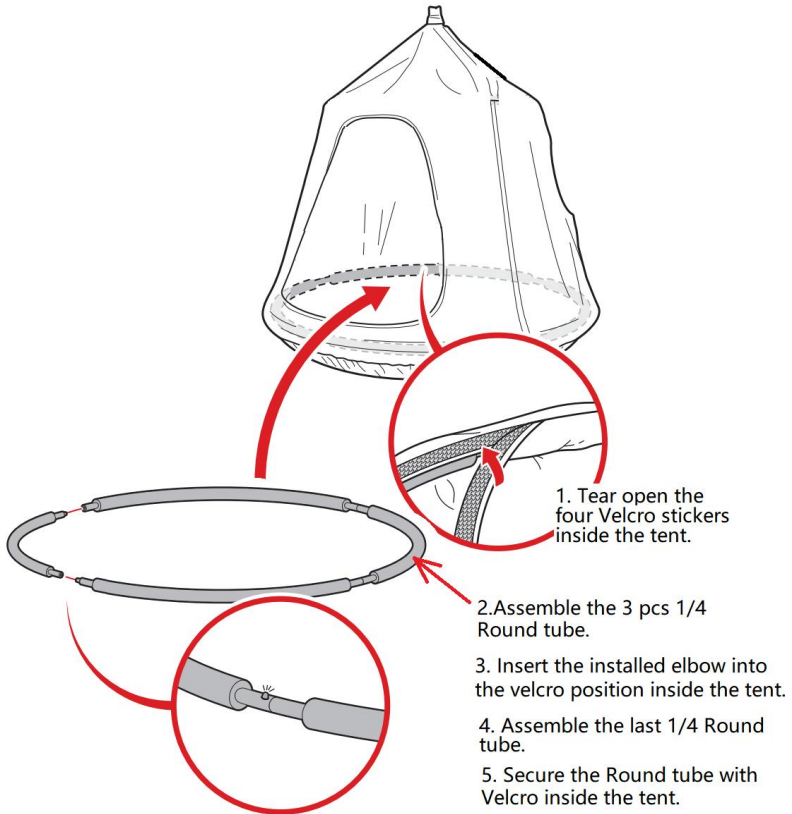



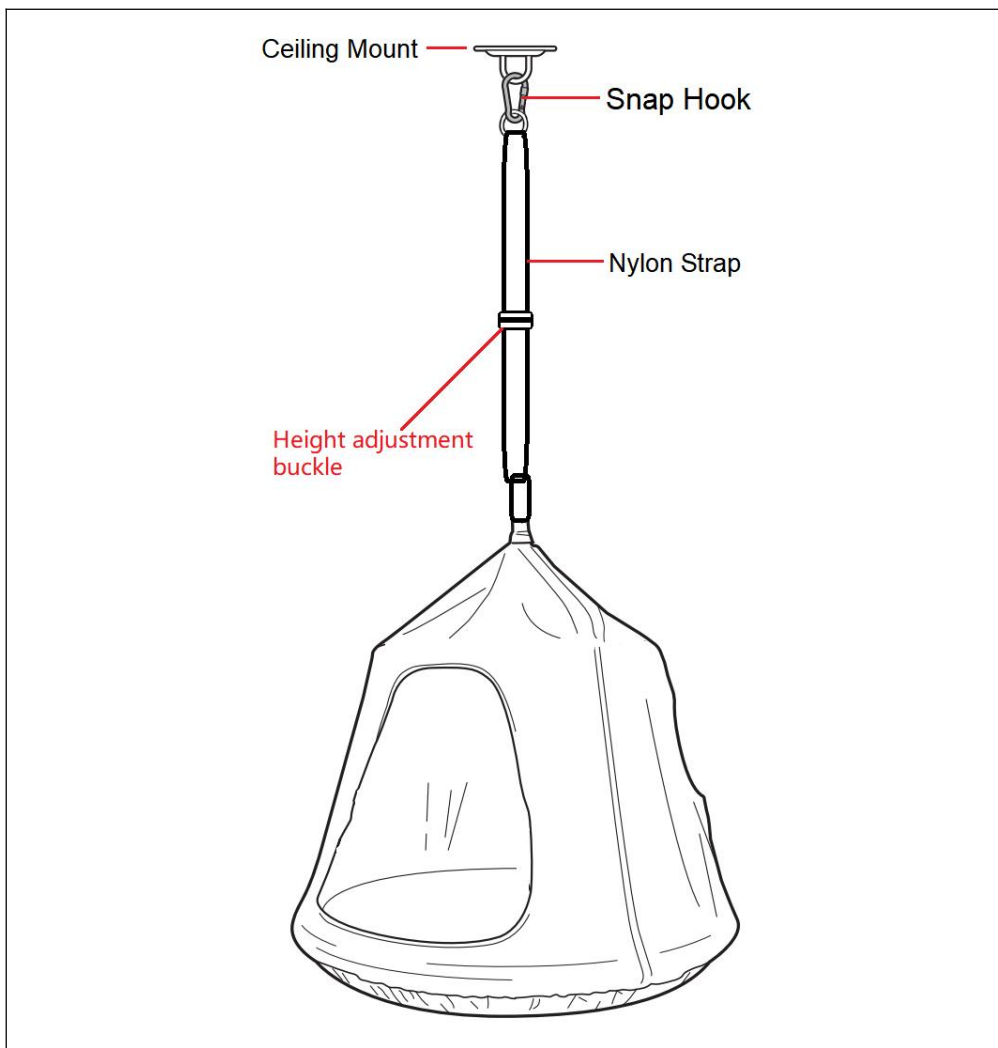

## **CONSIGLI PER L'INSTALLAZIONE**

- Assicurarsi che la struttura sopraelevata possa supportare un minimo di 25 0 libbre. Se appeso a un albero , il diametro del ramo dell'albero dovrebbe essere di 10 pollici.
- Chiedere agli adulti di testare la struttura sopraelevata abbassandola o sedendosi sull'altalena.
- Non installare su cemento , asfalto o terreno duro.

- L'altalena dovrebbe avere una zona di caduta attorno all'altalena.
  - La zona di caduta dovrebbe estendersi come minimo di 18 pollici SU ogni lato e il doppio dell'altezza di oscillazione nella parte anteriore/posteriore.
  - Posizionare un'imbottitura morbida attorno all'altalena se il terreno è troppo duro.
  - Non utilizzare in luoghi esposti alla luce solare eccessiva. Nella stagione calda , assicurarsi che la superficie dell'altalena della tenda non sia troppo calda.
- L'altezza dell'oscillazione dovrebbe essere compresa tra 12 e 18 pollici dal suolo.
- L'altalena deve avere a almeno 6,5 piedi di spazio sopraelevato e laterale da qualsiasi struttura o ostacolo come recinzione , garage , casa , rami , cavi , ecc.
  - Installare in un'area priva di cavi , pareti , strutture , mobili , ecc.

**Indirizzo:** Baoshanqu Shuangchenglu 803long 11hao 1602A-1609shi  
Shanghai

**Importato in AUS:** SIHAO PTY LTD, 1 ROKEVA STREETEASTWOOD  
NSW 2122 Australia

**Importato negli Stati Uniti:** Sanven Technology Ltd., Suite 250, 9166  
Anaheim Place, Rancho Cucamonga, CA 91730



Pooledas Group Ltd  
Unit 5 Albert Edward House, The Pavilions  
Preston, United Kingdom



SHUNSHUN GmbH  
Römeräcker 9 Z2021, 76351  
Linkenheim-Hochstetten, Germany

**Made in China**

**VEVOR**<sup>®</sup>

**TOUGH TOOLS, HALF PRICE**

**Tecnico Supporto e certificato di garanzia elettronica**

**[www.vevor.com/support](http://www.vevor.com/support)**

# **VEVOR<sup>®</sup>**

**TOUGH TOOLS, HALF PRICE**

Técnico Soporte y certificado de garantía electrónica [www.vevor.com/support](http://www.vevor.com/support)

## **SILLA HAMACA**

## **MANUAL DE USUARIO**

We continue to be committed to provide you tools with competitive price.

"Save Half", "Half Price" or any other similar expressions used by us only represents an estimate of savings you might benefit from buying certain tools with us compared to the major top brands and does not necessarily mean to cover all categories of tools offered by us. You are kindly reminded to verify carefully when you are placing an order with us if you are actually saving half in comparison with the top major brands.

# VEVOR<sup>®</sup>

TOUGH TOOLS, HALF PRICE

## HAMMOCK CHAIR

LYY006 /LYY007 /LYY008



**NEED HELP? CONTACT US!**

Have product questions? Need technical support? Please feel free to contact us:

**Technical Support and E-Warranty Certificate**  
**[www.vevor.com/support](http://www.vevor.com/support)**

This is the original instruction, please read all manual instructions carefully before operating. VEVOR reserves a clear interpretation of our user manual. The appearance of the product shall be subject to the product you received. Please forgive us that we won't inform you again if there are any technology or software updates on our product.

## Precauciones de seguridad

### ADVERTENCIA:

**Lea estas instrucciones** antes de usar este producto. De lo contrario, se pueden producir lesiones graves. Siempre se deben seguir las precauciones básicas , incluidas las siguientes:

- Vuelva a confirmar que todas las tuercas , pernos y tornillos estén apretados y seguros.
- Engrase los herrajes y los puntos para colgar con regularidad.
- Revise los herrajes y los puntos para colgar en busca de óxido que pueda afectar su fortaleza. Reemplace si es necesario.
- Revise el asiento , el cojín de aire y la tienda para detectar desgaste excesivo.
- Revise las cuerdas para ver si están deshilachadas , desgastadas o rotas.







Reemplácelas si es necesario.





- No deje la tienda de campaña al aire libre durante un período prolongado de tiempo.
- En la temporada de invierno , se recomienda guardar el columpio de la tienda en el interior.

- Para limpiar , limpie con un paño húmedo.
- Almacenar en un lugar seco y alejado de la luz solar directa.
- Cubra o guárdelo en una bolsa si no se utiliza durante un período prolongado.



## GUARDA ESTAS INSTRUCCIONES

### Lista de productos

Nombre	Partes	Cantidad _
Columpio de vaina		1
Cojín inflable de PVC		1
Correa de nailon		1
Mosquetón		1
Montaje en techo		1
Tornillos ( Para techo de hormigón )		4

Tornillos ( Para techo de madera )		4
inflador _		1
1/4 tubo redondo		4
tubos de esponja		4

## Parámetro del producto

Modelo	Color del cuerpo	Color del dobladillo	Imagen _	portador de carga
<b>LYY009</b>	polvo morado	Azul		1 20 libras / 54 kg
<b>LYY010</b>	Azul	fruta verde		1 20 libras / 54 kg



<p><b>LYY011</b></p>	<p>fruta verde</p>	<p>Pasto verde</p>		<p>1 20 libras / 54 kg</p>
----------------------	--------------------	--------------------	--	--------------------------------

**Mantenga el colchón de aire inflado una vez cada medio mes.**

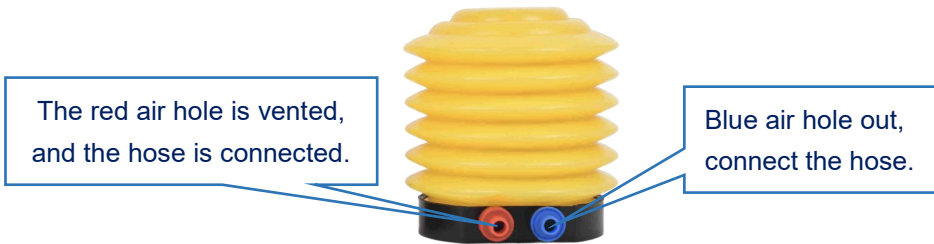

### Escenario de uso \_

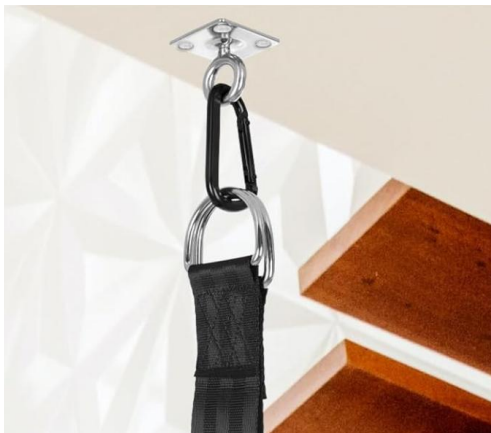

Techo de hormigón



Techo de madera



Soportes para hamacas



Árbol

## Procedimiento de instalación de techo de hormigón

A

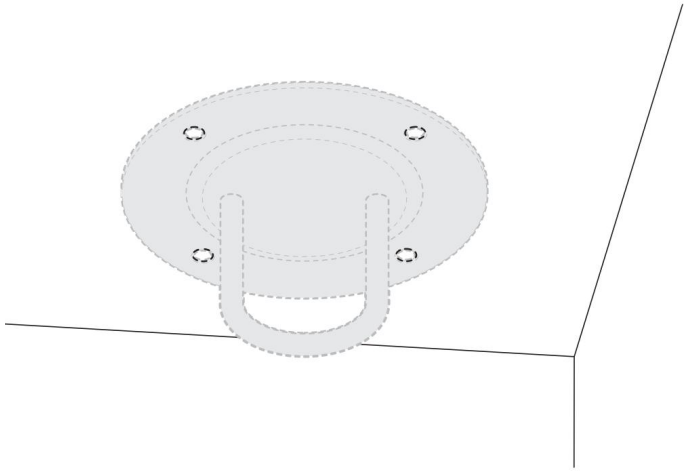

Alinee el soporte de techo y use un lápiz para marcar la ubicación de montaje deseada.

B

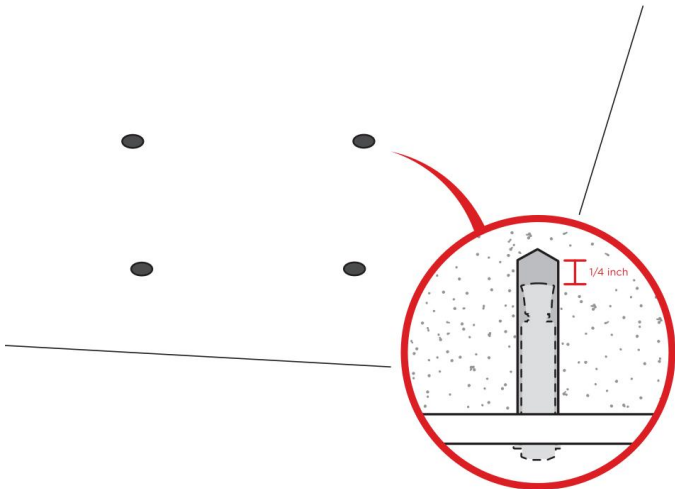

Taladre cuatro agujeros en la ubicación de montaje.

NOTA: Perfore aproximadamente 1/4" más profundo que la longitud del anclaje de la manga.

C

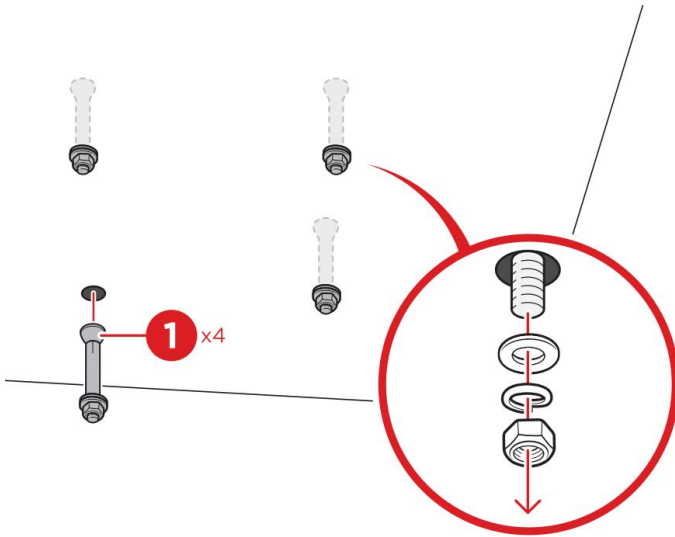

Inserte cuatro anclajes de manga de la parte 1 en los orificios. Utilice un martillo si es necesario. Retire las tuercas/arandelas de los anclajes de la manga.

D

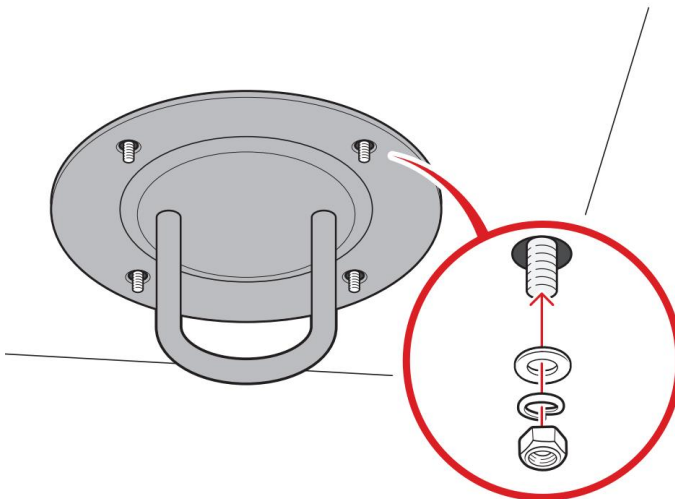

Coloque el soporte y luego apriete las tuercas para asegurar el soporte.

## Procedimiento de instalación

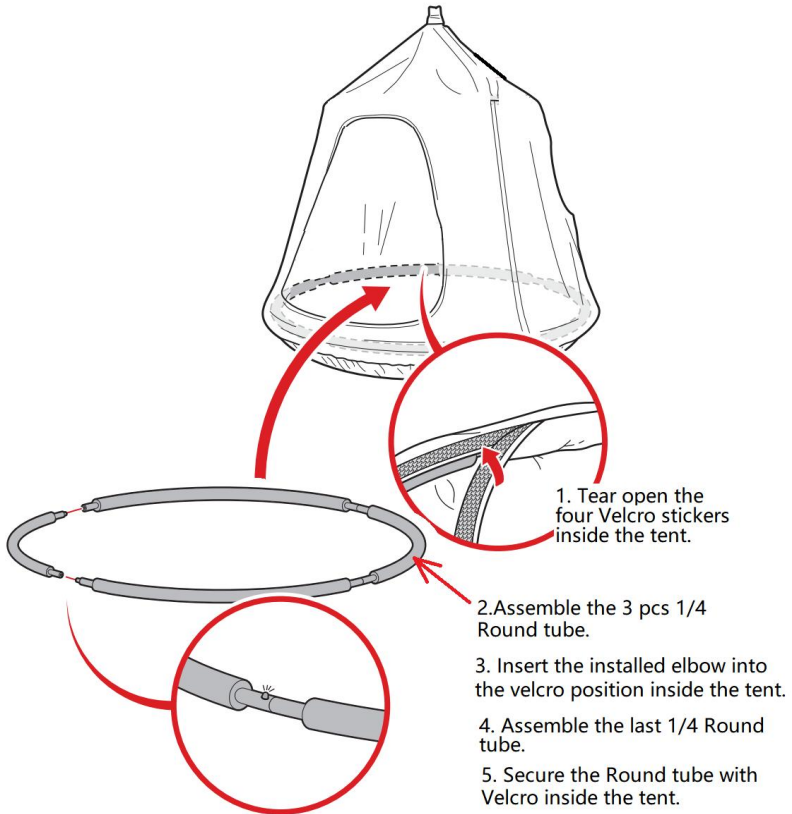

1. Inflate the cushion up to 60%~80%.
2. Pull the zipper inside the tent.
3. Tuck the air mattress into the tent.
4. Pull the zipper inside the tent.

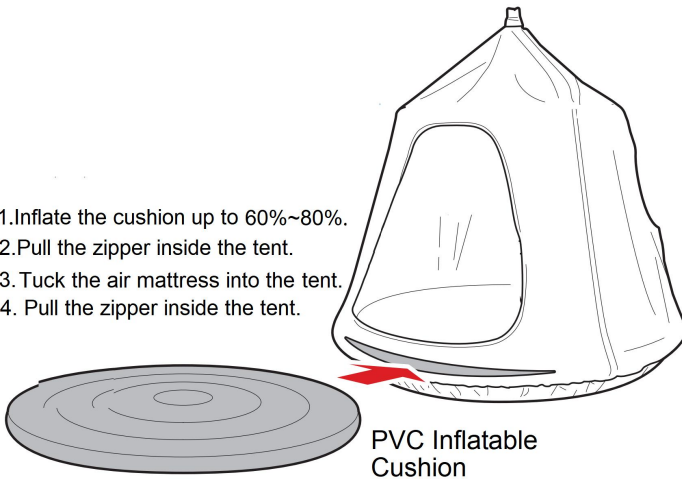

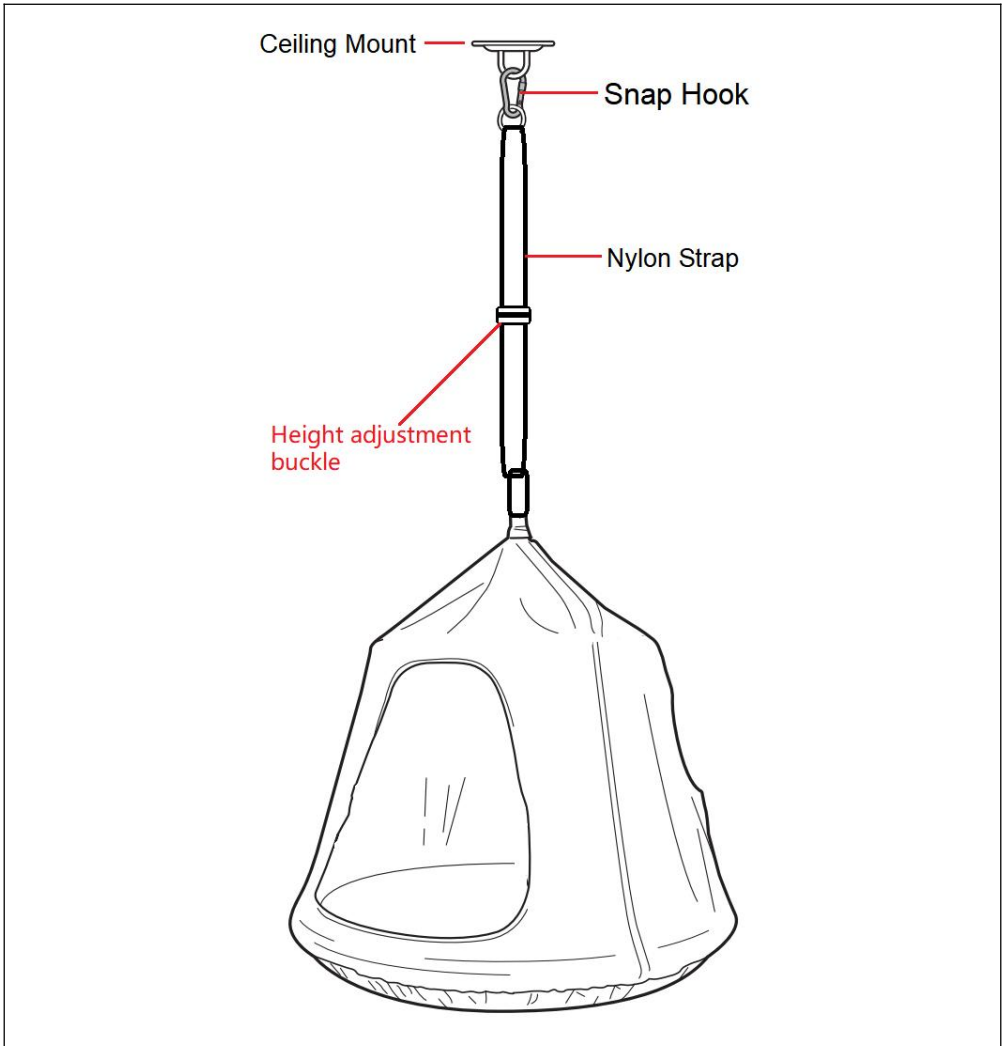

## **CONSEJOS DE INSTALACIÓN**

- Asegúrese de que la estructura superior pueda soportar un mínimo de 25 0 libras. Si cuelga de un árbol , el diámetro de la rama del árbol debe ser de 10 pulgadas.
- Haga que los adultos prueben la estructura superior tirando hacia abajo o sentándose en el columpio.
- No lo instale sobre concreto , asfalto o suelo duro.

- El columpio debe tener una zona de caída alrededor del columpio.
- La zona de caída debe extenderse un mínimo de 18 pulgadas en cada lado y el doble de la altura de giro en la parte delantera/trasera.
- Coloque un acolchado suave alrededor del columpio si el suelo es demasiado duro.
- No lo utilice en un lugar con luz solar excesiva. En climas cálidos , asegúrese de que la superficie del columpio de la tienda no esté demasiado caliente. La altura del columpio debe estar entre 12 y 18 pulgadas del suelo.
- El swing debe tener en menos 6,5 pies de espacio libre superior y lateral desde cualquier estructura u obstrucción como una cerca , garaje , casa , ramas , alambres , etc.
- Instalar en un área libre de cables , paredes , estructuras , muebles , etc.

**Dirección:** Baoshanqu Shuangchenglu 803long 11hao 1602A-1609shi  
Shanghai

**Importado a AUS:** SIHAO PTY LTD, 1 ROKEVA STREETEASTWOOD  
NSW 2122 Australia

**Importado a EE. UU.:** Sanven Technology Ltd., Suite 250, 9166 Anaheim  
Place, Rancho Cucamonga, CA 91730



Pooledas Group Ltd  
Unit 5 Albert Edward House, The Pavilions  
Preston, United Kingdom



SHUNSHUN GmbH  
Römeräcker 9 Z2021, 76351  
Linkenheim-Hochstetten, Germany

**Hecho en china**

**VEVOR**<sup>®</sup>

**TOUGH TOOLS, HALF PRICE**

**Técnico Certificado de soporte y garantía electrónica**

**[www.vevor.com/support](http://www.vevor.com/support)**



# **VEVOR<sup>®</sup>**

**TOUGH TOOLS, HALF PRICE**

Techniczny Certyfikat wsparcia i e-gwarancji [www.vevor.com/support](http://www.vevor.com/support)

## **LEŻAK**

### **INSTRUKCJA OBSŁUGI**

We continue to be committed to provide you tools with competitive price.

"Save Half", "Half Price" or any other similar expressions used by us only represents an estimate of savings you might benefit from buying certain tools with us compared to the major top brands and does not necessarily mean to cover all categories of tools offered by us. You are kindly reminded to verify carefully when you are placing an order with us if you are actually saving half in comparison with the top major brands.

# VEVOR<sup>®</sup>

TOUGH TOOLS, HALF PRICE

## HAMMOCK CHAIR

LYY006 /LYY007 /LYY008



**NEED HELP? CONTACT US!**

Have product questions? Need technical support? Please feel free to contact us:

**Technical Support and E-Warranty Certificate**  
**[www.vevor.com/support](http://www.vevor.com/support)**

This is the original instruction, please read all manual instructions carefully before operating. VEVOR reserves a clear interpretation of our user manual. The appearance of the product shall be subject to the product you received. Please forgive us that we won't inform you again if there are any technology or software updates on our product.

## Środki ostrożności

### **OSTRZEŻENIE:**





**Przeczytaj tę instrukcję** przed użyciem tego produktu. Niezastosowanie się do tego może spowodować poważne obrażenia. należy zawsze przestrzegać podstawowych środków ostrożności , w tym:





- Sprawdź ponownie, czy wszystkie nakrętki , śruby i wkręty są dokręcone i bezpieczne.
- Regularnie smaruj okucia i punkty zawieszenia.
- Sprawdź okucia i punkty zawieszenia pod kątem rdzy, która może mieć wpływ na ich działanie wytrzymałość. W razie potrzeby wymienić.
- Sprawdź siedzisko , poduszkę powietrzną i namiot pod kątem nadmiernego zużycia.
- Sprawdź liny pod kątem postrzępienia , zużycia lub złamania. W razie potrzeby wymień .
- Nie pozostawiaj huśtawki namiotowej na zewnątrz przez dłuższy czas.
- W sezonie zimowym zaleca się przechowywanie huśtawki namiotowej w pomieszczeniu zamkniętym.

- Aby wyczyścić , przetrzyj wilgotną szmatką.
- Przechowywać w suchym miejscu, z dala od bezpośredniego światła słonecznego.
- Przykryj lub przechowuj w torbie, jeśli nie jest używany przez dłuższy czas.

## ZACHOWAJ TE INSTRUKCJE

### Lista produktów

Nazwa	Części	Ilość _
Pod huśtawką		1
Nadmuchiwana poduszka z PCV		1
Nylonowy pasek		1
Karabińczyk		1
Montaż sufitowy		1

Śruby ( Do sufitów betonowych )		4
Śruby ( Do sufitów drewnianych )		4
ja nflator		1
Rurka okrągła 1/4		4
Rury z gąbki		4

## Parametr produktu

Model	Kolor skóry	Kolor obszycia	Obraz _	Nośne _
<b>LYY009</b>	Fioletowy proszek	Niebieski		1 20 funtów / 54 kg
<b>LYY010</b>	Niebieski	Owoce zielone		1 20 funtów / 54 kg

<p><b>LYY011</b></p>	<p>Owoce zielone</p>	<p>Zielona trawa</p>		<p>1 20 funtów / 54 kg</p>
----------------------	----------------------	----------------------	--	--------------------------------

**Raz na pół miesiąca należy napompować poduszkę powietrzną.**

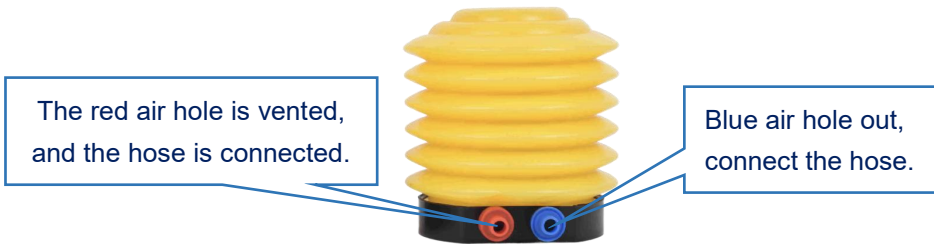

## Użyj Sage Scenario \_

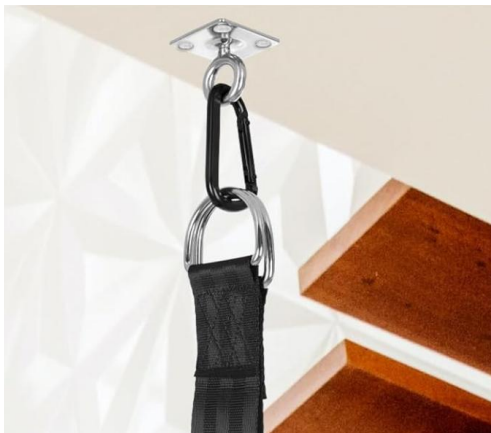

Betonowy sufit



Drewniany sufit

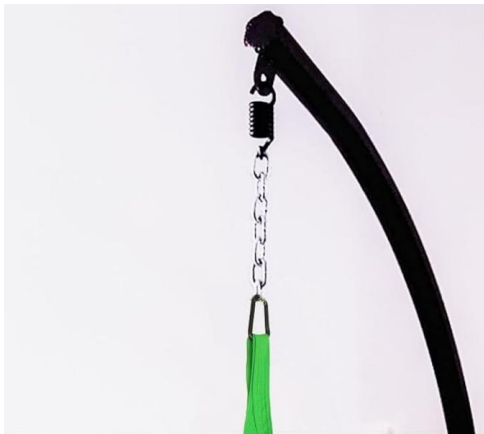

Stojaki do hamaków



Drzewo

## Procedura montażu sufitu betonowego

A

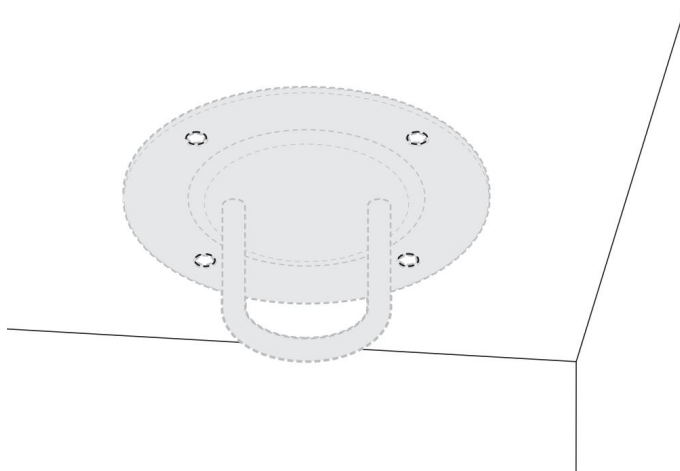

Wyrównaj uchwyt sufitowy i za pomocą ołówka zaznacz żądane miejsce montażu.

B

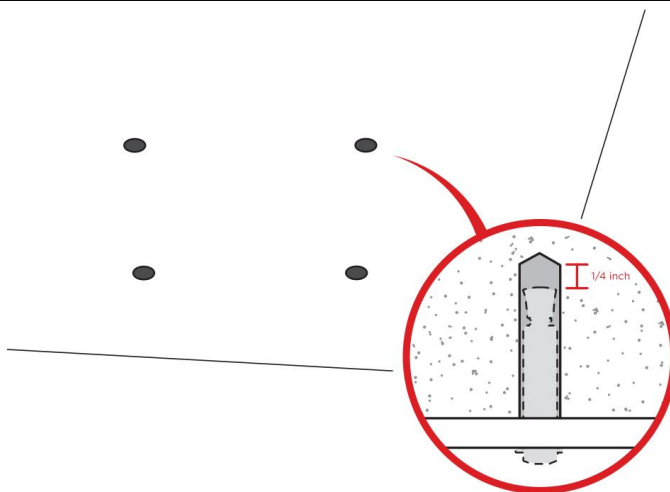

Wywierć cztery otwory w miejscu montażu.

**UWAGA:** Wywierć otwór o około 1/4 cala głębiej niż długość kotwy tulejowej.



C

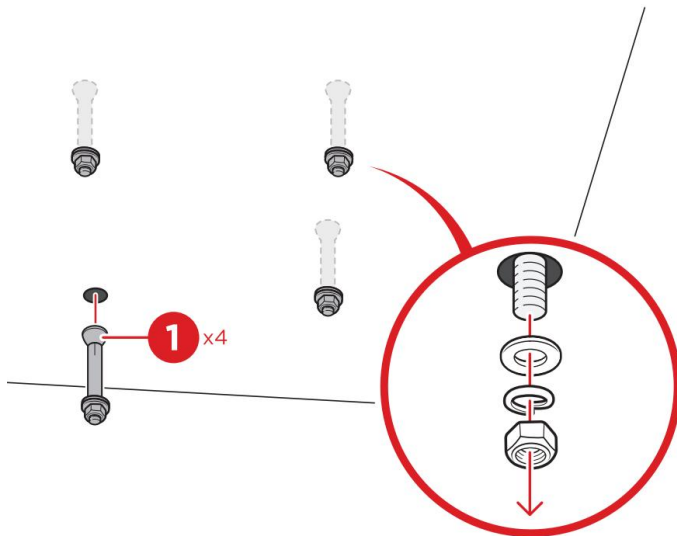

Włóż cztery kotwy tulejowe części 1 do otworów. W razie potrzeby użyj młotka. Zdejmij nakrętki/podkładki z kotew tulejowych.

D

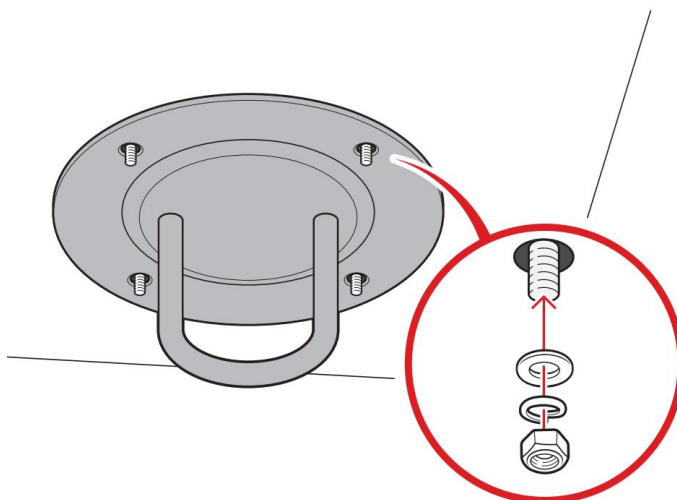

Umieść uchwyt, a następnie dokręć nakrętki, aby zabezpieczyć uchwyt.

## Procedura instalacji

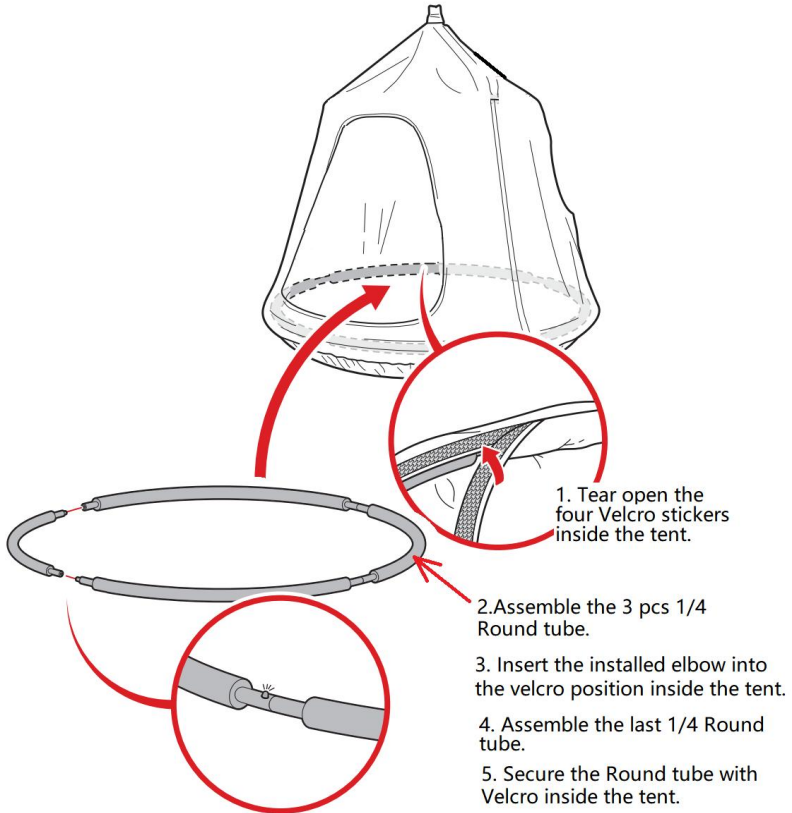

1. Inflate the cushion up to 60%~80%.
2. Pull the zipper inside the tent.
3. Tuck the air mattress into the tent.
4. Pull the zipper inside the tent.

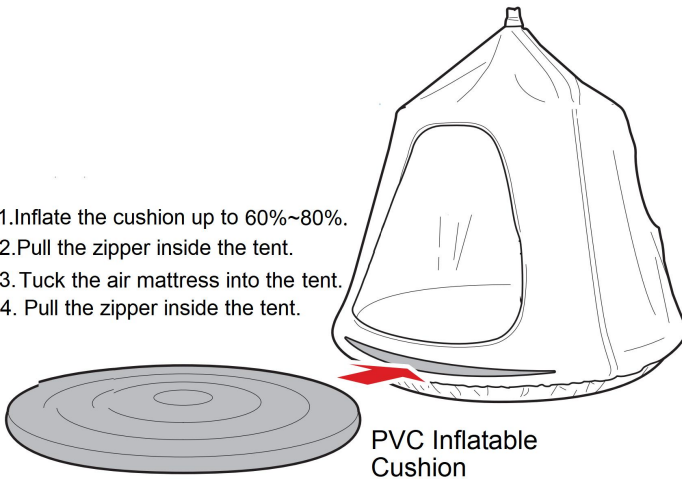

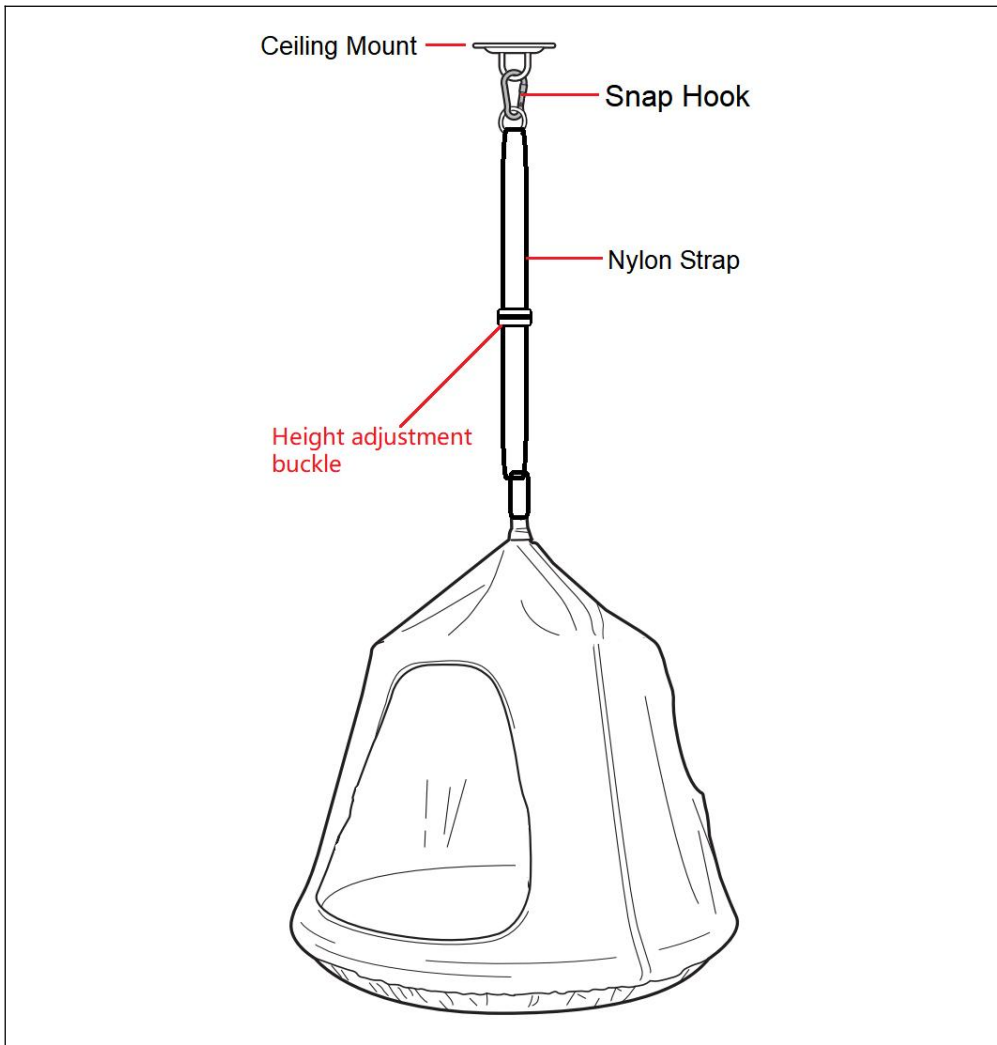

## **WSKAZÓWKI MONTAŻOWE**

- Upewnij się, że konstrukcja napowietrzna wytrzyma co najmniej 250 funtów. Jeśli zwisasz z drzewa, średnica gałęzi powinna wynosić 10 cali.
- Poproś dorosłych, aby przetestowali konstrukcję górną, pociągając ją lub siedząc na huśtawce.
- Nie instaluj na betonie, asfalcie lub twardym podłożu.
- Huśtawka powinna mieć wokół niej strefę upadku.

-Strefa upadku powinna rozciągać się na minimum 18 cali NA każdy boku i dwukrotność wysokości obrotu z przodu/tyłu.

- Jeśli podłoże jest zbyt twarde, umieść wokół huśtawki miękką wyściółkę.
- Nie używaj w miejscu o dużym nasłonecznieniu. Podczas ciepłej pogody upewnij się, że powierzchnia huśtawki namiotu nie jest zbyt gorąca. Wysokość huśtawki powinna wynosić od 12 do 18 cali nad ziemią.
- Huśtawka musi mieć godz co najmniej 6,5 stopy prześwitu nad głową i z boku dowolną konstrukcję lub przeszkodę, taką jak płot , garaż , dom , gałęzie , przewody itp .
- Zainstaluj w miejscu wolnym od przewodów , ścian , konstrukcji , mebli itp .

**Adres:** Baoshanqu Shuangchenglu 803long 11hao 1602A-1609shi  
Szanghaj

**Import do AUS:** SIHAO PTY LTD, 1 ROKEVA STREETEASTWOOD NSW  
2122 Australia

**Import do USA:** Sanven Technology Ltd., Suite 250, 9166 Anaheim Place,  
Rancho Cucamonga, CA 91730



Pooledas Group Ltd  
Unit 5 Albert Edward House, The Pavilions  
Preston, United Kingdom



SHUNSHUN GmbH  
Römeräcker 9 Z2021, 76351  
Linkenheim-Hochstetten, Germany

**Wyprodukowano w Chinach**

**VEVOR**<sup>®</sup>

**TOUGH TOOLS, HALF PRICE**

**Techniczny Certyfikat wsparcia i e-gwarancji**

**[www.vevor.com/support](http://www.vevor.com/support)**

# **VEVOR<sup>®</sup>**

## **TOUGH TOOLS, HALF PRICE**

Technisch Ondersteuning en e-garantiecertificaat [www.vevor.com/support](http://www.vevor.com/support)

# **HANGSTOEL**

## **HANDLEIDING**

We continue to be committed to provide you tools with competitive price.

"Save Half", "Half Price" or any other similar expressions used by us only represents an estimate of savings you might benefit from buying certain tools with us compared to the major top brands and does not necessarily mean to cover all categories of tools offered by us. You are kindly reminded to verify carefully when you are placing an order with us if you are actually saving half in comparison with the top major brands.

# VEVOR<sup>®</sup>

TOUGH TOOLS, HALF PRICE

## HAMMOCK CHAIR

LYY006 /LYY007 /LYY008



**NEED HELP? CONTACT US!**

Have product questions? Need technical support? Please feel free to contact us:

**Technical Support and E-Warranty Certificate**  
**[www.vevor.com/support](http://www.vevor.com/support)**

This is the original instruction, please read all manual instructions carefully before operating. VEVOR reserves a clear interpretation of our user manual. The appearance of the product shall be subject to the product you received. Please forgive us that we won't inform you again if there are any technology or software updates on our product.

## Veiligheidsmaatregelen

### WAARSCHUWING:

**Lees deze instructies** voordat u dit product gebruikt. Als u dit niet doet, kan dit leiden tot ernstig letsel. de basisvoorzorgsmaatregelen moeten altijd worden gevolgd , waaronder de volgende:







- Controleer nogmaals of alle moeren , bouten en schroeven goed vastzitten.
- Smeer beslag en ophangpunten regelmatig.
- Controleer het beslag en de ophangpunten op roest die hun onderdelen kan aantasten kracht. Vervang indien nodig.
- Controleer stoel , luchtkussen en tent op overmatige slijtage.
- Controleer de touwen op rafels , slijtage of breuk . Vervang ze indien nodig.
- Laat de tentschommel niet gedurende langere tijd buiten staan.
- In het winterseizoen wordt aanbevolen de tentschommel binnen op te bergen.
- Om schoon te maken , veegt u af met een vochtige doek.
- Bewaar op een droge plaats, uit de buurt van direct zonlicht.





- Dek het apparaat af of bewaar het in een zak als het gedurende langere tijd niet wordt gebruikt.



## BEWAAR DEZE INSTRUCTIES

### Productlijst

Naam	Onderdelen	Hoeveelheid _
Pod-schommel		1
PVC opblaasbaar kussen		1
Nylon riem		1
Karabijnhaak		1
Plafondmontage		1
Schroeven ( Voor betonnen plafond )		4
Schroeven ( Voor houten plafond )		4

Ik nflator		1
1/4 Ronde buis		4
Spons buizen		4

## Productparameter

Model	Lichaamskleur	Kleur zoom	Afbeelding _	Belastbaar _
<b>LYY009</b>	Paars poeder	Blauw		1 20 pond / 54 kg
<b>LYY010</b>	Blauw	Fruitgroen		1 20 pond / 54 kg
<b>LYY011</b>	Fruitgroen	Gras groen		1 20 pond / 54 kg

**Houd het luchtkussen eens per halve maand opgeblazen.**

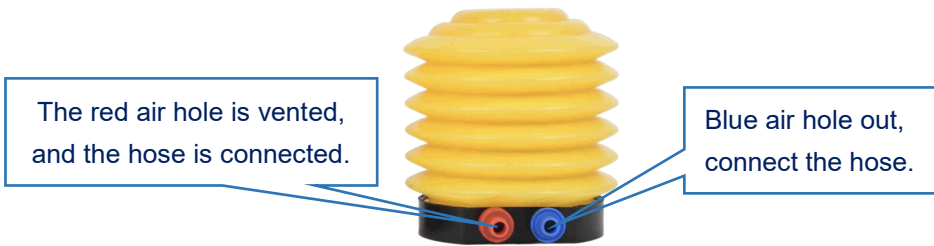

## **Gebruiksscenario \_ \_ \_**

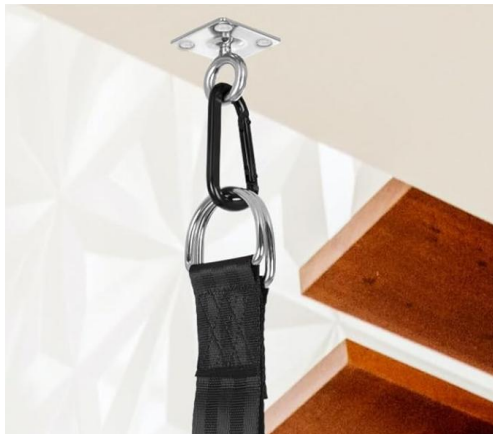

**Betonnen plafond**



**Houten plafond**



Hangmatstandaards



Boom

**Installatieprocedure voor betonnen plafonds**

A

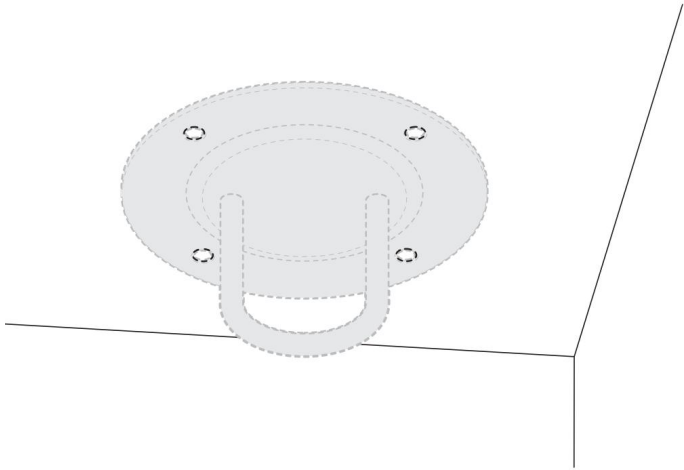

Lijn de plafondmontage uit en gebruik een potlood om de gewenste montagelocatie te markeren.

B

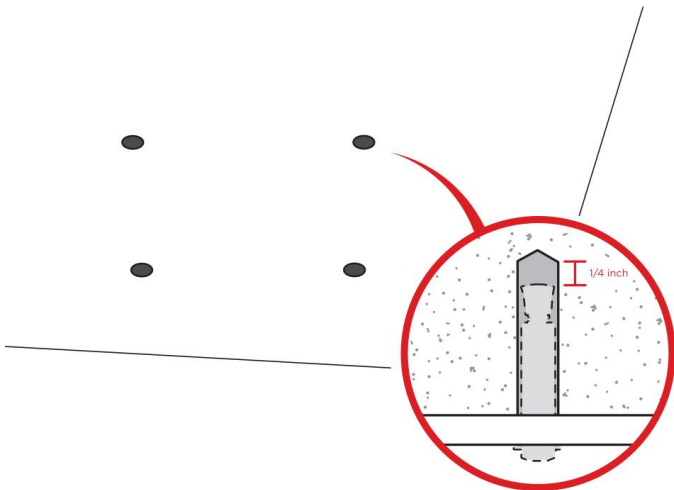

Boor vier gaten op de montageplaats.

**OPMERKING:** Boor ongeveer 1/4 inch dieper dan de lengte van het hulsanker.

C

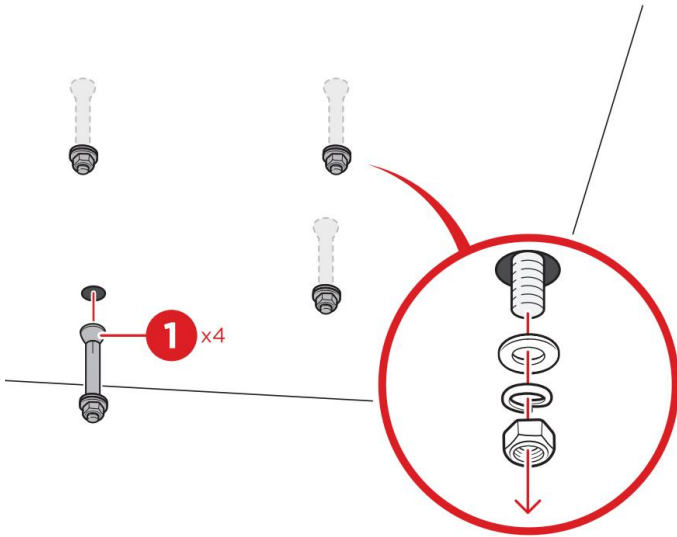

Steek vier deel 1-hulsankers in de gaten. Gebruik indien nodig een hamer. Verwijder de moeren/ringen van de hulsankers.

D

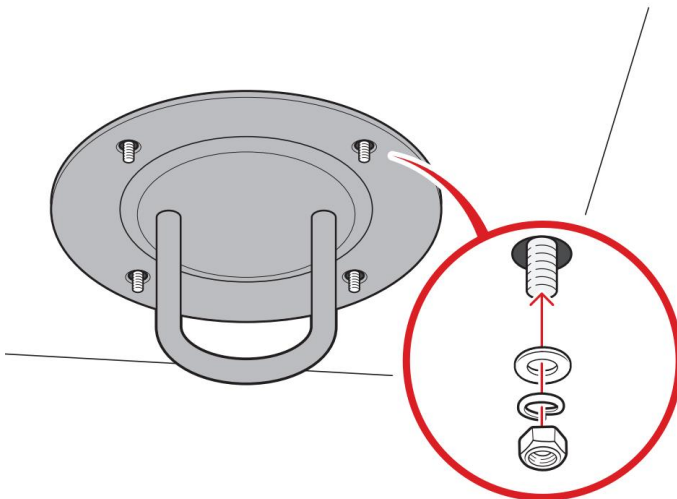

Plaats de houder en draai vervolgens de moeren vast om de houder vast te zetten.

# Installatieprocedure

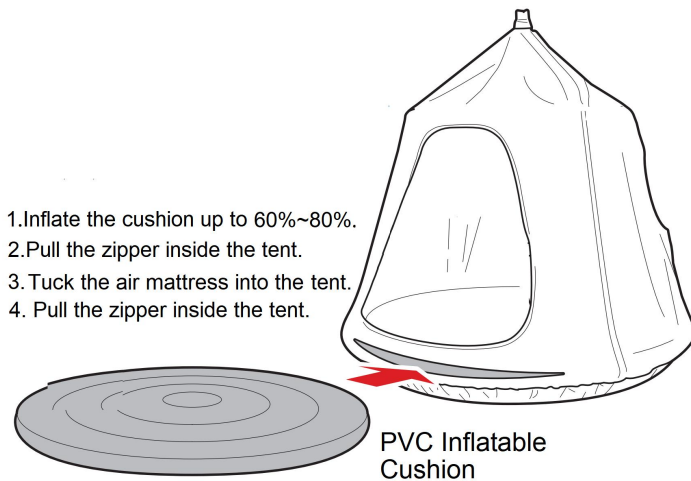
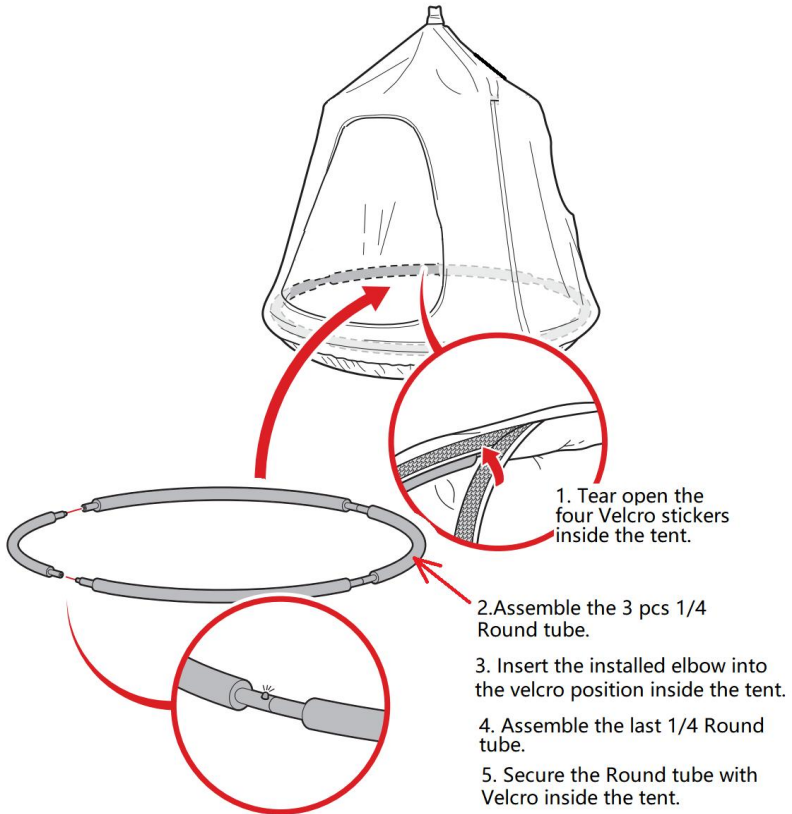

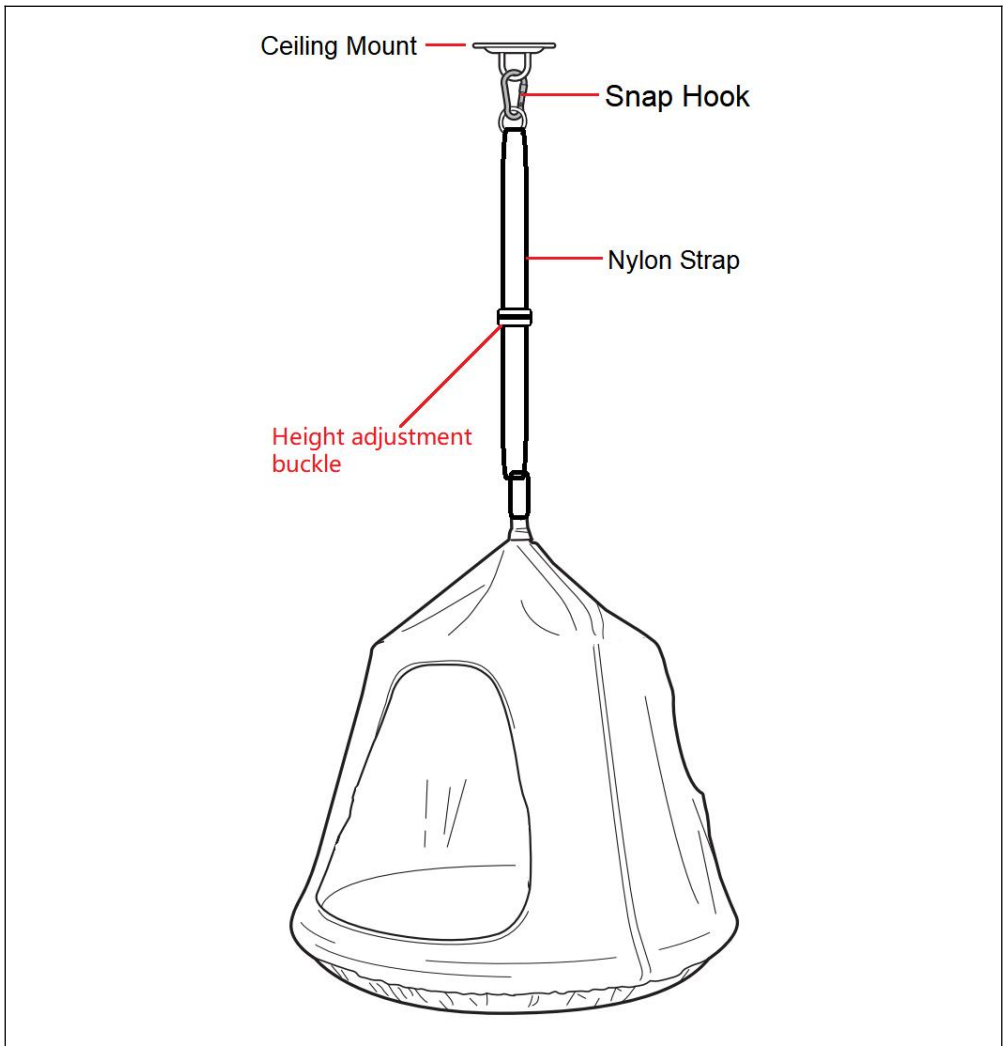

## **INSTALLATIETIPS**

- Zorg ervoor dat de bovenconstructie minimaal 25 kg kan dragen. Als u aan een boom hangt , moet de diameter van de boomtak 25 cm zijn.
- Laat volwassenen de bovenconstructie testen door deze naar beneden te trekken of in de schommel te gaan zitten.
- Niet installeren op beton , asfalt of harde grond.
- Schommel moet een valzone rondom de schommel hebben.



-De valzone moet minimaal 18 zijn inches op elk zijkant en tweemaal de schommelhoogte aan de voor-/achterkant.

- Plaats zachte vulling rond de schommel als de grond te hard is.
- Niet gebruiken op een plek met veel zonlicht. Zorg er bij warm weer voor dat het schommeloppervlak van de tent niet te warm is. De schommelhoogte moet 12 tot 18 inch boven de grond zijn.
- Swing moet hebben minimaal 6,5 meter boven het hoofd en een vrije ruimte aan de zijkant elke constructie of obstakel zoals een hek , garage , huis , takken , draden , enz.
- Installeer het apparaat op een plek vrij van draden , muren , constructies , meubels , enz.

**Adres:** Baoshanqu Shuangchenglu 803long 11hao 1602A-1609shi  
Shanghai

**Geïmporteerd naar AUS:** SIHAO PTY LTD, 1 ROKEVA  
STREETEASTWOOD NSW 2122 Australië

**Geïmporteerd naar de VS:** Sanven Technology Ltd., Suite 250, 9166  
Anaheim Place, Rancho Cucamonga, CA 91730



Pooledas Group Ltd  
Unit 5 Albert Edward House, The Pavilions  
Preston, United Kingdom



SHUNSHUN GmbH  
Römeräcker 9 Z2021, 76351  
Linkenheim-Hochstetten, Germany

**Gemaakt in China**

**VEVOR**<sup>®</sup>

**TOUGH TOOLS, HALF PRICE**

**Technisch Ondersteuning en e-garantiecertificaat**

**[www.vevor.com/support](http://www.vevor.com/support)**

# **VEVOR<sup>®</sup>**

**TOUGH TOOLS, HALF PRICE**

Teknisk Support och e-garanticertifikat [www.vevor.com/support](http://www.vevor.com/support)

## **HÄNGMATTA STOL**

### **ANVÄNDARMANUAL**

We continue to be committed to provide you tools with competitive price.

"Save Half", "Half Price" or any other similar expressions used by us only represents an estimate of savings you might benefit from buying certain tools with us compared to the major top brands and does not necessarily mean to cover all categories of tools offered by us. You are kindly reminded to verify carefully when you are placing an order with us if you are actually saving half in comparison with the top major brands.

# VEVOR®

TOUGH TOOLS, HALF PRICE

## HAMMOCK CHAIR

LYY006 /LYY007 /LYY008



**NEED HELP? CONTACT US!**

Have product questions? Need technical support? Please feel free to contact us:

**Technical Support and E-Warranty Certificate**  
**[www.vevor.com/support](http://www.vevor.com/support)**

This is the original instruction, please read all manual instructions carefully before operating. VEVOR reserves a clear interpretation of our user manual. The appearance of the product shall be subject to the product you received. Please forgive us that we won't inform you again if there are any technology or software updates on our product.

## Säkerhetsåtgärder

### **VARNING:**

**Läs dessa instruktioner** innan du använder denna produkt. Underlåtenhet att göra det kan resultera i allvarliga skador. de grundläggande försiktighetsåtgärderna bör alltid följas, inklusive följande:

- Bekräfta igen att alla muttrar , bultar och skruvar är åtdragna och säkra.
- Smörj hårdvara och upphängningspunkter regelbundet.
- Kontrollera hårdvara och hängpunkter för rost som kan påverka deras styrka.







Byt ut vid behov.



- Kontrollera sätet , luftkudden och tältet för överdrivet slitage .
- Kontrollera att repen inte är slitna , slitna eller går sönder . Byt ut dem vid behov.
- Lämna inte tältgungan utomhus under en längre tid.
- Under vintersäsongen rekommenderas att tältgungan förvaras inomhus .
- För att rengöra , torka av med en fuktig trasa.
- Förvara på en torr plats borta från direkt solljus.

- Täck över eller förvara i en påse om den inte används under en längre tid.



## SPARA DESSA INSTRUKTIONER

### Produktlista

namn	Delar	Kvantitet _
Pod Swing		1
Uppblåsbar PVC-kudde		1
Nylonrem		1
Snapkrok		1
Takmontering		1
Skrubar ( För betongtak )		4
Skrubar ( För trätak )		4

Jag nflator		1
1/4 Runt rör		4
Svamprör		4

## Produktparameter

Modell	Kroppsfärg	Fålla färg	Bild _	L bärande
<b>LYY009</b>	Lila pulver	Blå		1 20lb / 54kg
<b>LYY010</b>	Blå	Frukt grön		1 20lb / 54kg
<b>LYY011</b>	Frukt grön	Gräsgrön		1 20lb / 54kg

Håll luftkudden uppblåst en gång i halvmånaden.

The red air hole is vented,  
and the hose is connected.

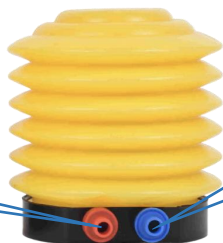

Blue air hole out,  
connect the hose.

## U sage S cenario

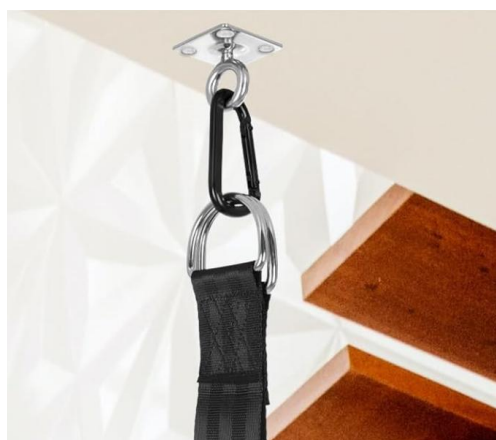

Betongtak



Trätak

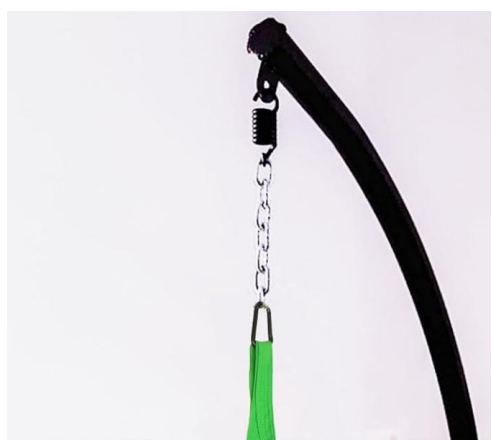



Hängmatta stativ

Träd

## Procedur för installation av betongtak

A

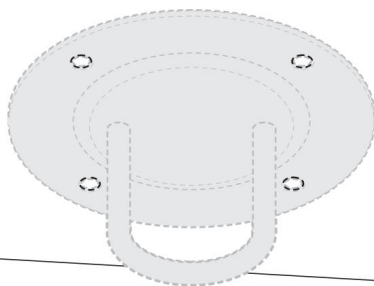

Rikta upp takfästet och använd en penna för att markera önskad monteringsplats.

B

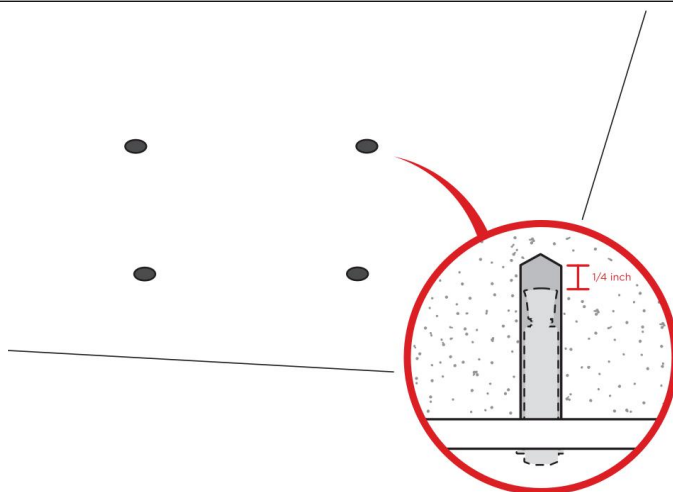

Borra fyra hål vid monteringsplatsen.  
OBS: Borra ungefär 1/4" djupare än längden på hylsankaret.

C

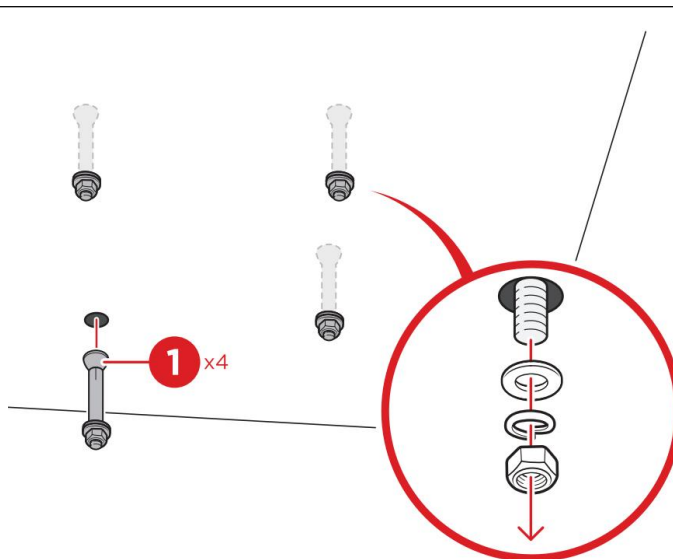

Sätt in fyra del 1-hylsankare i hålen. Använd en hammare om det behövs. Ta bort muttrarna/brickorna från hylsankare.

D

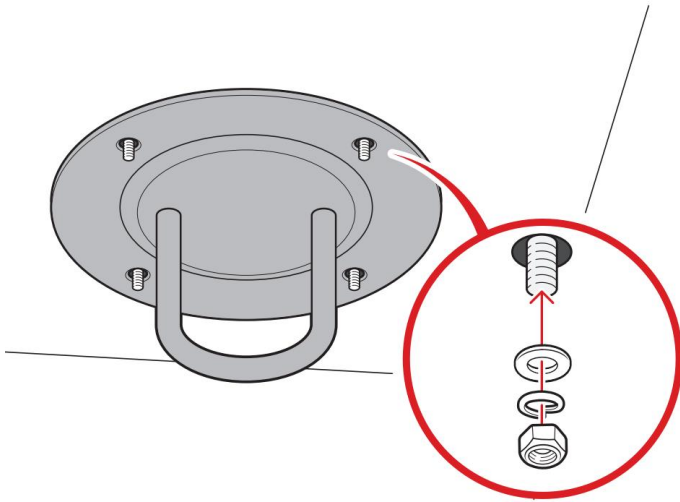

Placera fästet och dra sedan åt muttrarna för att säkra fästet.

## Installationsprocedur

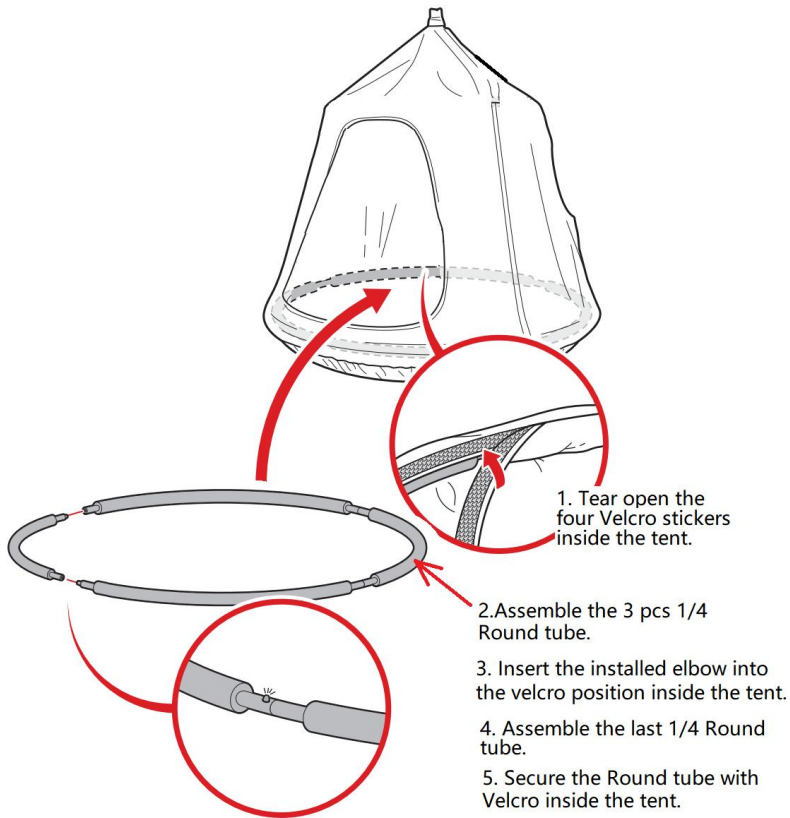

1. Inflate the cushion up to 60%~80%.
2. Pull the zipper inside the tent.
3. Tuck the air mattress into the tent.
4. Pull the zipper inside the tent.

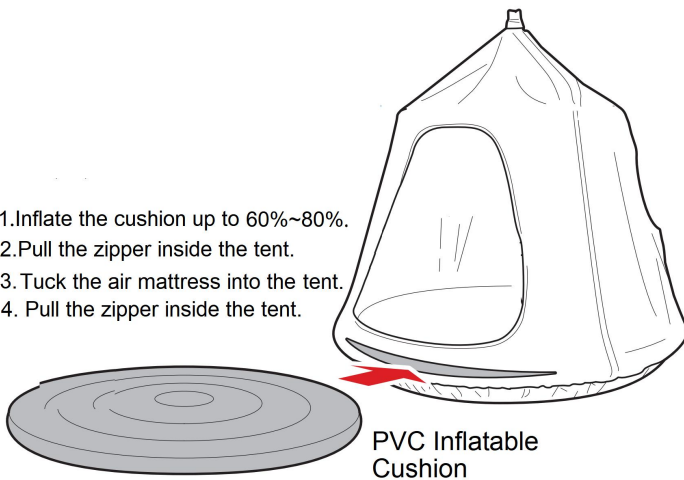

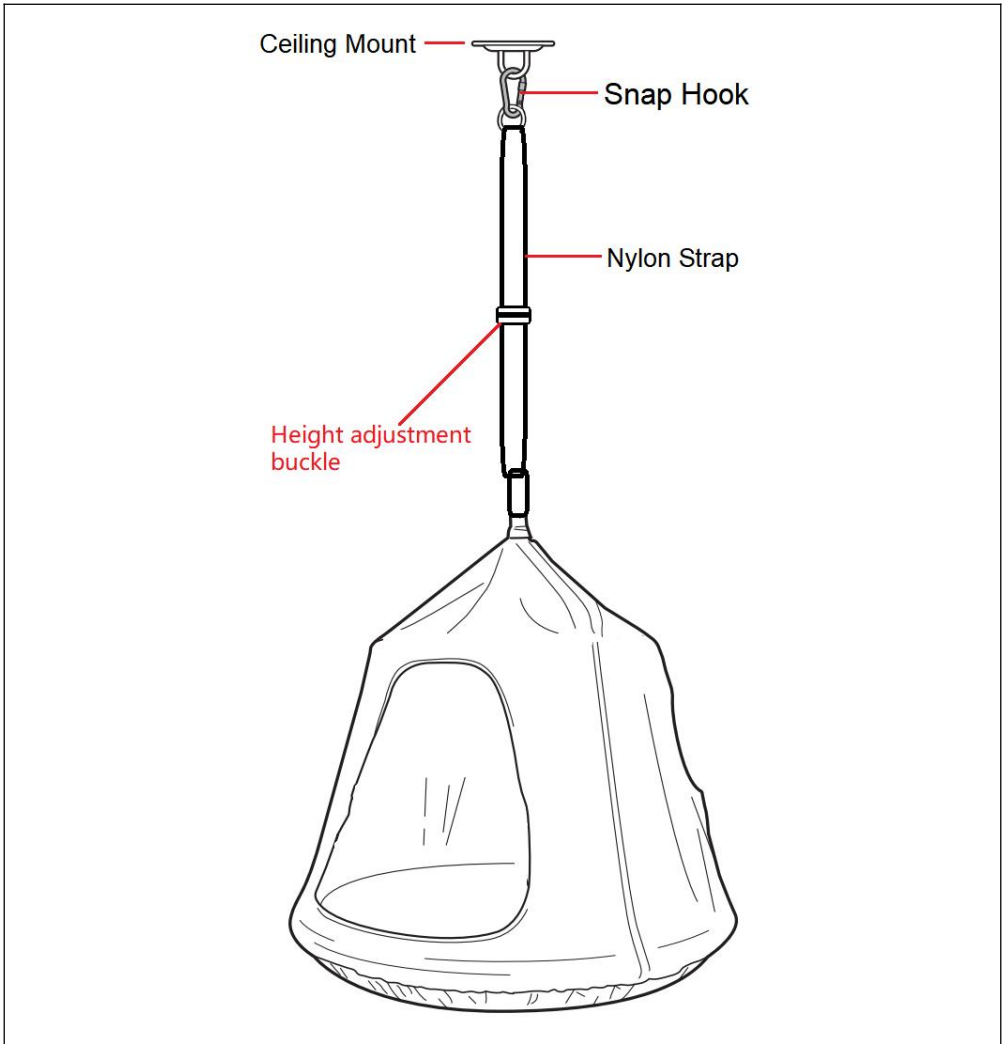

## **INSTALLATIONSTIPS**

- Se till att överliggande struktur kan bära minst 25 0lbs. Om den hänger i ett träd bör diametern på trädets gren vara 10 tum .
- Låt vuxna testa överliggande struktur genom att dra ner eller sitta i gungan.
- Installera inte över betong , asfalt eller hård mark .
- Gungan bör ha en fallzon som omger gungan.
- Fallzonen bör vara minst 18 tum på varje sida och dubbla gunghöjden fram/bak.

- Placera mjuk stoppning runt gungan om underlaget är för hårt.
- Använd inte på en plats med starkt solljus. Vid varmt väder, se till att tältets gungyta inte är för varm. Svänghöjden bör vara 12 till 18 tum över marken.
- Gunga måste ha kl minst 6,5 fot av overhead och sidoavstånd från någon struktur eller hinder som ett staket , garage , hus , grenar , ledningar , etc.
- Installera i ett område fritt från ledningar , väggar , strukturer , möbler etc.

**Adress:** Baoshanqu Shuangchenglu 803long 11hao 1602A-1609shi  
Shanghai

**Importerad till AUS:** SIHAO PTY LTD, 1 ROKEVA STREETEASTWOOD  
NSW 2122 Australien

**Importerad till USA:** Sanven Technology Ltd., Suite 250, 9166 Anaheim  
Place, Rancho Cucamonga, CA 91730



Pooledas Group Ltd  
Unit 5 Albert Edward House, The Pavilions  
Preston, United Kingdom



SHUNSHUN GmbH  
Römeräcker 9 Z2021, 76351  
Linkenheim-Hochstetten, Germany

**Tillverkad i Kina**

**VEVOR**<sup>®</sup>

**TOUGH TOOLS, HALF PRICE**

**Teknisk Support och e-garanticertifikat**

**[www.vevor.com/support](http://www.vevor.com/support)**