

VEVOR[®]

TOUGH TOOLS, HALF PRICE

Technical Support and E-Warranty Certificate www.vevor.com/support

DOME TUNNEL GREENHOUSE USER MANUAL

We continue to be committed to provide you tools with competitive price.

"Save Half", "Half Price" or any other similar expressions used by us only represents an estimate of savings you might benefit from buying certain tools with us compared to the major top brands and does not necessarily mean to cover all categories of tools offered by us. You are kindly reminded to verify carefully when you are placing an order with us if you are actually saving half in comparison with the top major brands.

VEVOR[®]

TOUGH TOOLS, HALF PRICE

DOME TUNNEL GREENHOUSE

Model: 12*7*7 ft (Green)



NEED HELP? CONTACT US!

Have product questions? Need technical support? Please feel free to contact us:

Technical Support and E-Warranty Certificate
www.vevor.com/support

This is the original instruction, please read all manual instructions carefully before operating. VEVOR reserves a clear interpretation of our user manual. The appearance of the product shall be subject to the product you received. Please forgive us that we won't inform you again if there are any technology or software updates on our product.

GENERAL SAFETY RULES

WARNING:

1. Please read this manual carefully before using the product.
2. Flammable: Keep away from open flame. This product will ignite and burn if brought into contact with an open flame.
3. Keep away from sharp points, blades and other items, so as not to scratch the product.
4. This product is not a toy, dome tunnel greenhouse cannot be used as toys for children to play with.
5. Keep away from rain, water, hail, etc. to avoid damaging the documents in your bag .

SAVE THESE INSTRUCTION

SPECIFICATIONS

Model	12*7*7 ft (Green)
Product Size	3.5×2×2m
Color	Green

Please carefully follow assembly instruction. Suggested 2-4 person to construction.

COMPONENTS

NO.	1	2	3	4	5	6	7	7A	8	9	10	11	12	13	14	15	16	17	18
	4PCS	4PCS	2PCS	2PCS	12PCS	4PCS	2PCS	2PCS	10PCS	5PCS	24PCS	12PCS	36PCS	1PC	1PC	4PCS	4PCS	1PC	10PCS

Assembly Instructions

STEP1 Main Structure

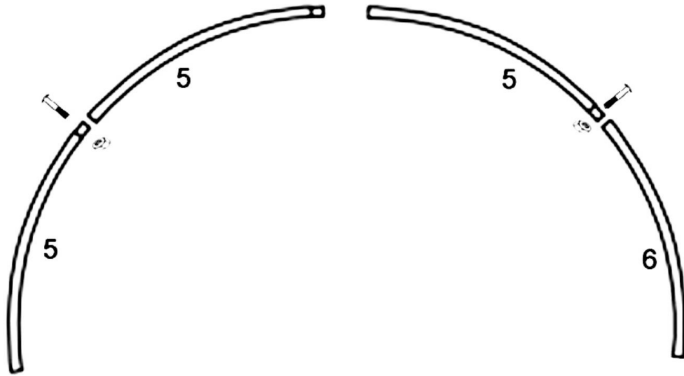

Assemble each 4 sets No.5+No.5 together, make them into one part first, use the shorter bolts, put the curve tube on the flat ground, make both tubes horizontal, then tighten the nuts. And assemble for 4 sets No.5+No.6 in the same way.

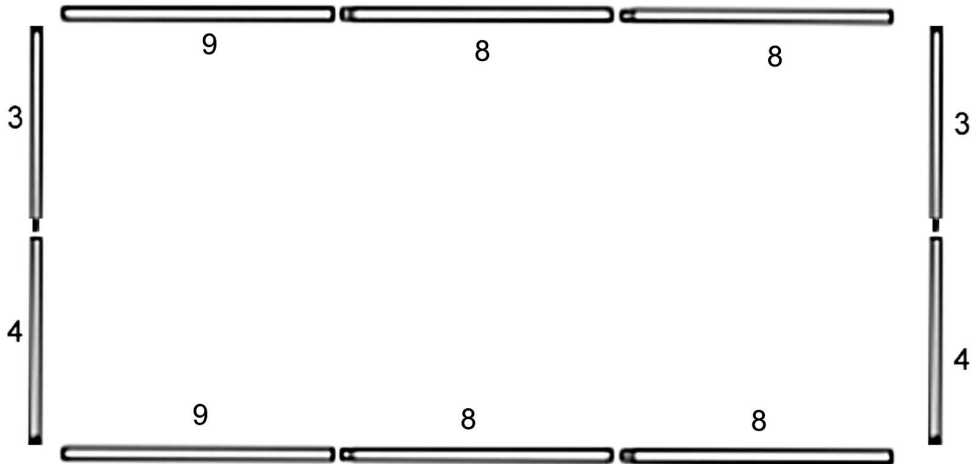

Assemble for 2 sets floor tubes No3 + No4 use the shorter bolts, and the horizontal frame No9+No8+No8 together.



Assemble for 2 sets support diagonal tubes No7 + No7A use the shorter bolts.

STEP2

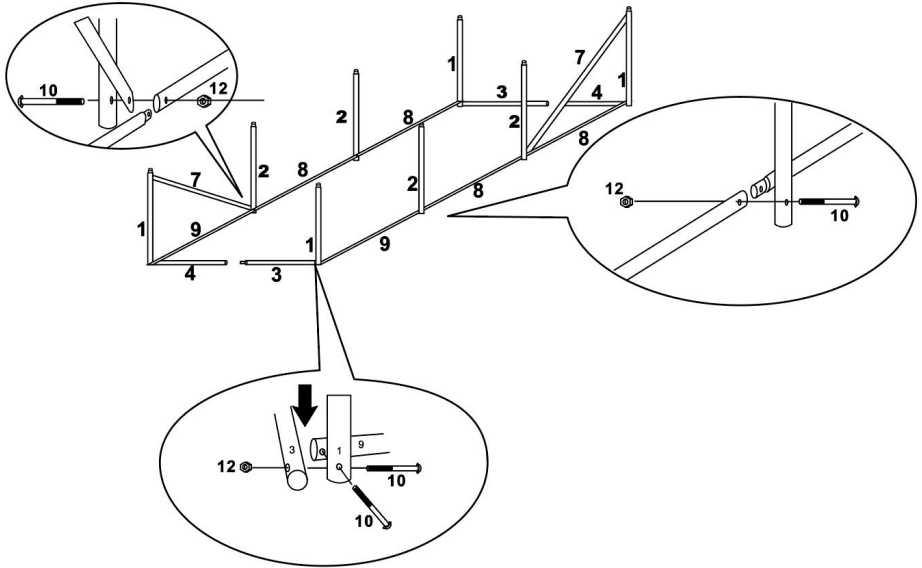

Loosely assemble complete frame, before tightening all bolts in final position.

STEP3

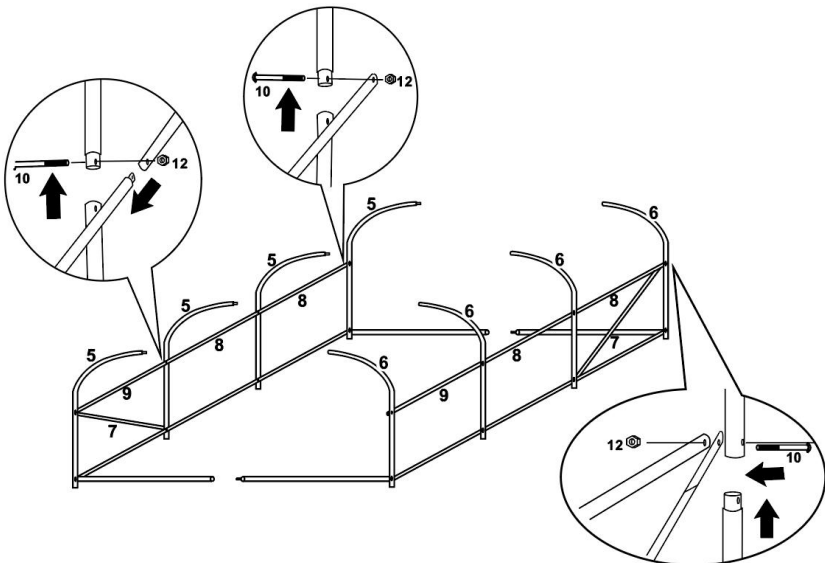

Loosely assemble complete frame, before tightening all bolts in final position.

STEP4

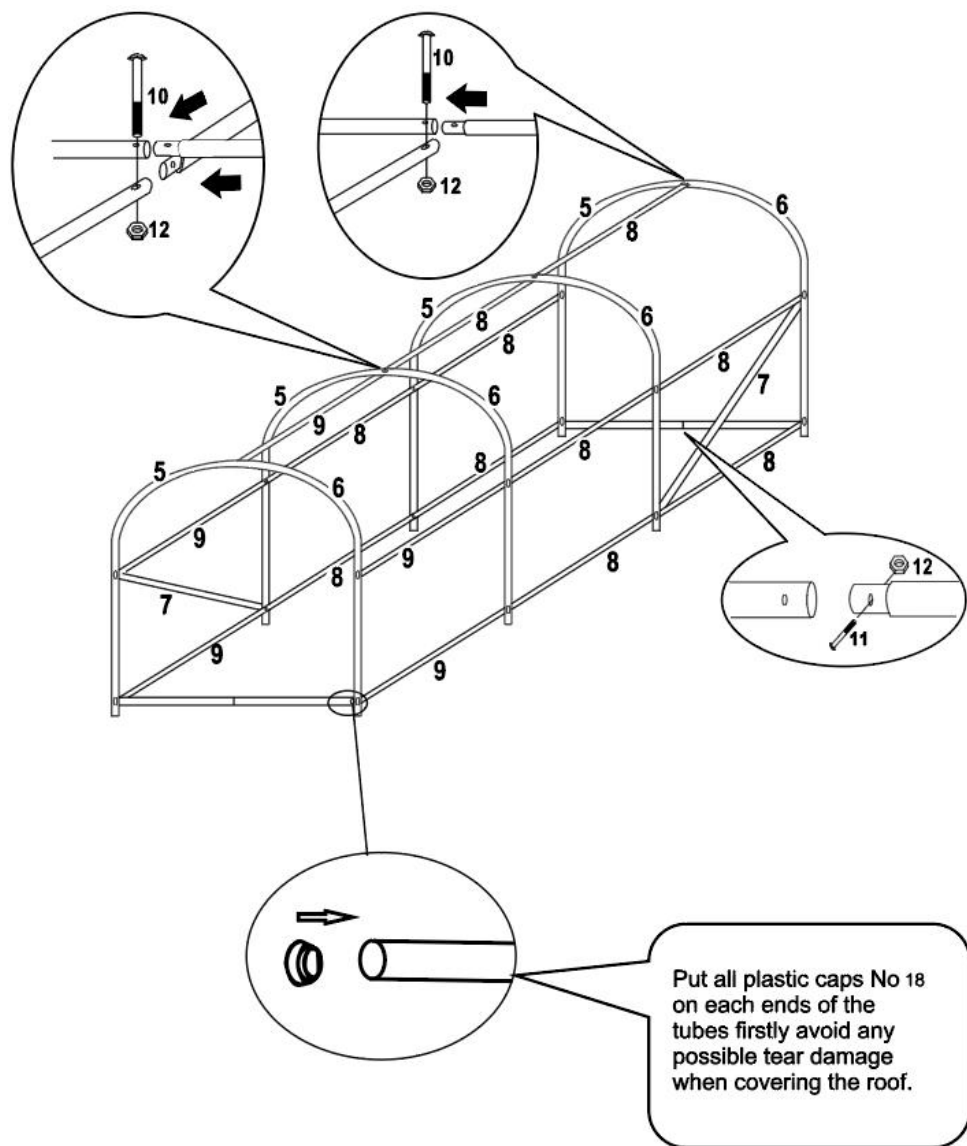

Loosely assemble completed frame before tightening all bolts in final position.

STEP5

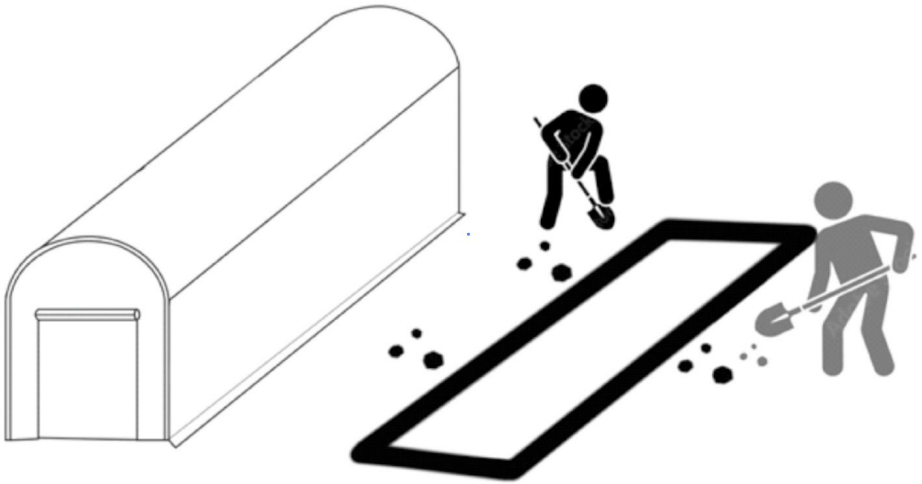

For maximum stability of your polytunnel, we recommend digging a 20cm width trench around the base of the polytunnel and back.

Put the frame inside the trench, filling with the soil.

STEP6

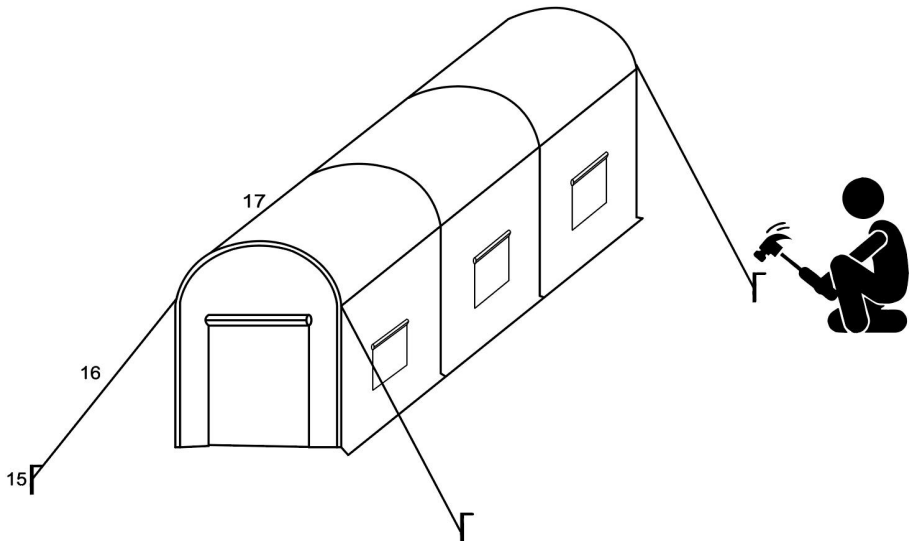

Tied the string in the back of the cover to the frame. Use the ropes and stakes for four corners of the greenhouse, to reinforce the stability of it.

WARNING

Covering the roof carefully, puts all places in the right position. As much as possible as not make the frame structure of the greenhouse out of the shape.

Do not use it in bad weather conditions, such as a rainstorm, hailstone, heavy snow, and heavy wind.

Manufacturer: Shanghaimuxinmuyeyouxiangongsi

Address: Shuangchenglu 803nong11hao1602A-1609shi, baoshanqu, shanghai 200000 CN.

EC REP: E-CrossStu GmbH.

Mainzer Landstr.69, 60329 Frankfurt am Main.

UK REP: YH CONSULTING LIMITED.

C/O YH Consulting Limited Office 147, Centurion House, London Road, Staines-upon-Thames, Surrey, TW18 4AX

Imported to AUS: SIHAO PTY LTD.

1 ROKEVA STREETEASTWOOD NSW 2122 Australia

Imported to USA: Sanven Technology Ltd.

Suite 250, 9166 Anaheim Place, Rancho Cucamonga, CA 91730

VEVOR[®]

TOUGH TOOLS, HALF PRICE

Technical Support and E-Warranty Certificate

www.vevor.com/support

VEVOR®

TOUGH TOOLS, HALF PRICE

Wsparcie techniczne i certyfikat gwarancji elektronicznej www.vevor.com/support

INSTRUKCJA OBSŁUGI SZKLARNI TUNELOWEJ DOME

Nadal staramy się oferować Państwu narzędzia w konkurencyjnych cenach.

„Oszczędź połowę”, „Połowa ceny” lub inne podobne wyrażenia używane przez nas stanowią jedynie szacunkowe oszczędności, jakie możesz uzyskać, kupując u nas określone narzędzia w porównaniu z głównymi markami i niekoniecznie oznaczają one objęcie wszystkich kategorii narzędzi oferowanych przez nas. Uprzejmie przypominamy, aby dokładnie sprawdzić, czy składając u nas zamówienie faktycznie oszczędzasz połowę w porównaniu z głównymi markami.

VEVOR[®]

TOUGH TOOLS, HALF PRICE

SZKLARNIA TUNELOWA KOPUŁOWA

Model: 12*7*7 stóp (zielony)



POTRZEBUJESZ POMOCY? SKONTAKTUJ SIĘ Z NAMI!

Masz pytania dotyczące produktu? Potrzebujesz wsparcia technicznego? Skontaktuj się z nami:

Wsparcie techniczne i certyfikat gwarancji
elektronicznej www.vevor.com/support

To jest oryginalna instrukcja, przed użyciem należy uważnie przeczytać wszystkie instrukcje. VEVOR zastrzega sobie jasną interpretację naszej instrukcji obsługi. Wygląd produktu będzie zależał od produktu, który otrzymałeś. Prosimy o wybaczenie, że nie poinformujemy Cię ponownie, jeśli w naszym produkcie pojawią się jakiegokolwiek aktualizacje technologiczne lub oprogramowania.

OGÓLNE ZASADY BEZPIECZEŃSTWA

OSTRZEŻENIE:

1. Przed użyciem produktu należy uważnie przeczytać niniejszą instrukcję.
 2. Łatwopalny: Trzymać z dala od otwartego ognia. Ten produkt zapali się i spali, jeśli zetknąć się z otwartym ogniem.
 3. Trzymaj z dala od ostrych punktów, ostrzy i innych przedmiotów, aby nie porysować Produktu.
 4. Ten produkt nie jest zabawką, tunel szklarniowy kopułowy nie może być używany jako zabawka do zabawy dla dzieci.
 5. Trzymaj dokumenty z dala od deszczu, wody, gradu itp., aby uniknąć ich uszkodzenia.
- Twoja torba.



















ZAPISZ TĘ INSTRUKCJĘ

SPECYFIKACJE

Model	12*7*7 stóp (zielony)
Rozmiar produktu	3,5×2×2m
Kolor	Zielony

Prosimy o dokładne zapoznanie się z instrukcją montażu. Zalecane jest, aby montaż wykonywały 2-4 osoby. budowa.

SKŁADNIKI

NO.	1	2	3	4	5	6	7	7A	8	9	10	11	12	13	14	15	16	17	18
																			
	4PCS	4PCS	2PCS	2PCS	12PCS	4PCS	2PCS	2PCS	10PCS	5PCS	24PCS	12PCS	36PCS	1PC	1PC	4PCS	4PCS	1PC	10PCS

Instrukcja montażu

STEP1 Główna struktura

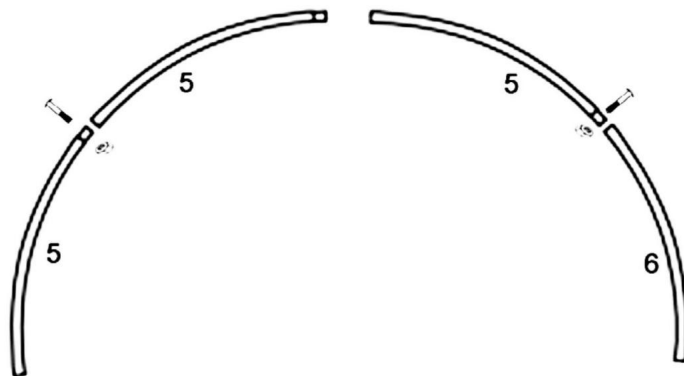

Złóż 4 zestawy nr 5+nr 5 razem, najpierw połącz je w jedną część, użyj krótszego śruby, połóż rurę zakrzywioną na płaskim podłożu, ustaw obie rury poziomo, a następnie dokręć orzechy. I zmontuj 4 zestawy nr 5+nr 6 w ten sam sposób.

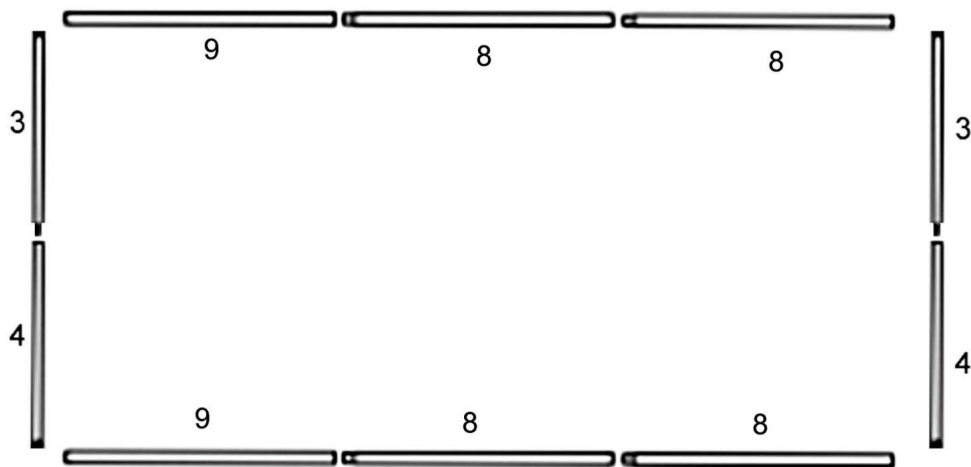

Złóż 2 zestawy rur podłogowych nr 3 i nr 4, używając krótszych śrub i poziomej ramy Nr 9+Nr 8+Nr 8 razem.



Złóż 2 zestawy wsporników rur skośnych nr 7 + nr 7A, używając krótszych śrub.

KROK 2

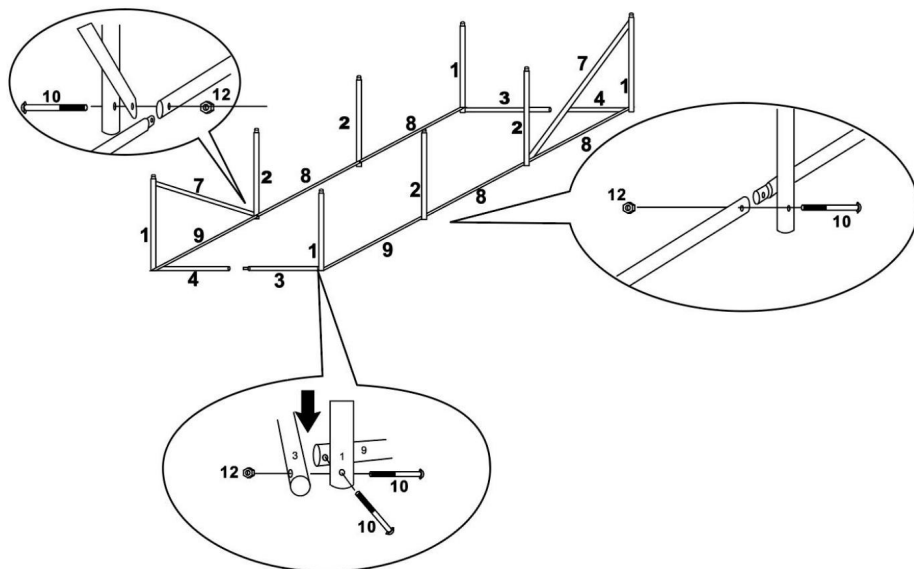

Luźno zmontuj całą ramę, przed dokręceniem wszystkich śrub w pozycji końcowej.

KROK 3

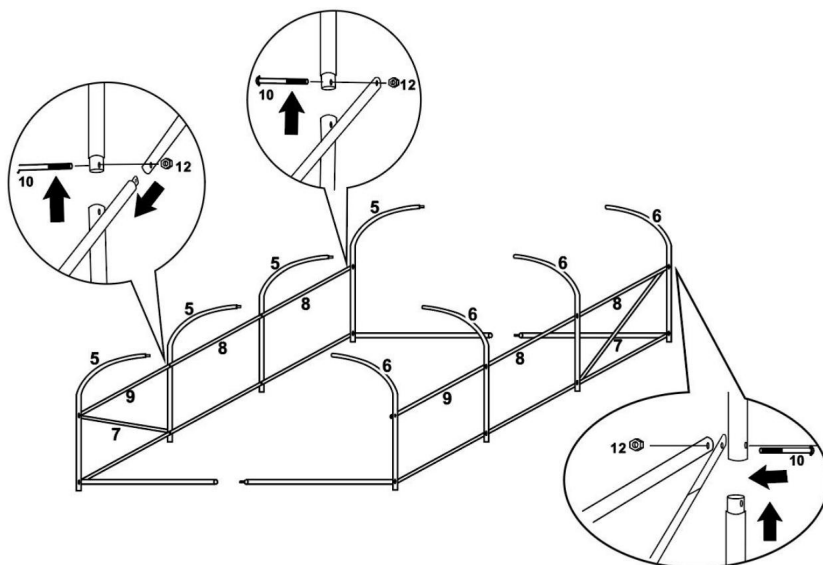

Luźno zmontuj całą ramę, przed dokręceniem wszystkich śrub w pozycji końcowej.

KROK 4

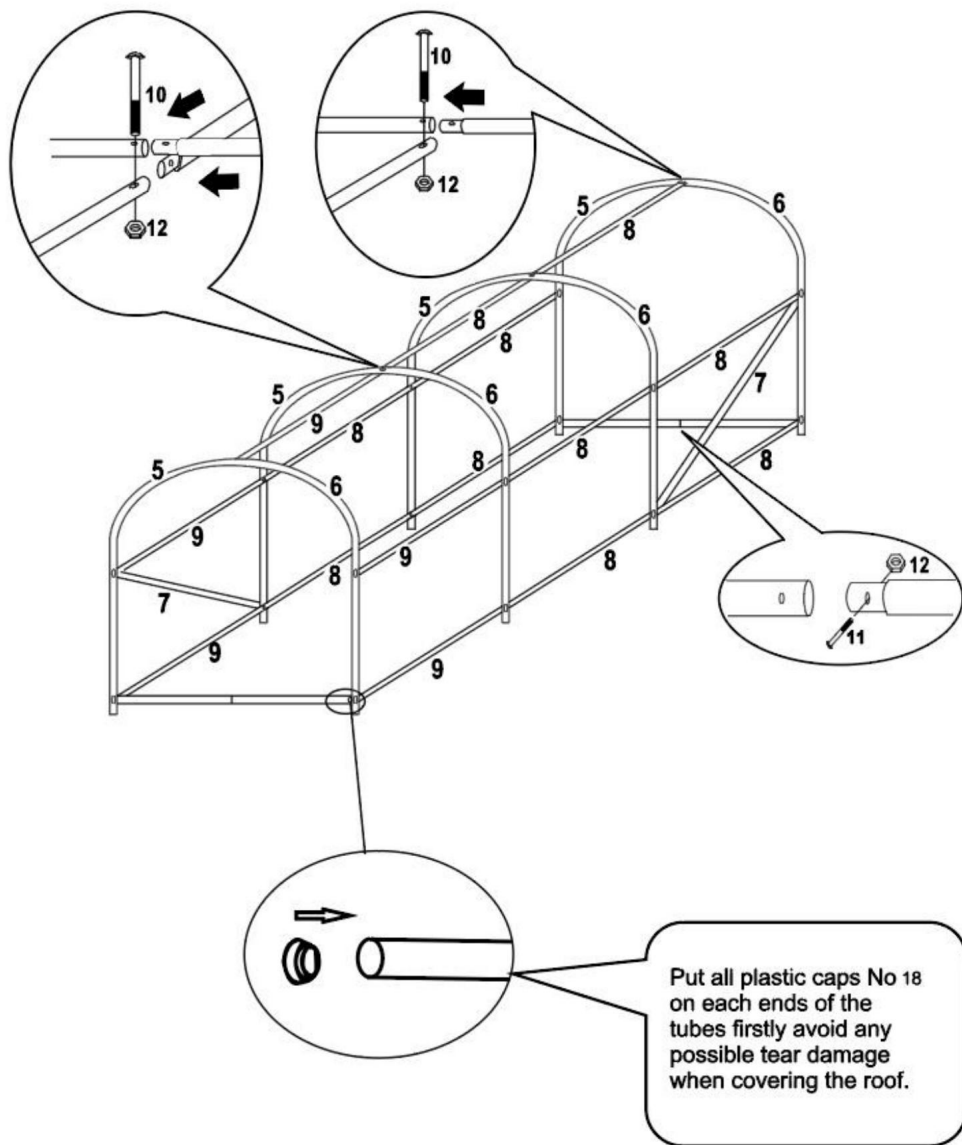

Luźno zmontuj gotową ramę, a następnie dokręć wszystkie śruby w ostatecznej pozycji.

KROK 5

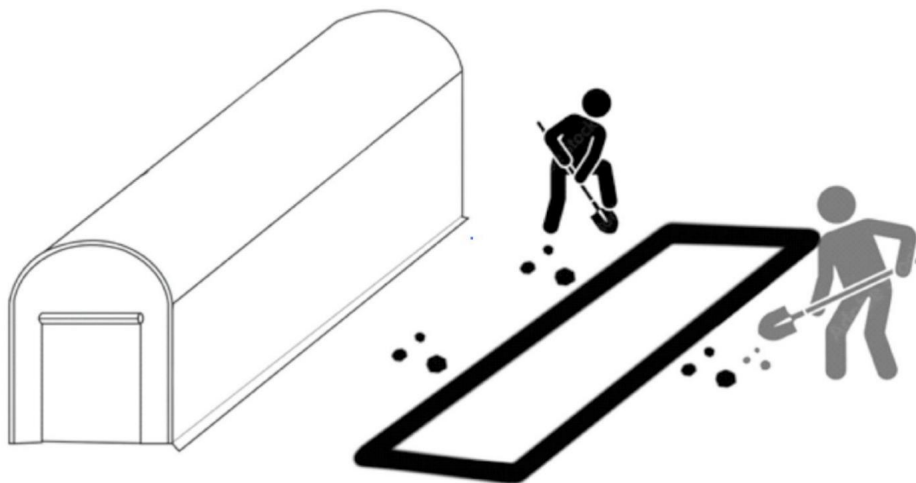

Aby zapewnić maksymalną stabilność tunelu foliowego, zalecamy wykopanie rowu o szerokości 20 cm wokół podstawy tunelu foliowego i z tyłu.

Umieść ramę w wykopie i wypełnij ją ziemią.

KROK 6

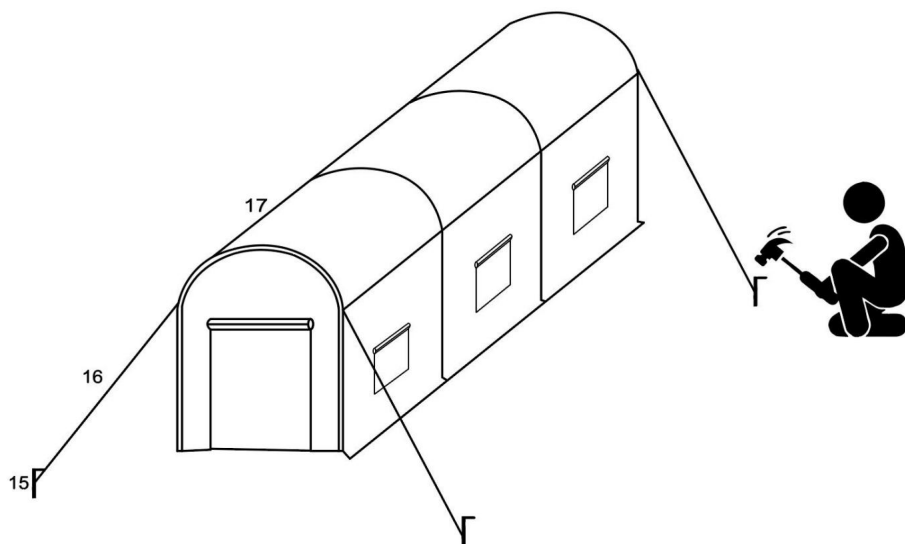

Przywiąż sznurek z tyłu pokrywy do ramy. Użyj lin i kołków do czterech narożników szklarni, aby zwiększyć jej stabilność.

OSTRZEŻENIE

Starannie pokrywając dach, umieszczamy wszystkie miejsca we właściwej pozycji. W miarę możliwości nie wykonać konstrukcję szkieletową szklarni z tego kształtu.

Nie należy używać urządzenia w niesprzyjających warunkach pogodowych, takich jak ulewa, grad, obfite opady śniegu i silny wiatr.

Producent: Shanghaimuxinmuyeyouxiangongsi

Adres: Shuangchenglu 803nong11hao1602A-1609shi, baoshanqu, szanghaj 200000 CN.

Przedstawiciel KE: E-CrossStu GmbH.

Mainzer Landstr.69, 60329 Frankfurt nad Menem.

ODPOWIEDZIALNOŚĆ W WIELKIEJ BRYTANII: YH CONSULTING LIMITED.

C/O YH Consulting Limited Biuro 147, Centurion House, London Road, Staines-upon-Thames, Surrey, TW18 4AX

Importowane do AUS: SIHAO PTY LTD.

1 ROKEVA STREETEASTWOOD NSW 2122 Australia

Importowane do USA: Sanven Technology Ltd.

Apartament 250, 9166 Anaheim Place, Rancho Cucamonga, CA 91730

VEVOR®

TOUGH TOOLS, HALF PRICE

Wsparcie techniczne i certyfikat gwarancji
elektronicznej www.vevor.com/support

VEVOR[®]

TOUGH TOOLS, HALF PRICE

Supporto tecnico e certificato di garanzia elettronica www.vevor.com/support

MANUALE D'USO DELLA SERRA A TUNNEL A CUPOLA

Continuiamo a impegnarci per fornirvi strumenti a prezzi competitivi.

"Risparmia la metà", "Metà prezzo" o qualsiasi altra espressione simile da noi utilizzata rappresenta solo una stima del risparmio che potresti ottenere acquistando determinati utensili con noi rispetto ai principali marchi principali e non significa necessariamente coprire tutte le categorie di utensili da noi offerti. Ti ricordiamo gentilmente di verificare attentamente quando effettui un ordine con noi se stai effettivamente risparmiando la metà rispetto ai principali marchi principali.

VEVOR[®]
TOUGH TOOLS, HALF PRICE

SERRA A CUPOLA A TUNNEL

Modello: 12*7*7 piedi (verde)



HAI BISOGNO DI AIUTO? CONTATTACI!

Hai domande sui prodotti? Hai bisogno di supporto tecnico? Non esitare a contattarci:

**Supporto tecnico e certificato di garanzia
elettronica www.vevor.com/support**

Questa è l'istruzione originale, si prega di leggere attentamente tutte le istruzioni del manuale prima di utilizzare. VEVOR si riserva una chiara interpretazione del nostro manuale utente. L'aspetto del prodotto sarà soggetto al prodotto ricevuto. Vi preghiamo di perdonarci se non vi informeremo di nuovo se ci sono aggiornamenti tecnologici o software sul nostro prodotto.

NORME GENERALI DI SICUREZZA

AVVERTIMENTO:

1. Leggere attentamente il presente manuale prima di utilizzare il prodotto.
2. Infiammabile: tenere lontano da fiamme libere. Questo prodotto si accenderà e brucerà se portato a contatto con una fiamma libera.
3. Tenere lontano da punte affilate, lame e altri oggetti, per non graffiare il prodotto.
4. Questo prodotto non è un giocattolo, la serra a cupola non può essere utilizzata come giocattolo per far giocare i bambini.
5. Tenere lontano da pioggia, acqua, grandine, ecc. per evitare di danneggiare i documenti in la tua borsa.















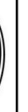



SALVA QUESTE ISTRUZIONI

SPECIFICHE

Modello	12*7*7 piedi (verde)
Dimensioni del prodotto	3,5x2x2m
Colore	Verde

Si prega di seguire attentamente le istruzioni di montaggio. Si consiglia di utilizzare da 2 a 4 persone. costruzione.

COMPONENTI

NO.	1	2	3	4	5	6	7	7A	8	9	10	11	12	13	14	15	16	17	18
																			
	4PCS	4PCS	2PCS	2PCS	12PCS	4PCS	2PCS	2PCS	10PCS	5PCS	24PCS	12PCS	36PCS	1PC	1PC	4PCS	4PCS	1PC	10PCS

Istruzioni di montaggio

STEP1 Struttura principale

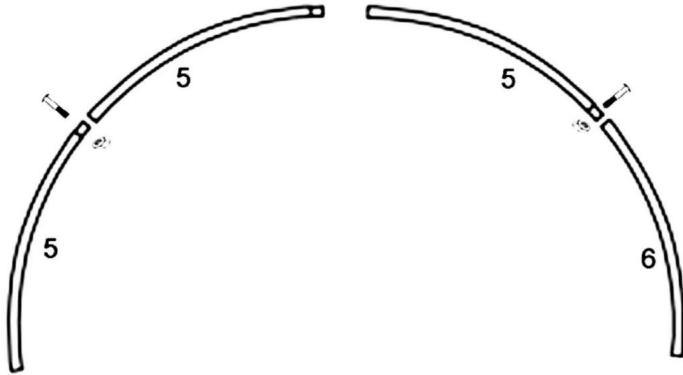

Assemblare insieme 4 set n. 5+n. 5, prima trasformarli in una parte, usare il più corto bulloni, posizionare il tubo curvo su un terreno pianeggiante, rendere entrambi i tubi orizzontali, quindi serrare i noci. E assemblare per 4 set No.5+No.6 nello stesso modo.

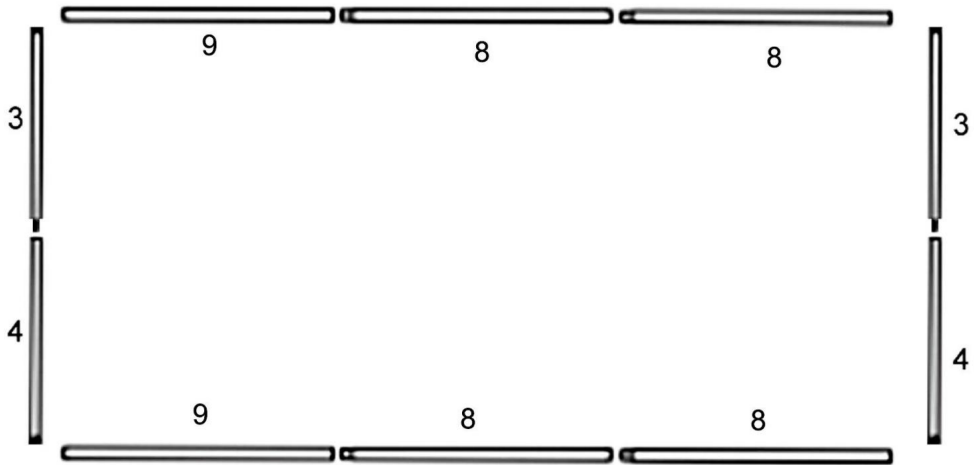

Assemblare per 2 set tubi del pavimento n. 3 + n. 4 utilizzare i bulloni più corti e il telaio orizzontale No9+No8+No8 insieme.



Assemblare 2 set di tubi diagonali di supporto No7 + No7A utilizzando i bulloni più corti.

PASSO 2

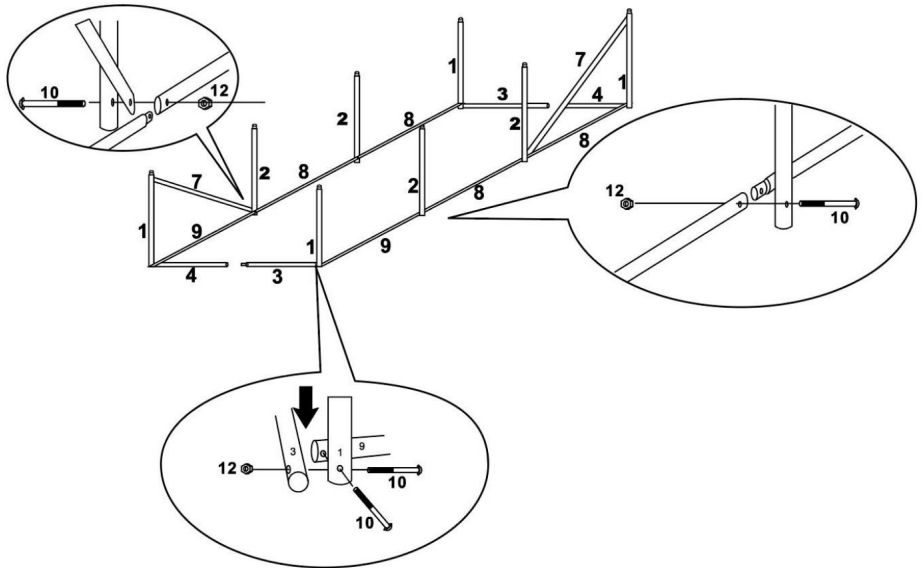

Assemblare il telaio completo senza stringerlo troppo prima di serrare tutti i bulloni nella posizione finale.

PASSO 3

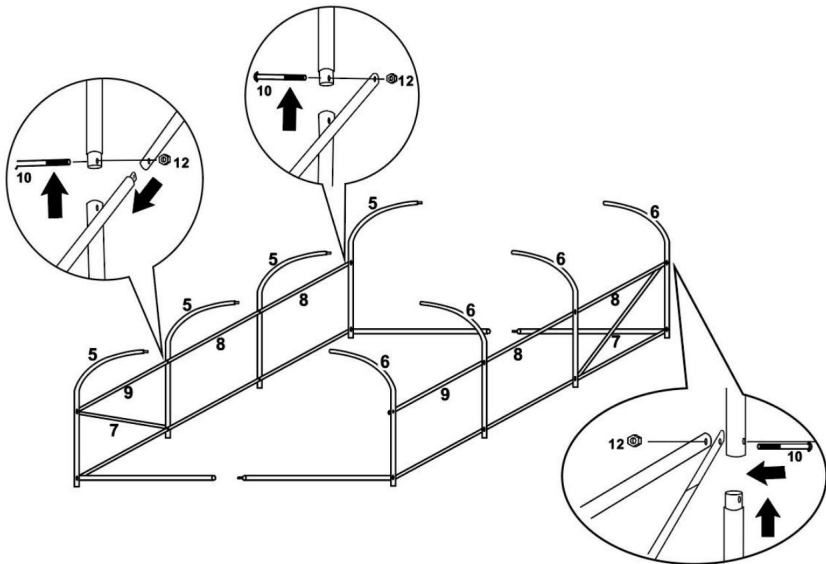

Assemblare il telaio completo senza stringerlo troppo prima di serrare tutti i bulloni nella posizione finale.

PASSO4

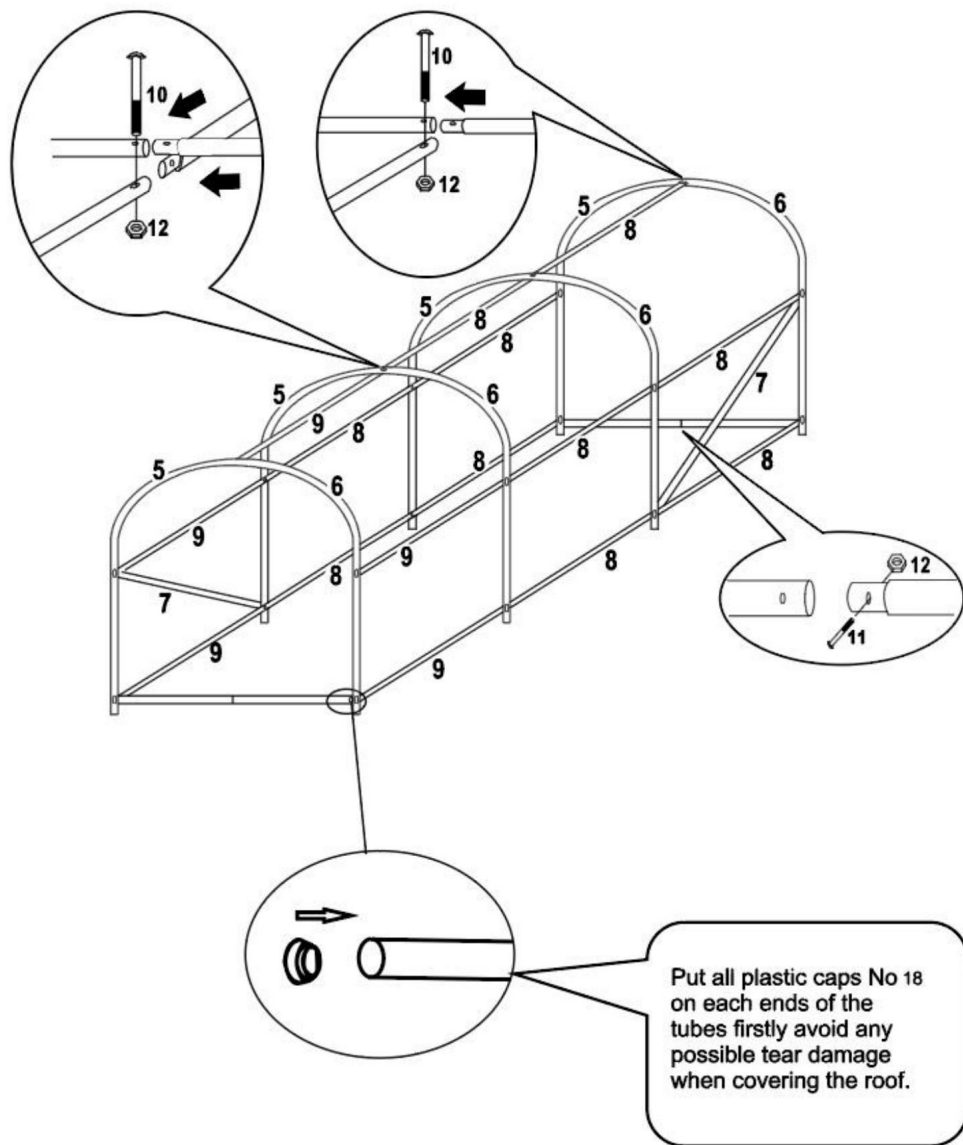

Assemblare il telaio completato senza stringerlo troppo prima di serrare tutti i bulloni nella posizione finale.

PASSO 5

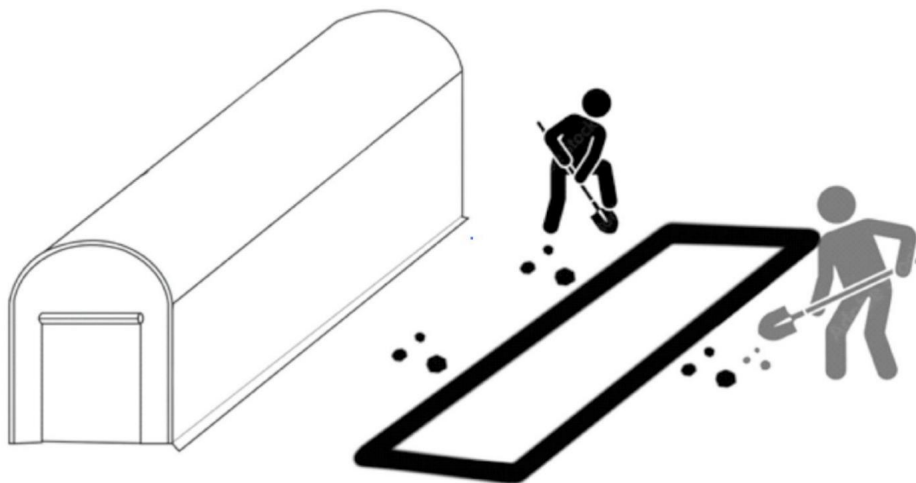

Per la massima stabilità del tuo polytunnel, ti consigliamo di scavare una trincea larga 20 cm attorno alla base della serra e ritorno.

Posizionare il telaio all'interno della trincea e riempirlo con il terreno.

PASSO6

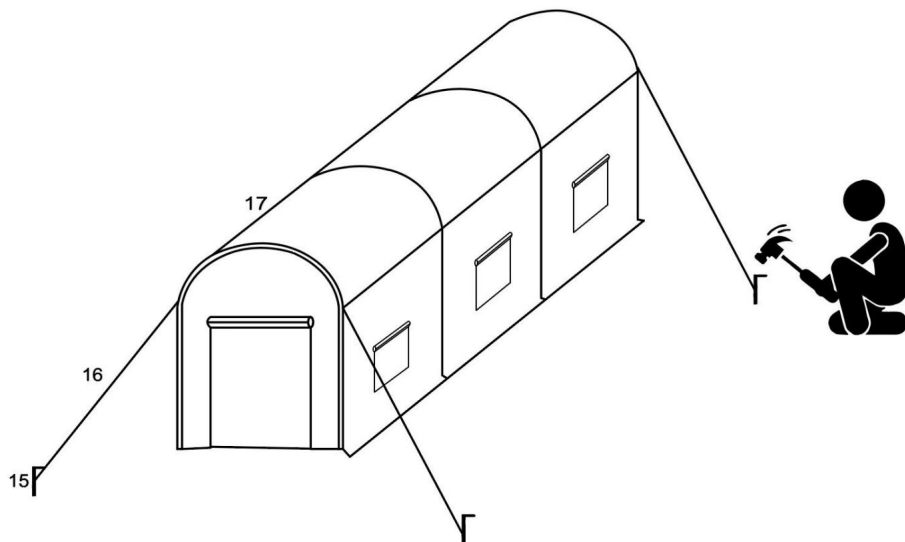

Legare la corda nella parte posteriore della copertura al telaio. Utilizzare le corde e i picchetti per quattro angoli della serra, per rafforzarne la stabilità.

AVVERTIMENTO

Coprendo attentamente il tetto, mette tutti i posti nella posizione giusta. Per quanto possibile, non ricavare la struttura portante della serra dalla sagoma.

Non utilizzarlo in condizioni meteorologiche avverse, come temporali, grandine, forti neviccate e vento forte.

Produttore: Shanghaimuxinmuyeyouxiangongsi

Indirizzo: Shuangchenglu 803nong11hao1602A-1609shi, baoshanqu, shanghai 200000 CN.

RAPPRESENTANTE CE: E-CrossStu GmbH.

Mainzer Landstr.69, 60329 Francoforte sul Meno.

RAPPRESENTANTE DEL REGNO UNITO: YH CONSULTING LIMITED.

C/O YH Consulting Limited Ufficio 147, Centurion House, London Road, Staines-upon-Thames, Surrey, TW18 4AX

Importato in AUS: SIHAO PTY LTD.

1 ROKEVA STREET EASTWOOD NSW 2122 Australia

Importato negli USA: Sanven Technology Ltd.

Suite 250, 9166 Anaheim Place, Rancho Cucamonga, CA 91730

VEVOR[®]

TOUGH TOOLS, HALF PRICE

Supporto tecnico e certificato di garanzia
elettronica www.vevor.com/support

VEVOR[®]

TOUGH TOOLS, HALF PRICE

Soporte técnico y certificado de garantía electrónica www.vevor.com/support

MANUAL DEL USUARIO DEL INVERNADERO TÚNEL CON DOMO

Seguimos comprometidos a brindarle herramientas a precios competitivos.

"Ahorre la mitad", "mitad de precio" o cualquier otra expresión similar que utilicemos solo representa una estimación del ahorro que podría obtener al comprar ciertas herramientas con nosotros en comparación con las principales marcas y no necesariamente significa que cubra todas las categorías de herramientas que ofrecemos. Le recordamos que, al realizar un pedido con nosotros, verifique cuidadosamente si realmente está ahorrando la mitad en comparación con las principales marcas.

VEVOR[®]

TOUGH TOOLS, HALF PRICE

INVERNADERO TÚNEL CON DOMO

Modelo: 12*7*7 pies (verde)



¿NECESITA AYUDA? ¡CONTÁCTENOS!

¿Tiene preguntas sobre el producto? ¿Necesita asistencia técnica? No dude en ponerse en contacto con nosotros:

Soporte técnico y certificado de garantía
electrónica www.vevor.com/support

Estas son las instrucciones originales, lea atentamente todas las instrucciones del manual antes de utilizar el producto. VEVOR se reserva una interpretación clara de nuestro manual de usuario. La apariencia del producto estará sujeta al producto que recibió. Perdónenos por no informarle nuevamente si hay actualizaciones de tecnología o software en nuestro producto.

NORMAS GENERALES DE SEGURIDAD

ADVERTENCIA:

1. Lea atentamente este manual antes de utilizar el producto.
2. Inflamable: Mantener alejado del fuego. Este producto puede encenderse y arder si puesto en contacto con una llama abierta.
3. Mantener alejado de puntas afiladas, cuchillas y otros elementos, para no rayar. El producto.
4. Este producto no es un juguete. Los invernaderos tipo túnel no se pueden utilizar como juguetes. Para que los niños jueguen.
5. Mantener alejado de la lluvia, agua, granizo, etc. para evitar dañar los documentos. tu bolso



















GUARDE ESTAS INSTRUCCIONES

PRESUPUESTO

Modelo	12*7*7 pies (verde)
Tamaño del producto	3,5 × 2 × 2 m
Color	Verde

Siga atentamente las instrucciones de montaje. Se recomiendan de 2 a 4 personas. construcción.

COMPONENTES

NO.	1	2	3	4	5	6	7	7A	8	9	10	11	12	13	14	15	16	17	18
																			
	4PCS	4PCS	2PCS	2PCS	12PCS	4PCS	2PCS	2PCS	10PCS	5PCS	24PCS	12PCS	36PCS	1PC	1PC	4PCS	4PCS	1PC	10PCS

Instrucciones de montaje

PASO 1 Estructura principal

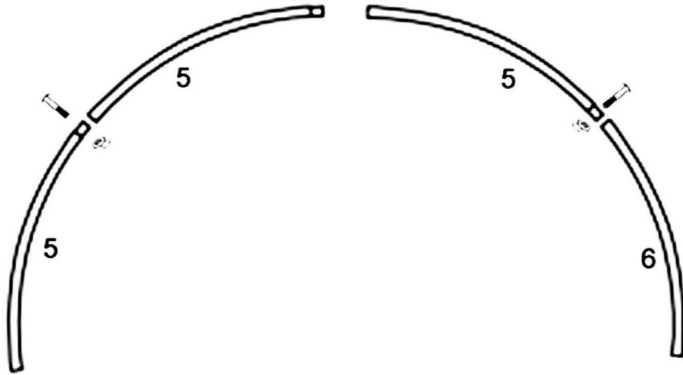

Ensamble cada uno de los 4 juegos No.5 + No.5 juntos, conviértalos en una sola pieza primero, use el más corto pernos, coloque el tubo curvo sobre el suelo plano, haga que ambos tubos queden horizontales y luego apriete los Tuercas. Y ensamblar los 4 juegos No.5+No.6 de la misma manera.

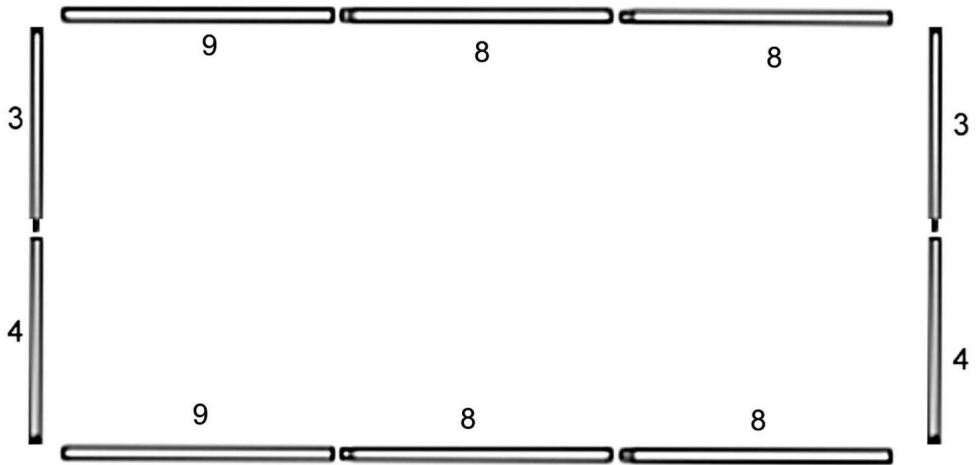

Para ensamblar los 2 juegos de tubos de piso n.º 3 y n.º 4, use los pernos más cortos y el marco horizontal. No9+No8+No8 juntos.



Para ensamblar los 2 juegos de tubos diagonales de soporte No7 + No7A, use los pernos más cortos.

PASO 2

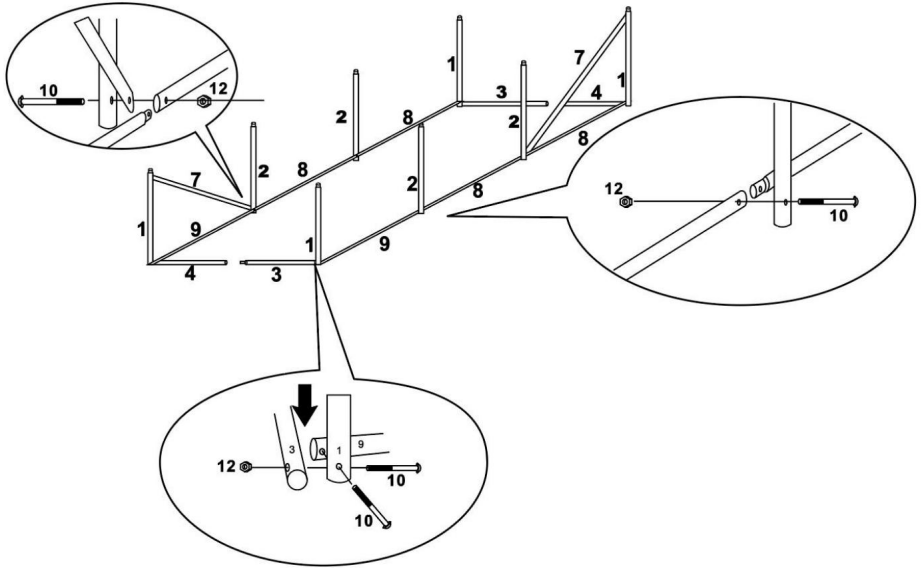

Ensamble el marco completo de manera flexible, antes de apretar todos los pernos en la posición final.

PASO 3

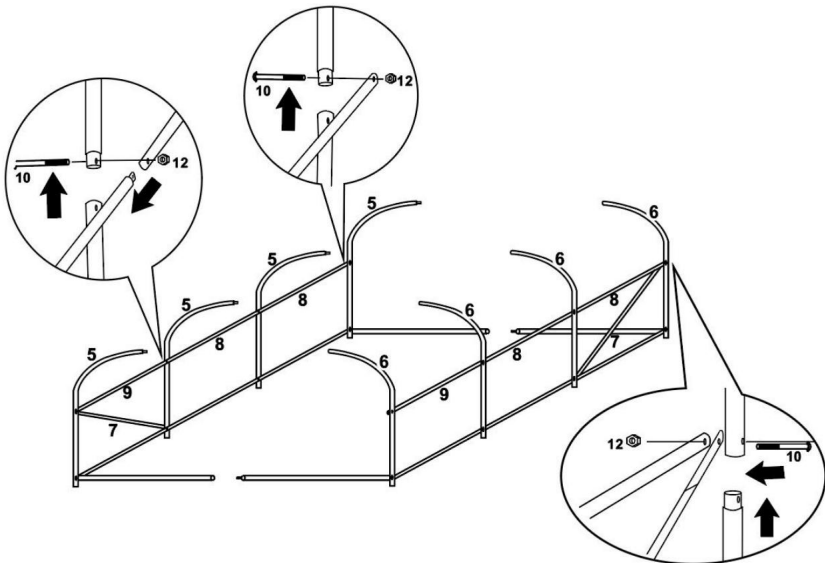

Ensamble el marco completo de manera flexible, antes de apretar todos los pernos en la posición final.

PASO 4

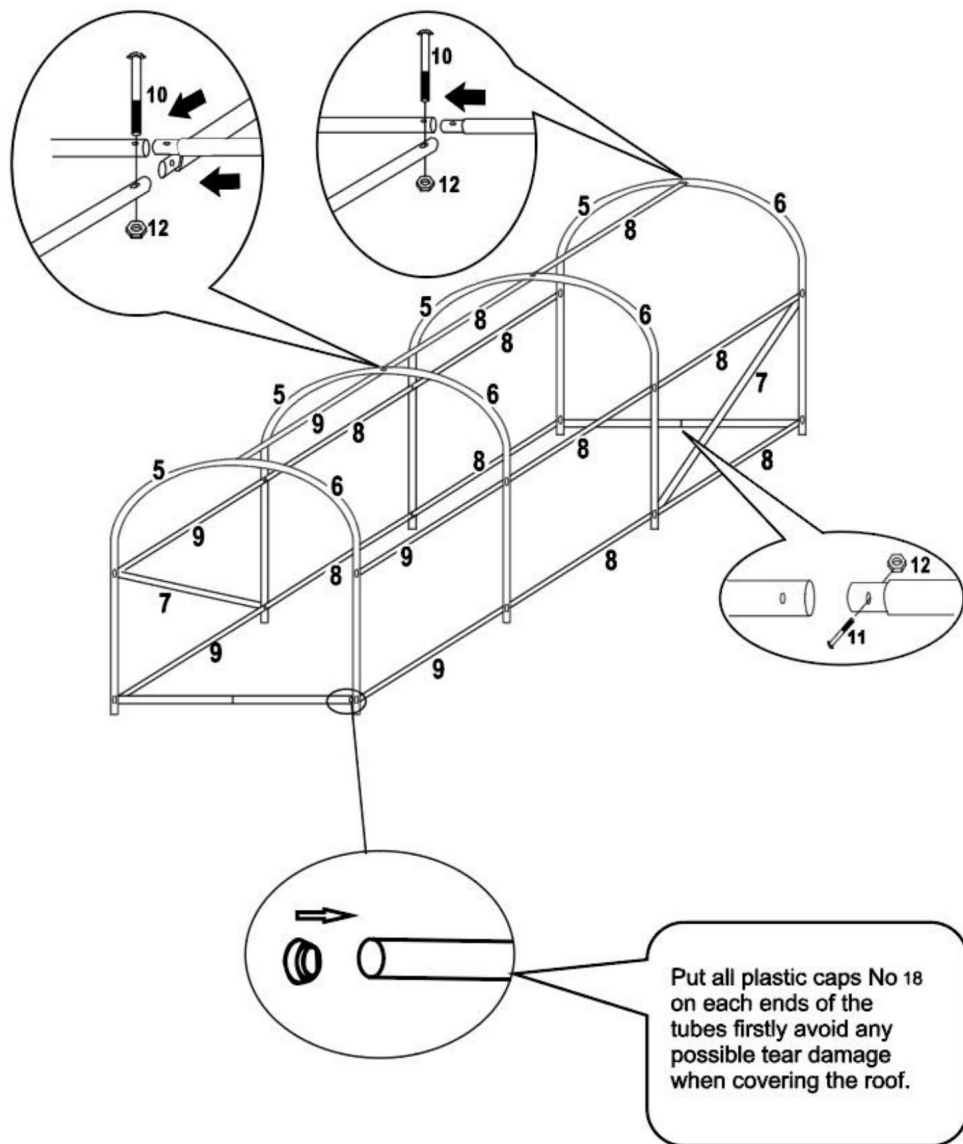

Ensamble sin apretar el marco completo antes de apretar todos los pernos en la posición final.

PASO 5

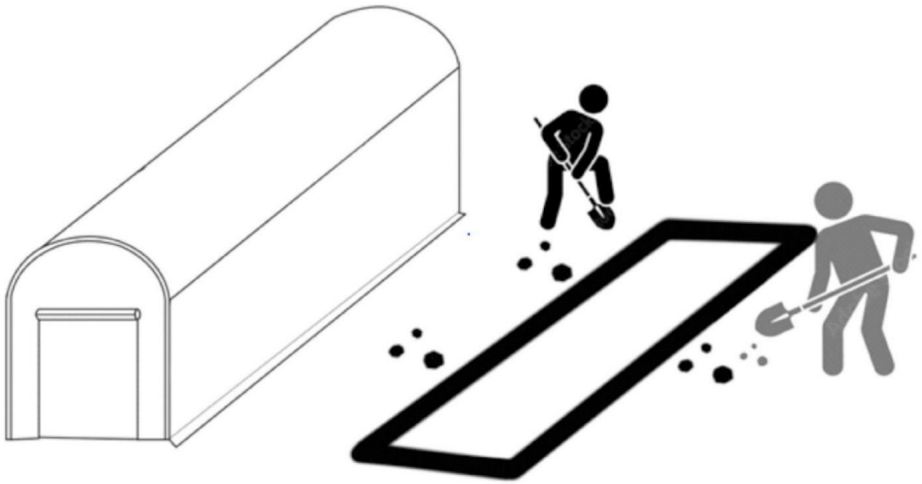

Para lograr la máxima estabilidad de su invernadero, recomendamos cavar una zanja de 20 cm de ancho. alrededor de la base del invernadero y la parte posterior.

Coloque el marco dentro de la zanja, rellenándolo con tierra.

PASO 6

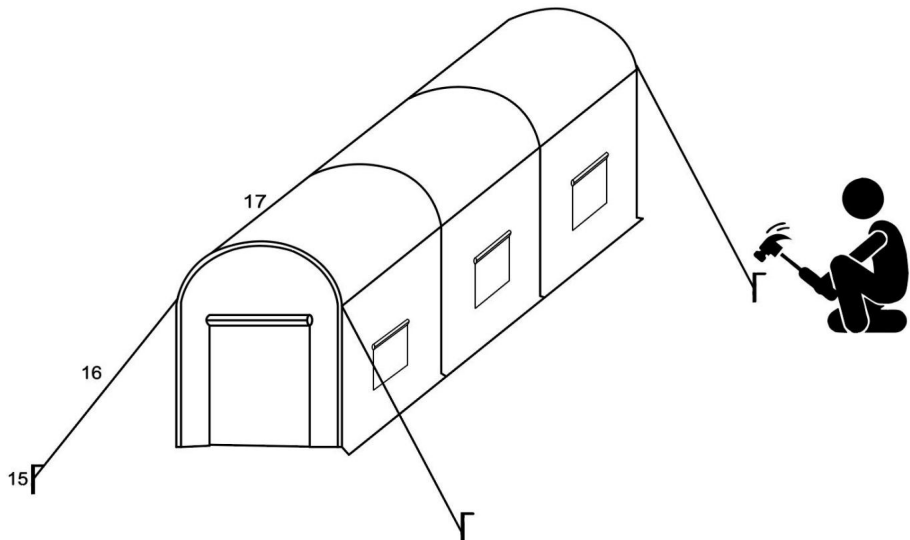

Ate la cuerda en la parte posterior de la cubierta al marco. Use las cuerdas y las estacas para cuatro esquinas del invernadero, para reforzar la estabilidad del mismo.

ADVERTENCIA

Cubrir el techo con cuidado, poner todos los lugares en la posición correcta. En la medida de lo posible, Hacer la estructura del marco del invernadero a partir de la forma.

No lo utilice en condiciones climáticas adversas, como tormentas, granizo, nevadas intensas y viento fuerte

Fabricante: Shanghaimuxinmuyeyouxiangongsi

Dirección: Shuangchenglu 803nong11hao1602A-1609shi, baoshanqu, shanghai 200000 CN.

REPRESENTANTE CE: E-CrossStu GmbH.

Mainzer Landstr.69, 60329 Fráncfort del Meno.

REPRESENTANTE DEL REINO UNIDO: YH CONSULTING LIMITED.

C/O YH Consulting Limited Oficina 147, Centurion House, London Road, Staines-upon-Thames, Surrey, TW18 4AX

Importado a AUS: SIHAO PTY LTD.

1 ROKEVA STREET EASTWOOD NSW 2122 Australia

Importado a EE. UU.: Sanven Technology Ltd.

Suite 250, 9166 Anaheim Place, Rancho Cucamonga, CA 91730

VEVOR®

TOUGH TOOLS, HALF PRICE

Soporte técnico y certificado de garantía
electrónica www.vevor.com/support

VEVOR[®]

TOUGH TOOLS, HALF PRICE

Teknisk support och e-garanticertifikat www.vevor.com/support

DOME TUNNEL GREENHOUSE ANVÄNDARHANDBOK

Vi fortsätter att vara engagerade i att ge dig verktyg till konkurrenskraftiga priser.

"Spara hälften", "halva priset" eller andra liknande uttryck som används av oss representerar bara en uppskattning av besparingar du kan dra nytta av att köpa vissa verktyg hos oss jämfört med de stora toppmärkena och betyder inte nödvändigtvis att täcka alla kategorier av verktyg som erbjuds av oss. Du påminns vänligen om att noggrant kontrollera när du gör en beställning hos oss om du faktiskt sparar hälften i jämförelse med de främsta stora varumärkena.

VEVOR[®]

TOUGH TOOLS, HALF PRICE

DOME TUNNEL VÄXTHUS

Modell: 12*7*7 fot (grön)



BEHÖVER HJÄLP? KONTAKTA OSS!

Har du produktfrågor? Behöver du teknisk support? Kontakta oss gärna:

Teknisk support och e-garanticertifikat
www.vevor.com/support

Detta är den ursprungliga instruktionen, läs alla instruktioner noggrant innan du använder den. VEVOR reserverar sig för en tydlig tolkning av vår användarmanual. Utseendet på produkten är beroende av den produkt du fått. Ursäkta oss att vi inte kommer att informera dig igen om det finns någon teknik eller mjukvaruuppdateringar på vår produkt.

ALLMÄNNA SÄKERHETSFÖRESKRIFTER**VARNING:**

1. Läs denna bruksanvisning noggrant innan du använder produkten.
2. Brandfarligt: Förvaras åtskilt från öppen låga. Denna produkt kommer att antändas och brinna om komma i kontakt med öppen låga.
3. Håll dig borta från vassa spetsar, knivar och andra föremål för att inte repa produkten.
4. Denna produkt är inte en leksak, kupoltunnelväxthus kan inte användas som leksaker för barn att leka med.
5. Håll dig borta från regn, vatten, hagel, etc. för att undvika att skada dokumenten i din väska.

SPARA DESSA INSTRUKTIONER**SPECIFIKATIONER**

Modell	12*7*7 fot (grön)
Produktstorlek	3,5x2x2m
Färg	Grön

Vänligen följ noggrant monteringsanvisningen. Föreslagna 2-4 personer till konstruktion.

KOMPONENTER

NO.	1	2	3	4	5	6	7	7A	8	9	10	11	12	13	14	15	16	17	18
	4PCS	4PCS	2PCS	2PCS	12PCS	4PCS	2PCS	2PCS	10PCS	5PCS	24PCS	12PCS	36PCS	1PC	1PC	4PCS	4PCS	1PC	10PCS

Monteringsanvisningar

STEG1 Huvudstruktur

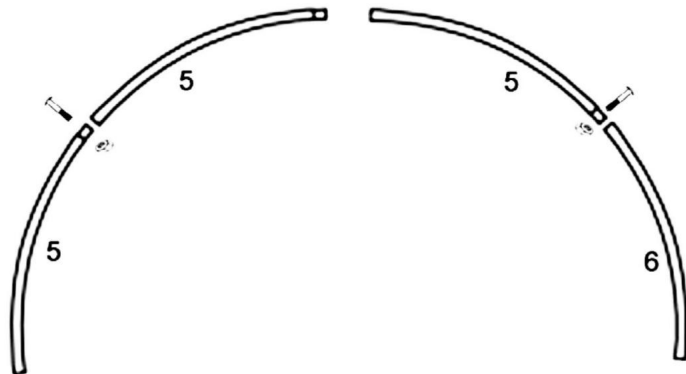

Sätt ihop varje 4 set nr 5+ nr 5, gör dem till en del först, använd den kortare bultar, sätt kurvörret på den plana marken, gör båda rören horisontella och dra sedan åt nötter. Och montera för 4 set nr.5+nr.6 på samma sätt.

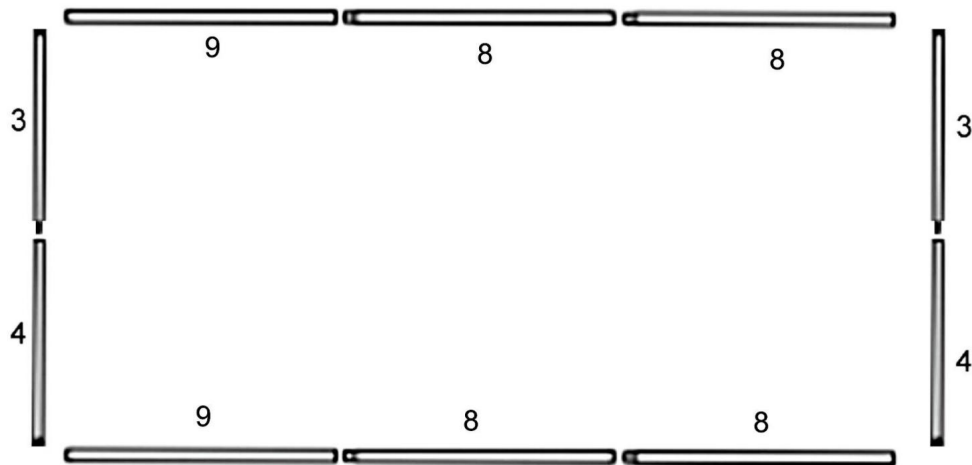

Montera för 2 set golvrör No3 + No4 använd de kortare bultarna och den horisontella ramen No9+No8+No8 tillsammans.



Montera för 2 uppsättningar stöd diagonalrör No7 + No7A använd de kortare bultarna.

STEG 2

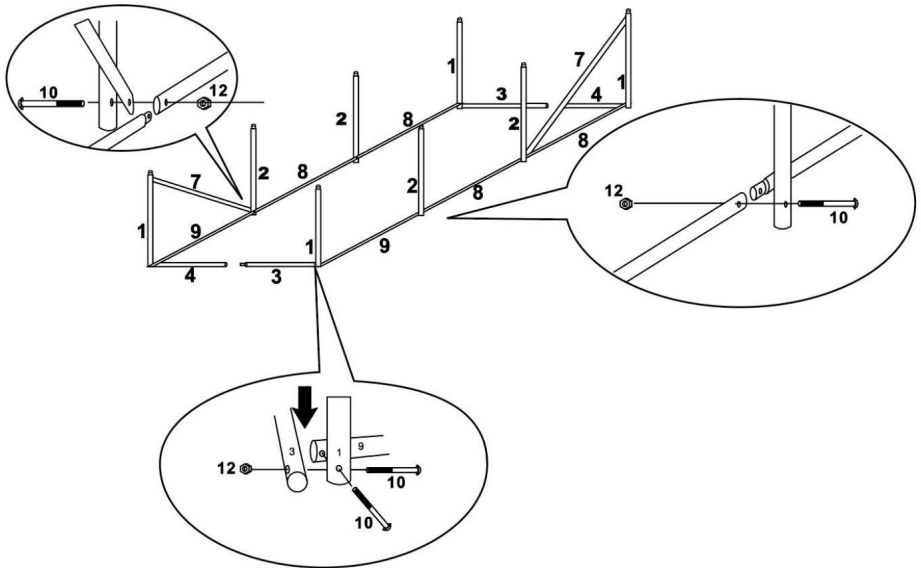

Montera hela ramen löst innan du drar åt alla bultar i slutläget.

STEG 3

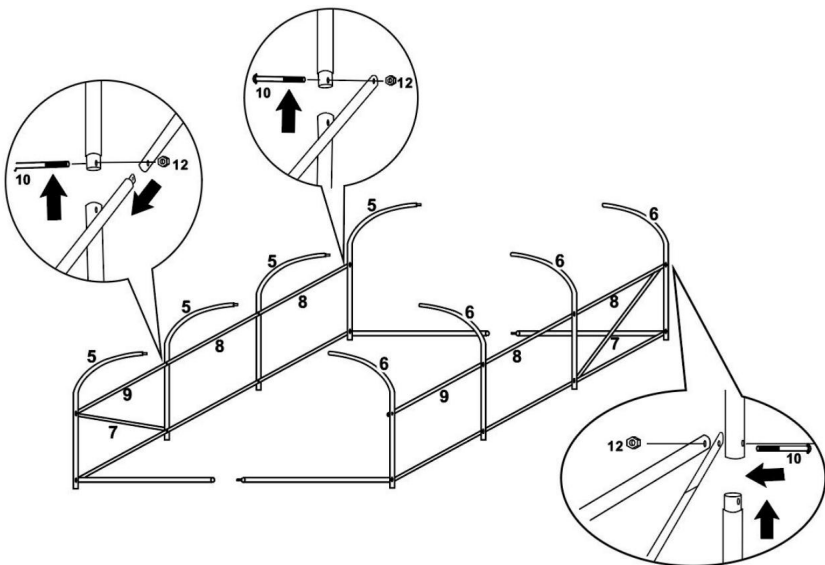

Montera hela ramen löst innan du drar åt alla bultar i slutläget.

STEG 4

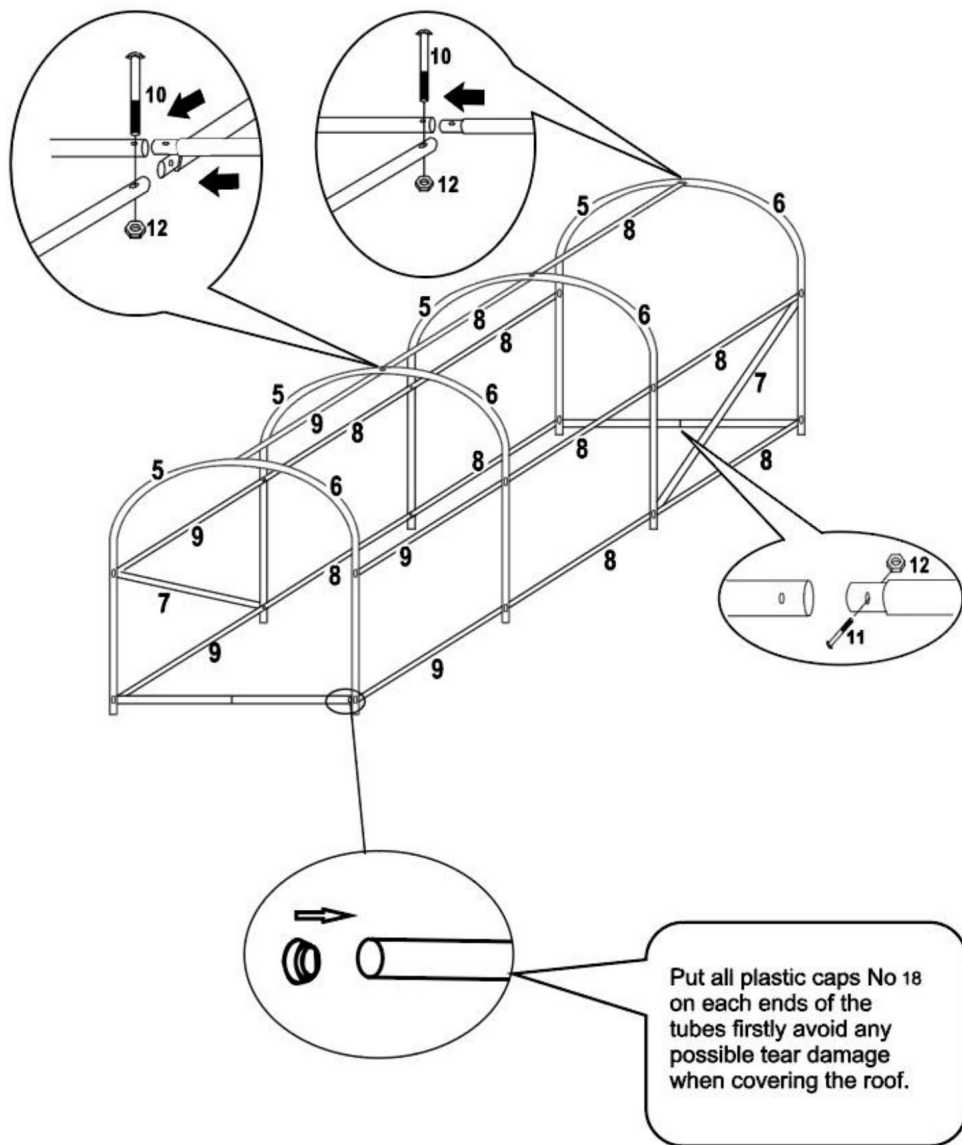

Montera den färdiga ramen löst innan du drar åt alla bultar i slutläget.

STEG 5

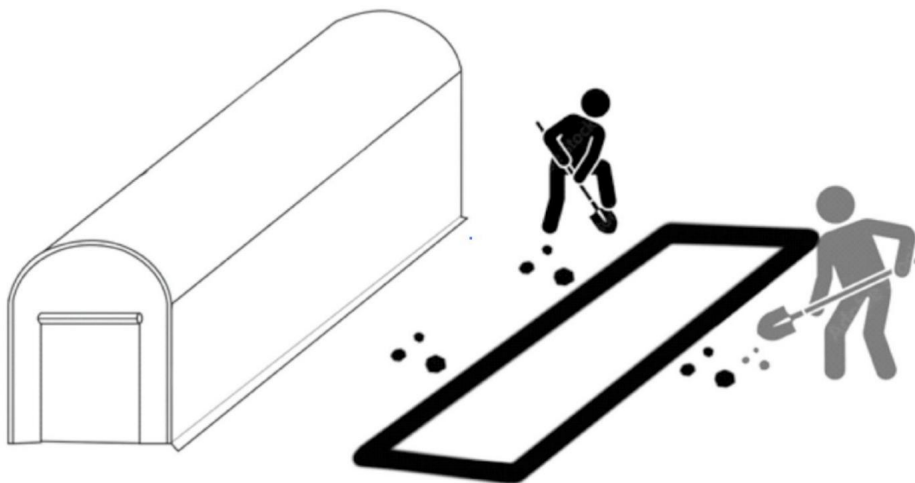

För maximal stabilitet hos din polytunnel rekommenderar vi att du gräver en 20 cm bred dike runt basen av polytunneln och baksidan.

Sätt ramen inuti diket, fyll på med jorden.

STEG 6

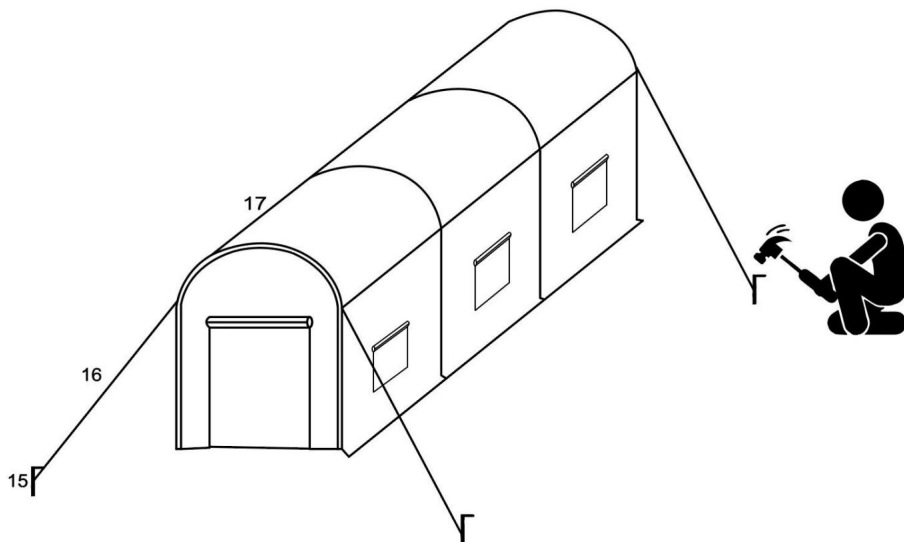

Bind fast snöret på baksidan av locket till ramen. Använd repen och pålarna för fyra hörn av växthuset, för att förstärka stabiliteten i det.

VARNING

Att täcka taket noggrant, sätter alla platser i rätt läge. Så mycket som möjligt som inte gör växthusets ramstruktur ur formen.

Använd den inte i dåliga väderförhållanden, som regn, hagel, kraftig snö och kraftig vind.

Tillverkare: Shanghaimuxinmuyeyouxiangongsi

Adress: Shuangchenglu 803nong11hao1602A-1609shi, baoshanqu, shanghai 200000 CN.

EC REP: E-CrossStu GmbH.

Mainzer Landstr.69, 60329 Frankfurt am Main.

UK REP: YH CONSULTING LIMITED.

C/O YH Consulting Limited Office 147, Centurion House, London Road, Staines-upon-Thames, Surrey, TW18 4AX

Importerad till AUS: SIHAO PTY LTD.

1 ROKEVA STREETEASTWOOD NSW 2122 Australien

Importerad till USA: Sanven Technology Ltd.

Suite 250, 9166 Anaheim Place, Rancho Cucamonga, CA 91730

VEVOR[®]

TOUGH TOOLS, HALF PRICE

Teknisk support och e-garanticertifikat

www.vevor.com/support

VEVOR[®]

TOUGH TOOLS, HALF PRICE

Technische ondersteuning en e-garantiecertificaat www.vevor.com/support

GEBRUIKSAANWIJZING DOME TUNNEL KASK

Wij streven er voortdurend naar om u gereedschappen tegen concurrerende prijzen te leveren.

"Save Half", "Half Price" of andere soortgelijke uitdrukkingen die wij gebruiken, geven alleen een schatting van de besparingen die u kunt behalen door bepaalde gereedschappen bij ons te kopen in vergelijking met de grote topmerken en betekent niet noodzakelijkerwijs dat alle categorieën gereedschappen die wij aanbieden, worden gedekt. Wij herinneren u eraan om zorgvuldig te controleren of u daadwerkelijk de helft bespaart in vergelijking met de grote topmerken wanneer u een bestelling bij ons plaatst.

VEVOR[®]

TOUGH TOOLS, HALF PRICE

KAS MET KOEPEL TUNNEL

Model: 12*7*7 ft (groen)



HULP NODIG? NEEM CONTACT MET ONS OP!

Heeft u vragen over het product? Heeft u technische ondersteuning nodig? Neem dan gerust contact met ons op:

Technische ondersteuning en e-garantiecertificaat www.vevor.com/support

Dit is de originele instructie, lees alle handleidingen zorgvuldig door voordat u het product gebruikt. VEVOR behoudt zich een duidelijke interpretatie van onze gebruikershandleiding voor. Het uiterlijk van het product is afhankelijk van het product dat u hebt ontvangen. Vergeef ons dat we u niet opnieuw zullen informeren als er technologie- of software-updates voor ons product zijn.

ALGEMENE VEILIGHEIDSREGELS

WAARSCHUWING:

1. Lees deze handleiding zorgvuldig door voordat u het product gebruikt.
2. Ontvlambaar: Uit de buurt van open vuur houden. Dit product zal ontbranden en verbranden als in contact komen met een open vlam.
3. Houd het uit de buurt van scherpe punten, messen en andere voorwerpen, om krassen te voorkomen het product.
4. Dit product is geen speelgoed, de koepeltunnelkas kan niet als speelgoed worden gebruikt voor kinderen om mee te spelen.
5. Bescherm de documenten tegen regen, water, hagel, enz. om schade aan de documenten te voorkomen. jouw tas.



















BEWAAR DEZE INSTRUCTIES

SPECIFICATIES

Model	12*7*7 ft (Groen)
Productgrootte	3,5x2x2m
Kleur	Groente

Volg de montage-instructies zorgvuldig op. Aanbevolen wordt dat 2-4 personen bouw.

COMPONENTEN

NO.	1	2	3	4	5	6	7	7A	8	9	10	11	12	13	14	15	16	17	18
																			
	4PCS	4PCS	2PCS	2PCS	12PCS	4PCS	2PCS	2PCS	10PCS	5PCS	24PCS	12PCS	36PCS	1PC	1PC	4PCS	4PCS	1PC	10PCS

Montage-instructies

STAP 1 Hoofdstructuur

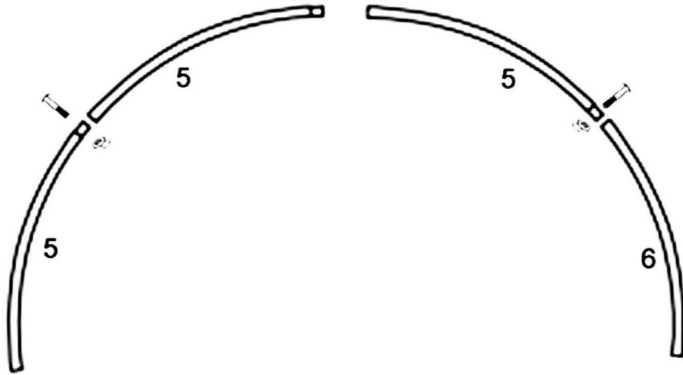

Monteer elke 4 sets nr. 5 + nr. 5 samen, maak ze eerst tot één geheel, gebruik de kortere bouten, leg de gebogen buis op de vlakke grond, maak beide buizen horizontaal en draai de bouten vast noten. En monteer voor 4 sets No.5+No.6 op dezelfde manier.

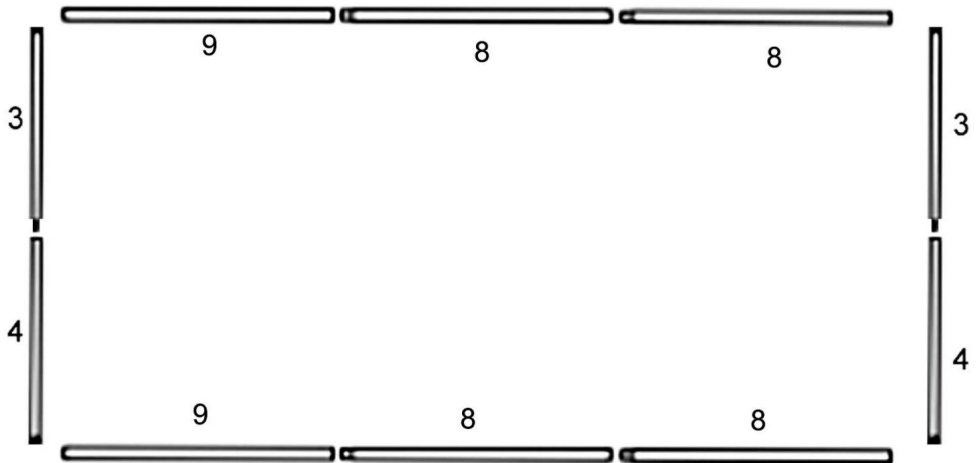

Monteer voor 2 sets vloerbuizen nr. 3 + nr. 4 de kortere bouten en het horizontale frame No9+No8+No8 samen.



Monteer voor 2 sets diagonale ondersteuningsbuizen nr. 7 en nr. 7A en gebruik de kortere bouten.

STAP 2

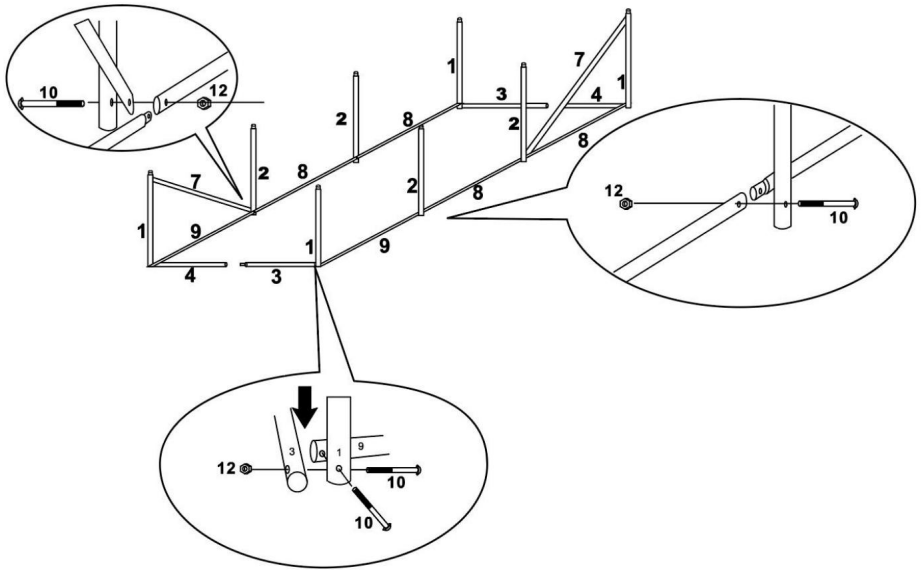

Monteer het complete frame losjes, voordat u alle bouten in de definitieve positie vastdraait.

STAP 3

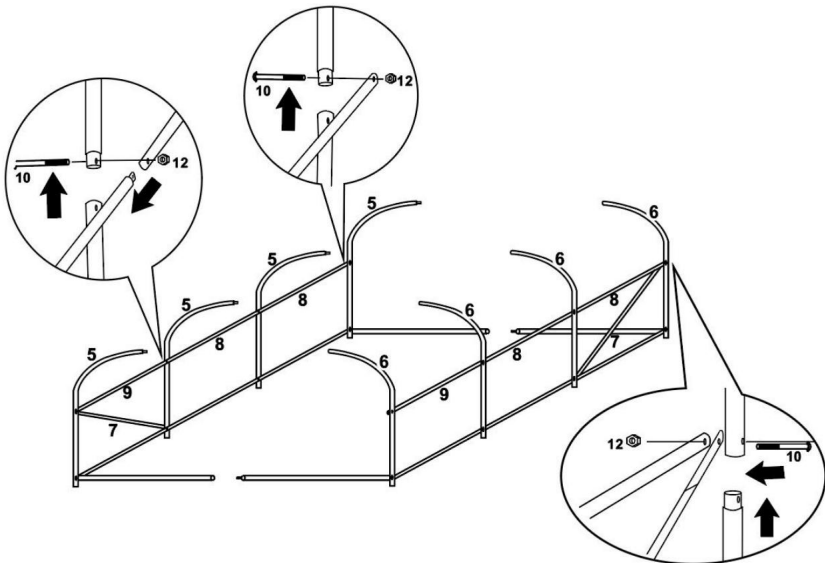

Monteer het complete frame losjes, voordat u alle bouten in de definitieve positie vastdraait.

STAP 4

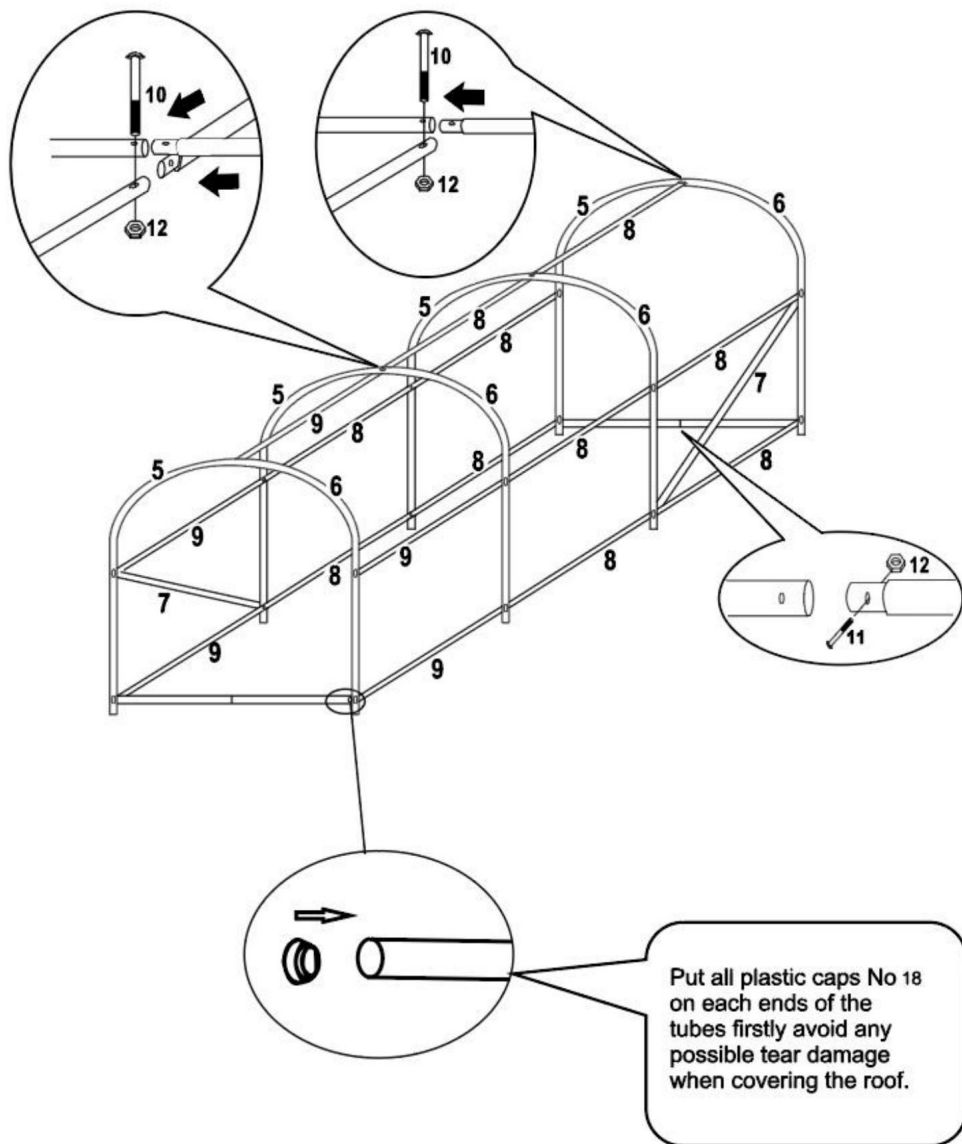

Monteer het complete frame losjes voordat u alle bouten op de definitieve positie vastdraait.

STAP 5

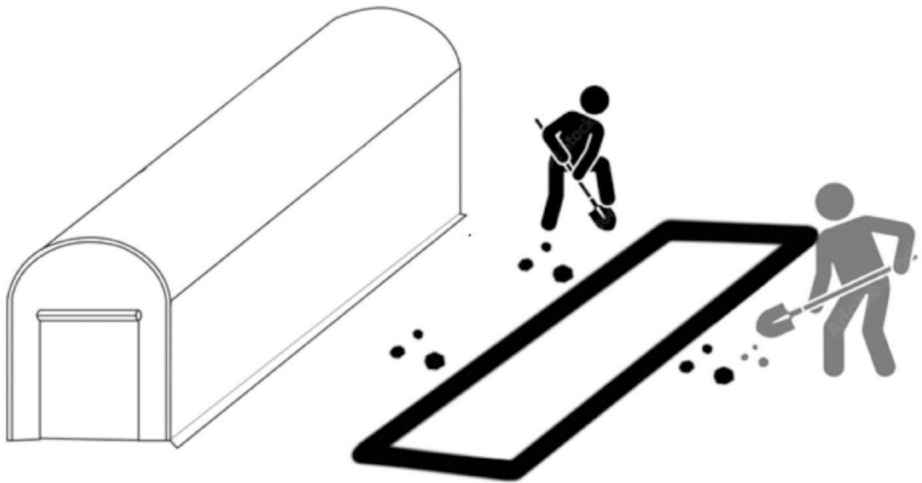

Voor maximale stabiliteit van uw polytunnel raden wij aan een sleuf van 20 cm breed te graven rond de basis van de polytunnel en terug.

Plaats het frame in de sleuf en vul het met aarde.

STAP 6

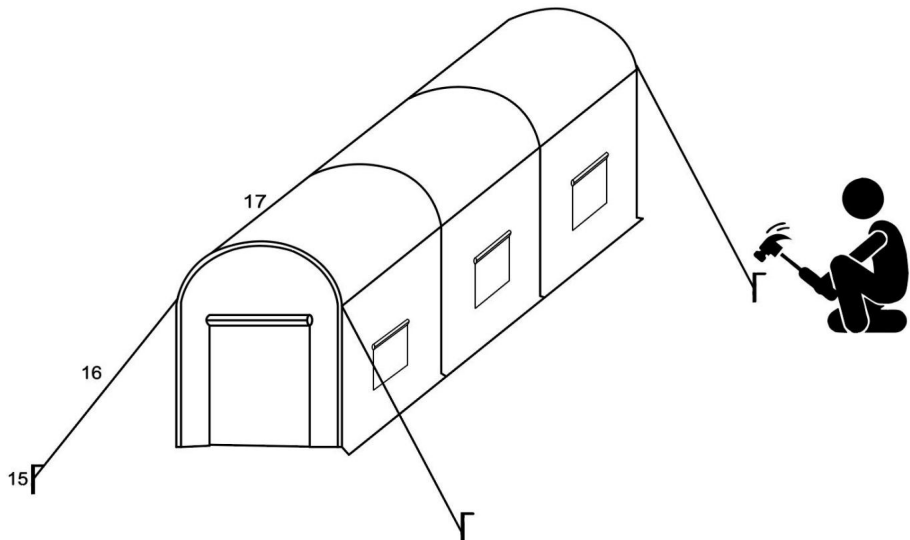

Maak het touw aan de achterkant van de hoes vast aan het frame. Gebruik de touwen en haringen voor vier hoeken van de kas, om de stabiliteit ervan te versterken.

WAARSCHUWING

Het dak zorgvuldig afdekken, alle plaatsen op de juiste positie zetten. Zoveel mogelijk als niet
Maak de framestructuur van de kas uit de vorm.

Gebruik het niet bij slechte weersomstandigheden, zoals een regenbui, hagel, zware sneeuwval en
harde wind.

Fabrikant: Shanghaimuxinmuyeyouxiangongsi

Adres: Shuangchenglu 803nong11hao1602A-1609shi, baoshanqu, shanghai 200000
CN.

EG-REP: E-CrossStu GmbH.

Mainzer Landstr.69, 60329 Frankfurt am Main.

VK VERTEGENWOORDIGING: YH CONSULTING LIMITED.

C/O YH Consulting Limited Kantoor 147, Centurion House, London Road, Staines-upon-
Thames, Surrey, TW18 4AX

Geïmporteerd naar AUS: SIHAO PTY LTD.

1 ROKEVA STRAAT EASTWOOD NSW 2122 Australië

Geïmporteerd naar de VS: Sanven Technology Ltd.

Suite 250, 9166 Anaheim Place, Rancho Cucamonga, CA 91730

VEVOR[®]

TOUGH TOOLS, HALF PRICE

**Technische ondersteuning en e-
garantiecertificaat www.vevor.com/support**

VEVOR[®]

TOUGH TOOLS, HALF PRICE

Assistance technique et certificat de garantie électronique www.vevor.com/support

MANUEL D'UTILISATION DE LA SERRE TUNNEL DOME

Nous continuons à nous engager à vous fournir des outils à des prix compétitifs.

« Économisez la moitié », « Moitié prix » ou toute autre expression similaire utilisée par nous ne représente qu'une estimation des économies que vous pourriez réaliser en achetant certains outils chez nous par rapport aux grandes marques et ne couvre pas nécessairement toutes les catégories d'outils que nous proposons.

Nous vous rappelons de bien vouloir vérifier soigneusement lorsque vous passez une commande chez nous si vous économisez réellement la moitié par rapport aux grandes marques.

VEVOR[®]
TOUGH TOOLS, HALF PRICE

SERRE TUNNEL DÔME

Modèle : 12*7*7 pieds (vert)



BESOIN D'AIDE? CONTACTEZ-NOUS!

Vous avez des questions sur nos produits ? Vous avez besoin d'assistance technique ? N'hésitez pas à nous contacter :

Assistance technique et certificat de garantie
électronique www.vevor.com/support

Il s'agit de la notice d'utilisation d'origine. Veuillez lire attentivement toutes les instructions du manuel avant de l'utiliser. VEVOR se réserve le droit d'interpréter clairement notre manuel d'utilisation. L'apparence du produit dépend du produit que vous avez reçu. Veuillez nous excuser, nous ne vous informerons plus en cas de mise à jour technologique ou logicielle de notre produit.

RÈGLES GÉNÉRALES DE SÉCURITÉ

AVERTISSEMENT:

1. Veuillez lire attentivement ce manuel avant d'utiliser le produit.
2. Inflammable : Tenir à l'écart des flammes nues. Ce produit s'enflamme et brûle s'il est exposé à des températures élevées. mis en contact avec une flamme nue.
3. Tenir à l'écart des objets pointus, des lames et autres objets tranchants, afin de ne pas les rayer le produit.
4. Ce produit n'est pas un jouet, la serre tunnel à dôme ne peut pas être utilisée comme jouet pour que les enfants puissent jouer avec.
5. Tenir à l'écart de la pluie, de l'eau, de la grêle, etc. pour éviter d'endommager les documents. ton sac .















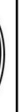



CONSERVEZ CES INSTRUCTIONS

CARACTÉRISTIQUES

Modèle	12*7*7 pieds (vert)
Taille du produit	3,5×2×2m
Couleur	Vert

Veuillez suivre attentivement les instructions de montage. Il est suggéré de compter 2 à 4 personnes. construction.

COMPOSANTS

NO.	1	2	3	4	5	6	7	7A	8	9	10	11	12	13	14	15	16	17	18
																			
	4PCS	4PCS	2PCS	2PCS	12PCS	4PCS	2PCS	2PCS	10PCS	5PCS	24PCS	12PCS	36PCS	1PC	1PC	4PCS	4PCS	1PC	10PCS

Instructions de montage

ÉTAPE 1 Structure principale

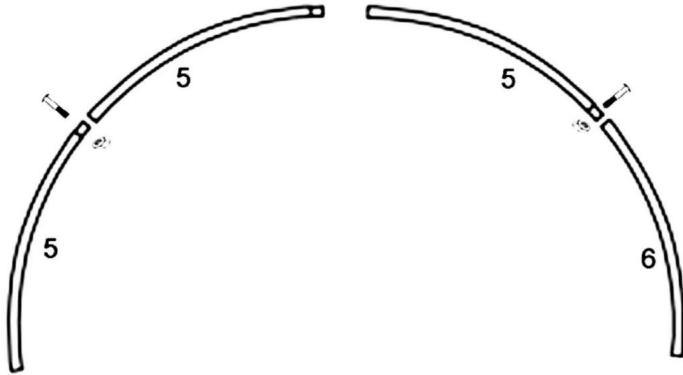

Assemblez chacun des 4 ensembles No.5+No.5 ensemble, faites-les d'abord en une seule partie, utilisez la plus courte boulons, placez le tube courbe sur le sol plat, mettez les deux tubes horizontaux, puis serrez les noix. Et assembler pour 4 ensembles N°5+N°6 de la même manière.

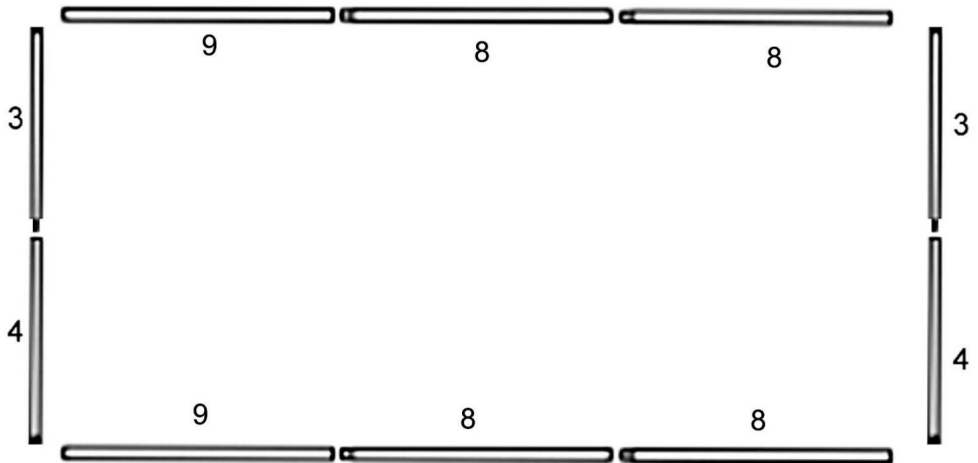

Assemblez les 2 jeux de tubes de plancher n°3 + n°4 en utilisant les boulons les plus courts et le cadre horizontal N°9+N°8+N°8 ensemble.



Assemblez les 2 ensembles de tubes de support diagonaux No7 + No7A en utilisant les boulons les plus courts.

ÉTAPE 2

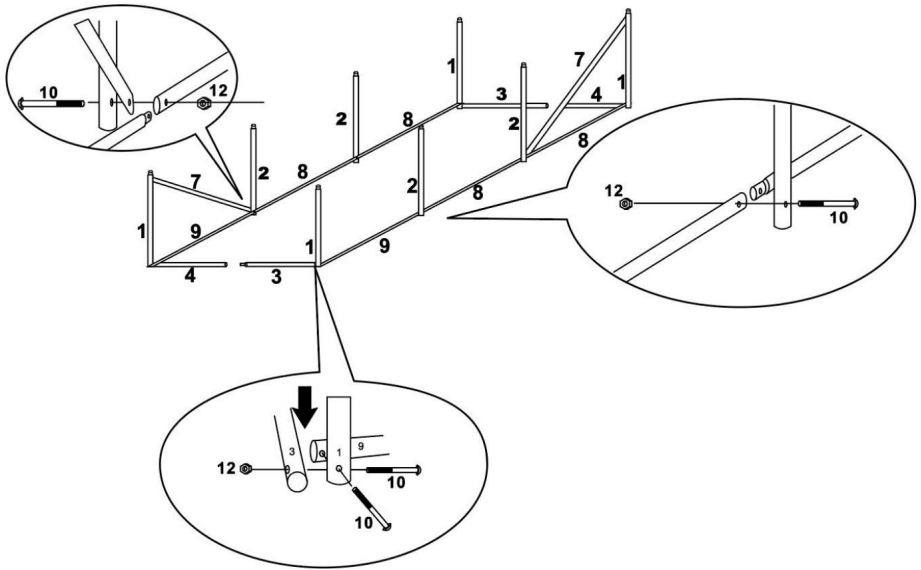

Assemblez sans serrer le cadre complet avant de serrer tous les boulons dans la position finale.

ÉTAPE 3

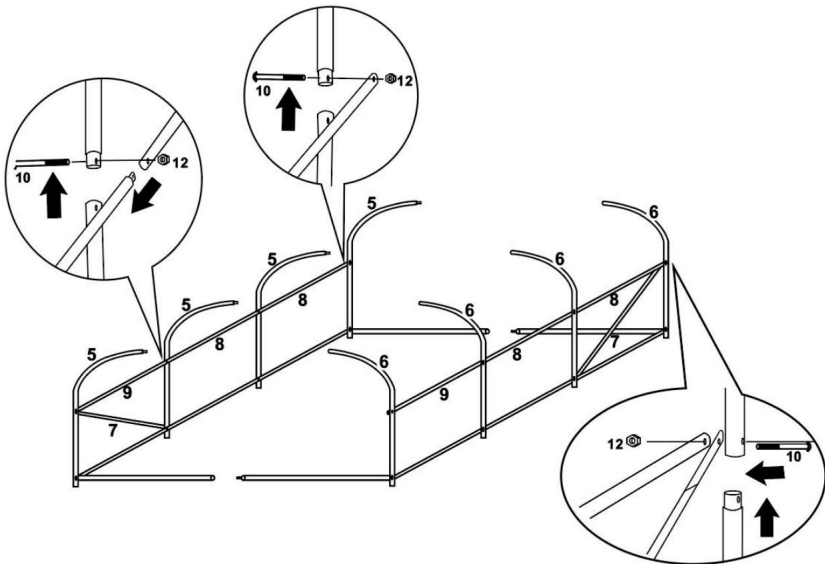

Assemblez sans serrer le cadre complet avant de serrer tous les boulons dans la position finale.

ÉTAPE 4

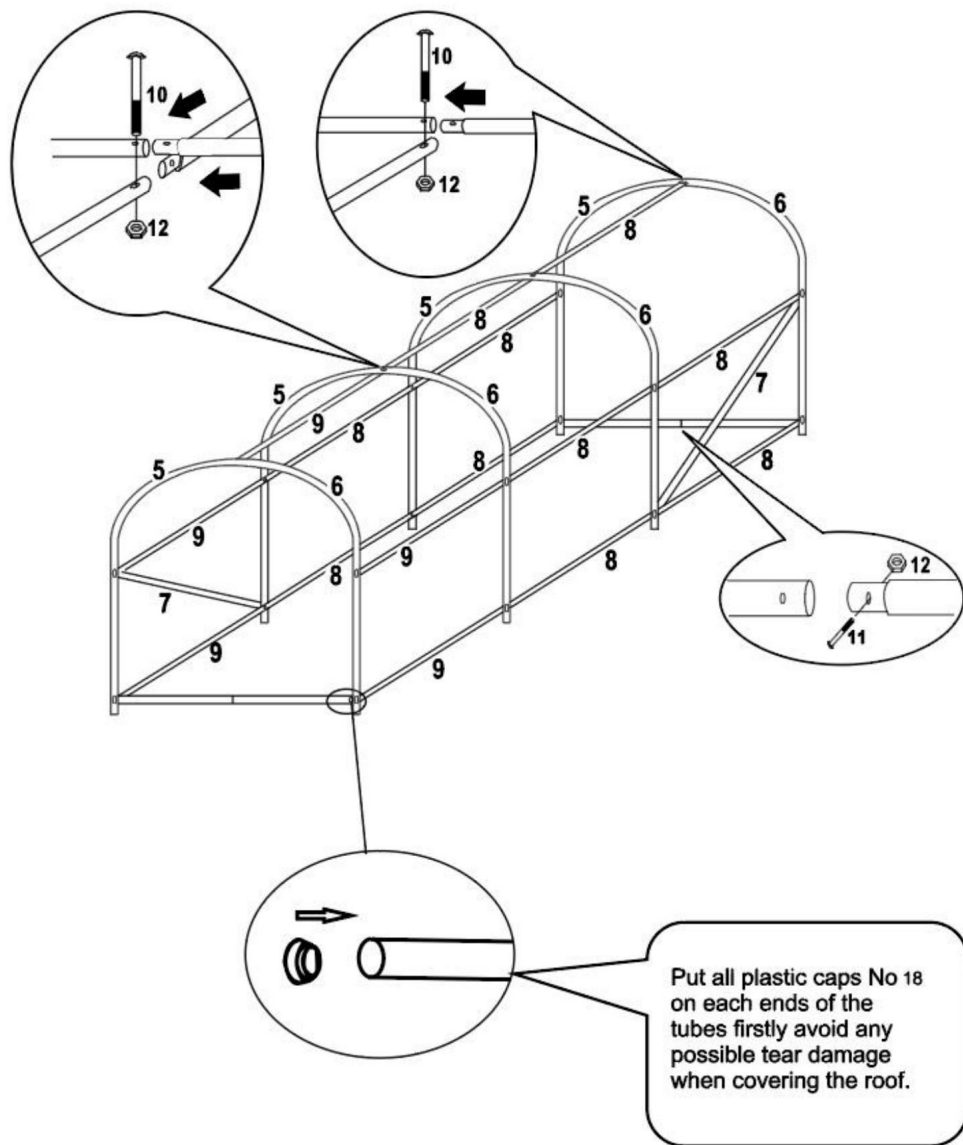

Assemblez sans serrer le cadre terminé avant de serrer tous les boulons dans la position finale.

ÉTAPE 5

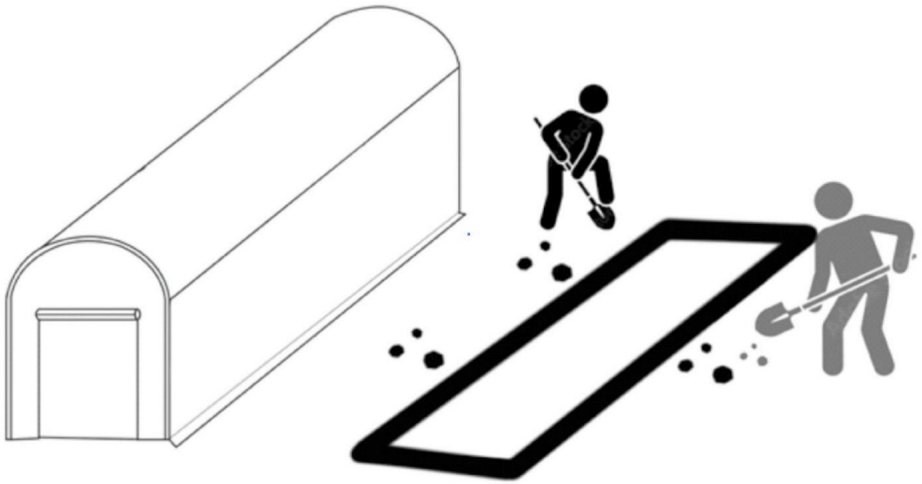

Pour une stabilité maximale de votre serre tunnel, nous vous recommandons de creuser une tranchée de 20 cm de largeur autour de la base de la serre tunnel et à l'arrière.

Placez le cadre à l'intérieur de la tranchée, en le remplissant avec la terre.

ÉTAPE 6

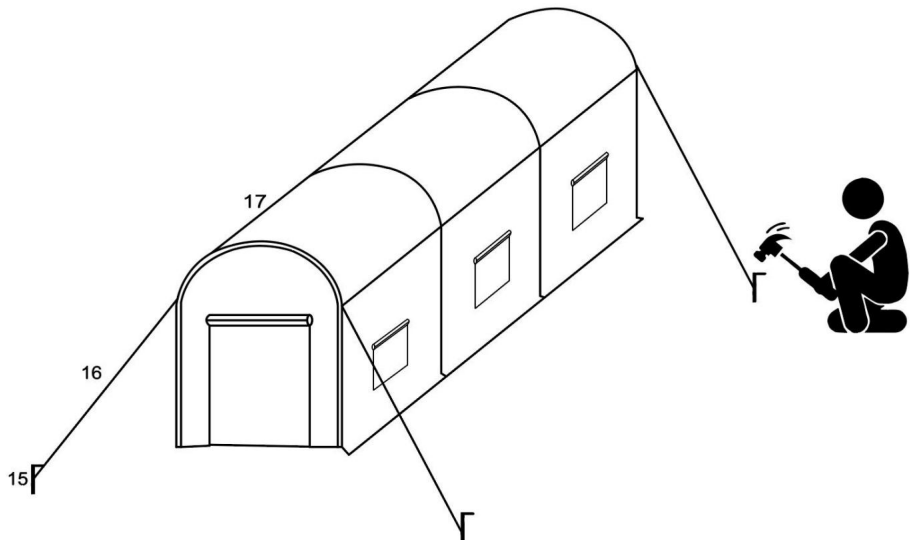

Attachez la ficelle à l'arrière de la couverture au cadre. Utilisez les cordes et les piquets pour quatre coins de la serre, pour renforcer la stabilité de celle-ci.

AVERTISSEMENT

Couvrir soigneusement le toit, c'est mettre tous les endroits à la bonne place. Autant que possible réaliser la structure du cadre de la serre à partir de la forme.

Ne l'utilisez pas dans de mauvaises conditions météorologiques, telles qu'une tempête de pluie, de la grêle, de fortes chutes de neige et vent fort.

Fabricant : Shanghaimuxinmuyeyouxiangongsi

Adresse : Shuangchenglu 803nong11hao1602A-1609shi, baoshanqu, Shanghai 200000 CN.

CE REP : E-CrossStu GmbH.

Mainzer Landstr.69, 60329 Francfort-sur-le-Main.

REPRÉSENTANT AU ROYAUME-UNI : YH CONSULTING LIMITED.

A/S YH Consulting Limited Bureau 147, Centurion House, London Road, Staines-upon-Thames, Surrey, TW18 4AX

Importé en AUS : SIHAO PTY LTD.

1 ROKEVA STREET EASTWOOD NSW 2122 Australie

Importé aux États-Unis : Sanven Technology Ltd.

Suite 250, 9166 Anaheim Place, Rancho Cucamonga, CA 91730

VEVOR®

TOUGH TOOLS, HALF PRICE

Assistance technique et certificat de garantie
électronique www.vevor.com/support

VEVOR[®]

TOUGH TOOLS, HALF PRICE

Technischer Support und E-Garantie-Zertifikat www.vevor.com/support

BENUTZERHANDBUCH FÜR DOME-TUNNEL-GEWÄCHSHÄUSER

Wir sind weiterhin bestrebt, Ihnen Werkzeuge zu wettbewerbsfähigen Preisen anzubieten.

„Sparen Sie die Hälfte“, „Halber Preis“ oder andere ähnliche Ausdrücke, die wir verwenden, stellen nur eine Schätzung der Ersparnis dar, die Sie beim Kauf bestimmter Werkzeuge bei uns im Vergleich zu den großen Topmarken erzielen können, und decken nicht unbedingt alle von uns angebotenen Werkzeugkategorien ab. Wir möchten Sie freundlich daran erinnern, bei Ihrer Bestellung bei uns sorgfältig zu prüfen, ob Sie im Vergleich zu den großen Topmarken tatsächlich die Hälfte sparen.

VEVOR[®]

TOUGH TOOLS, HALF PRICE

KUPPELTUNNEL-GEWÄCHSHAUS

Modell: 12 x 7 x 7 Fuß (Grün)



Brauchen Sie Hilfe? Kontaktieren Sie uns!

Sie haben Fragen zu unseren Produkten? Sie benötigen technischen Support? Dann kontaktieren Sie uns gerne:

Technischer Support und E-Garantie-Zertifikat
www.vevor.com/support

Dies ist die Originalanleitung. Bitte lesen Sie alle Anweisungen sorgfältig durch, bevor Sie das Gerät in Betrieb nehmen. VEVOR behält sich eine klare Auslegung unserer Bedienungsanleitung vor. Das Erscheinungsbild des Produkts richtet sich nach dem Produkt, das Sie erhalten haben. Bitte verzeihen Sie uns, dass wir Sie nicht erneut informieren, wenn es Technologie- oder Software-Updates für unser Produkt gibt.

ALLGEMEINE SICHERHEITSGELN

WARNUNG:

1. Bitte lesen Sie dieses Handbuch sorgfältig durch, bevor Sie das Produkt verwenden.
2. Entzündlich: Von offenem Feuer fernhalten. Dieses Produkt entzündet sich und brennt, wenn mit einer offenen Flamme in Berührung gebracht.
3. Von scharfen Spitzen, Klingen und anderen Gegenständen fernhalten, um Kratzer zu vermeiden das Produkt.
4. Dieses Produkt ist kein Spielzeug. Das Kuppeltunnelgewächshaus kann nicht als Spielzeug verwendet werden für Kinder zum Spielen.
5. Halten Sie sich von Regen, Wasser, Hagel usw. fern, um eine Beschädigung der Dokumente zu vermeiden deine Tasche.



















BEWAHREN SIE DIESE ANLEITUNG AUF

Spezifikationen

Modell	12*7*7 Fuß (Grün)
Produktgröße	3,5x2x2m
Farbe	Grün

Bitte befolgen Sie die Montageanleitung sorgfältig. Es werden 2-4 Personen empfohlen. Konstruktion.

KOMPONENTEN

NO.	1	2	3	4	5	6	7	7A	8	9	10	11	12	13	14	15	16	17	18
																			
	4PCS	4PCS	2PCS	2PCS	12PCS	4PCS	2PCS	2PCS	10PCS	5PCS	24PCS	12PCS	36PCS	1PC	1PC	4PCS	4PCS	1PC	10PCS

Montageanleitung

STEP1 Hauptstruktur

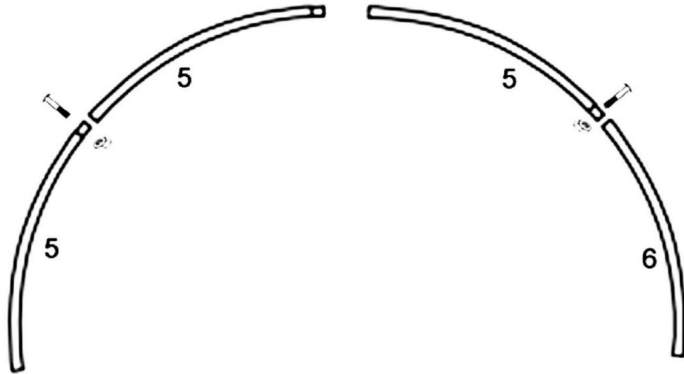

Jeweils 4 Sets Nr. 5+Nr. 5 zusammenfügen, zunächst zu einem Teil zusammenfügen, dann den kürzeren Schrauben, legen Sie das gebogene Rohr auf den ebenen Boden, stellen Sie beide Rohre waagrecht auf, dann ziehen Sie die Muttern. Und für 4 Sätze Nr. 5 + Nr. 6 auf die gleiche Weise zusammenbauen.

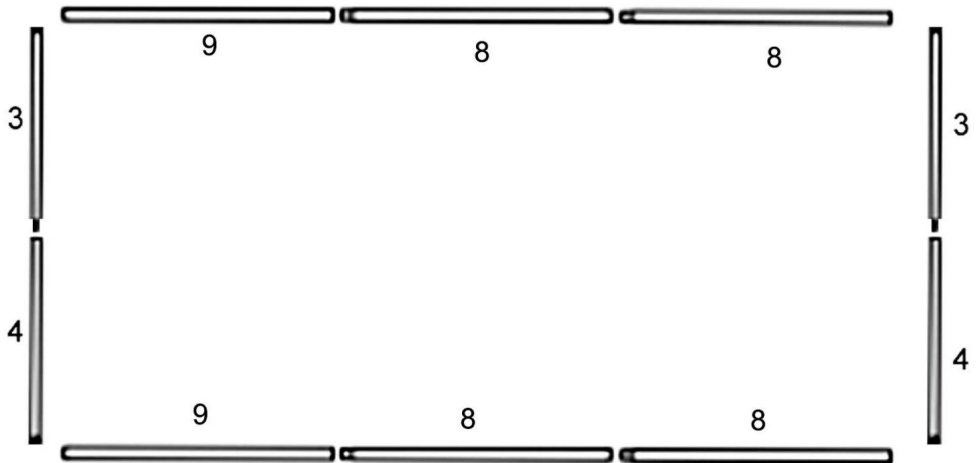

Für die Montage von 2 Bodenrohrsätzen Nr. 3 + Nr. 4 verwenden Sie die kürzeren Bolzen und den horizontalen Rahmen Nr. 9 + Nr. 8 + Nr. 8 zusammen.



Verwenden Sie für die Montage von 2 Sätzen Stützdiagonalrohre Nr. 7 + Nr. 7A die kürzeren Bolzen.

SCHRITT2

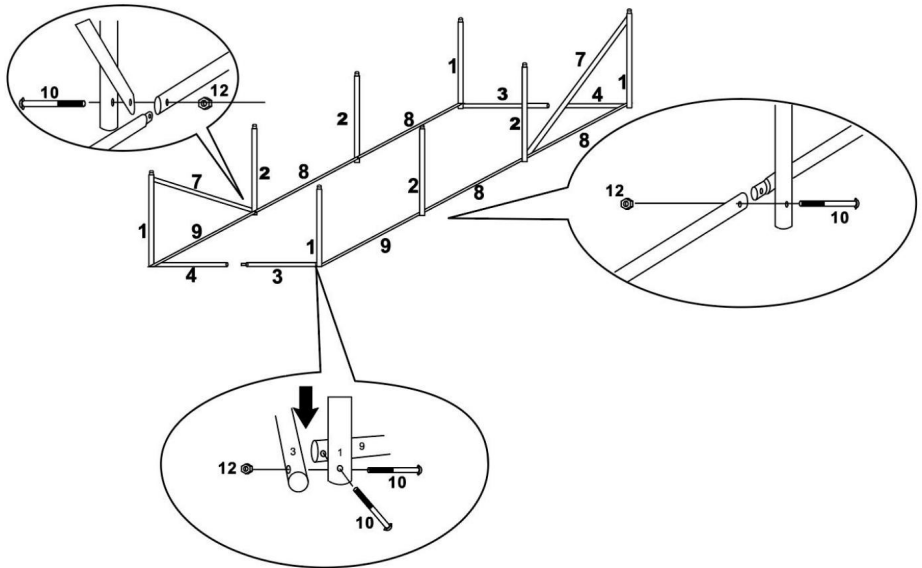

Montieren Sie den gesamten Rahmen locker, bevor Sie alle Schrauben in der endgültigen Position festziehen.

SCHRITT3

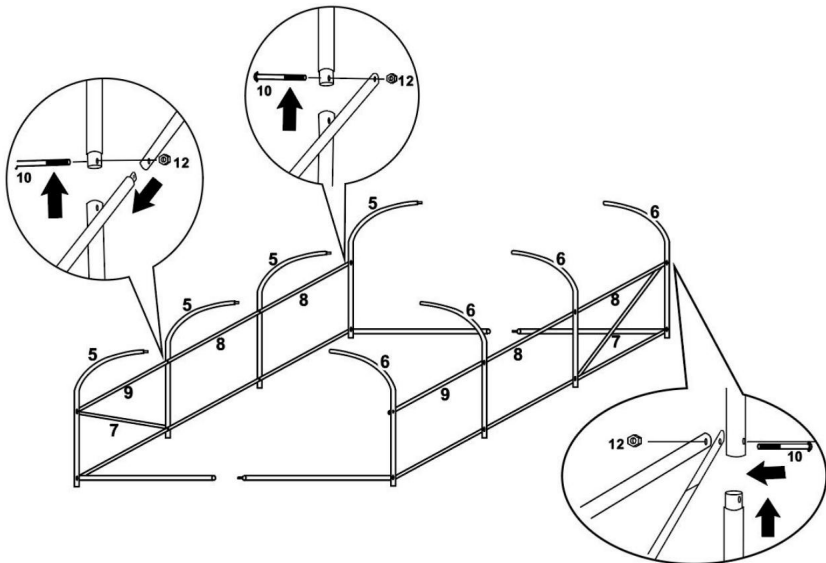

Montieren Sie den gesamten Rahmen locker, bevor Sie alle Schrauben in der endgültigen Position festziehen.

SCHRITT 4

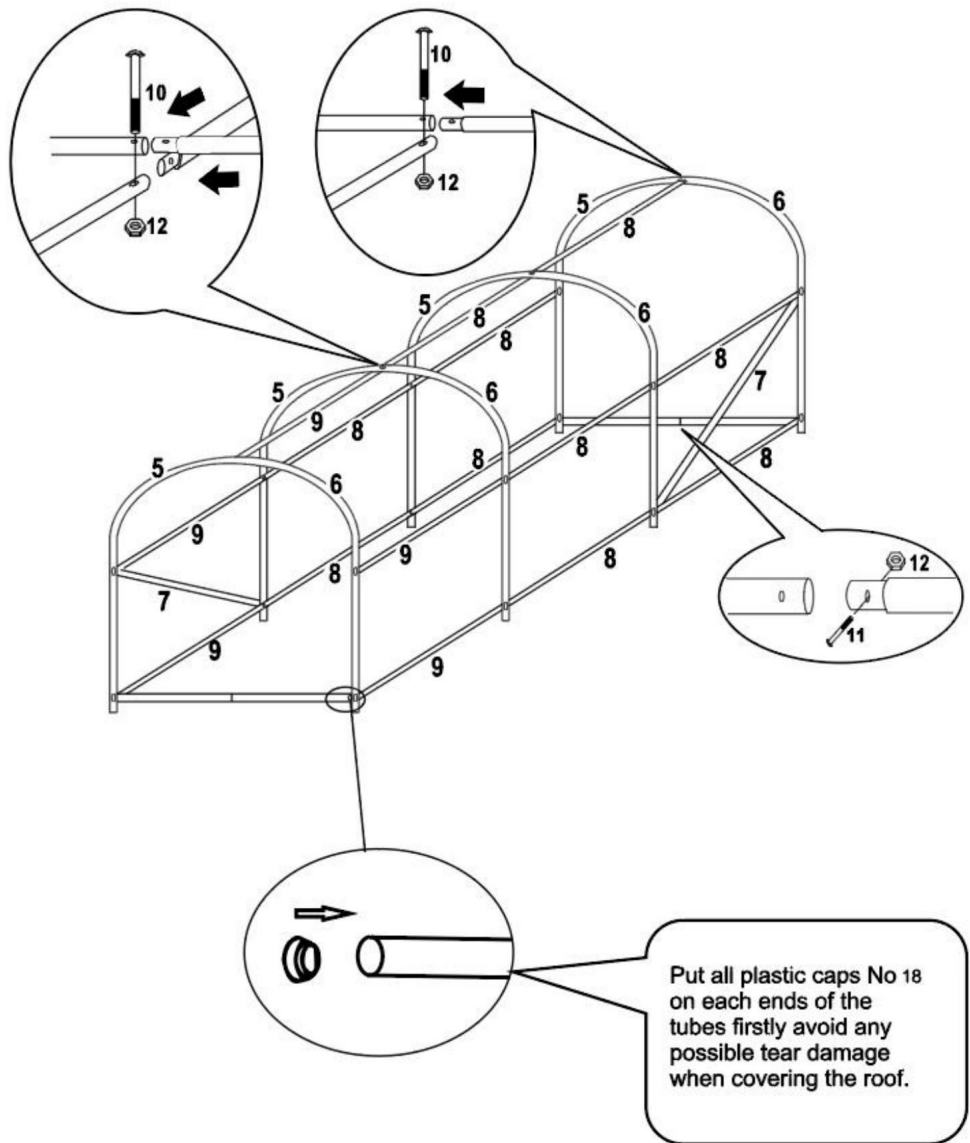

Setzen Sie den fertigen Rahmen locker zusammen, bevor Sie alle Schrauben in der endgültigen Position festziehen.

SCHRITT 5

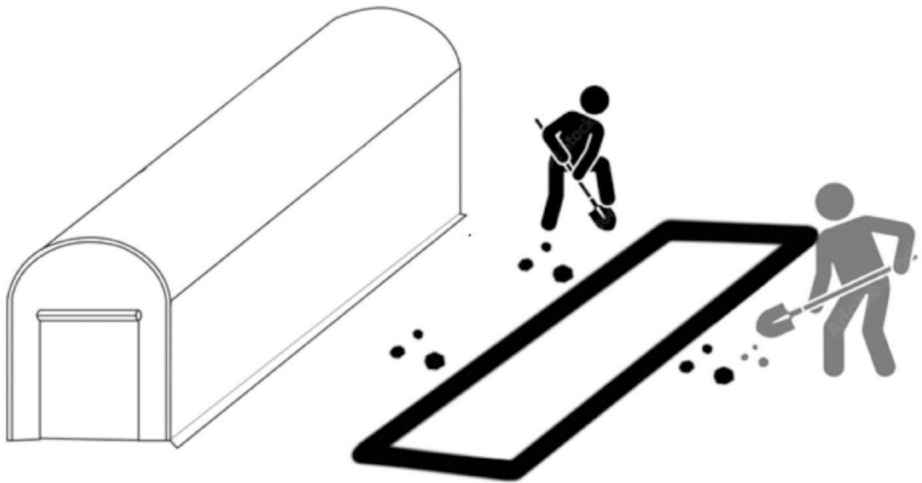

Für maximale Stabilität Ihres Folientunnels empfehlen wir, einen 20 cm breiten Graben auszuheben, um den Boden des Folientunnels herum und zurück.

Legen Sie den Rahmen in den Graben und füllen Sie ihn mit Erde.

SCHRITT 6

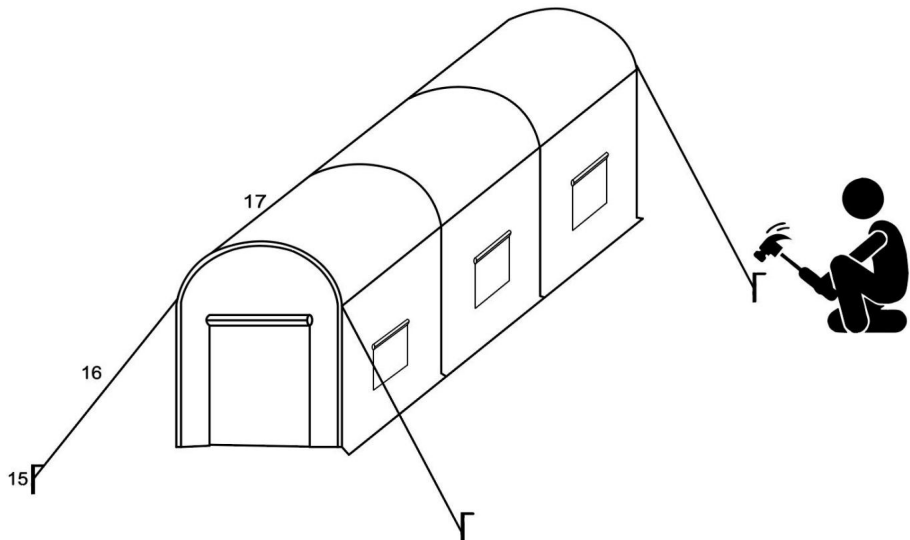

Binden Sie die Schnur auf der Rückseite der Abdeckung an den Rahmen. Verwenden Sie die Seile und Pfähle für vier Ecken des Gewächshauses, um dessen Stabilität zu verstärken.

WARNUNG

Das sorgfältige Abdecken des Daches bringt alle Stellen in die richtige Position. So viel wie möglich wie nicht

Machen Sie aus der Form die Rahmenkonstruktion des Gewächshauses.

Benutzen Sie das Gerät nicht bei widrigen Wetterbedingungen wie Regenschauer, Hagel, starkem Schneefall und starker Wind.

Hersteller: Shanghaimuxinmuyeyouxiangongsi

Adresse: Shuangchenglu 803nong11hao1602A-1609shi, baoshanqu, Shanghai
200000 CN.

EG-Vertreter: E-CrossStu GmbH.

Mainzer Landstr.69, 60329 Frankfurt am Main.

UK-VERTRETER: YH CONSULTING LIMITED.

C/O YH Consulting Limited Office 147, Centurion House, London Road, Staines-upon-Thames, Surrey, TW18 4AX

Nach AUS importiert: SIHAO PTY LTD.

1 ROKEVA STREETEASTWOOD NSW 2122 Australien

In die USA importiert: Sanven Technology Ltd.

Suite 250, 9166 Anaheim Place, Rancho Cucamonga, CA 91730

VEVOR[®]

TOUGH TOOLS, HALF PRICE

Technischer Support und E-Garantie-Zertifikat

www.vevor.com/support