

VEVOR[®]

TOUGH TOOLS, HALF PRICE

Technical Support and E-Warranty Certificate

www.vevor.com/support

NUT RIVETER 14 INCH

We continue to be committed to provide you tools with competitive price.

"Save Half", "Half Price" or any other similar expressions used by us only represents an estimate of savings you might benefit from buying certain tools with us compared to the major top brands and does not necessarily mean to cover all categories of tools offered by us. You are kindly reminded to verify carefully when you are placing an order with us if you are actually saving half in comparison with the top major brands.

VEVOR[®]

TOUGH TOOLS, HALF PRICE

NUT RIVETER 14 INCH

MODEL: DY-8806

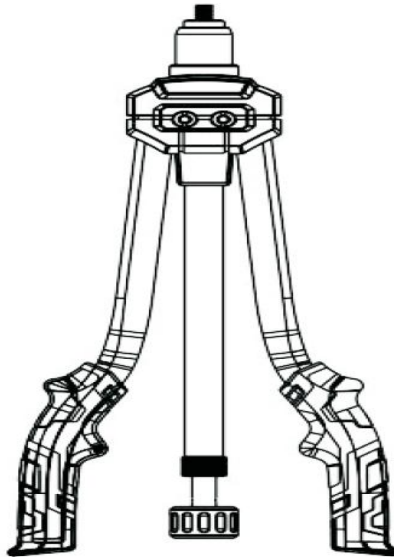



NEED HELP? CONTACT US!

Have product questions? Need technical support? Please feel free to contact us:

Technical Support and E-Warranty Certificate
www.vevor.com/support

This is the original instruction, please read all manual instructions carefully before operating. VEVOR reserves a clear interpretation of our user manual. The appearance of the product shall be subject to the product you received. Please forgive us that we won't inform you again if there are any technology or software updates on our product.

	<p>Warning-To reduce the risk of injury, user must read instructions manual carefully.</p>
	<p>Warning- Be sure to wear eye protectors when using this product.</p>

INTENDED USE OF THE TOOL

This tool is intended to be used to install metric M4, M5, M6, M8, M10, M12 and SAE 10-24, 1/4-20, 5/16-18, 3/8-16, 1/2-13 rivet nuts. Do not use this tool outside of the designed intent. Never modify the tool for any other purpose or use.

SAFETY PRECAUTION

Caution: To help prevent personal injury.

- Normal use of this product is likely to expose the user to dust and/or microscopic particles containing chemicals that cause cancer, birth defects or other reproductive harm. Always wear appropriate safety equipment and clothing when using this product. Study, understand and follow all instructions provided with this product.
- Always wear CERTIFIED GOOGLES when using this product. (Users and By standers)
- Always select the correct accessories of the correct size and design for the job that you are attempting to perform.
- Never use this tool for any application other than for which it was designed.
- Only use accessories designed for this tool.
- Never alter or modify this tool in any way.

SET INCLUDES

14 in hand riveter

Interchangeable threaded mandrels & nosepieces:

10-24, 1/4-20, M6, 5/16-18, M8, 3/8-16, M10, 1pc

Steel rivet nuts: 10-24, 1/4-20, M6, 5/16-18, M8, 3/8-16, M10, 10pc

HOLE SIZE GUIDE

METRIC		SAE	
Nut Size	Hole Size	Nut Size	Hole Size
M6	9mm (3/8")	10-24	7mm (9/32")
M8	11mm (7/16")	1/4-20	9mm (23/64")
M10	13mm (17/32")	5/16-18	11mm (7/16")
		3/8-16	13mm (33/64")

OPERATION INSTRUCTIONS

1. Choose the rivet nut size to be installed.
2. Install the correct size mandrel/nosepiece for the rivet nut to be installed. See photos and instructions for changing the mandrel/nosepiece.
3. Drill a hole in the workpiece the same size or slightly larger than the outside diameter of the rivet nut to be installed, ref to the section of "HOLE SIZE GUIDE".
4. To install the rivet nut, open the handles outward as far as possible and thread the rivet nut clockwise onto the mandrel until reaching the nosepiece.
5. Insert the rivet nut fastened to the riveter into the pre-drilled hole until flush with the workpiece, squeeze two handles to touch the workpiece and secure the rivet nut into the hole. Open the handles outward to unscrew the threaded mandrel from the gripped rivet nut completely.

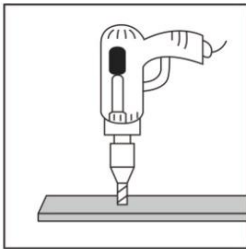

1 Drill with a pistol and drill first.

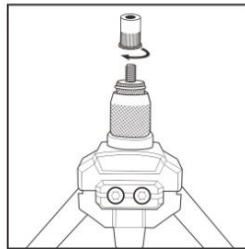

2 Insert a rivet nut into the nosepiece.

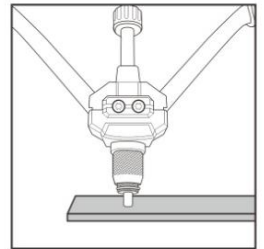

3 Insert the rivet nut into the hole.

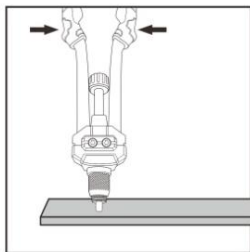

4 Squeeze the handle.

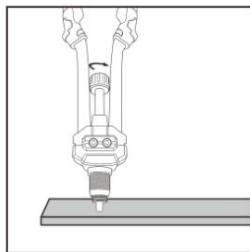

5 Unscrew the threaded mandrel from the gripped rivet nut completely

HOW TO CHANGE THREADED MANDREL AND NOSEPIECE

1. Remove and install the mandrel and nose pieces. Always keep the matched mandrel/nosepiece sets together.
2. Remove nosepiece from sleeve nut by unthreading the nosepiece anticlockwise. (see Fig. 1)
3. Remove sleeve nut by unthreading anticlockwise. (see Fig. 2)
4. Take out the mandrel directly to remove it from the head. (see Fig. 3)
5. Choose the correct mandrel/nosepiece to be installed.
6. Thread the new mandrel into the tool.
7. Install the sleeve nut and nosepiece.

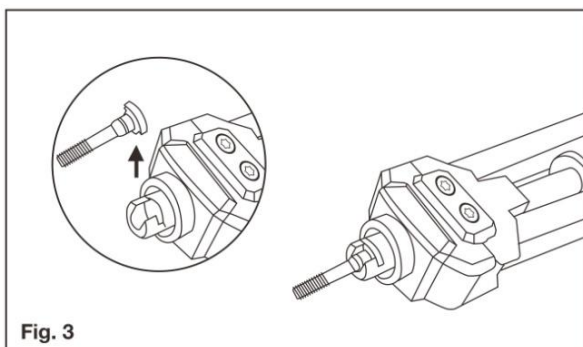
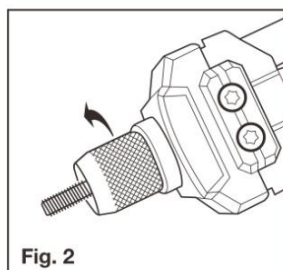
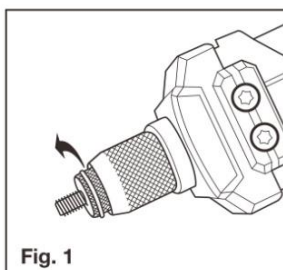



Note Store matching nosepieces and mandrels together when not in use to prevent mismatching the sizes and for convenience.

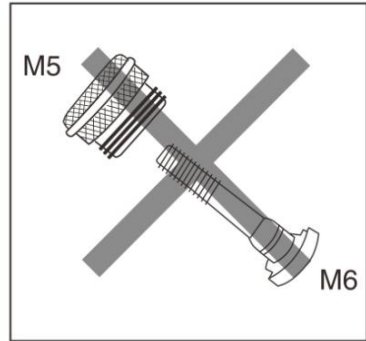
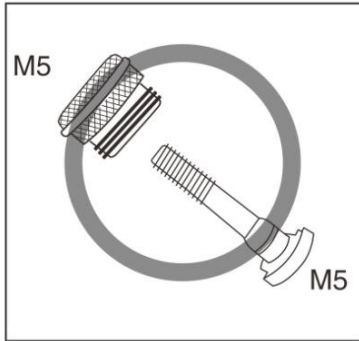

Manufacturer: Shanghaimuxinmuyeyouxiangongsi

Address: Shuangchenglu 803nong11hao1602A-1609shi, baoshanqu, shanghai 200000 CN.

Imported to AUS: SIHAO PTY LTD. 1 ROKEVA STREETEASTWOOD NSW 2122 Australia

Imported to USA: Sanven Technology Ltd. Suite 250, 9166 Anaheim Place, Rancho Cucamonga, CA 91730

UK	REP
-----------	------------

YH CONSULTING LIMITED. C/O YH Consulting Limited Office 147, Centurion House, London Road, Staines-upon-Thames, Surrey, TW18 4AX

EC	REP
-----------	------------

E-CrossStu GmbH
Mainzer Landstr.69,
60329 Frankfurt am Main.

VEVOR[®]

TOUGH TOOLS, HALF PRICE

Technical Support and E-Warranty Certificate

www.vevor.com/support

VEVOR[®]

TOUGH TOOLS, HALF PRICE

Wsparcie techniczne i certyfikat gwarancji
elektronicznej www.vevor.com/support

NITOWNICA NAKRĘTKOWA 14 CALI

Nadal staramy się oferować Państwu narzędzia w konkurencyjnych cenach. „Oszczędź połowę”, „Połowa ceny” lub inne podobne wyrażenia używane przez nas stanowią jedynie szacunkowe oszczędności, jakie możesz uzyskać kupując u nas określone narzędzia w porównaniu z głównymi markami i niekoniecznie oznaczają one objęcie wszystkich kategorii narzędzi oferowanych przez nas. Uprzejmie przypominamy, aby dokładnie sprawdzić, czy składając u nas zamówienie faktycznie oszczędzasz połowę w porównaniu z głównymi markami.

VEVOR[®]

TOUGH TOOLS, HALF PRICE

NITOWNICA NAKRĘTKOWA 14 CALI

MODEL:DY-8806

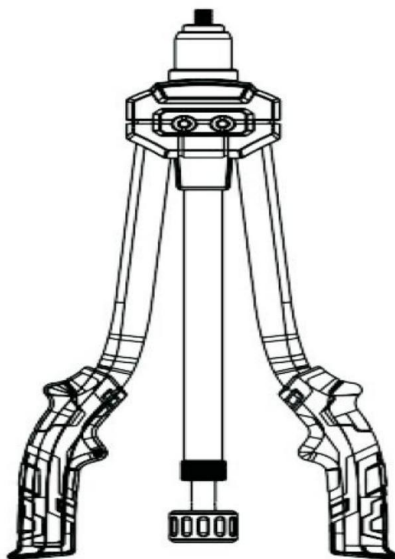



POTRZEBUJESZ POMOCY? SKONTAKTUJ SIĘ Z NAMI!

Masz pytania dotyczące produktu? Potrzebujesz wsparcia technicznego? Skontaktuj się z nami:

Wsparcie techniczne i certyfikat gwarancji
elektronicznej www.vevor.com/support

To jest oryginalna instrukcja, przed użyciem należy uważnie przeczytać wszystkie instrukcje. VEVOR zastrzega sobie jasną interpretację naszej instrukcji obsługi. Wygląd produktu będzie zależał od produktu, który otrzymałeś. Prosimy o wybaczenie, że nie poinformujemy Cię ponownie, jeśli w naszym produkcie pojawią się jakiegokolwiek aktualizacje technologiczne lub oprogramowania.

	Ostrzeżenie: Aby zminimalizować ryzyko obrażeń, użytkownik powinien uważnie przeczytać instrukcję obsługi.
	Ostrzeżenie: Podczas stosowania tego produktu należy nosić okulary ochronne.

INTENDED USE OF THE TOOL

This tool is intended to be used to install metric M4, M5, M6, M8, M10, M12 and SAE 10-24, 1/4-20, 5/16-18, 3/8-16, 1/2-13 rivet nuts. Do not use this tool outside of the designed intent. Never modify the tool for any other purpose or use.

SAFETY PRECAUTION

Caution: To help prevent personal injury.

- Normal use of this product is likely to expose the user to dust and/or microscopic particles containing chemicals that cause cancer, birth defects or other reproductive harm. Always wear appropriate safety equipment and clothing when using this product. Study, understand and follow all instructions provided with this product.
- Always wear CERTIFIED GOOGLES when using this product. (Users and By standers)
- Always select the correct accessories of the correct size and design for the job that you are attempting to perform.
- Never use this tool for any application other than for which it was designed.
- Only use accessories designed for this tool.
- Never alter or modify this tool in any way.

SET INCLUDES

14 in hand riveter

Interchangeable threaded mandrels & nosepieces:

10-24, 1/4-20, M6, 5/16-18, M8, 3/8-16, M10, 1pc

Steel rivet nuts: 10-24, 1/4-20, M6, 5/16-18, M8, 3/8-16, M10, 10pc

HOLE SIZE GUIDE

METRIC		SAE	
Nut Size	Hole Size	Nut Size	Hole Size
M6	9mm (3/8")	10-24	7mm (9/32")
M8	11mm (7/16")	1/4-20	9mm (23/64")
M10	13mm (17/32")	5/16-18	11mm (7/16")
		3/8-16	13mm (33/64")

OPERATION INSTRUCTIONS

1. Choose the rivet nut size to be installed.
2. Install the correct size mandrel/nosepiece for the rivet nut to be installed. See photos and instructions for changing the mandrel/nosepiece.
3. Drill a hole in the workpiece the same size or slightly larger than the outside diameter of the rivet nut to be installed, ref to the section of "HOLE SIZE GUIDE".
4. To install the rivet nut, open the handles outward as far as possible and thread the rivet nut clockwise onto the mandrel until reaching the nosepiece.
5. Insert the rivet nut fastened to the riveter into the pre-drilled hole until flush with the workpiece, squeeze two handles to touch the workpiece and secure the rivet nut into the hole. Open the handles outward to unscrew the threaded mandrel from the gripped rivet nut completely.

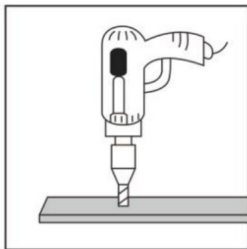

1 Drill with a pistol and drill first.

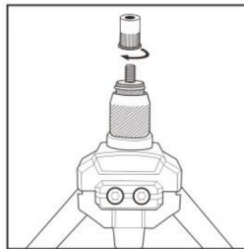

2 Insert a rivet nut into the nosepiece.

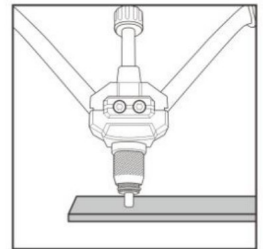

3 Insert the rivet nut into the hole.

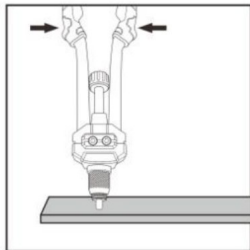

4 Squeeze the handle.

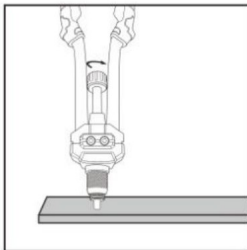

5 Unscrew the threaded mandrel from the gripped rivet nut completely

HOW TO CHANGE THREADED MANDREL AND NOSEPIECE

1. Remove and install the mandrel and nose pieces. Always keep the matched mandrel/nosepiece sets together.
2. Remove nosepiece from sleeve nut by unthreading the nosepiece anticlockwise. (see Fig. 1)
3. Remove sleeve nut by unthreading anticlockwise. (see Fig. 2)
4. Take out the mandrel directly to remove it from the head. (see Fig. 3)
5. Choose the correct mandrel/nosepiece to be installed.
6. Thread the new mandrel into the tool.
7. Install the sleeve nut and nosepiece.

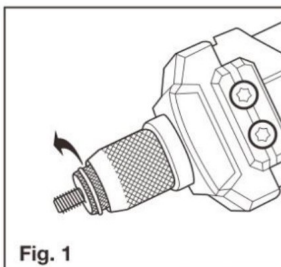

Fig. 1

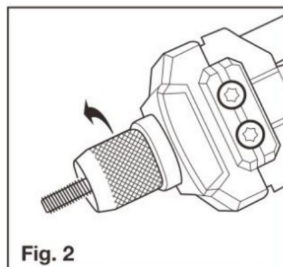

Fig. 2

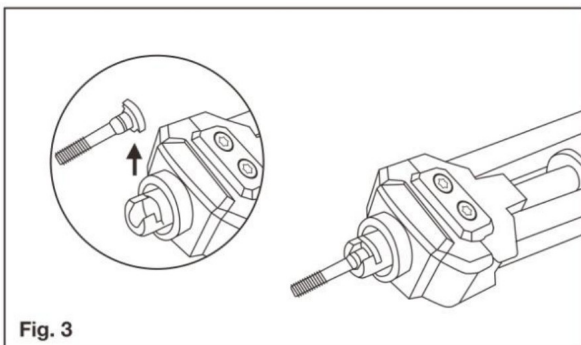
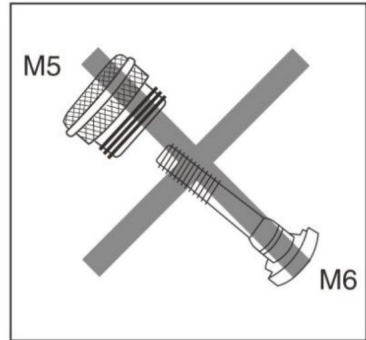
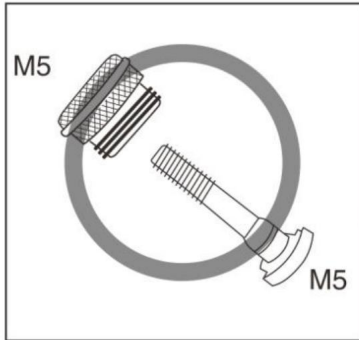

Fig. 3



Note Store matching nosepieces and mandrels together when not in use to prevent mismatching the sizes and for convenience.



Producent: Shanghai muxinmuyeyouxiangongsi Adres:

Shuangchenglu 803nong11hao1602A-1609shi, baoshanqu, szanghaj 200000 CN.

Importowane do AUS: SIHAO PTY LTD. 1 ROKEVA STREET EASTWOOD NSW 2122 Australia

Importowane do USA:

Sanven Technology Ltd. Suite 250, 9166 Anaheim Place, Rancho Cucamonga, CA 91730

REP WIELKIEJ BRYTANII	
-----------------------	--

YH CONSULTING LIMITED. C/O YH Consulting Limited
Biuro 147, Centurion House, London Road, Staines-upon-Thames, Surrey, TW18 4AX

Przedstawiciel UE	
-------------------	--

E-CrossStu GmbH
Mainzer Landstr.69,
60329 Frankfurt nad Menem.

VEVOR®

TOUGH TOOLS, HALF PRICE

Wsparcie techniczne i certyfikat gwarancji
elektronicznej www.vevor.com/support

VEVOR[®]

TOUGH TOOLS, HALF PRICE

**Supporto tecnico e certificato di garanzia
elettronica www.vevor.com/support**

RIVETTATRICE PER DADI 14 POLLICI

Continuiamo a impegnarci per fornirvi strumenti a prezzi competitivi.

"Risparmia la metà", "Metà prezzo" o qualsiasi altra espressione simile da noi utilizzata rappresenta solo una stima del risparmio che potresti ottenere acquistando determinati utensili con noi rispetto ai principali marchi principali e non necessariamente intende coprire tutte le categorie di utensili da noi offerti. Ti ricordiamo cortesemente di verificare attentamente quando effettui un ordine con noi se stai effettivamente risparmiando la metà rispetto ai principali marchi principali.

VEVOR[®]

TOUGH TOOLS, HALF PRICE

RIVETTATRICE PER DADI 14 POLLICI

MODELLO: DY-8806

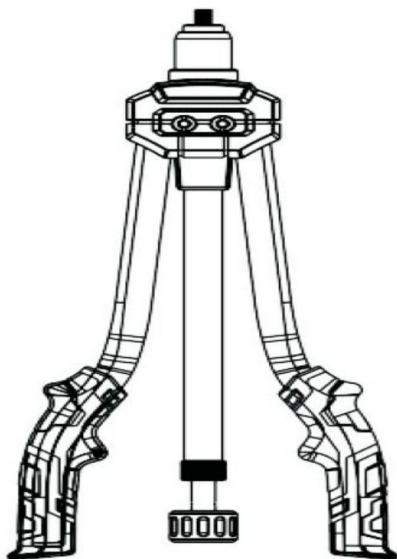



HAI BISOGNO DI AIUTO? CONTATTACI!

Hai domande sui prodotti? Hai bisogno di supporto tecnico? Non esitare a contattarci:

**Supporto tecnico e certificato di garanzia
elettronica www.vevor.com/support**

Questa è l'istruzione originale, si prega di leggere attentamente tutte le istruzioni del manuale prima di utilizzare. VEVOR si riserva una chiara interpretazione del nostro manuale utente. L'aspetto del prodotto sarà soggetto al prodotto ricevuto. Vi preghiamo di perdonarci se non vi informeremo di nuovo se ci sono aggiornamenti tecnologici o software sul nostro prodotto.

	Attenzione: per ridurre il rischio di lesioni, l'utente deve leggere attentamente il manuale di istruzioni.
	Attenzione: assicurarsi di indossare protezioni per gli occhi quando si utilizza questo prodotto.

INTENDED USE OF THE TOOL

This tool is intended to be used to install metric M4, M5, M6, M8, M10, M12 and SAE 10-24, 1/4-20, 5/16-18, 3/8-16, 1/2-13 rivet nuts. Do not use this tool outside of the designed intent. Never modify the tool for any other purpose or use.

SAFETY PRECAUTION

Caution: To help prevent personal injury.

- Normal use of this product is likely to expose the user to dust and/or microscopic particles containing chemicals that cause cancer, birth defects or other reproductive harm. Always wear appropriate safety equipment and clothing when using this product. Study, understand and follow all instructions provided with this product.
- Always wear CERTIFIED GOOGLES when using this product. (Users and By standers)
- Always select the correct accessories of the correct size and design for the job that you are attempting to perform.
- Never use this tool for any application other than for which it was designed.
- Only use accessories designed for this tool.
- Never alter or modify this tool in any way.

SET INCLUDES

14 in hand riveter

Interchangeable threaded mandrels & nosepieces:

10-24, 1/4-20, M6, 5/16-18, M8, 3/8-16, M10, 1pc

Steel rivet nuts: 10-24, 1/4-20, M6, 5/16-18, M8, 3/8-16, M10, 10pc

HOLE SIZE GUIDE

METRIC		SAE	
Nut Size	Hole Size	Nut Size	Hole Size
M6	9mm (3/8")	10-24	7mm (9/32")
M8	11mm (7/16")	1/4-20	9mm (23/64")
M10	13mm (17/32")	5/16-18	11mm (7/16")
		3/8-16	13mm (33/64")

OPERATION INSTRUCTIONS

1. Choose the rivet nut size to be installed.
2. Install the correct size mandrel/nosepiece for the rivet nut to be installed. See photos and instructions for changing the mandrel/nosepiece.
3. Drill a hole in the workpiece the same size or slightly larger than the outside diameter of the rivet nut to be installed, ref to the section of "HOLE SIZE GUIDE".
4. To install the rivet nut, open the handles outward as far as possible and thread the rivet nut clockwise onto the mandrel until reaching the nosepiece.
5. Insert the rivet nut fastened to the riveter into the pre-drilled hole until flush with the workpiece, squeeze two handles to touch the workpiece and secure the rivet nut into the hole. Open the handles outward to unscrew the threaded mandrel from the gripped rivet nut completely.

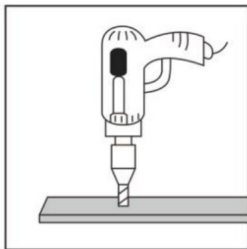

1 Drill with a pistol and drill first.

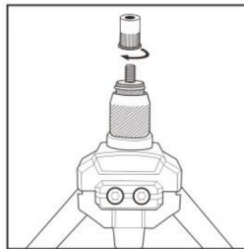

2 Insert a rivet nut into the nosepiece.

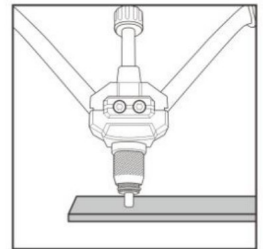

3 Insert the rivet nut into the hole.

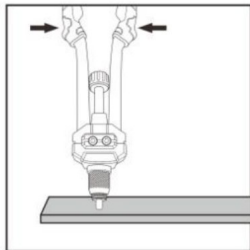

4 Squeeze the handle.

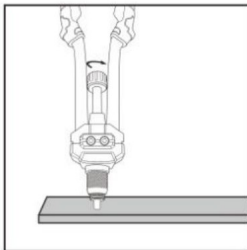

5 Unscrew the threaded mandrel from the gripped rivet nut completely

HOW TO CHANGE THREADED MANDREL AND NOSEPIECE

1. Remove and install the mandrel and nose pieces. Always keep the matched mandrel/nosepiece sets together.
2. Remove nosepiece from sleeve nut by unthreading the nosepiece anticlockwise. (see Fig. 1)
3. Remove sleeve nut by unthreading anticlockwise. (see Fig. 2)
4. Take out the mandrel directly to remove it from the head. (see Fig. 3)
5. Choose the correct mandrel/nosepiece to be installed.
6. Thread the new mandrel into the tool.
7. Install the sleeve nut and nosepiece.

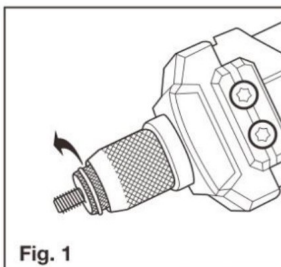

Fig. 1

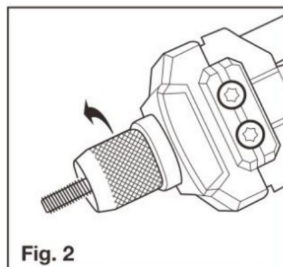

Fig. 2

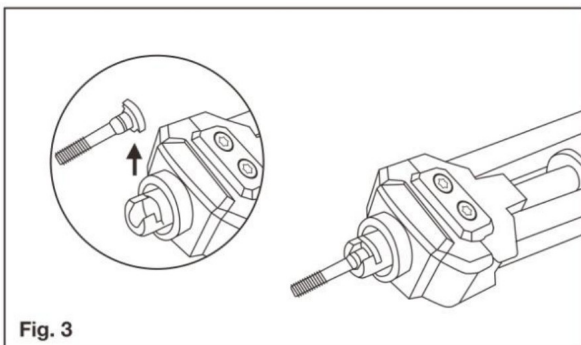
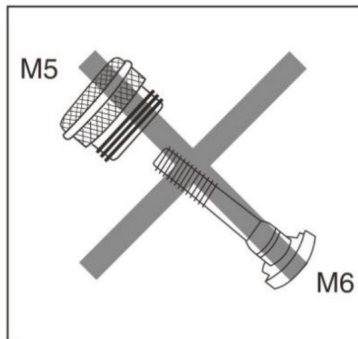
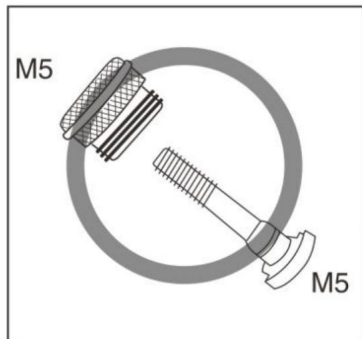

Fig. 3



Note Store matching nosepieces and mandrels together when not in use to prevent mismatching the sizes and for convenience.



Produttore: Shanghaimuxinmuyeyouxiangongsi **Indirizzo:**

Shuangchenglu 803nong11hao1602A-1609shi, baoshanqu, shanghai 200000 CN.

Importato in AUS: SIHAO PTY LTD. 1 ROKEVA STREETEASTWOOD NSW 2122
Australia **Importato negli**

USA: Sanven Technology Ltd. Suite 250, 9166 Anaheim Place, Rancho Cucamonga,
CA 91730



RAPPRESENTANZA DEL REGNO UNITO

YH CONSULTING LIMITED. C/O YH Consulting
Limited Ufficio 147, Centurion House, London
Road, Staines-upon-Thames, Surrey, TW18 4AX

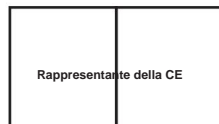

Rappresentante della CE

E-CrossStu GmbH
Via Magonza 69,
60329 Francoforte sul Meno.

VEVOR®

TOUGH TOOLS, HALF PRICE

**Supporto tecnico e certificato di garanzia
elettronica www.vevor.com/support**

VEVOR[®]

TOUGH TOOLS, HALF PRICE

Soporte técnico y certificado de garantía
electrónica www.vevor.com/support

REMACHADORA DE TUERCAS DE 14 PULGADAS

Seguimos comprometidos a brindarle herramientas a precios competitivos.

"Ahorre la mitad", "mitad de precio" o cualquier otra expresión similar que utilizemos solo representa una estimación del ahorro que podría obtener al comprar ciertas herramientas con nosotros en comparación con las principales marcas y no necesariamente significa que cubra todas las categorías de herramientas que ofrecemos. Le recordamos que, al realizar un pedido con nosotros, verifique cuidadosamente si realmente está ahorrando la mitad en comparación con las principales marcas.

VEVOR[®]

TOUGH TOOLS, HALF PRICE

REMACHADORA DE TUERCAS DE 14 PULGADAS

MODELO:DY-8806

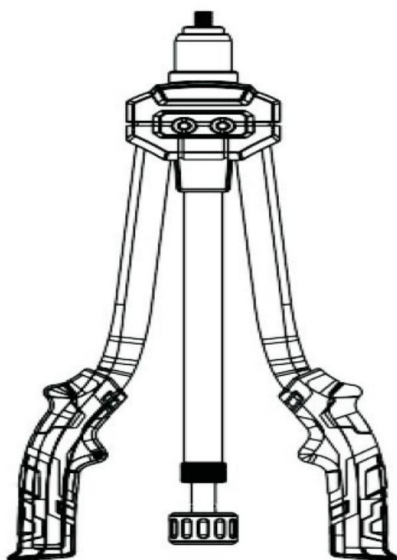



¿NECESITA AYUDA? ¡CONTÁCTENOS!

¿Tiene preguntas sobre el producto? ¿Necesita asistencia técnica? No dude en ponerse en contacto con nosotros:

Soporte técnico y certificado de garantía
electrónica www.vevor.com/support

Estas son las instrucciones originales, lea atentamente todas las instrucciones del manual antes de utilizar el producto. VEVOR se reserva una interpretación clara de nuestro manual de usuario. La apariencia del producto estará sujeta al producto que recibió. Perdónenos por no informarle nuevamente si hay actualizaciones de tecnología o software en nuestro producto.

	Advertencia: Para reducir el riesgo de lesiones, el usuario debe leer atentamente el manual de instrucciones.
	Advertencia: Asegúrese de usar protectores para los ojos cuando utilice este producto.

INTENDED USE OF THE TOOL

This tool is intended to be used to install metric M4, M5, M6, M8, M10, M12 and SAE 10-24, 1/4-20, 5/16-18, 3/8-16, 1/2-13 rivet nuts. Do not use this tool outside of the designed intent. Never modify the tool for any other purpose or use.

SAFETY PRECAUTION

Caution: To help prevent personal injury.

- Normal use of this product is likely to expose the user to dust and/or microscopic particles containing chemicals that cause cancer, birth defects or other reproductive harm. Always wear appropriate safety equipment and clothing when using this product. Study, understand and follow all instructions provided with this product.
- Always wear CERTIFIED GOOGLES when using this product. (Users and By standers)
- Always select the correct accessories of the correct size and design for the job that you are attempting to perform.
- Never use this tool for any application other than for which it was designed.
- Only use accessories designed for this tool.
- Never alter or modify this tool in any way.

SET INCLUDES

14 in hand riveter

Interchangeable threaded mandrels & nosepieces:

10-24, 1/4-20, M6, 5/16-18, M8, 3/8-16, M10, 1pc

Steel rivet nuts: 10-24, 1/4-20, M6, 5/16-18, M8, 3/8-16, M10, 10pc

HOLE SIZE GUIDE

METRIC		SAE	
Nut Size	Hole Size	Nut Size	Hole Size
M6	9mm (3/8")	10-24	7mm (9/32")
M8	11mm (7/16")	1/4-20	9mm (23/64")
M10	13mm (17/32")	5/16-18	11mm (7/16")
		3/8-16	13mm (33/64")

OPERATION INSTRUCTIONS

1. Choose the rivet nut size to be installed.
2. Install the correct size mandrel/nosepiece for the rivet nut to be installed. See photos and instructions for changing the mandrel/nosepiece.
3. Drill a hole in the workpiece the same size or slightly larger than the outside diameter of the rivet nut to be installed, ref to the section of "HOLE SIZE GUIDE".
4. To install the rivet nut, open the handles outward as far as possible and thread the rivet nut clockwise onto the mandrel until reaching the nosepiece.
5. Insert the rivet nut fastened to the riveter into the pre-drilled hole until flush with the workpiece, squeeze two handles to touch the workpiece and secure the rivet nut into the hole. Open the handles outward to unscrew the threaded mandrel from the gripped rivet nut completely.

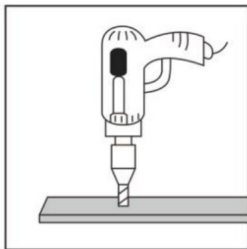

1 Drill with a pistol and drill first.

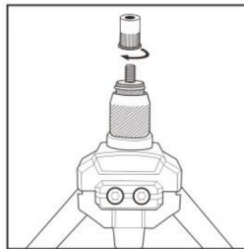

2 Insert a rivet nut into the nosepiece.

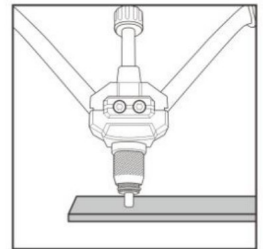

3 Insert the rivet nut into the hole.

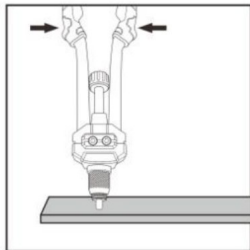

4 Squeeze the handle.

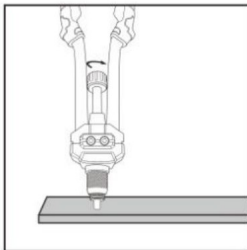

5 Unscrew the threaded mandrel from the gripped rivet nut completely

HOW TO CHANGE THREADED MANDREL AND NOSEPIECE

1. Remove and install the mandrel and nose pieces. Always keep the matched mandrel/nosepiece sets together.
2. Remove nosepiece from sleeve nut by unthreading the nosepiece anticlockwise. (see Fig. 1)
3. Remove sleeve nut by unthreading anticlockwise. (see Fig. 2)
4. Take out the mandrel directly to remove it from the head. (see Fig. 3)
5. Choose the correct mandrel/nosepiece to be installed.
6. Thread the new mandrel into the tool.
7. Install the sleeve nut and nosepiece.

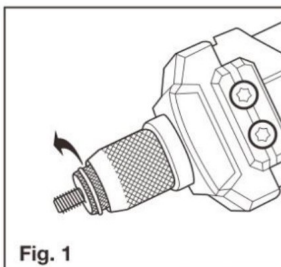

Fig. 1

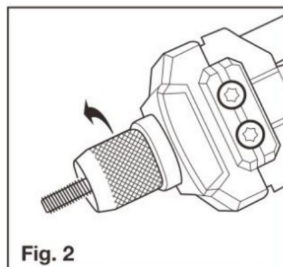

Fig. 2

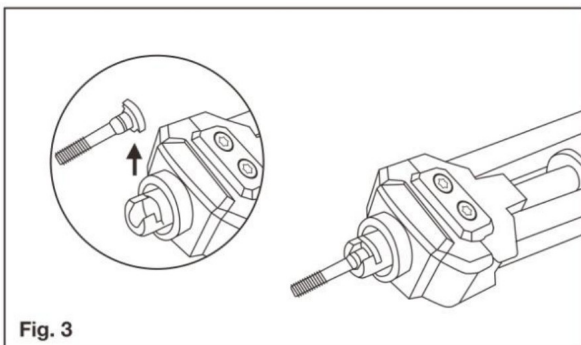
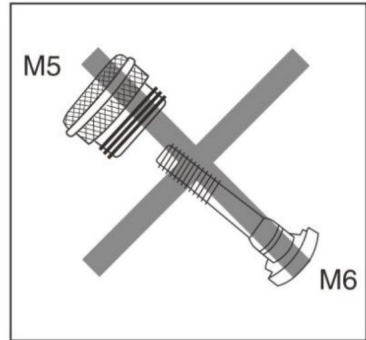
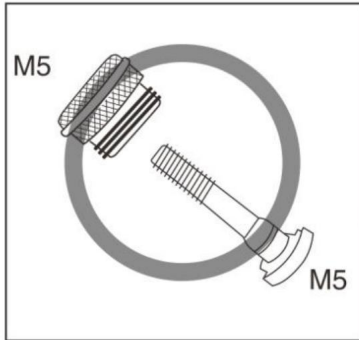

Fig. 3



Note Store matching nosepieces and mandrels together when not in use to prevent mismatching the sizes and for convenience.



Fabricante: Shanghaimuxinmuyeyouxiangongsi Dirección:

Shuangchenglu 803nong11hao1602A-1609shi, baoshanqu, shanghai 200000 CN.

Importado a AUS: SIHAO PTY LTD. 1 ROKEVA STREETEASTWOOD NSW 2122
Australia Importado a

EE. UU.: Sanven Technology Ltd. Suite 250, 9166 Anaheim Place, Rancho Cucamonga,
CA 91730

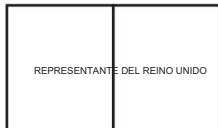

YH CONSULTING LIMITED. A LA DIRECCIÓN DE YH
Consulting Limited Oficina 147, Centurion House, London
Road, Staines-upon-Thames, Surrey, TW18 4AX

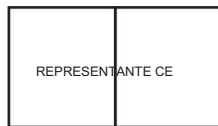

E-CrossStu GmbH
Calle Mainz Landstr.69,
60329 Fráncfort del Meno.

VEVOR®

TOUGH TOOLS, HALF PRICE

Soporte técnico y certificado de garantía
electrónica www.vevor.com/support

VEVOR[®]

TOUGH TOOLS, HALF PRICE

Teknisk support och e-garanticertifikat
www.vevor.com/support

MÖTTERNITA 14 TUM

Vi fortsätter att vara engagerade i att ge dig verktyg till konkurrenskraftiga priser.

"Spara halva", "halva priset" eller andra liknande uttryck som används av oss representerar bara en uppskattning av besparingar du kan dra nytta av att köpa vissa verktyg hos oss jämfört med de stora toppmärkena och doser behöver inte nödvändigtvis täcka alla kategorier av verktyg som erbjuds av oss. Du påminns vänligen om att noggrant kontrollera när du gör en beställning hos oss om du faktiskt sparar hälften i jämförelse med de främsta stora varumärkena.

VEVOR[®]
TOUGH TOOLS, HALF PRICE

MÖTTERNITA 14 TUM

MODELL: DY-8806

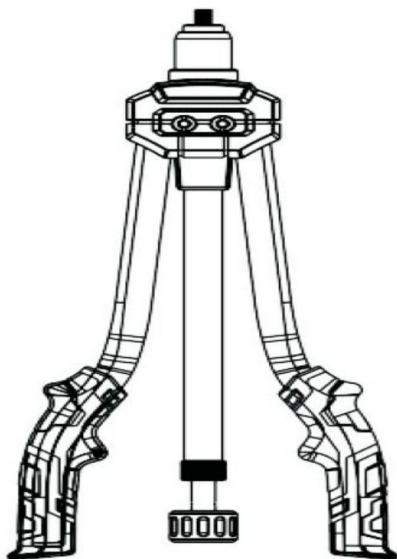



BEHÖVER HJÄLP? KONTAKTA OSS!

Har du produktfrågor? Behöver du teknisk support? Kontakta oss gärna:

Teknisk support och e-garanticertifikat
www.vevor.com/support

Detta är den ursprungliga instruktionen, läs alla instruktioner noggrant innan du använder den. VEVOR reserverar sig för en tydlig tolkning av vår användarmanual. Utseendet på produkten är beroende av den produkt du fått. Ursäkta oss att vi inte kommer att informera dig igen om det finns någon teknik eller mjukvaruuppdateringar på vår produkt.

	Varning - För att minska risken för skada måste användaren läsa instruktionerna noggrant.
	Varning- Var noga med att bära ögonskydd när du använder denna produkt.

INTENDED USE OF THE TOOL

This tool is intended to be used to install metric M4, M5, M6, M8, M10, M12 and SAE 10-24, 1/4-20, 5/16-18, 3/8-16, 1/2-13 rivet nuts. Do not use this tool outside of the designed intent. Never modify the tool for any other purpose or use.

SAFETY PRECAUTION

Caution: To help prevent personal injury.

- Normal use of this product is likely to expose the user to dust and/or microscopic particles containing chemicals that cause cancer, birth defects or other reproductive harm. Always wear appropriate safety equipment and clothing when using this product. Study, understand and follow all instructions provided with this product.
- Always wear CERTIFIED GOOGLES when using this product. (Users and By standers)
- Always select the correct accessories of the correct size and design for the job that you are attempting to perform.
- Never use this tool for any application other than for which it was designed.
- Only use accessories designed for this tool.
- Never alter or modify this tool in any way.

SET INCLUDES

14 in hand riveter

Interchangeable threaded mandrels & nosepieces:

10-24, 1/4-20, M6, 5/16-18, M8, 3/8-16, M10, 1pc

Steel rivet nuts: 10-24, 1/4-20, M6, 5/16-18, M8, 3/8-16, M10, 10pc

HOLE SIZE GUIDE

METRIC		SAE	
Nut Size	Hole Size	Nut Size	Hole Size
M6	9mm (3/8")	10-24	7mm (9/32")
M8	11mm (7/16")	1/4-20	9mm (23/64")
M10	13mm (17/32")	5/16-18	11mm (7/16")
		3/8-16	13mm (33/64")

OPERATION INSTRUCTIONS

1. Choose the rivet nut size to be installed.
2. Install the correct size mandrel/nosepiece for the rivet nut to be installed. See photos and instructions for changing the mandrel/nosepiece.
3. Drill a hole in the workpiece the same size or slightly larger than the outside diameter of the rivet nut to be installed, ref to the section of "HOLE SIZE GUIDE".
4. To install the rivet nut, open the handles outward as far as possible and thread the rivet nut clockwise onto the mandrel until reaching the nosepiece.
5. Insert the rivet nut fastened to the riveter into the pre-drilled hole until flush with the workpiece, squeeze two handles to touch the workpiece and secure the rivet nut into the hole. Open the handles outward to unscrew the threaded mandrel from the gripped rivet nut completely.

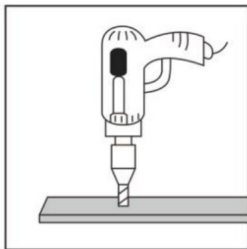

1 Drill with a pistol and drill first.

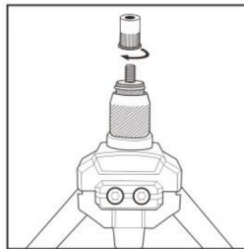

2 Insert a rivet nut into the nosepiece.

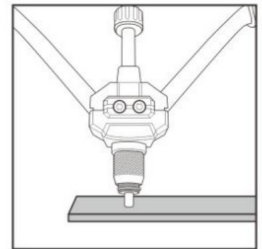

3 Insert the rivet nut into the hole.

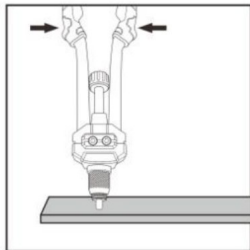

4 Squeeze the handle.

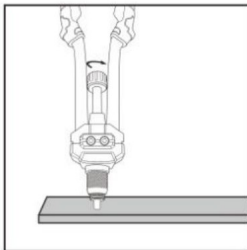

5 Unscrew the threaded mandrel from the gripped rivet nut completely

HOW TO CHANGE THREADED MANDREL AND NOSEPIECE

1. Remove and install the mandrel and nose pieces. Always keep the matched mandrel/nosepiece sets together.
2. Remove nosepiece from sleeve nut by unthreading the nosepiece anticlockwise. (see Fig. 1)
3. Remove sleeve nut by unthreading anticlockwise. (see Fig. 2)
4. Take out the mandrel directly to remove it from the head. (see Fig. 3)
5. Choose the correct mandrel/nosepiece to be installed.
6. Thread the new mandrel into the tool.
7. Install the sleeve nut and nosepiece.

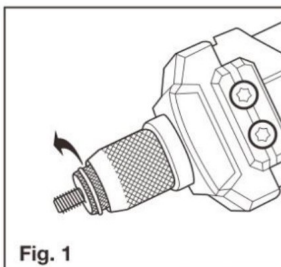

Fig. 1

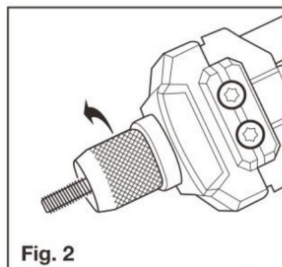

Fig. 2

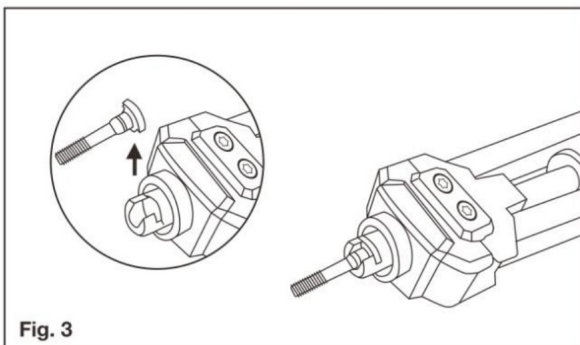
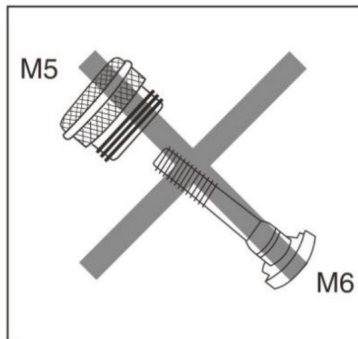
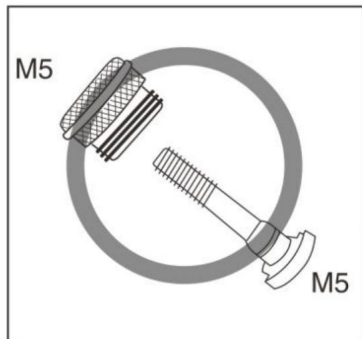

Fig. 3



Note Store matching nosepieces and mandrels together when not in use to prevent mismatching the sizes and for convenience.



Tillverkare: Shanghaimuxinmuyeyouxiangongsi **Adress:**

Shuangchenglu 803nong11hao1602A-1609shi, baoshanqu, shanghai 200000 CN.

Importerad till AUS: SIHAO PTY LTD. 1 ROKEVA STREETEASTWOOD NSW 2122
Australien **Importerad**

till USA: Sanven Technology Ltd. Suite 250, 9166 Anaheim Place, Rancho Cucamonga,
CA 91730



YH CONSULTING LIMITED. C/O YH Consulting
Limited Office 147, Centurion House, London
Road, Staines-upon-Thames, Surrey, TW18 4AX



E-CrossStu GmbH
Mainzer Landstr.69,
60329 Frankfurt am Main.

VEVOR®

TOUGH TOOLS, HALF PRICE

Teknisk support och e-garanticertifikat

www.vevor.com/support

VEVOR[®]

TOUGH TOOLS, HALF PRICE

**Technische ondersteuning en e-
garantiecertificaat www.vevor.com/support**

MOERKLINKMACHINE 14 INCH

Wij streven er voortdurend naar om u gereedschappen tegen concurrerende prijzen te leveren.

"Bespaar de helft", "halve prijs" of andere soortgelijke uitdrukkingen die wij gebruiken, geven alleen een schatting van de besparingen die u kunt behalen door bepaalde gereedschappen bij ons te kopen in vergelijking met de grote topmerken en doseringen betekenen niet noodzakelijkerwijs dat ze alle categorieën gereedschappen dekken die wij aanbieden. Wij herinneren u eraan om zorgvuldig te controleren of u daadwerkelijk de helft bespaart in vergelijking met de grote topmerken wanneer u een bestelling bij ons plaatst.

VEVOR[®]

TOUGH TOOLS, HALF PRICE

MOERKLINKMACHINE 14 INCH

MODEL: DY-8806

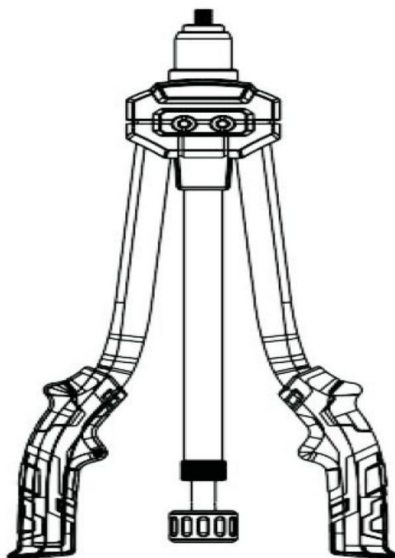



HULP NODIG? NEEM CONTACT MET ONS OP!

Heeft u vragen over het product? Heeft u technische ondersteuning nodig? Neem dan gerust contact met ons op:

**Technische ondersteuning en e-
garantiecertificaat www.vevor.com/support**

Dit is de originele instructie, lees alle handleidingen zorgvuldig door voordat u het product gebruikt. VEVOR behoudt zich een duidelijke interpretatie van onze gebruikershandleiding voor. Het uiterlijk van het product is afhankelijk van het product dat u hebt ontvangen. Vergeef ons dat we u niet opnieuw zullen informeren als er technologie- of software-updates voor ons product zijn.

	Waarschuwing: om het risico op letsel te verkleinen, moet de gebruiker de gebruiksaanwijzing zorgvuldig lezen.
	Waarschuwing: draag altijd een oogbescherming wanneer u dit product gebruikt.

INTENDED USE OF THE TOOL

This tool is intended to be used to install metric M4, M5, M6, M8, M10, M12 and SAE 10-24, 1/4-20, 5/16-18, 3/8-16, 1/2-13 rivet nuts. Do not use this tool outside of the designed intent. Never modify the tool for any other purpose or use.

SAFETY PRECAUTION

Caution: To help prevent personal injury.

- Normal use of this product is likely to expose the user to dust and/or microscopic particles containing chemicals that cause cancer, birth defects or other reproductive harm. Always wear appropriate safety equipment and clothing when using this product. Study, understand and follow all instructions provided with this product.
- Always wear CERTIFIED GOOGLES when using this product. (Users and By standers)
- Always select the correct accessories of the correct size and design for the job that you are attempting to perform.
- Never use this tool for any application other than for which it was designed.
- Only use accessories designed for this tool.
- Never alter or modify this tool in any way.

SET INCLUDES

14 in hand riveter

Interchangeable threaded mandrels & nosepieces:

10-24, 1/4-20, M6, 5/16-18, M8, 3/8-16, M10, 1pc

Steel rivet nuts: 10-24, 1/4-20, M6, 5/16-18, M8, 3/8-16, M10, 10pc

HOLE SIZE GUIDE

METRIC		SAE	
Nut Size	Hole Size	Nut Size	Hole Size
M6	9mm (3/8")	10-24	7mm (9/32")
M8	11mm (7/16")	1/4-20	9mm (23/64")
M10	13mm (17/32")	5/16-18	11mm (7/16")
		3/8-16	13mm (33/64")

OPERATION INSTRUCTIONS

1. Choose the rivet nut size to be installed.
2. Install the correct size mandrel/nosepiece for the rivet nut to be installed. See photos and instructions for changing the mandrel/nosepiece.
3. Drill a hole in the workpiece the same size or slightly larger than the outside diameter of the rivet nut to be installed, ref to the section of "HOLE SIZE GUIDE".
4. To install the rivet nut, open the handles outward as far as possible and thread the rivet nut clockwise onto the mandrel until reaching the nosepiece.
5. Insert the rivet nut fastened to the riveter into the pre-drilled hole until flush with the workpiece, squeeze two handles to touch the workpiece and secure the rivet nut into the hole. Open the handles outward to unscrew the threaded mandrel from the gripped rivet nut completely.

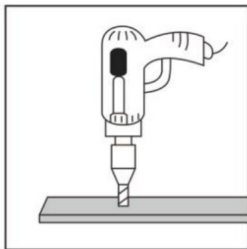

1 Drill with a pistol and drill first.

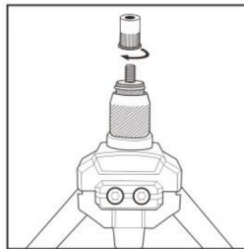

2 Insert a rivet nut into the nosepiece.

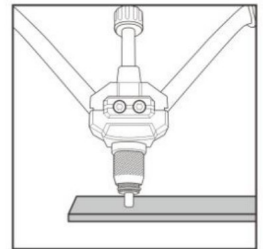

3 Insert the rivet nut into the hole.

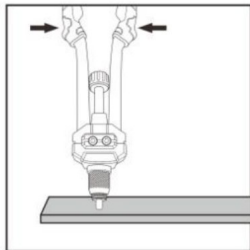

4 Squeeze the handle.

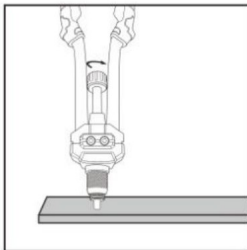

5 Unscrew the threaded mandrel from the gripped rivet nut completely

HOW TO CHANGE THREADED MANDREL AND NOSEPIECE

1. Remove and install the mandrel and nose pieces. Always keep the matched mandrel/nosepiece sets together.
2. Remove nosepiece from sleeve nut by unthreading the nosepiece anticlockwise. (see Fig. 1)
3. Remove sleeve nut by unthreading anticlockwise. (see Fig. 2)
4. Take out the mandrel directly to remove it from the head. (see Fig. 3)
5. Choose the correct mandrel/nosepiece to be installed.
6. Thread the new mandrel into the tool.
7. Install the sleeve nut and nosepiece.

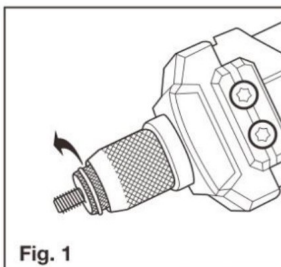

Fig. 1

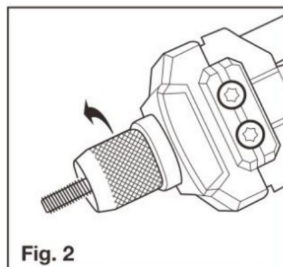

Fig. 2

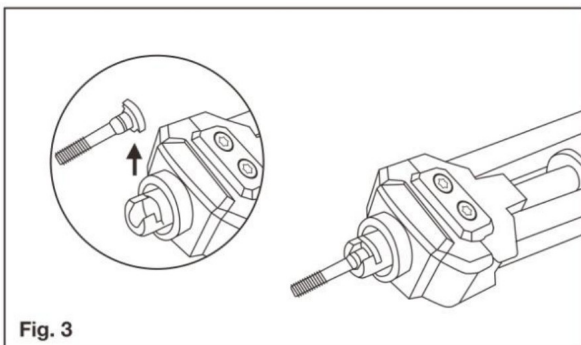
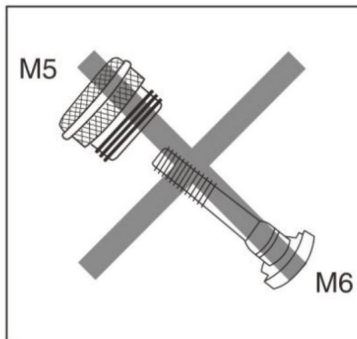
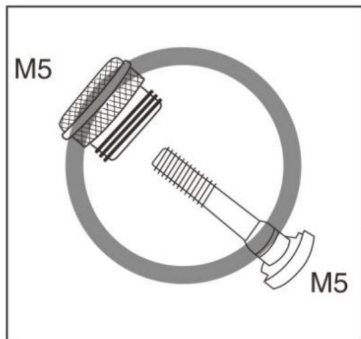

Fig. 3



Note Store matching nosepieces and mandrels together when not in use to prevent mismatching the sizes and for convenience.



Fabrikant: Shanghai muxin muyeyouxiangongsi **Adres:**

Shuangchenglu 803nong11hao1602A-1609shi, baoshanqu, shanghai 200000 CN.

Geïmporteerd naar AUS: SIHAO PTY LTD. 1 ROKEVA STREET EASTWOOD NSW 2122 Australië

Geïmporteerd naar de VS: Sanven Technology Ltd. Suite 250, 9166 Anaheim Place, Rancho Cucamonga, CA 91730



YH CONSULTING LIMITED. C/O YH Consulting Limited Kantoor 147, Centurion House, London Road, Staines-upon-Thames, Surrey, TW18 4AX



E-CrossStu GmbH
Mainzer Landstr.69,
60329 Frankfurt am Main.

VEVOR®

TOUGH TOOLS, HALF PRICE

Technische ondersteuning en e-
garantiecertificaat www.vevor.com/support

VEVOR®

TOUGH TOOLS, HALF PRICE

Assistance technique et certificat de garantie
électronique www.vevor.com/support

RIVET À ÉCROU 14 POUCES

Nous continuons à nous engager à vous fournir des outils à des prix compétitifs.

« Économisez la moitié », « Moitié prix » ou toute autre expression similaire utilisée par nous ne représente qu'une estimation des économies que vous pourriez réaliser en achetant certains outils chez nous par rapport aux grandes marques et ne couvre pas nécessairement toutes les catégories d'outils que nous proposons. Nous vous rappelons de bien vouloir vérifier soigneusement lorsque vous passez une commande chez nous si vous économisez réellement la moitié par rapport aux grandes marques.

VEVOR[®]
TOUGH TOOLS, HALF PRICE

RIVET À ÉCROU 14 POUCES

MODÈLE : DY-8806

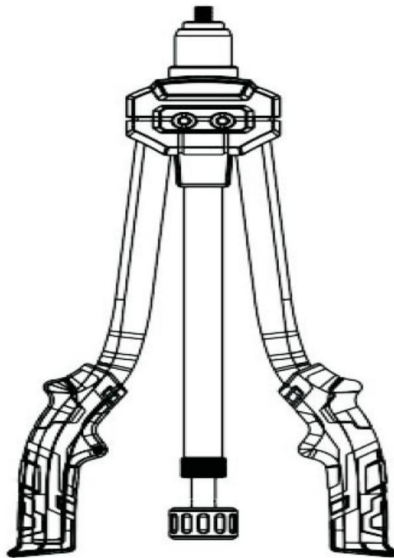



BESOIN D'AIDE? CONTACTEZ-NOUS!

Vous avez des questions sur les produits ? Vous avez besoin d'une assistance technique ? N'hésitez pas à nous contacter :

Assistance technique et certificat de garantie
électronique www.vevor.com/support

Il s'agit de la notice d'utilisation d'origine. Veuillez lire attentivement toutes les instructions du manuel avant de l'utiliser. VEVOR se réserve le droit d'interpréter clairement notre manuel d'utilisation. L'apparence du produit dépend du produit que vous avez reçu. Veuillez nous excuser, nous ne vous informerons plus en cas de mise à jour technologique ou logicielle de notre produit.

	<p>Avertissement - Pour réduire le risque de blessure, l'utilisateur doit lire attentivement le manuel d'instructions.</p>
	<p>Avertissement – Assurez-vous de porter des lunettes de protection lorsque vous utilisez ce produit.</p>

INTENDED USE OF THE TOOL

This tool is intended to be used to install metric M4, M5, M6, M8, M10, M12 and SAE 10-24, 1/4-20, 5/16-18, 3/8-16, 1/2-13 rivet nuts. Do not use this tool outside of the designed intent. Never modify the tool for any other purpose or use.

SAFETY PRECAUTION

Caution: To help prevent personal injury.

- Normal use of this product is likely to expose the user to dust and/or microscopic particles containing chemicals that cause cancer, birth defects or other reproductive harm. Always wear appropriate safety equipment and clothing when using this product. Study, understand and follow all instructions provided with this product.
- Always wear CERTIFIED GOOGLES when using this product. (Users and By standers)
- Always select the correct accessories of the correct size and design for the job that you are attempting to perform.
- Never use this tool for any application other than for which it was designed.
- Only use accessories designed for this tool.
- Never alter or modify this tool in any way.

SET INCLUDES

14 in hand riveter

Interchangeable threaded mandrels & nosepieces:

10-24, 1/4-20, M6, 5/16-18, M8, 3/8-16, M10, 1pc

Steel rivet nuts: 10-24, 1/4-20, M6, 5/16-18, M8, 3/8-16, M10, 10pc

HOLE SIZE GUIDE

METRIC		SAE	
Nut Size	Hole Size	Nut Size	Hole Size
M6	9mm (3/8")	10-24	7mm (9/32")
M8	11mm (7/16")	1/4-20	9mm (23/64")
M10	13mm (17/32")	5/16-18	11mm (7/16")
		3/8-16	13mm (33/64")

OPERATION INSTRUCTIONS

1. Choose the rivet nut size to be installed.
2. Install the correct size mandrel/nosepiece for the rivet nut to be installed. See photos and instructions for changing the mandrel/nosepiece.
3. Drill a hole in the workpiece the same size or slightly larger than the outside diameter of the rivet nut to be installed, ref to the section of "HOLE SIZE GUIDE".
4. To install the rivet nut, open the handles outward as far as possible and thread the rivet nut clockwise onto the mandrel until reaching the nosepiece.
5. Insert the rivet nut fastened to the riveter into the pre-drilled hole until flush with the workpiece, squeeze two handles to touch the workpiece and secure the rivet nut into the hole. Open the handles outward to unscrew the threaded mandrel from the gripped rivet nut completely.

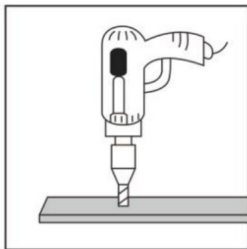

1 Drill with a pistol and drill first.

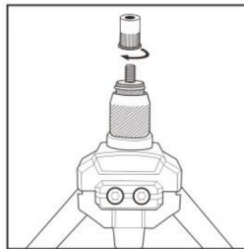

2 Insert a rivet nut into the nosepiece.

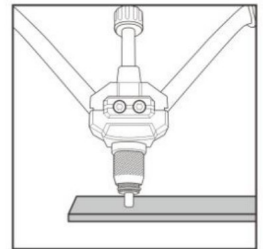

3 Insert the rivet nut into the hole.

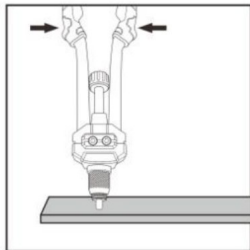

4 Squeeze the handle.

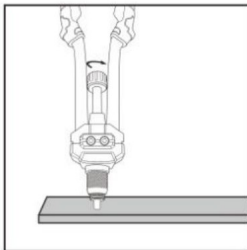

5 Unscrew the threaded mandrel from the gripped rivet nut completely

HOW TO CHANGE THREADED MANDREL AND NOSEPIECE

1. Remove and install the mandrel and nose pieces. Always keep the matched mandrel/nosepiece sets together.
2. Remove nosepiece from sleeve nut by unthreading the nosepiece anticlockwise. (see Fig. 1)
3. Remove sleeve nut by unthreading anticlockwise. (see Fig. 2)
4. Take out the mandrel directly to remove it from the head. (see Fig. 3)
5. Choose the correct mandrel/nosepiece to be installed.
6. Thread the new mandrel into the tool.
7. Install the sleeve nut and nosepiece.

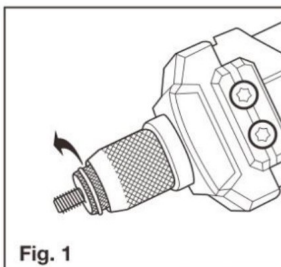

Fig. 1

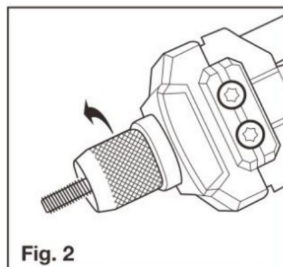

Fig. 2

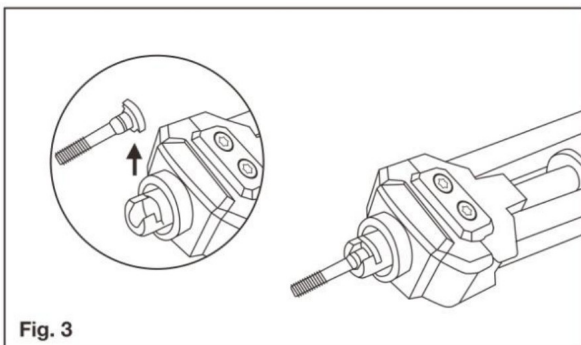
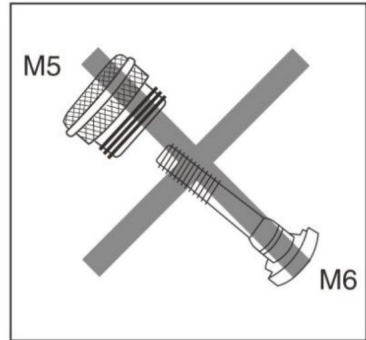
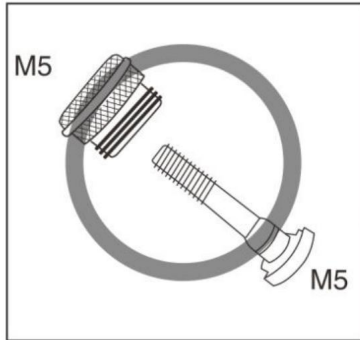

Fig. 3



Note Store matching nosepieces and mandrels together when not in use to prevent mismatching the sizes and for convenience.



Fabricant : Shanghai muxin muyeyouxiangongsi Adresse :
Shuangchenglu 803nong11hao1602A-1609shi, baoshanqu, shanghai 200000 CN.

Importé en AUS : SIHAO PTY LTD. 1 ROKEVA STREET EASTWOOD NSW 2122
Australie Importé aux

USA : Sanven Technology Ltd. Suite 250, 9166 Anaheim Place, Rancho Cucamonga,
CA 91730



YH CONSULTING LIMITED. C/O YH Consulting Limited
Bureau 147, Centurion House, London Road, Staines-
upon-Thames, Surrey, TW18 4AX



E-CrossStu GmbH
69, rue Mainzer Landstr.,
60329 Francfort-sur-le-Main.

VEVOR®

TOUGH TOOLS, HALF PRICE

Assistance technique et certificat de garantie
électronique www.vevor.com/support

VEVOR[®]

TOUGH TOOLS, HALF PRICE

Technischer Support und E-Garantie-Zertifikat
www.vevor.com/support

Mutternietzange 14 Zoll

Wir sind weiterhin bestrebt, Ihnen Werkzeuge zu wettbewerbsfähigen Preisen anzubieten.

„Sparen Sie die Hälfte“, „Halber Preis“ oder andere ähnliche Ausdrücke, die wir verwenden, stellen nur eine Schätzung der Ersparnis dar, die Sie beim Kauf bestimmter Werkzeuge bei uns im Vergleich zu den großen Topmarken erzielen können, und bedeuten nicht unbedingt, dass sie alle von uns angebotenen Werkzeugkategorien abdecken. Wir möchten Sie freundlich daran erinnern, bei Ihrer Bestellung bei uns sorgfältig zu prüfen, ob Sie im Vergleich zu den großen Topmarken tatsächlich die Hälfte sparen.

VEVOR[®]
TOUGH TOOLS, HALF PRICE

Mutternnetzange 14 Zoll

MODELL:DY-8806

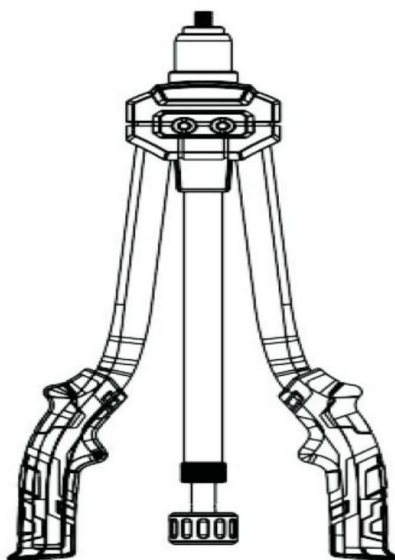



Brauchen Sie Hilfe? Kontaktieren Sie uns!

Sie haben Fragen zu unseren Produkten? Sie benötigen technischen Support? Dann kontaktieren Sie uns gerne:

Technischer Support und E-Garantie-Zertifikat
www.vevor.com/support

Dies ist die Originalanleitung. Bitte lesen Sie alle Anweisungen sorgfältig durch, bevor Sie das Gerät in Betrieb nehmen. VEVOR behält sich eine klare Auslegung unserer Bedienungsanleitung vor. Das Erscheinungsbild des Produkts richtet sich nach dem Produkt, das Sie erhalten haben. Bitte verzeihen Sie uns, dass wir Sie nicht erneut informieren, wenn es Technologie- oder Software-Updates für unser Produkt gibt.

	<p>Warnung: Um das Verletzungsrisiko zu verringern, muss der Benutzer die Bedienungsanleitung sorgfältig lesen.</p>
	<p>Warnung: Tragen Sie bei der Verwendung dieses Produkts unbedingt einen Augenschutz.</p>

INTENDED USE OF THE TOOL

This tool is intended to be used to install metric M4, M5, M6, M8, M10, M12 and SAE 10-24, 1/4-20, 5/16-18, 3/8-16, 1/2-13 rivet nuts. Do not use this tool outside of the designed intent. Never modify the tool for any other purpose or use.

SAFETY PRECAUTION

Caution: To help prevent personal injury.

- Normal use of this product is likely to expose the user to dust and/or microscopic particles containing chemicals that cause cancer, birth defects or other reproductive harm. Always wear appropriate safety equipment and clothing when using this product. Study, understand and follow all instructions provided with this product.
- Always wear CERTIFIED GOOGLES when using this product. (Users and By standers)
- Always select the correct accessories of the correct size and design for the job that you are attempting to perform.
- Never use this tool for any application other than for which it was designed.
- Only use accessories designed for this tool.
- Never alter or modify this tool in any way.

SET INCLUDES

14 in hand riveter

Interchangeable threaded mandrels & nosepieces:

10-24, 1/4-20, M6, 5/16-18, M8, 3/8-16, M10, 1pc

Steel rivet nuts: 10-24, 1/4-20, M6, 5/16-18, M8, 3/8-16, M10, 10pc

HOLE SIZE GUIDE

METRIC		SAE	
Nut Size	Hole Size	Nut Size	Hole Size
M6	9mm (3/8")	10-24	7mm (9/32")
M8	11mm (7/16")	1/4-20	9mm (23/64")
M10	13mm (17/32")	5/16-18	11mm (7/16")
		3/8-16	13mm (33/64")

OPERATION INSTRUCTIONS

1. Choose the rivet nut size to be installed.
2. Install the correct size mandrel/nosepiece for the rivet nut to be installed. See photos and instructions for changing the mandrel/nosepiece.
3. Drill a hole in the workpiece the same size or slightly larger than the outside diameter of the rivet nut to be installed, ref to the section of "HOLE SIZE GUIDE".
4. To install the rivet nut, open the handles outward as far as possible and thread the rivet nut clockwise onto the mandrel until reaching the nosepiece.
5. Insert the rivet nut fastened to the riveter into the pre-drilled hole until flush with the workpiece, squeeze two handles to touch the workpiece and secure the rivet nut into the hole. Open the handles outward to unscrew the threaded mandrel from the gripped rivet nut completely.

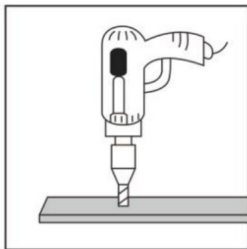

1 Drill with a pistol and drill first.

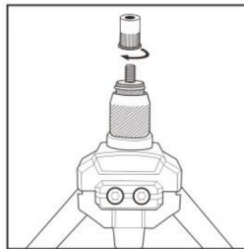

2 Insert a rivet nut into the nosepiece.

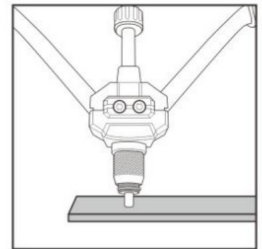

3 Insert the rivet nut into the hole.

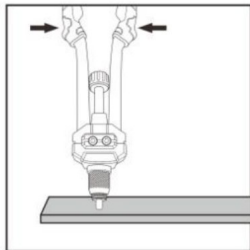

4 Squeeze the handle.

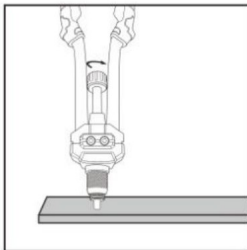

5 Unscrew the threaded mandrel from the gripped rivet nut completely

HOW TO CHANGE THREADED MANDREL AND NOSEPIECE

1. Remove and install the mandrel and nose pieces. Always keep the matched mandrel/nosepiece sets together.
2. Remove nosepiece from sleeve nut by unthreading the nosepiece anticlockwise. (see Fig. 1)
3. Remove sleeve nut by unthreading anticlockwise. (see Fig. 2)
4. Take out the mandrel directly to remove it from the head. (see Fig. 3)
5. Choose the correct mandrel/nosepiece to be installed.
6. Thread the new mandrel into the tool.
7. Install the sleeve nut and nosepiece.

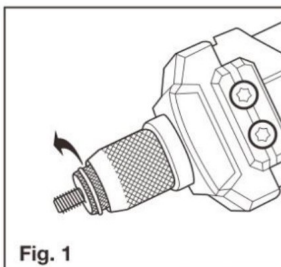

Fig. 1

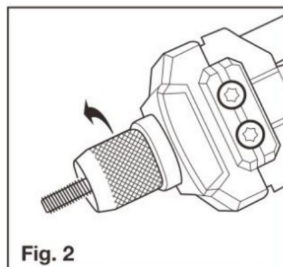

Fig. 2

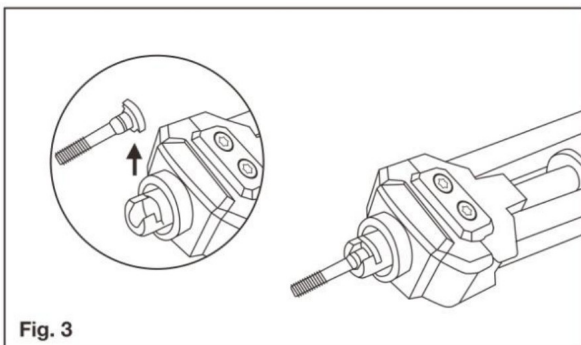
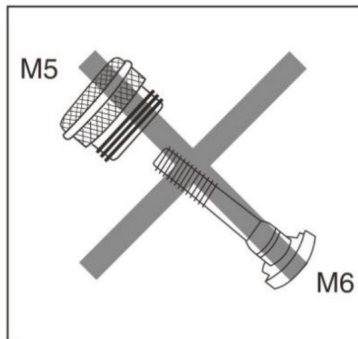
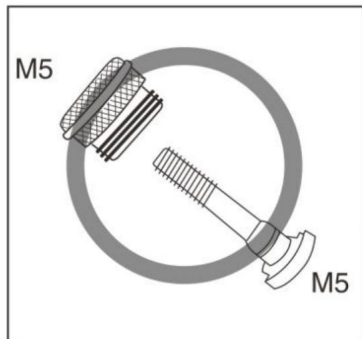

Fig. 3



Note Store matching nosepieces and mandrels together when not in use to prevent mismatching the sizes and for convenience.



Hersteller: Shanghai muxinmuyeyouxiangongsi **Adresse:**

Shuangchenglu 803nong11hao1602A-1609shi, baoshanqu, Shanghai 200000 CN.

Importiert nach AUS: SIHAO PTY LTD. 1 ROKEVA STREETEASTWOOD NSW 2122
Australien **Importiert**

nach USA: Sanven Technology Ltd. Suite 250, 9166 Anaheim Place, Rancho
Cucamonga, CA 91730



YH CONSULTING LIMITED. C/O YH Consulting
Limited Office 147, Centurion House, London
Road, Staines-upon-Thames, Surrey, TW18 4AX

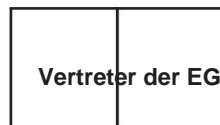

E-CrossStu GmbH
Mainzer Landstr.69,
60329 Frankfurt am Main.

VEVOR[®]

TOUGH TOOLS, HALF PRICE

Technischer Support und E-Garantie-Zertifikat

www.vevor.com/support