

VEVOR[®]

TOUGH TOOLS, HALF PRICE

Technical Support and E-Warranty Certificate www.vevor.com/support

Mounted Cat Shelf Installation Instructions

We continue to be committed to provide you tools with competitive price. "Save Half", "Half Price" or any other similar expressions used by us only represents an estimate of savings you might benefit from buying certain tools with us compared to the major top brands and does not necessarily mean to cover all categories of tools offered by us. You are kindly reminded to verify carefully when you are placing an order with us if you are actually saving half in comparison with the top major brands.

VEVOR®

TOUGH TOOLS, HALF PRICE

Mounted Cat Shelf

Model: SSGQK-03

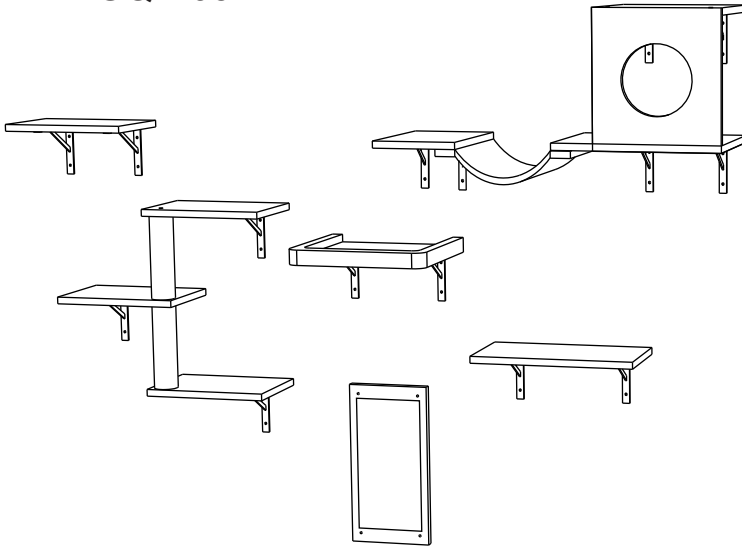

NEED HELP? CONTACT US!

Have product questions? Need technical support? Please feel free to contact us:











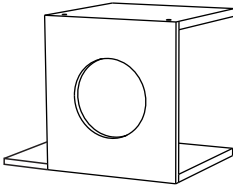

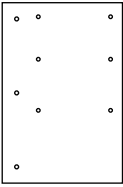
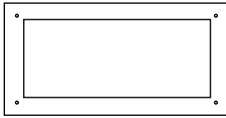
Technical Support and E-Warranty Certificate
www.vevor.com/support

This is the original instruction, please read all manual instructions carefully before operating. VEVOR reserves a clear interpretation of our user manual. The appearance of the product shall be subject to the product you received. Please forgive us that we won't inform you again if there are any technology or software updates on our product.



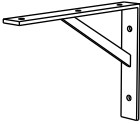

SPECIFICATIONS

Model	SSGQK-03
Color	Gray

COMPONENTS

 <p>Ax1</p>	 <p>Bx1</p>	 <p>Cx1</p>
 <p>Dx1</p>	 <p>Ex1</p>	 <p>Fx2</p>
 <p>Gx1</p>	 <p>Hx1</p>	 <p>Ix1</p>
 <p>Jx15</p>	 <p>K1x2</p>  <p>K2x2</p>	<p>(M8*70) (M8*35)</p>  <p>R1x1</p>  <p>R2x6</p>
<p>* each set of products is equipped with screwdrivers and wrenches</p>		

COMPONENTS

(M4*10)	(M4*22)	(M4*70)		
				
R3x45	R4x6	M1x30	M2x30	M3x30
* each set of products is equipped with screwdrivers and wrenches				

Assembly Instructions

TIPS:

- 1.The number of screws marked above is the actual number used during installation. When the product is shipped, 1~3 more screws of each type will be given as spares.
2. During the use of the product, children are prohibited from approaching without the company of adults.
3. The edge of the product is a bit sharp, and you need to wear gloves for installation; at the same time, it comes with sandpaper, so you can polish the edge again by yourself; without gloves, be careful when touching the running wheel.
- 4.Do not tighten the installation screws at once. Tighten the installation screws twice after all screws are aligned
- 5.It is recommended that two or more people install the device



6.Please use the following tools to install



Tape measure



Marker pen



screwdriver



Electric drill

Assembly Instructions

Please mark the position on the wall against the plate, reserve about 30cm distance between the jump platforms, drill the hole and bury the expansion tube
(A 6mm drill bit is used for solid walls and a yellow expansion tube is embedded; a 9mm drill bit is used for hollow walls and a butterfly expansion tube is embedded)

Expansion solenoid

Butterfly solenoid

M4*70

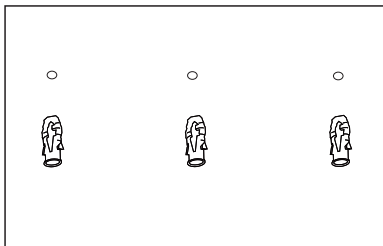

STEP 1

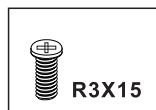
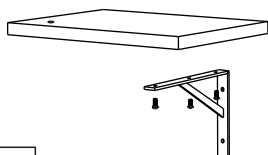
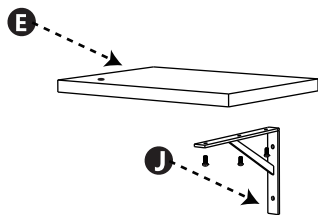
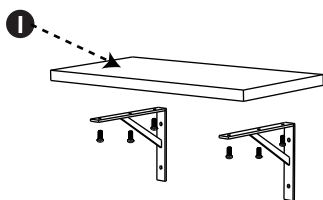

STEP 2

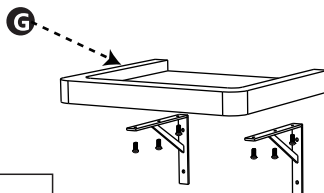
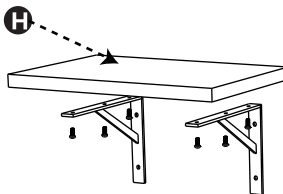
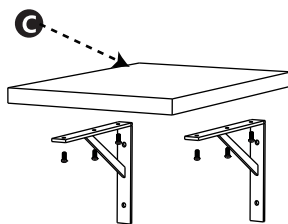

Assembly Instructions

STEP 3

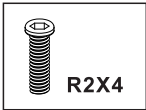
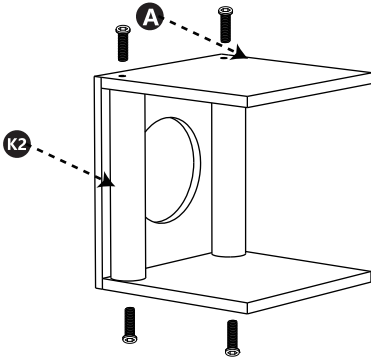

STEP 4

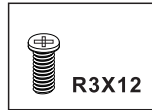
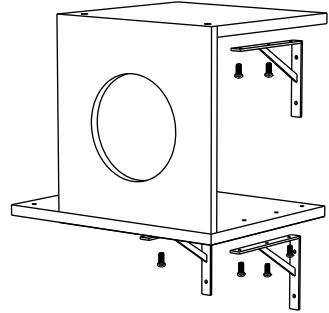

STEP 5

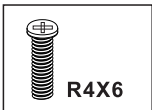
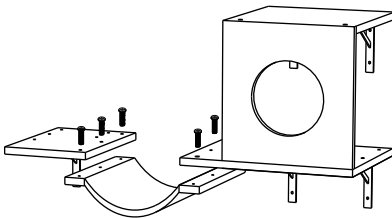

STEP 6

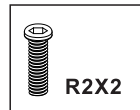
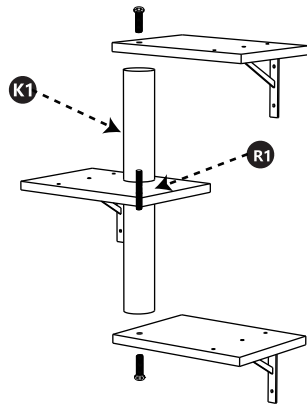

Assembly Instructions

STEP 7

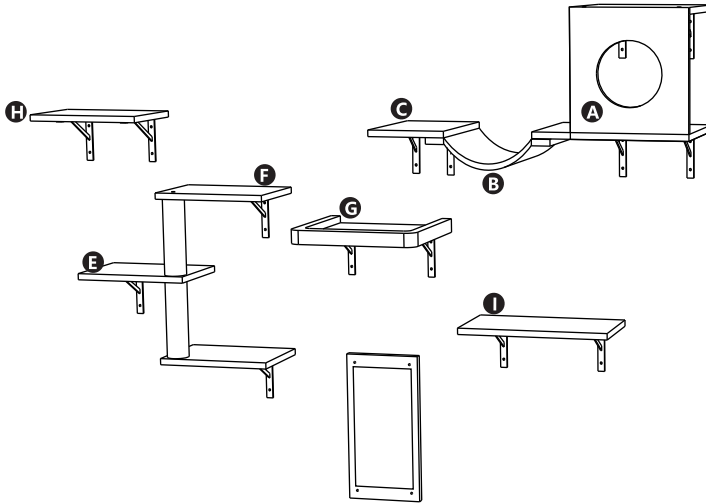

M1x30

All the parts are nailed to the wall
(It is recommended that the installation distance between jumps be about 30cm)

Address: Shuangchenglu 803nong11hao1602A-1609shi, baoshanqu, shanghai 200000 CN.

Imported to AUS: SIHAO PTY LTD, 1 ROKEVA STREETEASTWOOD NSW 2122 Australia

Imported to USA: Sanven Technology Ltd.Suite 250, 9166 Anaheim Place, Rancho Cucamonga, CA 91730



E-CrossStu GmbH.

Mainzer Landstr.69, 60329 Frankfurt am Main.



YH CONSULTING LIMITED.

C/O YH Consulting Limited Office 147, Centurion House,
London Road, Staines-upon-Thames, Surrey, TW18 4AX.

VEVOR[®]

TOUGH TOOLS, HALF PRICE

Technical Support and E-Warranty Certificate

www.vevor.com/support

VEVOR®

TOUGH TOOLS, HALF PRICE

Tecnico supporto e Certificato di garanzia elettronica Www.vevor.com/supporto

Mensola per gatti montata Installazione Istruzioni

continuiamo a Essere impegnato con fornirti gli strumenti competitivo prezzo. "salva Metà", "Metà prezzo" o qualsiasi altra espressione simile utilizzata da noi rappresenta solo UN stima del tuo risparmio potrebbe trarre beneficio da m acquistare determinati strumenti con noi rispetto al maggiore le migliori marche e fa non significa necessariamente coprire tutto categorie di strumenti s offerto da noi. Voi Sono si ricorda gentilmente di verificare attentamente quando si Sono collocazione UN ordina con noi se tu Sono effettivamente risparmiando metà dentro confronto con la massima specializzazione Marche.

VEVOR®

TOUGH TOOLS, HALF PRICE

Mounted Cat Shelf

Modello: SSGQK-03

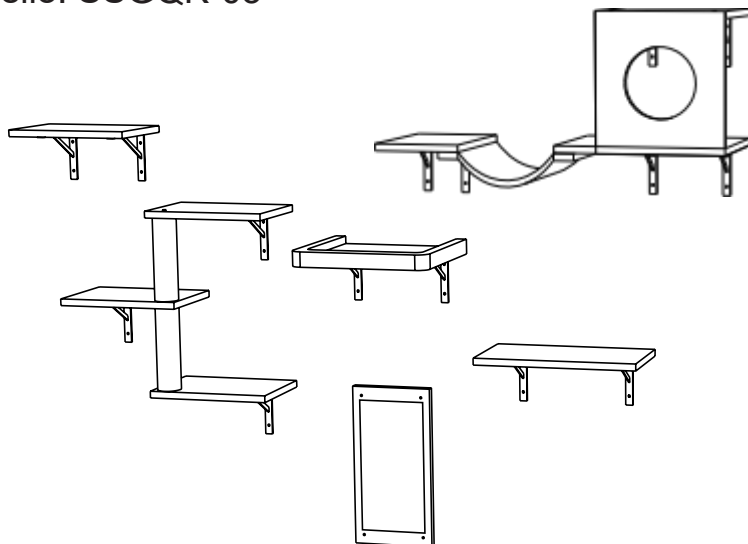

NEED HELP? CONTACT US!

Have product questions? Need technical support? Please feel free to contact us:











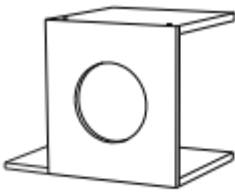

Technical Support and E-Warranty Certificate
www.vevor.com/support

This is the original instruction, please read all manual instructions carefully before operating. VEVOR reserves a clear interpretation of our user manual. The appearance of the product shall be subject to the product you received. Please forgive us that we won't inform you again if there are any technology or software updates on our product.



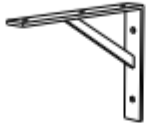

SPECIFICATIONS

Modello	SSGQK-03
Colore	Grigio

COMPONENTS

 <p>Ax1</p>	 <p>Bx1</p>	 <p>Cx1</p>
 <p>Dx1</p>	 <p>Ex1</p>	 <p>Fx2</p>
 <p>Gx1</p>	 <p>Hx1</p>	 <p>Ix1</p>
 <p>Jx15</p>	 <p>K1x2</p>  <p>K2x2</p>	<p>(M8*70) (M8*35)</p>  <p>R1x1</p>  <p>R2x6</p>
<p>* each set of products is equipped with screwdrivers and wrenches</p>		

COMPONENTS

(M4*10)	(M4*22)	(M4*70)		
				
R3x45	R4x6	M1x30	M2x30	M3x30
* each set of products is equipped with screwdrivers and wrenches				

Assembly Instructions

TIPS:

1. The number of screws marked above is the actual number used during installation. When the product is shipped, 1~3 more screws of each type will be given as spares.
2. During the use of the product, children are prohibited from approaching without the company of adults.
3. The edge of the product is a bit sharp, and you need to wear gloves for installation; at the same time, it comes with sandpaper, so you can polish the edge again by yourself; without gloves, be careful when touching the running wheel.
4. Do not tighten the installation screws at once. Tighten the installation screws twice after all screws are aligned
5. It is recommended that two or more people install the device



6. Please use the following tools to install



Tape measure



Marker pen



screwdriver



Electric drill

Assembly Instructions

Please mark the position on the wall against the plate, reserve about 30cm distance between the jump platforms, drill the hole and bury the expansion tube
(A 6mm drill bit is used for solid walls and a yellow expansion tube is embedded; a 9mm drill bit is used for hollow walls and a butterfly expansion tube is embedded)

Expansion
solenoid



Butterfly
solenoid



M4*70



STEP 1

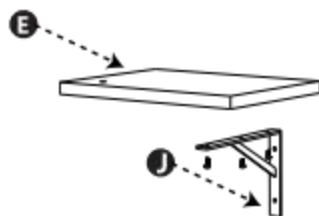
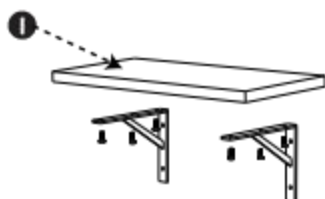

R3X15

STEP 2

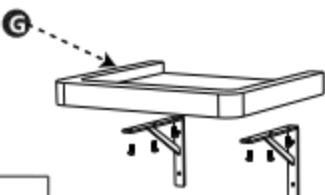
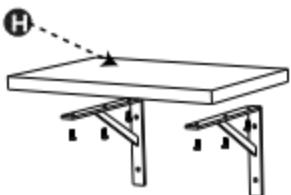
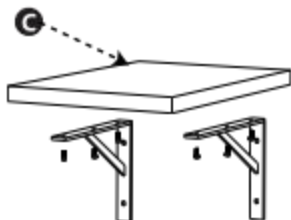

R3X18

Assembly Instructions

STEP 3

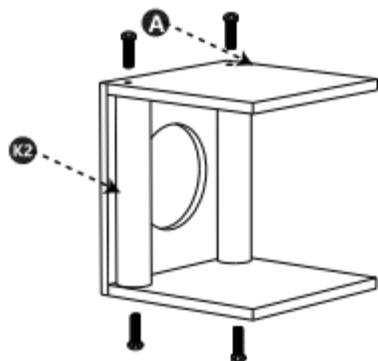

STEP 4

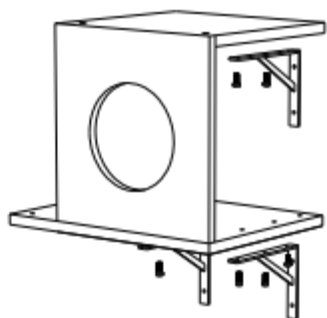

STEP 5

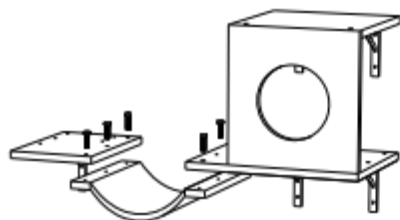

STEP 6

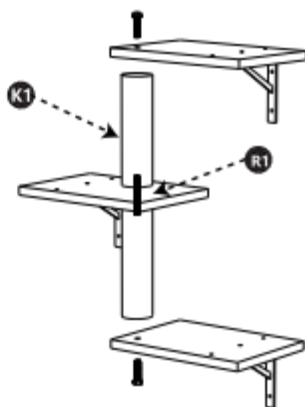

Assembly Instructions

STEP 7

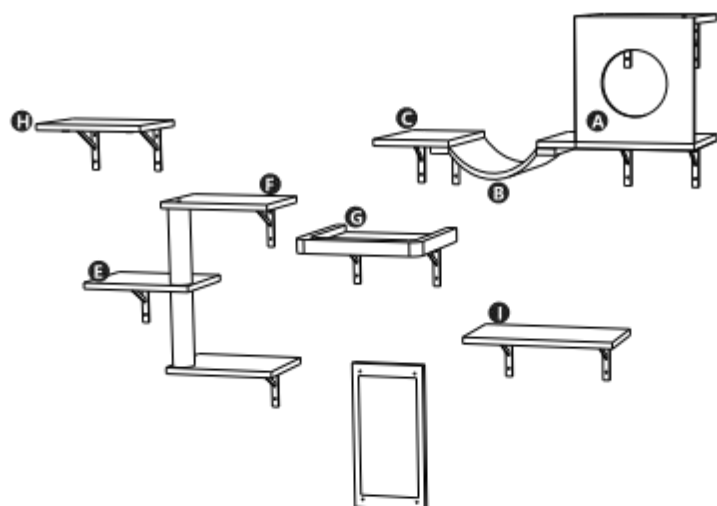

M1x30

All the parts are nailed to the wall

(It is recommended that the installation distance between jumps be about 30cm)

Address: Shuangchenglu 803nong11hao1602A-1609shi, baoshanqu, shanghai 200000 CN.

Imported to AUS: SIHAO PTY LTD, 1 ROKEVA STREETEASTWOOD NSW 2122 Australia

Imported to USA: Sanven Technology Ltd.Suite 250, 9166 Anaheim Place, Rancho Cucamonga, CA 91730

EC

REP

E-CrossStu GmbH.

Mainzer Landstr.69, 60329 Frankfurt am Main.

UK

REP

YH CONSULTING LIMITED.

C/O YH Consulting Limited Office 147, Centurion House,
London Road, Staines-upon-Thames, Surrey, TW18 4AX.

VEVOR[®]

TOUGH TOOLS, HALF PRICE

Supporto tecnico e Certificato di garanzia
elettronica [Www.vevor.com/supporto](http://www.vevor.com/supporto)



Techniczny wsparcie i Certyfikat e-gwarancji www.wevor.com/wsparcie

Zamontowana półka dla kota Instalacja Instrukcje

kontynuujemy Być zobowiązań się zapewnić Ci narzędzia konkurencyjny cena. "ratować Połowa", "Połowa ceny" lub jakiegokolwiek inne podobne wyrażenia przez nas stanowi jedynie jakiś oszacowanie oszczędności może skorzystać z m kupując określone narzędzia za pomocą nas w porównaniu z majorem najlepsze marki i robi niekoniecznie to znaczy przykryć wszystko kategorie narzędzia s oferowany przez nas. Ty

Czy Uprzejmie przypominamy, aby dokładnie sprawdzić, kiedy Czy umieszczanie jakiś zamów z nas Jeśli ty Czy faktycznie oszczędza w połowie porównanie z czołowym kierunkiem marki.

VEVOR®

TOUGH TOOLS, HALF PRICE

Mounted Cat Shelf

Model: SSGQK-03

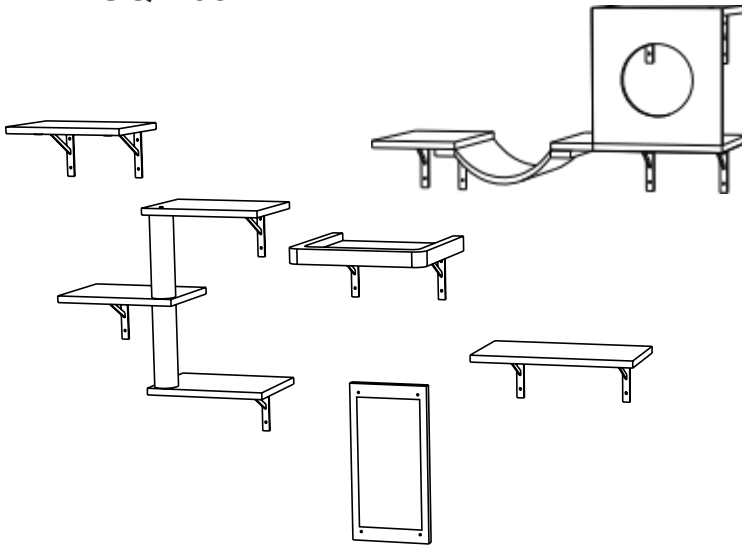

NEED HELP? CONTACT US!

Have product questions? Need technical support? Please feel free to contact us:











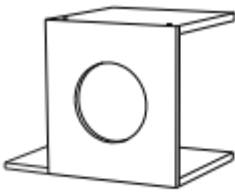

Technical Support and E-Warranty Certificate
www.vevor.com/support

This is the original instruction, please read all manual instructions carefully before operating. VEVOR reserves a clear interpretation of our user manual. The appearance of the product shall be subject to the product you received. Please forgive us that we won't inform you again if there are any technology or software updates on our product.



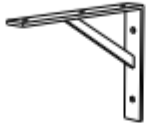

SPECIFICATIONS

Model	SSGQK-03
Kolor	Szary

COMPONENTS

 <p>Ax1</p>	 <p>Bx1</p>	 <p>Cx1</p>
 <p>Dx1</p>	 <p>Ex1</p>	 <p>Fx2</p>
 <p>Gx1</p>	 <p>Hx1</p>	 <p>Ix1</p>
 <p>Jx15</p>	 <p>K1x2</p>  <p>K2x2</p>	<p>(M8*70) (M8*35)</p>  <p>R1x1</p>  <p>R2x6</p>
<p>* each set of products is equipped with screwdrivers and wrenches</p>		

COMPONENTS

(M4*10)	(M4*22)	(M4*70)		
				
R3x45	R4x6	M1x30	M2x30	M3x30
* each set of products is equipped with screwdrivers and wrenches				

Assembly Instructions

TIPS:

1. The number of screws marked above is the actual number used during installation. When the product is shipped, 1~3 more screws of each type will be given as spares.
2. During the use of the product, children are prohibited from approaching without the company of adults.
3. The edge of the product is a bit sharp, and you need to wear gloves for installation; at the same time, it comes with sandpaper, so you can polish the edge again by yourself; without gloves, be careful when touching the running wheel.
4. Do not tighten the installation screws at once. Tighten the installation screws twice after all screws are aligned
5. It is recommended that two or more people install the device



6. Please use the following tools to install



Tape measure



Marker pen



screwdriver



Electric drill

Assembly Instructions

Please mark the position on the wall against the plate, reserve about 30cm distance between the jump platforms, drill the hole and bury the expansion tube
(A 6mm drill bit is used for solid walls and a yellow expansion tube is embedded; a 9mm drill bit is used for hollow walls and a butterfly expansion tube is embedded)

Expansion
solenoid



Butterfly
solenoid



M4*70



STEP 1

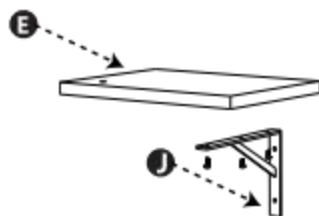
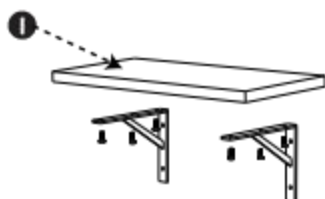

R3X15

STEP 2

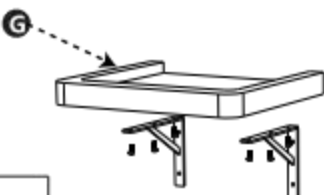
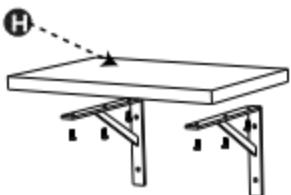
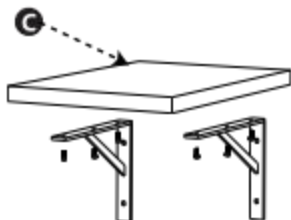

R3X18

Assembly Instructions

STEP 3

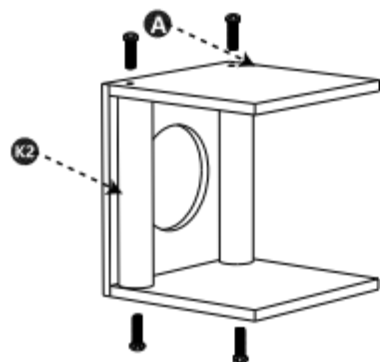

R2X4

STEP 4

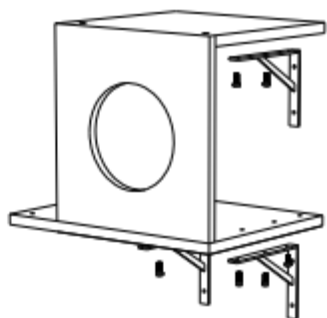

R3X12

STEP 5

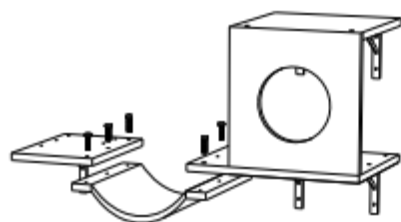

R4X6

STEP 6

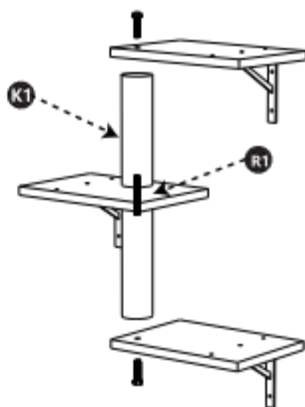

R2X2

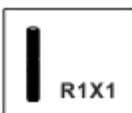

R1X1

Assembly Instructions

STEP 7

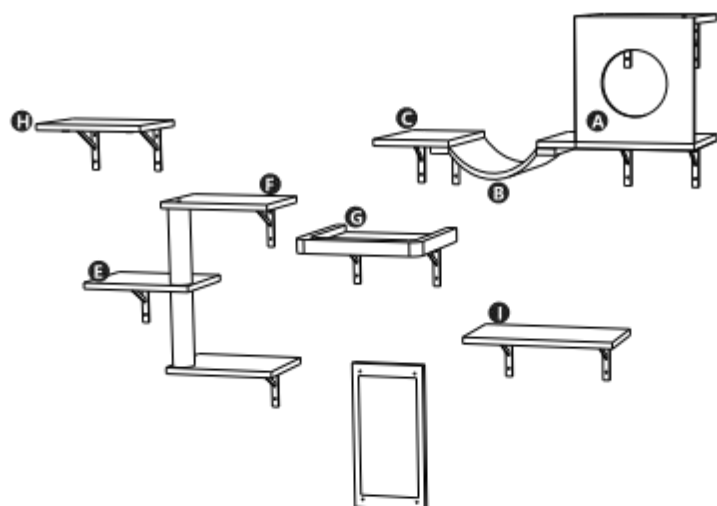

M1x30

All the parts are nailed to the wall

(It is recommended that the installation distance between jumps be about 30cm)

Address: Shuangchenglu 803nong11hao1602A-1609shi, baoshanqu, shanghai 200000 CN.

Imported to AUS: SIHAO PTY LTD, 1 ROKEVA STREETEASTWOOD NSW 2122 Australia

Imported to USA: Sanven Technology Ltd.Suite 250, 9166 Anaheim Place, Rancho Cucamonga, CA 91730

EC

REP

E-CrossStu GmbH.

Mainzer Landstr.69, 60329 Frankfurt am Main.

UK

REP

YH CONSULTING LIMITED.

C/O YH Consulting Limited Office 147, Centurion House,
London Road, Staines-upon-Thames, Surrey, TW18 4AX.

VEVOR[®]

TOUGH TOOLS, HALF PRICE

Wsparcie techniczne i Certyfikat gwarancji
elektronicznej www.vevor.com/wsparcie

VEVOR®

TOUGH TOOLS, HALF PRICE

Technisch Unterstützung und E-Garantiezertifikat [Www.vevor.com/support](http://www.vevor.com/support)

Montiertes Katzenregal Installation Anweisungen

wir fahren fort Sei verpflichtet bieten Ihnen Werkzeuge mit wettbewerbsfähig
Preis.

"speichern Halb", "Zum halben Preis" oder andere ähnliche Ausdrücke von uns stellt nur
ein

Schätzung der Einsparungen, die Sie könnte von m profitieren Kauf bestimmter Werkzeuge
mit uns im Vergleich zu den großen Top-Marken und tut nicht unbedingt bedeuten alles
abdecken Kategorien von Werkzeugen angeboten von uns. Du

Sind Bitte überprüfen Sie sorgfältig, wenn Sie Sind Platzierung ein Bestellen mit uns
wenn du Sind tatsächlich sparen halb in Vergleich mit den Top-Major
Marken.

VEVOR®

TOUGH TOOLS, HALF PRICE

Mounted Cat Shelf

Modell: SSGQK-03

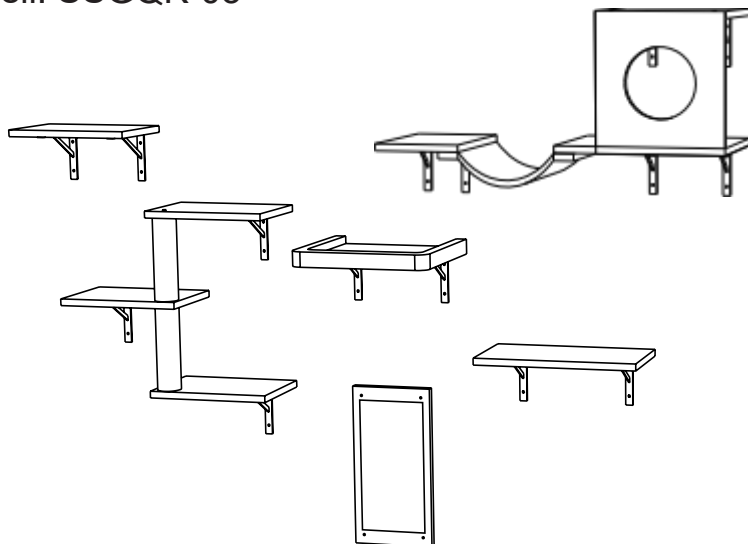

NEED HELP? CONTACT US!

Have product questions? Need technical support? Please feel free to contact us:











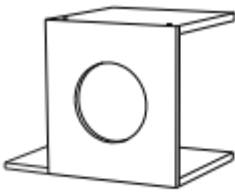

Technical Support and E-Warranty Certificate
www.vevor.com/support

This is the original instruction, please read all manual instructions carefully before operating. VEVOR reserves a clear interpretation of our user manual. The appearance of the product shall be subject to the product you received. Please forgive us that we won't inform you again if there are any technology or software updates on our product.



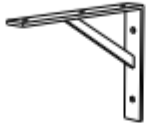

SPECIFICATIONS

Modell	SSGQK-03
Farbe	Grau

COMPONENTS

 <p>Ax1</p>	 <p>Bx1</p>	 <p>Cx1</p>
 <p>Dx1</p>	 <p>Ex1</p>	 <p>Fx2</p>
 <p>Gx1</p>	 <p>Hx1</p>	 <p>Ix1</p>
 <p>Jx15</p>	 <p>K1x2</p>  <p>K2x2</p>	<p>(M8*70) (M8*35)</p>  <p>R1x1</p>  <p>R2x6</p>
<p>* each set of products is equipped with screwdrivers and wrenches</p>		

COMPONENTS

(M4*10)	(M4*22)	(M4*70)		
				
R3x45	R4x6	M1x30	M2x30	M3x30
* each set of products is equipped with screwdrivers and wrenches				

Assembly Instructions

TIPS:

1. The number of screws marked above is the actual number used during installation. When the product is shipped, 1~3 more screws of each type will be given as spares.
2. During the use of the product, children are prohibited from approaching without the company of adults.
3. The edge of the product is a bit sharp, and you need to wear gloves for installation; at the same time, it comes with sandpaper, so you can polish the edge again by yourself; without gloves, be careful when touching the running wheel.
4. Do not tighten the installation screws at once. Tighten the installation screws twice after all screws are aligned
5. It is recommended that two or more people install the device



6. Please use the following tools to install



Tape measure



Marker pen



screwdriver



Electric drill

Assembly Instructions

Please mark the position on the wall against the plate, reserve about 30cm distance between the jump platforms, drill the hole and bury the expansion tube
(A 6mm drill bit is used for solid walls and a yellow expansion tube is embedded; a 9mm drill bit is used for hollow walls and a butterfly expansion tube is embedded)

Expansion
solenoid



Butterfly
solenoid



M4*70



STEP 1

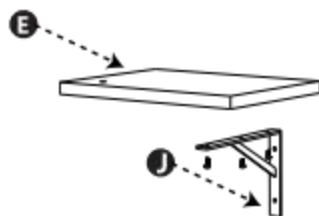
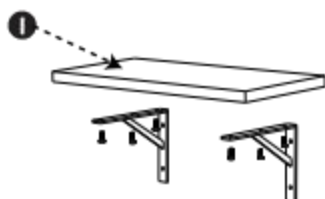

R3X15

STEP 2

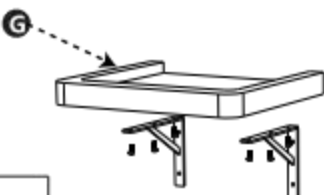
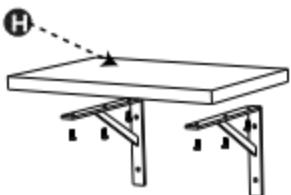
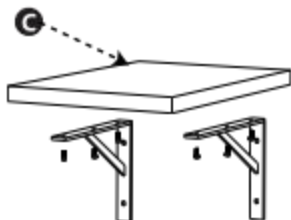

R3X18

Assembly Instructions

STEP 3

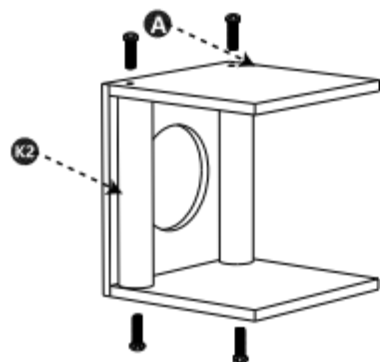

R2X4

STEP 4

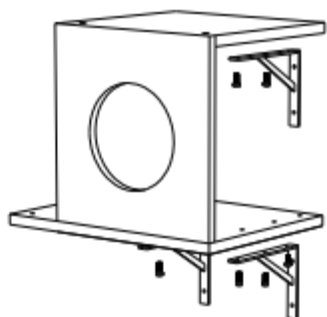

R3X12

STEP 5

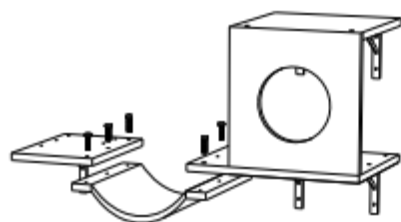

R4X6

STEP 6

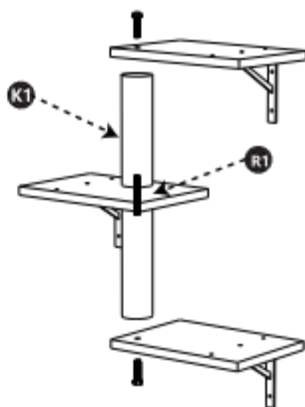

R2X2

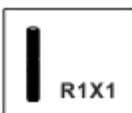

R1X1

Assembly Instructions

STEP 7

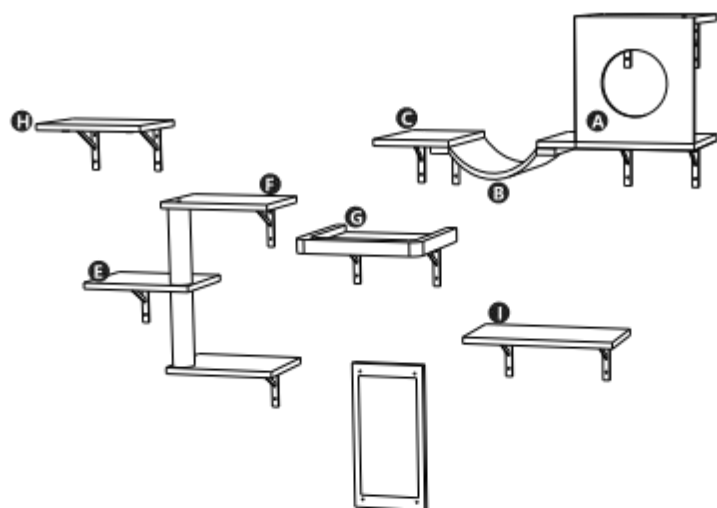

M1x30

All the parts are nailed to the wall

(It is recommended that the installation distance between jumps be about 30cm)

Address: Shuangchenglu 803nong11hao1602A-1609shi, baoshanqu, shanghai 200000 CN.

Imported to AUS: SIHAO PTY LTD, 1 ROKEVA STREETEASTWOOD NSW 2122 Australia

Imported to USA: Sanven Technology Ltd.Suite 250, 9166 Anaheim Place, Rancho Cucamonga, CA 91730

EC

REP

E-CrossStu GmbH.

Mainzer Landstr.69, 60329 Frankfurt am Main.

UK

REP

YH CONSULTING LIMITED.

C/O YH Consulting Limited Office 147, Centurion House,
London Road, Staines-upon-Thames, Surrey, TW18 4AX.

VEVOR[®]

TOUGH TOOLS, HALF PRICE

Technischer Support und E- Garantie-
Zertifikat www.vevor.com/support

VEVOR®

TOUGH TOOLS, HALF PRICE

Technique soutien et Certificat de garantie électronique [Www.vevor.com/support](http://www.vevor.com/support)

Étagère pour chat montée Installation Instructions

nous continuons à être engagé à vous fournir des outils avec compétitif prix. "sauvegarder Moitié", "Moitié prix" ou toute autre expression similaire utilisée par nous ne représente que un estimation des économies que vous pourrait bénéficier de acheter certains outils avec nous par rapport aux majors grandes marques et fait ne veut pas nécessairement dire couvrir tout catégories d' outils offert par nous. Toi sont Nous vous rappelons de vérifier attentivement lorsque vous sont placement un commander avec nous si tu sont en fait, j'économise à moitié dedans comparaison avec le top majeur marques.

VEVOR®

TOUGH TOOLS, HALF PRICE

Mounted Cat Shelf

Modèle : SSGQK-03

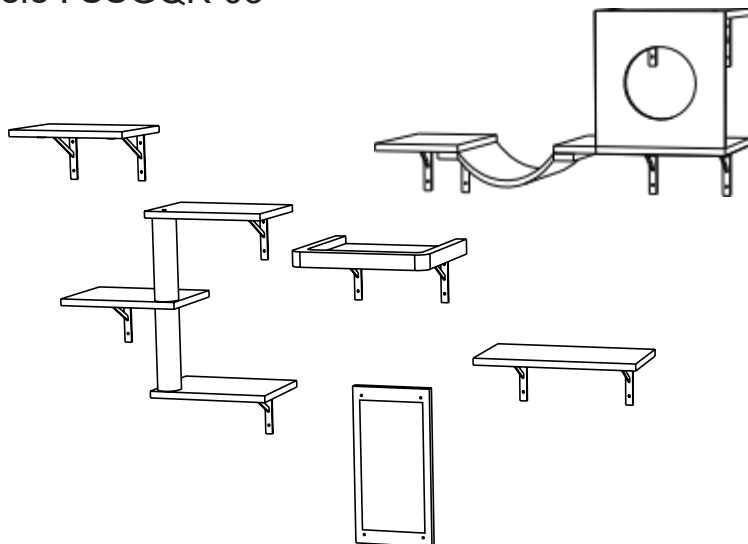

NEED HELP? CONTACT US!

Have product questions? Need technical support? Please feel free to contact us:











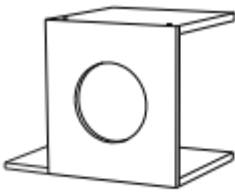

Technical Support and E-Warranty Certificate
www.vevor.com/support

This is the original instruction, please read all manual instructions carefully before operating. VEVOR reserves a clear interpretation of our user manual. The appearance of the product shall be subject to the product you received. Please forgive us that we won't inform you again if there are any technology or software updates on our product.



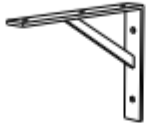

SPECIFICATIONS

Modèle	SSGQK-03
Couleur	Gris

COMPONENTS

 <p>Ax1</p>	 <p>Bx1</p>	 <p>Cx1</p>
 <p>Dx1</p>	 <p>Ex1</p>	 <p>Fx2</p>
 <p>Gx1</p>	 <p>Hx1</p>	 <p>Ix1</p>
 <p>Jx15</p>	 <p>K1x2</p>  <p>K2x2</p>	<p>(M8*70) (M8*35)</p>  <p>R1x1</p>  <p>R2x6</p>
<p>* each set of products is equipped with screwdrivers and wrenches</p>		

COMPONENTS

(M4*10)	(M4*22)	(M4*70)		
				
R3x45	R4x6	M1x30	M2x30	M3x30
* each set of products is equipped with screwdrivers and wrenches				

Assembly Instructions

TIPS:

1. The number of screws marked above is the actual number used during installation. When the product is shipped, 1~3 more screws of each type will be given as spares.
2. During the use of the product, children are prohibited from approaching without the company of adults.
3. The edge of the product is a bit sharp, and you need to wear gloves for installation; at the same time, it comes with sandpaper, so you can polish the edge again by yourself; without gloves, be careful when touching the running wheel.
4. Do not tighten the installation screws at once. Tighten the installation screws twice after all screws are aligned
5. It is recommended that two or more people install the device



6. Please use the following tools to install



Tape measure



Marker pen



screwdriver



Electric drill

Assembly Instructions

Please mark the position on the wall against the plate, reserve about 30cm distance between the jump platforms, drill the hole and bury the expansion tube
(A 6mm drill bit is used for solid walls and a yellow expansion tube is embedded; a 9mm drill bit is used for hollow walls and a butterfly expansion tube is embedded)

Expansion
solenoid



Butterfly
solenoid



M4*70



STEP 1

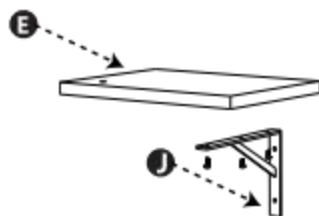
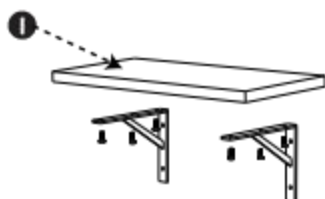

R3X15

STEP 2

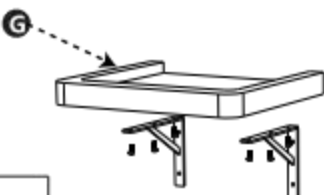
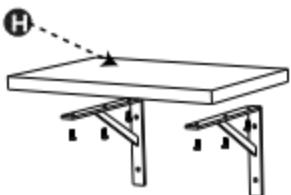
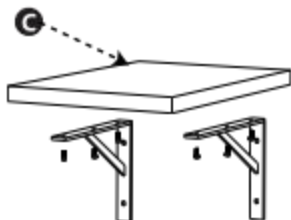

R3X18

Assembly Instructions

STEP 3

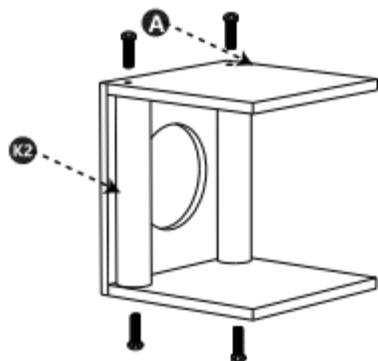

R2X4

STEP 4

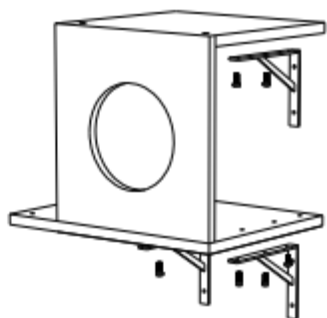

R3X12

STEP 5

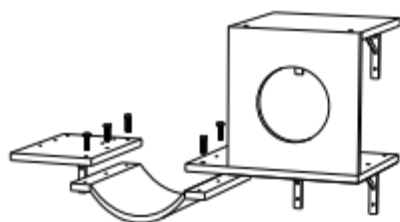

R4X6

STEP 6

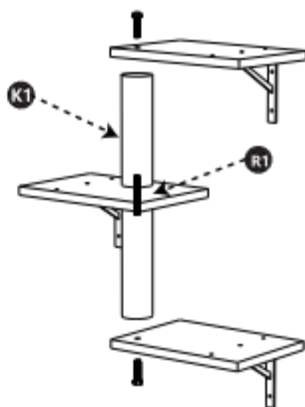

R2X2



R1X1

Assembly Instructions

STEP 7

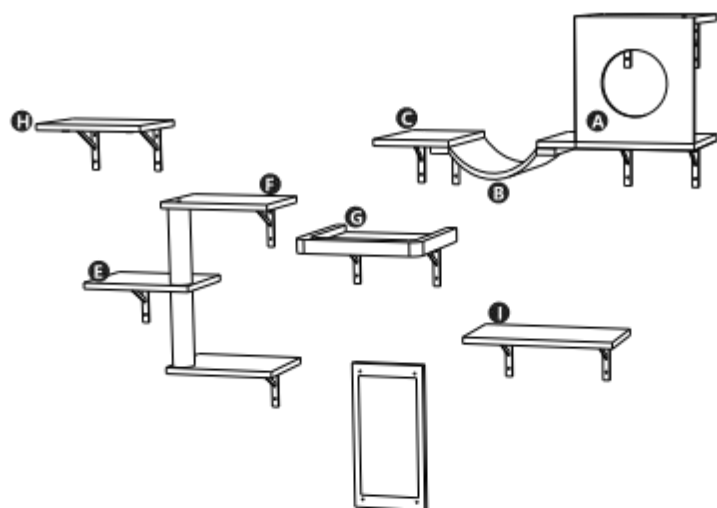

M1x30

All the parts are nailed to the wall

(It is recommended that the installation distance between jumps be about 30cm)

Address: Shuangchenglu 803nong11hao1602A-1609shi, baoshanqu, shanghai 200000 CN.

Imported to AUS: SIHAO PTY LTD, 1 ROKEVA STREETEASTWOOD NSW 2122 Australia

Imported to USA: Sanven Technology Ltd.Suite 250, 9166 Anaheim Place, Rancho Cucamonga, CA 91730

EC

REP

E-CrossStu GmbH.

Mainzer Landstr.69, 60329 Frankfurt am Main.

UK

REP

YH CONSULTING LIMITED.

C/O YH Consulting Limited Office 147, Centurion House,
London Road, Staines-upon-Thames, Surrey, TW18 4AX.

VEVOR[®]

TOUGH TOOLS, HALF PRICE

Assistance technique et Certificat de
garantie électronique Www.vevor.com/support



Technisch ondersteuning en E-garantiecertificaat [Www.vurig.com/ondersteuning](http://www.vurig.com/ondersteuning)

Gemonteerde kattenplank Ins tallatie Instructies

wij blijven doorgaan zijn vastberaden om je gereedschap aanreiken competitief prijs.

"redden Half", "Helft van de prijs" of andere soortgelijke gebruikte uitdrukkingen door ons alleen vertegenwoordigt een

schatting van uw besparing zou baat kunnen hebben bij m bepaalde gereedschappen kopen ons vergeleken met de majoor topmerken en doet niet noodzakelijkerwijs de bedoeling bedek alles categorieën van gereedschap s aangeboden door ons . Jij

Zijn vriendelijk eraan herinnerd om zorgvuldig te verifiëren wanneer u Zijn plaatsen een bestellen bij ons als jij Zijn daadwerkelijk besparen helft binnen Vergelijking met de hoogste major merken.

VEVOR[®]

TOUGH TOOLS, HALF PRICE

Mounted Cat Shelf

Model: SSGQK-03

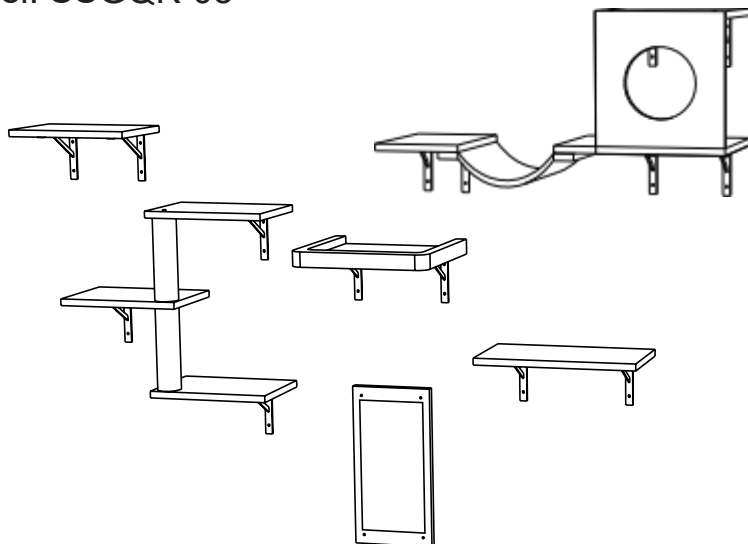

NEED HELP? CONTACT US!

Have product questions? Need technical support? Please feel free to contact us:











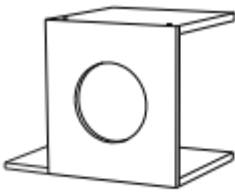

Technical Support and E-Warranty Certificate
www.vevor.com/support

This is the original instruction, please read all manual instructions carefully before operating. VEVOR reserves a clear interpretation of our user manual. The appearance of the product shall be subject to the product you received. Please forgive us that we won't inform you again if there are any technology or software updates on our product.



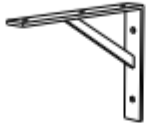

SPECIFICATIONS

Model	SSGQK-03
Kleur	Grijs

COMPONENTS

 <p>Ax1</p>	 <p>Bx1</p>	 <p>Cx1</p>	
 <p>Dx1</p>	 <p>Ex1</p>	 <p>Fx2</p>	
 <p>Gx1</p>	 <p>Hx1</p>	 <p>Ix1</p>	
 <p>Jx15</p>	 <p>K1x2</p>  <p>K2x2</p>	<p>(M8*70) (M8*35)</p>  <p>R1x1</p>  <p>R2x6</p>	
<p>* each set of products is equipped with screwdrivers and wrenches</p>			

COMPONENTS

(M4*10)	(M4*22)	(M4*70)		
				
R3x45	R4x6	M1x30	M2x30	M3x30
* each set of products is equipped with screwdrivers and wrenches				

Assembly Instructions

TIPS:

1. The number of screws marked above is the actual number used during installation. When the product is shipped, 1~3 more screws of each type will be given as spares.
2. During the use of the product, children are prohibited from approaching without the company of adults.
3. The edge of the product is a bit sharp, and you need to wear gloves for installation; at the same time, it comes with sandpaper, so you can polish the edge again by yourself; without gloves, be careful when touching the running wheel.
4. Do not tighten the installation screws at once. Tighten the installation screws twice after all screws are aligned
5. It is recommended that two or more people install the device



6. Please use the following tools to install



Tape measure



Marker pen



screwdriver



Electric drill

Assembly Instructions

Please mark the position on the wall against the plate, reserve about 30cm distance between the jump platforms, drill the hole and bury the expansion tube
(A 6mm drill bit is used for solid walls and a yellow expansion tube is embedded; a 9mm drill bit is used for hollow walls and a butterfly expansion tube is embedded)

Expansion
solenoid



Butterfly
solenoid



M4*70



STEP 1

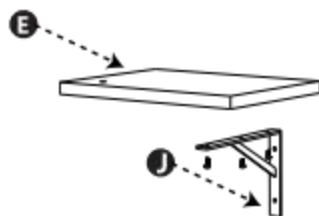
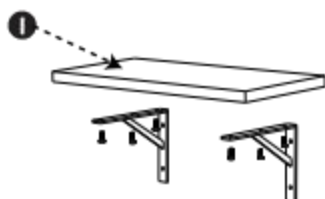

R3X15

STEP 2

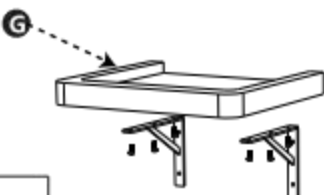
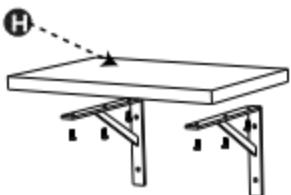
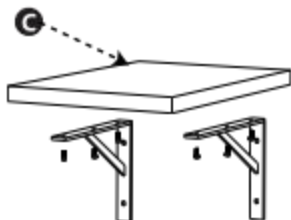

R3X18

Assembly Instructions

STEP 3

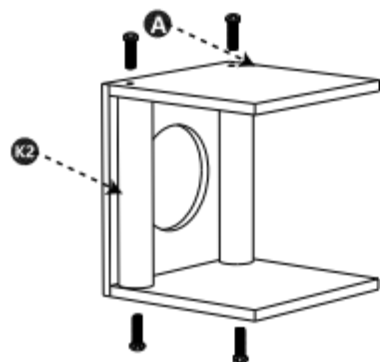

R2X4

STEP 4

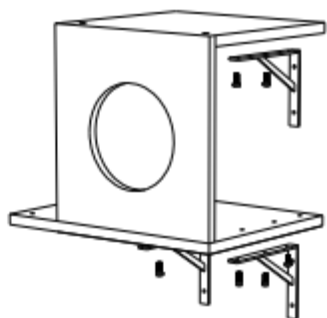

R3X12

STEP 5

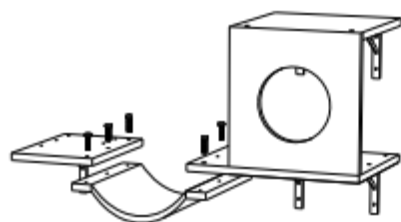

R4X6

STEP 6

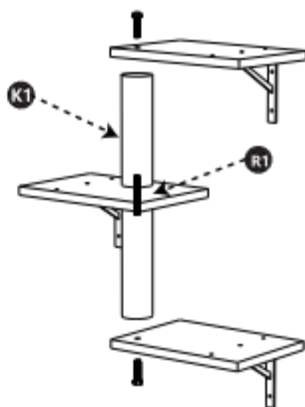

R2X2

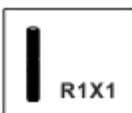

R1X1

Assembly Instructions

STEP 7

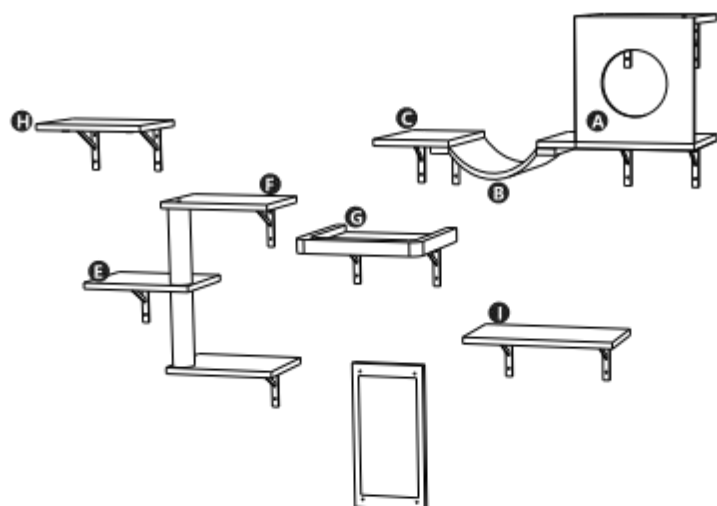

M1x30

All the parts are nailed to the wall

(It is recommended that the installation distance between jumps be about 30cm)

Address: Shuangchenglu 803nong11hao1602A-1609shi, baoshanqu, shanghai 200000 CN.

Imported to AUS: SIHAO PTY LTD, 1 ROKEVA STREETEASTWOOD NSW 2122 Australia

Imported to USA: Sanven Technology Ltd.Suite 250, 9166 Anaheim Place, Rancho Cucamonga, CA 91730

EC

REP

E-CrossStu GmbH.

Mainzer Landstr.69, 60329 Frankfurt am Main.

UK

REP

YH CONSULTING LIMITED.

C/O YH Consulting Limited Office 147, Centurion House,
London Road, Staines-upon-Thames, Surrey, TW18 4AX.

VEVOR[®]

TOUGH TOOLS, HALF PRICE

Technische ondersteuning en E-
garantiecertificaat Www.vevor.com/ondersteuning

VEVOR®

TOUGH TOOLS, HALF PRICE

Teknisk stöd och E-garantibevis [Www.vevor.se/support](http://www.vevor.se/support)

Monterad kathylla Installation Instruktioner

vi fortsätter att vara åtagit sig att förse dig med verktyg tävlande pris. "spara Halv", "Halva priset" eller andra liknande uttryck som används av oss representerar endast en uppskattning av dina besparingar kan dra nytta av m köpa vissa verktyg med oss jämfört med majoren toppmärken och gör inte nödvändigtvis menat täcka alla kategorier av verktyg s erbjuds av oss. Du är vänligen påmind om att kontrollera noggrant när du är placering en beställa med oss om du är faktiskt sparar hälften in jämförelse med högsta majoren märken.

VEVOR®

TOUGH TOOLS, HALF PRICE

Mounted Cat Shelf

Modell: SSGQK-03

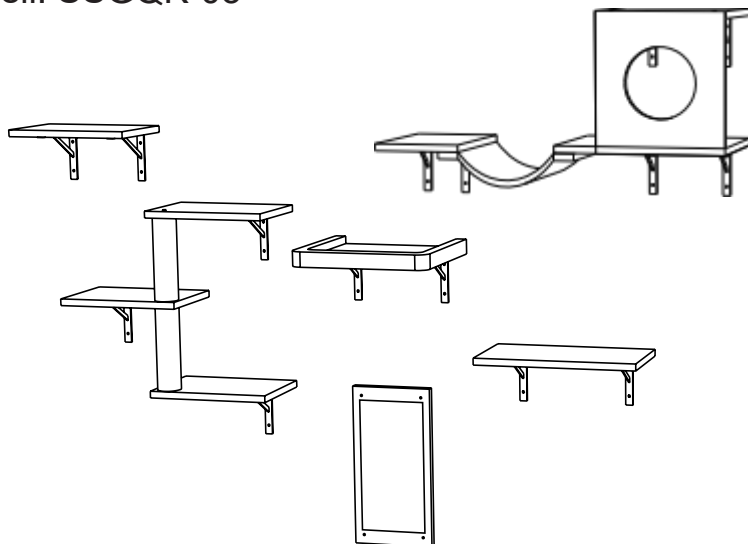

NEED HELP? CONTACT US!

Have product questions? Need technical support? Please feel free to contact us:











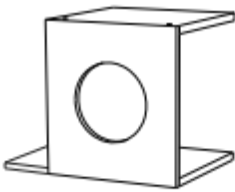

Technical Support and E-Warranty Certificate
www.vevor.com/support

This is the original instruction, please read all manual instructions carefully before operating. VEVOR reserves a clear interpretation of our user manual. The appearance of the product shall be subject to the product you received. Please forgive us that we won't inform you again if there are any technology or software updates on our product.



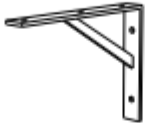

SPECIFICATIONS

Modell	SSGQK-03
Färg	grå

COMPONENTS

 <p>Ax1</p>	 <p>Bx1</p>	 <p>Cx1</p>
 <p>Dx1</p>	 <p>Ex1</p>	 <p>Fx2</p>
 <p>Gx1</p>	 <p>Hx1</p>	 <p>Ix1</p>
 <p>Jx15</p>	 <p>K1x2</p>  <p>K2x2</p>	<p>(M8*70) (M8*35)</p>  <p>R1x1</p>  <p>R2x6</p>
<p>* each set of products is equipped with screwdrivers and wrenches</p>		

COMPONENTS

(M4*10)	(M4*22)	(M4*70)		
				
R3x45	R4x6	M1x30	M2x30	M3x30
* each set of products is equipped with screwdrivers and wrenches				

Assembly Instructions

TIPS:

1. The number of screws marked above is the actual number used during installation. When the product is shipped, 1~3 more screws of each type will be given as spares.
2. During the use of the product, children are prohibited from approaching without the company of adults.
3. The edge of the product is a bit sharp, and you need to wear gloves for installation; at the same time, it comes with sandpaper, so you can polish the edge again by yourself; without gloves, be careful when touching the running wheel.
4. Do not tighten the installation screws at once. Tighten the installation screws twice after all screws are aligned
5. It is recommended that two or more people install the device



6. Please use the following tools to install



Tape measure



Marker pen



screwdriver



Electric drill

Assembly Instructions

Please mark the position on the wall against the plate, reserve about 30cm distance between the jump platforms, drill the hole and bury the expansion tube
(A 6mm drill bit is used for solid walls and a yellow expansion tube is embedded; a 9mm drill bit is used for hollow walls and a butterfly expansion tube is embedded)

Expansion
solenoid



Butterfly
solenoid



M4*70



STEP 1

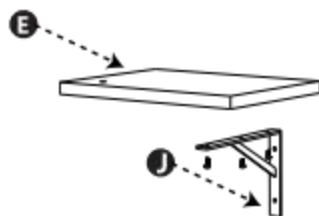
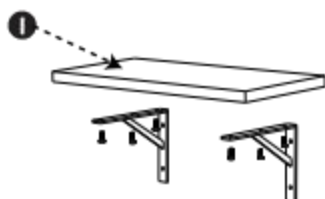

R3X15

STEP 2

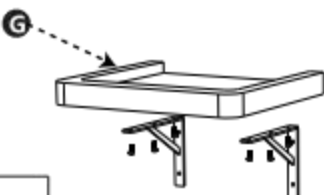
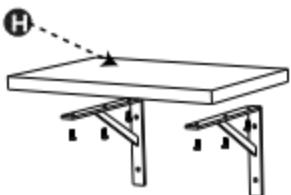
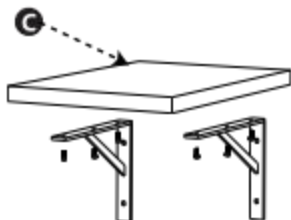

R3X18

Assembly Instructions

STEP 3

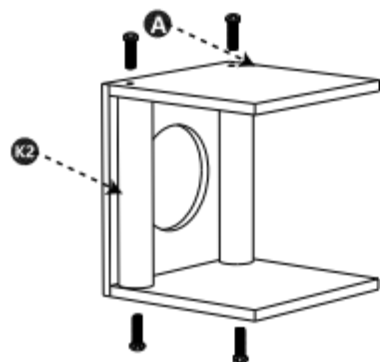

R2X4

STEP 4

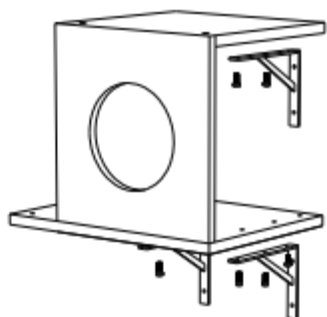

R3X12

STEP 5

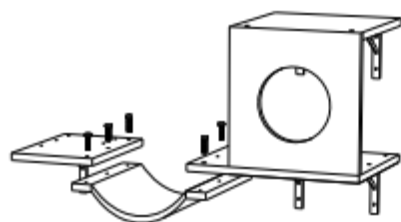

R4X6

STEP 6

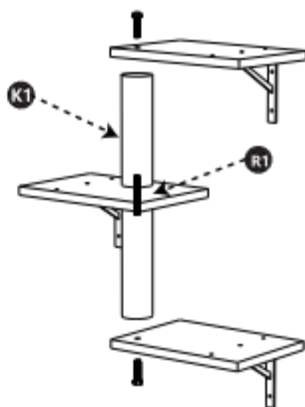

R2X2

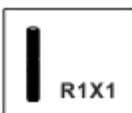

R1X1

Assembly Instructions

STEP 7

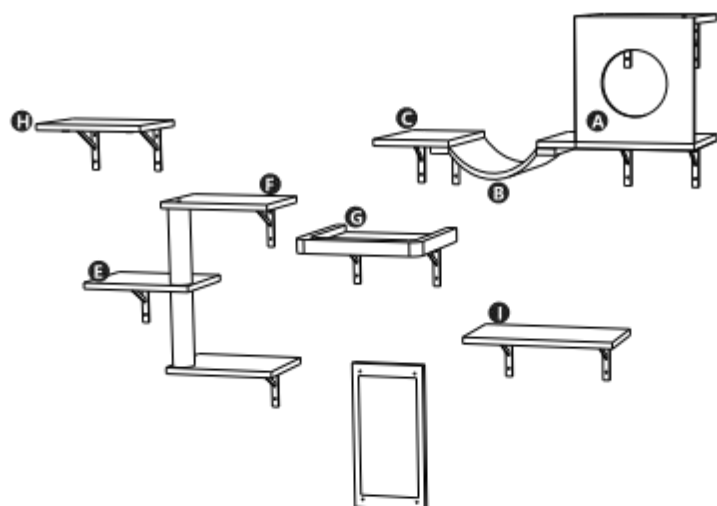

M1x30

All the parts are nailed to the wall

(It is recommended that the installation distance between jumps be about 30cm)

Address: Shuangchenglu 803nong11hao1602A-1609shi, baoshanqu, shanghai 200000 CN.

Imported to AUS: SIHAO PTY LTD, 1 ROKEVA STREETEASTWOOD NSW 2122 Australia

Imported to USA: Sanven Technology Ltd.Suite 250, 9166 Anaheim Place, Rancho Cucamonga, CA 91730

EC

REP

E-CrossStu GmbH.

Mainzer Landstr.69, 60329 Frankfurt am Main.

UK

REP

YH CONSULTING LIMITED.

C/O YH Consulting Limited Office 147, Centurion House,
London Road, Staines-upon-Thames, Surrey, TW18 4AX.

VEVOR[®]

TOUGH TOOLS, HALF PRICE

Teknisk support och E- garanticertifikat
www.vevor.se/support

VEVOR®

TOUGH TOOLS, HALF PRICE

Técnico apoyo y Certificado de garantía electrónica [Www.vevor.es](http://www.vevor.es)/soporte

Estante para gatos montado Ins talación Instrucciones

continuamos ser comprometido con proporcionarle herramientas competitivo precio.

"ahorrar Medio", "Mitad de precio" o cualquier otra expresión similar utilizada por nosotros solo representa un

estimación de ahorros podría beneficiarse de m comprar ciertas herramientas con nosotros en comparación con los principales primeras marcas y hace no necesariamente significa cubrir todo categorías de herramienta f Ofrecido por nosotros. Tú

son Le recordamos que debe verificar cuidadosamente cuando son colocación un ordenar con a nosotros si usted son realmente ahorrando la mitad en comparación con el mejor mayor marcas.

VEVOR®

TOUGH TOOLS, HALF PRICE

Mounted Cat Shelf

Modelo: SSGQK-03

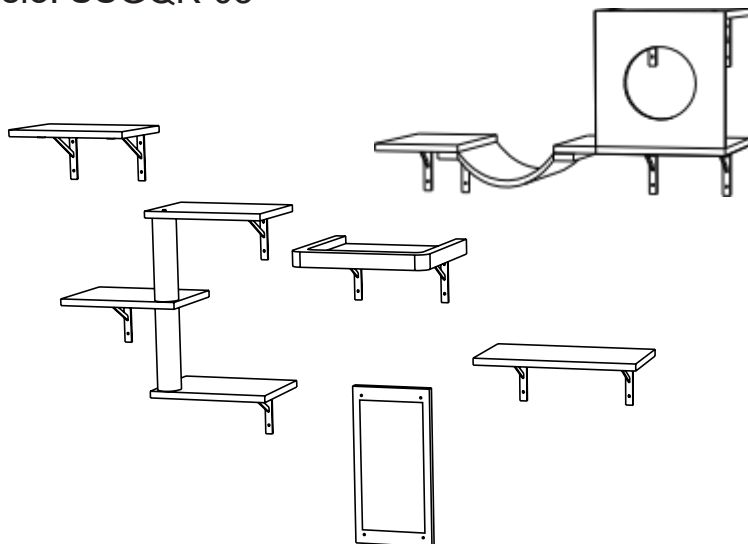

NEED HELP? CONTACT US!

Have product questions? Need technical support? Please feel free to contact us:











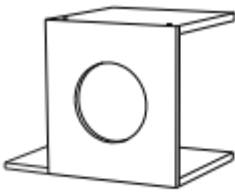

Technical Support and E-Warranty Certificate
www.vevor.com/support

This is the original instruction, please read all manual instructions carefully before operating. VEVOR reserves a clear interpretation of our user manual. The appearance of the product shall be subject to the product you received. Please forgive us that we won't inform you again if there are any technology or software updates on our product.



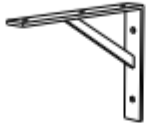

SPECIFICATIONS

Modelo	SSGQK-03
Color	Gris

COMPONENTS

 <p>Ax1</p>	 <p>Bx1</p>	 <p>Cx1</p>
 <p>Dx1</p>	 <p>Ex1</p>	 <p>Fx2</p>
 <p>Gx1</p>	 <p>Hx1</p>	 <p>Ix1</p>
 <p>Jx15</p>	 <p>K1x2</p>  <p>K2x2</p>	<p>(M8*70) (M8*35)</p>  <p>R1x1</p>  <p>R2x6</p>
<p>* each set of products is equipped with screwdrivers and wrenches</p>		

COMPONENTS

(M4*10)	(M4*22)	(M4*70)		
				
R3x45	R4x6	M1x30	M2x30	M3x30
* each set of products is equipped with screwdrivers and wrenches				

Assembly Instructions

TIPS:

1. The number of screws marked above is the actual number used during installation. When the product is shipped, 1~3 more screws of each type will be given as spares.
2. During the use of the product, children are prohibited from approaching without the company of adults.
3. The edge of the product is a bit sharp, and you need to wear gloves for installation; at the same time, it comes with sandpaper, so you can polish the edge again by yourself; without gloves, be careful when touching the running wheel.
4. Do not tighten the installation screws at once. Tighten the installation screws twice after all screws are aligned
5. It is recommended that two or more people install the device



6. Please use the following tools to install



Tape measure



Marker pen



screwdriver



Electric drill

Assembly Instructions

Please mark the position on the wall against the plate, reserve about 30cm distance between the jump platforms, drill the hole and bury the expansion tube
(A 6mm drill bit is used for solid walls and a yellow expansion tube is embedded; a 9mm drill bit is used for hollow walls and a butterfly expansion tube is embedded)

Expansion
solenoid



Butterfly
solenoid



M4*70



STEP 1

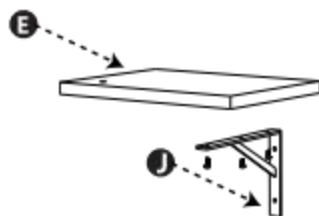
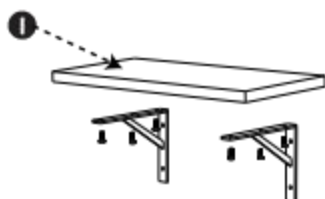

R3X15

STEP 2

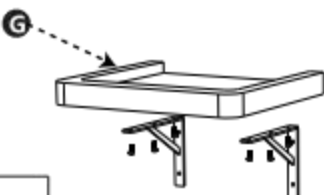
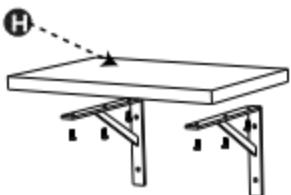
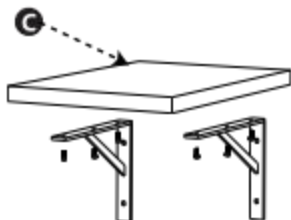

R3X18

Assembly Instructions

STEP 3

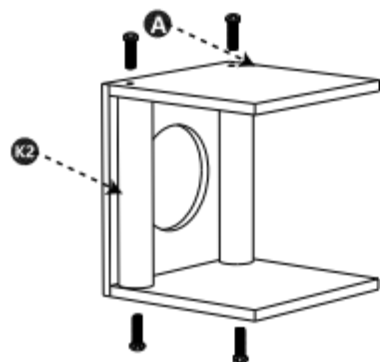

STEP 4

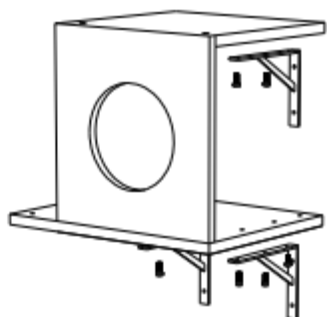

STEP 5

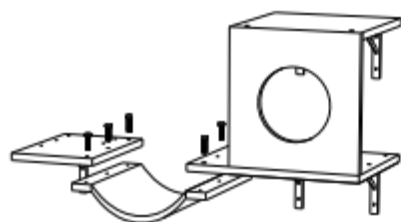

STEP 6

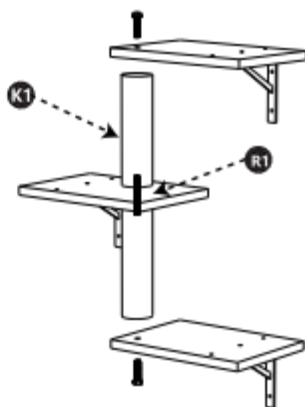

Assembly Instructions

STEP 7

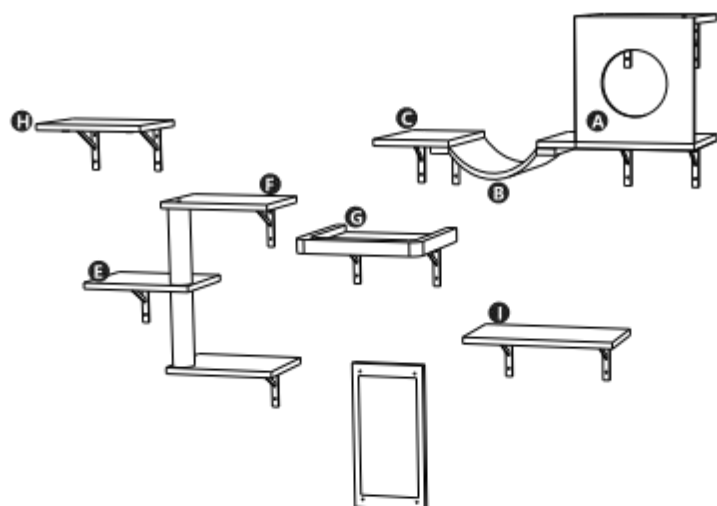

All the parts are nailed to the wall
(It is recommended that the installation distance between jumps be about 30cm)

Address: Shuangchenglu 803nong11hao1602A-1609shi, baoshanqu, shanghai 200000 CN.

Imported to AUS: SIHAO PTY LTD, 1 ROKEVA STREETEASTWOOD NSW 2122 Australia

Imported to USA: Sanven Technology Ltd.Suite 250, 9166 Anaheim Place, Rancho Cucamonga, CA 91730

EC

REP

E-CrossStu GmbH.

Mainzer Landstr.69, 60329 Frankfurt am Main.

UK

REP

YH CONSULTING LIMITED.

C/O YH Consulting Limited Office 147, Centurion House,
London Road, Staines-upon-Thames, Surrey, TW18 4AX.

VEVOR[®]

TOUGH TOOLS, HALF PRICE

Soporte técnico y Certificado de garantía
electrónica [Www.vevor.es/soporte](http://www.vevor.es/soporte)