

VEVOR[®]

TOUGH TOOLS, HALF PRICE

Technical Support and E-Warranty Certificate

www.vevor.com/support

INDUSTRIAL CRANE SCALE

MODEL: OCS-3-D / OCS-5-D

We continue to be committed to provide you tools with competitive price. "Save Half", "Half Price" or any other similar expressions used by us only represents an estimate of savings you might benefit from buying certain tools with us compared to the major top brands and does not necessarily mean to cover all categories of tools offered by us. You are kindly reminded to verify carefully when you are placing an order with us if you are actually saving half in comparison with the top major brands.

VEVOR®

TOUGH TOOLS, HALF PRICE

INDUSTRIAL CRANE SCALE

MODEL: OCS-3-D / OCS-5-D



NEED HELP? CONTACT US!

Have product questions? Need technical support? Please feel free to contact us:

Technical Support and E-Warranty Certificate
www.vevor.com/support

This is the original instruction, please read all manual instructions carefully before operating. VEVOR reserves a clear interpretation of our user manual. The appearance of the product shall be subject to the product you received. Please forgive us that we won't inform you again if there are any technology or software updates on our product.

GENERAL SAFETY RULES

Symbol	Symbol Description
	Warning - To reduce the risk of injury, the user must read the instructions manual carefully.
	This symbol, placed before a safety comment, indicates a kind of precaution, warning, or danger. Ignoring this warning may lead to an accident. To reduce the risk of injury, fire, or electrocution, please always follow the recommendations shown below.
	Warning- Be sure to wear gloves when using this product.
	Warning- Be sure to wear eye protectors when using this product.
	<p>Disposal information:</p> <p>This product is subject to the provision of European Directive 2012/19/EC. The symbol showing a wheeled bin crossed through indicates that the product requires separate refuse collection in the European Union. This applies to the product and all accessories marked with this symbol. Products marked as such may not be discarded with normal domestic waste but must be taken to a collection point for recycling electrical and electronic devices.</p>



General safety instructions

WARNING! Read all safety warnings and notes. Failure to follow the instructions listed below may result in electrical shock, fire, and/or injury.

For good performance and precise measurement, be careful with daily operation and maintenance.

WORK AREA SAFETY

a) **Keep the application area clean and well-lit.** Unclean and dark areas lead to accidents.

b) **Do not use power tools in explosive environments, such as in the presence of flammable liquids, gases, or vapors.** Power tools generate sparks that can ignite dust or vapors.

c) **Keep children and bystanders away when operating the appliance.**

Distractions can lead to loss of control over the device.

Usage Note:

Do not overload crane scale, this will damage loadcell;

Do not leave load hung on the digital balance for long. This will decrease scale accuracy and shorten loadcell life;

Inspect shackle and hook before using. Check clips, pins and screws regularly;

Thank you for your support to our products!



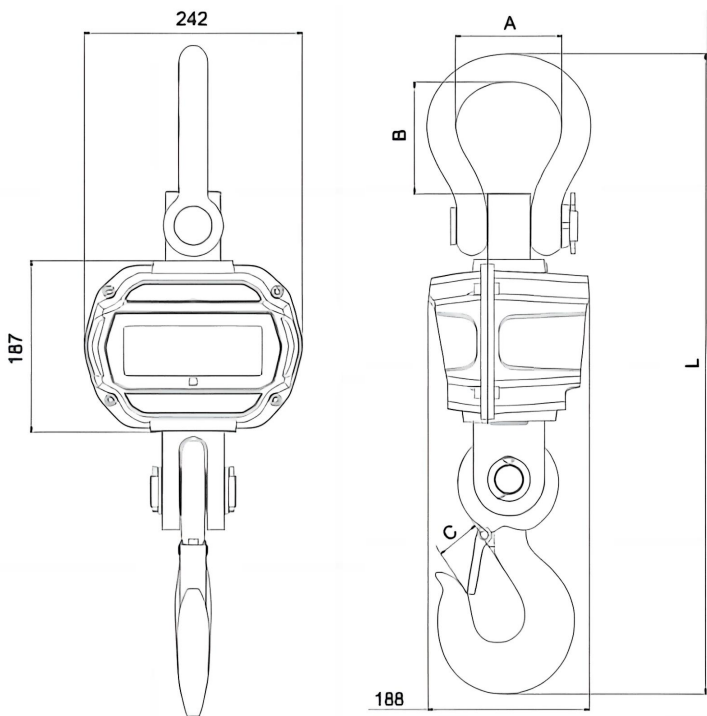

1. Dimension & Weight















Model	A (mm)	B (mm)	C (mm)	L (mm)
OCS-3-D	55	96	35	575
OCS-5-D	78	123	48	675

2. Display & Keys

● Scale Keys

Key	Name	Function
	On/Off	Press 1s to power on/off scale.
	Zero	Manual Zero. Increase flashing digit.
	Tare	Tare in/out. Right scroll flashing digit.
	Hold	Lock/unlock reading. Confirm.

● Remote Keys

Key	Name	Function
	Zero	Same as  .
	Tare	Same as  .
	Hold	Same as  .
	Acc.	Accumulate weight. Decrease flashing digit.
	Del.	Delete the last weight. Clear all weight. Left scroll flashing digit.
	F1	View. Input decimal point.
	F2	Unit switch.
	Off	Press 1s to power off.
	2nd	2nd function.

● Indicators

LED	Name	Note
	Charging	lit when charging
STB.	Stable	lit when weight is stable
ZERO	Zero	lit when weight is at zero
TARE	Tared	lit when the scale is tared
HOLD	Hold	lit when the scale is locked
lb	lb	lit when the unit is lb

kg	kg	lit when the unit is kg
UN	USER	lit when the unit is a user unit

● Message



Message	Stand for	Note
—		detect weight
-		in Idle Mode
Setup	SETUP	User Setup Menu
Bat--	BATtery	battery life percentage
P0000	Password	in Password Mode
end	END	save and exit
off	OFF	power off
over	OVERload	overloading
2nd	2ND	2nd function
err	ERRor	invalid operation
acc	ACCumulate	accumulate weight
del	DELeTe	delete last weight
Clr	CLeaR	delete all weight

3. Operations

● Power On/Off

- Press  for 1s to power on the scale. Scale performs initialization and power-on test, ***** shows twice, then capacity |5000 shows, battery life percentage bat90 shows, weight detection — shows, and then auto zero.

 For information about Auto-Zero, refer to Scale Configuration in the Technical Manual.

- Press  or  for 1s to power off the scale. Battery life percentage bat90 shows, off message |off| shows, and then cuts off power.





● Zero

- Press  or  to zero. ZERO light on.





 If the load is in motion, tared, or out of Manual-Zero Range, |err| shows.

 For information about Manual-Zero Range, refer to Scale Configuration in the Technical Manual.

● Tare In/Out

- ✓ In gross mode, press  or  to tare in. TARE light on.
- ❗ If the load is in motion, negative, or out of Tare Range, |err| shows.
- 📄 Tare will reduce the apparent overload range of scale. For example, if a 5000*2kg scale has a 1000kg container as its tare, the scale will overload at a new weight of 4018kg (5000 – 1000 + additional 9 divisions).
- ✓ In net mode, press  or  to tare out. TARE the light off.





● Lock/unlock

- ✓ Press  or  to lock screen. HOLD the light on.
- ✓ Press  or  to unlock screen. HOLD the light off.

● Accumulate

- ✓ Press  to accumulate current weight.
- 📄 |acc| shows, indicating weight is accumulated. Scale uses displayed weight, so gross or net weight is added into the same accumulator.
- ❗ If the load is in motion, negative, or does not return to zero before, |err| shows.

● View

- ✓ Press  to enter View mode.
- 📄 Display flashes accumulated weight.
- ✓ Press  or  to view high 5-digit or low 5-digit.
- ✓ Press  or  to exit View mode.



● Delete Last Weight

- ✓ Press  to delete the last accumulated weight.
- 📄 |del| shows, indicating that the last accumulated weight is deleted. The delete function only deletes the last weight.
- ❗ If the last accumulated weight has been deleted, |err| shows.

● Clear All Weight

- ✓ Press  first and then press  to clear all accumulated weight.
- 📄 |clr| shows, indicating all weight is cleared.







● Unit Switch

- ✓ Press  to switch the unit in between kg, lb, and User Unit.
-  When the unit is kg, the kg LED light is on. When the unit is lb, the lb LED light is on. When the unit is User unit, the UN LED light is on.
-  For more information about the User Unit, refer to Scale Configuration in the Technical Manual.







4. User Setup

- ✓ Press  first and then press  or  to enter User Setup menu. **setup** shows.









● Auto-Off Timing

- ✓ Press  or  to enter Auto-Off Timing. **Off--** shows.
- ✓ Press  or  and  to change timing value.
-  Auto-Off Timing can be set to: 0(disabled), 5(5min), 10(10min), 15(15min), 30(30min), 60(60min). It is disabled by default.
-  Auto-Off function maximizes the scale's battery life against people's carelessness not to power off the scale when it's not working. Auto-Off starts the countdown timer when there's no action, or the load is stable. Any key pressing or motion in the load restarts the countdown timer.

● Display Brightness

- ✓ Press  or  to enter Display Brightness. **Br--** shows.
- ✓ Press  or  and  to change brightness value.
-  Dim LED brightness saves battery power dramatically.

● Idle Mode Timing

- ✓ Press  or  to enter Idle Mode Timing. **Idl--** shows.
- ✓ Press  or  and  to change the timing value.
-  Idle Mode Timing can be set to: 0(disabled), 5(5sec), 10(10sec), 15(15sec), 30(30sec), 60(60sec). It is 30sec by default.
-  To maximize battery life, the scale automatically enters Idle Mode when there's no action, or the load is stable. In Idle Mode, the scale works in low-power consumption status. Any key pressing or motion in load wakes up the scale from Idle Mode.
- ✓ Press  or  to exit User Setup.

5. Battery Maintenance

To maximize battery life, please note the following battery maintenance guide.

- ❗ This scale is powered by a 6V4.0Ah rechargeable lead-acid battery.
- ❗ The battery is permanently fixed inside the battery house.
- ❗ Depending on LED brightness and idle mode setting, the battery works from 60 hours to 200 hours.
- ❗ In order to conserve battery life, enable Auto-Off and Idle Mode to dim LED brightness.
- ❗ Charging time for a completely discharged battery is approximately 12 hours.
- ❗ To obtain maximum service life, the battery should be stored between -20°C (-4°F) and +50°C (122°F). Stored batteries should be recharged every three months.
- ❗ During charging, the green LED indicates full power, while red indicates that charging is going on.

6. Troubleshooting

Simple problems can be resolved as the below-listed solution. If problems still exist, please contact your local representative.

Symptom	Possible Cause	Suggested Solution
not power-on after On/Off is pressed	discharged / defective battery	check battery and charge
	defective On/Off key	press harder and keep pressing 2s
	defective power cable	open the front panel, check the power cable
	defective mainboard	contact representative
display flashes	discharged battery	charge battery
no action was taken after the key was pressed	scale is disturbed	re-plug power cable
	defective key	contact representative
weight reading is not stable	load in motion	keep load stable
	weak Anti-Motion	change Anti-Motion level
	damped loadcell or mainboard	dry loadcell or mainboard
	defective mainboard	contact representative
weight reading is not zero when there is no load	discharged battery	charge battery
	load-cell stressed too long	hang scale in storage
	discharged battery	charge battery

large error in weight reading	scale not zeroed before applying the load	manual Zero scale before loading
	wrong unit	switch to the correct unit
	scale requires calibration	calibrate scale
	defective loadcell or mainboard	contact representative
battery can not be recharged	defective charge board	contact representative
	defective battery	contact representative
short remote controlling distance	discharged / defective remote battery	replace remote controller batteries

7. Loading Procedures

DO NOT attach an oversized interface!



DO NOT push/pull on the loaded scale or directly on the hook!

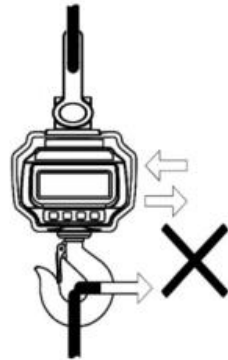

DO NOT use multiple attachments!



Use hardware that creates single-point attachments.



8. Specifications

Accuracy Class	Chinese GB/T 11883-2002 Class III Equivalent to OIML R76
Tare Range	100% F.S.
Zero Range	4% F.S.
Stable Time	≤10sec
Overload	100% F.S. + 9e
Safety Load	150% F.S.
Ultimate Load	400% F.S.
Battery	6V/4.0Ah lead acid rechargeable battery.
Charger	14VDC/1000mA output (European, American standard) 9VDC/1500mA output(Australian Standard)
Display	40mm (1.6inch) LED module
Op. Temp.	-10°C - +40°C
Op. Humidity	20°C ≤90%

	Items	Description
1	Name	Industrial Crane Scale
2	Model	OCS-3-D
3	Parameter	Rating(s): 6VDC Capacity: 3000kg/6600lb Division: 1lb

	Items	Description
1	Name	Industrial Crane Scale
2	Model	OCS-5-D
3	Parameter	Rating(s): 6VDC Capacity: 5000kg/11000lb Division: 2lb

Manufacturer: Shanghaimuxinmuyeyouxiangongsi

Address: Shuangchenglu 803nong11hao1602A-1609shi, baoshanqu, shanghai 200000 CN.

Imported to AUS: SIHAO PTY LTD, 1 ROKEVA STREETEASTWOOD NSW 2122 Australia

Imported to USA: Sanven Technology Ltd., Suite 250, 9166 Anaheim Place, Rancho Cucamonga, CA 91730

EC	REP
-----------	------------

E-CrossStu GmbH
Mainzer Landstr.69, 60329 Frankfurt am Main.

UK	REP
-----------	------------

YH CONSULTING LIMITED.
C/O YH Consulting Limited Office 147, Centurion House,
London Road, Staines-upon-Thames, Surrey, TW18 4AX

VEVOR®

TOUGH TOOLS, HALF PRICE

Technical Support and E-Warranty Certificate

www.vevor.com/support