

VEVOR[®]

TOUGH TOOLS, HALF PRICE

Technical Support and E-Warranty Certificate www.vevor.com/support

RETRACTABLE PERGOLA

USER MANUAL

We continue to be committed to provide you tools with competitive price.

"Save Half", "Half Price" or any other similar expressions used by us only represents an estimate of savings you might benefit from buying certain tools with us compared to the major top brands and does not necessarily mean to cover all categories of tools offered by us. You are kindly reminded to verify carefully when you are placing an order with us if you are actually saving half in comparison with the top major brands.

VEVOR®

TOUGH TOOLS, HALF PRICE

RETRACTABLE PERGOLA

MODEL: JDG-098-34DGR / JDG-098-34DBL / JDG-098-34DBE

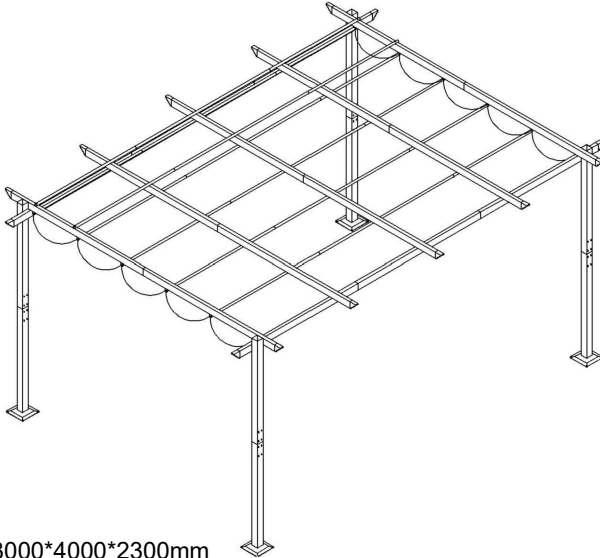

Product Size: 3000*4000*2300mm

NEED HELP? CONTACT US!

Have product questions? Need technical support? Please feel free to contact us:

Technical Support and E-Warranty Certificate
www.vevor.com/support

This is the original instruction, please read all manual instructions carefully before operating. VEVOR reserves a clear interpretation of our user manual. The appearance of the product shall be subject to the product you received. Please forgive us that we won't inform you again if there are any technology or software updates on our product.



Safety precautions

Read this instructions before using this product. Failure to do so can result in serious injury. the basic precautions should always be followed,including the following:

PLEASE NOTE! Drawings in this manual are for illustration purposes only and in some details may differ from the actual product.

Before Assembling

Before assembling, we recommend:

1. Wear Gloves.





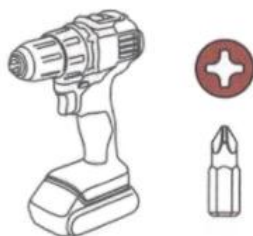





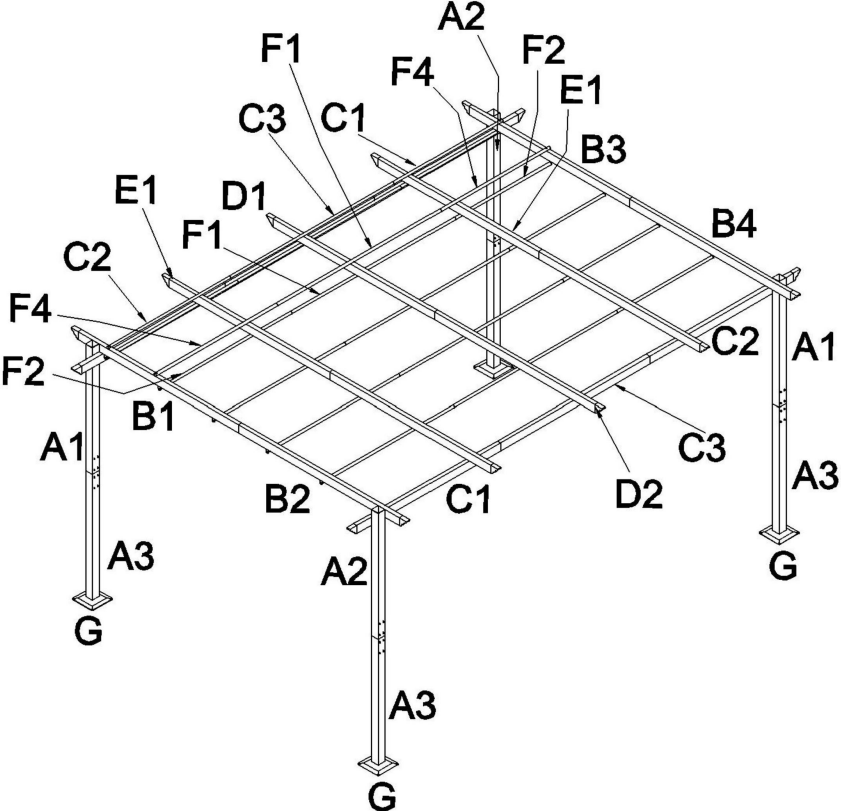

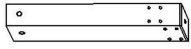
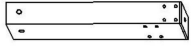

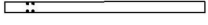
- 2.Recommended Tools, Power Drill With Phillips Bit



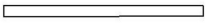
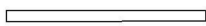

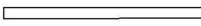

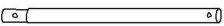
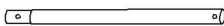

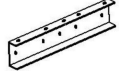















- 3.we recommend 4 people for a smoother assembly

Product List



| Item no. | Reference Image | Qty. | Item no. | Reference Image | Qty. |
|----------|---|------|----------|---|------|
| A1 |  | 2 | A2 |  | 2 |
| A3 |  | 4 | B1 |  | 1 |
| B2 |  | 1 | B3 |  | 1 |
| B4 |  | 1 | C1 |  | 2 |
| C2 |  | 2 | C3 |  | 2 |
| D1 |  | 1 | D2 |  | 1 |
| E1 |  | 4 | F1 |  | 8 |
| F2 |  | 12 | F4 |  | 4 |
| G |  | 4 | H |  | 3 |

| Item no. | Reference Image | Qty. | Item no. | Reference Image | Qty. |
|----------|---|------|----------|---|------|
| I |  | 6 | J |  | 8 |
| K |  | 1 | L |  | 5 |
| M |  | 12 | N |  | 2 |
| O |  | 14 | P |  | 4 |
| Q |  | 1 | R |  | 2 |
| S |  | 1 | T |  | 1 |
| U |  | 16 | V |  | 1 |
| W |  | 4 | | | |
| | | | | | |

| Item no. | Reference Image | Qty. | Item no. | Reference Image | Qty. |
|---|-----------------|------|---|-----------------|------|
|  | M6*10 | 24 |  | M6*15 | 134 |
|  | M6*30 | 4 |  | M6*75 | 6 |
|  | M6*40 | 3 |  | M6*15 | 32 |
|  | M6 | 64 | | | |
| | | | | | |
| | | | | | |
| | | | | | |
| | | | | | |
| | | | | | |
| | | | | | |

Product Description

1

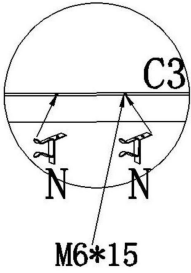
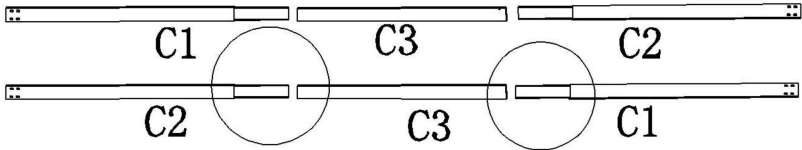
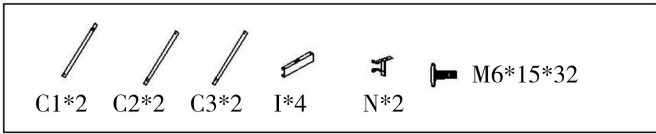

Please do nothing about this middle screw hole

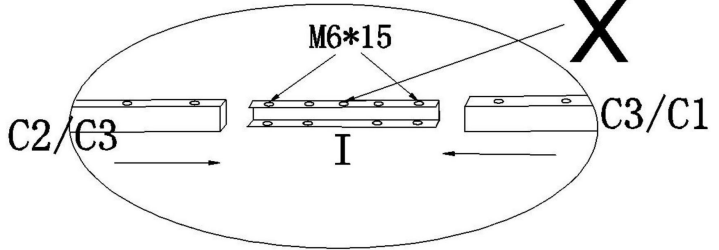

2

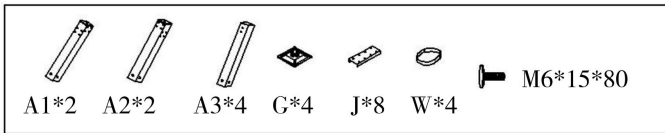

Please fix the W before connect A1 and A3, A2 and A3.

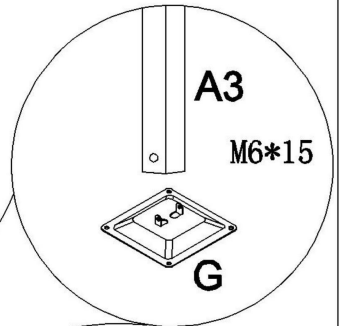
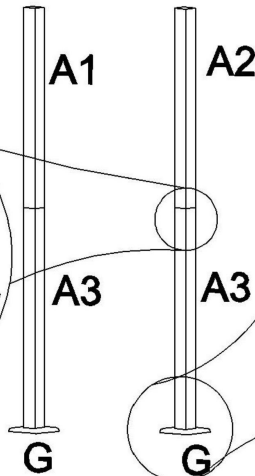
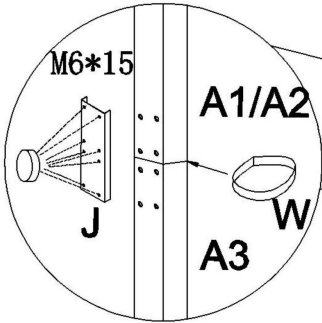

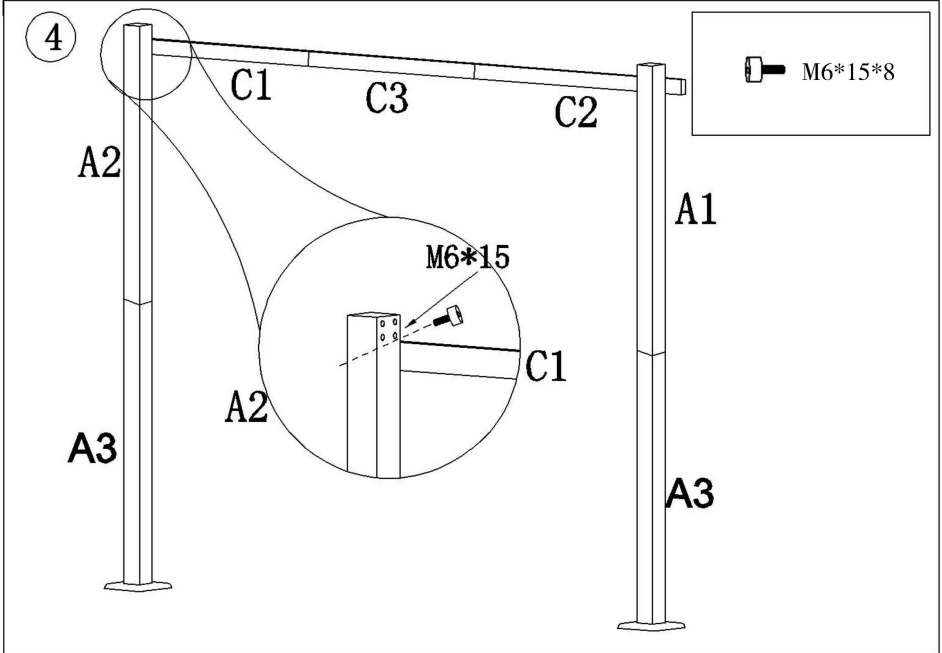
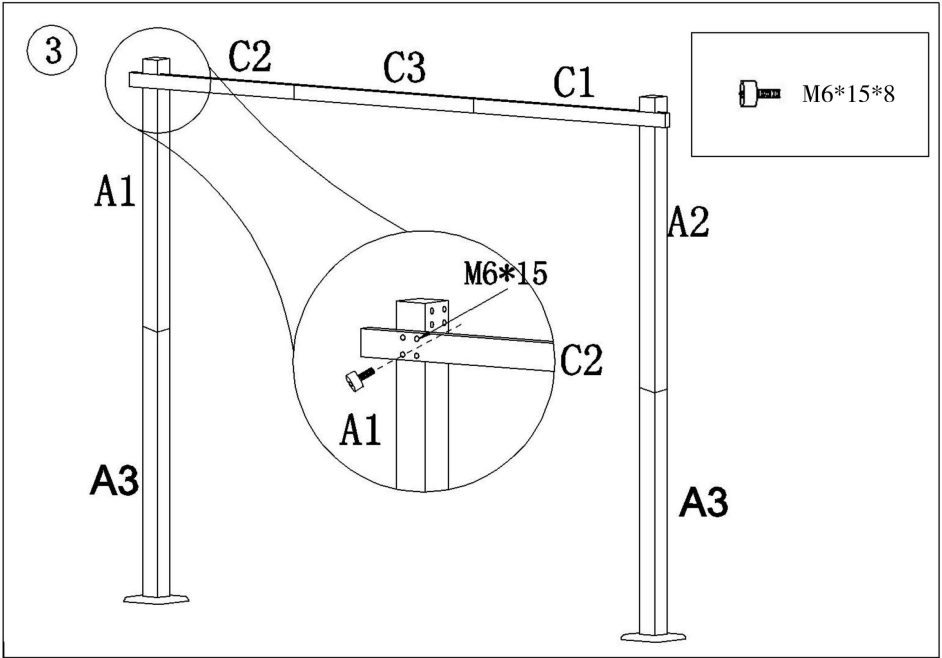

5

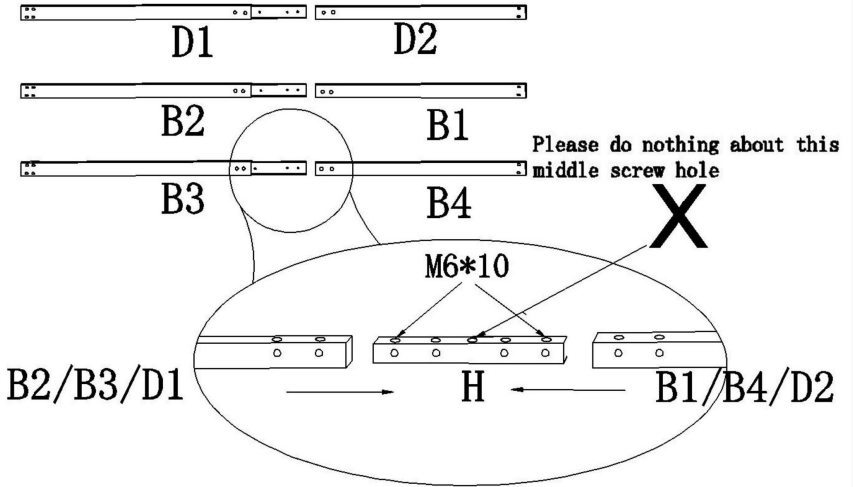
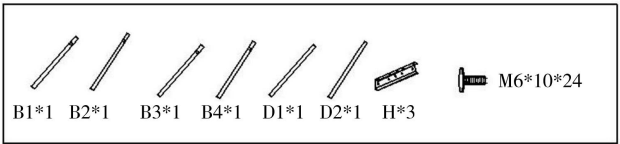

6

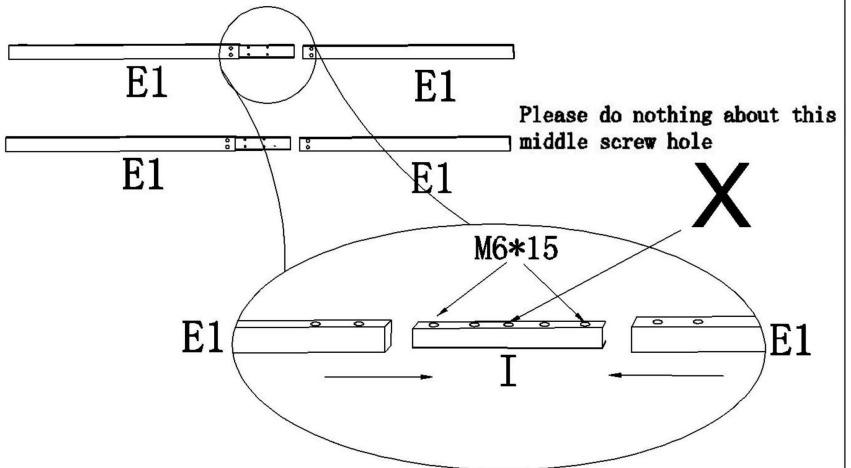
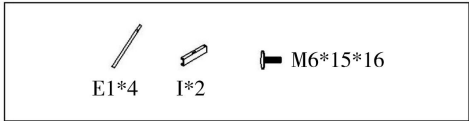

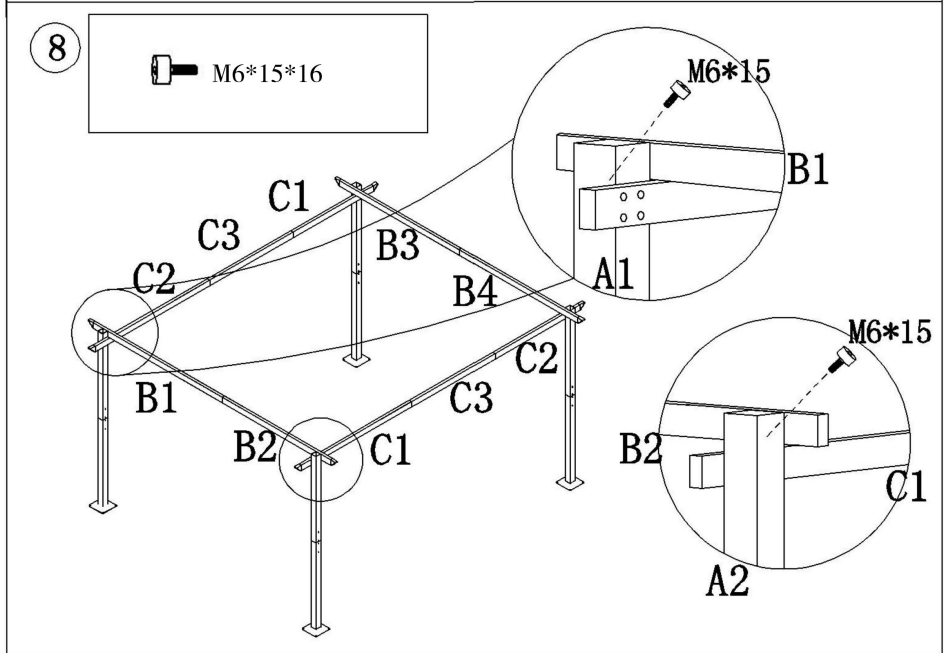
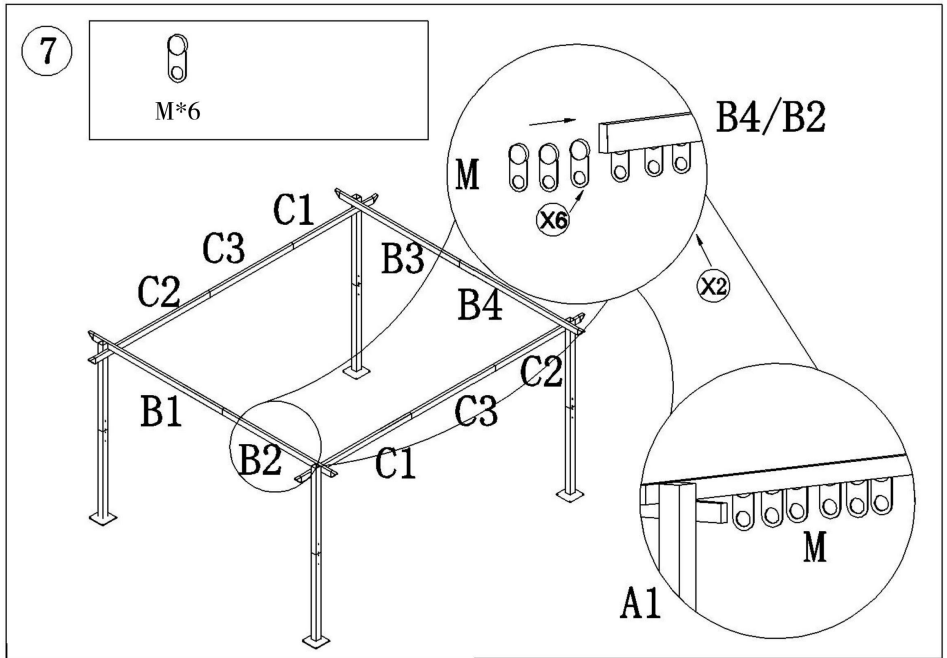

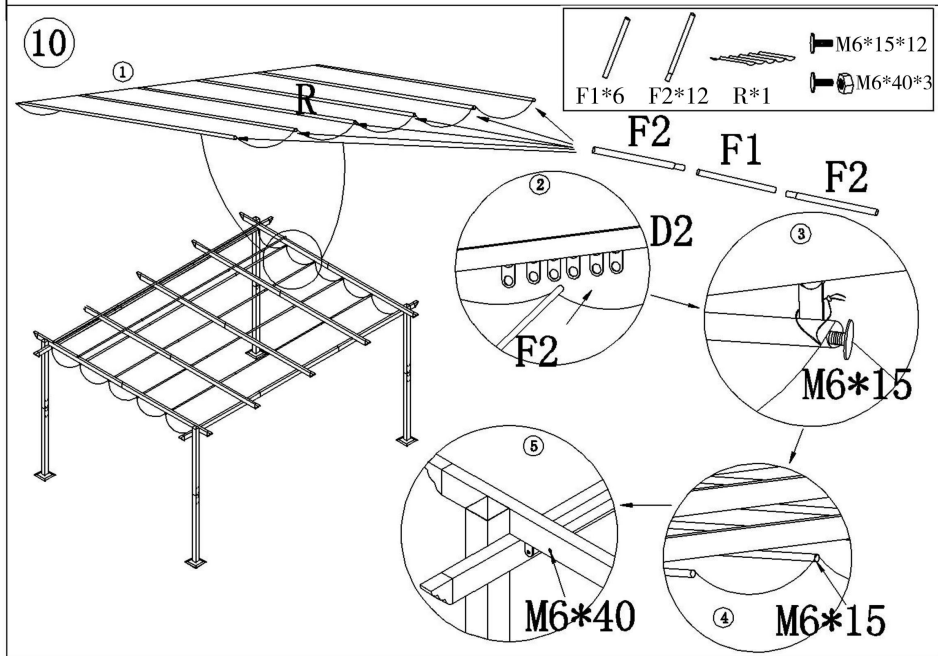
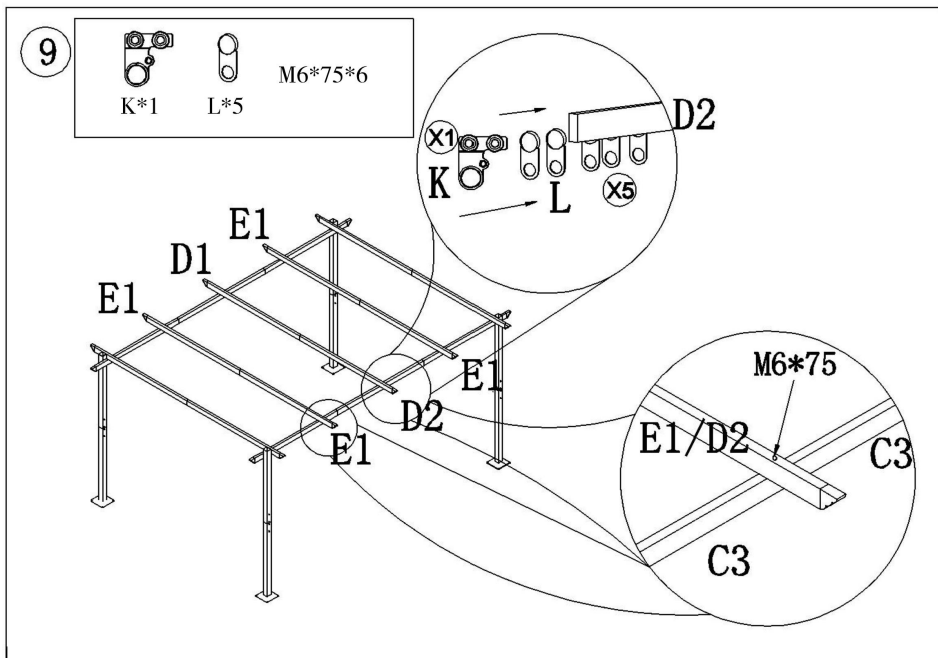

Note: The top cloth has leaking holes (R)

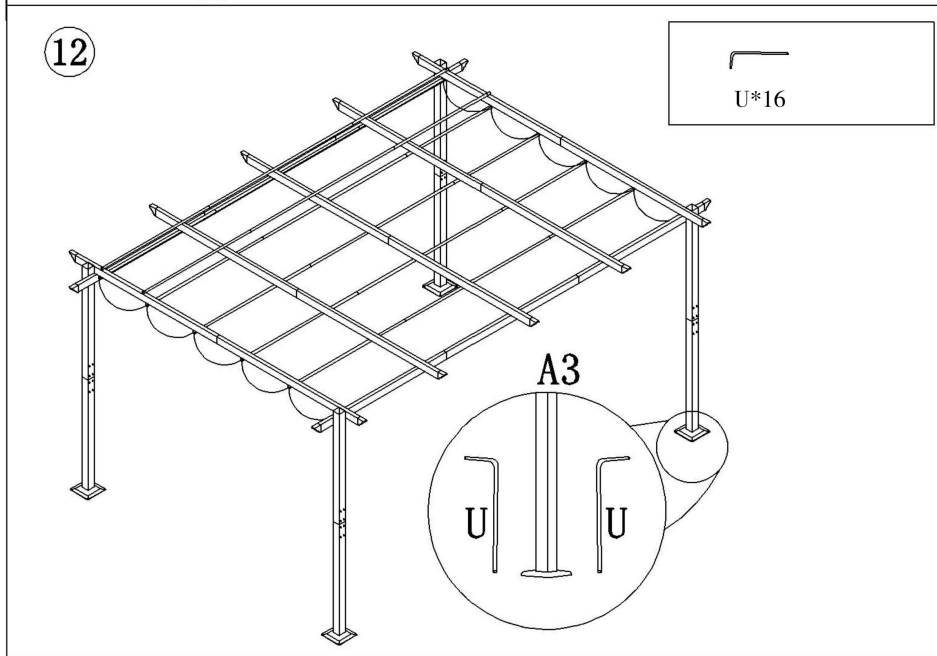
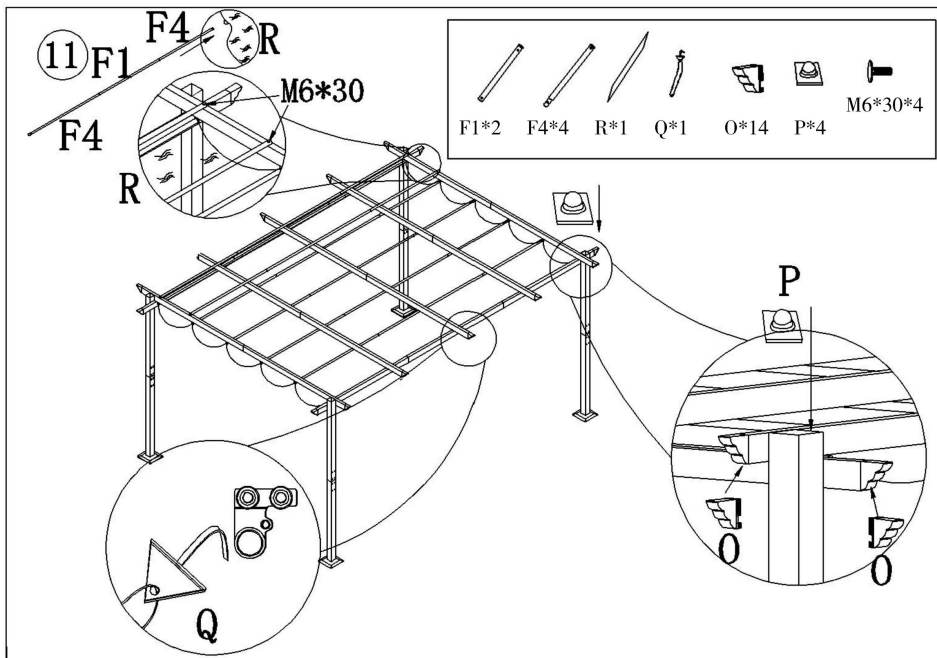

Manufacturer:Shanghaimuxinmuyeyouxiangongsi

Address: Shuangchenglu 803nong11hao1602A-1609shi, baoshanqu, shanghai 200000 CN.

Imported to AUS: SIHAO PTY LTD. 1 ROKEVA STREETEASTWOOD NSW 2122 Australia

Imported to USA: Sanven Technology Ltd. Suite 250, 9166 Anaheim Place, Rancho Cucamonga, CA 91730

| | |
|-----------|------------|
| EC | REP |
|-----------|------------|

E-CrossStu GmbH

Mainzer Landstr.69, 60329 Frankfurt am Main.

| | |
|-----------|------------|
| UK | REP |
|-----------|------------|

YH CONSULTING LIMITED.

C/O YH Consulting Limited Office 147, Centurion House,
London Road, Staines-upon-Thames, Surrey, TW18 4AX

VEVOR[®]

TOUGH TOOLS, HALF PRICE

Technical Support and E-Warranty Certificate

www.vevor.com/support



Technisch Support und E-Garantie-Zertifikat www.vevor.com/support

EINZIEHBARE PERGOLA

BENUTZERHANDBUCH

We continue to be committed to provide you tools with competitive price.

"Save Half", "Half Price" or any other similar expressions used by us only represents an estimate of savings you might benefit from buying certain tools with us compared to the major top brands and does not necessarily mean to cover all categories of tools offered by us. You are kindly reminded to verify carefully when you are placing an order with us if you are actually saving half in comparison with the top major brands.

VEVOR®

TOUGH TOOLS, HALF PRICE

RETRACTABLE PERGOLA

MODELL: JDG-098-34DGR / JDG-098-34DBL / JDG-098-34DBE

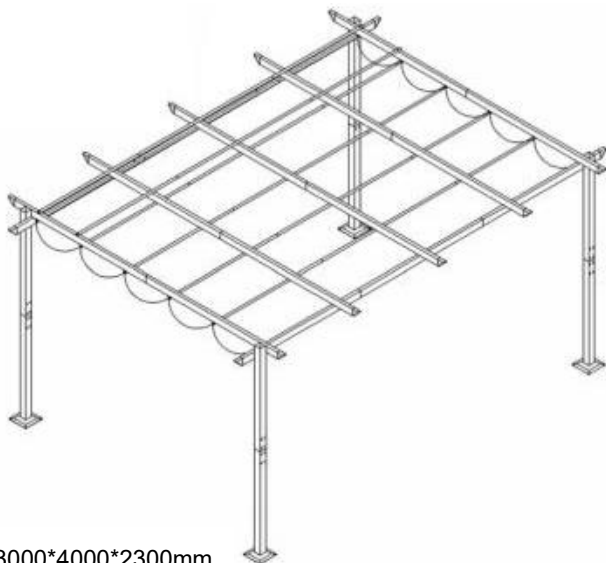

Product Size: 3000*4000*2300mm

NEED HELP? CONTACT US!

Have product questions? Need technical support? Please feel free to contact us:

Technical Support and E-Warranty Certificate
www.vevor.com/support

This is the original instruction, please read all manual instructions carefully before operating. VEVOR reserves a clear interpretation of our user manual. The appearance of the product shall be subject to the product you received. Please forgive us that we won't inform you again if there are any technology or software updates on our product.



Sicherheitsvorkehrungen

Lesen Sie diese Anweisungen, bevor Sie dieses Produkt verwenden. Andernfalls kann es zu schweren Verletzungen kommen. Die grundlegenden Vorsichtsmaßnahmen sollten immer befolgt werden, einschließlich der folgenden: **BITTE BEACHTEN!** Die Zeichnungen in diesem Handbuch dienen lediglich Illustrationszwecken und können in einigen vom tatsächlichen Produkt abweichen.

Vor dem Zusammenbau

Vor der Montage empfehlen wir:

2. Trag Handschuhe.











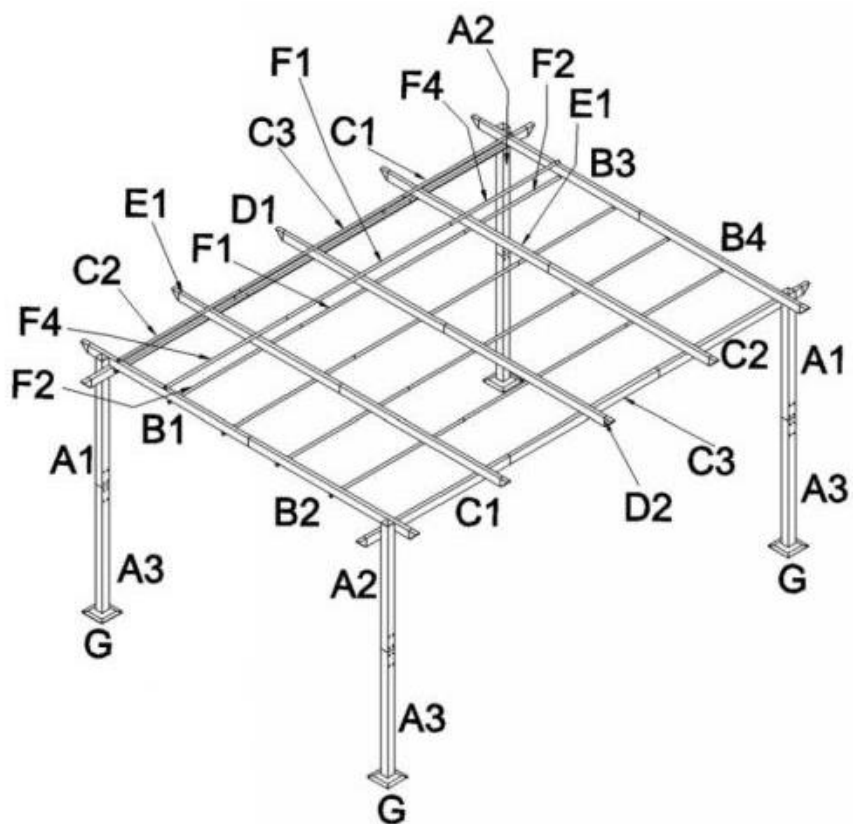

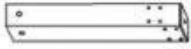
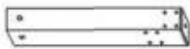





2. Empfohlene Werkzeuge, Bohrmaschine mit Kreuzschlitz-Bit

























3. Wir empfehlen 4 Personen für eine reibungslosere Montage

Produktliste



| Item no. | Reference Image | Qty. | Item no. | Reference Image | Qty. |
|----------|---|------|----------|---|------|
| A1 |  | 2 | A2 |  | 2 |
| A3 |  | 4 | B1 |  | 1 |
| B2 |  | 1 | B3 |  | 1 |
| B4 |  | 1 | C1 |  | 2 |
| C2 |  | 2 | C3 |  | 2 |
| D1 |  | 1 | D2 |  | 1 |
| E1 |  | 4 | F1 |  | 8 |
| F2 |  | 12 | F4 |  | 4 |
| G |  | 4 | H |  | 3 |

| Item no. | Reference Image | Qty. | Item no. | Reference Image | Qty. |
|----------|---|------|----------|---|------|
| I |  | 6 | J |  | 8 |
| K |  | 1 | L |  | 5 |
| M |  | 12 | N |  | 2 |
| O |  | 14 | P |  | 4 |
| Q |  | 1 | R |  | 2 |
| S |  | 1 | T |  | 1 |
| U |  | 16 | V |  | 1 |
| W |  | 4 | | | |
| | | | | | |

| Item no. | Reference Image | Qty. | Item no. | Reference Image | Qty. |
|---|-----------------|------|---|-----------------|------|
|  | M6*10 | 24 |  | M6*15 | 134 |
|  | M6*30 | 4 |  | M6*75 | 6 |
|  | M6*40 | 3 |  | M6*15 | 32 |
|  | M6 | 64 | | | |
| | | | | | |
| | | | | | |
| | | | | | |
| | | | | | |
| | | | | | |
| | | | | | |

Produktbeschreibung

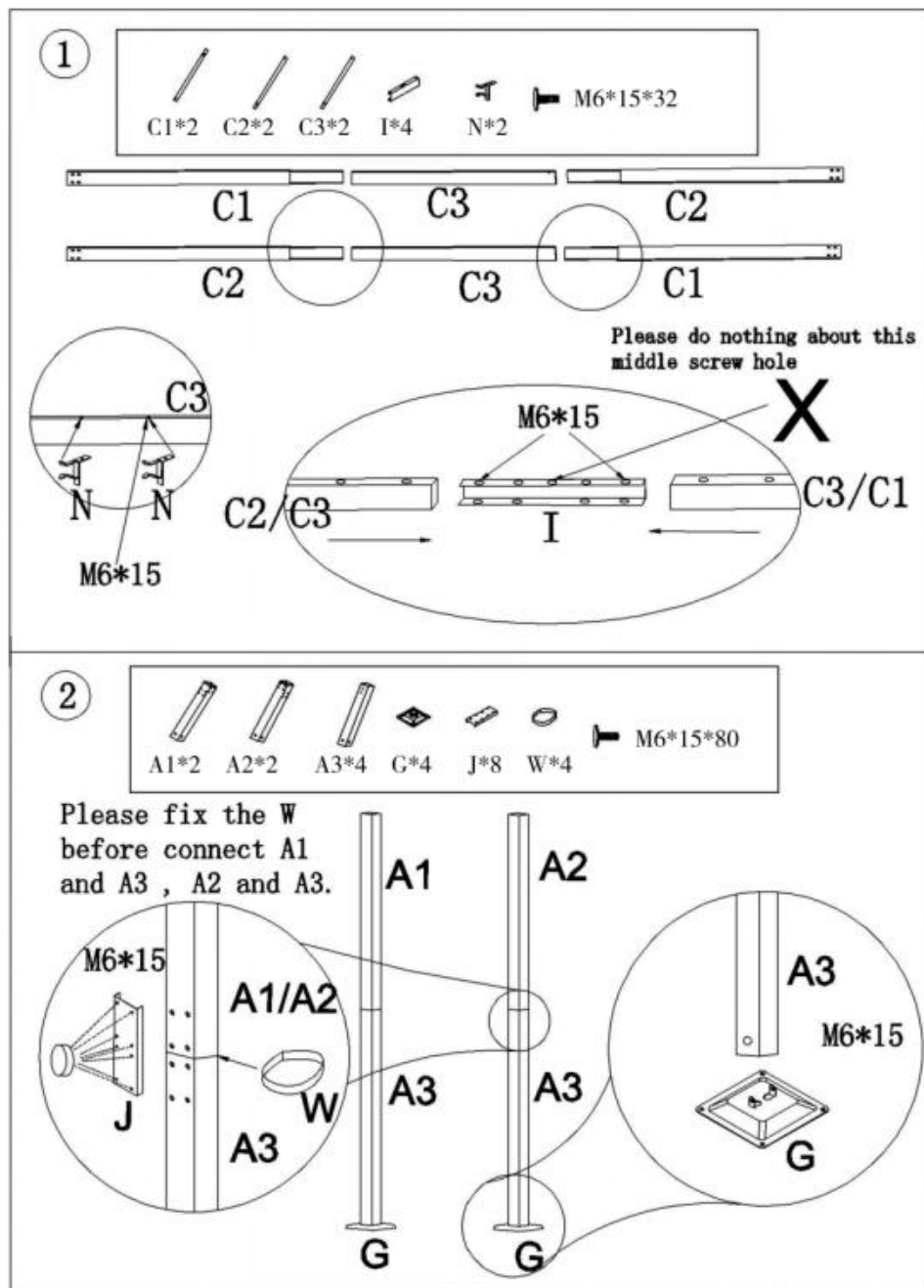

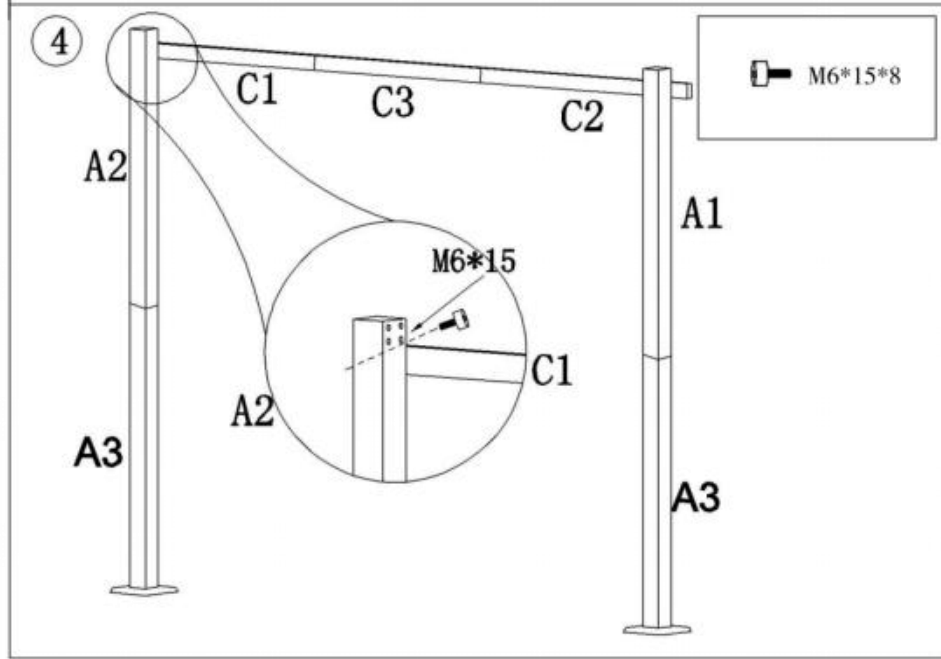
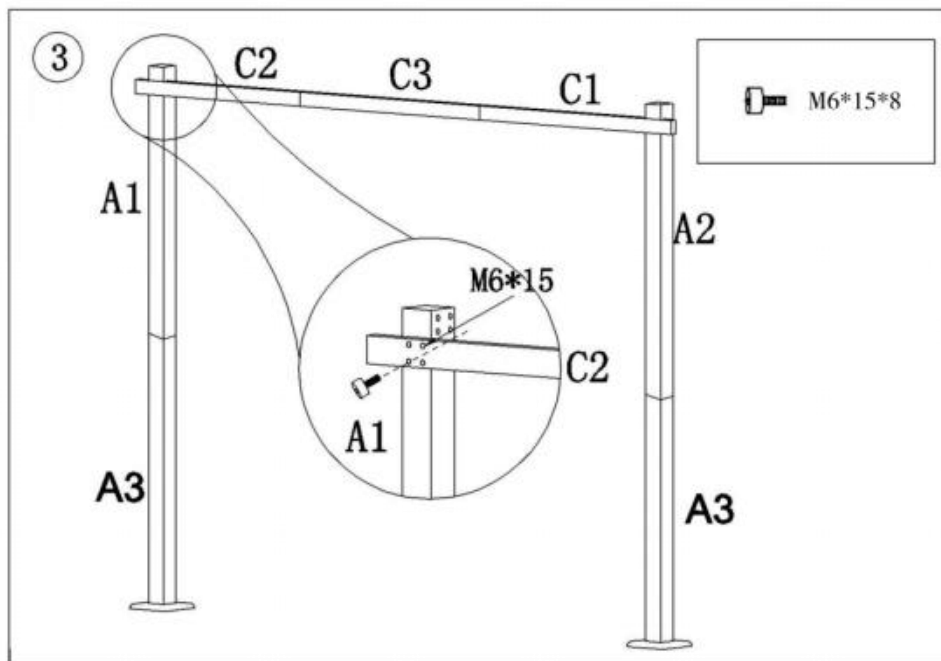

5

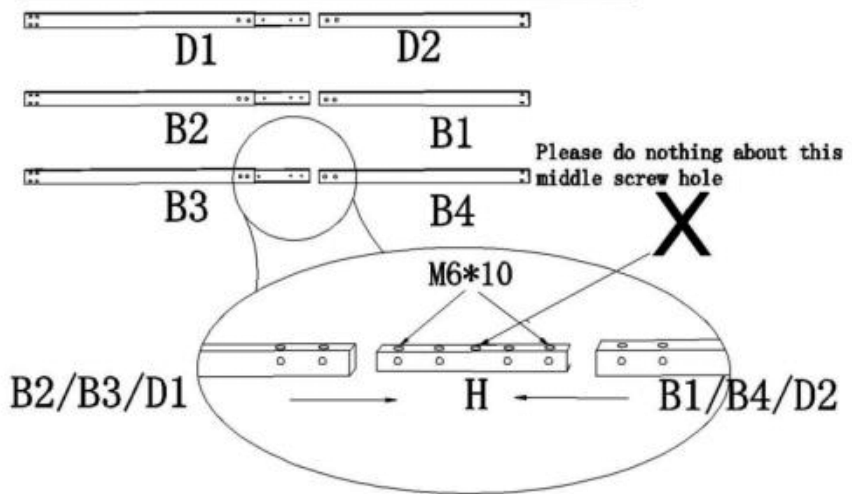
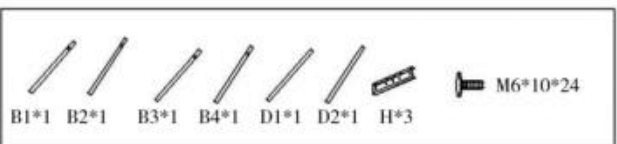

6

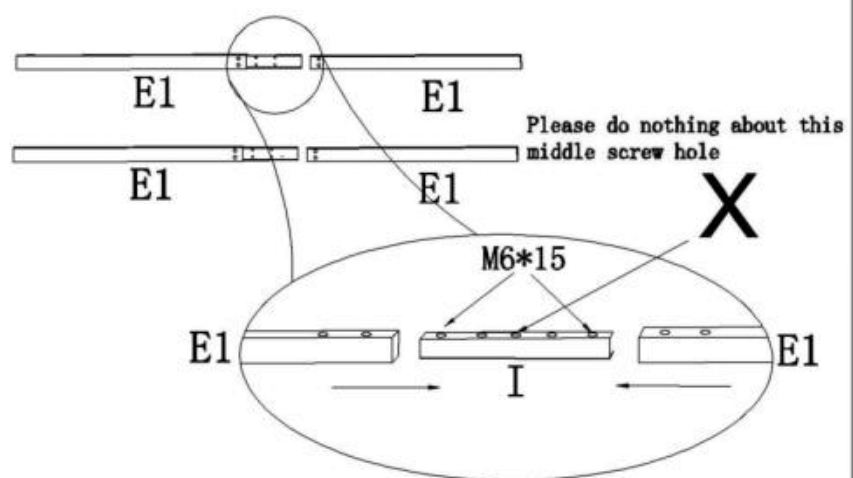
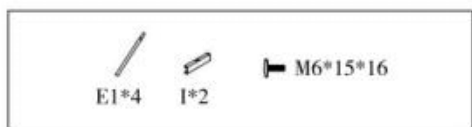

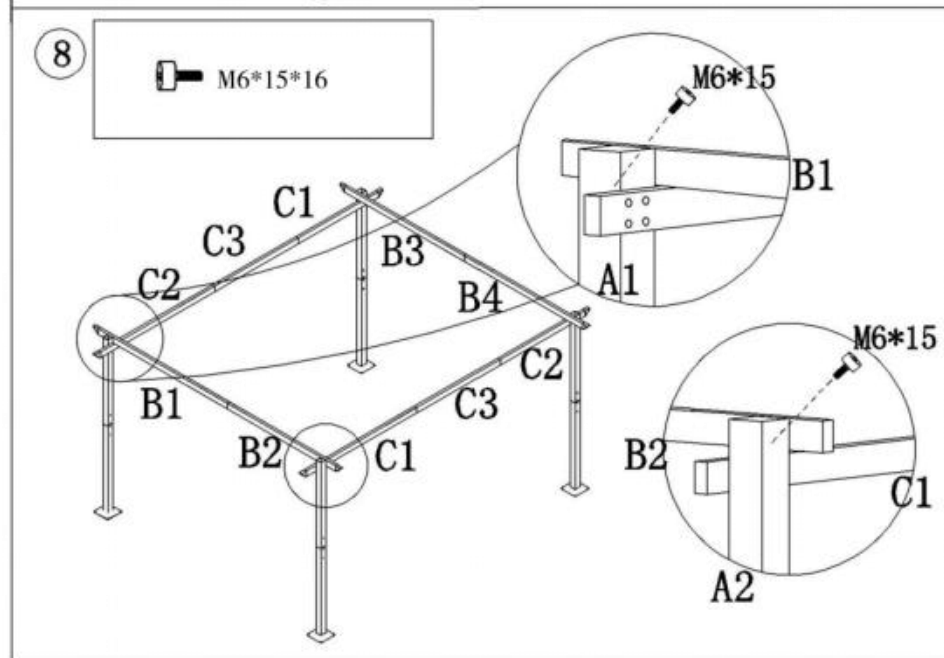
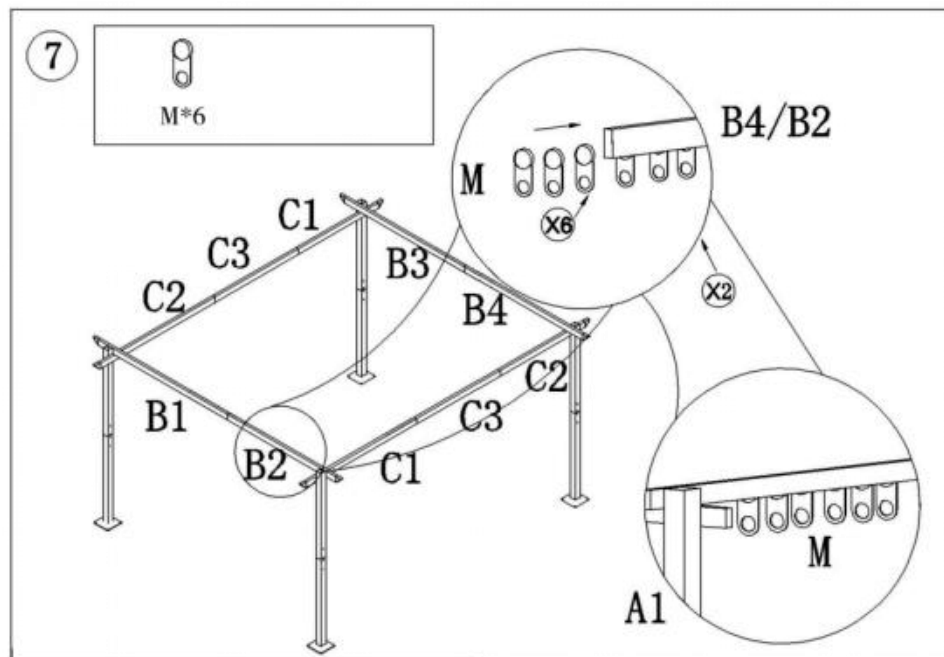

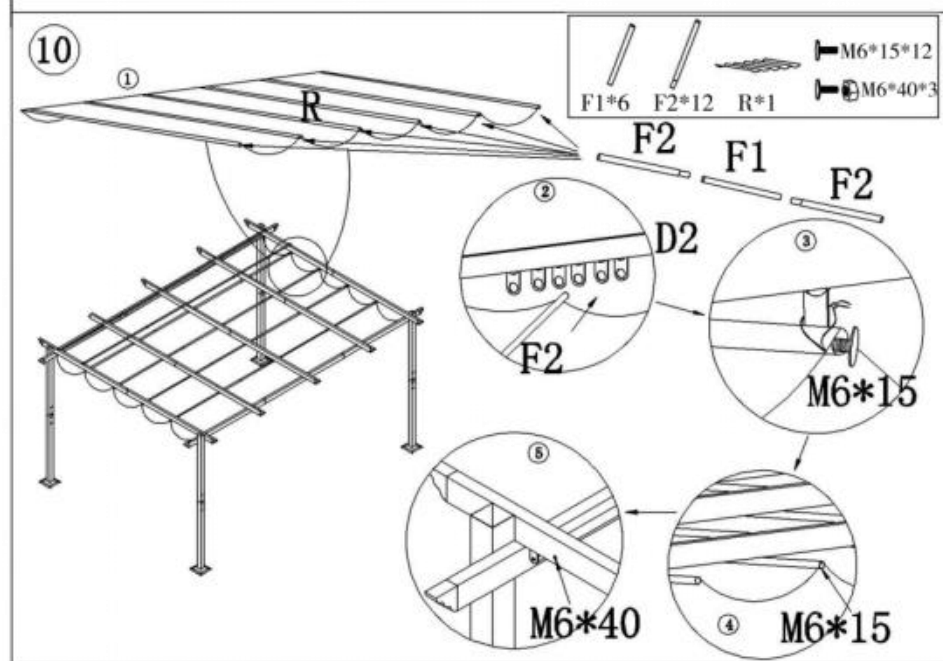
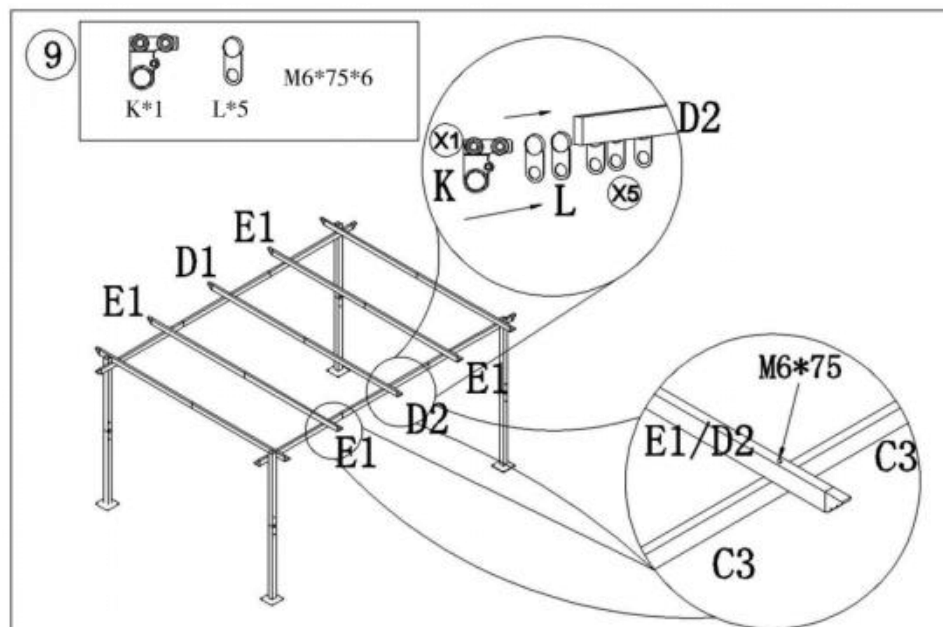

Hinweis: Der Verdeckbezug ist undicht Löcher (R)

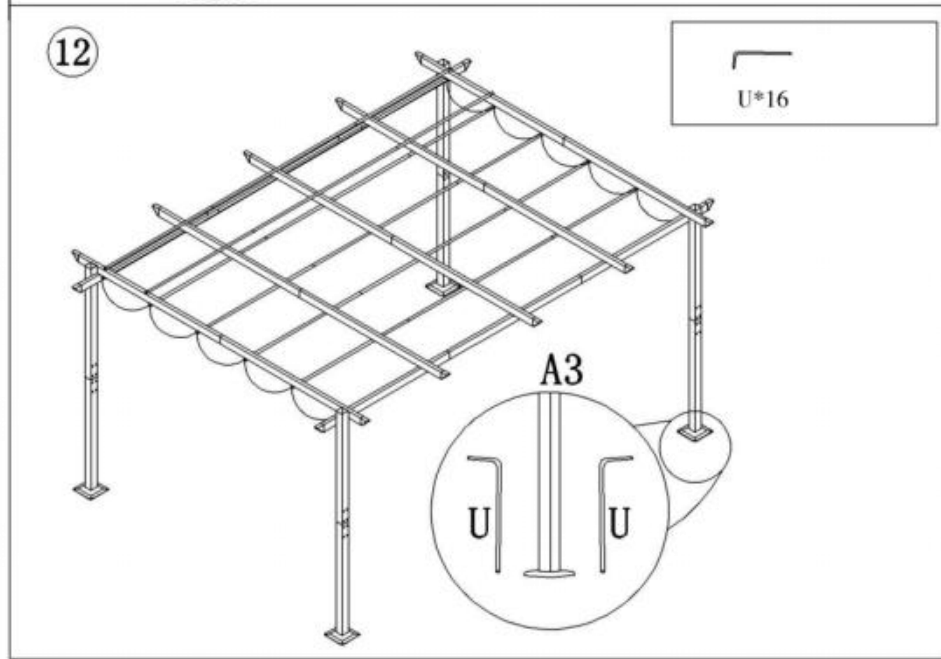
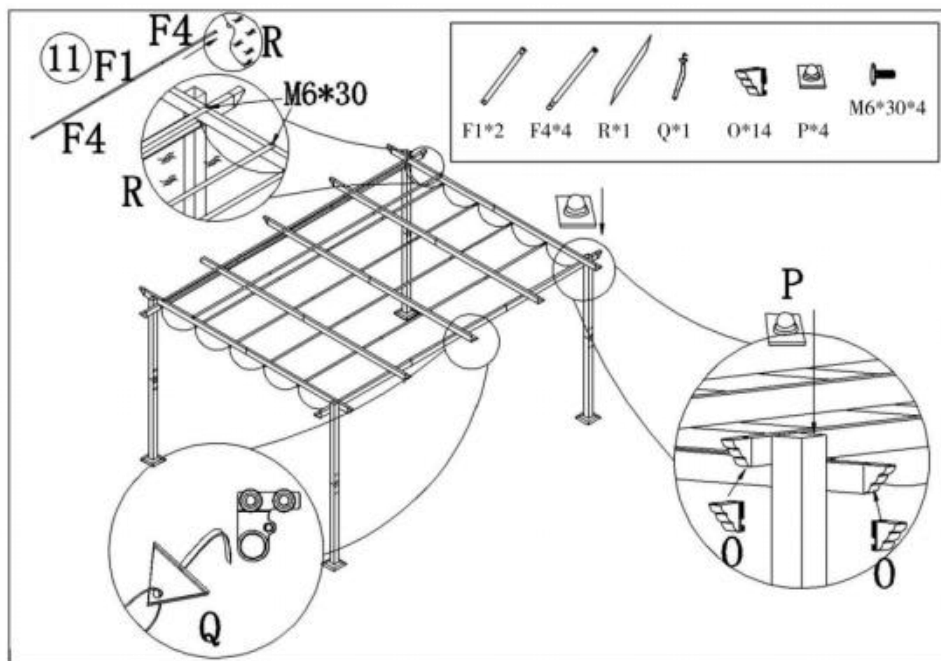

Hersteller : Shanghaimuxinmuyeyouxiangongsi

Adresse: Shuangchenglu 803nong11hao1602A-1609shi, Baoshanqu, Shanghai 200000 CN.

Nach AUS importiert: SIHAO PTY LTD. 1 ROKEVA
STREETEASTWOOD NSW 2122 Australien

Importiert in die USA: Sanven Technology Ltd. Suite 250, 9166 Anaheim
Ort, Rancho Cucamonga, CA 91730

| | |
|-----------|------------|
| EC | REP |
|-----------|------------|

E-CrossStu GmbH

Mainzer Landstr.69, 60329 Frankfurt am Main.

| | |
|-----------|------------|
| UK | REP |
|-----------|------------|

YH CONSULTING LIMITED.

C/O YH Consulting Limited Office 147, Centurion House,
London Road, Staines-upon-Thames, Surrey, TW18 4AX

VEVOR[®]

TOUGH TOOLS, HALF PRICE

Technisch Support und E-Garantie-Zertifikat

www.vevor.com/support

VEVOR[®]

TOUGH TOOLS, HALF PRICE

Technique Assistance et certificat de garantie électronique
www.vevor.com/support

PERGOLA RÉTRACTABLE

MANUEL DE L'UTILISATEUR

We continue to be committed to provide you tools with competitive price.

"Save Half", "Half Price" or any other similar expressions used by us only represents an estimate of savings you might benefit from buying certain tools with us compared to the major top brands and does not necessarily mean to cover all categories of tools offered by us. You are kindly reminded to verify carefully when you are placing an order with us if you are actually saving half in comparison with the top major brands.

VEVOR®

TOUGH TOOLS, HALF PRICE

RETRACTABLE PERGOLA

MODÈLE : JDG-098-34DGR/JDG-098-34DBL/JDG-098-34DBE

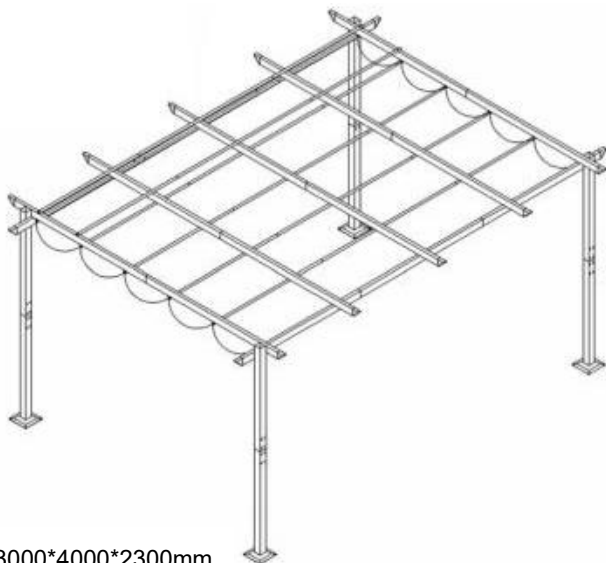

Product Size: 3000*4000*2300mm

NEED HELP? CONTACT US!

Have product questions? Need technical support? Please feel free to contact us:

Technical Support and E-Warranty Certificate
www.vevor.com/support

This is the original instruction, please read all manual instructions carefully before operating. VEVOR reserves a clear interpretation of our user manual. The appearance of the product shall be subject to the product you received. Please forgive us that we won't inform you again if there are any technology or software updates on our product.



Précautions de sécurité

Lisez ces instructions avant d'utiliser ce produit. Ne pas le faire peut entraîner des blessures graves. les précautions de base doivent toujours être suivies , notamment les suivantes :

VEUILLEZ NOTER! Les dessins de ce manuel sont destinés à titre d'illustration uniquement et dans certains détails, peut diffèrent du produit réel.

Avant l'assemblage

Avant le montage, nous recommandons :

3. Porter des gants.











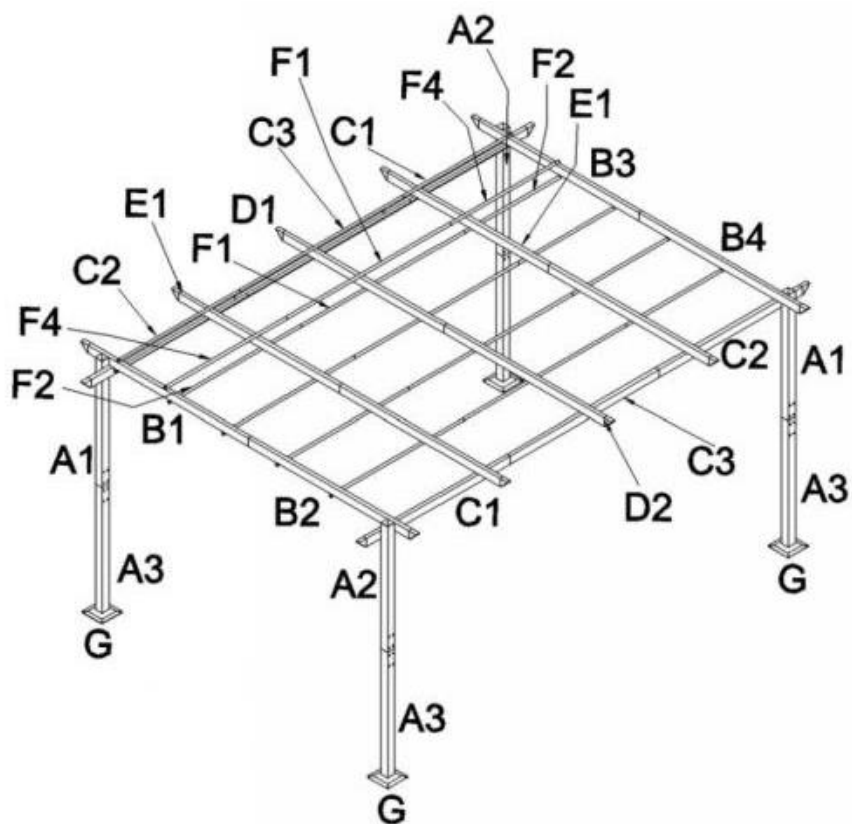

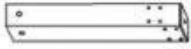
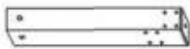





2. Outils recommandés, perceuse électrique avec embout Phillips

























3.nous recommandons 4 personnes pour un assemblage plus fluide

Liste de produits



| Item no. | Reference Image | Qty. | Item no. | Reference Image | Qty. |
|----------|---|------|----------|---|------|
| A1 |  | 2 | A2 |  | 2 |
| A3 |  | 4 | B1 |  | 1 |
| B2 |  | 1 | B3 |  | 1 |
| B4 |  | 1 | C1 |  | 2 |
| C2 |  | 2 | C3 |  | 2 |
| D1 |  | 1 | D2 |  | 1 |
| E1 |  | 4 | F1 |  | 8 |
| F2 |  | 12 | F4 |  | 4 |
| G |  | 4 | H |  | 3 |

| Item no. | Reference Image | Qty. | Item no. | Reference Image | Qty. |
|----------|---|------|----------|---|------|
| I |  | 6 | J |  | 8 |
| K |  | 1 | L |  | 5 |
| M |  | 12 | N |  | 2 |
| O |  | 14 | P |  | 4 |
| Q |  | 1 | R |  | 2 |
| S |  | 1 | T |  | 1 |
| U |  | 16 | V |  | 1 |
| W |  | 4 | | | |
| | | | | | |

| Item no. | Reference Image | Qty. | Item no. | Reference Image | Qty. |
|---|-----------------|------|---|-----------------|------|
|  | M6*10 | 24 |  | M6*15 | 134 |
|  | M6*30 | 4 |  | M6*75 | 6 |
|  | M6*40 | 3 |  | M6*15 | 32 |
|  | M6 | 64 | | | |
| | | | | | |
| | | | | | |
| | | | | | |
| | | | | | |
| | | | | | |
| | | | | | |

Description du produit

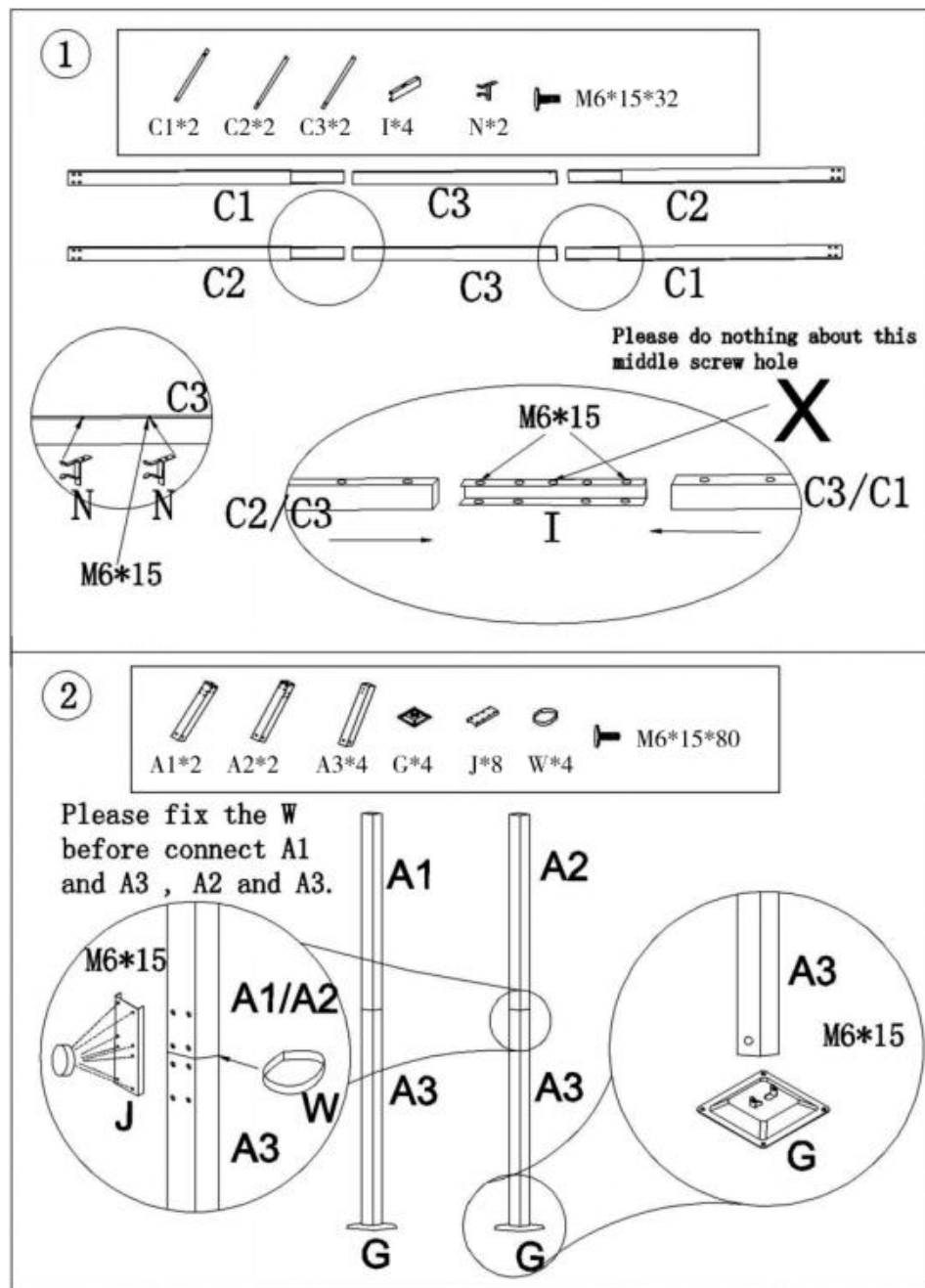

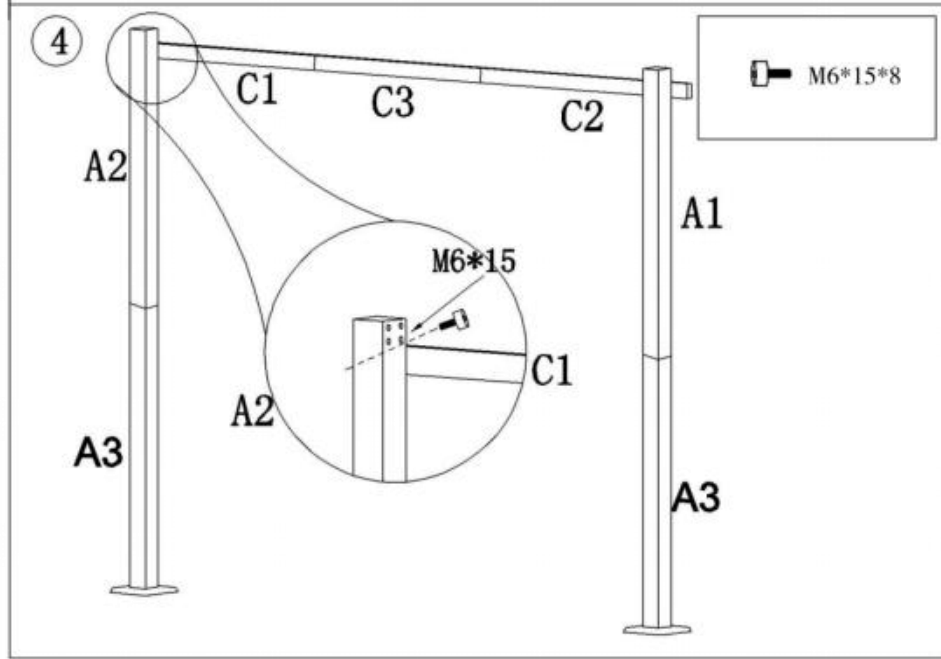
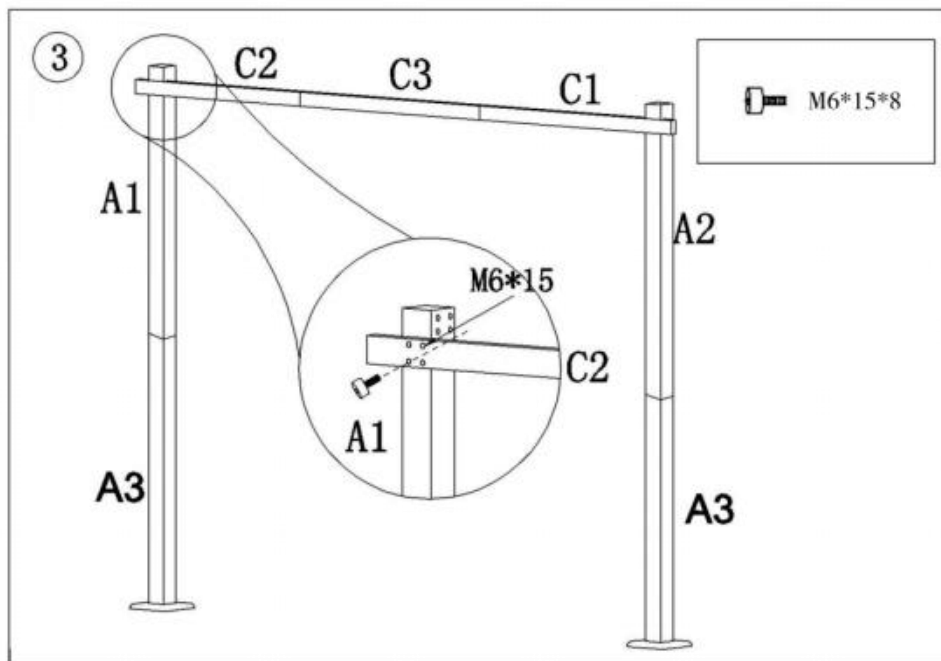

5

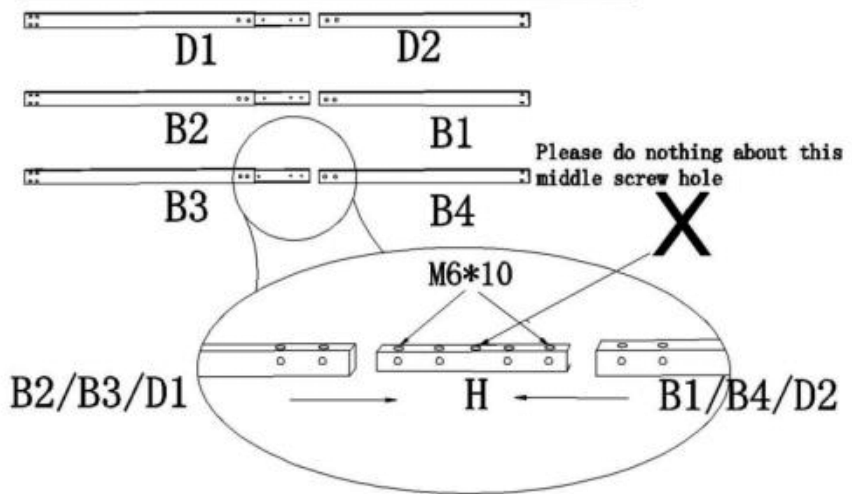
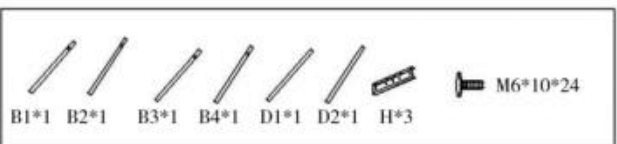

6

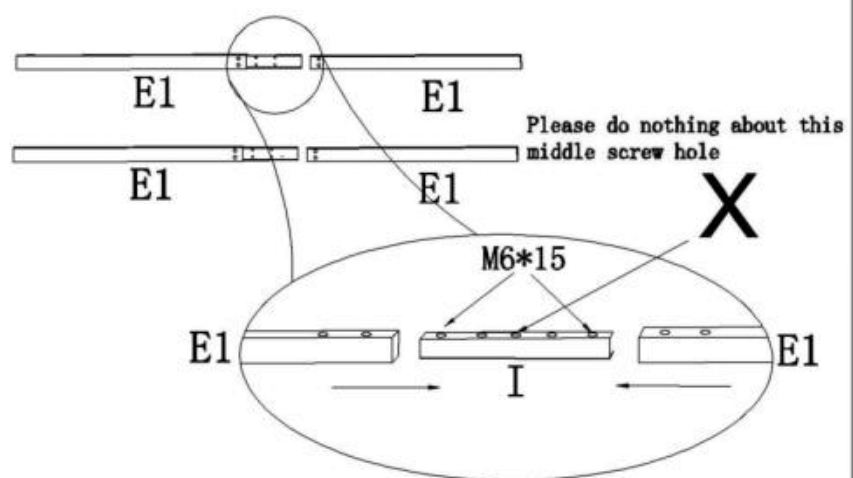
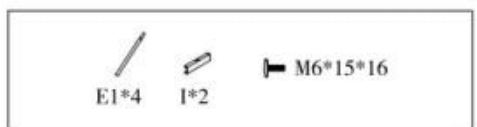

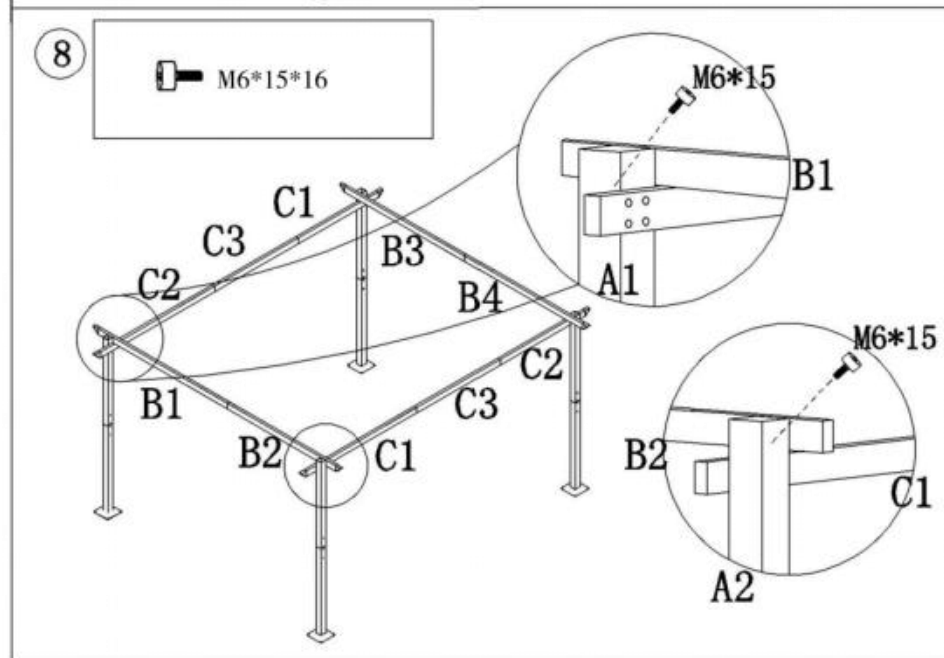
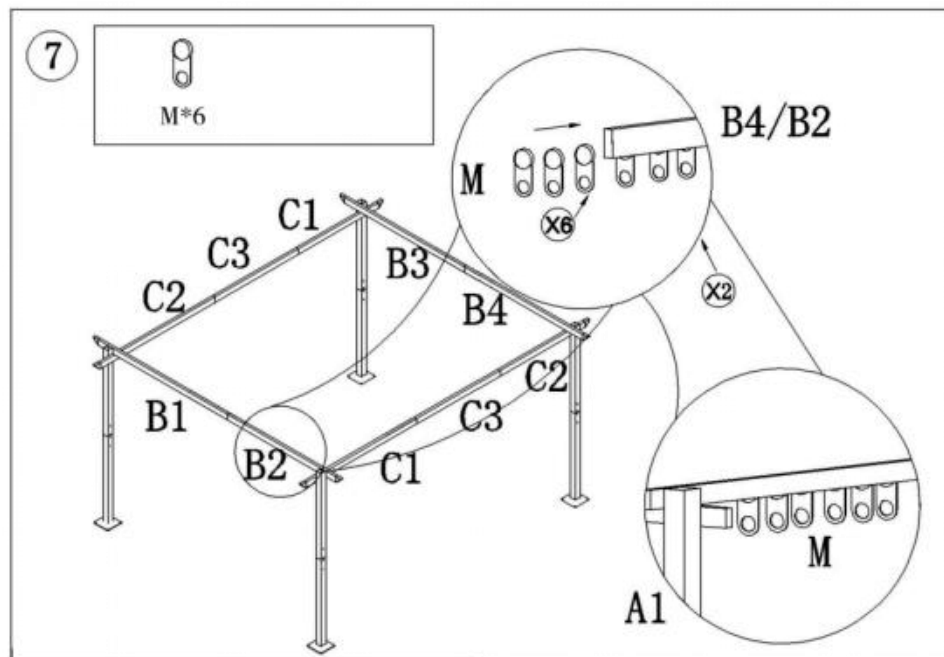

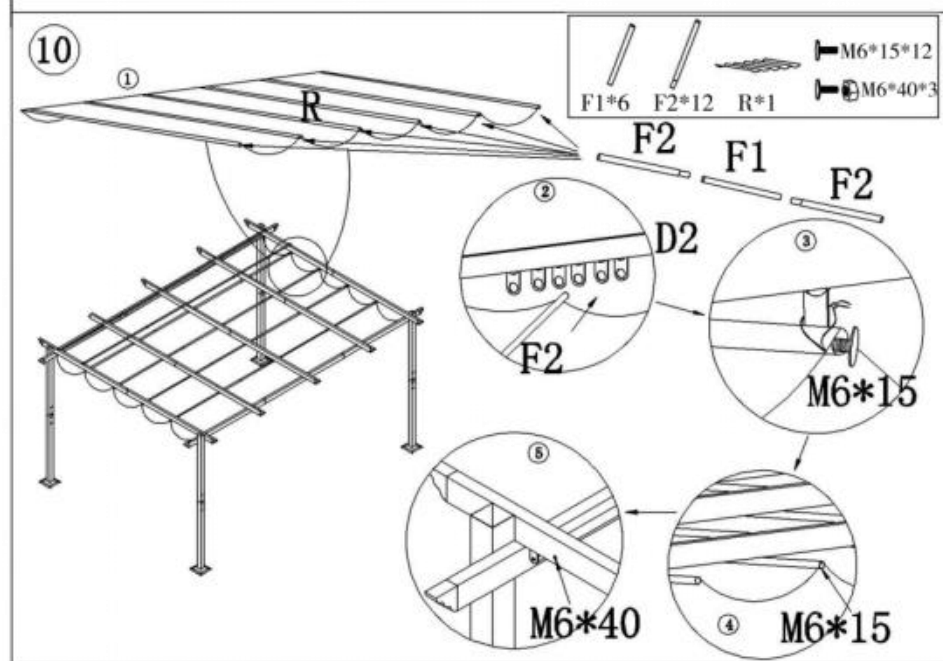
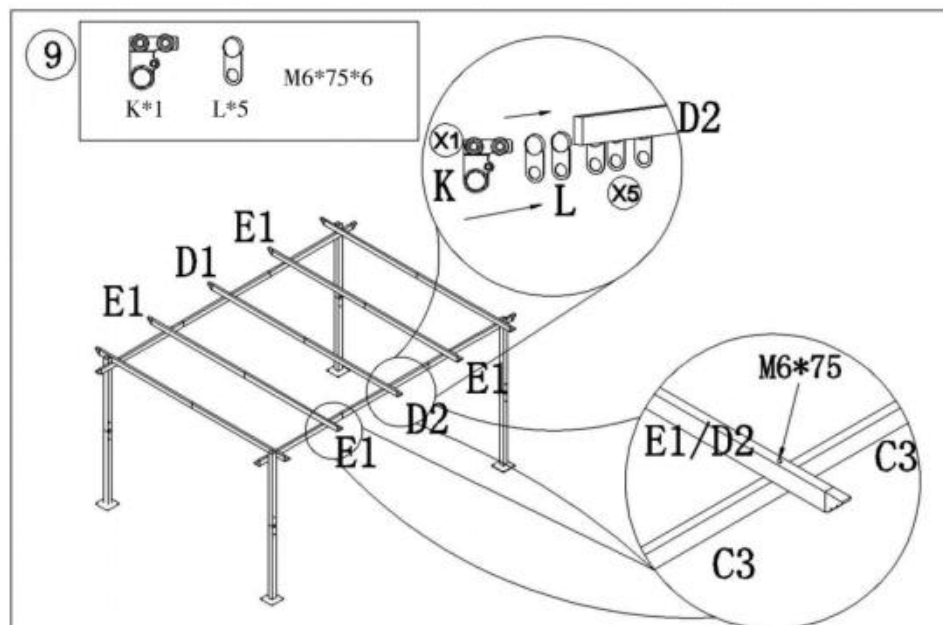

Remarque : le tissu supérieur fuit trous (R)

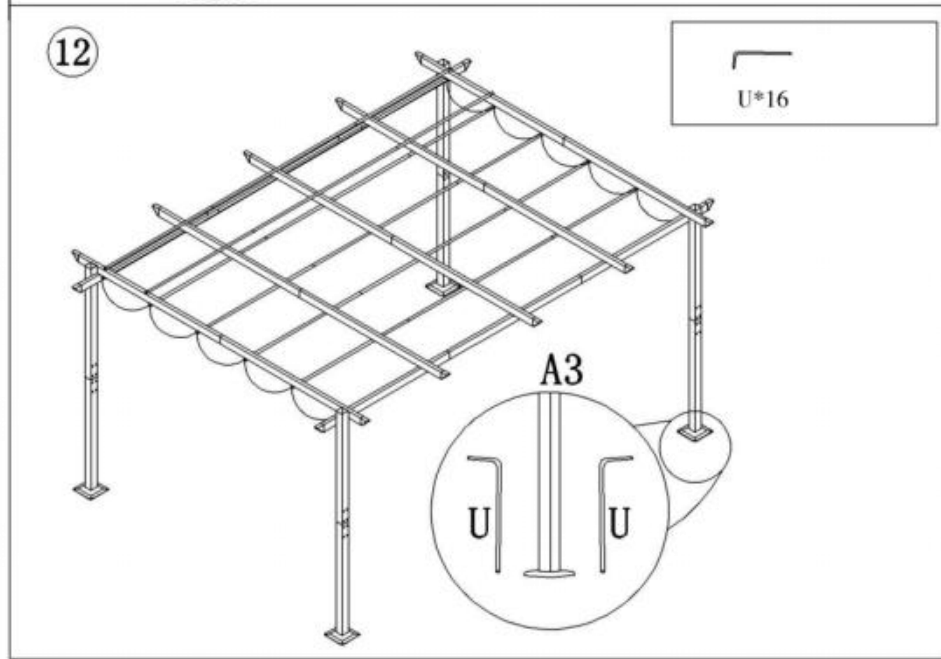
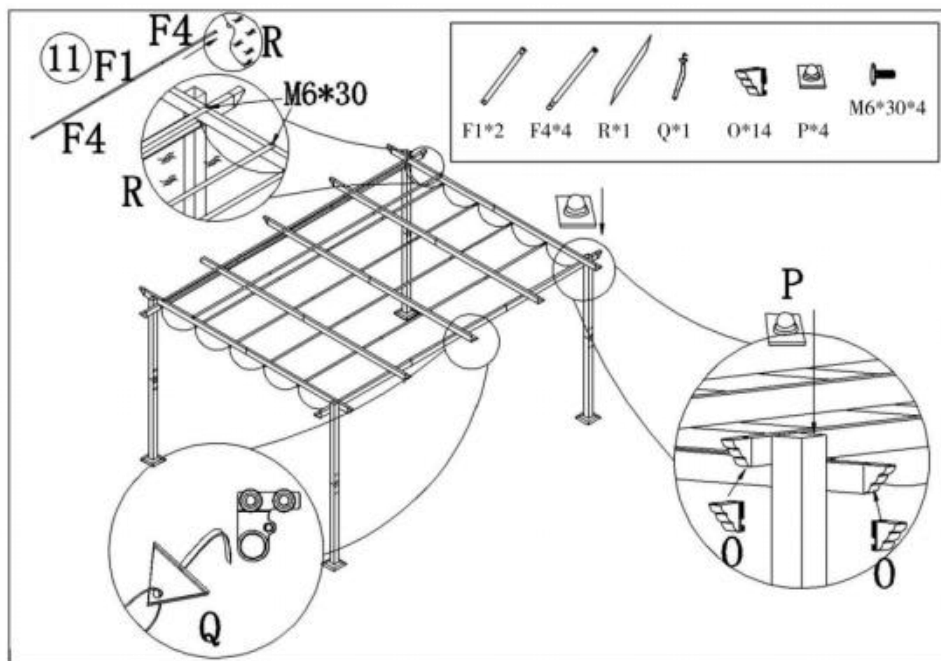

Fabricant : Shanghai muxinmuyeyouxiangongsi

Adresse : Shuangchenglu 803nong11hao1602A-1609shi, baoshanqu, Shanghai 200000 CN.

Importé en Australie : SIHAO PTY LTD. 1 ROKEVA STREETASTWOOD NSW 2122 Australie

Importé aux États-Unis : Sanven Technology Ltd. Suite 250, 9166 Anaheim

Lieu, Rancho Cucamonga, CA 91730

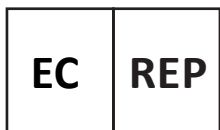

E-CrossStu GmbH

Mainzer Landstr.69, 60329 Frankfurt am Main.



YH CONSULTING LIMITED.

C/O YH Consulting Limited Office 147, Centurion House, London Road, Staines-upon-Thames, Surrey, TW18 4AX

VEVOR[®]

TOUGH TOOLS, HALF PRICE

Technique Assistance et certificat de garantie électronique

www.vevor.com/support



Technisch Ondersteuning en e-garantiecertificaat www.vevor.com/support

INTREKBARE PERGOLA

HANDLEIDING

We continue to be committed to provide you tools with competitive price.

"Save Half", "Half Price" or any other similar expressions used by us only represents an estimate of savings you might benefit from buying certain tools with us compared to the major top brands and does not necessarily mean to cover all categories of tools offered by us. You are kindly reminded to verify carefully when you are placing an order with us if you are actually saving half in comparison with the top major brands.

VEVOR®

TOUGH TOOLS, HALF PRICE

RETRACTABLE PERGOLA

MODEL: JDG-098-34DGR / JDG-098-34DBL / JDG-098-34DBE

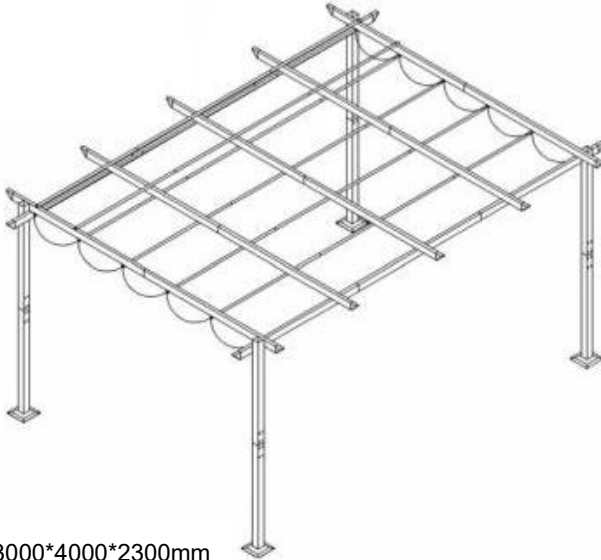

Product Size: 3000*4000*2300mm

NEED HELP? CONTACT US!

Have product questions? Need technical support? Please feel free to contact us:

Technical Support and E-Warranty Certificate
www.vevor.com/support

This is the original instruction, please read all manual instructions carefully before operating. VEVOR reserves a clear interpretation of our user manual. The appearance of the product shall be subject to the product you received. Please forgive us that we won't inform you again if there are any technology or software updates on our product.



Veiligheidsmaatregelen

Lees deze instructies voordat u dit product gebruikt. Als u dit niet doet, kan dit leiden tot ernstig letsel. de basisverzorgingsmaatregelen moeten altijd worden gevolgd , waaronder de volgende:

HOUD ER REKENING MEE DAT! De tekeningen in deze handleiding zijn bedoeld voor alleen ter illustratie en in sommige details mogelijk afwijken van het daadwerkelijke product.

Vóór de montage

Voordat u met de montage begint, raden wij u aan:

4. Draag handschoenen.





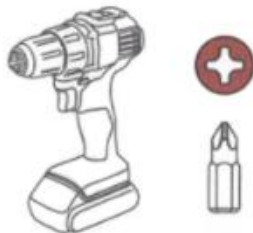





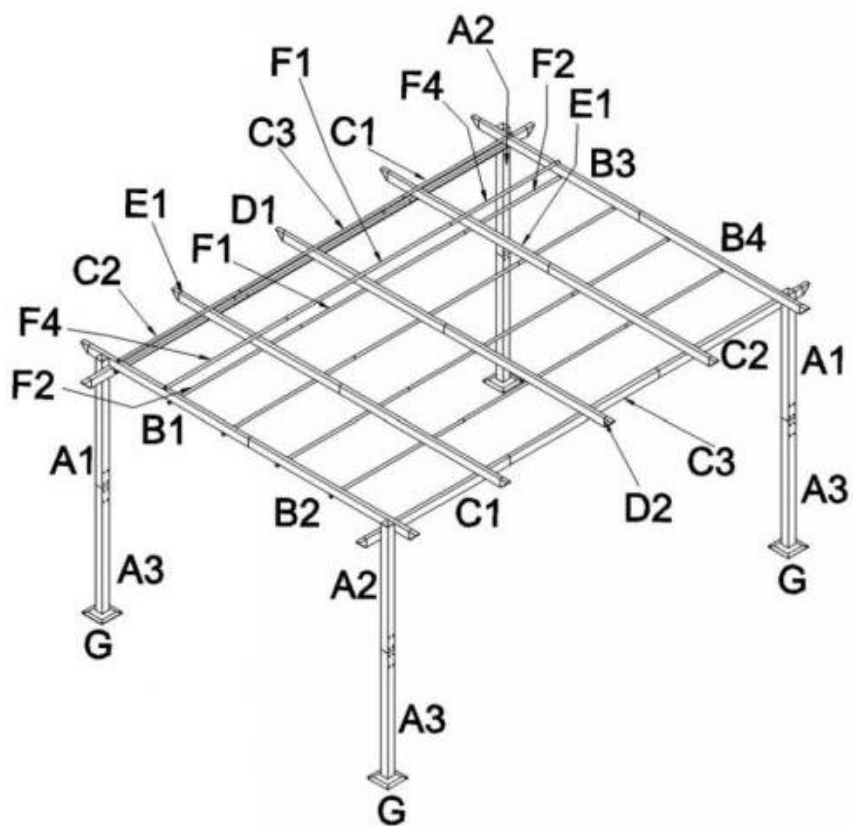

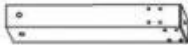







2. Aanbevolen gereedschap, boormachine met kruiskopbit

























3. Wij raden 4 personen aan voor een soepelere montage

Product lijst



| Item no. | Reference Image | Qty. | Item no. | Reference Image | Qty. |
|----------|---|------|----------|---|------|
| A1 |  | 2 | A2 |  | 2 |
| A3 |  | 4 | B1 |  | 1 |
| B2 |  | 1 | B3 |  | 1 |
| B4 |  | 1 | C1 |  | 2 |
| C2 |  | 2 | C3 |  | 2 |
| D1 |  | 1 | D2 |  | 1 |
| E1 |  | 4 | F1 |  | 8 |
| F2 |  | 12 | F4 |  | 4 |
| G |  | 4 | H |  | 3 |

| Item no. | Reference Image | Qty. | Item no. | Reference Image | Qty. |
|----------|---|------|----------|---|------|
| I |  | 6 | J |  | 8 |
| K |  | 1 | L |  | 5 |
| M |  | 12 | N |  | 2 |
| O |  | 14 | P |  | 4 |
| Q |  | 1 | R |  | 2 |
| S |  | 1 | T |  | 1 |
| U |  | 16 | V |  | 1 |
| W |  | 4 | | | |
| | | | | | |

| Item no. | Reference Image | Qty. | Item no. | Reference Image | Qty. |
|---|-----------------|------|---|-----------------|------|
|  | M6*10 | 24 |  | M6*15 | 134 |
|  | M6*30 | 4 |  | M6*75 | 6 |
|  | M6*40 | 3 |  | M6*15 | 32 |
|  | M6 | 64 | | | |
| | | | | | |
| | | | | | |
| | | | | | |
| | | | | | |
| | | | | | |
| | | | | | |

Productomschrijving

1

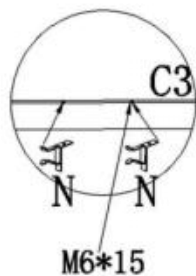
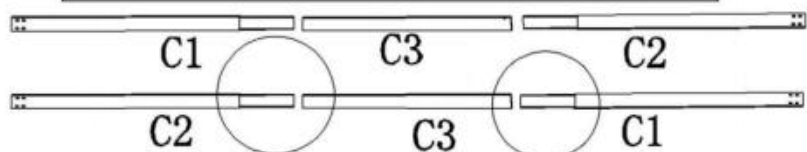

Please do nothing about this middle screw hole

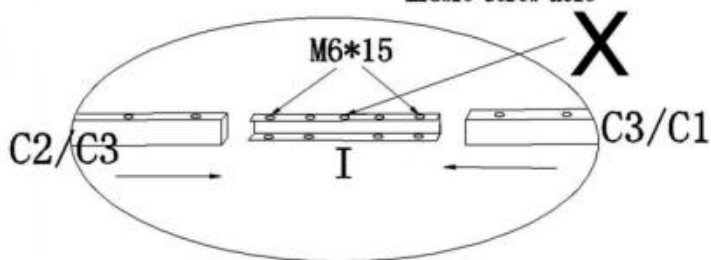

2

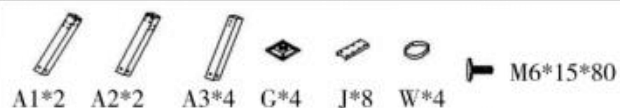

Please fix the W before connect A1 and A3, A2 and A3.

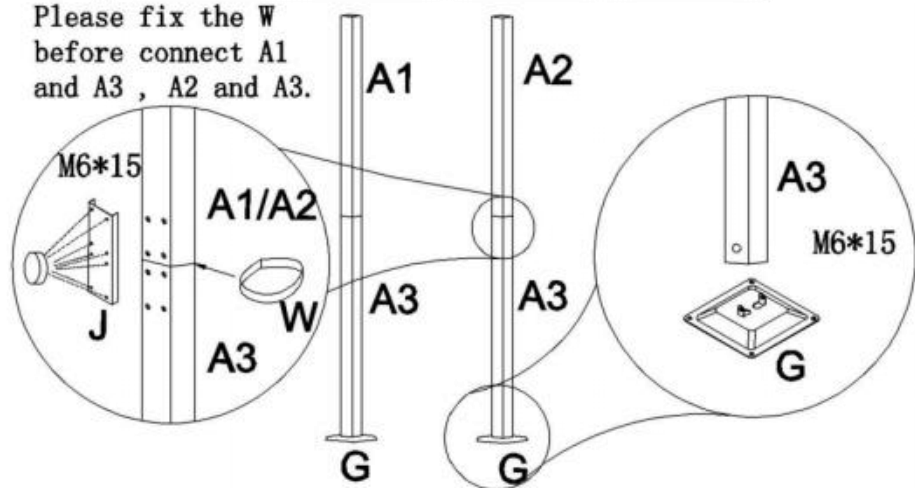

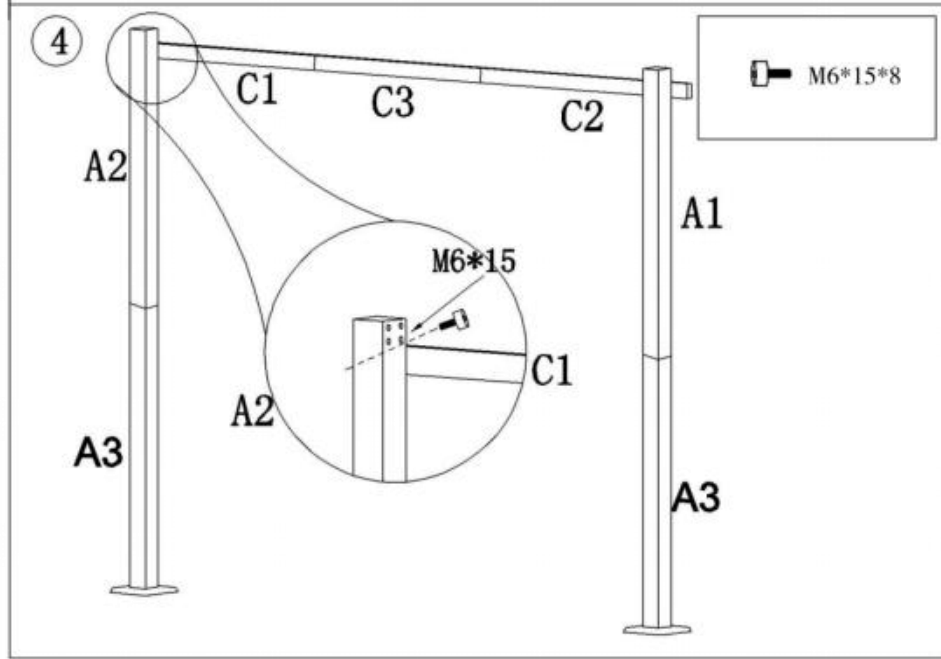
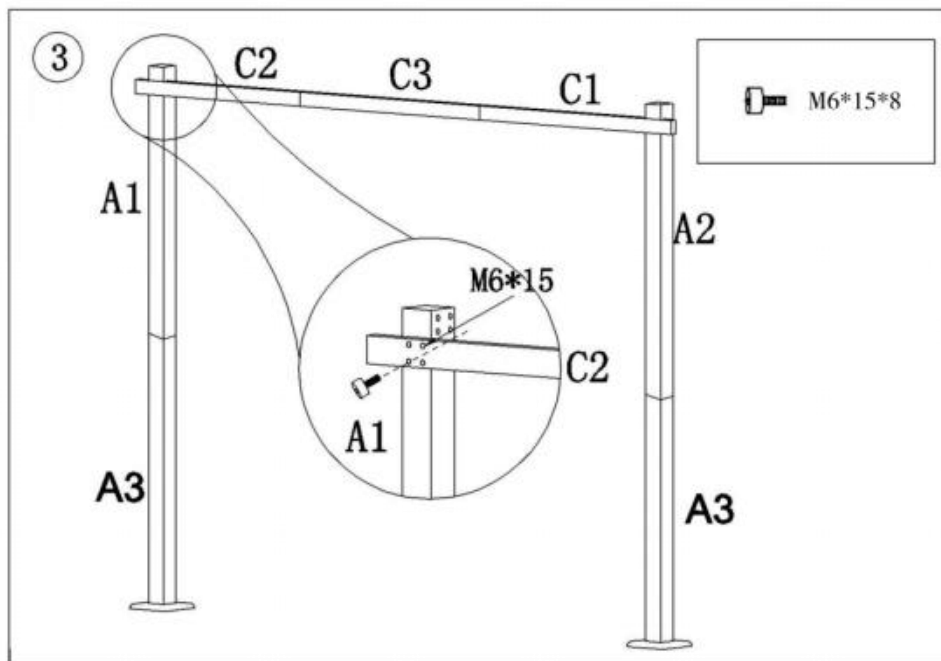

5

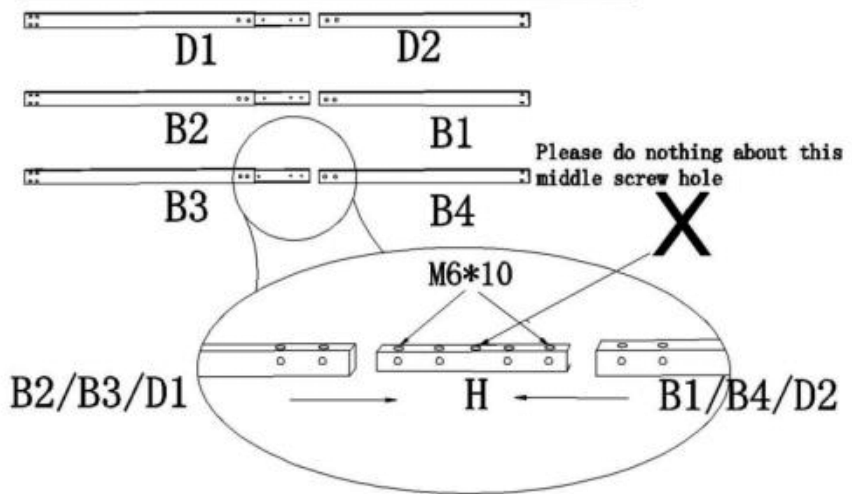
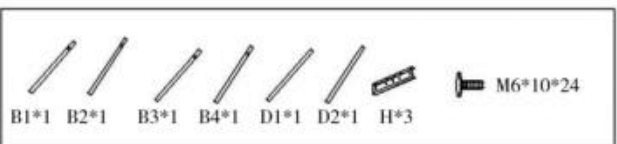

6

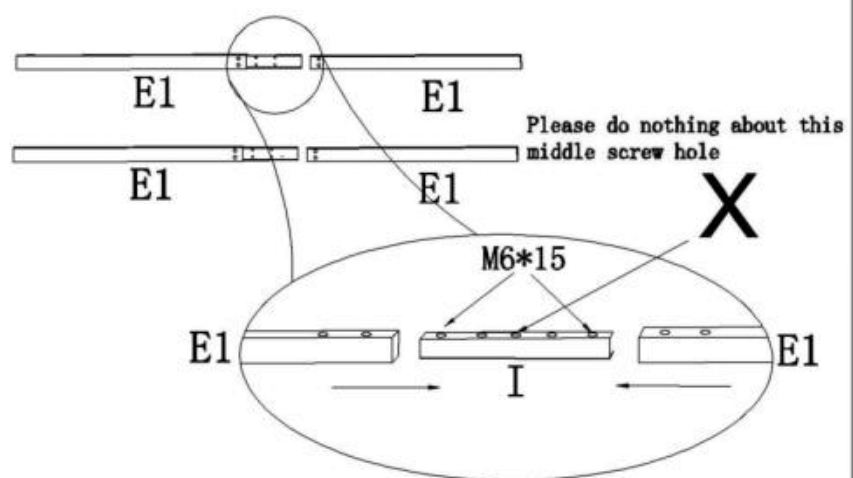
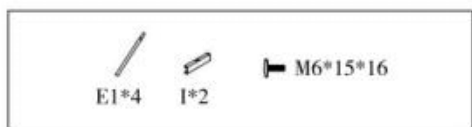

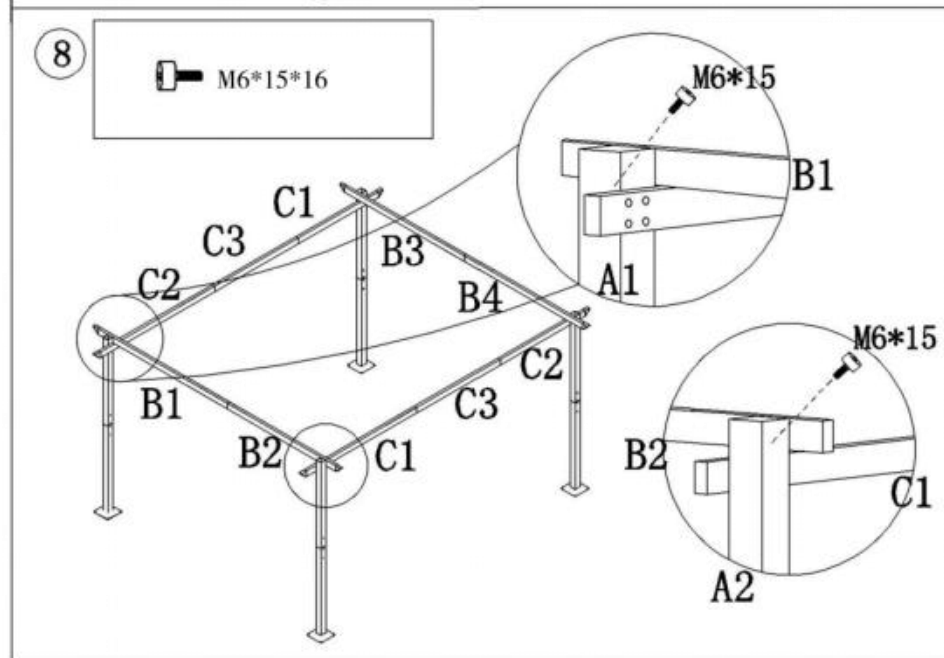
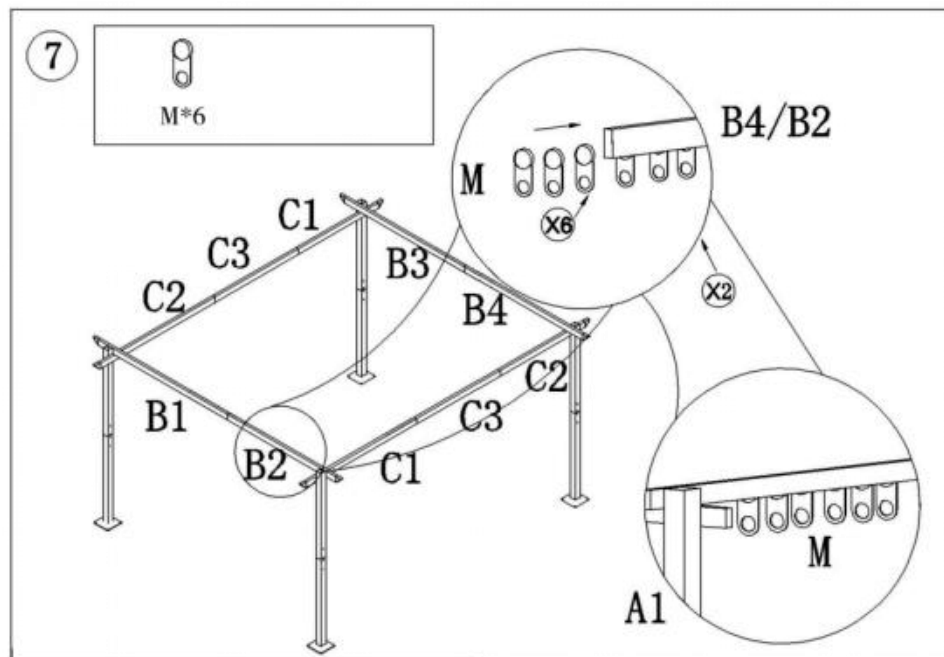

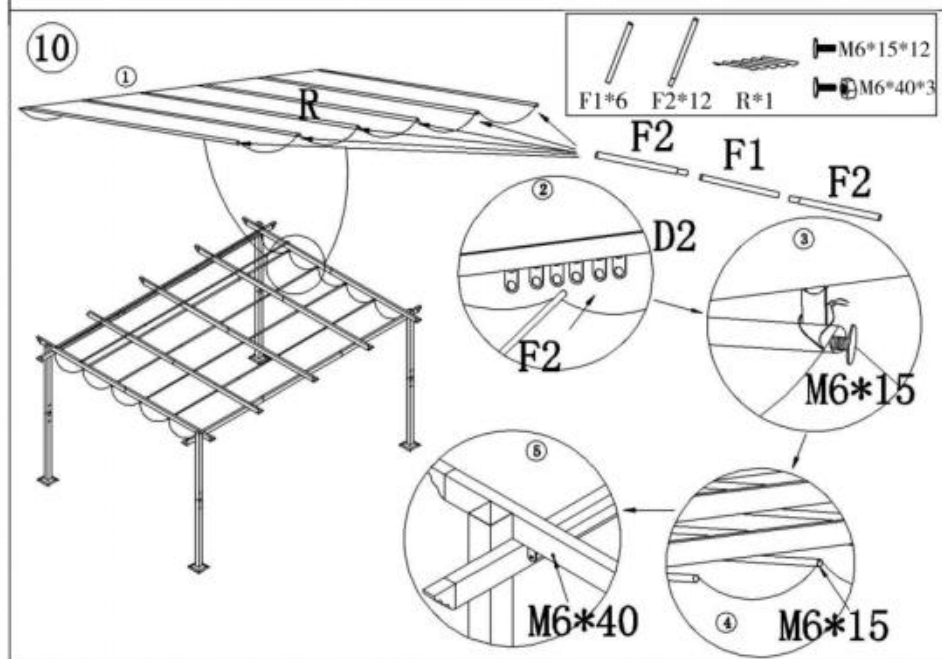
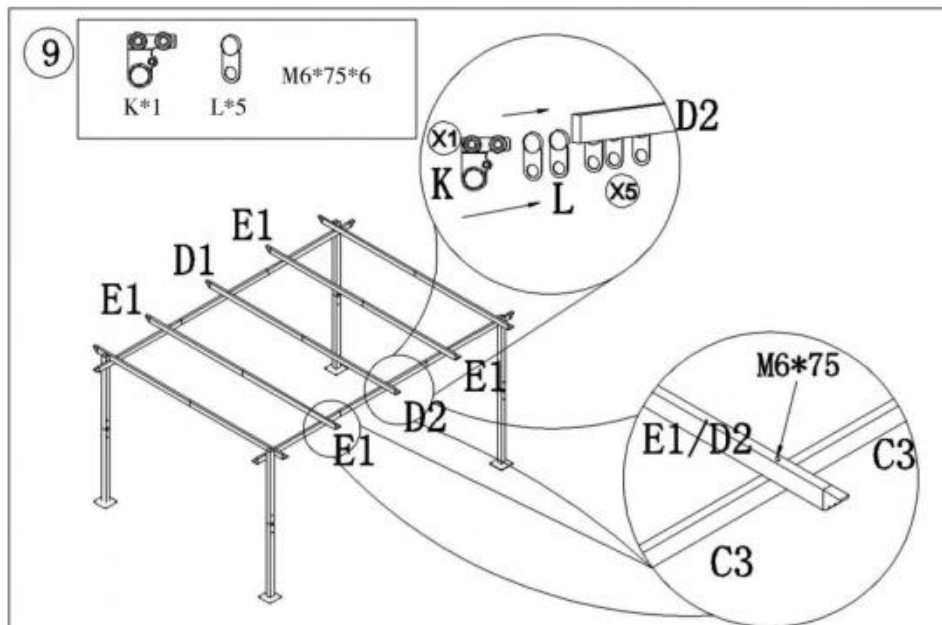

Let op: Het bovenste doek lekt gaten (R)

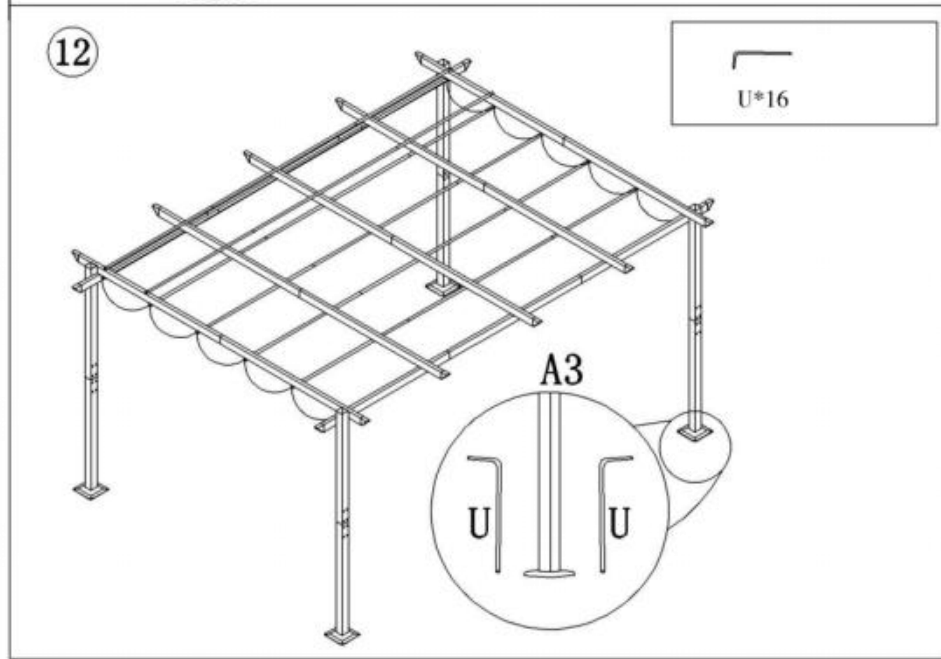
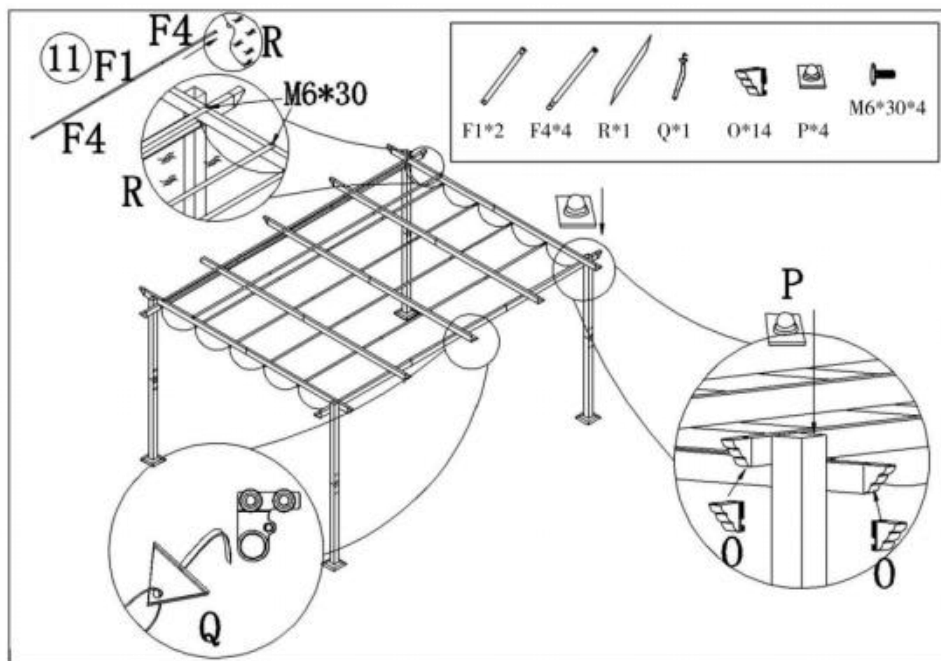

Fabrikant : Shanghaimuxinmuyeyouxiangongsi

Adres: Shuangchenglu 803nong11hao1602A-1609shi, baoshanqu, shanghai 200000 CN.

Geïmporteerd naar AUS: SIHAO PTY LTD. 1 ROKEVA
STREETEASTWOOD NSW 2122 Australië

Geïmporteerd in de VS: Sanven Technology Ltd. Suite 250, 9166
Anaheim

Plaats, Rancho Cucamonga, CA 91730

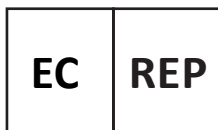

E-CrossStu GmbH

Mainzer Landstr.69, 60329 Frankfurt am Main.



YH CONSULTING LIMITED.

C/O YH Consulting Limited Office 147, Centurion House,
London Road, Staines-upon-Thames, Surrey, TW18 4AX

VEVOR[®]

TOUGH TOOLS, HALF PRICE

Technisch Ondersteuning en e-garantiecertificaat

www.vevor.com/support



Teknisk Support och e-garanticertifikat www.vevor.com/support

INFÄLLBAR PERGOLA

ANVÄNDARMANUAL

We continue to be committed to provide you tools with competitive price.

"Save Half", "Half Price" or any other similar expressions used by us only represents an estimate of savings you might benefit from buying certain tools with us compared to the major top brands and does not necessarily mean to cover all categories of tools offered by us. You are kindly reminded to verify carefully when you are placing an order with us if you are actually saving half in comparison with the top major brands.

VEVOR®

TOUGH TOOLS, HALF PRICE

RETRACTABLE PERGOLA

MODELL: JDG-098-34DGR / JDG-098-34DBL / JDG-098-34DBE

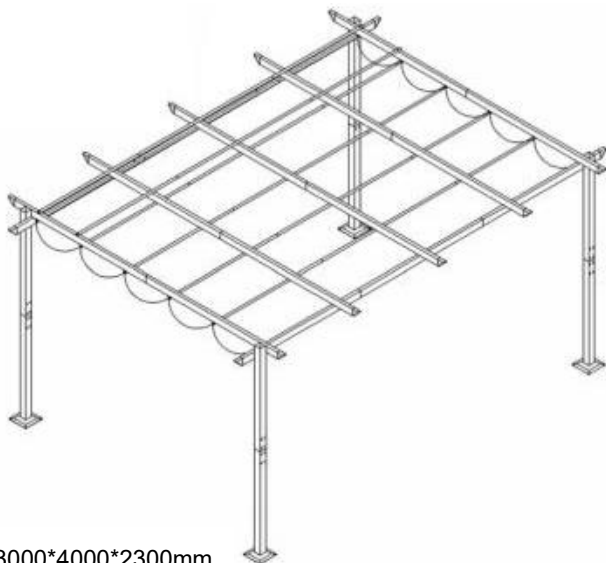

Product Size: 3000*4000*2300mm

NEED HELP? CONTACT US!

Have product questions? Need technical support? Please feel free to contact us:

Technical Support and E-Warranty Certificate
www.vevor.com/support

This is the original instruction, please read all manual instructions carefully before operating. VEVOR reserves a clear interpretation of our user manual. The appearance of the product shall be subject to the product you received. Please forgive us that we won't inform you again if there are any technology or software updates on our product.



Säkerhetsåtgärder

Läs dessa instruktioner innan du använder denna produkt. Underlåtenhet att göra det kan resultera i allvarliga skador. de grundläggande försiktighetsåtgärderna bör alltid följas , inklusive följande:

VÄNLIGEN NOTERA! Ritningar i denna handbok är till för endast i illustrationssyfte och i vissa detaljer kan skilja sig från den faktiska produkten.

! Innan montering

Innan montering rekommenderar vi:

5. Bära handskar.











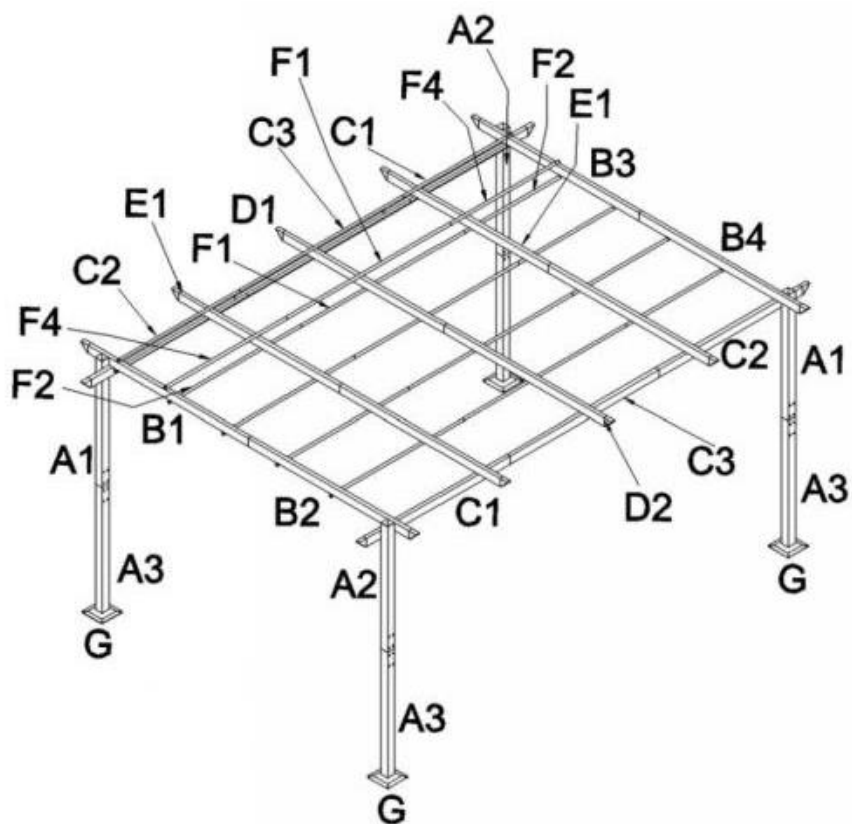

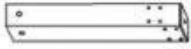
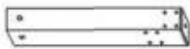





2. Rekommenderade verktyg, bormaskin med stjärnborr

























3. vi rekommenderar 4 personer för en smidigare montering

Produktlista



| Item no. | Reference Image | Qty. | Item no. | Reference Image | Qty. |
|----------|---|------|----------|---|------|
| A1 |  | 2 | A2 |  | 2 |
| A3 |  | 4 | B1 |  | 1 |
| B2 |  | 1 | B3 |  | 1 |
| B4 |  | 1 | C1 |  | 2 |
| C2 |  | 2 | C3 |  | 2 |
| D1 |  | 1 | D2 |  | 1 |
| E1 |  | 4 | F1 |  | 8 |
| F2 |  | 12 | F4 |  | 4 |
| G |  | 4 | H |  | 3 |

| Item no. | Reference Image | Qty. | Item no. | Reference Image | Qty. |
|----------|---|------|----------|---|------|
| I |  | 6 | J |  | 8 |
| K |  | 1 | L |  | 5 |
| M |  | 12 | N |  | 2 |
| O |  | 14 | P |  | 4 |
| Q |  | 1 | R |  | 2 |
| S |  | 1 | T |  | 1 |
| U |  | 16 | V |  | 1 |
| W |  | 4 | | | |
| | | | | | |

| Item no. | Reference Image | Qty. | Item no. | Reference Image | Qty. |
|---|-----------------|------|---|-----------------|------|
|  | M6*10 | 24 |  | M6*15 | 134 |
|  | M6*30 | 4 |  | M6*75 | 6 |
|  | M6*40 | 3 |  | M6*15 | 32 |
|  | M6 | 64 | | | |
| | | | | | |
| | | | | | |
| | | | | | |
| | | | | | |
| | | | | | |
| | | | | | |

Produktbeskrivning

1

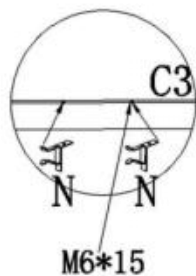
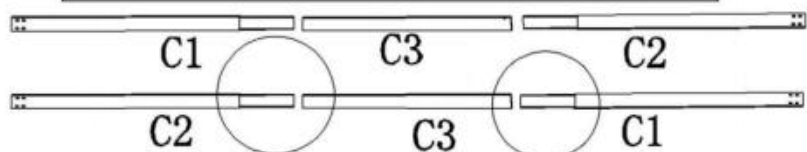

Please do nothing about this middle screw hole

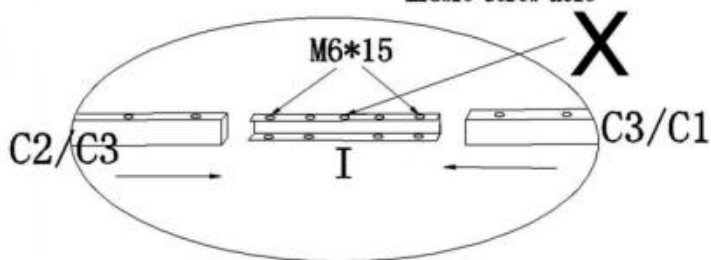

2

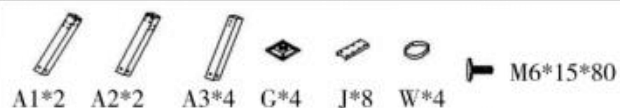

Please fix the W before connect A1 and A3, A2 and A3.

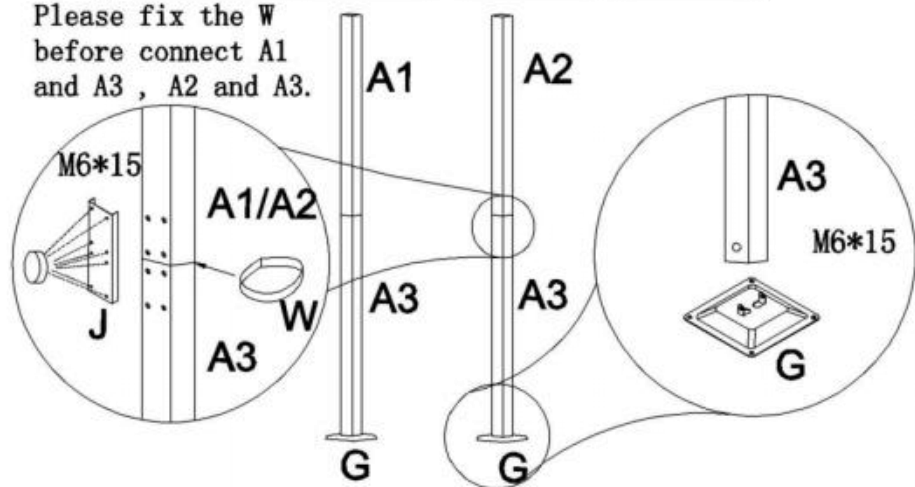

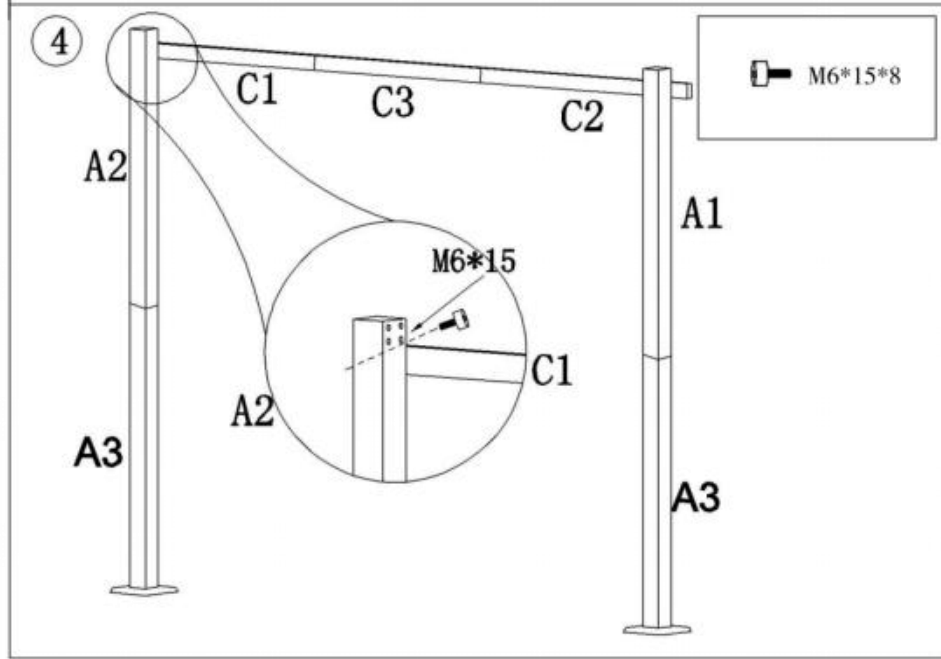
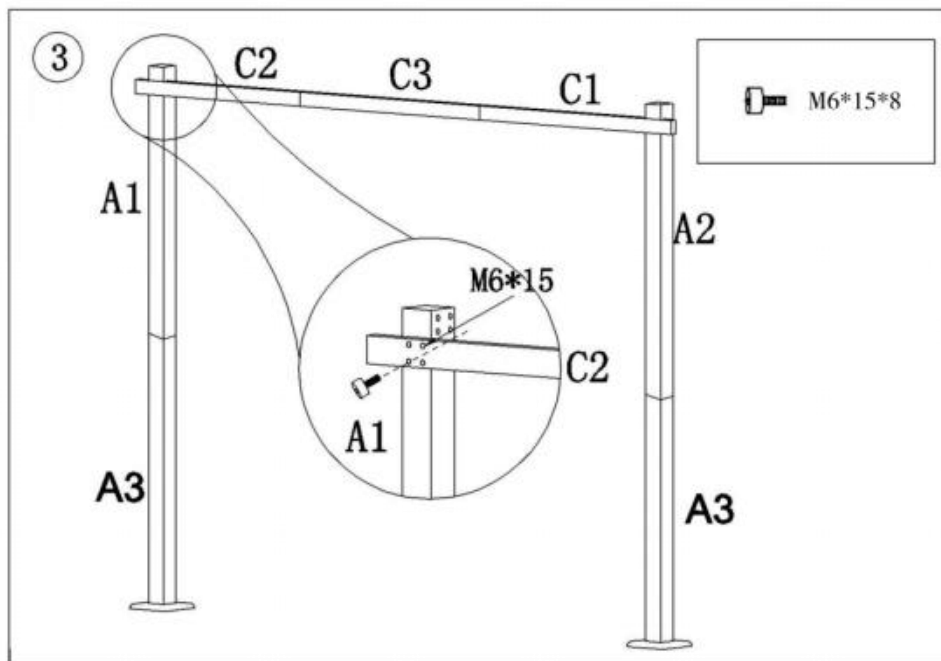

5

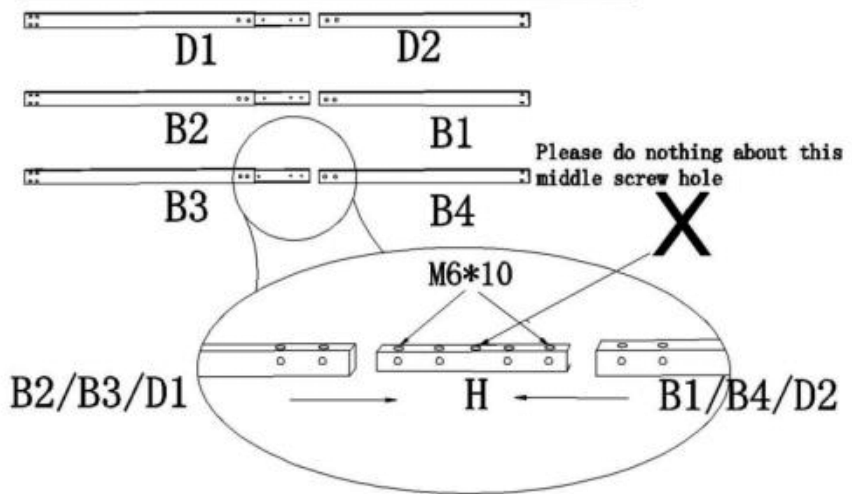
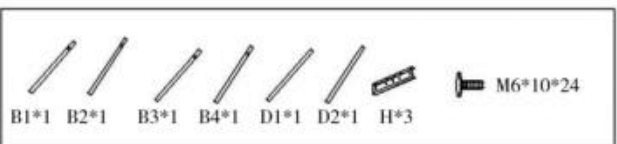

6

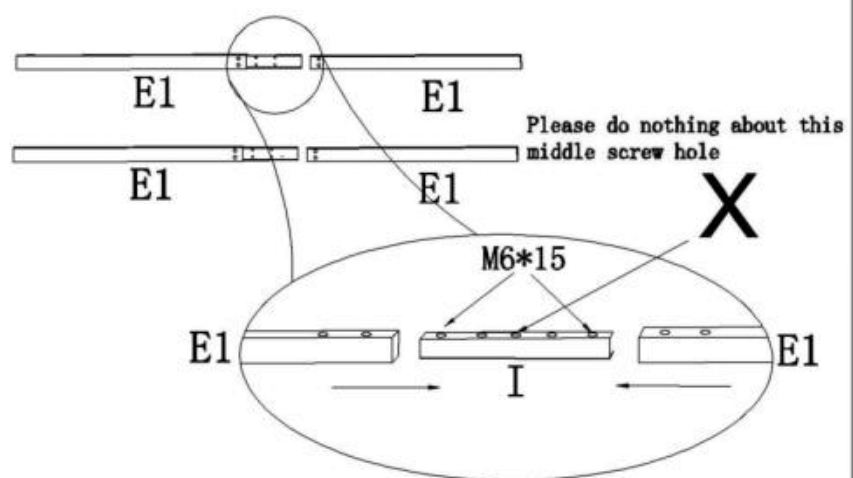
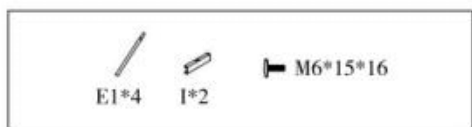

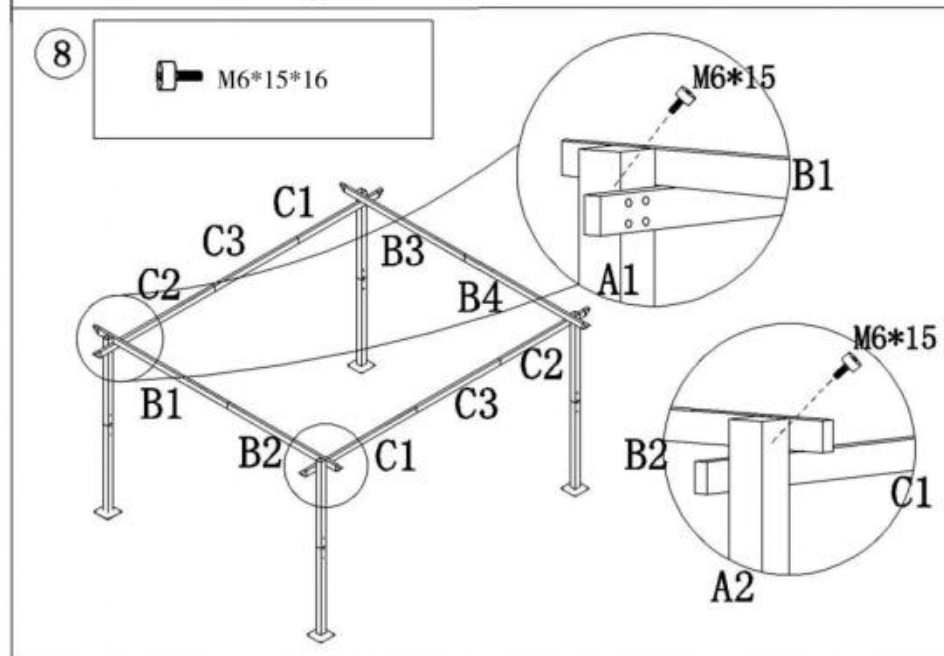
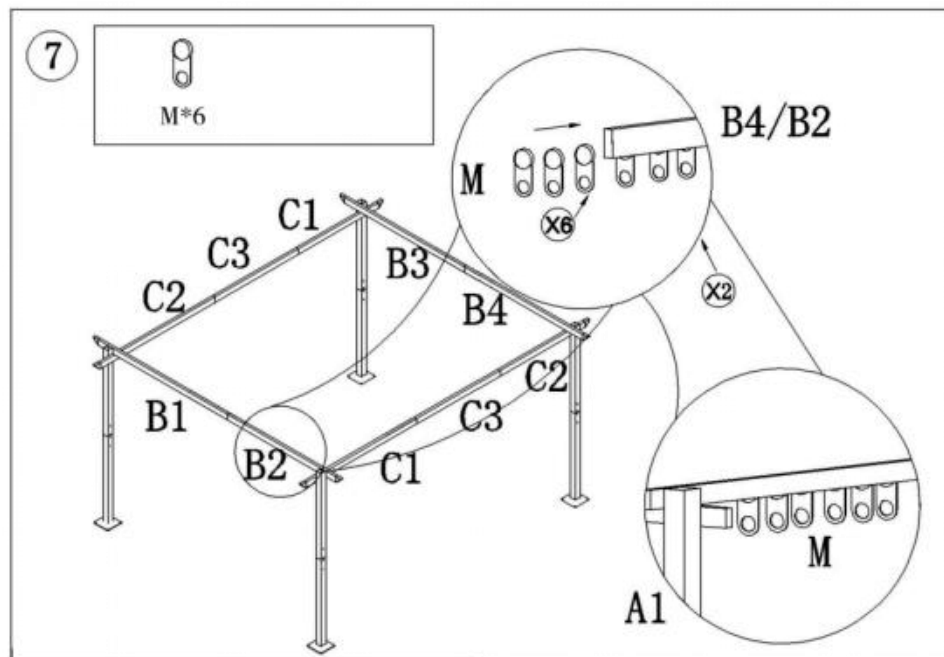

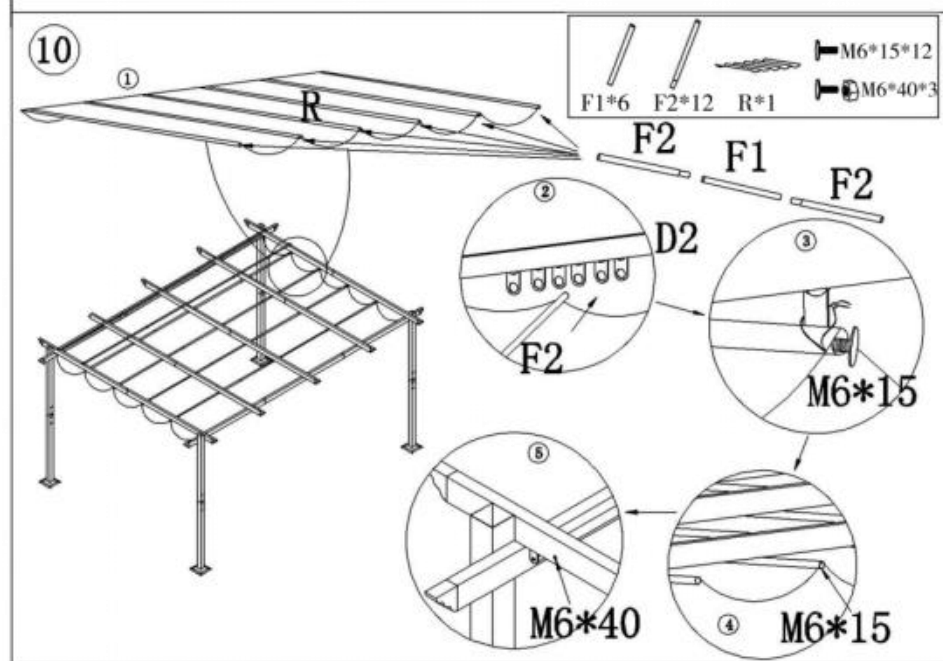
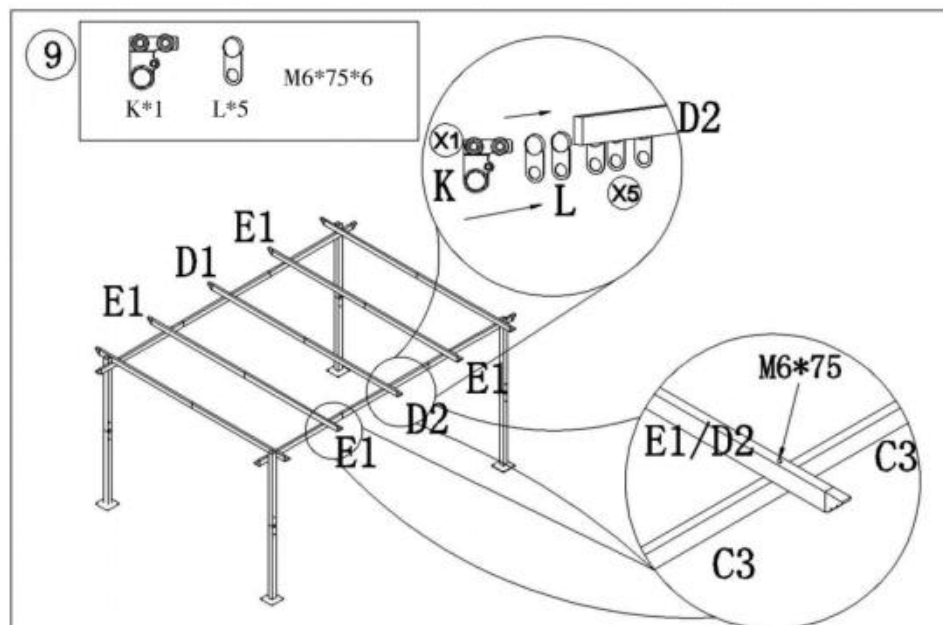

Obs: Den övre duken har läcker h oles (R)

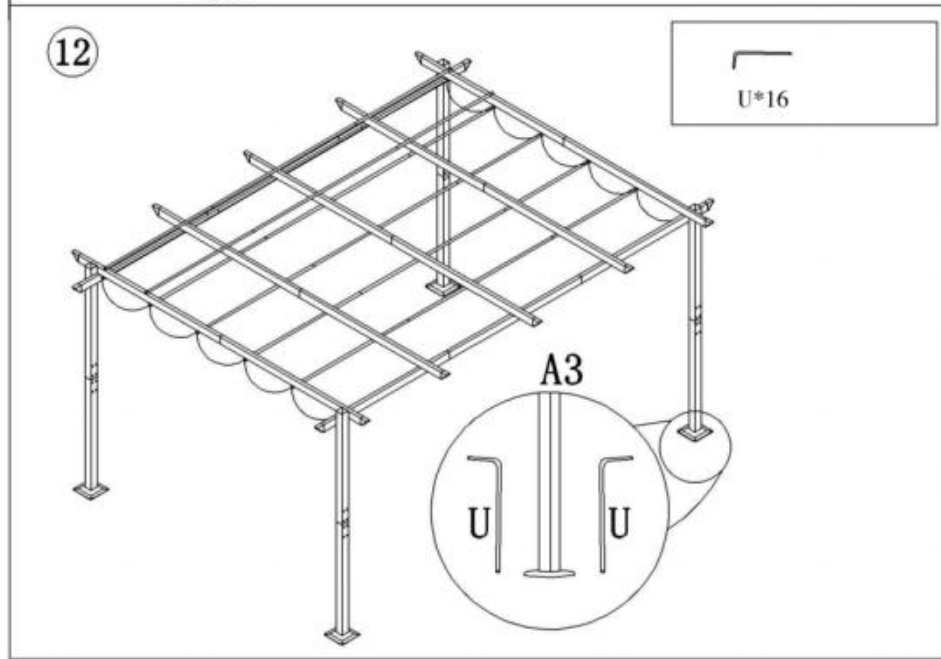
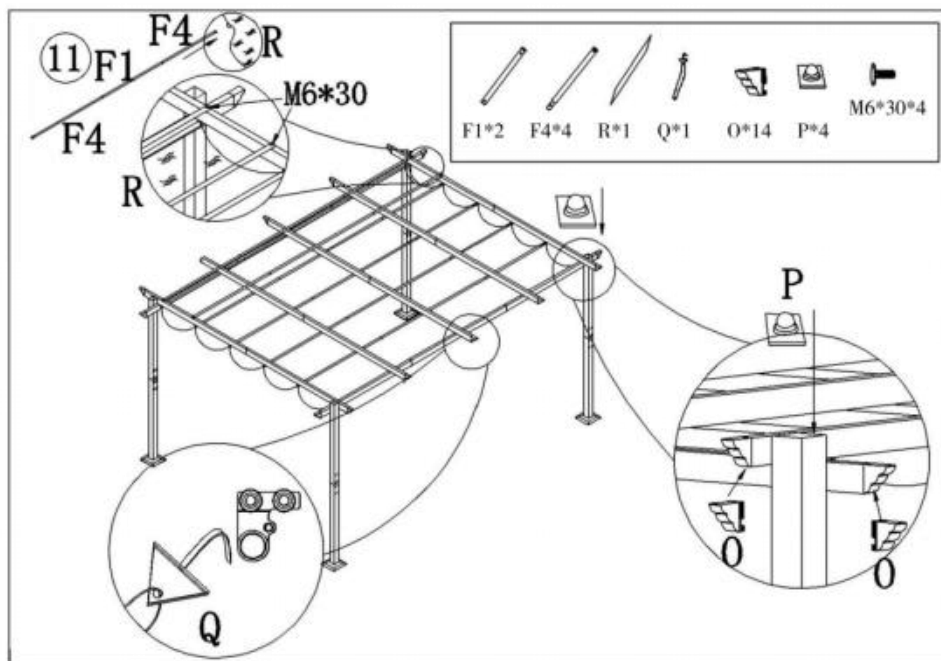

Tillverkare : Shanghaimuxinmuyeyouxiangongsi

Adress: Shuangchenglu 803nong11hao1602A-1609shi, baoshanqu, shanghai 200000 CN.

Importerad till AUS: SIHAO PTY LTD. 1 ROKEVA STREETEASTWOOD NSW 2122 Australien

Importerad till USA: Sanven Technology Ltd. Suite 250, 9166 Anaheim Place, Rancho Cucamonga, CA 91730

| | |
|-----------|------------|
| EC | REP |
|-----------|------------|

E-CrossStu GmbH

Mainzer Landstr.69, 60329 Frankfurt am Main.

| | |
|-----------|------------|
| UK | REP |
|-----------|------------|

YH CONSULTING LIMITED.

C/O YH Consulting Limited Office 147, Centurion House,
London Road, Staines-upon-Thames, Surrey, TW18 4AX

VEVOR[®]

TOUGH TOOLS, HALF PRICE

Teknisk Support och e-garanticertifikat

www.vevor.com/support



Técnico Soporte y certificado de garantía electrónica www.vevor.com/support

PÉRGOLA RETRÁCTIL

MANUAL DE USUARIO

We continue to be committed to provide you tools with competitive price.

"Save Half", "Half Price" or any other similar expressions used by us only represents an estimate of savings you might benefit from buying certain tools with us compared to the major top brands and does not necessarily mean to cover all categories of tools offered by us. You are kindly reminded to verify carefully when you are placing an order with us if you are actually saving half in comparison with the top major brands.

VEVOR®

TOUGH TOOLS, HALF PRICE

RETRACTABLE PERGOLA

MODELO: JDG-098-34DGR / JDG-098-34DBL / JDG-098-34DBE

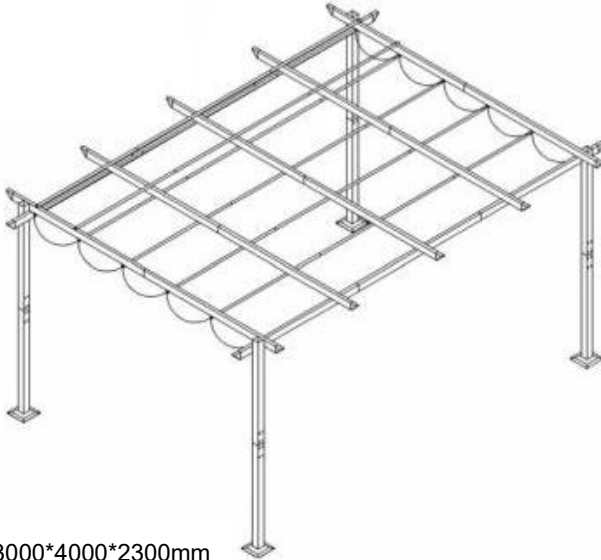

Product Size: 3000*4000*2300mm

NEED HELP? CONTACT US!

Have product questions? Need technical support? Please feel free to contact us:

Technical Support and E-Warranty Certificate
www.vevor.com/support

This is the original instruction, please read all manual instructions carefully before operating. VEVOR reserves a clear interpretation of our user manual. The appearance of the product shall be subject to the product you received. Please forgive us that we won't inform you again if there are any technology or software updates on our product.



Precauciones de seguridad

Lea estas instrucciones antes de usar este producto. De lo contrario, se pueden producir lesiones graves. Siempre se deben seguir las precauciones básicas , incluidas las siguientes:

¡TENGA EN CUENTA! Los dibujos de este manual son para Sólo con fines ilustrativos y en algunos detalles puede diferir del producto real.

Antes de ensamblar

Antes del montaje recomendamos:

6. Usar guantes.











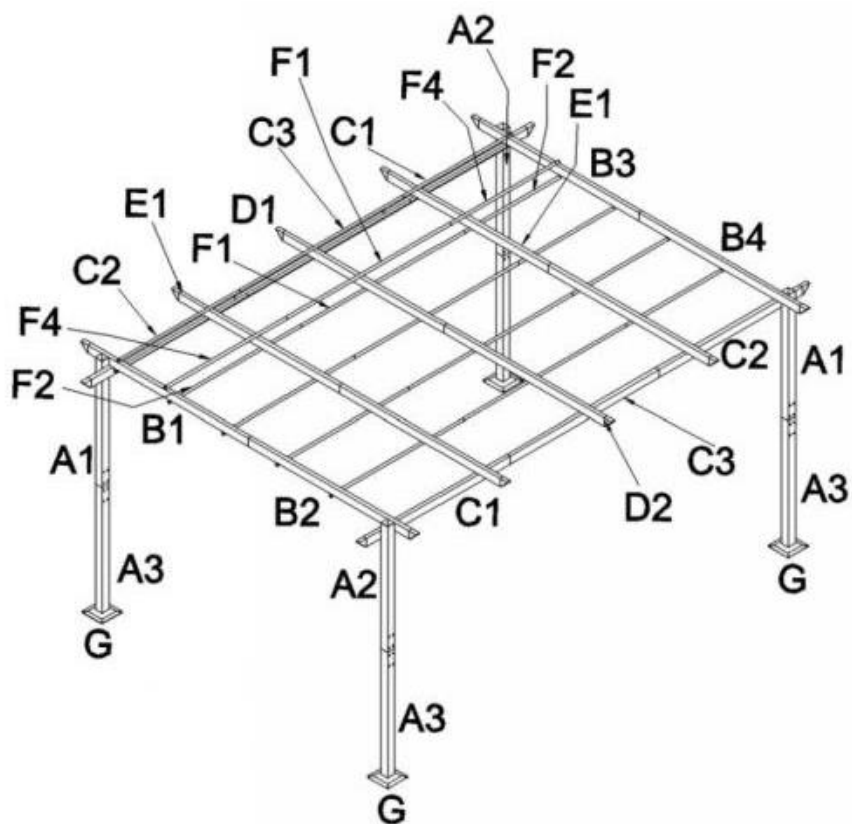

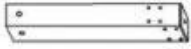
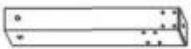





2.Herramientas recomendadas, taladro eléctrico con broca Phillips

























3.Recomendamos 4 personas para un montaje más fluido.

Lista de productos



| Item no. | Reference Image | Qty. | Item no. | Reference Image | Qty. |
|----------|---|------|----------|---|------|
| A1 |  | 2 | A2 |  | 2 |
| A3 |  | 4 | B1 |  | 1 |
| B2 |  | 1 | B3 |  | 1 |
| B4 |  | 1 | C1 |  | 2 |
| C2 |  | 2 | C3 |  | 2 |
| D1 |  | 1 | D2 |  | 1 |
| E1 |  | 4 | F1 |  | 8 |
| F2 |  | 12 | F4 |  | 4 |
| G |  | 4 | H |  | 3 |

| Item no. | Reference Image | Qty. | Item no. | Reference Image | Qty. |
|----------|---|------|----------|---|------|
| I |  | 6 | J |  | 8 |
| K |  | 1 | L |  | 5 |
| M |  | 12 | N |  | 2 |
| O |  | 14 | P |  | 4 |
| Q |  | 1 | R |  | 2 |
| S |  | 1 | T |  | 1 |
| U |  | 16 | V |  | 1 |
| W |  | 4 | | | |
| | | | | | |

| Item no. | Reference Image | Qty. | Item no. | Reference Image | Qty. |
|---|-----------------|------|---|-----------------|------|
|  | M6*10 | 24 |  | M6*15 | 134 |
|  | M6*30 | 4 |  | M6*75 | 6 |
|  | M6*40 | 3 |  | M6*15 | 32 |
|  | M6 | 64 | | | |
| | | | | | |
| | | | | | |
| | | | | | |
| | | | | | |
| | | | | | |
| | | | | | |

Descripción del Producto

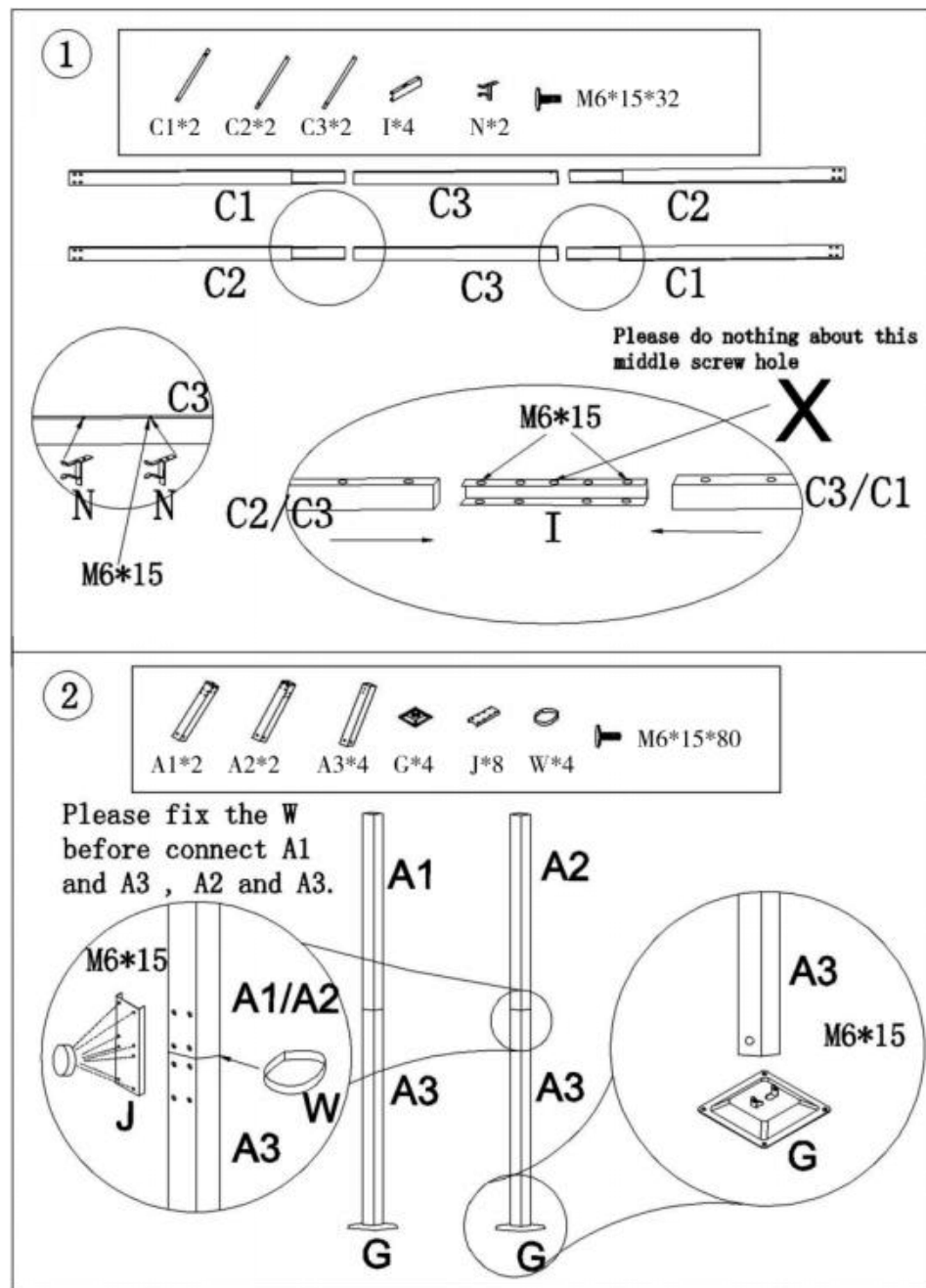

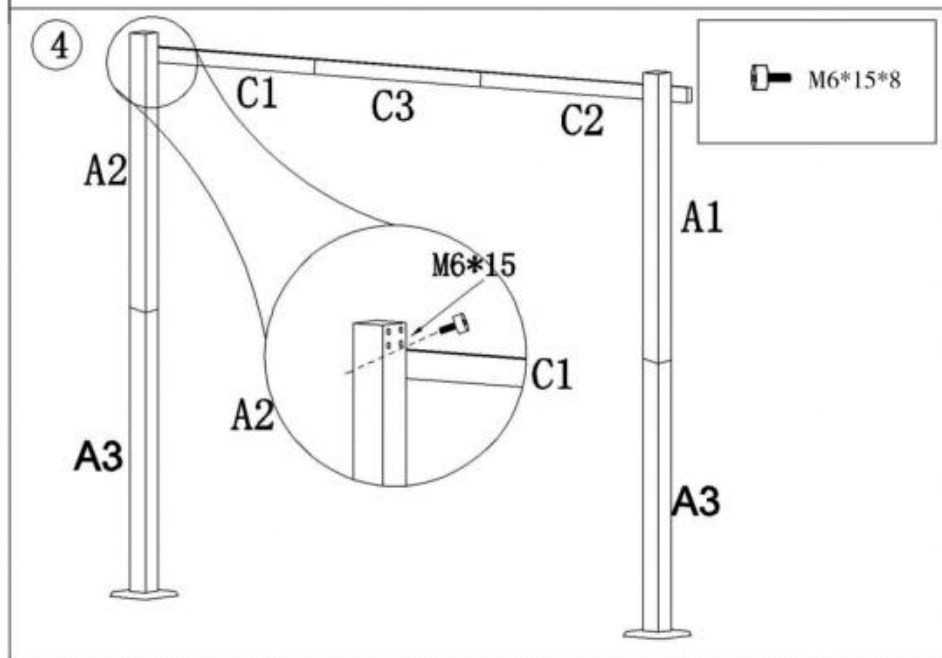
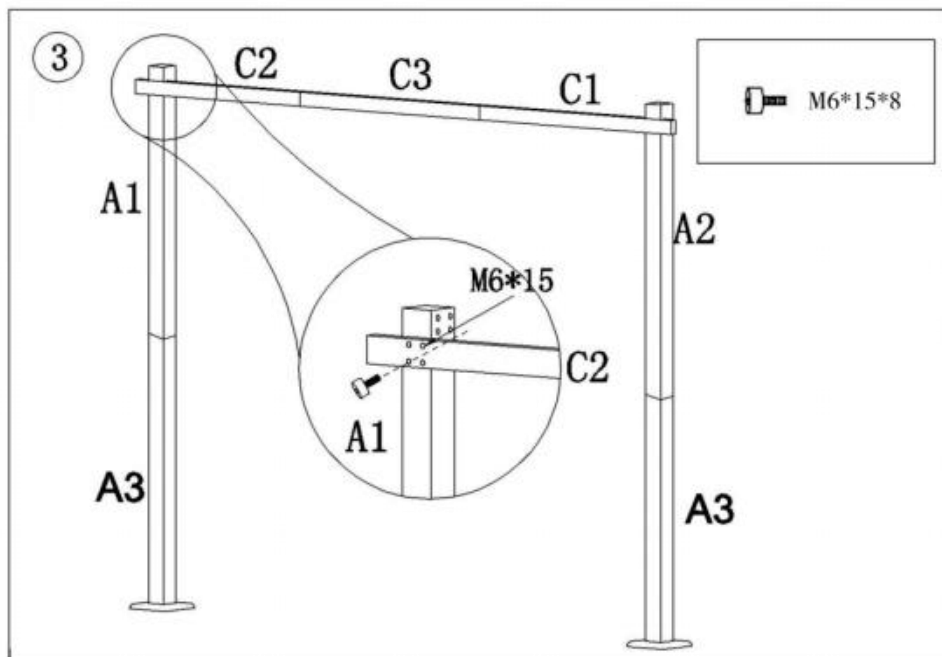

5

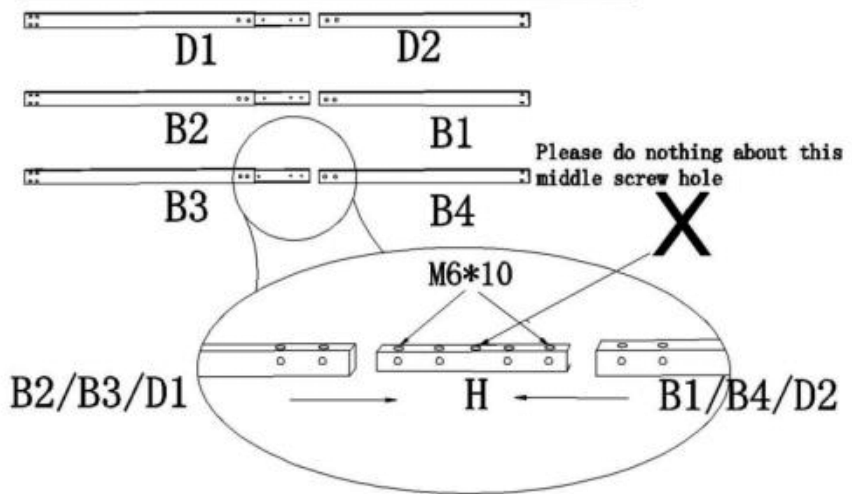
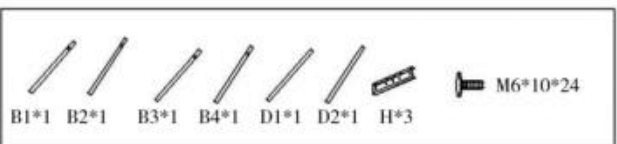

6

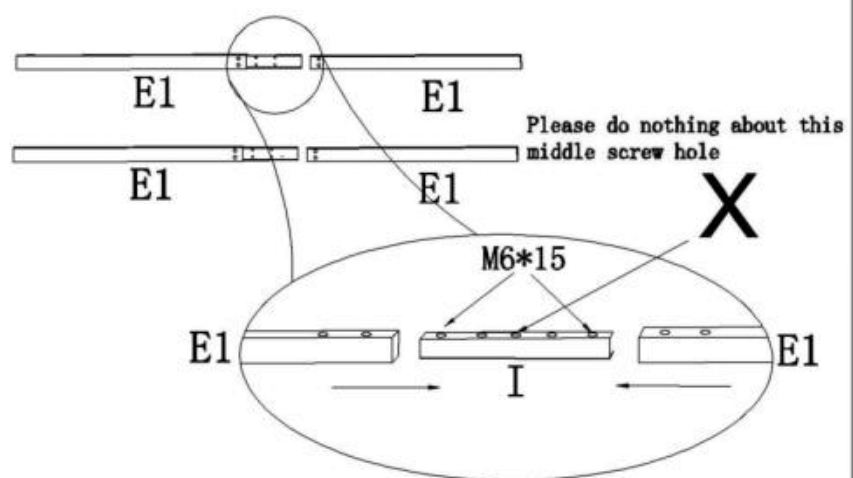
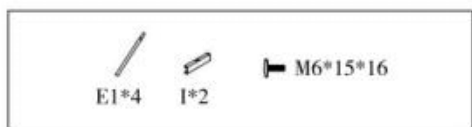

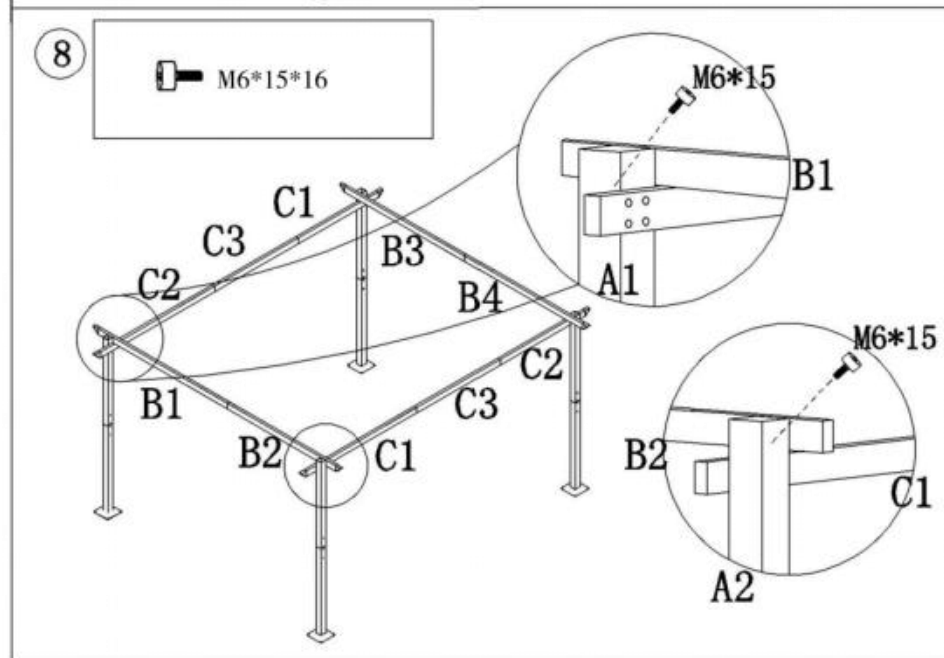
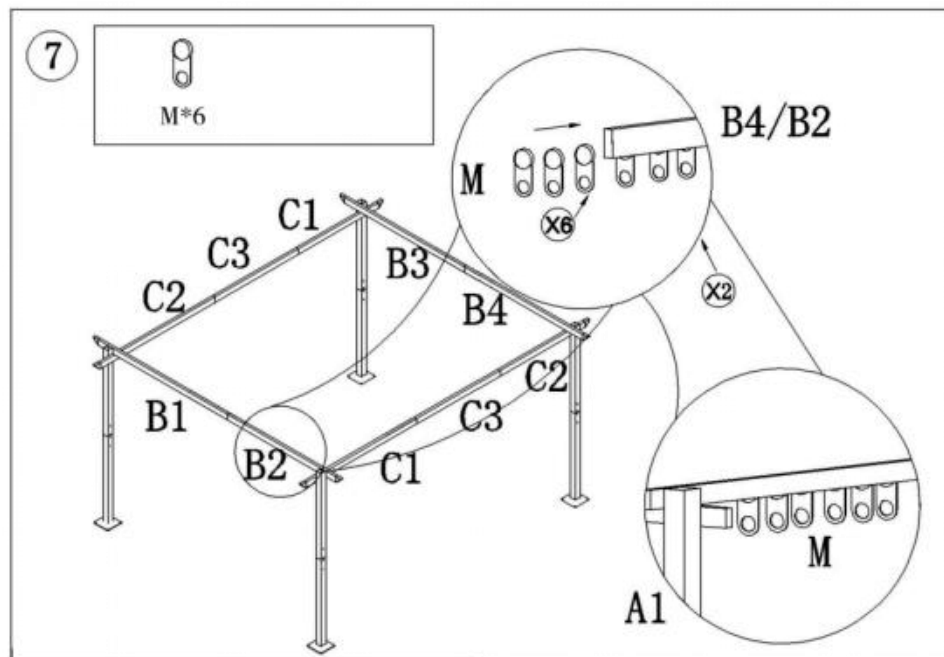

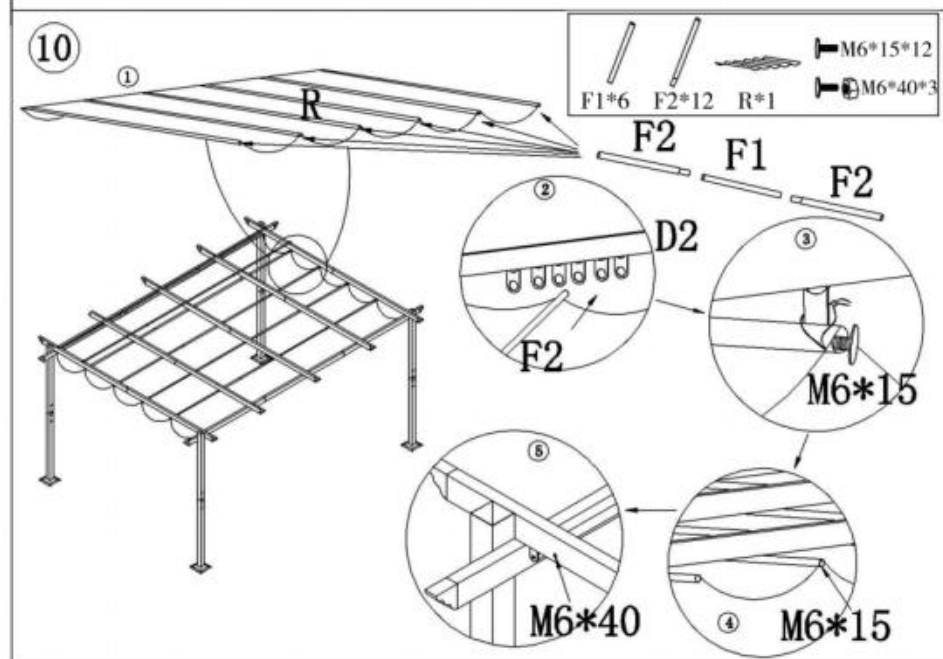
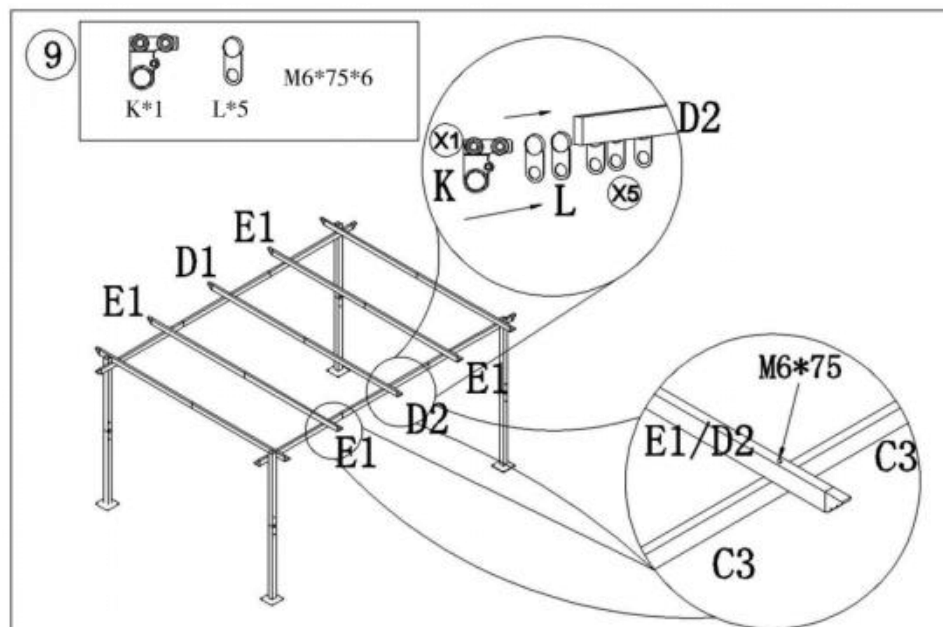

Nota: La tela superior tiene fugas agujeros (R)

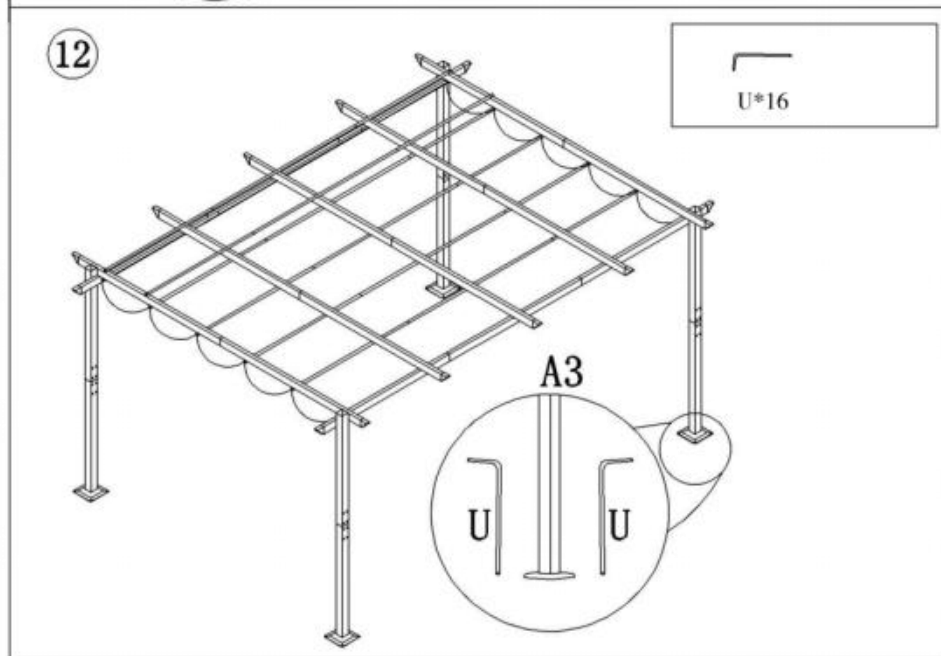
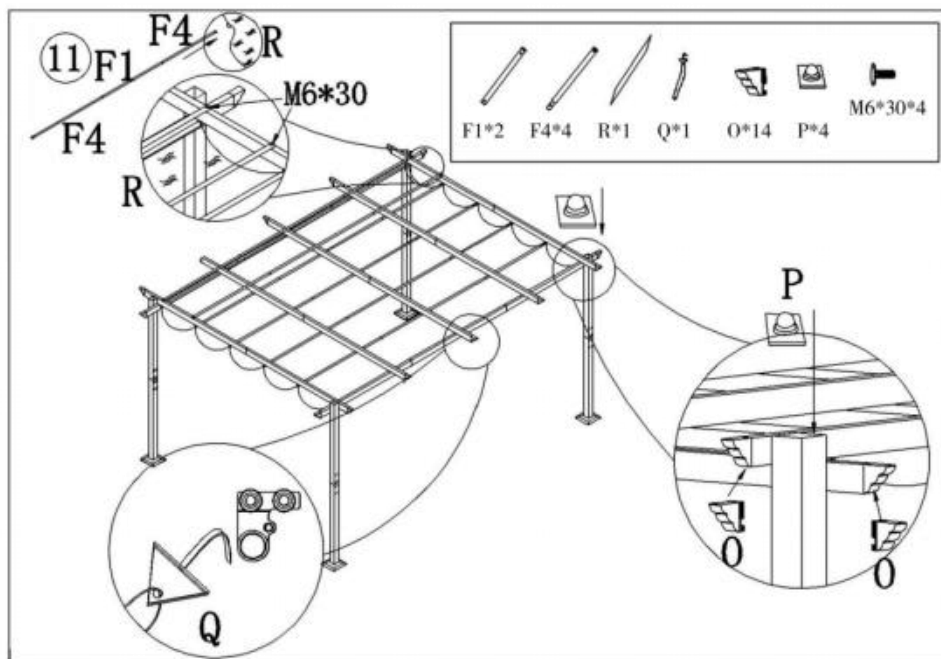

Fabricante : Shanghaimuxinmuyeyouxiangongsi

Dirección: Shuangchenglu 803nong11hao1602A-1609shi, baoshanqu, shanghai 200000 CN.

Importado a AUS: SIHAO PTY LTD. 1 ROKEVA STREET ASTWOOD NSW 2122 Australia

Importado a EE. UU.: Sanven Technology Ltd. Suite 250, 9166 Anaheim Lugar, Rancho Cucamonga, CA 91730

| | |
|-----------|------------|
| EC | REP |
|-----------|------------|

E-CrossStu GmbH

Mainzer Landstr.69, 60329 Frankfurt am Main.

| | |
|-----------|------------|
| UK | REP |
|-----------|------------|

YH CONSULTING LIMITED.

C/O YH Consulting Limited Office 147, Centurion House,
London Road, Staines-upon-Thames, Surrey, TW18 4AX

VEVOR[®]

TOUGH TOOLS, HALF PRICE

Técnico Certificado de soporte y garantía electrónica

www.vevor.com/support

VEVOR[®]

TOUGH TOOLS, HALF PRICE

Tecnico Supporto e certificato di garanzia elettronica www.vevor.com/support

PERGOLA RETRATTILE

MANUALE D'USO

We continue to be committed to provide you tools with competitive price.

"Save Half", "Half Price" or any other similar expressions used by us only represents an estimate of savings you might benefit from buying certain tools with us compared to the major top brands and does not necessarily mean to cover all categories of tools offered by us. You are kindly reminded to verify carefully when you are placing an order with us if you are actually saving half in comparison with the top major brands.

VEVOR®

TOUGH TOOLS, HALF PRICE

RETRACTABLE PERGOLA

MODELLO: JDG-098-34DGR / JDG-098-34DBL / JDG-098-34DBE

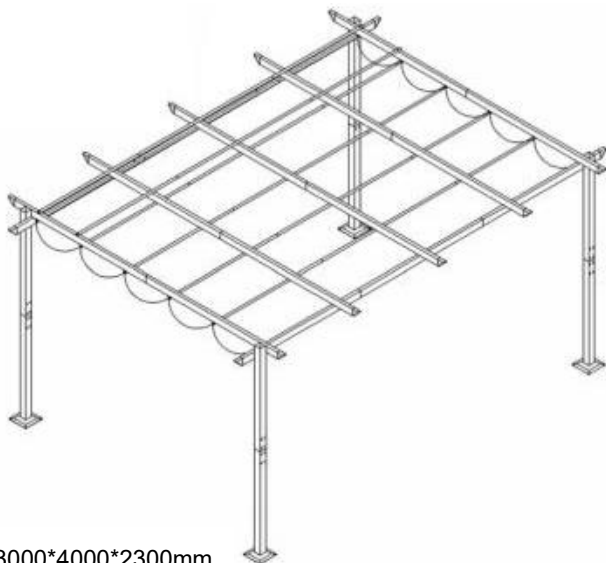

Product Size: 3000*4000*2300mm

NEED HELP? CONTACT US!

Have product questions? Need technical support? Please feel free to contact us:

Technical Support and E-Warranty Certificate
www.vevor.com/support

This is the original instruction, please read all manual instructions carefully before operating. VEVOR reserves a clear interpretation of our user manual. The appearance of the product shall be subject to the product you received. Please forgive us that we won't inform you again if there are any technology or software updates on our product.



Misure di sicurezza

Leggere queste istruzioni prima di utilizzare questo prodotto. In caso contrario si potrebbero causare lesioni gravi. È necessario seguire sempre le precauzioni di base, incluse le seguenti:

NOTARE CHE! I disegni contenuti in questo manuale servono solo a scopo illustrativo e in alcuni dettagli differire dal prodotto reale.

Prima dell'assemblaggio

Prima del montaggio consigliamo:

7. Indossare i guanti.











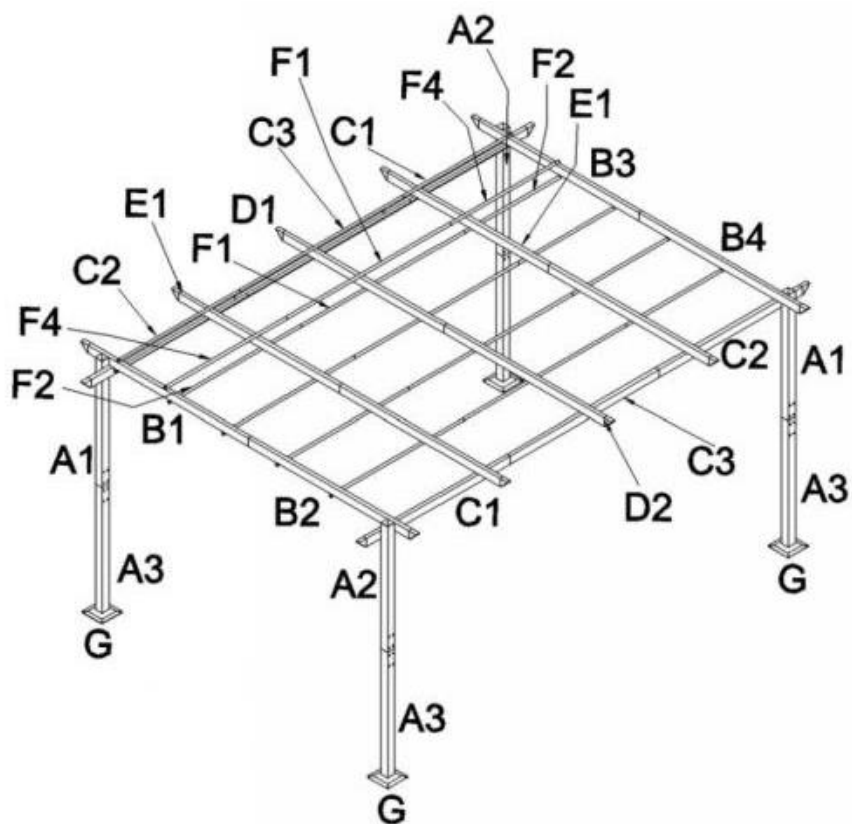

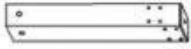
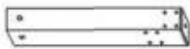





2. Strumenti consigliati, trapano elettrico con punta Phillips

























3. si consigliano 4 persone per un assemblaggio più fluido

Elenco prodotti



| Item no. | Reference Image | Qty. | Item no. | Reference Image | Qty. |
|----------|---|------|----------|---|------|
| A1 |  | 2 | A2 |  | 2 |
| A3 |  | 4 | B1 |  | 1 |
| B2 |  | 1 | B3 |  | 1 |
| B4 |  | 1 | C1 |  | 2 |
| C2 |  | 2 | C3 |  | 2 |
| D1 |  | 1 | D2 |  | 1 |
| E1 |  | 4 | F1 |  | 8 |
| F2 |  | 12 | F4 |  | 4 |
| G |  | 4 | H |  | 3 |

| Item no. | Reference Image | Qty. | Item no. | Reference Image | Qty. |
|----------|---|------|----------|---|------|
| I |  | 6 | J |  | 8 |
| K |  | 1 | L |  | 5 |
| M |  | 12 | N |  | 2 |
| O |  | 14 | P |  | 4 |
| Q |  | 1 | R |  | 2 |
| S |  | 1 | T |  | 1 |
| U |  | 16 | V |  | 1 |
| W |  | 4 | | | |
| | | | | | |

| Item no. | Reference Image | Qty. | Item no. | Reference Image | Qty. |
|---|-----------------|------|---|-----------------|------|
|  | M6*10 | 24 |  | M6*15 | 134 |
|  | M6*30 | 4 |  | M6*75 | 6 |
|  | M6*40 | 3 |  | M6*15 | 32 |
|  | M6 | 64 | | | |
| | | | | | |
| | | | | | |
| | | | | | |
| | | | | | |
| | | | | | |
| | | | | | |

Descrizione del prodotto

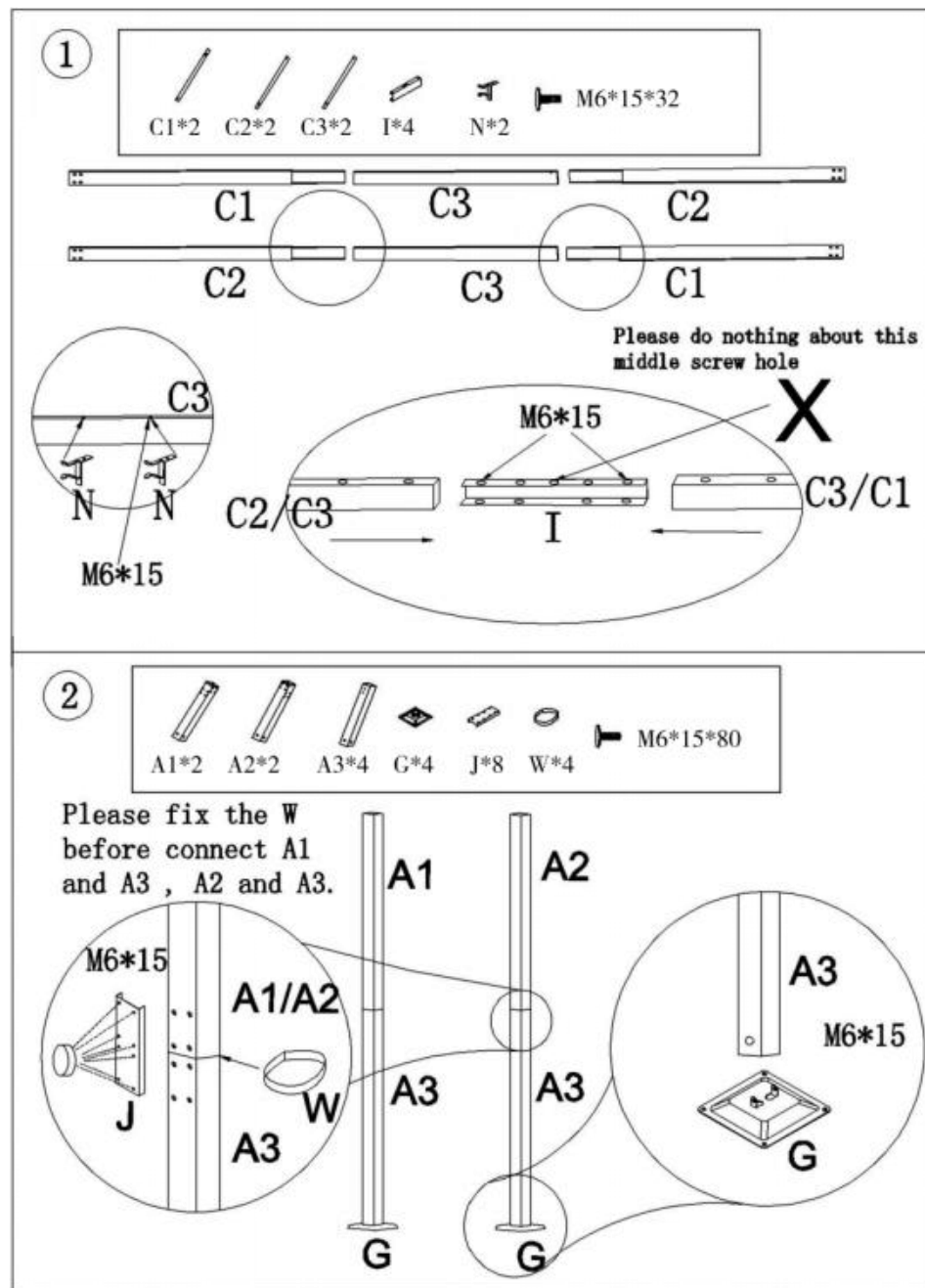

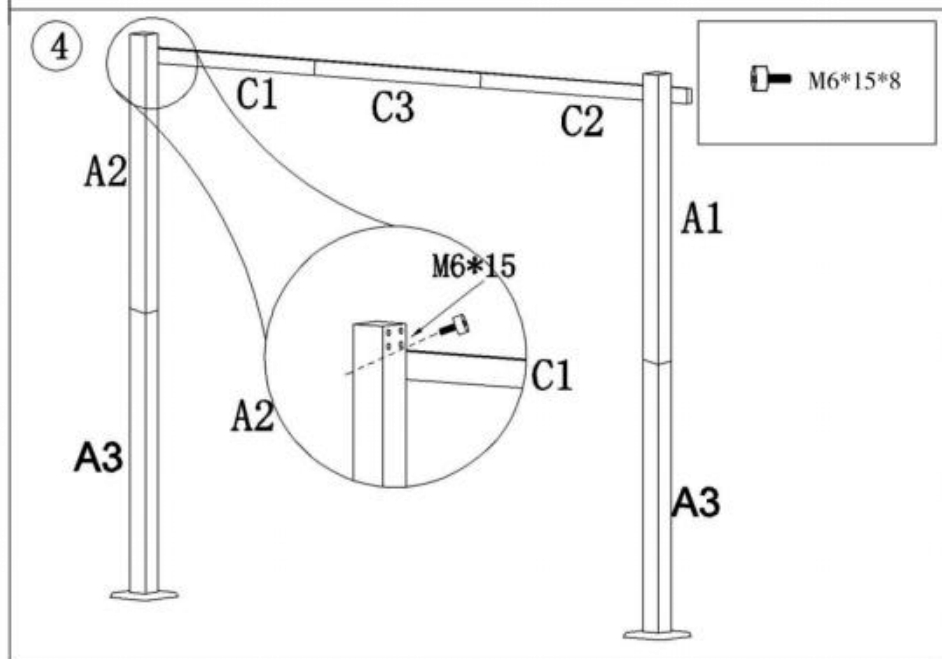
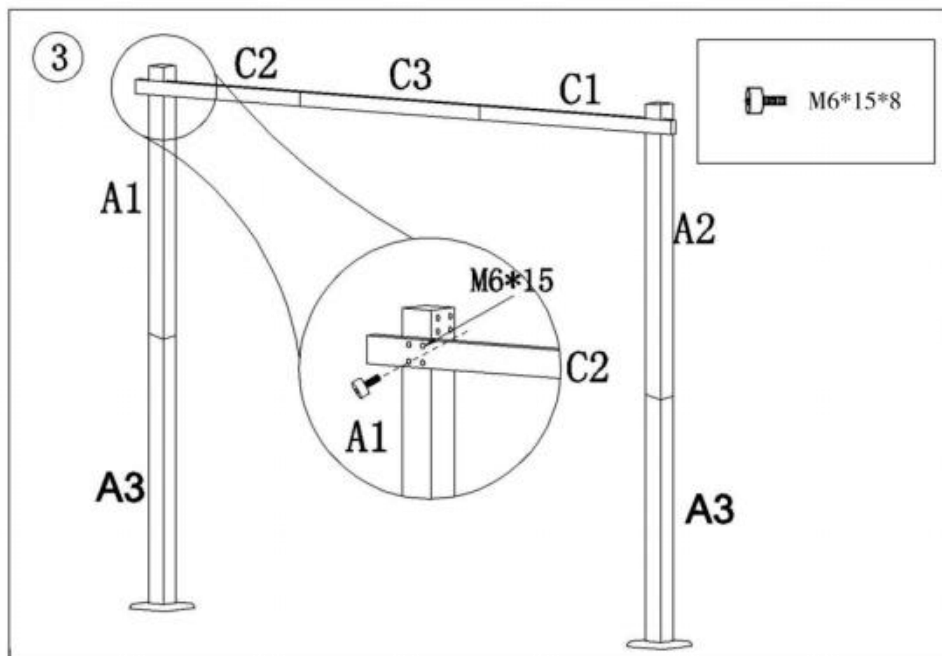

5

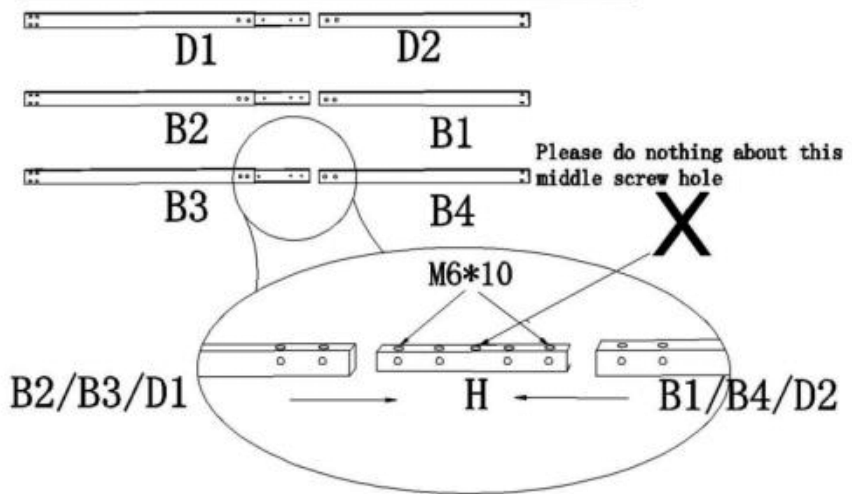
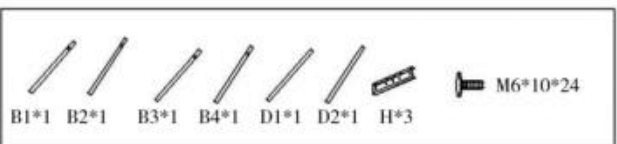

6

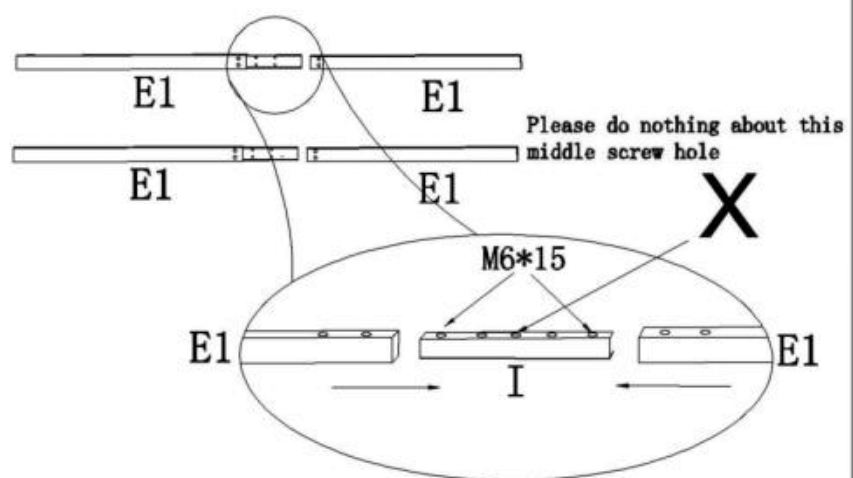
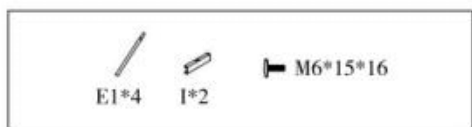

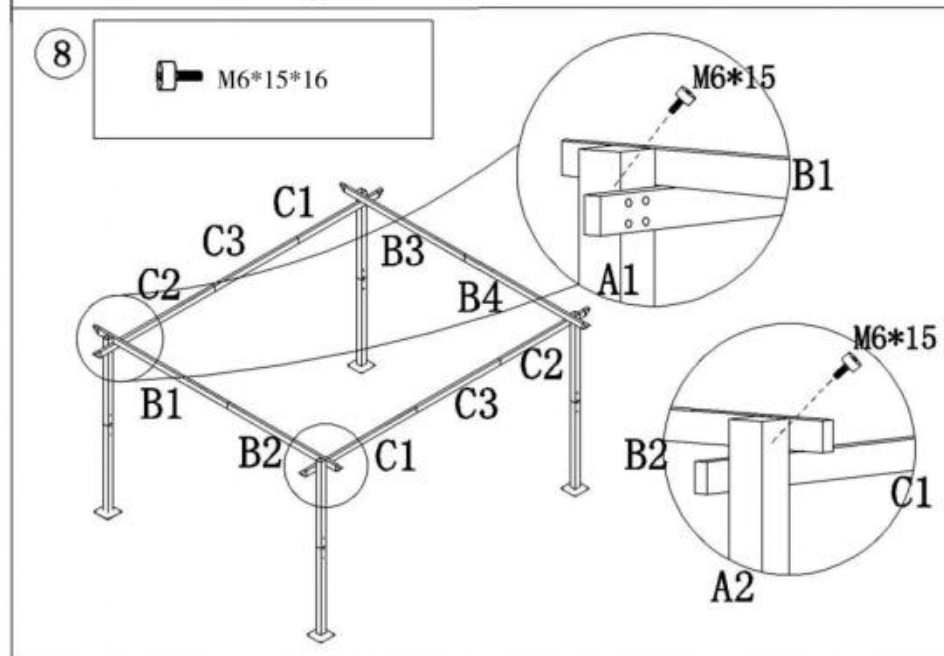
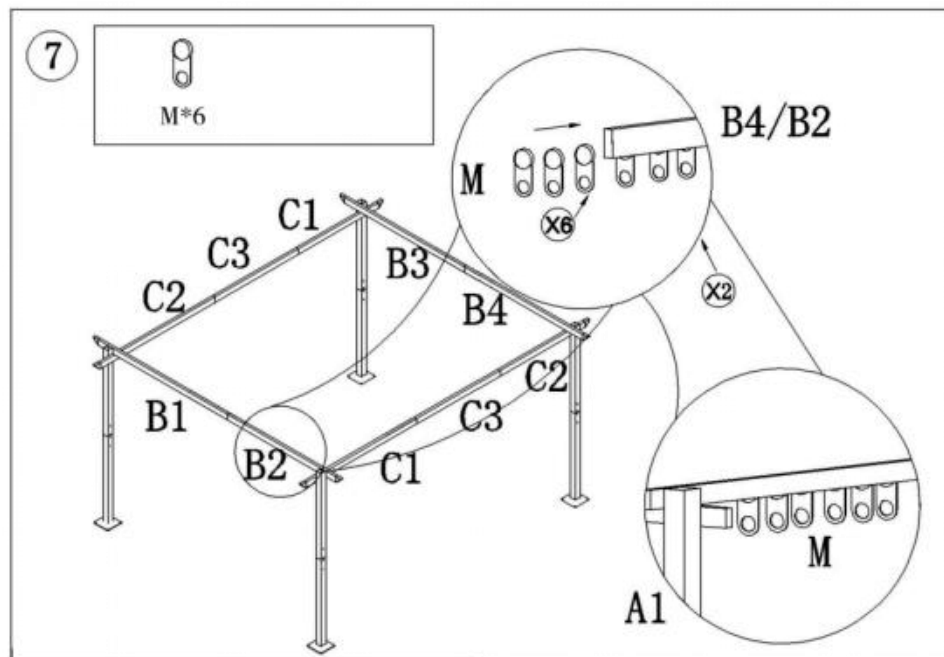

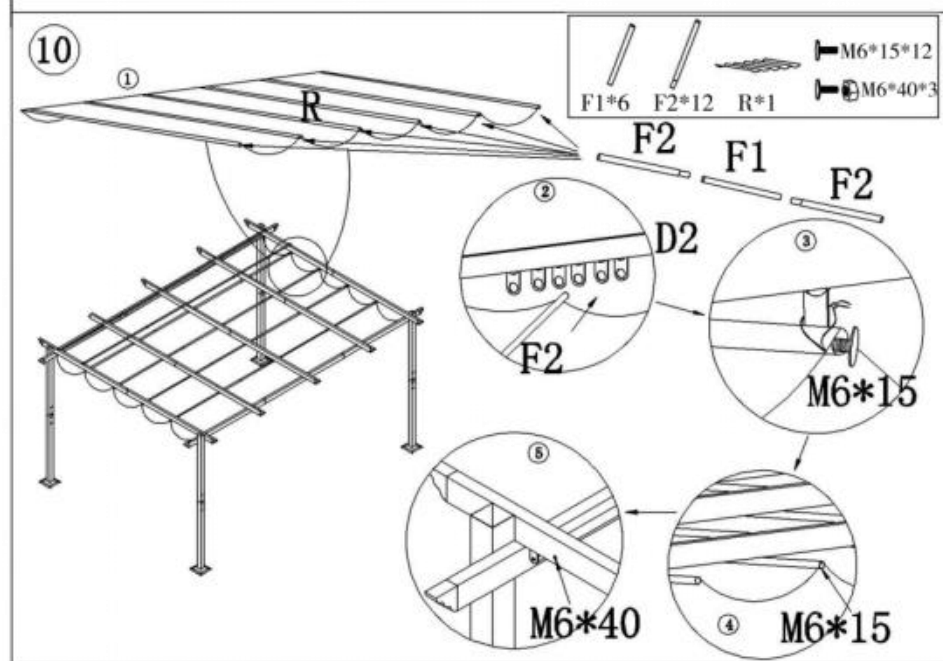
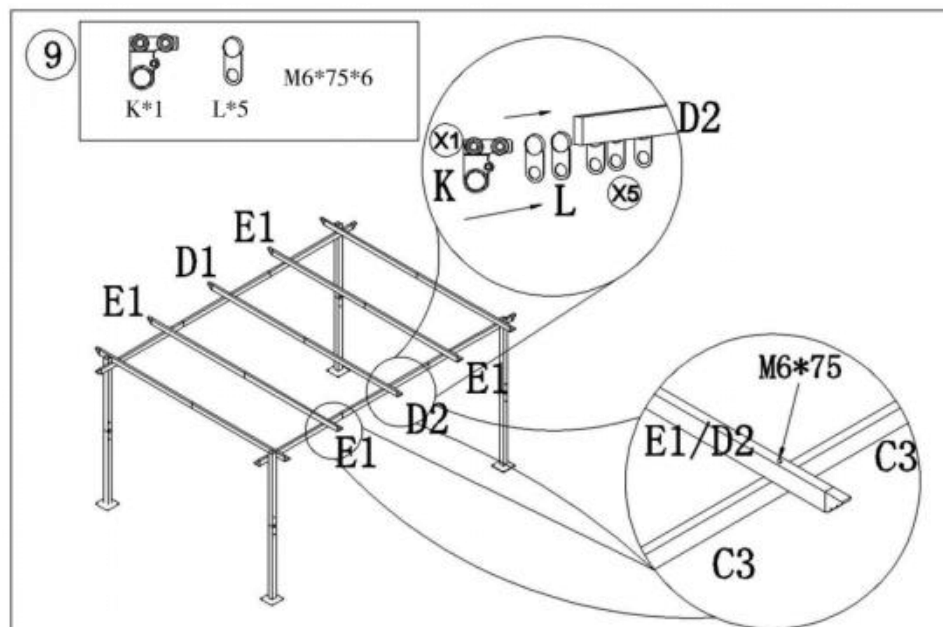

Nota: il tessuto superiore perde buchi (R)

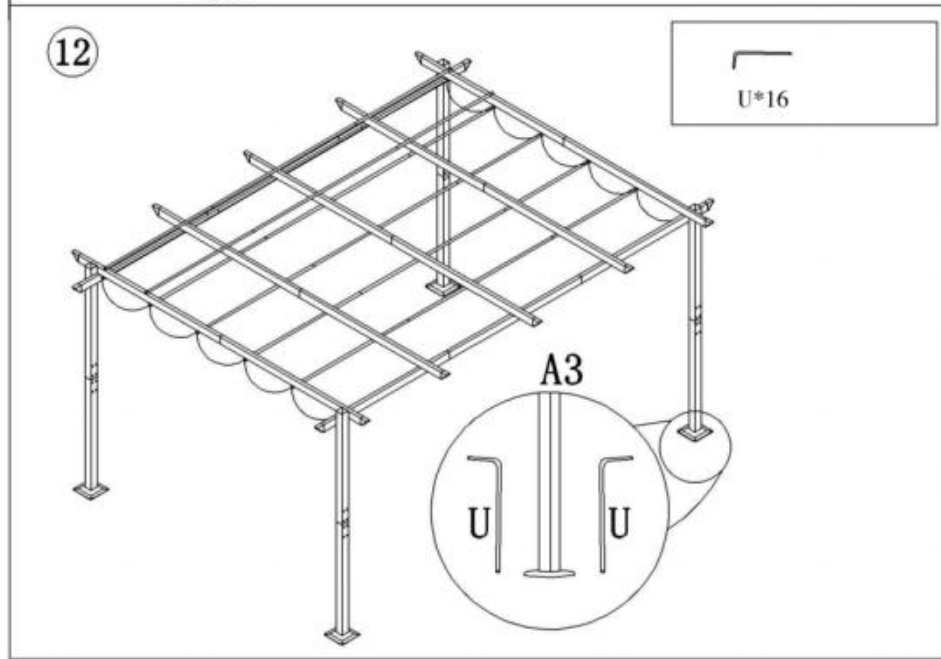
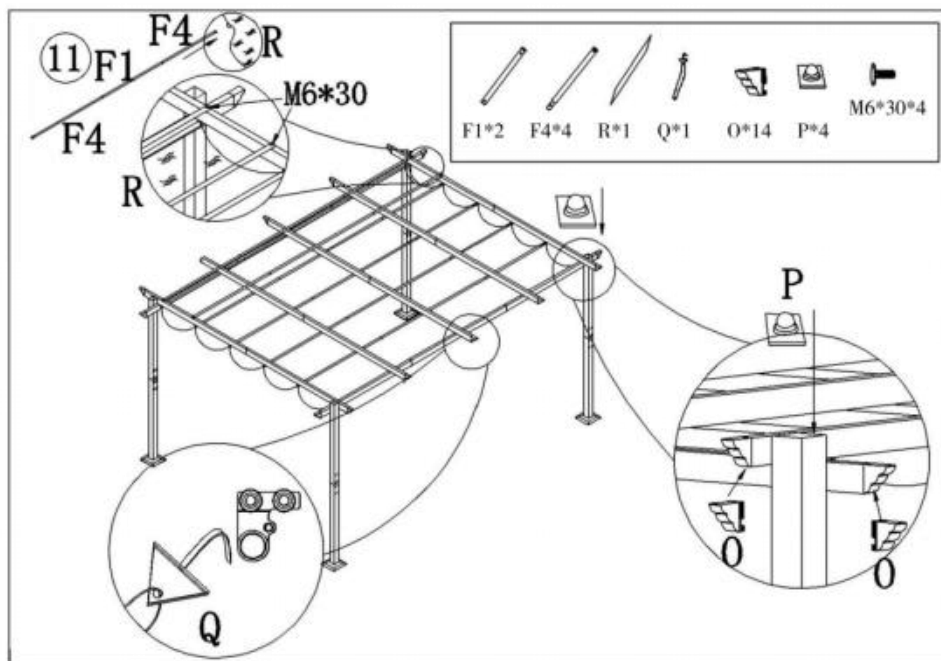

Produttore : Shanghaimuxinmuyeyouxiangongsi

Indirizzo: Shuangchenglu 803nong11hao1602A-1609shi, baoshanqu, shanghai 200000 CN.

Importato in AUS: SIHAO PTY LTD. 1 ROKEVA STREETEASTWOOD NSW 2122 Australia

Importato negli Stati Uniti: Sanven Technology Ltd. Suite 250, 9166 Anaheim

Luogo, Rancho Cucamonga, CA 91730

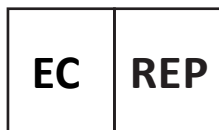

E-CrossStu GmbH

Mainzer Landstr.69, 60329 Frankfurt am Main.



YH CONSULTING LIMITED.

C/O YH Consulting Limited Office 147, Centurion House,
London Road, Staines-upon-Thames, Surrey, TW18 4AX

VEVOR[®]

TOUGH TOOLS, HALF PRICE

Tecnico Supporto e certificato di garanzia elettronica

www.vevor.com/support



Techniczny Certyfikat wsparcia i e-gwarancji www.vevor.com/support

WYSUWANA PERGOLA

INSTRUKCJA OBSŁUGI

We continue to be committed to provide you tools with competitive price.

"Save Half", "Half Price" or any other similar expressions used by us only represents an estimate of savings you might benefit from buying certain tools with us compared to the major top brands and does not necessarily mean to cover all categories of tools offered by us. You are kindly reminded to verify carefully when you are placing an order with us if you are actually saving half in comparison with the top major brands.

VEVOR®

TOUGH TOOLS, HALF PRICE

RETRACTABLE PERGOLA

MODELU: JDG-098-34DGR / JDG-098-34DBL / JDG-098-34DBE

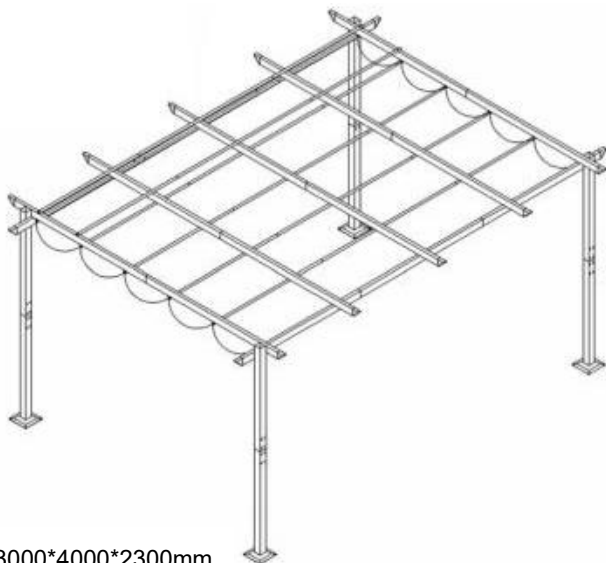

Product Size: 3000*4000*2300mm

NEED HELP? CONTACT US!

Have product questions? Need technical support? Please feel free to contact us:

Technical Support and E-Warranty Certificate
www.vevor.com/support

This is the original instruction, please read all manual instructions carefully before operating. VEVOR reserves a clear interpretation of our user manual. The appearance of the product shall be subject to the product you received. Please forgive us that we won't inform you again if there are any technology or software updates on our product.



Środki ostrożności

Przeczytaj tę instrukcję przed użyciem tego produktu. Niezastosowanie się do tego może spowodować poważne obrażenia. należy zawsze przestrzegać podstawowych środków ostrożności , w tym:

PROSZĘ ZANOTOWAĆ! Rysunki w tej instrukcji służą do: wyłącznie w celach ilustracyjnych i w niektórych szczegółach może różnić się od rzeczywistego produktu.

Przed montażem

Przed montażem zalecamy:

8. Nosić rękawiczki.











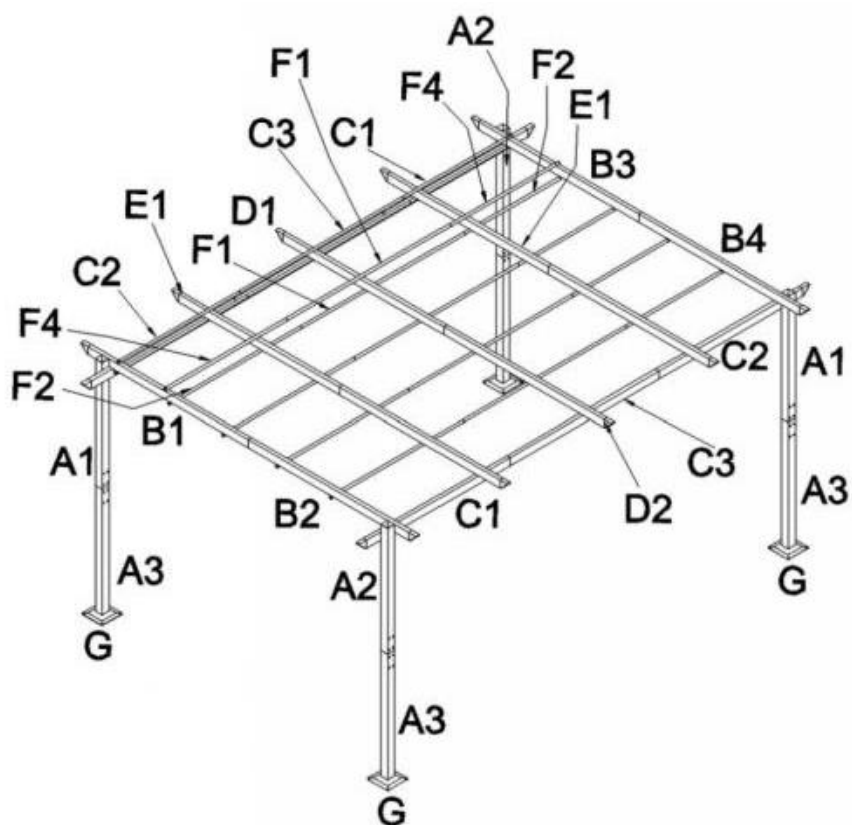

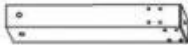







2. Zalecane narzędzia, wiertarka elektryczna z bitem krzyżakowym

























3. Dla płynniejszego montażu zalecamy udział 4 osób

Lista produktów



| Item no. | Reference Image | Qty. | Item no. | Reference Image | Qty. |
|----------|---|------|----------|---|------|
| A1 |  | 2 | A2 |  | 2 |
| A3 |  | 4 | B1 |  | 1 |
| B2 |  | 1 | B3 |  | 1 |
| B4 |  | 1 | C1 |  | 2 |
| C2 |  | 2 | C3 |  | 2 |
| D1 |  | 1 | D2 |  | 1 |
| E1 |  | 4 | F1 |  | 8 |
| F2 |  | 12 | F4 |  | 4 |
| G |  | 4 | H |  | 3 |

| Item no. | Reference Image | Qty. | Item no. | Reference Image | Qty. |
|----------|---|------|----------|---|------|
| I |  | 6 | J |  | 8 |
| K |  | 1 | L |  | 5 |
| M |  | 12 | N |  | 2 |
| O |  | 14 | P |  | 4 |
| Q |  | 1 | R |  | 2 |
| S |  | 1 | T |  | 1 |
| U |  | 16 | V |  | 1 |
| W |  | 4 | | | |
| | | | | | |

| Item no. | Reference Image | Qty. | Item no. | Reference Image | Qty. |
|---|-----------------|------|---|-----------------|------|
|  | M6*10 | 24 |  | M6*15 | 134 |
|  | M6*30 | 4 |  | M6*75 | 6 |
|  | M6*40 | 3 |  | M6*15 | 32 |
|  | M6 | 64 | | | |
| | | | | | |
| | | | | | |
| | | | | | |
| | | | | | |
| | | | | | |
| | | | | | |

Opis produktu

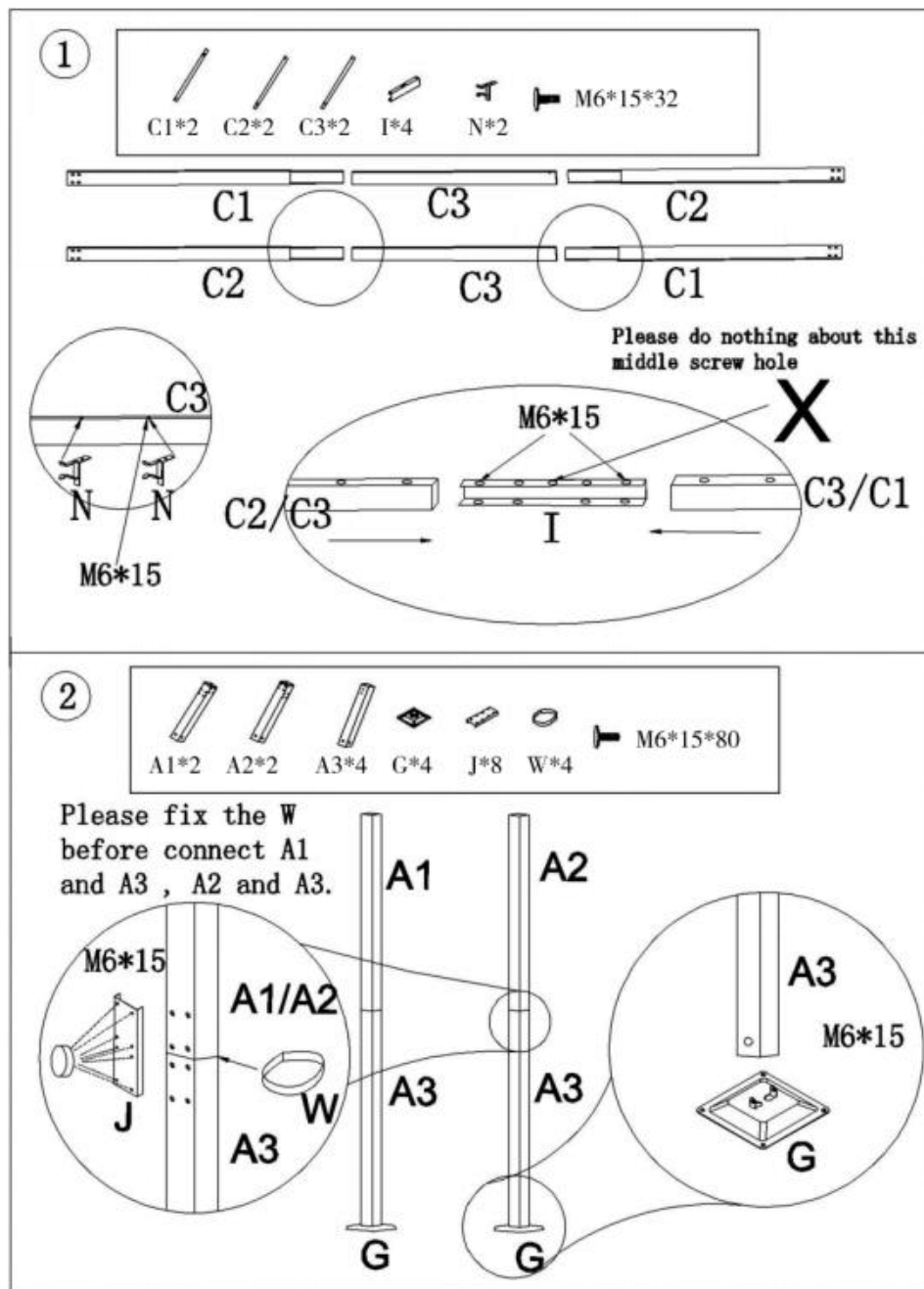

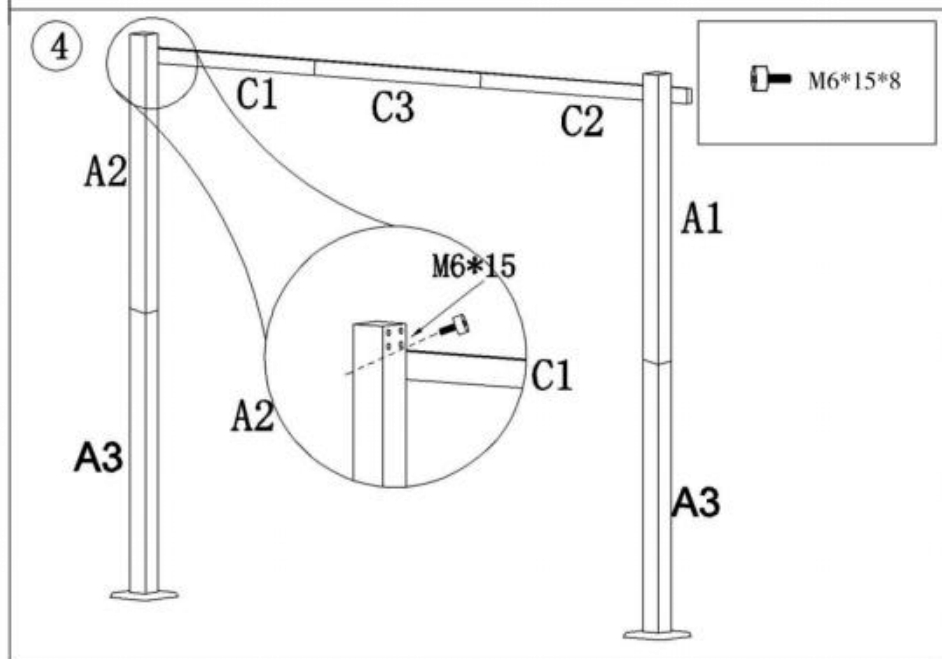
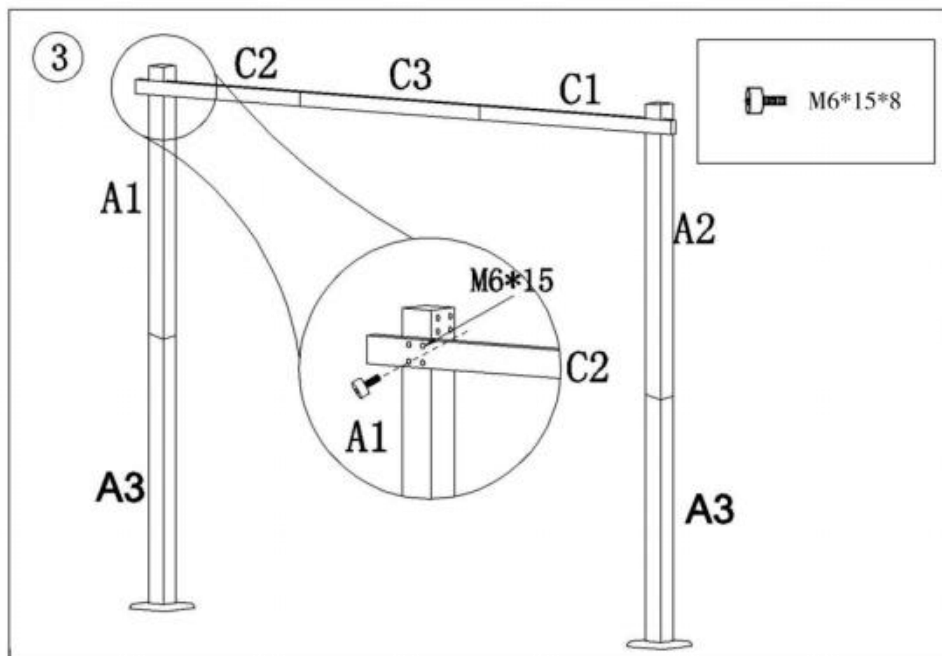

5

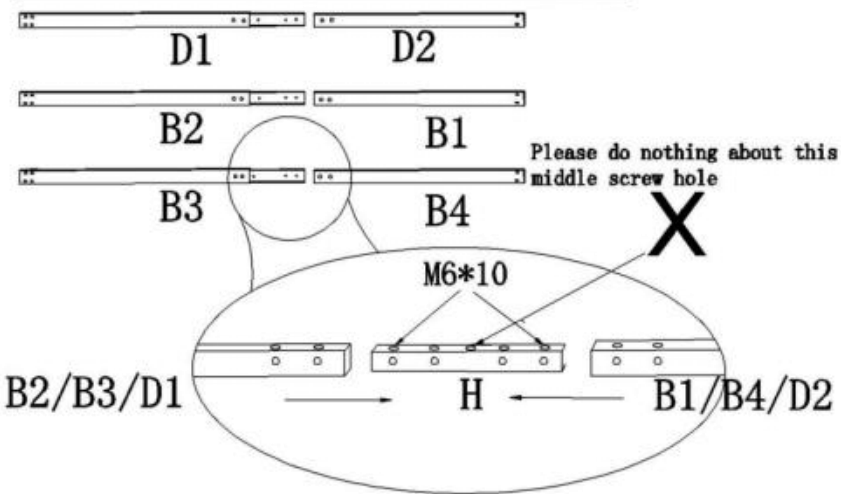
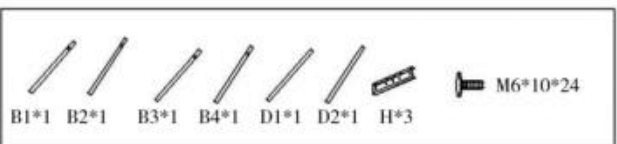

6

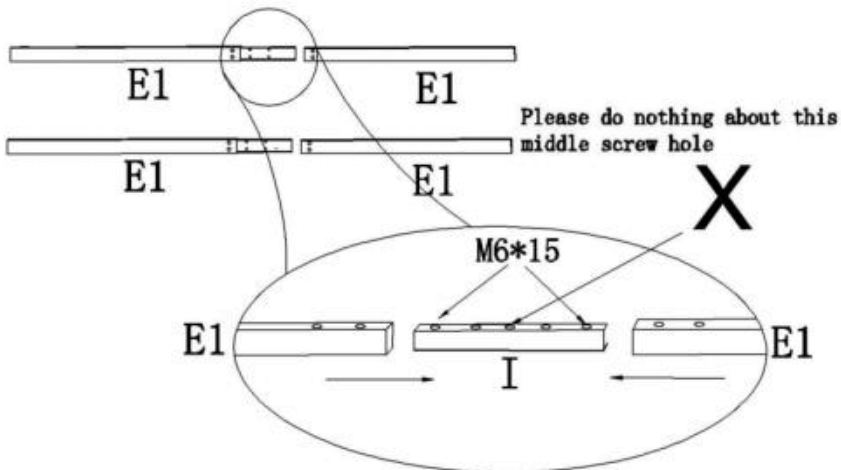
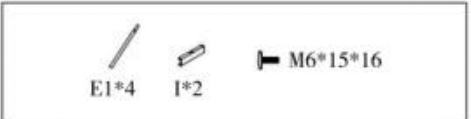

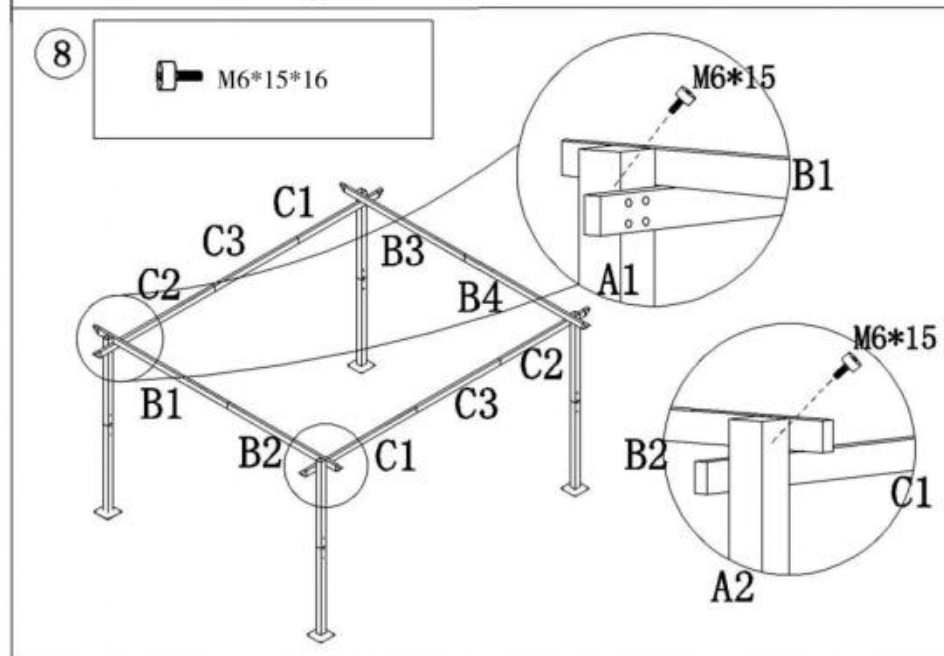
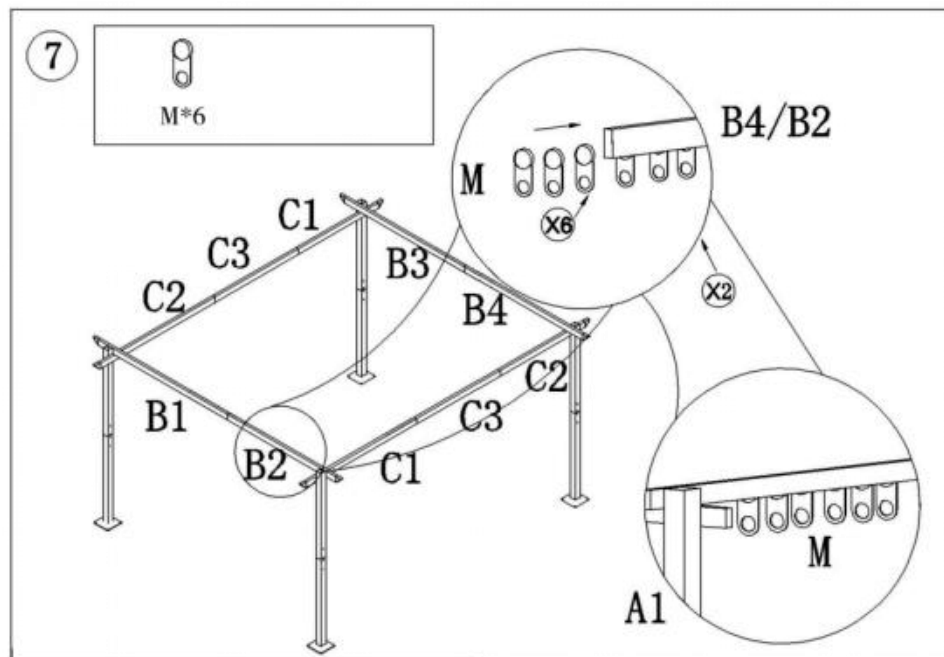

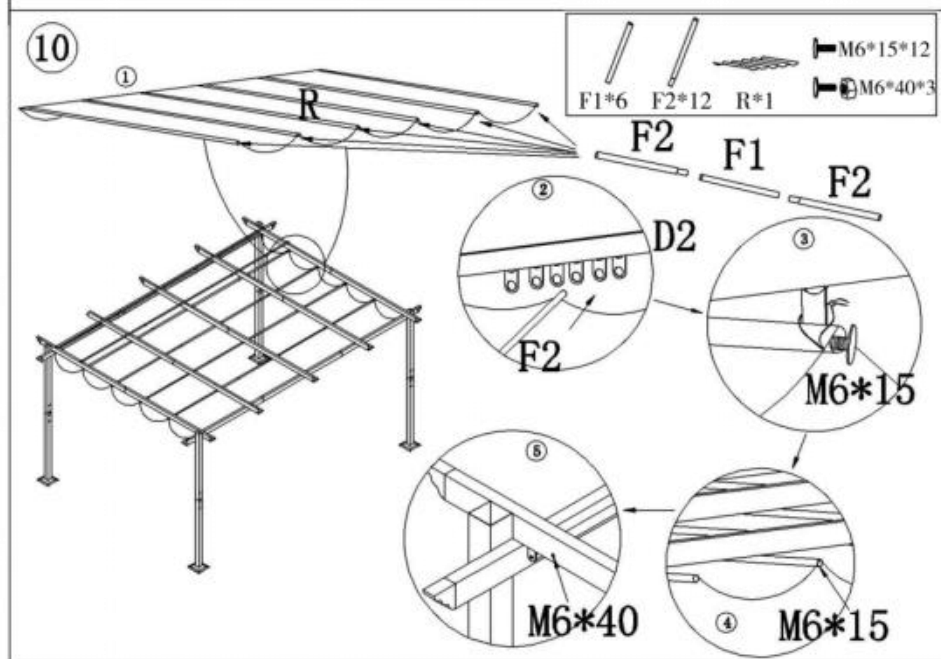
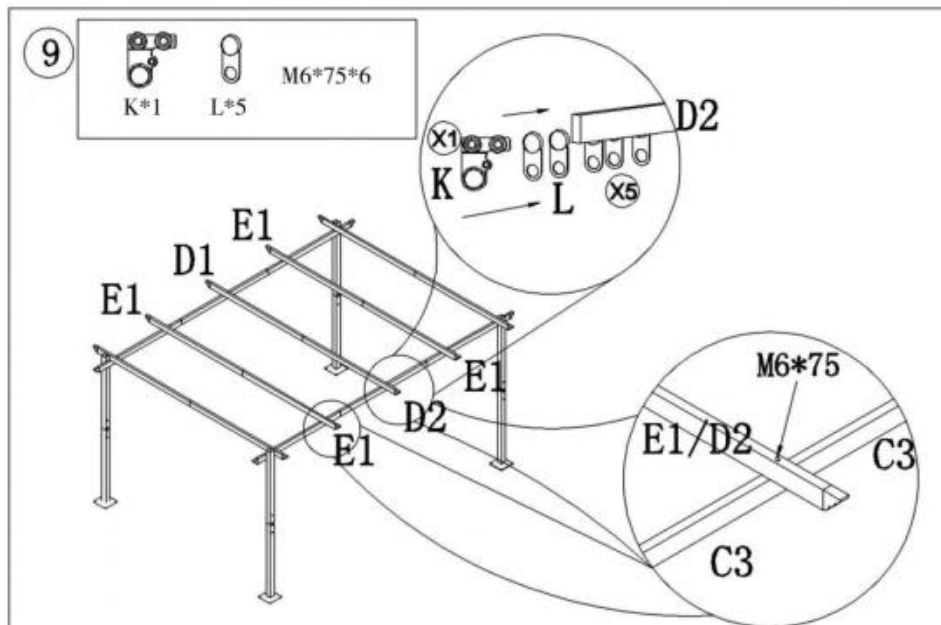

Uwaga: górna tkanina przecieka h oles (R)

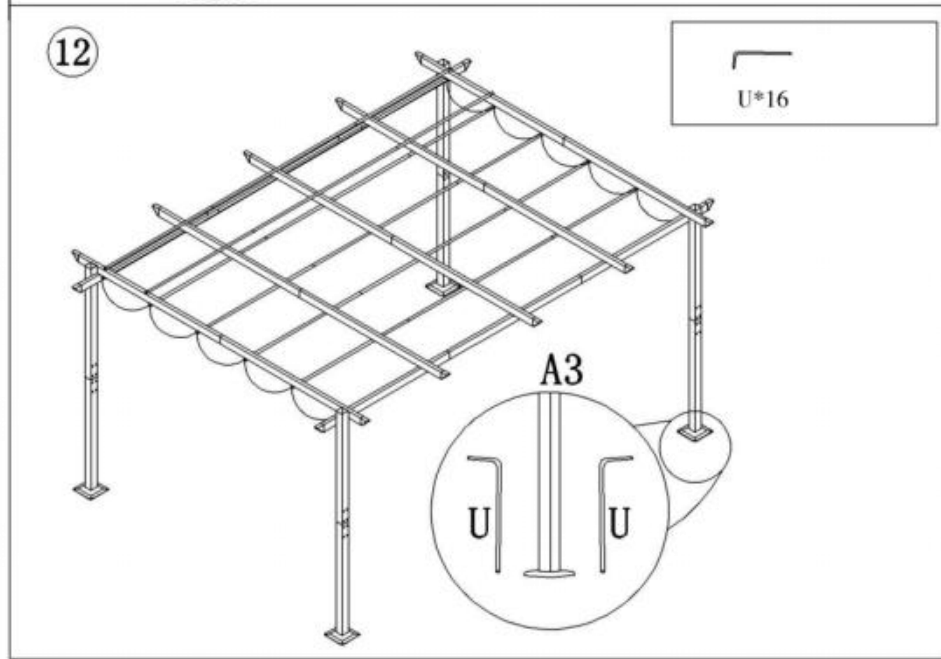
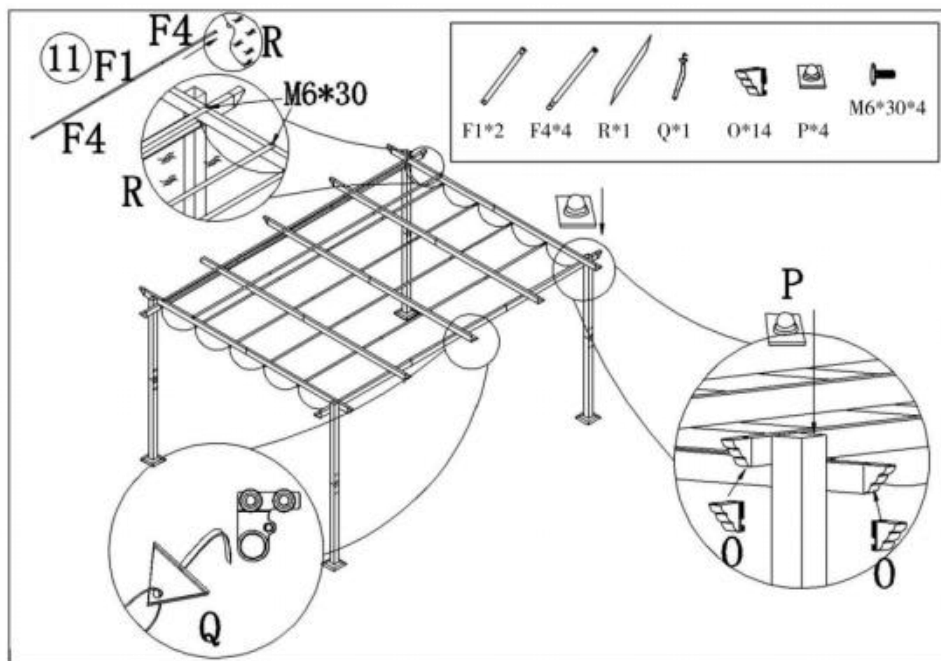

Producent : Shanghaimuxinmuyeyouxiangongsi

Adres: Shuangchenglu 803nong11hao1602A-1609shi, baoshanqu, szanghaj 200000 CN.

Import do AUS: SIHAO PTY LTD. 1 ROKEVA STREETEASTWOOD NSW 2122 Australia

Import do USA: Sanven Technology Ltd. Suite 250, 9166 Anaheim Place, Rancho Cucamonga, Kalifornia 91730

| | |
|-----------|------------|
| EC | REP |
|-----------|------------|

E-CrossStu GmbH

Mainzer Landstr.69, 60329 Frankfurt am Main.

| | |
|-----------|------------|
| UK | REP |
|-----------|------------|

YH CONSULTING LIMITED.

C/O YH Consulting Limited Office 147, Centurion House,
London Road, Staines-upon-Thames, Surrey, TW18 4AX

VEVOR[®]

TOUGH TOOLS, HALF PRICE

Techniczny Certyfikat wsparcia i e-gwarancji

www.vevor.com/support