

VEVOR[®]

TOUGH TOOLS, HALF PRICE

Technical Support and E-Warranty Certificate www.vevor.com/support

PIPE WRENCH USER MANUAL

MODEL: TD0520 14" & TD0520 18"

We continue to be committed to provide you tools with competitive price. "Save Half", "Half Price" or any other similar expressions used by us only represents an estimate of savings you might benefit from buying certain tools with us compared to the major top brands and does not necessarily mean to cover all categories of tools offered by us. You are kindly reminded to verify carefully when you are placing an order with us if you are actually saving half in comparison with the top major brands.

VEVOR®

TOUGH TOOLS, HALF PRICE

PIPE WRENCH

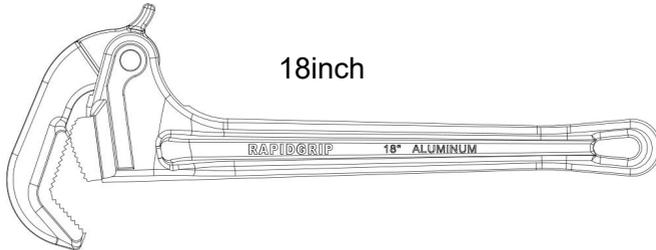
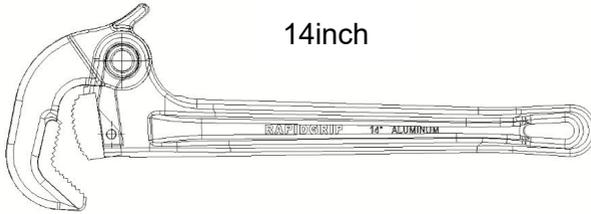

Note: The actual product you receive determines its look.

NEED HELP? CONTACT US!

Have product questions? Need technical support? Please feel free to contact us:

Technical Support and E-Warranty Certificate
www.vevor.com/support

This is the original instruction, please read all manual instructions carefully before operating. VEVOR reserves a clear interpretation of our user manual. The appearance of the product shall be subject to the product you received. Please forgive us that we won't inform you again if there are any technology or software updates on our product.

Important safety instructions

	Warning - To reduce the risk of injury, user must read instructions manual carefully.
	Warning- Be sure to wear ear protectors when using this product.
	Warning- Be sure to wear eye protectors when using this product.
	Warning- Be sure to wear dust masks when using this product.
	Warning- Be sure to wear gloves when using this product.

WARNING!

1. Use the product only after receiving professional metalworking training.
2. Wear necessary personal protective equipment such as safety goggles, earplugs, and protective gloves during use.
3. Ensure that the workspace remains clean, dry, and well-ventilated during operation.
4. keep away from children.

2. Product Introduce

The clamp head and tooth block are forged with high quality chromium vanadium steel, the whole heat treatment, the teeth laser quenching, the hardness can reach 52HRC or more,easy to adjust the upper and lower bite clamp tooth design, the clamping force is stronger.the clamp body is made of aluminum alloy material, large torque, save effort,The handle is

ergonomic, more lightweight and comfortable.

This product is mainly used to tighten and loosen pipes, pipe fittings and other cylindrical workpieces. The biggest feature of the fast pipe clamp is that there is no nut, and it can automatically adjust the size of the clamp mouth, eliminating the manual adjustment process, and greatly improving the work efficiency.

3. Product Structure (14inch for refer)

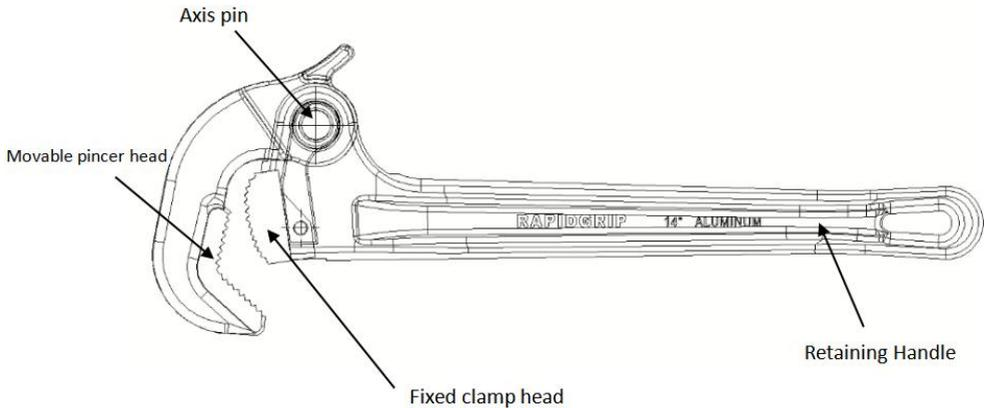

4. Instructions and precautions for use

1. Hold the handle with one hand, press the head and tail of the pliers to open the mouth, release the head and tail of the pliers after clamping the pipe, and press the tail of the handle clockwise.
2. This product is not intended for use with electrically charged objects
3. Always wear protective tools when using
4. This product has sharp teeth and heavy weight, please pay attention to safety when using at high altitude.
5. Please grease the jaws for a long time to prevent rust.
6. when using pipe clamp, it is not allowed to hammer on the clamp handle, sleeve or long clamp handle and other overload use, not allowed to use tractors, winches and other mechanical drag overload use, so as to avoid unsafe accidents

7.when using, it is not allowed to replace the hammer, so as not to damage the parts and affect the use.

5. Parameter

Items	Model	TD0520 14''	TD0520 18''
1	Maximum Overall Length	14inch	18inch
2	Crimping Range	Φ 17mm-Φ 48mm	Φ 27mm-Φ 89mm
3	Plier Jaws Hardness	≥52HRC	≥52HRC
4	I-Beam Handle	√	√

6. Maintenance

Pay attention to storage and maintenance, and do not place it in an environment that may easily cause rust.

Manufacturer:Shanghaimuxinmuyeyouxiangongsi

Address: Shuangchenglu 803nong11hao1602A-1609shi, baoshanqu, shanghai 200000 CN.

Imported to AUS: SIHAO PTY LTD. 1 ROKEVA STREETEASTWOOD NSW 2122 Australia

Imported to USA: Sanven Technology Ltd. Suite 250, 9166 Anaheim Place, Rancho Cucamonga, CA 91730

UK	REP
-----------	------------

E-CrossStu GmbH

Mainzer Landstr.69, 60329 Frankfurt am Main.

EC	REP
-----------	------------

YH CONSULTING LIMITED.

C/O YH Consulting Limited Office 147, Centurion House,
London Road, Staines-upon-Thames, Surrey, TW18 4AX

VEVOR[®]

TOUGH TOOLS, HALF PRICE

Technical Support and E-Warranty Certificate

www.vevor.com/support

VEVOR[®]

TOUGH TOOLS, HALF PRICE

Technisch Ondersteuning en e-garantiecertificaat www.vevor.com/support

PIJPTANG GEBRUIKERSHANDLEIDING

MODEL: TD05 20 14" & TD0520 18"

We continue to be committed to provide you tools with competitive price. "Save Half", "Half Price" or any other similar expressions used by us only represents an estimate of savings you might benefit from buying certain tools with us compared to the major top brands and does not necessarily mean to cover all categories of tools offered by us. You are kindly reminded to verify carefully when you are placing an order with us if you are actually saving half in comparison with the top major brands.

VEVOR[®]

TOUGH TOOLS, HALF PRICE

PIPE WRENCH

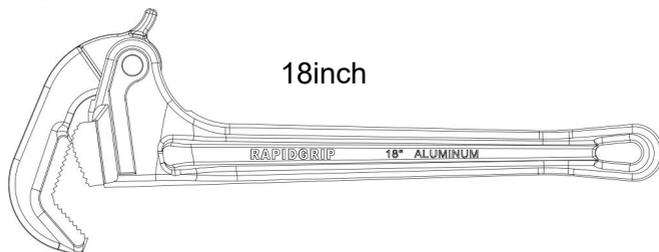
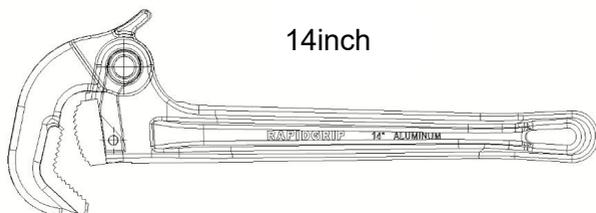

Let op: Het daadwerkelijke product dat u ontvangt, bepaalt de uitstraling.

NEED HELP? CONTACT US!

Have product questions? Need technical support? Please feel free to contact us:

Technical Support and E-Warranty Certificate
www.vevor.com/support

This is the original instruction, please read all manual instructions carefully before operating. VEVOR reserves a clear interpretation of our user manual. The appearance of the product shall be subject to the product you received. Please forgive us that we won't inform you again if there are any technology or software updates on our product.

Belangrijke veiligheidsinstructies

	Waarschuwing - Om het risico op letsel te verminderen, moet de gebruiker de handleiding zorgvuldig lezen.
	Waarschuwing- Zorg ervoor dat u gehoorbeschermers draagt wanneer u dit product gebruikt.
	Waarschuwing- Zorg ervoor dat u oogbeschermers draagt wanneer u dit product gebruikt.
	Waarschuwing- Zorg ervoor dat u stofmaskers draagt wanneer u dit product gebruikt.
	Waarschuwing- Zorg ervoor dat u handschoenen draagt wanneer u dit product gebruikt.

WAARSCHUWING!

5. Gebruik het product uitsluitend na een professionele opleiding metaalbewerking.
6. Draag tijdens het gebruik de noodzakelijke persoonlijke beschermingsmiddelen, zoals een veiligheidsbril, oordopjes en beschermende handschoenen.
7. Zorg ervoor dat de werkruimte tijdens het gebruik schoon, droog en goed geventileerd blijft.
8. blijf uit de buurt van kinderen .

2. Productintroductie

De klem kop en tandblok zijn gesmeed met hoogwaardig chroomvanadiumstaal, de hele warmtebehandeling, de tanden laserdoven, de hardheid kan 52HRC of meer bereiken , eenvoudig aan te passen het bovenste en onderste bijtklemtandontwerp, de klemkracht is sterker.

klemlichaam is gemaakt van aluminiumlegering, groot koppel, bespaart moeite, het handvat is ergonomisch, lichter en comfortabeler. Dit product wordt voornamelijk gebruikt voor het vast- en losmaken van buizen, buisfittingen en andere cilindrische werkstukken. Het grootste kenmerk van de snelle buisklem is dat er geen moer is en dat deze automatisch de grootte van de klemmond kan aanpassen, waardoor het handmatige aanpassingsproces wordt geëlimineerd en de werkefficiëntie aanzienlijk wordt verbeterd.

3.Productstructuur (14 inch voor verwijzing)

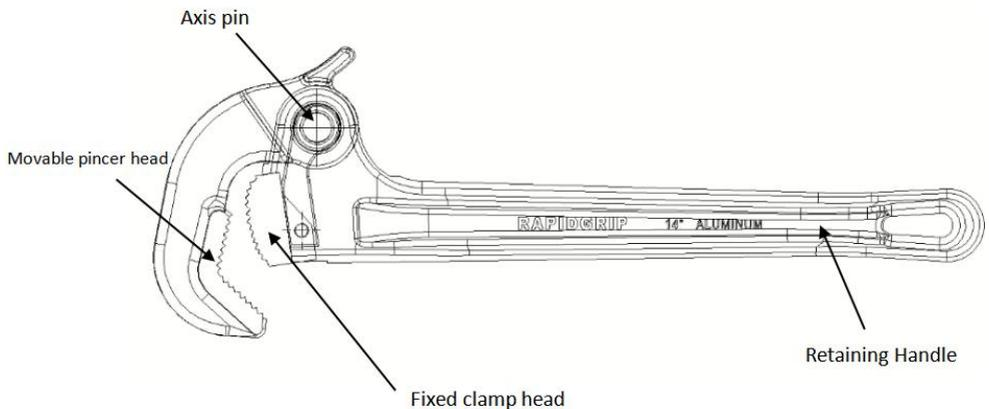

6. Instructies en voorzorgsmaatregelen voor gebruik

1. Houd de handgreep met één hand vast, druk op de kop en staart van de tang om de mond te openen, laat de kop en staart van de tang los na het vastklemmen van de buis en druk de staart van de handgreep met de klok mee.
2. Dit product is niet bedoeld voor gebruik met elektrisch geladen voorwerpen
3. Draag altijd beschermend gereedschap tijdens het gebruik
4. Dit product heeft scherpe tanden en een zwaar gewicht. Let op de veiligheid bij gebruik op grote hoogte.
5. Smeer de kaken langdurig in om roest te voorkomen.

6. Bij gebruik van een pijpklem is het niet toegestaan om op de klemhandgreep, de huls of de lange klemhandgreep en ander gebruik van overbelasting te hameren. Het is niet toegestaan om tractoren, lieren en ander mechanisch sleepoverbelastingsgebruik te gebruiken, om onveilige ongelukken te voorkomen

7. Bij gebruik is het niet toegestaan de hamer te vervangen, om de onderdelen niet te beschadigen en het gebruik te beïnvloeden.

7. Parameter

Artikelen	Model	TD05 20 14"	TD05 20 18"
1	Maximaal Totale lengte	14 inch	18 inch
2	Krimpbereik	Φ 17mm-Φ 48mm	Φ 27mm-Φ 89mm
3	Tangkaken Hardheid	≥52 HRC	≥52 HRC
4	I-Beam-handgreep	√	√

6. Onderhoud

Besteed aandacht aan opslag en onderhoud en plaats het apparaat niet in een omgeving waar gemakkelijk roest kan ontstaan.

Fabrikant : Shanghai muxinmuyeyouxiangongsi

Adres: Shuangchenglu 803nong11hao1602A-1609shi, baoshanqu, shanghai 200000 CN.

Geïmporteerd naar AUS: SIHAO PTY LTD. 1 ROKEVA
STREETEASTWOOD NSW 2122 Australië

Geïmporteerd in de VS: Sanven Technology Ltd. Suite 250, 9166
Anaheim

Plaats, Rancho Cucamonga, CA 91730

UK	REP
-----------	------------

E-CrossStu GmbH

Mainzer Landstr.69, 60329 Frankfurt am Main.

EC	REP
-----------	------------

YH CONSULTING LIMITED.

C/O YH Consulting Limited Office 147, Centurion House,
London Road, Staines-upon-Thames, Surrey, TW18 4AX

VEVOR[®]

TOUGH TOOLS, HALF PRICE

Technisch Ondersteuning en e-garantiecertificaat

www.vevor.com/support

VEVOR[®]

TOUGH TOOLS, HALF PRICE

Technique Assistance et certificat de garantie électronique

www.vevor.com/support

MANUEL D'UTILISATION DE LA CLÉ À TUYAUX

MODÈLE : TD05 20 14" & TD0520 18"

We continue to be committed to provide you tools with competitive price.

"Save Half", "Half Price" or any other similar expressions used by us only represents an estimate of savings you might benefit from buying certain tools with us compared to the major top brands and does not necessarily mean to cover all categories of tools offered by us. You are kindly reminded to verify carefully when you are placing an order with us if you are actually saving half in comparison with the top major brands.

VEVOR®

TOUGH TOOLS, HALF PRICE

PIPE WRENCH

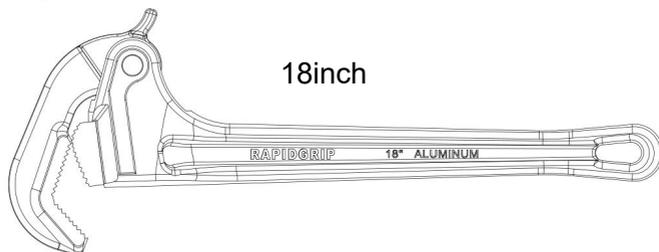
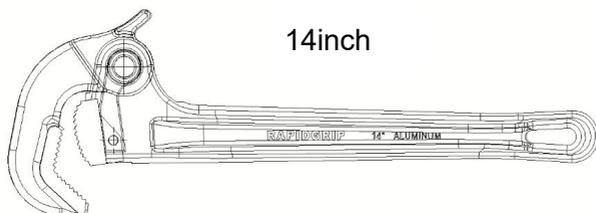

Remarque : le produit réel que vous recevez détermine son apparence.

NEED HELP? CONTACT US!

Have product questions? Need technical support? Please feel free to contact us:

Technical Support and E-Warranty Certificate
www.vevor.com/support

This is the original instruction, please read all manual instructions carefully before operating. VEVOR reserves a clear interpretation of our user manual. The appearance of the product shall be subject to the product you received. Please forgive us that we won't inform you again if there are any technology or software updates on our product.

Consignes de sécurité importantes

	Avertissement - Pour réduire le risque de blessure, l'utilisateur doit lire attentivement le manuel d'instructions.
	Avertissement - Assurez-vous de porter des protecteurs d'oreilles lorsque vous utilisez ce produit.
	Avertissement - Assurez-vous de porter des protections oculaires lorsque vous utilisez ce produit.
	Avertissement - Assurez-vous de porter des masques anti-poussière lorsque vous utilisez ce produit.
	Avertissement - Assurez-vous de porter des gants lorsque vous utilisez ce produit.

AVERTISSEMENT!

- Utilisez le produit uniquement après avoir reçu une formation professionnelle en métallurgie.
- Portez l'équipement de protection individuelle nécessaire tel que des lunettes de sécurité, des bouchons d'oreilles et des gants de protection pendant l'utilisation.
- Assurez-vous que l'espace de travail reste propre, sec et bien ventilé pendant le fonctionnement.
- garder loin des enfants .

2. Présentation du produit

La pince la tête et le bloc dentaire sont forgés avec de l'acier au chrome vanadium de haute qualité, tout le traitement thermique, la trempe au laser des dents, la dureté peut atteindre 52HRC ou plus , facile à ajuster la conception des dents de serrage supérieure et inférieure, la force de

serrage est plus forte. Le corps de la pince est en alliage d'aluminium, couple important, permet d'économiser des efforts , la poignée est ergonomique , plus légère et confortable .

Ce produit est principalement utilisé pour serrer et desserrer des tuyaux, des raccords de tuyauterie et d'autres pièces cylindriques. La plus grande caractéristique du collier de serrage rapide est qu'il n'y a pas d'écrou et qu'il peut ajuster automatiquement la taille de la bouche du collier, éliminant le processus de réglage manuel et améliorant considérablement l'efficacité du travail .

3. Structure du produit (14 pouces pour référence)

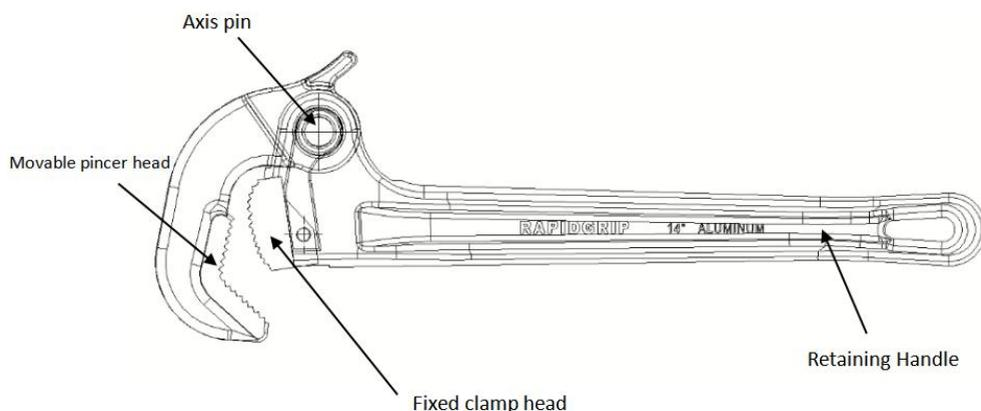

8. Mode d'emploi et précautions d'emploi

1. Tenez la poignée d'une main, appuyez sur la tête et la queue de la pince pour ouvrir la bouche, relâchez la tête et la queue de la pince après avoir serré le tuyau et appuyez sur la queue de la poignée dans le sens des aiguilles d'une montre.
- 2 . Ce produit n'est pas destiné à être utilisé avec des objets chargés électriquement
- 3 . Portez toujours des outils de protection lorsque vous utilisez
- 4 . Ce produit a des dents pointues et un poids lourd, veuillez faire attention à la sécurité lors de l'utilisation à haute altitude.

5 . Veuillez graisser les mâchoires pendant une longue période pour éviter la rouille.

6. Lors de l'utilisation d'un collier de serrage, il n'est pas permis de marteler la poignée de serrage, le manchon ou la longue poignée de serrage et toute autre utilisation de surcharge, il est interdit d'utiliser des tracteurs, des treuils et d'autres utilisations de surcharge de traînée mécanique, afin d'éviter des accidents dangereux.

7. Lors de l'utilisation , il n'est pas permis de remplacer le marteau, afin de ne pas endommager les pièces et affecter l'utilisation.

9. Paramètre

Articles	Modèle	TD05 20 14 "	TD05 20 18 "
1	Maximum Longueur totale	14 pouces	18 pouces
2	Plage de sertissage	Φ 17mm-Φ 48mm	Φ 27mm-Φ 89mm
3	Dureté des mâchoires de pince	≥52 HRC	≥52 HRC
4	Poignée en I	√	√

6. Entretien

Faites attention au stockage et à l'entretien, et ne le placez pas dans un environnement susceptible de provoquer facilement de la rouille.

Fabricant : Shanghaimuxinmuyeyouxiangongsi

Adresse : Shuangchenglu 803nong11hao1602A-1609shi, baoshanqu, Shanghai 200000 CN.

Importé en Australie : SIHAO PTY LTD. 1 ROKEVA STREETASTWOOD NSW 2122 Australie

Importé aux États-Unis : Sanven Technology Ltd. Suite 250, 9166 Anaheim

Lieu, Rancho Cucamonga, CA 91730



E-CrossStu GmbH

Mainzer Landstr.69, 60329 Frankfurt am Main.



YH CONSULTING LIMITED.

C/O YH Consulting Limited Office 147, Centurion House,
London Road, Staines-upon-Thames, Surrey, TW18 4AX

VEVOR[®]

TOUGH TOOLS, HALF PRICE

Technique Assistance et certificat de garantie électronique

www.vevor.com/support

VEVOR[®]

TOUGH TOOLS, HALF PRICE

Technisch Support und E-Garantie-Zertifikat www.vevor.com/support

ROHRZANGE BENUTZERHANDBUCH

MODELL: TD05 20 14" &TD0520 18"

We continue to be committed to provide you tools with competitive price. "Save Half", "Half Price" or any other similar expressions used by us only represents an estimate of savings you might benefit from buying certain tools with us compared to the major top brands and does not necessarily mean to cover all categories of tools offered by us. You are kindly reminded to verify carefully when you are placing an order with us if you are actually saving half in comparison with the top major brands.

VEVOR[®]

TOUGH TOOLS, HALF PRICE

PIPE WRENCH

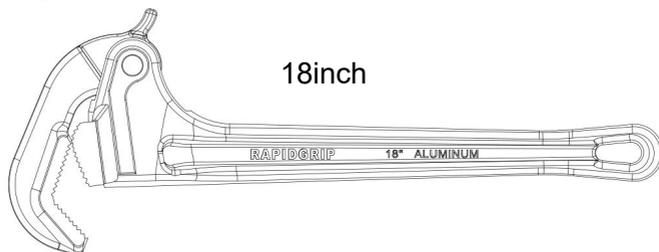
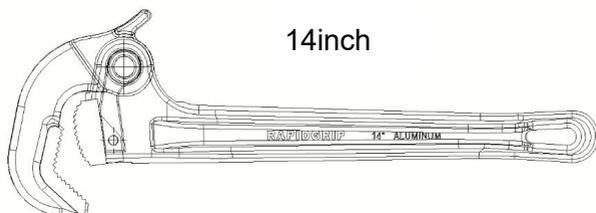

Hinweis: Das tatsächliche Produkt, das Sie erhalten, bestimmt sein Aussehen.

NEED HELP? CONTACT US!

Have product questions? Need technical support? Please feel free to contact us:

Technical Support and E-Warranty Certificate
www.vevor.com/support

This is the original instruction, please read all manual instructions carefully before operating. VEVOR reserves a clear interpretation of our user manual. The appearance of the product shall be subject to the product you received. Please forgive us that we won't inform you again if there are any technology or software updates on our product.

Wichtige Sicherheitsanweisungen

	Warnung – Um das Verletzungsrisiko zu verringern, muss der Benutzer die Bedienungsanleitung sorgfältig lesen.
	Warnung: Tragen Sie bei der Verwendung dieses Produkts unbedingt einen Gehörschutz.
	Warnung: Tragen Sie bei der Verwendung dieses Produkts unbedingt einen Augenschutz.
	Warnung: Tragen Sie bei der Verwendung dieses Produkts unbedingt eine Staubmaske.
	Achtung: Tragen Sie bei der Verwendung dieses Produkts unbedingt Handschuhe.

WARNUNG!

13. Verwenden Sie das Produkt nur nach einer professionellen Metallverarbeitungsschulung.
14. Tragen Sie während des Gebrauchs die erforderliche persönliche Schutzausrüstung wie Schutzbrille, Ohrstöpsel und Schutzhandschuhe.
15. Stellen Sie sicher, dass der Arbeitsplatz während des Betriebs sauber, trocken und gut belüftet bleibt.
16. Von Kindern fernhalten .

2. Produkteinführung

Die Klemme Kopf und Zahnblock sind aus hochwertigem Chrom-Vanadium-Stahl geschmiedet, die gesamte Wärmebehandlung und die Zähne wurden per Laser abgeschreckt, die Härte kann 52 HRC oder mehr erreichen , das Design der oberen und unteren Beißklemmenzähne

lässt sich leicht einstellen und die Klemmkraft ist stärker. Der Klemmkörper besteht aus einer Aluminiumlegierung, hat ein großes Drehmoment und spart Kraft. Der Griff ist ergonomisch, leichter und bequemer. Dieses Produkt wird hauptsächlich zum Festziehen und Lösen von Rohren, Rohrverbindungsstücken und anderen zylindrischen Werkstücken verwendet. Das größte Merkmal der Schnellrohrschelle ist, dass keine Mutter vorhanden ist und die Größe der Schellenöffnung automatisch angepasst werden kann, wodurch der manuelle Anpassungsprozess entfällt und die Arbeitseffizienz erheblich verbessert wird.

3. Produktstruktur (14 Zoll als Referenz)

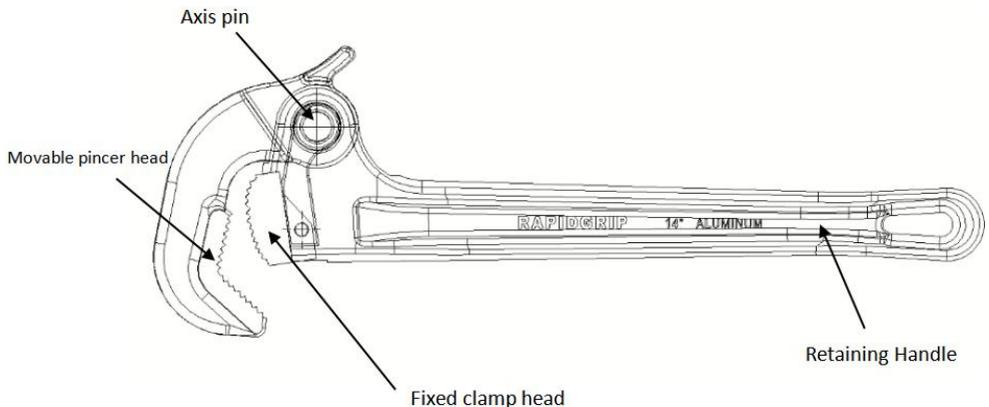

10. Anweisungen und Vorsichtsmaßnahmen für den Gebrauch

1. Halten Sie den Griff mit einer Hand fest, drücken Sie auf Kopf und Ende der Zange, um die Öffnung zu öffnen, lassen Sie Kopf und Ende der Zange los, nachdem Sie das Rohr festgeklemmt haben, und drücken Sie das Ende des Griffs im Uhrzeigersinn.
2. Dieses Produkt ist nicht für den Gebrauch mit elektrisch geladenen Objekten vorgesehen
3. Tragen Sie immer Schutzausrüstung bei der Verwendung
4. Dieses Produkt hat scharfe Zähne und ist schwer. Achten Sie bei der

Verwendung in großen Höhen auf die Sicherheit.

5. Bitte fetten Sie die Backen lange ein, um Rost vorzubeugen.

6. Bei der Verwendung von Rohrschellen ist es nicht gestattet, auf den Klemmgriff, die Hülse oder den langen Klemmgriff zu hämmern und andere Überlastungen zu verwenden. Es ist nicht gestattet, Traktoren, Winden und andere mechanische Zugvorrichtungen zu verwenden, um gefährliche Unfälle zu vermeiden.

7. Bei der Verwendung darf der Hammer nicht ausgetauscht werden, um die Teile nicht zu beschädigen und die Verwendung zu beeinträchtigen.

11. Parameter

Artikel	Modell	TD05 20 14 "	TD05 20 18 "
1	Maximal Gesamtlänge	14 Zoll	18 Zoll
2	Crimpbereich	Φ 17mm-Φ 48mm	Φ 27mm-Φ 89mm
3	Härte der Zangenbacken	≥52 HRC	≥52 HRC
4	I-Träger-Griff	√	√

6. Wartung

Achten Sie auf Lagerung und Wartung und platzieren Sie es nicht an einem Ort, an dem es leicht zu Rost kommen kann.

Hersteller : Shanghaimuxinmuyeyouxiangongsi

Adresse: Shuangchenglu 803nong11hao1602A-1609shi, Baoshanqu, Shanghai 200000 CN.

Nach AUS importiert: SIHAO PTY LTD. 1 ROKEVA
STREETEASTWOOD NSW 2122 Australien

Importiert in die USA: Sanven Technology Ltd. Suite 250, 9166 Anaheim
Ort, Rancho Cucamonga, CA 91730



E-CrossStu GmbH

Mainzer Landstr.69, 60329 Frankfurt am Main.



YH CONSULTING LIMITED.

C/O YH Consulting Limited Office 147, Centurion House,
London Road, Staines-upon-Thames, Surrey, TW18 4AX

VEVOR[®]

TOUGH TOOLS, HALF PRICE

Technisch Support und E-Garantie-Zertifikat

www.vevor.com/support

VEVOR[®]

TOUGH TOOLS, HALF PRICE

Techniczny Certyfikat wsparcia i e-gwarancji www.vevor.com/support

INSTRUKCJA OBSŁUGI KLUCZA DO RUR

MODEL: TD05 20 14" I TD0520 18"

We continue to be committed to provide you tools with competitive price. "Save Half", "Half Price" or any other similar expressions used by us only represents an estimate of savings you might benefit from buying certain tools with us compared to the major top brands and does not necessarily mean to cover all categories of tools offered by us. You are kindly reminded to verify carefully when you are placing an order with us if you are actually saving half in comparison with the top major brands.

VEVOR®

TOUGH TOOLS, HALF PRICE

PIPE WRENCH

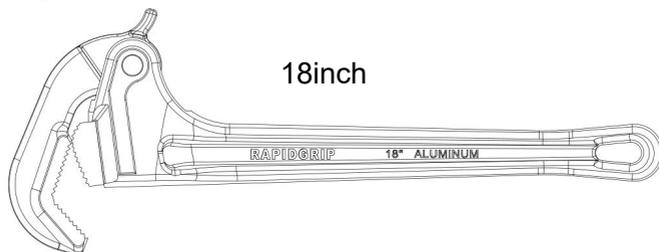
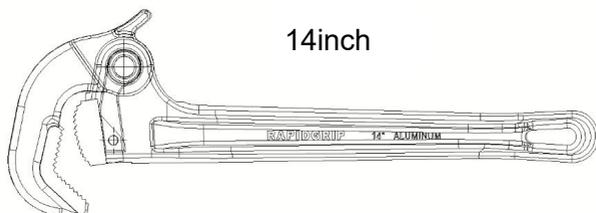

Uwaga: rzeczywisty produkt, który otrzymasz, określa jego wygląd.

NEED HELP? CONTACT US!

Have product questions? Need technical support? Please feel free to contact us:

Technical Support and E-Warranty Certificate
www.vevor.com/support

This is the original instruction, please read all manual instructions carefully before operating. VEVOR reserves a clear interpretation of our user manual. The appearance of the product shall be subject to the product you received. Please forgive us that we won't inform you again if there are any technology or software updates on our product.

Ważne instrukcje dotyczące bezpieczeństwa

	Ostrzeżenie — aby zmniejszyć ryzyko obrażeń, użytkownik musi uważnie przeczytać instrukcję obsługi.
	Ostrzeżenie — podczas korzystania z tego produktu należy nosić ochroniacze uszu.
	Ostrzeżenie — podczas korzystania z tego produktu należy nosić okulary ochronne.
	Ostrzeżenie — podczas korzystania z tego produktu należy nosić maski przeciwpyłowe.
	Ostrzeżenie — podczas korzystania z tego produktu należy nosić rękawiczki.

OSTRZEŻENIE!

17. Produkt stosować wyłącznie po odbyciu profesjonalnego szkolenia w zakresie obróbki metali.
18. Podczas użytkowania należy nosić niezbędny sprzęt ochrony osobistej, taki jak okulary ochronne, zatyczki do uszu i rękawice ochronne.
19. Upewnij się, że miejsce pracy pozostaje czyste, suche i dobrze wentylowane podczas pracy.
20. trzymać z dala od dzieci .

2. Wprowadzenie produktu

Zacisk głowica i blok zębów są kute z wysokiej jakości stali chromowo-wanadowej, cała obróbka cieplna, hartowanie laserowe zębów, twardość może osiągnąć 52HRC lub więcej , łatwa regulacja górnego i dolnego kształtu zęba zacisku zgryzowego, siła zaciskania jest większa.

Korpus zacisku wykonany jest ze stopu aluminium, duży moment obrotowy, oszczędność wysiłku . Uchwyt jest ergonomiczny , lżejszy i wygodniejszy . Produkt ten służy głównie do dokręcania i luzowania rur, złączek rurowych i innych cylindrycznych przedmiotów. Największą cechą szybkiego obejmy do rur jest to, że nie ma nakrętki i może automatycznie regulować rozmiar otworu obejmy, eliminując proces ręcznej regulacji i znacznie poprawiając wydajność pracy .

3. Struktura produktu (14 cali w celach informacyjnych)

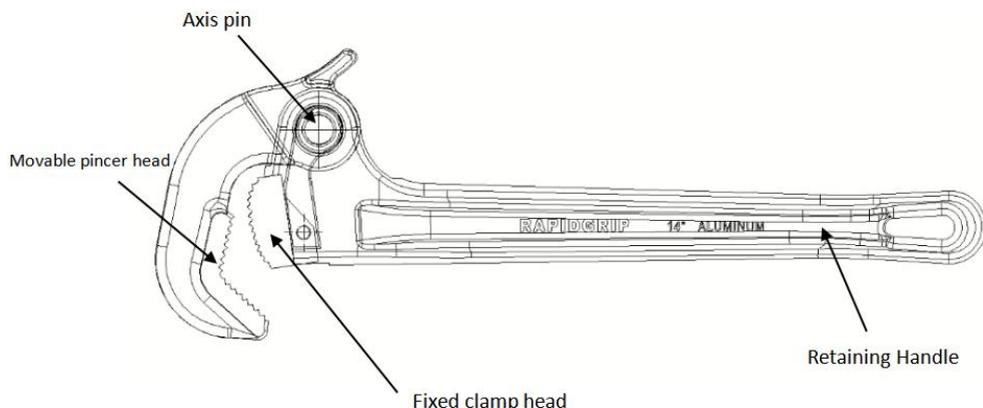

12. Instrukcje i środki ostrożności dotyczące stosowania

1. Przytrzymaj uchwyt jedną ręką, naciśnij główkę i końcówkę szczypiec, aby otworzyć usta, zwolnij główkę i końcówkę szczypiec po zaciśnięciu rury i naciśnij końcówkę rączki w kierunku zgodnym z ruchem wskazówek zegara.
- 2 . Ten produkt nie jest przeznaczony do użytku z przedmiotami

naładowanymi elektrycznie

3 . Podczas używania zawsze noś narzędzia ochronne

4 . Ten produkt ma ostre zęby i dużą wagę, należy zwrócić uwagę na

bezpieczeństwo podczas użytkowania na dużych wysokościach.

5 . Proszę smarować szczęki przez długi czas, aby zapobiec rdzy.

6. podczas używania obejm rurowej nie wolno uderzać młotkiem w

uchwyt obejm, tuleję lub długi uchwyt obejm i inne przypadki

przeciążenia, nie wolno używać traktorów, wciągarek ani innych

mechanicznych zastosowań związanych z przeciążeniami, aby uniknąć

niebezpiecznych wypadków

7. Podczas używania nie wolno wymieniać młotka, aby nie uszkodzić

części i nie wpłynąć na użytkowanie.

13. Parametr

Rzeczy	Model	TD05 20 14''	TD05 20 18''
1	Maksymalna Całkowita długość	14 cali	18 cali
2	Zakres zaciskania	Φ 17mm-Φ 48mm	Φ 27mm-Φ 89mm
3	Twardość szczęk szczypiec	≥52 HRC	≥52 HRC
4	Uchwyt I-Beam	√	√

6. Konserwacja

Zwróć uwagę na przechowywanie i konserwację i nie umieszczaj go w środowisku, które może łatwo spowodować rdzę.

Producent : Shanghaimuxinmuyeyouxiangongsi

Adres: Shuangchenglu 803nong11hao1602A-1609shi, baoshanqu, szanghaj 200000 CN.

Import do AUS: SIHAO PTY LTD. 1 ROKEVA STREETEASTWOOD NSW 2122 Australia

Import do USA: Sanven Technology Ltd. Suite 250, 9166 Anaheim Place, Rancho Cucamonga, Kalifornia 91730

UK	REP
-----------	------------

E-CrossStu GmbH

Mainzer Landstr.69, 60329 Frankfurt am Main.

EC	REP
-----------	------------

YH CONSULTING LIMITED.

C/O YH Consulting Limited Office 147, Centurion House,
London Road, Staines-upon-Thames, Surrey, TW18 4AX

VEVOR[®]

TOUGH TOOLS, HALF PRICE

Techniczny Certyfikat wsparcia i e-gwarancji

www.vevor.com/support

VEVOR[®]

TOUGH TOOLS, HALF PRICE

Tecnico Supporto e certificato di garanzia elettronica www.vevor.com/support

MANUALE UTENTE DELLA CHIAVE A TUBO

MODELLO: TD05 20 14" E TD0520 18"

We continue to be committed to provide you tools with competitive price. "Save Half", "Half Price" or any other similar expressions used by us only represents an estimate of savings you might benefit from buying certain tools with us compared to the major top brands and does not necessarily mean to cover all categories of tools offered by us. You are kindly reminded to verify carefully when you are placing an order with us if you are actually saving half in comparison with the top major brands.

VEVOR®

TOUGH TOOLS, HALF PRICE

PIPE WRENCH

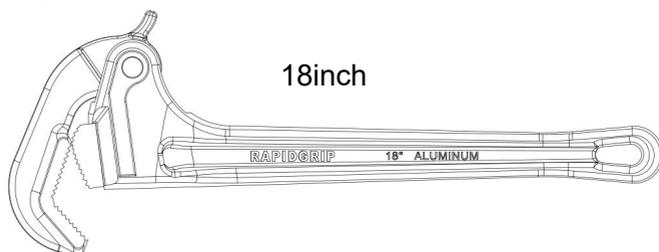
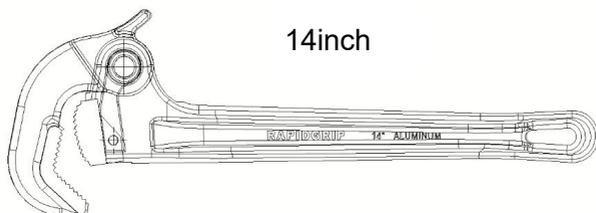

Nota: il prodotto effettivo che ricevi ne determina l'aspetto.

NEED HELP? CONTACT US!

Have product questions? Need technical support? Please feel free to contact us:

Technical Support and E-Warranty Certificate
www.vevor.com/support

This is the original instruction, please read all manual instructions carefully before operating. VEVOR reserves a clear interpretation of our user manual. The appearance of the product shall be subject to the product you received. Please forgive us that we won't inform you again if there are any technology or software updates on our product.

Importanti istruzioni di sicurezza

	Avvertenza - Per ridurre il rischio di lesioni, l'utente deve leggere attentamente il manuale di istruzioni.
	Avvertenza: assicurarsi di indossare protezioni per le orecchie quando si utilizza questo prodotto.
	Avvertenza: assicurarsi di indossare protezioni per gli occhi quando si utilizza questo prodotto.
	Avvertenza: assicurarsi di indossare maschere antipolvere quando si utilizza questo prodotto.
	Avvertenza: assicurarsi di indossare guanti quando si utilizza questo prodotto.

AVVERTIMENTO!

21. Utilizzare il prodotto solo dopo aver ricevuto una formazione professionale sulla lavorazione dei metalli.
22. Indossare i dispositivi di protezione individuale necessari come occhiali di sicurezza, tappi per le orecchie e guanti protettivi durante l'uso.
23. Assicurarsi che l'area di lavoro rimanga pulita, asciutta e ben ventilata durante il funzionamento.
24. tenere lontano dai bambini .

2. Presentazione del prodotto

Il morsetto la testa e il blocco denti sono forgiati con acciaio al cromo vanadio di alta qualità, l'intero trattamento termico, la tempra laser dei denti, la durezza può raggiungere 52HRC o più , facile regolare il design dei denti del morsetto del morso superiore e inferiore, la forza di serraggio è più

forte. il corpo del morsetto è realizzato in materiale in lega di alluminio, coppia elevata, risparmio di fatica , la maniglia è ergonomica , più leggera e confortevole .

Questo prodotto viene utilizzato principalmente per serrare e allentare tubi, raccordi e altri pezzi cilindrici. La caratteristica più importante del morsetto rapido per tubi è che non è presente un dado e può regolare automaticamente le dimensioni della bocca del morsetto, eliminando il processo di regolazione manuale e migliorando notevolmente l'efficienza del lavoro .

3.Struttura del prodotto (14 pollici per riferimento)

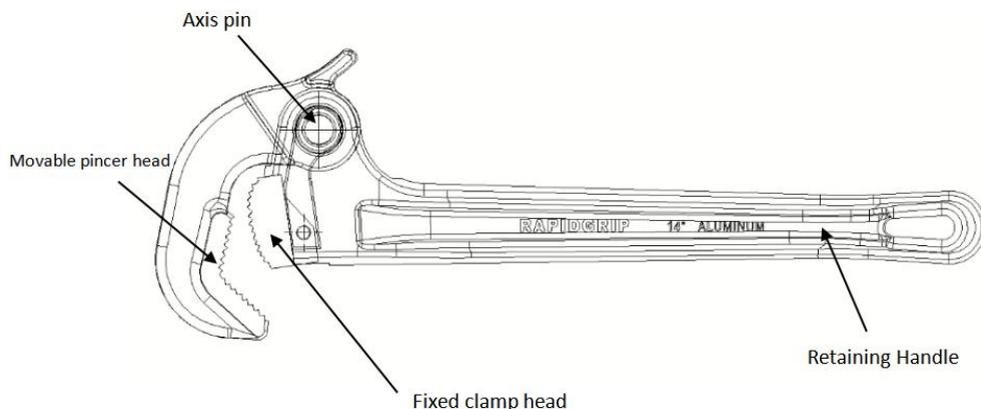

14. Istruzioni e precauzioni per l'uso

1. Tenere la maniglia con una mano, premere la testa e la coda della pinza per aprire la bocca, rilasciare la testa e la coda della pinza dopo aver serrato il tubo e premere la coda della maniglia in senso orario.
- 2 . Questo prodotto non è destinato all'uso con oggetti caricati elettricamente
- 3 . Indossare sempre strumenti protettivi durante l'utilizzo
- 4 . Questo prodotto ha denti affilati e peso elevato, prestare attenzione alla sicurezza quando si utilizza ad alta quota.
- 5 . Si prega di ingrassare a lungo le ganasce per prevenire la ruggine.

6. quando si utilizza la fascetta per tubi, non è consentito martellare la maniglia della fascetta, la manica o la maniglia lunga della fascetta e altri usi con sovraccarico, non è consentito utilizzare trattori, argani e altri usi con sovraccarico di trascinamento meccanico, in modo da evitare incidenti pericolosi

7. durante l'utilizzo , non è consentito sostituire il martello, per non danneggiare le parti e comprometterne l'uso.

15. Parametro

Elementi	Modello	TD0520 14''	TD0520 18''
1	Massimo Lunghezza totale	14 pollici	18 pollici
2	Gamma di crimpatura	Φ 17mm-Φ 48mm	Φ 27mm-Φ 89mm
3	Durezza delle ganasce della pinza	≥52HRC	≥52HRC
4	Maniglia a I-Beam	√	√

6. Manutenzione

Prestare attenzione alla conservazione e alla manutenzione e non collocarlo in un ambiente che potrebbe facilmente causare ruggine.

Produttore : Shanghaimuxinmuyeyouxiangongsi

Indirizzo: Shuangchenglu 803nong11hao1602A-1609shi, baoshanqu, shanghai 200000 CN.

Importato in Australia: SIHAO PTY LTD. 1 ROKEVA
STREETEASTWOOD NSW 2122 Australia

Importato negli Stati Uniti: Sanven Technology Ltd. Suite 250, 9166
Anaheim

Luogo, Rancho Cucamonga, CA 91730



E-CrossStu GmbH

Mainzer Landstr.69, 60329 Frankfurt am Main.



YH CONSULTING LIMITED.

C/O YH Consulting Limited Office 147, Centurion House,
London Road, Staines-upon-Thames, Surrey, TW18 4AX

VEVOR[®]

TOUGH TOOLS, HALF PRICE

Tecnico Supporto e certificato di garanzia elettronica

www.vevor.com/support

VEVOR[®]

TOUGH TOOLS, HALF PRICE

Técnico Soporte y certificado de garantía electrónica www.vevor.com/support

LLAVE PARA TUBOS MANUAL DEL USUARIO

MODELO: TD05 20 14" Y TD0520 18"

We continue to be committed to provide you tools with competitive price. "Save Half", "Half Price" or any other similar expressions used by us only represents an estimate of savings you might benefit from buying certain tools with us compared to the major top brands and does not necessarily mean to cover all categories of tools offered by us. You are kindly reminded to verify carefully when you are placing an order with us if you are actually saving half in comparison with the top major brands.

VEVOR®

TOUGH TOOLS, HALF PRICE

PIPE WRENCH

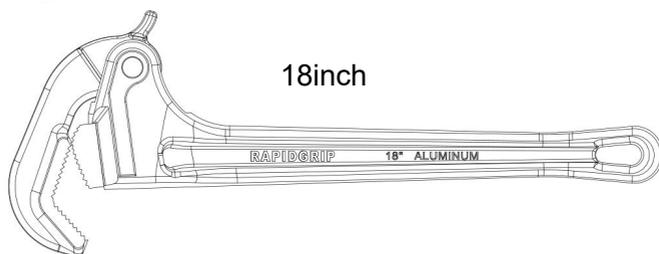
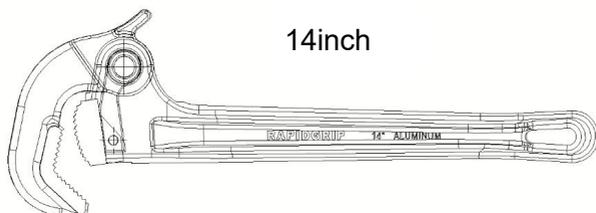

Nota: El producto real que recibe determina su apariencia.

NEED HELP? CONTACT US!

Have product questions? Need technical support? Please feel free to contact us:

Technical Support and E-Warranty Certificate
www.vevor.com/support

This is the original instruction, please read all manual instructions carefully before operating. VEVOR reserves a clear interpretation of our user manual. The appearance of the product shall be subject to the product you received. Please forgive us that we won't inform you again if there are any technology or software updates on our product.

Instrucciones de seguridad importantes

	Advertencia: para reducir el riesgo de lesiones, el usuario debe leer atentamente el manual de instrucciones.
	Advertencia: asegúrese de usar protectores auditivos cuando utilice este producto.
	Advertencia: asegúrese de usar protectores para los ojos cuando utilice este producto.
	Advertencia: asegúrese de usar máscaras antipolvo cuando utilice este producto.
	Advertencia: asegúrese de usar guantes cuando utilice este producto.

¡ADVERTENCIA!

25. Utilice el producto sólo después de recibir formación profesional en metalurgia.
26. Use el equipo de protección personal necesario, como gafas de seguridad, tapones para los oídos y guantes protectores, durante el uso.
27. Asegúrese de que el espacio de trabajo permanezca limpio, seco y bien ventilado durante la operación.
28. Aléjate de los niños .

2. Introducción del producto

la abrazadera La cabeza y el bloque de dientes están forjados con acero al cromo vanadio de alta calidad, todo el tratamiento térmico, el enfriamiento con láser de los dientes, la dureza puede alcanzar 52 HRC o más , fácil de ajustar el diseño del diente de la abrazadera de mordida superior e inferior,

la fuerza de sujeción es más fuerte. El cuerpo de la abrazadera está hecho de material de aleación de aluminio, gran torque, ahorra esfuerzo , el mango es ergonómico , más liviano y cómodo .

Este producto se utiliza principalmente para apretar y aflojar tuberías, accesorios de tuberías y otras piezas de trabajo cilíndricas. La característica más importante de la abrazadera de tubería rápida es que no tiene tuerca y puede ajustar automáticamente el tamaño de la boca de la abrazadera, eliminando el proceso de ajuste manual y mejorando en gran medida la eficiencia del trabajo .

3.Estructura del producto (14 pulgadas para referencia)

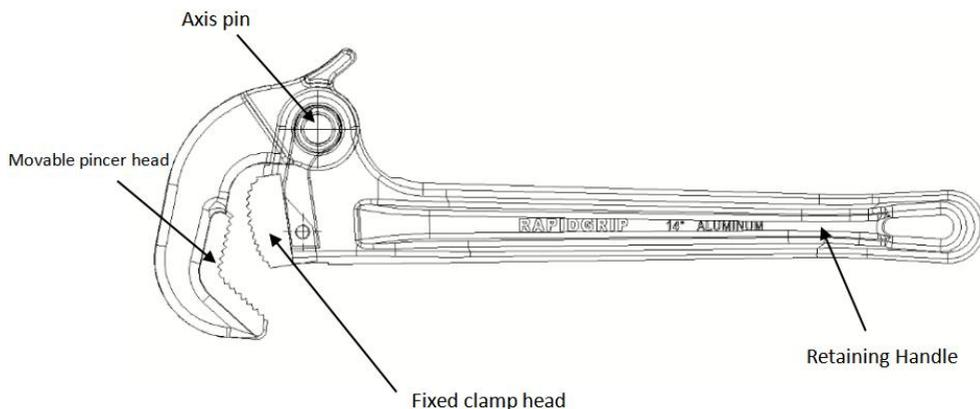

16. Instrucciones y precauciones de uso.

1. Sostenga el mango con una mano, presione la cabeza y la cola de los alicates para abrir la boca, suelte la cabeza y la cola de los alicates después de sujetar el tubo y presione la cola del mango en el sentido de las agujas del reloj.
- 2 . Este producto no está diseñado para usarse con objetos cargados eléctricamente.
- 3 . Utilice siempre herramientas protectoras cuando utilice
- 4 . Este producto tiene dientes afilados y peso pesado; preste atención a la

seguridad cuando lo use a gran altura.

5 . Engrase las mandíbulas durante mucho tiempo para evitar la oxidación.

6. Cuando se utiliza una abrazadera de tubo, no se permite martillar el mango de la abrazadera, el manguito o el mango largo de la abrazadera ni otros usos de sobrecarga, no se permite usar tractores, cabrestantes y otros usos de sobrecarga de arrastre mecánico, para evitar accidentes inseguros.

7. Cuando se utiliza , no está permitido reemplazar el martillo, para no dañar las piezas y afectar el uso.

17. Parámetro

Elementos	Modelo	TD05 20 14 "	TD05 20 18 "
1	Máximo Longitud total	14 pulgadas	18 pulgadas
2	Rango de prensado	Φ 17mm-Φ 48mm	Φ 27mm-Φ 89mm
3	Dureza de las mordazas del alicate	≥52 HRC	≥52 HRC
4	Mango de viga I	√	√

6. Mantenimiento

Preste atención al almacenamiento y mantenimiento y no lo coloque en un entorno que pueda oxidarlo fácilmente.

Fabricante : Shanghaimuxinmuyeyouxiangongsi

Dirección: Shuangchenglu 803nong11hao1602A-1609shi, baoshanqu, shanghai 200000 CN.

Importado a AUS: SIHAO PTY LTD. 1 ROKEVA STREET ASTWOOD NSW 2122 Australia

Importado a EE. UU.: Sanven Technology Ltd. Suite 250, 9166 Anaheim Lugar, Rancho Cucamonga, CA 91730

UK	REP
-----------	------------

E-CrossStu GmbH

Mainzer Landstr.69, 60329 Frankfurt am Main.

EC	REP
-----------	------------

YH CONSULTING LIMITED.

C/O YH Consulting Limited Office 147, Centurion House,
London Road, Staines-upon-Thames, Surrey, TW18 4AX

VEVOR[®]
TOUGH TOOLS, HALF PRICE

Técnico Certificado de soporte y garantía electrónica
www.vevor.com/support

VEVOR[®]

TOUGH TOOLS, HALF PRICE

Teknisk Support och e-garanticertifikat www.vevor.com/support

RÖRNYCKEL ANVÄNDARHANDBOK

MODELL: TD05 20 14" & TD0520 18"

We continue to be committed to provide you tools with competitive price. "Save Half", "Half Price" or any other similar expressions used by us only represents an estimate of savings you might benefit from buying certain tools with us compared to the major top brands and does not necessarily mean to cover all categories of tools offered by us. You are kindly reminded to verify carefully when you are placing an order with us if you are actually saving half in comparison with the top major brands.

VEVOR®

TOUGH TOOLS, HALF PRICE

PIPE WRENCH

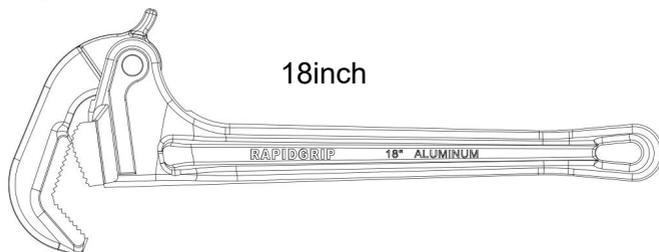
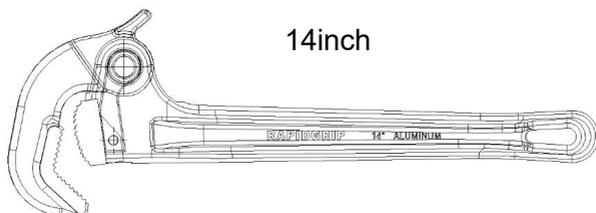

Obs: Den faktiska produkten du får avgör dess utseende.

NEED HELP? CONTACT US!

Have product questions? Need technical support? Please feel free to contact us:

Technical Support and E-Warranty Certificate
www.vevor.com/support

This is the original instruction, please read all manual instructions carefully before operating. VEVOR reserves a clear interpretation of our user manual. The appearance of the product shall be subject to the product you received. Please forgive us that we won't inform you again if there are any technology or software updates on our product.

Viktiga säkerhets instruktioner

	Varning - För att minska risken för skada måste användaren läsa bruksanvisningen noggrant.
	Varning- Var noga med att bära hörselskydd när du använder denna produkt.
	Varning- Var noga med att bära ögonskydd när du använder denna produkt.
	Varning- Var noga med att bära dammmasker när du använder denna produkt.
	Varning- Var noga med att bära handskar när du använder denna produkt.

VARNING!

29. Använd produkten endast efter att ha fått professionell metallbearbetningsutbildning.
30. Bär nödvändig personlig skyddsutrustning såsom skyddsglasögon, öronproppar och skyddshandskar under användning.
31. Se till att arbetsytan förblir ren, torr och välventilerad under drift.
32. håll borta från barn .

2. Produktintroducera

Klämman huvud och tandblock är smidda med högkvalitativt kromvanadinstål, hela värmebehandlingen, tänderna lasersläcker, hårdheten kan nå 52HRC eller mer , lätt att justera den övre och nedre bitklämmans design, klämkraften är starkare. Kläm kroppen är gjord av aluminiumlegeringsmaterial, stort vridmoment, spara ansträngning ,

Handtaget är ergonomiskt , lättare och bekvämt .

Denna produkt används främst för att dra åt och lossa rör, rördelar och andra cylindriska arbetsstycken. Den största egenskapen hos den snabba rörklämman är att det inte finns någon mutter, och den kan automatiskt justera storleken på klämmans mynning, vilket eliminerar den manuella justeringsprocessen och avsevärt förbättrar arbetseffektiviteten .

3. Produktstruktur (14 tum för referens)

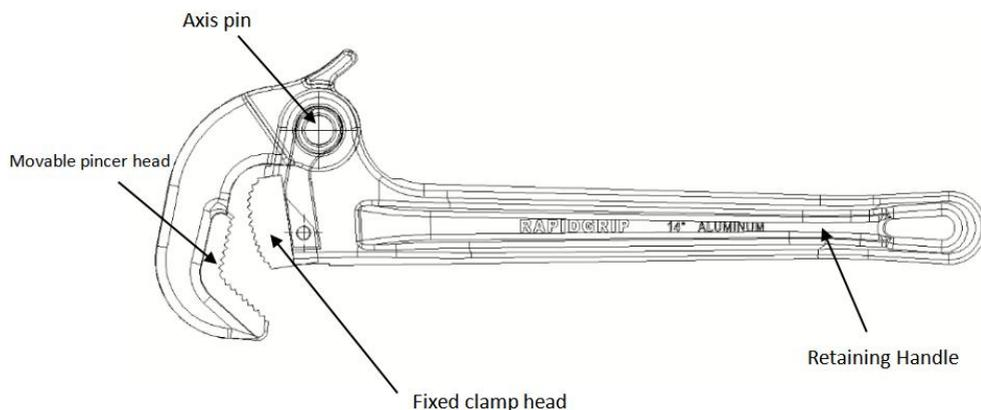

18. Instruktioner och försiktighetsåtgärder för användning

1. Håll i handtaget med en hand, tryck på huvudet och svansen på tången för att öppna munnen, släpp tångens huvud och svans efter att ha klämt fast röret och tryck på handtagets bakdel medurs.
- 2 . Denna produkt är inte avsedd att användas med elektriskt laddade föremål
- 3 . Bär alltid skyddsverktyg vid användning
- 4 . Denna produkt har vassa tänder och tung vikt, var uppmärksam på säkerheten vid användning på hög höjd.
- 5 . Smörj käftarna under lång tid för att förhindra rost.
6. vid användning av rörklämma är det inte tillåtet att hamra på klämhandtaget, hylsan eller det långa klämhandtaget och annan

överbelastningsanvändning, inte tillåtet att använda traktorer, vinschar och annan mekanisk dragöverbelastning för att undvika osäkra olyckor

7. Vid användning är det inte tillåtet att byta ut hammaren, för att inte skada delarna och påverka användningen.

19. Parameter

Föremål	Modell	TD05 20 14 tum	TD05 20 18 tum
1	Maximal Total längd	14 tum	18 tum
2	Crimping Range	Φ 17mm-Φ 48mm	Φ 27mm-Φ 89mm
3	Tångkäkar hårdhet	≥52 HRC	≥52 HRC
4	I-Beam Handtag	√	√

6. Underhåll

Var uppmärksam på förvaring och underhåll och placera den inte i en miljö som lätt kan orsaka rost.

Tillverkare : Shanghaimuxinmuyeyouxiangongsi

Address: Shuangchenglu 803nong11hao1602A-1609shi, baoshanqu, shanghai 200000 CN.

Importerad till AUS: SIHAO PTY LTD. 1 ROKEVA STREETEASTWOOD NSW 2122 Australien

Importerad till USA: Sanven Technology Ltd. Suite 250, 9166 Anaheim Place, Rancho Cucamonga, CA 91730



E-CrossStu GmbH

Mainzer Landstr.69, 60329 Frankfurt am Main.



YH CONSULTING LIMITED.

C/O YH Consulting Limited Office 147, Centurion House,
London Road, Staines-upon-Thames, Surrey, TW18 4AX

VEVOR[®]

TOUGH TOOLS, HALF PRICE

Teknisk Support och e-garanticertifikat

www.vevor.com/support