

VEVOR[®]

TOUGH TOOLS, HALF PRICE

Technical Support and E-Warranty Certificate www.vevor.com/support

LIVESTOCK FEEDER

USER MANUAL

We continue to be committed to provide you tools with competitive price. "Save Half", "Half Price" or any other similar expressions used by us only represents an estimate of savings you might benefit from buying certain tools with us compared to the major top brands and does not necessarily mean to cover all categories of tools offered by us. You are kindly reminded to verify carefully when you are placing an order with us if you are actually saving half in comparison with the top major brands.

VEVOR[®]

TOUGH TOOLS, HALF PRICE

LIVESTOCK FEEDER

MODEL : T1091

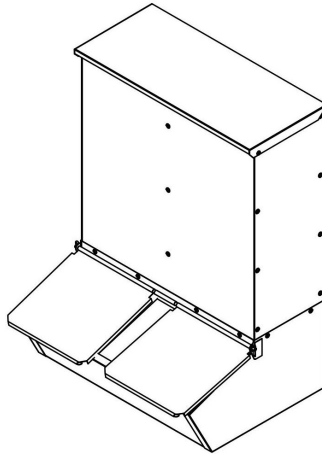

NEED HELP? CONTACT US!

Have product questions? Need technical support? Please feel free to contact us: Technical Support and E-Warranty Certificate www.vevor.com/support

This is the original instruction, please read all manual instructions carefully before operating. VEVOR reserves a clear interpretation of our user manual. The appearance of the product shall be subject to the product you received. Please forgive us that we won't inform you again if there are any technology or software updates on our product.



Safety precautions

Read this instructions before using this product. Failure to do so can result in serious injury. the basic precautions should always be followed,including the following:

1. PLEASE NOTE! Drawings in this manual are for illustration purposes only and in some details may differ from the actual product.

2. User Guide

Do not exceed the load weight. The screw is fixed on a flat, hard, wall surface for safe use

Check the livestock feeder before each use. Do not use it if parts are loose or damaged.



Before Assembling

Before assembling, we recommend:











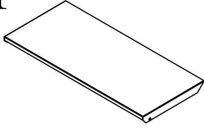
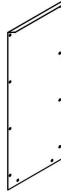
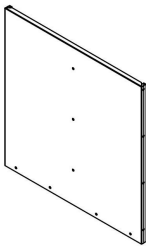
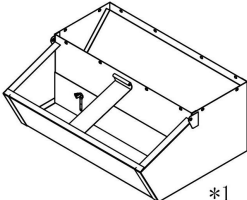

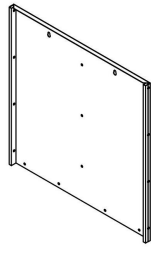
1. Wear Gloves.



2.Recommended Tools, Power Drill With Phillips Bit



PARTS LIST

<p>1</p>  <p>*1</p>	<p>2</p>  <p>*2</p>	<p>3</p>  <p>*1</p>
<p>4</p>  <p>*1</p>	<p>5</p>  <p>*2</p>	<p>6</p>  <p>*1</p>
<p>7</p>  <p>*1</p>	<p>8</p>  <p>Axostyle (1)</p>	<p>9</p>  <p>Washer (2)</p>
<p>10</p>  <p>Bayonet Lock (2)</p>	<p>11</p>  <p>M6X20mm (14) Bolit+Nut</p>	<p>12</p>  <p>M6X12MM(18) Bolt+Lock Washer+Nut</p>
<p>13</p>  <p>M6X20mm (2) Bolit+Nut</p>	<p>14</p>  <p>Spanner (1)</p>	<p>15</p>  <p>Wrench (1)</p>

INSTALLATION

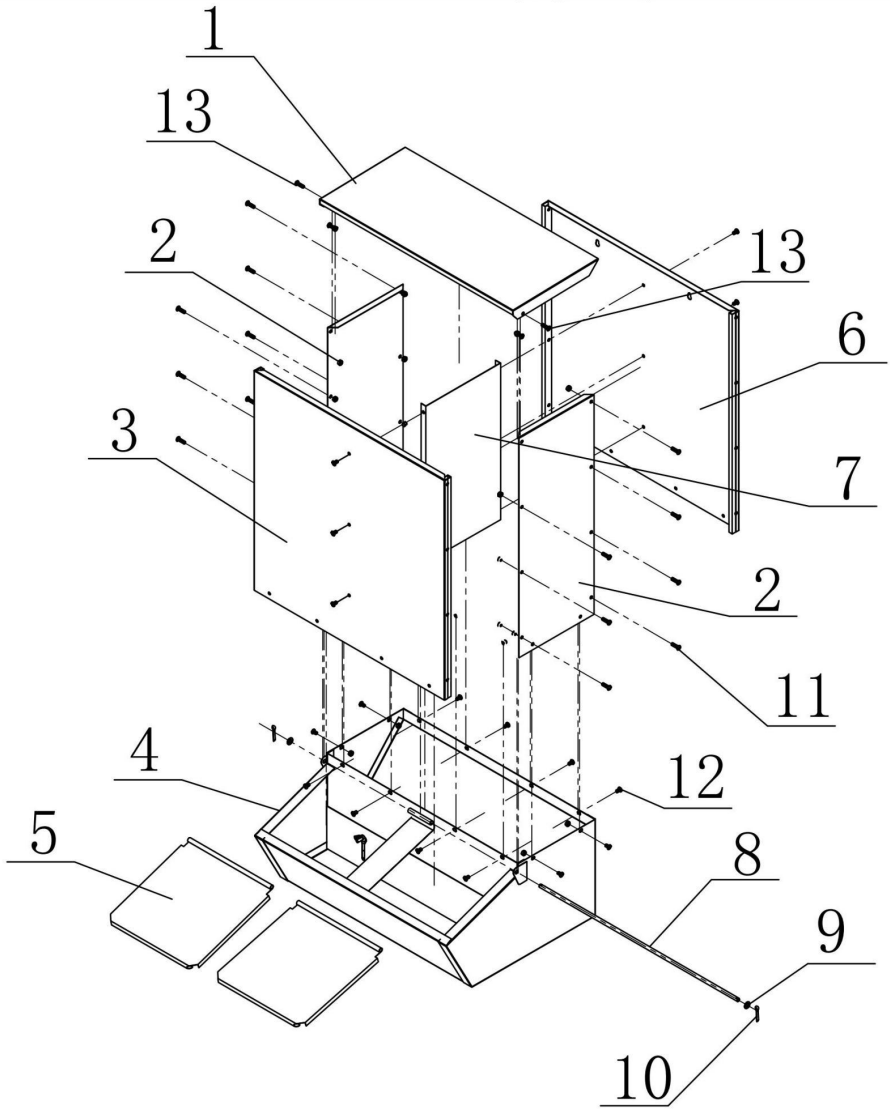

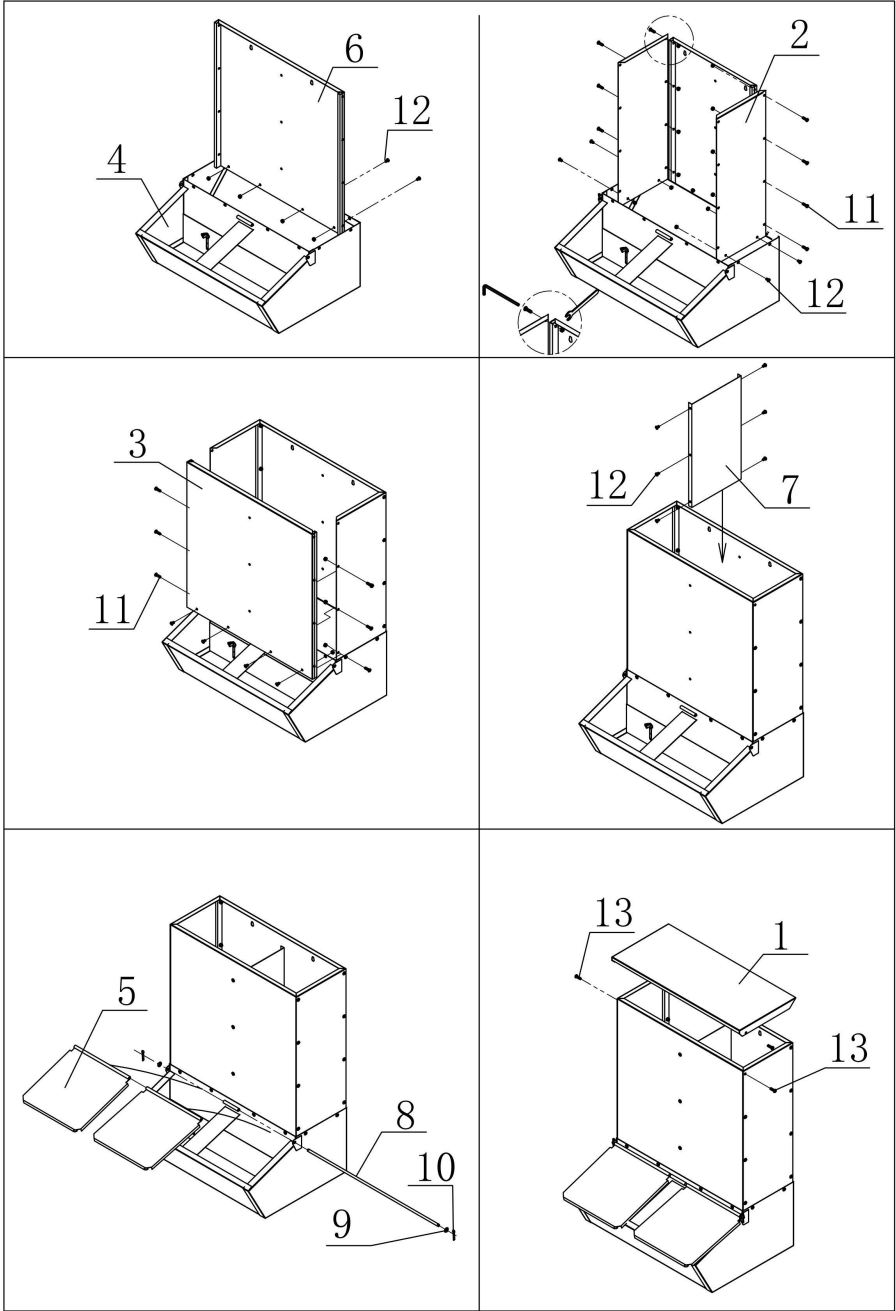

Manufacturer:Shanghaimuxinmuyeyouxiangongsi

Address: Shuangchenglu 803nong11hao1602A-1609shi, baoshanqu, shanghai 200000 CN.

Imported to AUS: SIHAO PTY LTD. 1 ROKEVA STREETEASTWOOD NSW 2122 Australia

Imported to USA: Sanven Technology Ltd. Suite 250, 9166 Anaheim Place, Rancho Cucamonga, CA 91730

EC	REP
-----------	------------

E-CrossStu GmbH

Mainzer Landstr.69, 60329 Frankfurt am Main.

UK	REP
-----------	------------

YH CONSULTING LIMITED.

C/O YH Consulting Limited Office 147, Centurion House,
London Road, Staines-upon-Thames, Surrey, TW18 4AX

VEVOR[®]

TOUGH TOOLS, HALF PRICE

Technical Support and E-Warranty Certificate

www.vevor.com/support

VEVOR[®]

TOUGH TOOLS, HALF PRICE

Teknisk Support och e-garanticertifikat www.vevor.com/support

BOSKAPSFODER

ANVÄNDARMANUAL

Vi fortsätter att vara engagerade i att ge dig verktyg till konkurrenskraftiga priser. "Spara hälften", "halva priset" eller andra liknande uttryck som används av oss representerar bara en uppskattning av besparingar du kan dra nytta av att köpa vissa verktyg hos oss jämfört med de stora toppmärkena och betyder inte nödvändigtvis att täcka alla kategorier av verktyg som erbjuds av oss. Du påminns vänligen om att noggrant kontrollera när du gör en beställning hos oss om du faktiskt sparar hälften i jämförelse med de främsta stora varumärkena.

VEVOR®

TOUGH TOOLS, HALF PRICE

LIVESTOCK FEEDER

Modell : T1091

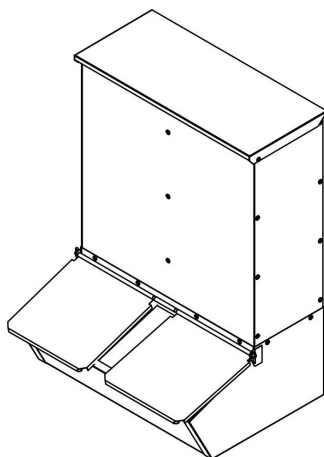

BEHÖVER HJÄLP? KONTAKTA OSS!

Har du produktfrågor? Behöver du teknisk support? Kontakta oss gärna:

Teknisk support och e-garanticertifikat www.vevor.com/support

Detta är den ursprungliga instruktionen, läs alla instruktioner noggrant innan du använder den. VEVOR reserverar sig för en tydlig tolkning av vår användarmanual. Utseendet på produkten är beroende av den produkt du fått. Ursäkta oss att vi inte kommer att informera dig igen om det finns någon teknik eller mjukvaruuppdateringar på vår produkt.



Säkerhetsåtgärder

Läs dessa instruktioner innan du använder denna produkt. Underlåtenhet att göra det kan resultera i allvarliga skador. de grundläggande försiktighetsåtgärderna bör alltid följas , inklusive följande:

1 . OBS! Ritningar i denna handbok är till för endast i illustrationssyfte och i vissa detaljer kan skilja sig från den faktiska produkten.

2. Användarhandbok

Överskrid inte lastvikten. Skruven är fäst på en plan, hård väggyta för säker användning

Kontrollera boskapsmataren före varje användning. Använd den inte om delar är lösa eller skadade.



Innan montering

Innan montering rekommenderar vi:







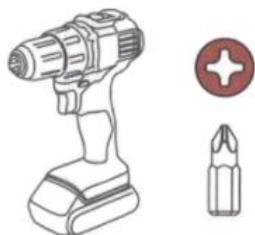



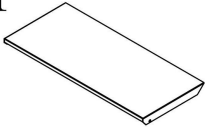
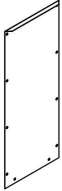
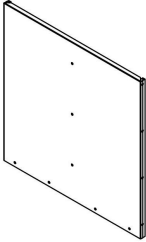
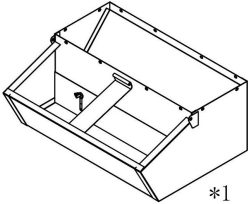

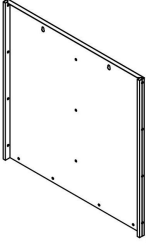
2. Använd handskar.



2. Rekommenderade verktyg, bormaskin med stjärnborr



PARTS LIST

<p>1</p>  <p>*1</p>	<p>2</p>  <p>*2</p>	<p>3</p>  <p>*1</p>
<p>4</p>  <p>*1</p>	<p>5</p>  <p>*2</p>	<p>6</p>  <p>*1</p>
<p>7</p>  <p>*1</p>	<p>8</p>  <p>Axostyle (1)</p>	<p>9</p>  <p>Washer (2)</p>
<p>10</p>  <p>Bayonet Lock (2)</p>	<p>11</p>  <p>M6X20mm (14) Bolit+Nut</p>	<p>12</p>  <p>M6X12MM(18) Bolt+Lock Washer+Nut</p>
<p>13</p>  <p>M6X20mm (2) Bolit+Nut</p>	<p>14</p>  <p>Spanner (1)</p>	<p>15</p>  <p>Wrench (1)</p>

INSTALLATION

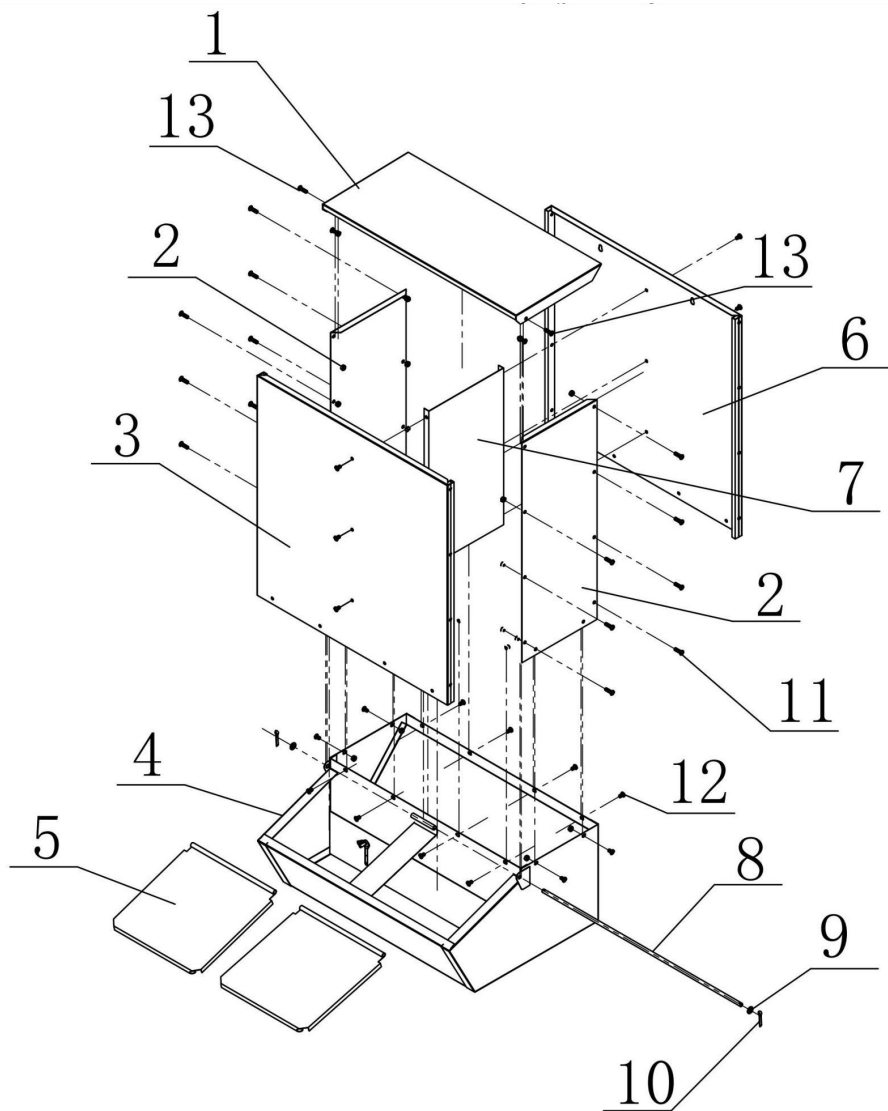

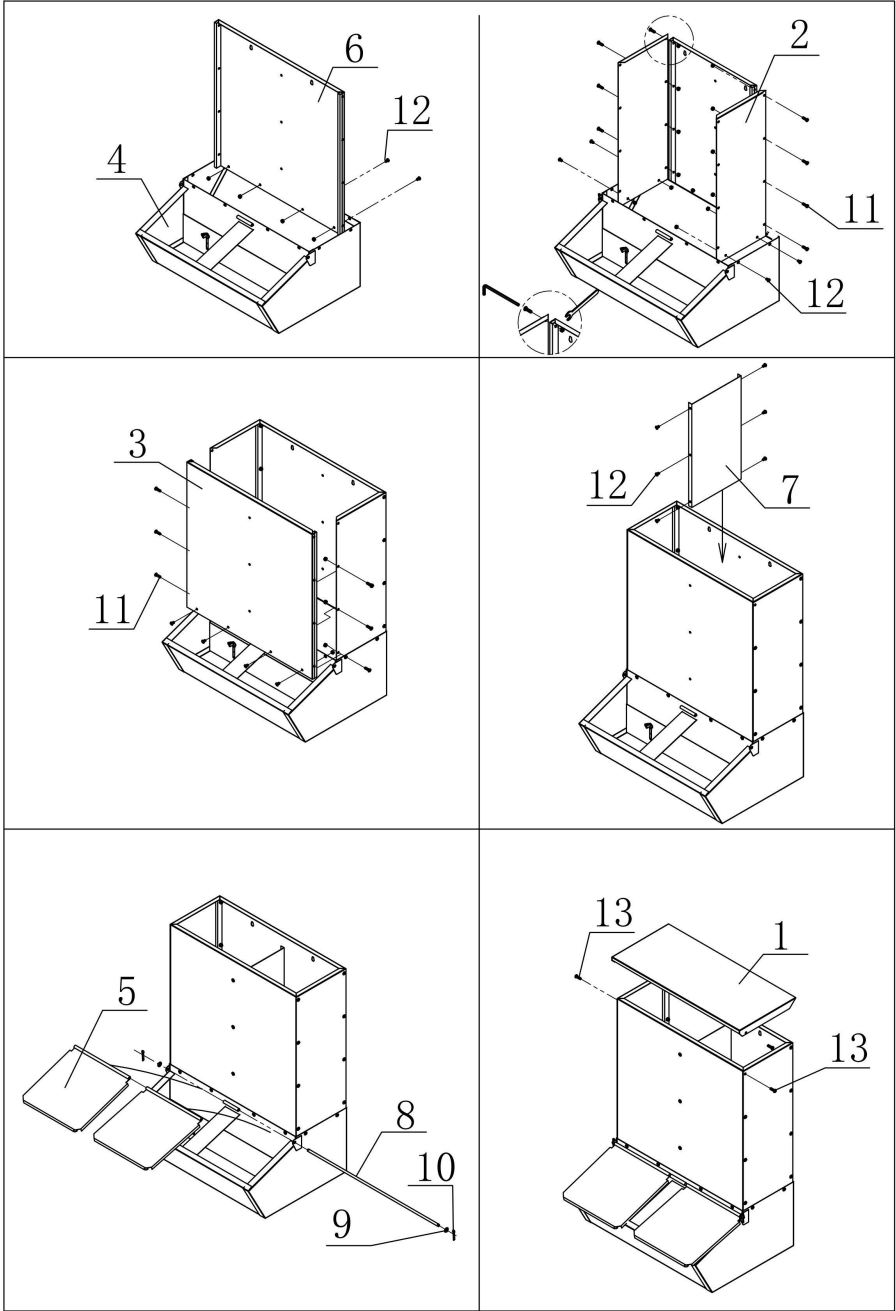

Tillverkare : Shanghaimuxinmuyeyouxiangongsi

Adress: Shuangchenglu 803nong11hao1602A-1609shi, baoshanqu, shanghai 200000 CN.

Importerad till AUS: SIHAO PTY LTD. 1 ROKEVA STREETEASTWOOD NSW 2122 Australien

Importerad till USA: Sanven Technology Ltd. Suite 250, 9166 Anaheim Place, Rancho Cucamonga, CA 91730

EC	REP
-----------	------------

E-CrossStu GmbH

Mainzer Landstr.69, 60329 Frankfurt am Main.

UK	REP
-----------	------------

YH CONSULTING LIMITED.

C/O YH Consulting Limited Office 147, Centurion House,
London Road, Staines-upon-Thames, Surrey, TW18 4AX

VEVOR[®]

TOUGH TOOLS, HALF PRICE

Teknisk Support och e-garanticertifikat

www.vevor.com/support

VEVOR[®]

TOUGH TOOLS, HALF PRICE

Técnico Soporte y certificado de garantía electrónica www.vevor.com/support

COMEDERO PARA GANADO

MANUAL DE USUARIO

Seguimos comprometidos a proporcionarle herramientas a precios competitivos. "Ahorre a mitad de precio", "A mitad de precio" o cualquier otra expresión similar utilizada por nosotros solo representa una estimación de los ahorros que podría beneficiarse al comprar ciertas herramientas con nosotros en comparación con las principales marcas y no significa necesariamente cubrir todas las categorías de herramientas ofrecidas por nosotros. Le recordamos que, cuando realice un pedido con nosotros, verifique cuidadosamente si realmente está ahorrando la mitad en comparación con las principales marcas.

VEVOR®

TOUGH TOOLS, HALF PRICE

LIVESTOCK FEEDER

Modelo : T1091

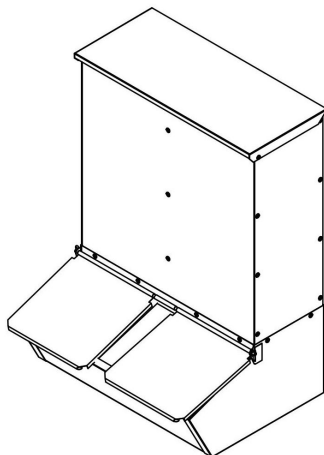

¿ NECESITAS AYUDA? ¡CONTACTANOS!

¿Tiene preguntas sobre el producto? ¿Necesita soporte técnico? No dude en contactarnos:

Soporte técnico y certificado de garantía electrónica www.vevor.com/support

Estas son las instrucciones originales; lea atentamente todas las instrucciones del manual antes de operar. VEVOR se reserva una interpretación clara de nuestro manual de usuario. La apariencia del producto estará sujeta al producto que recibió. Perdón que no le informaremos nuevamente si hay actualizaciones de tecnología o software en nuestro producto.



Precauciones de seguridad

Lea estas instrucciones antes de usar este producto. De lo contrario, se pueden producir lesiones graves. Siempre se deben seguir las precauciones básicas, incluidas las siguientes:

1. ¡TENGA EN CUENTA! Los dibujos de este manual son para Sólo con fines ilustrativos y en algunos detalles puede difieren del producto real.

2. Guía del usuario

No exceda el peso de la carga. El tornillo se fija en una superficie de pared plana y dura para un uso seguro.

Revise el comedero del ganado antes de cada uso. No lo utilice si las piezas están sueltas o dañadas.



Antes de ensamblar

Antes del montaje recomendamos:











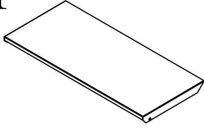
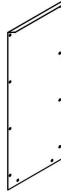
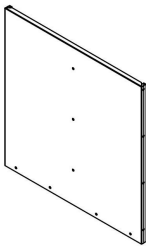
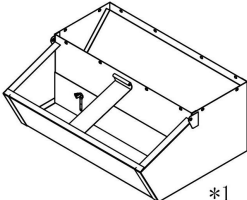

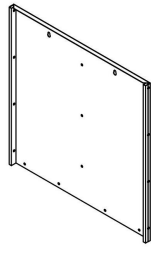
3. Use guantes.



2. Herramientas recomendadas, taladro eléctrico con broca Phillips



PARTS LIST

<p>1</p>  <p>*1</p>	<p>2</p>  <p>*2</p>	<p>3</p>  <p>*1</p>
<p>4</p>  <p>*1</p>	<p>5</p>  <p>*2</p>	<p>6</p>  <p>*1</p>
<p>7</p>  <p>*1</p>	<p>8</p>  <p>Axostyle (1)</p>	<p>9</p>  <p>Washer (2)</p>
<p>10</p>  <p>Bayonet Lock (2)</p>	<p>11</p>  <p>M6X20mm (14) Bolit+Nut</p>	<p>12</p>  <p>M6X12MM(18) Bolt+Lock Washer+Nut</p>
<p>13</p>  <p>M6X20mm (2) Bolit+Nut</p>	<p>14</p>  <p>Spanner (1)</p>	<p>15</p>  <p>Wrench (1)</p>

INSTALLATION

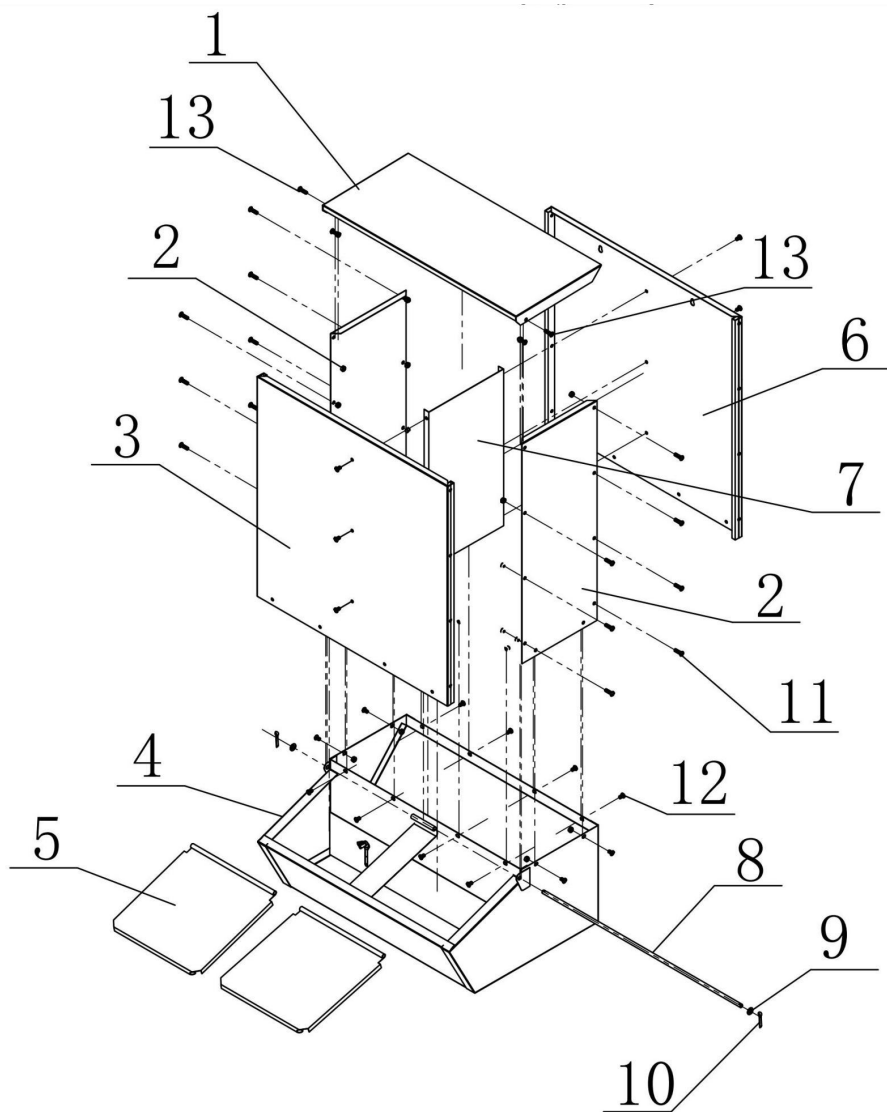

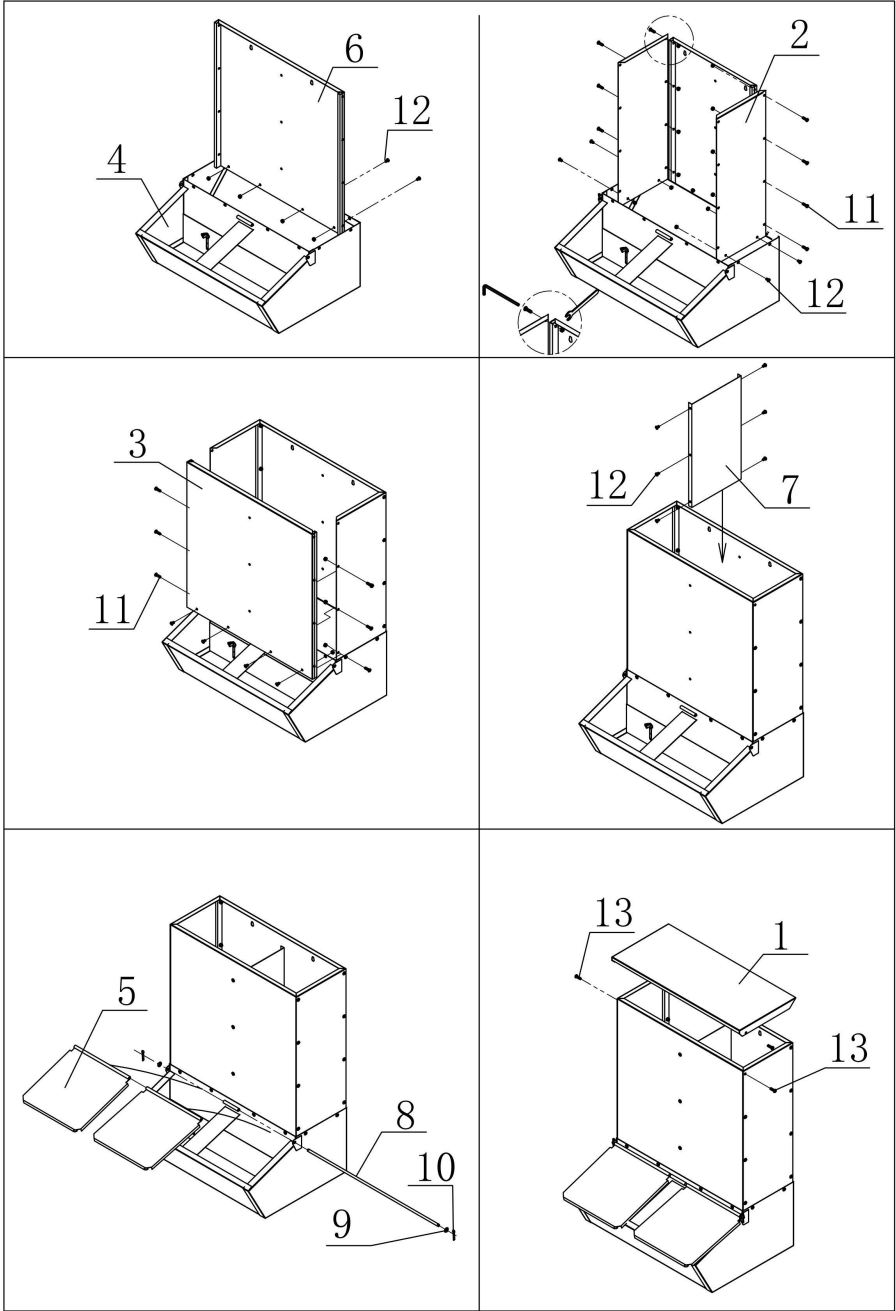

Fabricante : Shanghaimuxinmuyeyouxiangongsi

Dirección: Shuangchenglu 803nong11hao1602A-1609shi, baoshanqu, shanghai 200000 CN.

Importado a AUS: SIHAO PTY LTD. 1 ROKEVA STREET ASTWOOD NSW 2122 Australia

Importado a EE. UU.: Sanven Technology Ltd. Suite 250, 9166 Anaheim Lugar, Rancho Cucamonga, CA 91730

EC	REP
-----------	------------

E-CrossStu GmbH

Mainzer Landstr.69, 60329 Frankfurt am Main.

UK	REP
-----------	------------

YH CONSULTING LIMITED.

C/O YH Consulting Limited Office 147, Centurion House,
London Road, Staines-upon-Thames, Surrey, TW18 4AX

VEVOR[®]

TOUGH TOOLS, HALF PRICE

Técnico Certificado de soporte y garantía electrónica

www.vevor.com/support

VEVOR®

TOUGH TOOLS, HALF PRICE

Tecnico Supporto e certificato di garanzia elettronica www.vevor.com/support

ALIMENTATORE PER BESTIAME

MANUALE D'USO

Continuiamo a impegnarci per fornirvi strumenti a prezzi competitivi.

"Risparmia la metà", "Metà prezzo" o qualsiasi altra espressione simile da noi utilizzata rappresenta solo una stima del risparmio che potresti trarre dall'acquistare determinati strumenti con noi rispetto ai principali marchi più importanti e non significa necessariamente coprire tutte le categorie di strumenti offerti da noi. Ti ricordiamo di verificare attentamente quando effettui un ordine con noi se stai effettivamente risparmiando la metà rispetto ai migliori marchi principali.

VEVOR®

TOUGH TOOLS, HALF PRICE

LIVESTOCK FEEDER

Modello : T1091

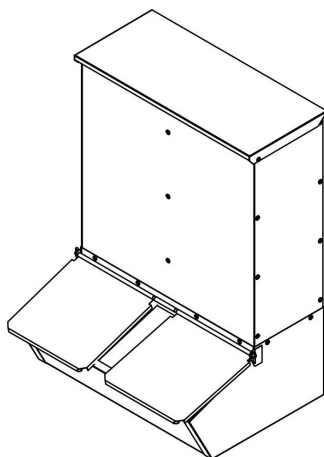

HAI BISOGNO DI AIUTO? CONTATTACI!

Hai domande sul prodotto? Hai bisogno di supporto tecnico? Non esitate a contattarci:

Supporto tecnico e certificato di garanzia elettronica www.vevor.com/support

Queste sono le istruzioni originali, leggere attentamente tutte le istruzioni del manuale prima dell'uso. VEVOR si riserva una chiara interpretazione del nostro manuale d'uso. L'aspetto del prodotto sarà soggetto al prodotto ricevuto. Ti preghiamo di perdonarci se non ti informeremo più se sono presenti aggiornamenti tecnologici o software sul nostro prodotto.



Precauzioni di sicurezza

Leggere queste istruzioni prima di utilizzare questo prodotto. In caso contrario si potrebbero causare lesioni gravi. È necessario seguire sempre le precauzioni di base, incluse le seguenti:

1. NOTARE CHE! I disegni contenuti in questo manuale servono solo a scopo illustrativo e in alcuni dettagli differire dal prodotto reale.

2. Guida per l'utente

Non superare il peso del carico. La vite è fissata su una superficie piana e dura della parete per un utilizzo sicuro

Controllare l'alimentatore per bestiame prima di ogni utilizzo. Non utilizzarlo se le parti sono allentate o danneggiate.



Prima dell'assemblaggio

Prima del montaggio consigliamo:











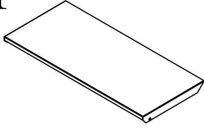
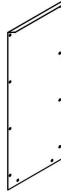
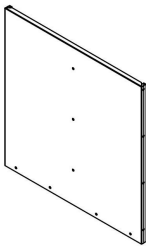
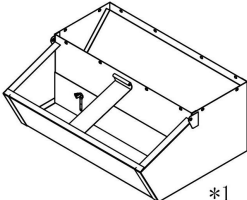

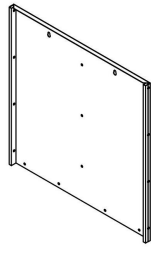
4. Indossare guanti.



2. Strumenti consigliati, trapano elettrico con punta Phillips



PARTS LIST

<p>1</p>  <p>*1</p>	<p>2</p>  <p>*2</p>	<p>3</p>  <p>*1</p>
<p>4</p>  <p>*1</p>	<p>5</p>  <p>*2</p>	<p>6</p>  <p>*1</p>
<p>7</p>  <p>*1</p>	<p>8</p>  <p>Axostyle (1)</p>	<p>9</p>  <p>Washer (2)</p>
<p>10</p>  <p>Bayonet Lock (2)</p>	<p>11</p>  <p>M6X20mm (14) Bolit+Nut</p>	<p>12</p>  <p>M6X12MM(18) Bolt+Lock Washer+Nut</p>
<p>13</p>  <p>M6X20mm (2) Bolit+Nut</p>	<p>14</p>  <p>Spanner (1)</p>	<p>15</p>  <p>Wrench (1)</p>

INSTALLATION

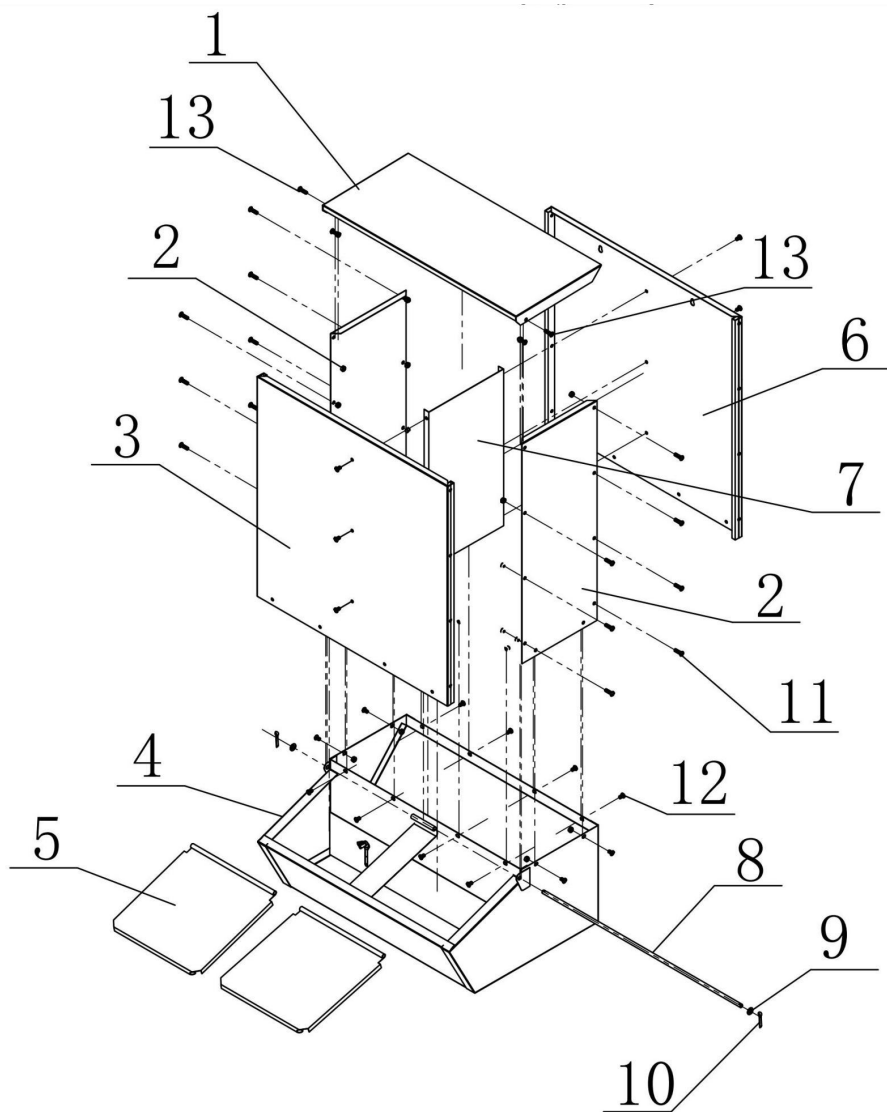

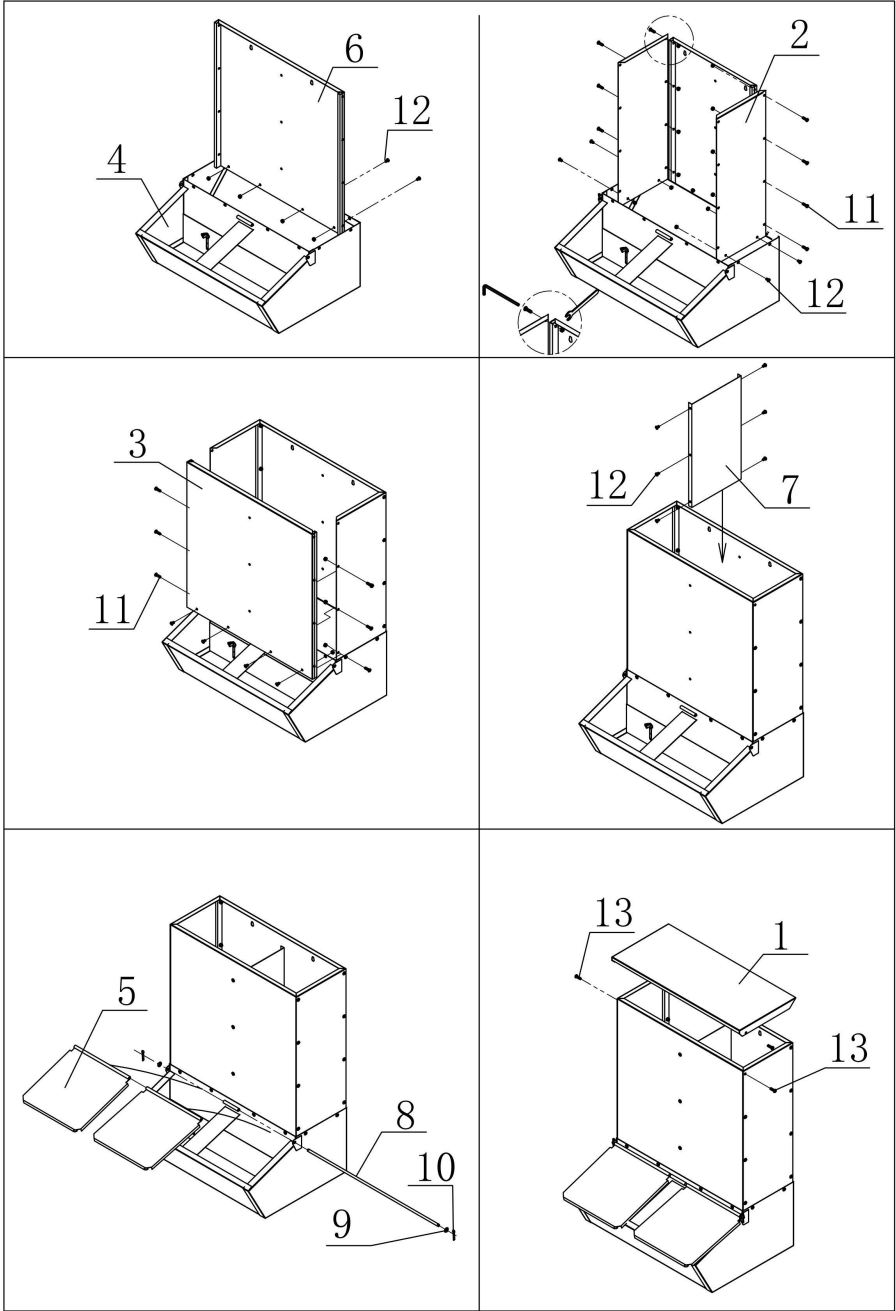

Produttore : Shanghaimuxinmuyeyouxiangongsi

Indirizzo: Shuangchenglu 803nong11hao1602A-1609shi, baoshanqu, shanghai 200000 CN.

Importato in Australia: SIHAO PTY LTD. 1 ROKEVA
STREETEASTWOOD NSW 2122 Australia

Importato negli Stati Uniti: Sanven Technology Ltd. Suite 250, 9166
Anaheim

Luogo, Rancho Cucamonga, CA 91730

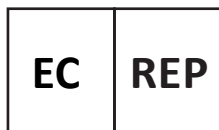

E-CrossStu GmbH

Mainzer Landstr.69, 60329 Frankfurt am Main.



YH CONSULTING LIMITED.

C/O YH Consulting Limited Office 147, Centurion House,
London Road, Staines-upon-Thames, Surrey, TW18 4AX

VEVOR[®]

TOUGH TOOLS, HALF PRICE

Tecnico Supporto e certificato di garanzia elettronica

www.vevor.com/support

VEVOR[®]

TOUGH TOOLS, HALF PRICE

Techniczny Certyfikat wsparcia i e-gwarancji www.vevor.com/support

KARMNIK DLA BYDŁA

INSTRUKCJA OBSŁUGI

Nadal dokładamy wszelkich starań, aby zapewnić Państwu narzędzia w konkurencyjnej cenie. „Zaoszczędź o połowę”, „o połowę ceny” lub inne podobne wyrażenia używane przez nas przedstawiają jedynie szacunkową oszczędność, jaką możesz zyskać kupując u nas określone narzędzia w porównaniu z głównymi najlepszymi markami i niekoniecznie oznaczają uwzględnienie wszystkich kategorii oferowanych narzędzi przez nas. Przypominamy, aby podczas składania zamówienia u nas dokładnie sprawdzić, czy faktycznie oszczędzasz połowę w porównaniu z czołowymi markami.

VEVOR®

TOUGH TOOLS, HALF PRICE

LIVESTOCK FEEDER

Model : T1091

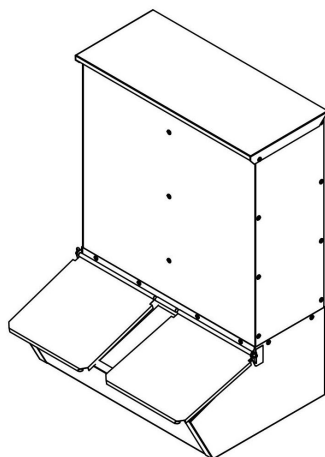

POTRZEBUJESZ POMOCY? SKONTAKTUJ SIĘ Z NAMI!

Masz pytania dotyczące produktu? Potrzebujesz wsparcia technicznego?

Zapraszamy do kontaktu z nami:

Wsparcie techniczne i certyfikat e-gwarancji www.vevor.com/support

To jest oryginalna instrukcja. Przed przystąpieniem do obsługi prosimy o dokładne zapoznanie się ze wszystkimi instrukcjami. VEVOR zastrzega sobie jasną interpretację naszej instrukcji obsługi. Wygląd produktu zależy od produktu, który otrzymałeś. Proszę wybaczyć nam, że nie będziemy ponownie informować Państwa, jeśli pojawią się jakieś aktualizacje technologii lub oprogramowania naszego produktu.



Środki ostrożności

Przeczytaj tę instrukcję przed użyciem tego produktu. Niezastosowanie się do tego może spowodować poważne obrażenia. należy zawsze przestrzegać podstawowych środków ostrożności , w tym:

1 . UWAGA! Rysunki w tej instrukcji służą do: wyłącznie w celach ilustracyjnych i w niektórych szczegółach może różnić się od rzeczywistego produktu.

2. Podręcznik użytkownika

Nie przekraczaj masy ładunku. Wkręt mocuje się na płaskiej, twardej powierzchni ściany, aby zapewnić bezpieczne użytkowanie

Przed każdym użyciem sprawdź karmnik dla zwierząt. Nie używaj go, jeśli części są luźne lub uszkodzone.



Przed montażem

Przed montażem zalecamy:











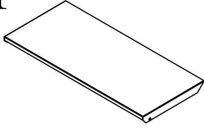
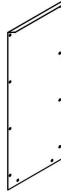
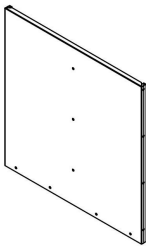
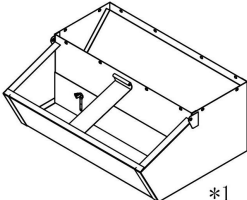

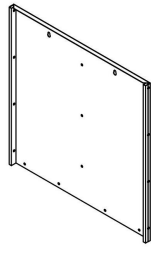
5. Nosić rękawiczki.



2. Zalecane narzędzia, wiertarka elektryczna z bitem krzyżakowym



PARTS LIST

<p>1</p>  <p>*1</p>	<p>2</p>  <p>*2</p>	<p>3</p>  <p>*1</p>
<p>4</p>  <p>*1</p>	<p>5</p>  <p>*2</p>	<p>6</p>  <p>*1</p>
<p>7</p>  <p>*1</p>	<p>8</p>  <p>Axostyle (1)</p>	<p>9</p>  <p>Washer (2)</p>
<p>10</p>  <p>Bayonet Lock (2)</p>	<p>11</p>  <p>M6X20mm (14) Bolit+Nut</p>	<p>12</p>  <p>M6X12MM(18) Bolt+Lock Washer+Nut</p>
<p>13</p>  <p>M6X20mm (2) Bolit+Nut</p>	<p>14</p>  <p>Spanner (1)</p>	<p>15</p>  <p>Wrench (1)</p>

INSTALLATION

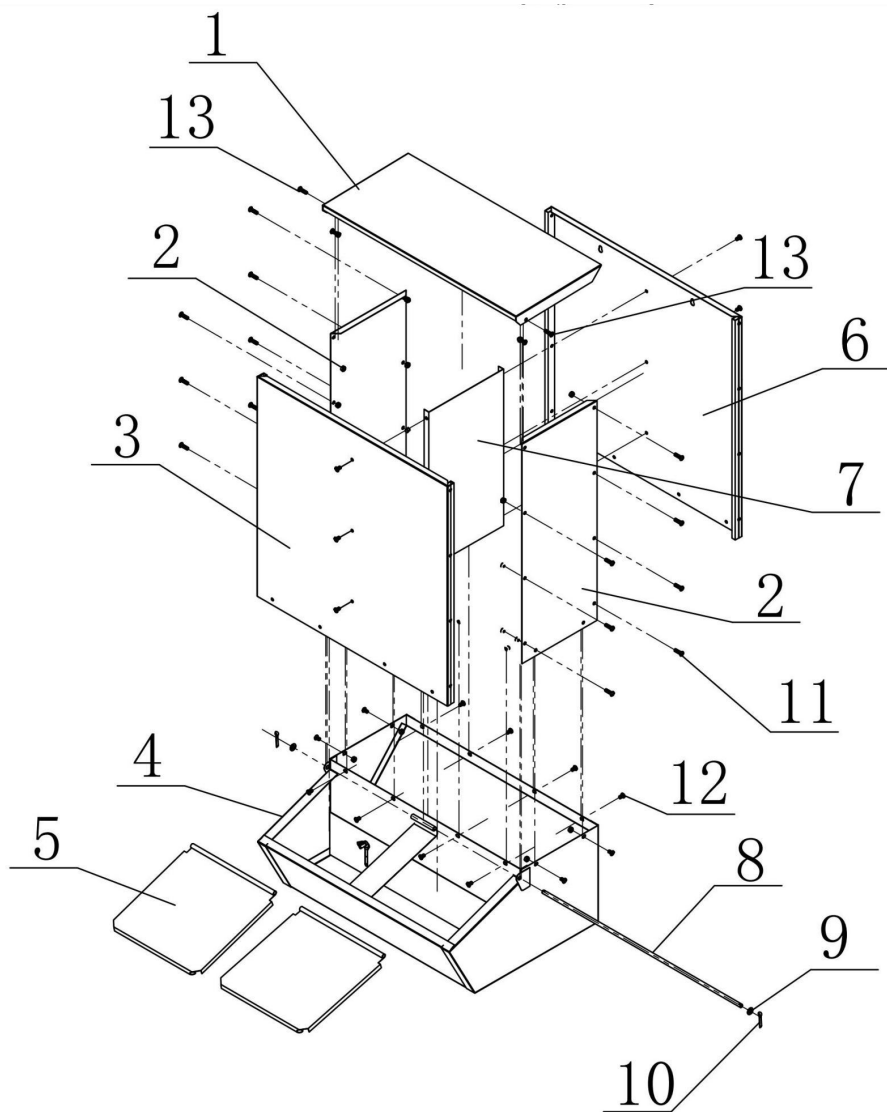

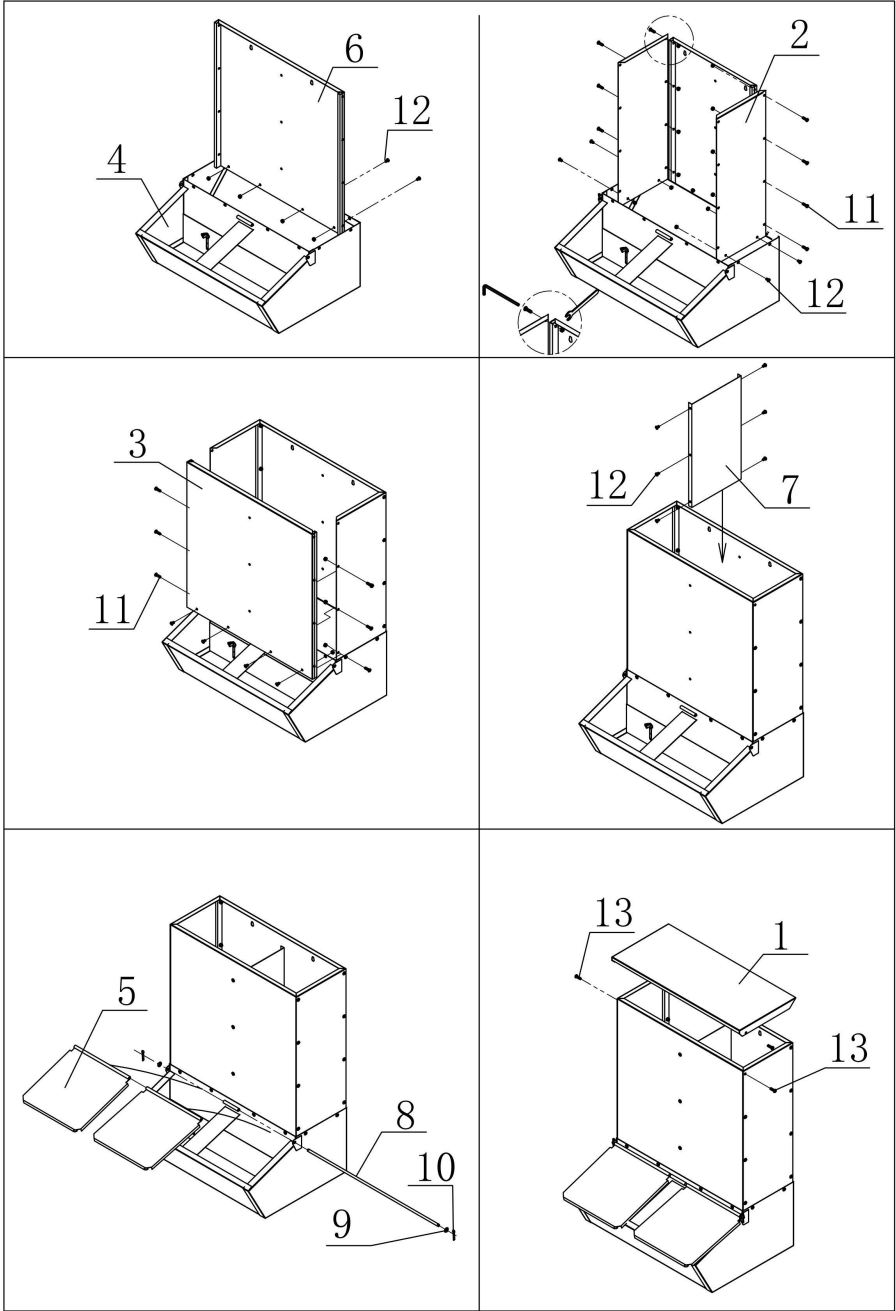

Producent : Shanghaimuxinmuyeyouxiangongsi

Adres: Shuangchenglu 803nong11hao1602A-1609shi, baoshanqu, szanghaj 200000 CN.

Import do AUS: SIHAO PTY LTD. 1 ROKEVA STREETEASTWOOD NSW 2122 Australia

Import do USA: Sanven Technology Ltd. Suite 250, 9166 Anaheim Place, Rancho Cucamonga, Kalifornia 91730

EC	REP
-----------	------------

E-CrossStu GmbH

Mainzer Landstr.69, 60329 Frankfurt am Main.

UK	REP
-----------	------------

YH CONSULTING LIMITED.

C/O YH Consulting Limited Office 147, Centurion House,
London Road, Staines-upon-Thames, Surrey, TW18 4AX

VEVOR[®]

TOUGH TOOLS, HALF PRICE

Techniczny Certyfikat wsparcia i e-gwarancji

www.vevor.com/support

VEVOR[®]

TOUGH TOOLS, HALF PRICE

Technisch Support und E-Garantie-Zertifikat www.vevor.com/support

VIEHFÜTTERER

BENUTZERHANDBUCH

Wir sind weiterhin bestrebt, Ihnen Werkzeuge zu wettbewerbsfähigen Preisen anzubieten. „Sparen Sie die Hälfte“, „Halber Preis“ oder andere ähnliche Ausdrücke, die wir verwenden, stellen nur eine Schätzung der Ersparnis dar, die Sie beim Kauf bestimmter Werkzeuge bei uns im Vergleich zu den großen Topmarken erzielen können, und decken nicht unbedingt alle von uns angebotenen Werkzeugkategorien ab. Wir möchten Sie freundlich daran erinnern, bei Ihrer Bestellung bei uns sorgfältig zu prüfen, ob Sie im Vergleich zu den großen Topmarken tatsächlich die Hälfte sparen.

VEVOR®

TOUGH TOOLS, HALF PRICE

LIVESTOCK FEEDER

Modell : T1091

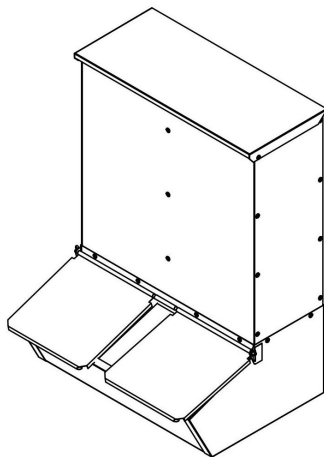

SIE HILFE? KONTAKTIEREN SIE UNS!

Sie haben Fragen zu unseren Produkten? Sie benötigen technischen Support?

Dann kontaktieren Sie uns gerne:

Technischer Support und E-Garantie-Zertifikat www.vevor.com/support

Dies ist die Originalanleitung. Bitte lesen Sie alle Anweisungen sorgfältig durch, bevor Sie das Gerät in Betrieb nehmen. VEVOR behält sich eine klare Auslegung unserer Bedienungsanleitung vor. Das Erscheinungsbild des Produkts richtet sich nach dem Produkt, das Sie erhalten haben. Bitte verzeihen Sie uns, dass wir Sie nicht erneut informieren, wenn es Technologie- oder Software-Updates für unser Produkt gibt.



Sicherheitsvorkehrungen

Lesen Sie diese Anweisungen, bevor Sie dieses Produkt verwenden. Andernfalls kann es zu schweren Verletzungen kommen. Die grundlegenden Vorsichtsmaßnahmen sollten immer befolgt werden, einschließlich der folgenden:

1. BITTE BEACHTEN! Die Zeichnungen in diesem Handbuch dienen lediglich Illustrationszwecken und können in einigen vom tatsächlichen Produkt abweichen.

2. Benutzerhandbuch

Das Ladegewicht darf nicht überschritten werden. Die Schraube ist zur sicheren Verwendung an einer flachen, harten Wandfläche befestigt.

Überprüfen Sie den Futterautomaten vor jedem Gebrauch. Verwenden Sie ihn nicht, wenn Teile lose oder beschädigt sind.



Vor dem Zusammenbau

Vor der Montage empfehlen wir:







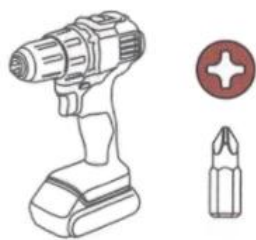



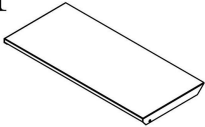
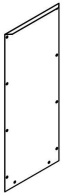
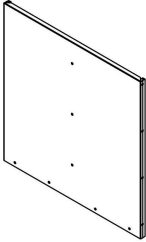
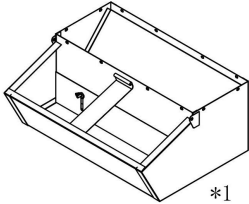

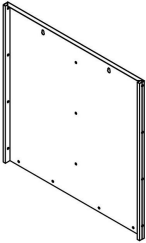
6. Tragen Sie Handschuhe.



2. Empfohlene Werkzeuge, Bohrmaschine mit Kreuzschlitz-Bit



PARTS LIST

<p>1</p>  <p>*1</p>	<p>2</p>  <p>*2</p>	<p>3</p>  <p>*1</p>
<p>4</p>  <p>*1</p>	<p>5</p>  <p>*2</p>	<p>6</p>  <p>*1</p>
<p>7</p>  <p>*1</p>	<p>8</p>  <p>Axostyle (1)</p>	<p>9</p>  <p>Washer (2)</p>
<p>10</p>  <p>Bayonet Lock (2)</p>	<p>11</p>  <p>M6X20mm (14) Bolit+Nut</p>	<p>12</p>  <p>M6X12MM(18) Bolt+Lock Washer+Nut</p>
<p>13</p>  <p>M6X20mm (2) Bolit+Nut</p>	<p>14</p>  <p>Spanner (1)</p>	<p>15</p>  <p>Wrench (1)</p>

INSTALLATION

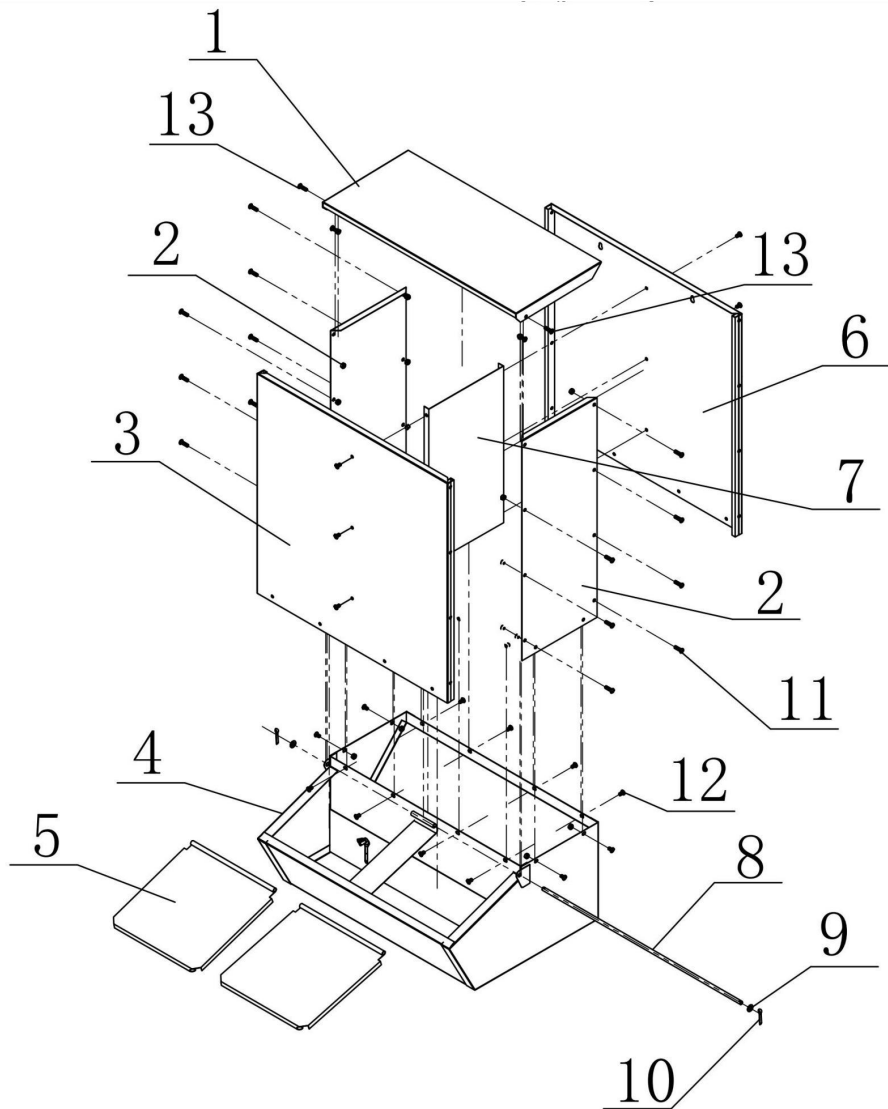

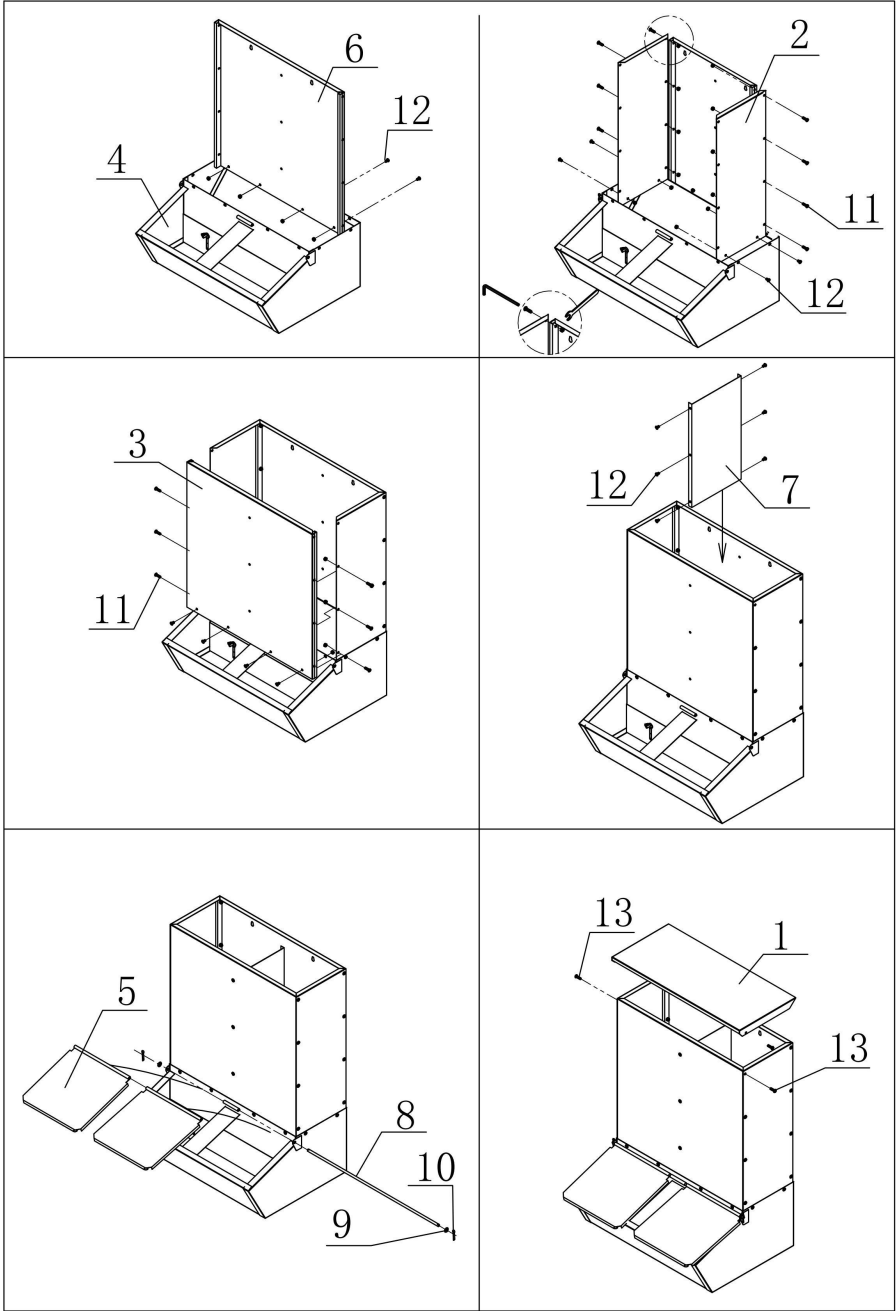

Hersteller : Shanghaimuxinmuyeyouxiangongsi

Adresse: Shuangchenglu 803nong11hao1602A-1609shi, baoshanqu, Shanghai 200000 CN.

Nach AUS importiert: SIHAO PTY LTD. 1 ROKEVA
STREETEASTWOOD NSW 2122 Australien

Importiert in die USA: Sanven Technology Ltd. Suite 250, 9166 Anaheim
Ort, Rancho Cucamonga, CA 91730

EC	REP
-----------	------------

E-CrossStu GmbH

Mainzer Landstr.69, 60329 Frankfurt am Main.

UK	REP
-----------	------------

YH CONSULTING LIMITED.

C/O YH Consulting Limited Office 147, Centurion House,
London Road, Staines-upon-Thames, Surrey, TW18 4AX

VEVOR[®]

TOUGH TOOLS, HALF PRICE

Technisch Support und E-Garantie-Zertifikat

www.vevor.com/support

VEVOR[®]

TOUGH TOOLS, HALF PRICE

Technique Assistance et certificat de garantie électronique

www.vevor.com/support

MANGEOIRE À BÉTAIL

MANUEL D'UTILISATION

Nous continuons à nous engager à vous fournir des outils à des prix compétitifs. "Économisez la moitié", "Moitié prix" ou toute autre expression similaire que nous utilisons ne représente qu'une estimation des économies dont vous pourriez bénéficier en achetant certains outils chez nous par rapport aux grandes marques et ne signifie pas nécessairement couvrir toutes les catégories d'outils proposés. par nous. Nous vous rappelons de bien vouloir vérifier attentivement lorsque vous passez une commande chez nous si vous économisez réellement la moitié par rapport aux grandes marques.

VEVOR®

TOUGH TOOLS, HALF PRICE

LIVESTOCK FEEDER

Modèle : T1091

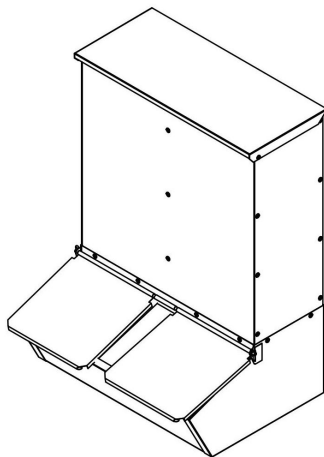

BESOIN D'AIDE ? CONTACTEZ-NOUS!

Vous avez des questions sur les produits ? Besoin d'une assistance technique ?

N'hésitez pas à nous contacter :

Assistance technique et certificat de garantie électronique www.vevor.com/support

Il s'agit des instructions originales, veuillez lire attentivement toutes les instructions du manuel avant de l'utiliser. VEVOR se réserve une interprétation claire de notre manuel d'utilisation. L'apparence du produit dépend du produit que vous avez reçu. Veuillez nous pardonner que nous ne vous informerons plus s'il y a des mises à jour technologiques ou logicielles sur notre produit.



Précautions de sécurité

Lisez ces instructions avant d'utiliser ce produit. Ne pas le faire peut entraîner des blessures graves. Les précautions de base doivent toujours être suivies, notamment les suivantes :

1. VEUILLEZ NOTER! Les dessins de ce manuel sont destinés à titre d'illustration uniquement et dans certains détails, peut différer du produit réel.

2. Guide de l'utilisateur

Ne dépassez pas le poids de la charge. La vis est fixée sur une surface murale plane et dure pour une utilisation en toute sécurité

Vérifiez la mangeoire pour bétail avant chaque utilisation. Ne l'utilisez pas si les pièces sont desserrées ou endommagées.



Avant l'assemblage

Avant le montage, nous recommandons :











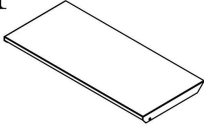
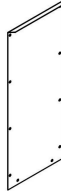
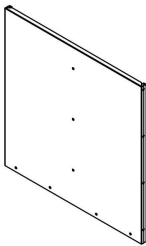
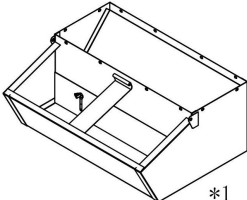

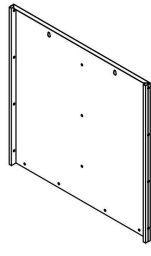
7. Portez des gants.



2. Outils recommandés, perceuse électrique avec embout Phillips



PARTS LIST

<p>1</p>  <p>*1</p>	<p>2</p>  <p>*2</p>	<p>3</p>  <p>*1</p>
<p>4</p>  <p>*1</p>	<p>5</p>  <p>*2</p>	<p>6</p>  <p>*1</p>
<p>7</p>  <p>*1</p>	<p>8</p>  <p>Axostyle (1)</p>	<p>9</p>  <p>Washer (2)</p>
<p>10</p>  <p>Bayonet Lock (2)</p>	<p>11</p>  <p>M6X20mm (14) Bolit+Nut</p>	<p>12</p>  <p>M6X12MM(18) Bolt+Lock Washer+Nut</p>
<p>13</p>  <p>M6X20mm (2) Bolit+Nut</p>	<p>14</p>  <p>Spanner (1)</p>	<p>15</p>  <p>Wrench (1)</p>

INSTALLATION

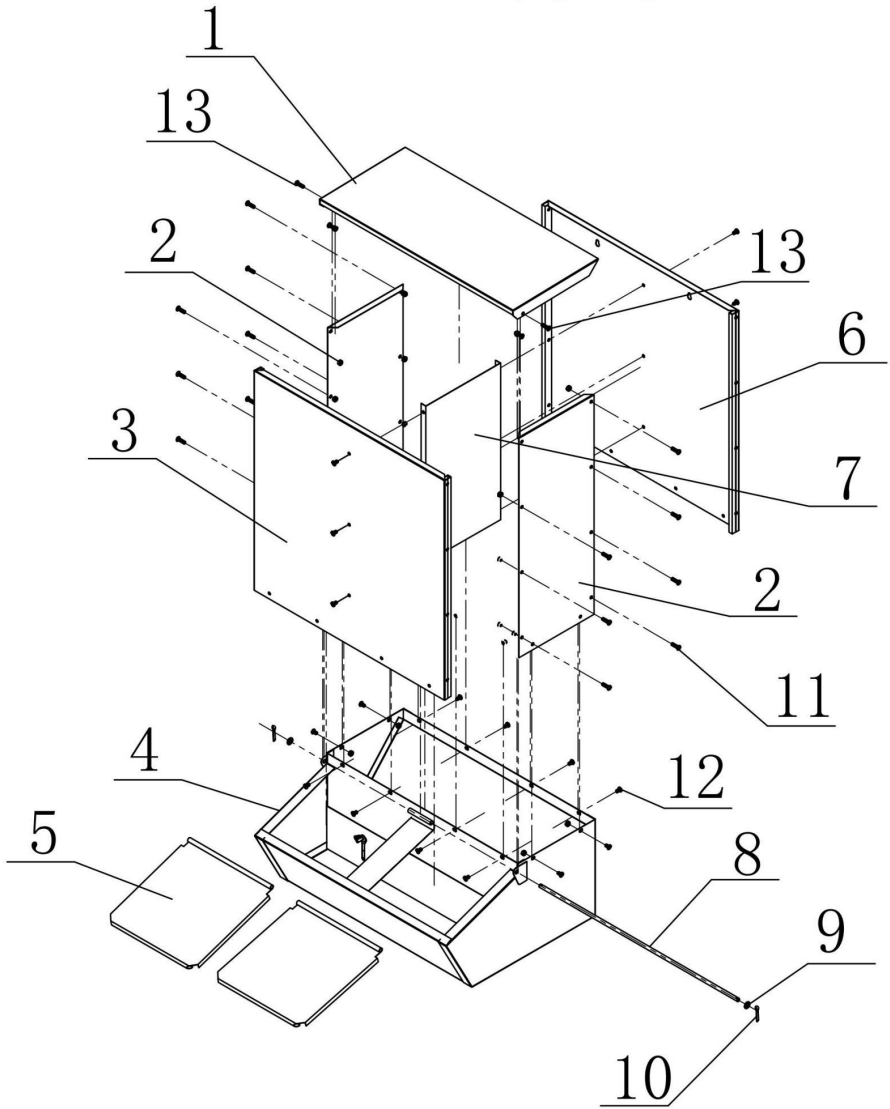

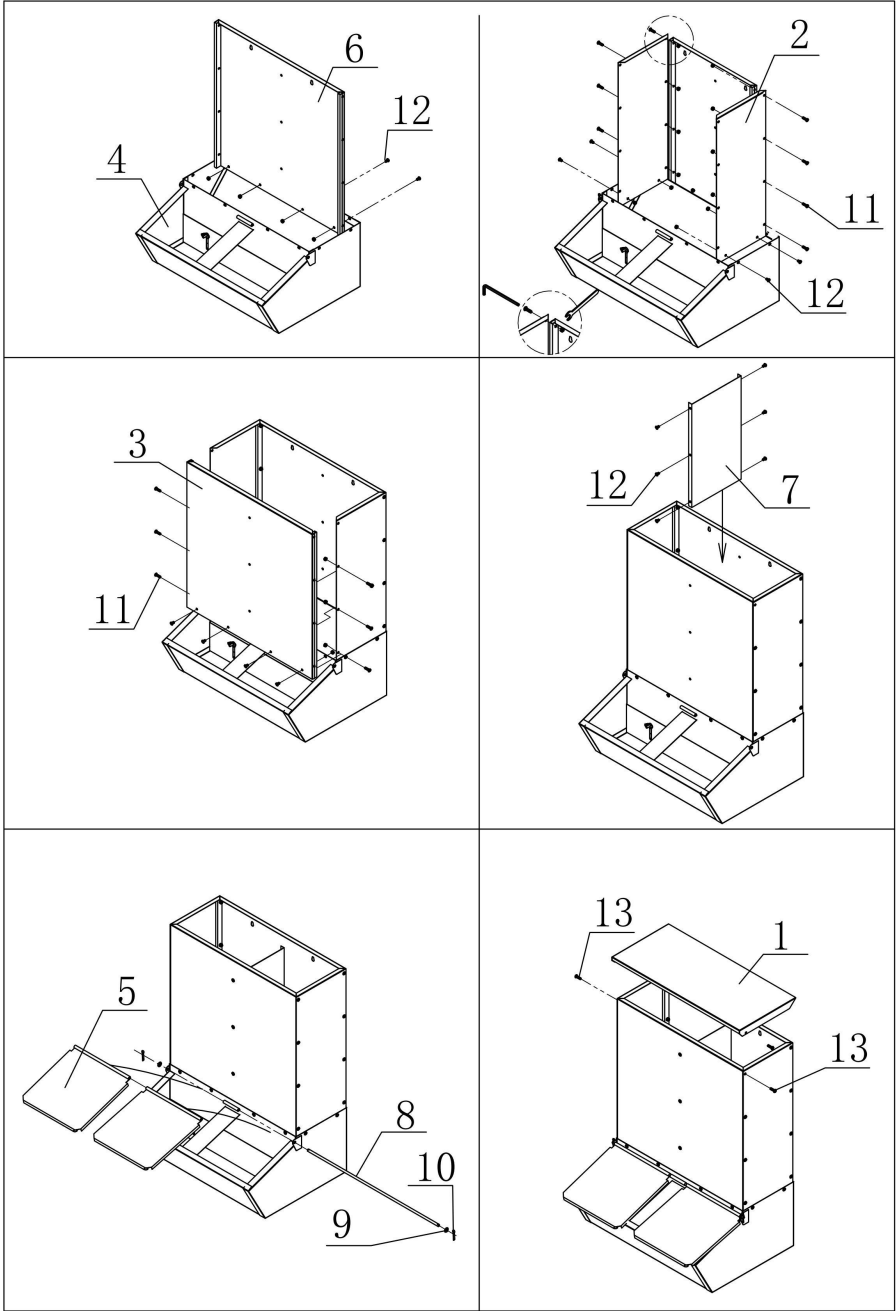

Fabricant : Shanghaimuxinmuyeyouxiangongsi

Adresse : Shuangchenglu 803nong11hao1602A-1609shi, baoshanqu, shanghai 200000 CN.

Importé en Australie : SIHAO PTY LTD. 1 ROKEVA STREETASTWOOD NSW 2122 Australie

Importé aux États-Unis : Sanven Technology Ltd. Suite 250, 9166 Anaheim

Lieu, Rancho Cucamonga, CA 91730

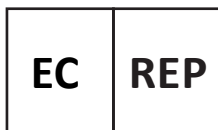

E-CrossStu GmbH

Mainzer Landstr.69, 60329 Frankfurt am Main.



YH CONSULTING LIMITED.

C/O YH Consulting Limited Office 147, Centurion House, London Road, Staines-upon-Thames, Surrey, TW18 4AX

VEVOR[®]

TOUGH TOOLS, HALF PRICE

Technique Assistance et certificat de garantie électronique

www.vevor.com/support

VEVOR[®]

TOUGH TOOLS, HALF PRICE

Technisch Ondersteuning en e-garantiecertificaat www.vevor.com/support

VEEVOEDER

GEBRUIKERSHANDLEIDING

Wij blijven ons inzetten om u gereedschap te bieden tegen een concurrerende prijs. 'Bespaar de helft', 'Halve prijs' of andere soortgelijke uitdrukkingen die door ons worden gebruikt vertegenwoordigen slechts een schatting van de besparingen die u zou kunnen profiteren als u bepaalde gereedschappen bij ons koopt in vergelijking met de grote topmerken en betekenen niet noodzakelijkerwijs dat ze alle aangeboden categorieën gereedschappen dekken. door ons. U wordt er vriendelijk aan herinnerd om bij het plaatsen van een bestelling bij ons zorgvuldig te verifiëren of u daadwerkelijk de helft bespaart in vergelijking met de grote topmerken.

VEVOR®

TOUGH TOOLS, HALF PRICE

LIVESTOCK FEEDER

Model : T1091

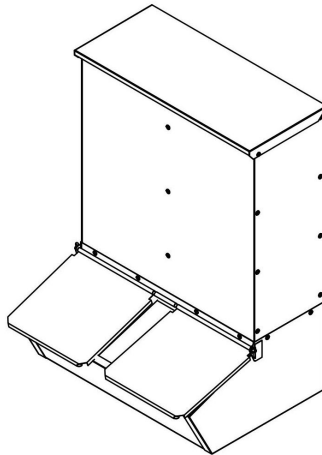

NODIG ? NEEM CONTACT MET ONS OP!

Heeft u productvragen? Technische ondersteuning nodig? Neem gerust contact met ons op:

Technische ondersteuning en e-garantiecertificaat www.vevor.com/support

Dit is de originele instructie. Lees alle handleidingen zorgvuldig door voordat u ermee aan de slag gaat. VEVOR behoudt zich een duidelijke interpretatie van onze gebruikershandleiding voor. Het uiterlijk van het product is afhankelijk van het product dat u heeft ontvangen. Vergeef ons alstublieft dat we u niet opnieuw informeren als er technologie- of software-updates zijn voor ons product.



Veiligheidsmaatregelen

Lees deze instructies voordat u dit product gebruikt. Als u dit niet doet, kan dit leiden tot ernstig letsel. de basisvoorzorgsmaatregelen moeten altijd worden gevolgd , waaronder de volgende:

1 . LET OP! De tekeningen in deze handleiding zijn bedoeld voor alleen ter illustratie en in sommige details mogelijk afwijken van het daadwerkelijke product.

2. Gebruikershandleiding

Overschrijd het laadgewicht niet. De schroef wordt voor veilig gebruik op een vlak, hard muuroppervlak bevestigd

Controleer de veevoederautomaat voor elk gebruik. Gebruik het niet als onderdelen loszitten of beschadigd zijn.



Vóór de montage

Voordat u met de montage begint, raden wij u aan:











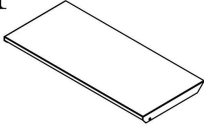
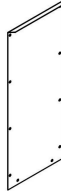
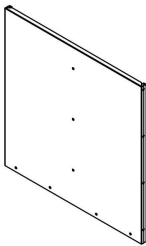
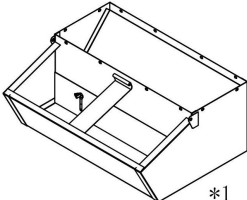

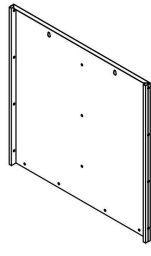
8. Draag handschoenen.



2. Aanbevolen gereedschap, boormachine met kruiskopbit



PARTS LIST

<p>1</p>  <p>*1</p>	<p>2</p>  <p>*2</p>	<p>3</p>  <p>*1</p>
<p>4</p>  <p>*1</p>	<p>5</p>  <p>*2</p>	<p>6</p>  <p>*1</p>
<p>7</p>  <p>*1</p>	<p>8</p>  <p>Axostyle (1)</p>	<p>9</p>  <p>Washer (2)</p>
<p>10</p>  <p>Bayonet Lock (2)</p>	<p>11</p>  <p>M6X20mm (14) Bolit+Nut</p>	<p>12</p>  <p>M6X12MM(18) Bolt+Lock Washer+Nut</p>
<p>13</p>  <p>M6X20mm (2) Bolit+Nut</p>	<p>14</p>  <p>Spanner (1)</p>	<p>15</p>  <p>Wrench (1)</p>

INSTALLATION

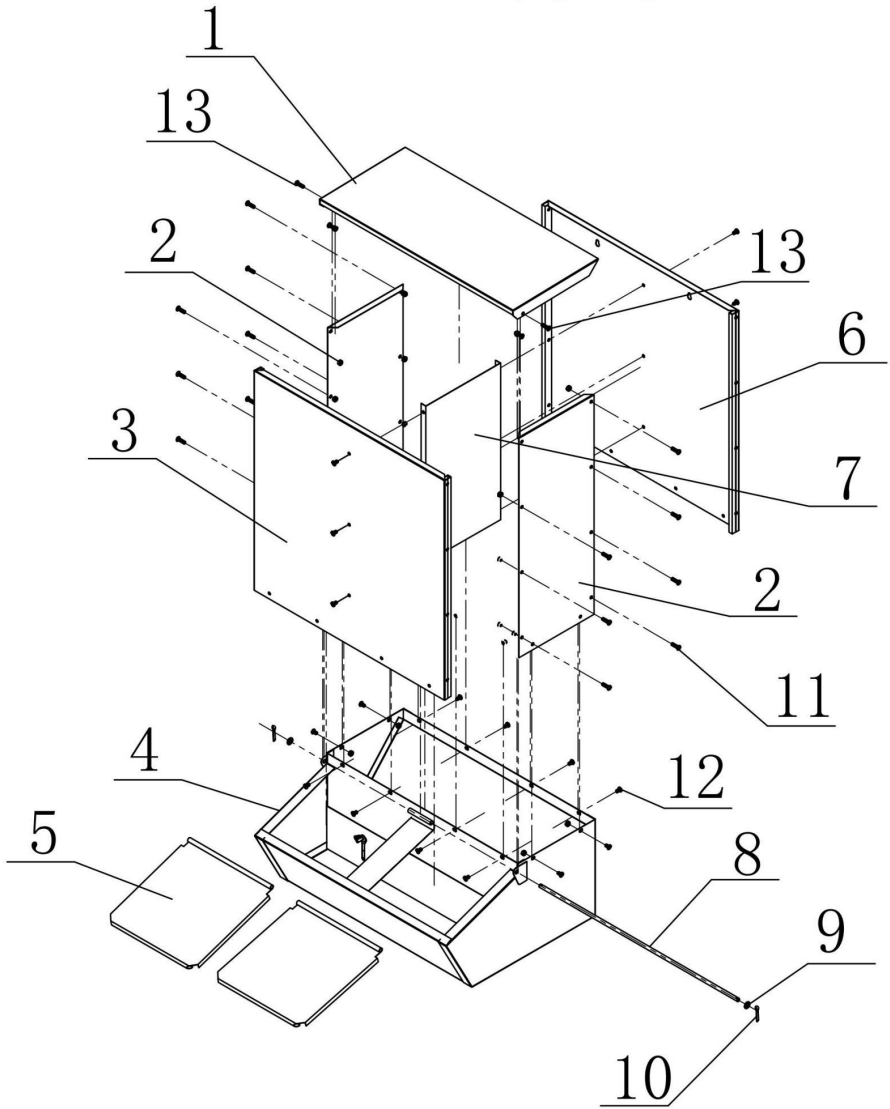

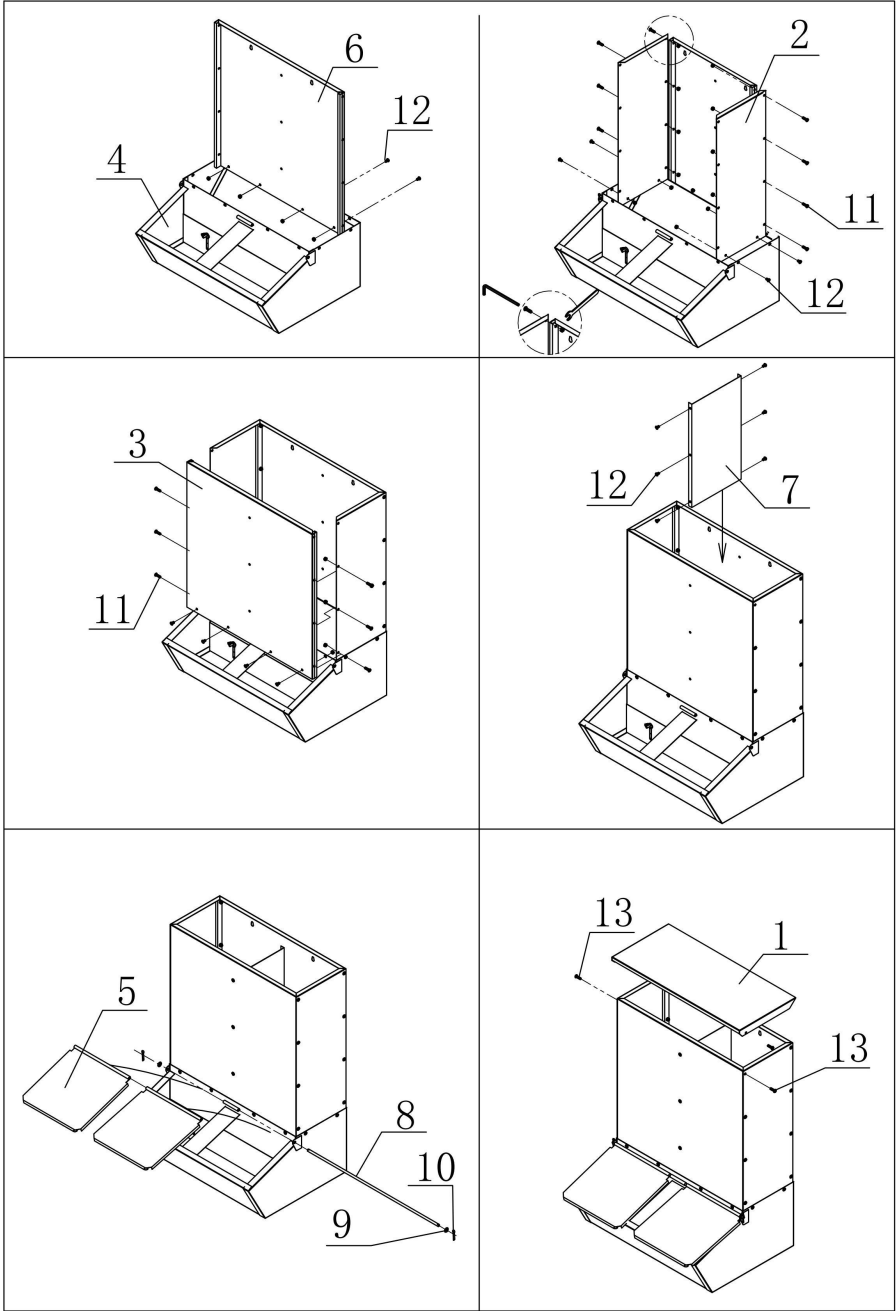

Fabrikant : Shanghaimuxinmuyeyouxiangongsi

Adres: Shuangchenglu 803nong11hao1602A-1609shi, baoshanqu, shanghai 200000 CN.

Geïmporteerd naar AUS: SIHAO PTY LTD. 1 ROKEVA
STREETEASTWOOD NSW 2122 Australië

Geïmporteerd in de VS: Sanven Technology Ltd. Suite 250, 9166
Anaheim

Plaats, Rancho Cucamonga, CA 91730

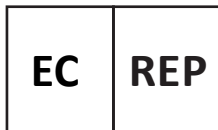

E-CrossStu GmbH

Mainzer Landstr.69, 60329 Frankfurt am Main.



YH CONSULTING LIMITED.

C/O YH Consulting Limited Office 147, Centurion House,
London Road, Staines-upon-Thames, Surrey, TW18 4AX

VEVOR[®]

TOUGH TOOLS, HALF PRICE

Technisch Ondersteuning en e-garantiecertificaat

www.vevor.com/support