

# **VEVOR**®

## **TOUGH TOOLS, HALF PRICE**

Technical Support and E-Warranty Certificate

[www.vevor.com/support](http://www.vevor.com/support)

# **OUTDOOR STORAGE SHELTER USER MANUAL**

We continue to be committed to provide you tools with competitive price.

"Save Half", "Half Price" or any other similar expressions used by us only represents an estimate of savings you might benefit from buying certain tools with us compared to the major top brands and does not necessarily mean to cover all categories of tools offered by us. You are kindly reminded to verify carefully when you are placing an order with us if you are actually saving half in comparison with the top major brands.

# VEVOR<sup>®</sup> OUTDOOR STORAGE SHELTER

MODEL:SCP0712/SCP0814

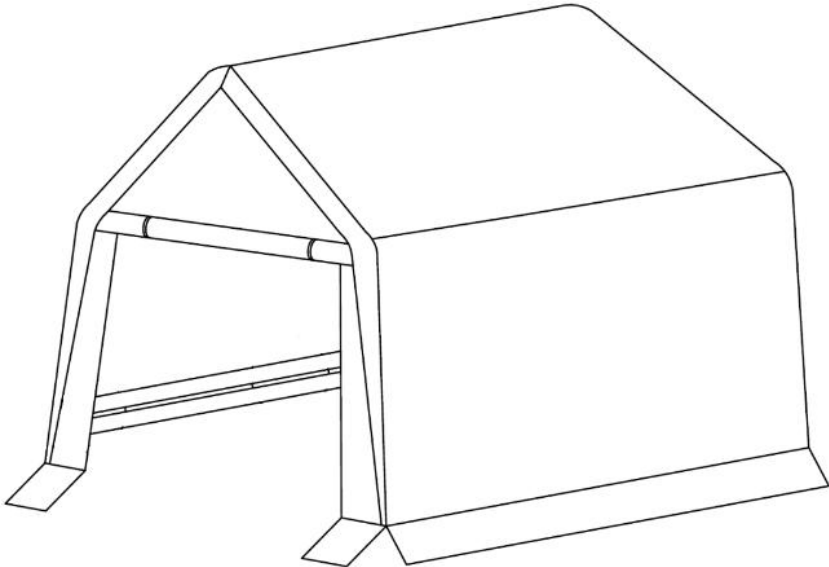

## NEED HELP? CONTACT US!

Have product questions? Need technical support? Please feel free to contact us:

**Technical Support and E-Warranty Certificate [www.vevor.com/support](http://www.vevor.com/support)**

This is the original instruction, please read all manual instructions carefully before operating. VEVOR reserves a clear interpretation of our user manual. The appearance of the product shall be subject to the product you received. Please forgive us that we won't inform you again if there are any technology or software updates on our product.

## SAFETY INSTRUCTIONS





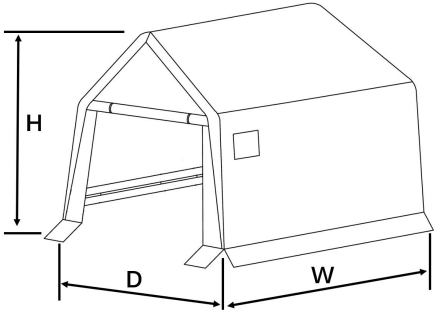



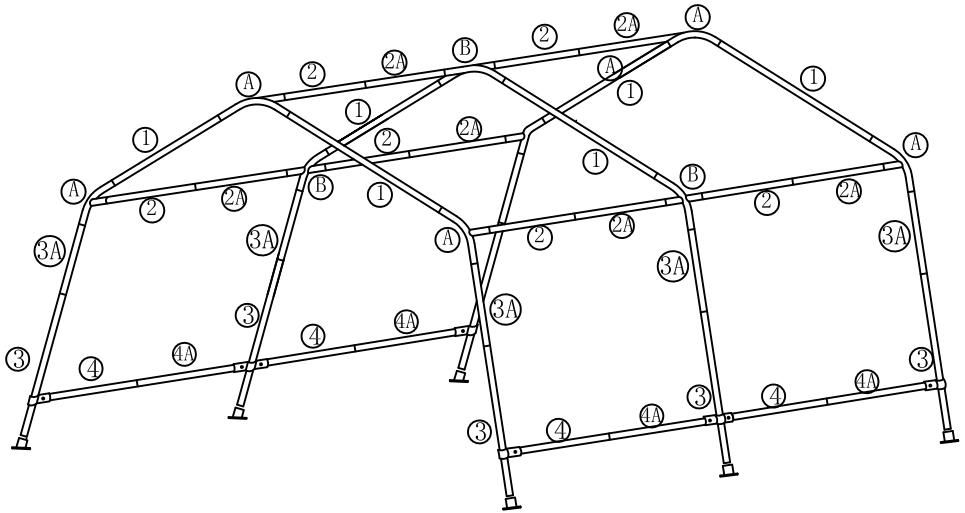

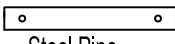

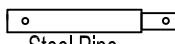
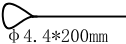
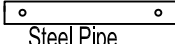

1. The instant garage needs to be installed on the smooth grass.
2. It is recommended to wear gloves during assembly.
3. You may need to use a ladder during assembly. Please pay attention to safety.
4. If any part of the product is damaged, please do not use it.
5. Do not stand or sit on top of the instant garage.
6. Do not smoke or use open flame devices in and around the instant garage to avoid fire.
7. In bad weather, the instant garage needs to be put away.
8. It is not recommended to use it in snowy conditions.
9. Assemble in strict accordance with the instructions, and use rope, anchor, and other accessories in the assembly process.

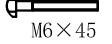
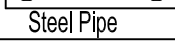
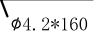
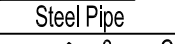
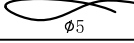
## MODEL AND PARAMETERS

Appearance	Color	Size (D*W*H)	Net Weight
	Gray	<b>(SCP0712)</b> 7*12*7.36FT	79.3lbs
	Gray	<b>(SCP0814)</b> 8*14*7.6FT	87.7lbs

# COMPONENTS



1#	 Steel Pipe	6pcs	D1#	 Rail Clamp	4pcs
2#	 Steel Pipe	6pcs	E#	 Anchor $\phi 4. 4*200mm$	4pcs
2A#	 Steel Pipe	6pcs	F#	 Bungee Cord	32+4pcs
3#	 Steel Pipe	6pcs	G#	 M8×50mm Screw	6+4pcs
3A#	 Steel Pipe	6pcs	H#	 M6×45mm Screw	16+1pcs
4#	 Steel Pipe	4pcs	I#	 Ground Peg $\phi 4. 2*160$	18pcs
4A#	 Steel Pipe	4pcs	J#	 Rope $\phi 5$	4pcs
A#	 3-way Corner Connector	6pcs	K#	 Roof Cover	1pc
B#	 4-way Corner Connector	3pcs	K1#	 Door Cover	1pc
C#	 Foot Plate	6pcs	K2#	 Back Cover	1pc
D#	 Rail Clamp	8pcs			

## ASSEMBLY

1

Find out (A,B,1,2,2A)parts,and place them according to the position of the parts in the picture.

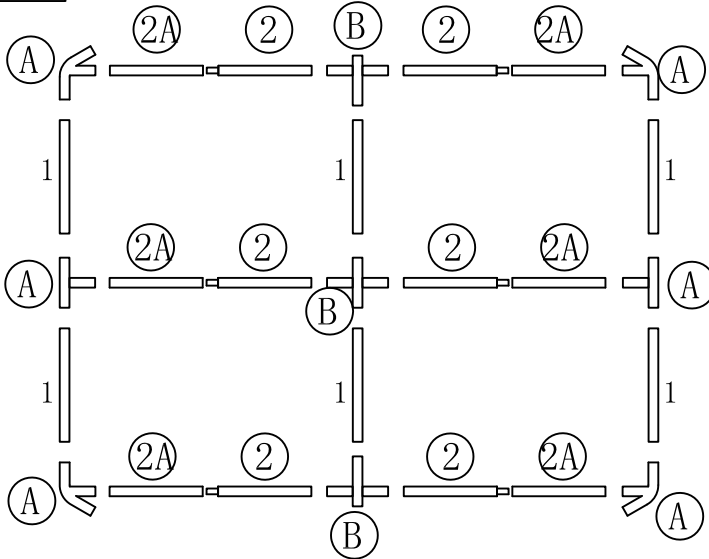

2

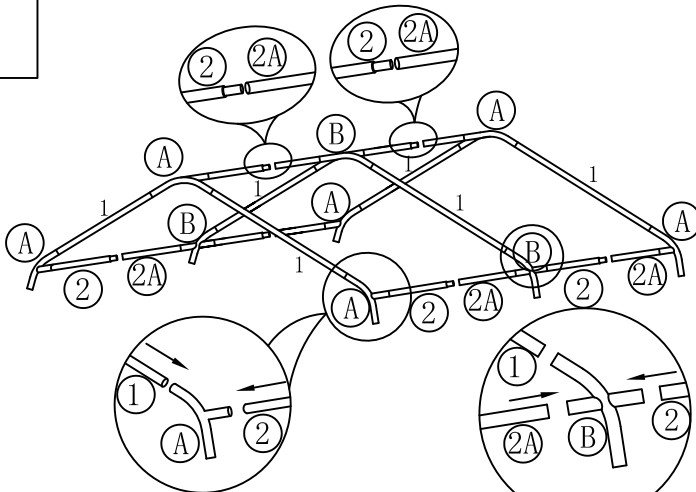

Assemble ridge using two Steel Pipes(2) with 4-Way Corner Connectors(B) between them,and a 3-Way Corner Connector(A) on each end. Connect a Steel Pipe(1) to each end of every connector (A,B) to get the roof frame.

3

Put the flat end of 3A# into connector A#,B# and then connect 3# pipe to 3A#.

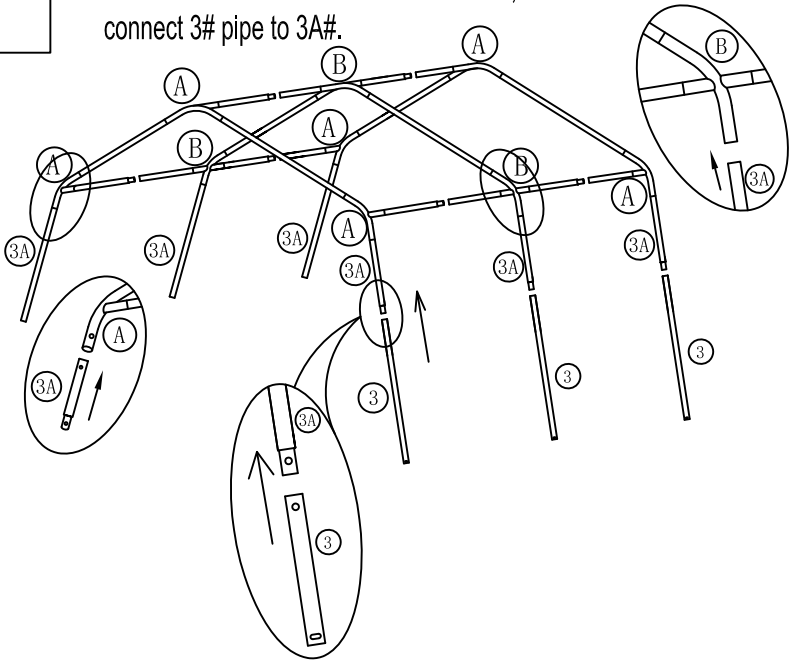

4

Put the Roof Cover(K) on the top frame.

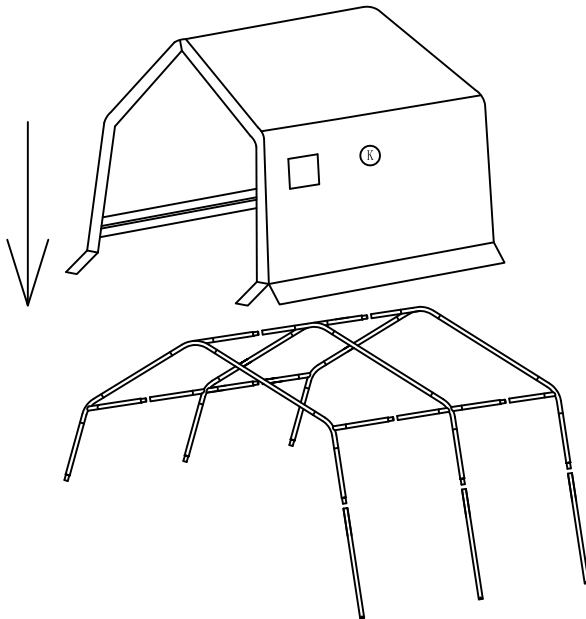

5

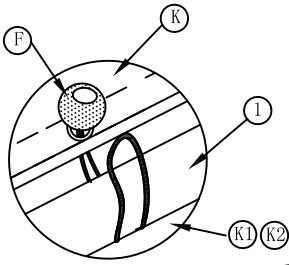

Assemble the Door Cover(K1) and Back Cover(K2) to the Steel Pipe(1) with the Bungee Cord(F)

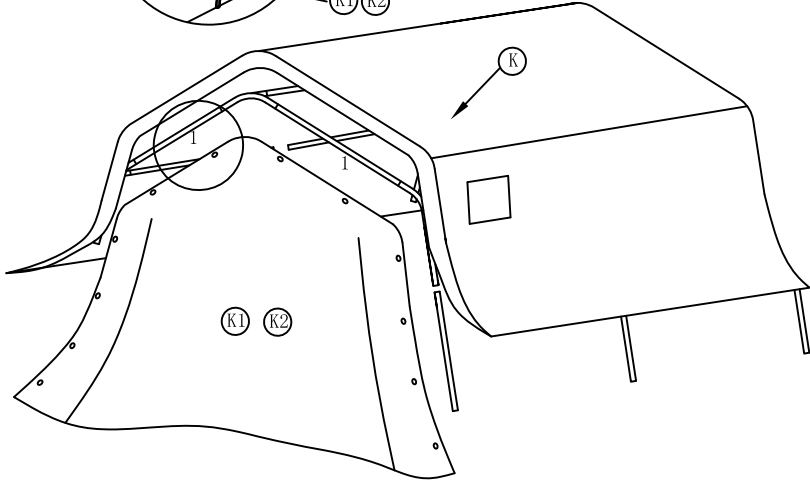

6

Assemble the long pipes using each Steel Pipes(3,3A).

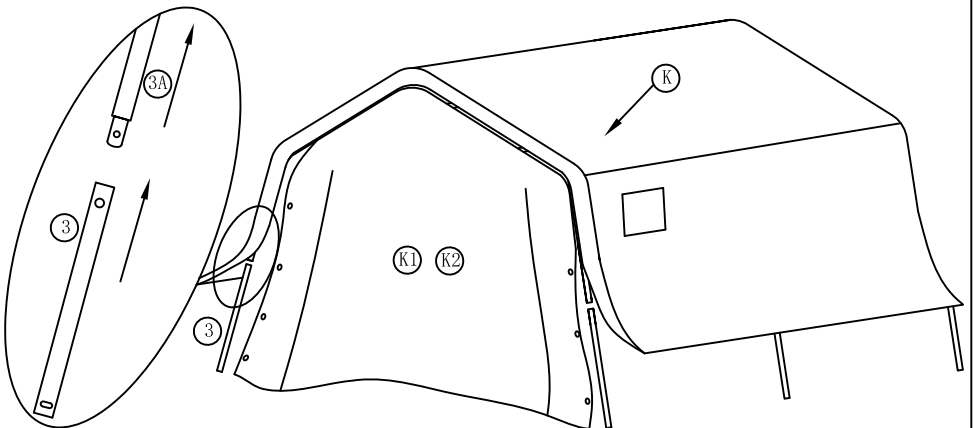

7

Fix the Door Cover(K1) and Back Cover(K2) on the long pipes (step 6) with the Bungee Cord(F)

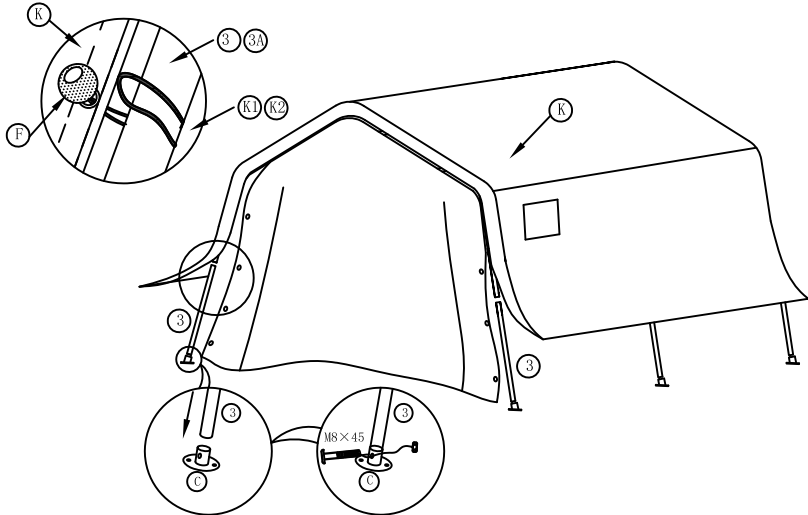

Assemble the Foot Plate(C) to the Steel Pipe(3) .Use the M8×50mm Screw (M) to four corners,As shown in the figure

8

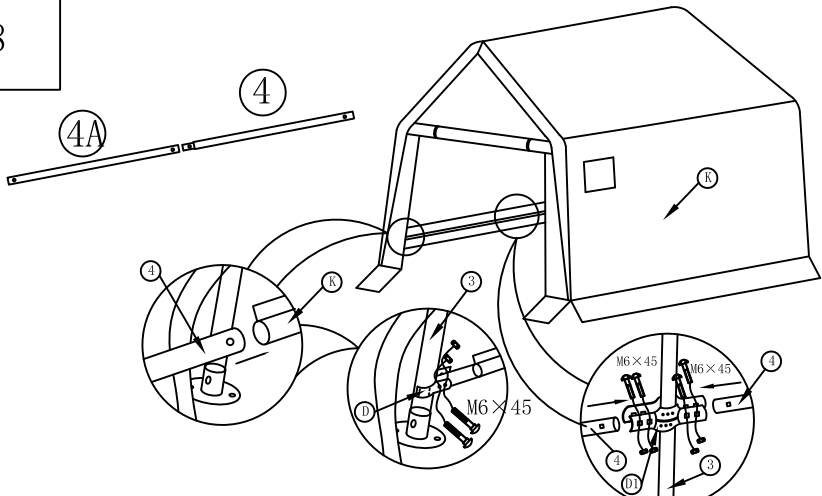

Connect the steel pipe 4#/4A# and insert it into the pipe sleeve at the lower end of both sides of the cover, and use M6\*45mm screws to fix it to the 3# steel pipe through the clamps D,D1.

Note: After all the clamps D,D1 on both sides are completely fixed, you need to tighten the cover at the same time to tighten the screws!



9

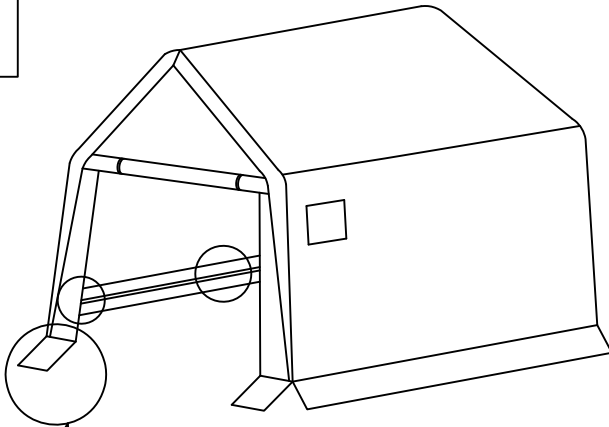

thread the Anchor(I) into the ground. Fix the Foot Plate (C)

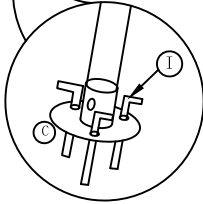

10

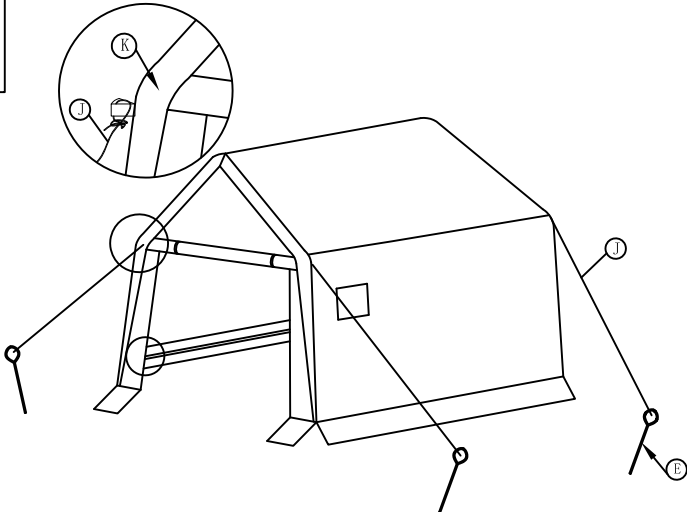

Tie one end of the rope J to the upper end of the door on both sides of the pull rope climb, the other end is tied to the ring with the ground nail, 4pcs pull rope at the same time to tighten the ground nail knocked into the ground soil, pay attention to the pull rope needs to be fixed firmly, can not be in a state of slack, correctly fixed after the completion of the installation!

## **Cleaning and Maintenance**

1. If there is snow or ice on the top of the instant garage, please clear it in time.
2. It is recommended to clean the surface of the instant garage regularly with mild soap and water.

Sanven Technology Ltd.

Address: Suite 250, 9166 Anaheim Place, Rancho Cucamonga, CA 91730



**VEVOR<sup>®</sup>**

**TOUGH TOOLS, HALF PRICE**

Technical Support and E-Warranty Certificate

[www.vevor.com/support](http://www.vevor.com/support)

# VEVOR<sup>®</sup>

## TOUGH TOOLS, HALF PRICE

Technischer Support und E-Garantie-Zertifikat

[www.vevor.com/support](http://www.vevor.com/support)

## Lagerzelt für den Außenbereich

### BENUTZERHANDBUCH

Wir sind weiterhin bestrebt, Ihnen Werkzeuge zu wettbewerbsfähigen Preisen anzubieten.

„Sparen Sie die Hälfte“, „Halber Preis“ oder andere ähnliche Ausdrücke, die wir verwenden, stellen nur eine Schätzung der Ersparnis dar, die Sie beim Kauf bestimmter Werkzeuge bei uns im Vergleich zu den großen Topmarken erzielen können, und decken nicht unbedingt alle von uns angebotenen Werkzeugkategorien ab. Wir möchten Sie freundlich daran erinnern, bei Ihrer Bestellung bei uns sorgfältig zu prüfen, ob Sie im Vergleich zu den großen Topmarken tatsächlich die Hälfte sparen.

# VEVOR® LAGERUNG IM FREIEN

UNTERSCHLUPF

MODELL:SCP0712/SCP0814

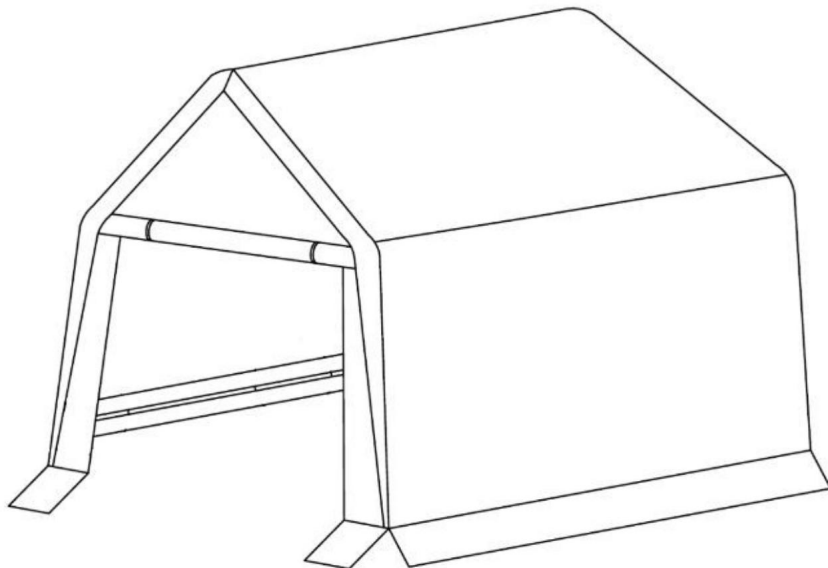

**Brauchen Sie Hilfe? Kontaktieren Sie uns!**

Sie haben Fragen zu unseren Produkten? Sie benötigen technischen Support? Dann kontaktieren Sie uns gerne:

**Technischer Support und E-Garantie-Zertifikat [www.vevor.com/support](http://www.vevor.com/support)**

Dies ist die Originalanleitung. Bitte lesen Sie alle Anweisungen sorgfältig durch, bevor Sie das Gerät in Betrieb nehmen. VEVOR behält sich eine klare Auslegung unserer Bedienungsanleitung vor. Das Erscheinungsbild des Produkts richtet sich nach dem Produkt, das Sie erhalten haben. Bitte verzeihen Sie uns, dass wir Sie nicht erneut informieren, wenn es Technologie- oder Software-Updates für unser Produkt gibt.

## SICHERHEITSHINWEISE





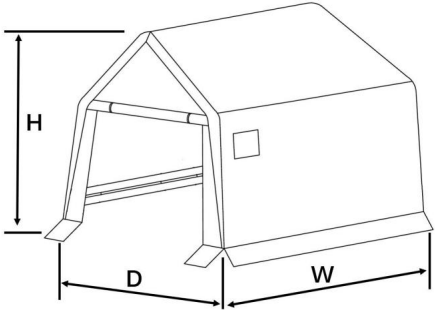



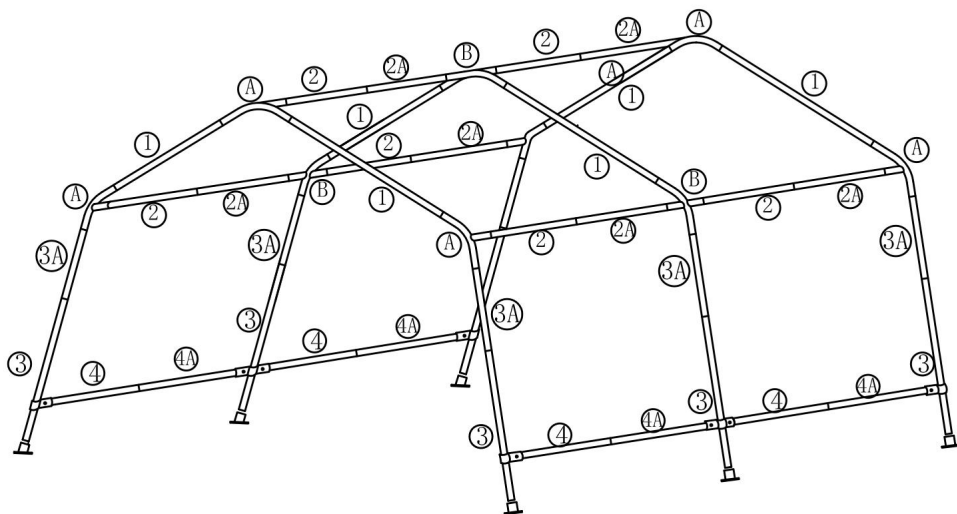

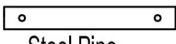

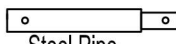
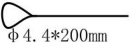

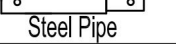

1. Die Fertiggarage muss auf glattem Rasen aufgestellt werden.
2. Es wird empfohlen, bei der Montage Handschuhe zu tragen.
3. Möglicherweise müssen Sie beim Aufbau eine Leiter verwenden. Bitte achten Sie auf die Sicherheit.
4. Wenn ein Teil des Produkts beschädigt ist, verwenden Sie es bitte nicht.
5. Stellen oder setzen Sie sich nicht auf die Fertiggarage.
6. Rauchen Sie nicht und verwenden Sie keine offenen Flammen in und um die Fertiggarage.  
Feuer vermeiden.
7. Bei schlechtem Wetter muss die Fertiggarage weggeräumt werden.
8. Die Verwendung bei Schnee wird nicht empfohlen.
9. Bauen Sie den Aufbau streng nach Anleitung durch und verwenden Sie Seil, Anker und anderes Zubehör im Montageprozess.

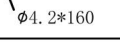
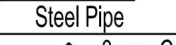
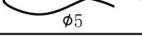
## MODELL UND PARAMETER

Aussehen	Farbe	Größe (T*B*H)	Netto Gewicht
	Grau	<b>(SCP0712)</b> 7*12*7,36 Fuß	79,3 Pfund
	Grau	<b>(SCP0814)</b> 8*14*7,6 Fuß	87,7 Pfund

## KOMPONENTEN



1#	 Steel Pipe	6pcs	D1#	 Rail Clamp	4pcs
2#	 Steel Pipe	6pcs	E#	 Anchor $\phi 4.4 \times 200\text{mm}$	4pcs
2A#	 Steel Pipe	6pcs	F#	 Bungee Cord	32+4pcs
3#	 Steel Pipe	6pcs	G#	 M8×50 Screw	6+4pcs
3A#	 Steel Pipe	6pcs	H#	 M6×45mm Screw	16+1pcs
4#	 Steel Pipe	4pcs	I#	 Ground Peg $\phi 4.2 \times 160$	18pcs
4A#	 Steel Pipe	4pcs	J#	 Rope $\phi 5$	4pcs
A#	 3-way Corner Connector	6pcs	K#	 Roof Cover	1pc
B#	 4-way Corner Connector	3pcs	K1#	 Door Cover	1pc
C#	 Foot Plate	6pcs	K2#	 Back Cover	1pc
D#	 Rail Clamp	8pcs			



## MONTAGE

1

Find out (A,B,1,2,2A) parts, and place them according to the position of the parts in the picture.

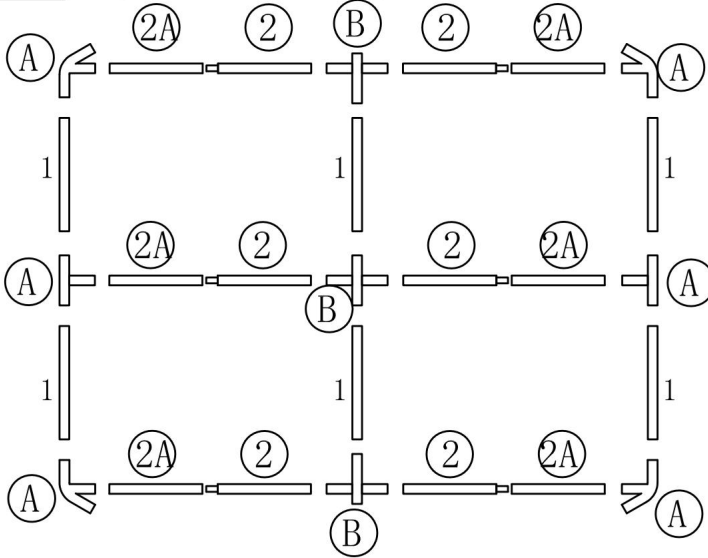

2

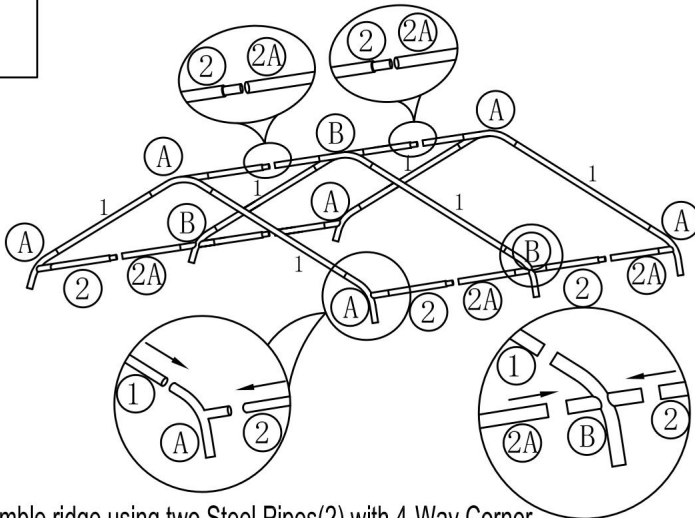

Assemble ridge using two Steel Pipes(2) with 4-Way Corner Connectors(B) between them, and a 3-Way Corner Connector(A) on each end. Connect a Steel Pipe(1) to each end of every connector (A,B) to get the roof frame.

3

Put the flat end of 3A# into connector A#,B# and then connect 3# pipe to 3A#.

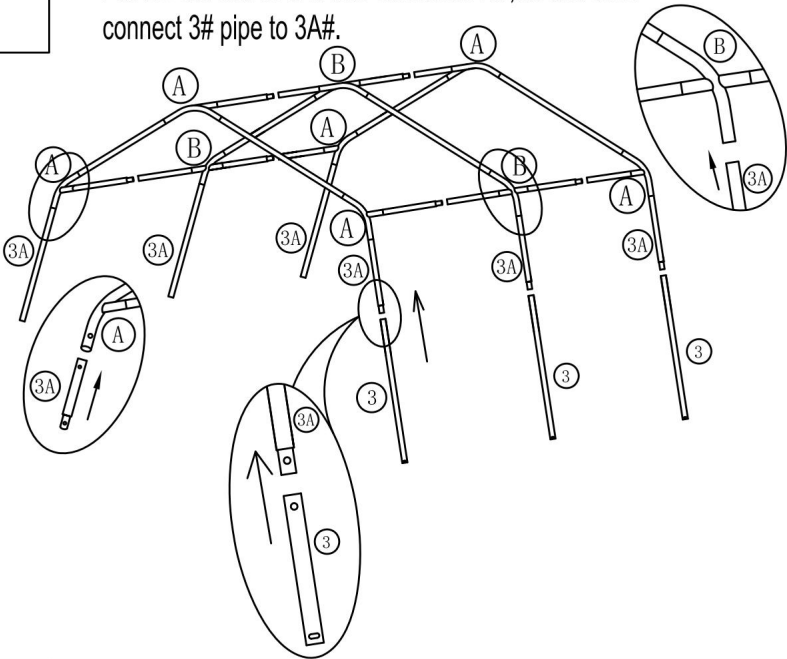

4

Put the Roof Cover(K) on the top frame.

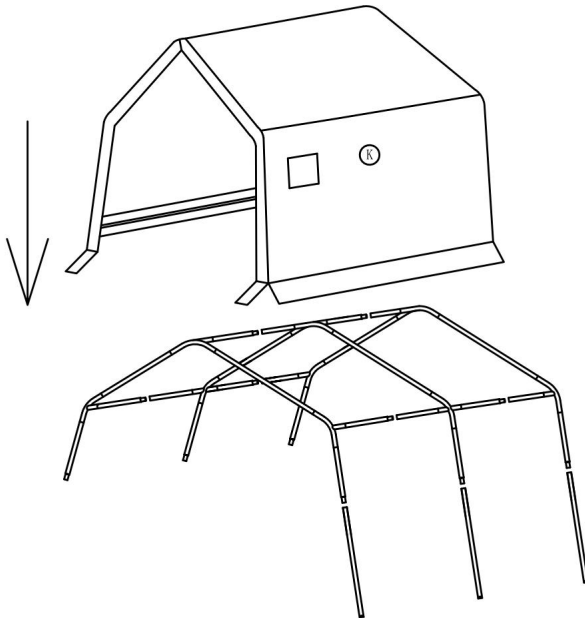

5

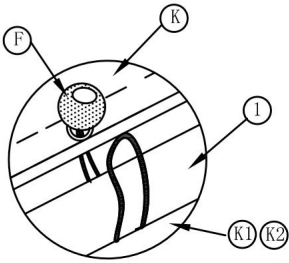

Assemble the Door Cover(K1) and Back Cover(K2) to the Steel Pipe(1) with the Bungee Cord(F)

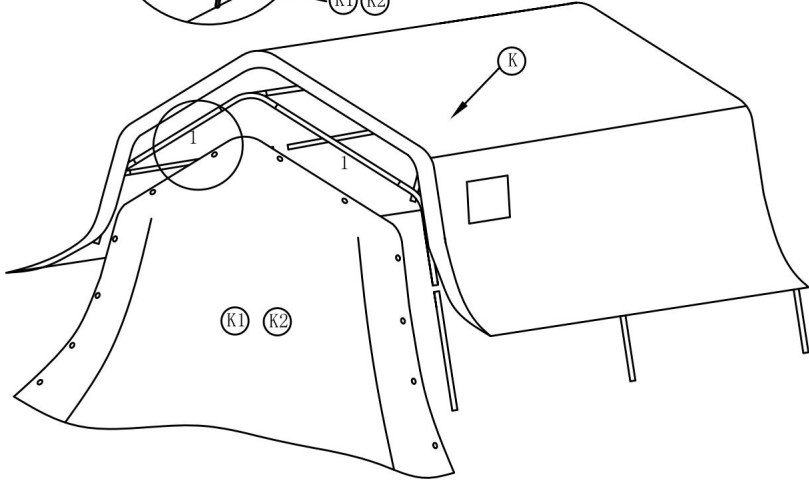

6

Assemble the long pipes using each Steel Pipes(3,3A).

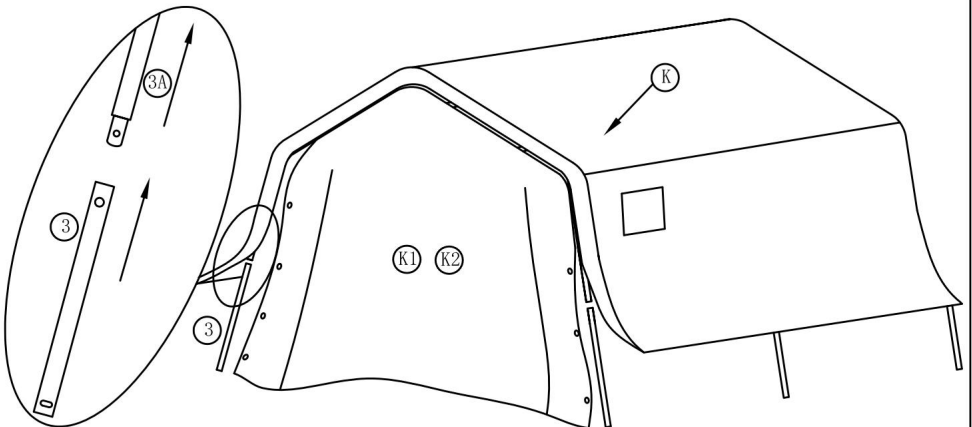

7

Fix the Door Cover(K1) and Back Cover(K2) on the long pipes (step 6) with the Bungee Cord(F)

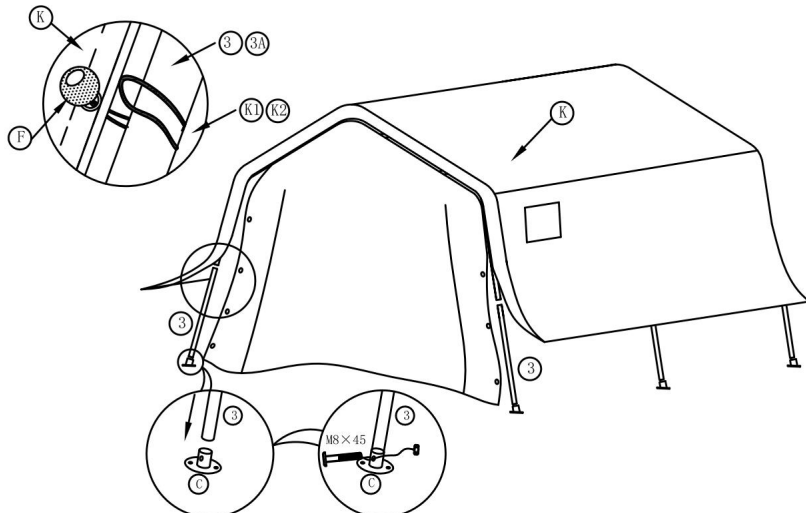

Assemble the Foot Plate(C) to the Steel Pipe(3) .Use the M8×50mm Screw (M) to four corners,As shown in the figure

8

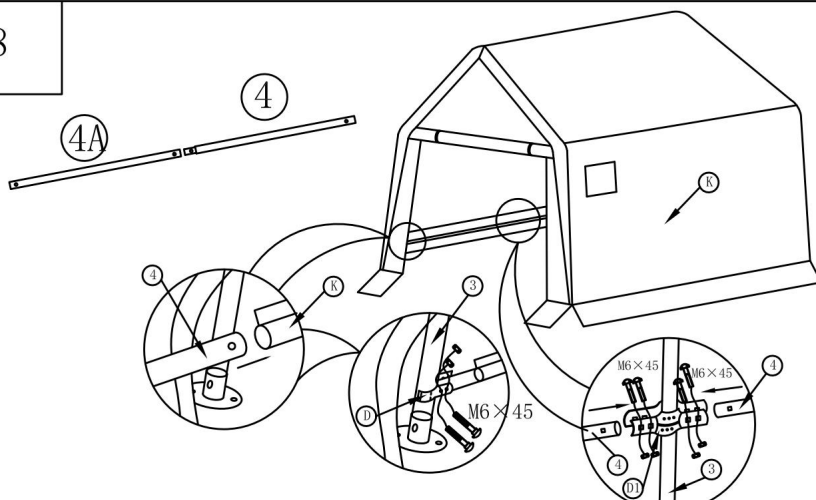

Connect the steel pipe 4#/4A# and insert it into the pipe sleeve at the lower end of both sides of the cover, and use M6\*45mm screws to fix it to the 3# steel pipe through the clamps D,D1.

Note: After all the clamps D,D1 on both sides are completely fixed, you need to tighten the cover at the same time to tighten the screws!

9

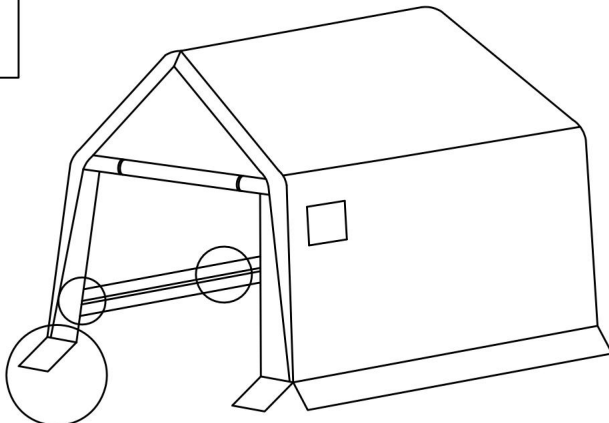

thread the Anchor(I) into the ground. Fix the Foot Plate (C)

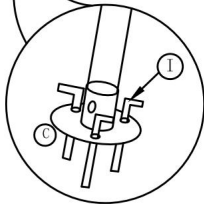

10

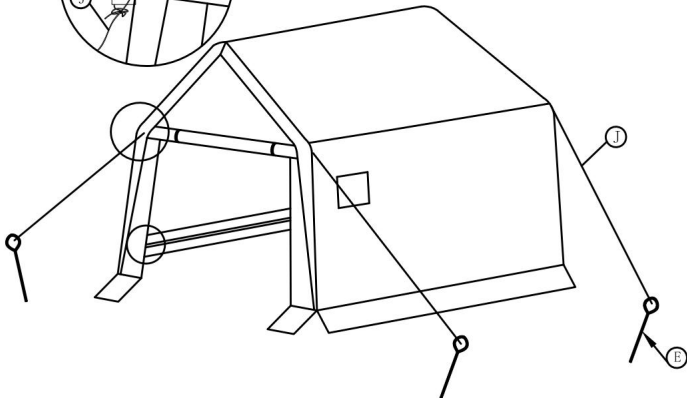
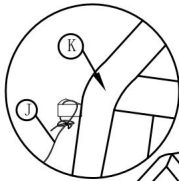

Tie one end of the rope J to the upper end of the door on both sides of the pull rope climb, the other end is tied to the ring with the ground nail, 4pcs pull rope at the same time to tighten the ground nail knocked into the ground soil, pay attention to the pull rope needs to be fixed firmly, can not be in a state of slack, correctly fixed after the completion of the installation!

**Reinigung und Wartung** 1. Wenn sich

Schnee oder Eis auf dem Dach der Fertiggarage befindet, räumen Sie es bitte rechtzeitig weg.

2. Es wird empfohlen, die Oberfläche der Fertiggarage regelmäßig mit milder Seife und Wasser zu reinigen.

Sanven Technology Ltd.

Adresse: Suite 250, 9166 Anaheim Place, Rancho Cucamonga, CA 91730



**VEVOR**<sup>®</sup>

**TOUGH TOOLS, HALF PRICE**

Technischer Support und E-Garantie-Zertifikat

[www.vevor.com/support](http://www.vevor.com/support)



# VEVOR<sup>®</sup>

## TOUGH TOOLS, HALF PRICE

Assistance technique et certificat de garantie électronique

[www.vevor.com/support](http://www.vevor.com/support)

## ABRI DE STOCKAGE EXTÉRIEUR

### MANUEL D'UTILISATION

Nous continuons à nous engager à vous fournir des outils à des prix compétitifs.

« Économisez la moitié », « Moitié prix » ou toute autre expression similaire utilisée par nous ne représente qu'une estimation des économies que vous pourriez réaliser en achetant certains outils chez nous par rapport aux grandes marques et ne couvre pas nécessairement toutes les catégories d'outils que nous proposons. Nous vous rappelons de bien vouloir vérifier soigneusement lorsque vous passez une commande chez nous si vous économisez réellement la moitié par rapport aux grandes marques.

# VEVOR<sup>®</sup>

## STOCKAGE EXTÉRIEUR

### ABRI

MODÈLE : SCP0712/SCP0814

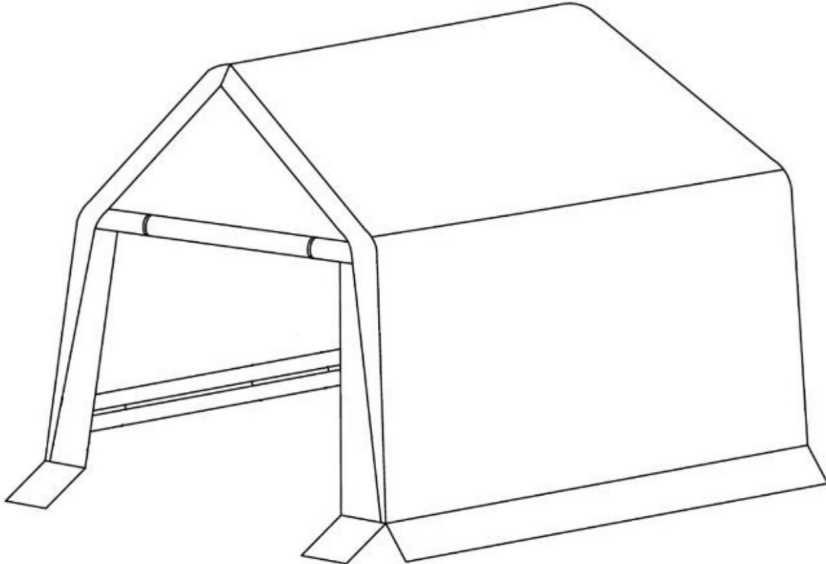

#### BESOIN D'AIDE? CONTACTEZ-NOUS!

Vous avez des questions sur les produits ? Vous avez besoin d'une assistance technique ? N'hésitez pas à nous contacter :

Assistance technique et certificat de garantie électronique [www.vevor.com/support](http://www.vevor.com/support)

Il s'agit de la notice d'utilisation d'origine. Veuillez lire attentivement toutes les instructions du manuel avant de l'utiliser. VEVOR se réserve le droit d'interpréter clairement notre manuel d'utilisation. L'apparence du produit dépend du produit que vous avez reçu. Veuillez nous excuser, nous ne vous informerons plus en cas de mise à jour technologique ou logicielle de notre produit.

## CONSIGNES DE SÉCURITÉ





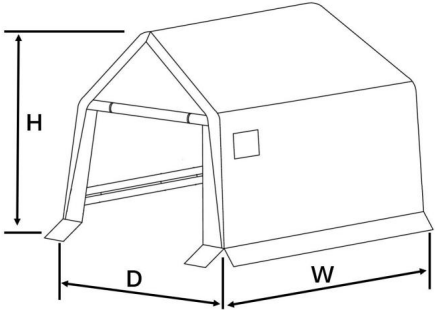



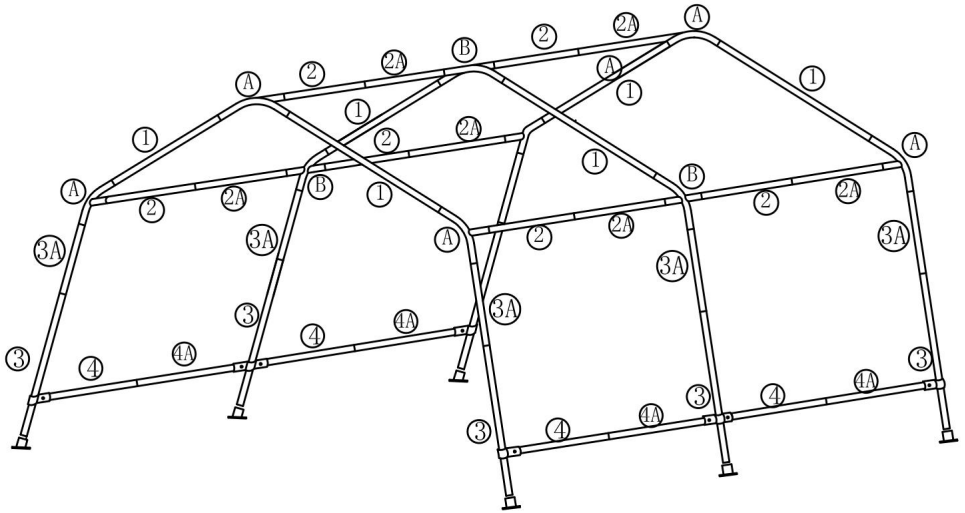

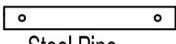

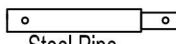
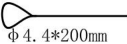

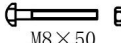
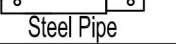
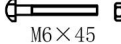

1. Le garage instantané doit être installé sur l'herbe lisse.
2. Il est recommandé de porter des gants lors du montage.
3. Vous devrez peut-être utiliser une échelle pendant le montage. Veuillez faire attention aux mesures de sécurité.
4. Si une partie du produit est endommagée, veuillez ne pas l'utiliser.
5. Ne vous tenez pas debout ou ne vous asseyez pas sur le garage instantané.
6. Ne fumez pas et n'utilisez pas d'appareils à flamme nue dans et autour du garage instantané pour éviter le feu.
7. En cas de mauvais temps, le garage instantané doit être rangé.
8. Il n'est pas recommandé de l'utiliser dans des conditions de neige.
9. Assemblez-vous en stricte conformité avec les instructions et utilisez une corde, une ancre et autres accessoires dans le processus d'assemblage.

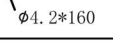
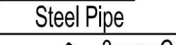
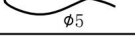
## MODÈLE ET PARAMÈTRES

Apparence	Couleur	Taille (P*L*H)	Filet Poids
	Gris	(SCP0712) 7*12*7.36FT	79,3 livres
	Gris	(SCP0814) 8*14*7.6FT	87,7 lb

## COMPOSANTS



1#	 Steel Pipe	6pcs	D1#	 Rail Clamp	4pcs
2#	 Steel Pipe	6pcs	E#	 Anchor $\phi 4.4 \times 200\text{mm}$	4pcs
2A#	 Steel Pipe	6pcs	F#	 Bungee Cord	32+4pcs
3#	 Steel Pipe	6pcs	G#	 M8×50 Screw	6+4pcs
3A#	 Steel Pipe	6pcs	H#	 M6×45 Screw	16+1pcs
4#	 Steel Pipe	4pcs	I#	 Ground Peg $\phi 4.2 \times 160$	18pcs
4A#	 Steel Pipe	4pcs	J#	 Rope $\phi 5$	4pcs
A#	 3-way Corner Connector	6pcs	K#	 Roof Cover	1pc
B#	 4-way Corner Connector	3pcs	K1#	 Door Cover	1pc
C#	 Foot Plate	6pcs	K2#	 Back Cover	1pc
D#	 Rail Clamp	8pcs			

## ASSEMBLÉE

1

Find out (A,B,1,2,2A)parts, and place them according to the position of the parts in the picture.

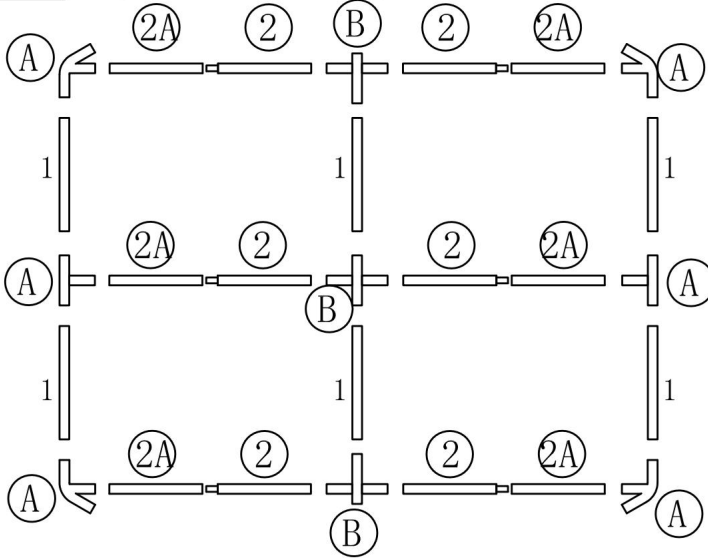

2

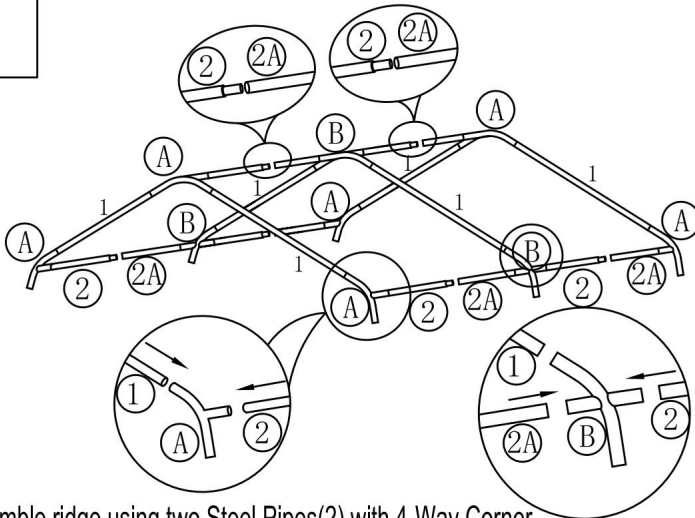

Assemble ridge using two Steel Pipes(2) with 4-Way Corner Connectors(B) between them, and a 3-Way Corner Connector(A) on each end. Connect a Steel Pipe(1) to each end of every connector (A,B) to get the roof frame.

3

Put the flat end of 3A# into connector A#,B# and then connect 3# pipe to 3A#.

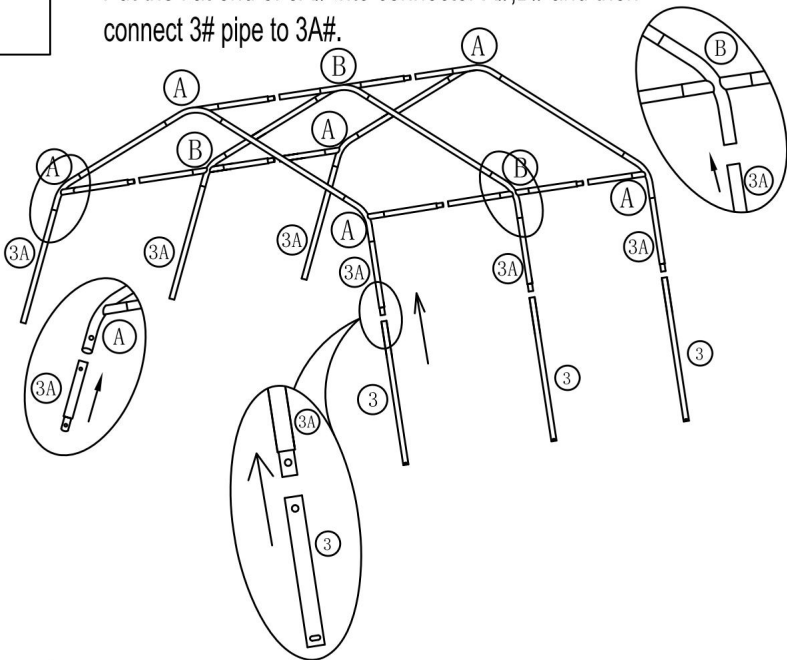

4

Put the Roof Cover(K) on the top frame.

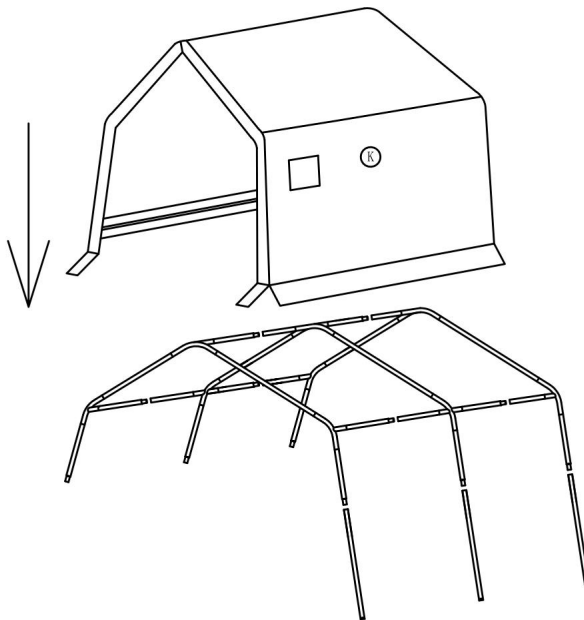

5

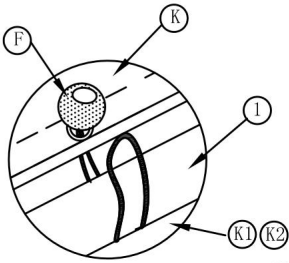

Assemble the Door Cover(K1) and Back Cover(K2) to the Steel Pipe(1) with the Bungee Cord(F)

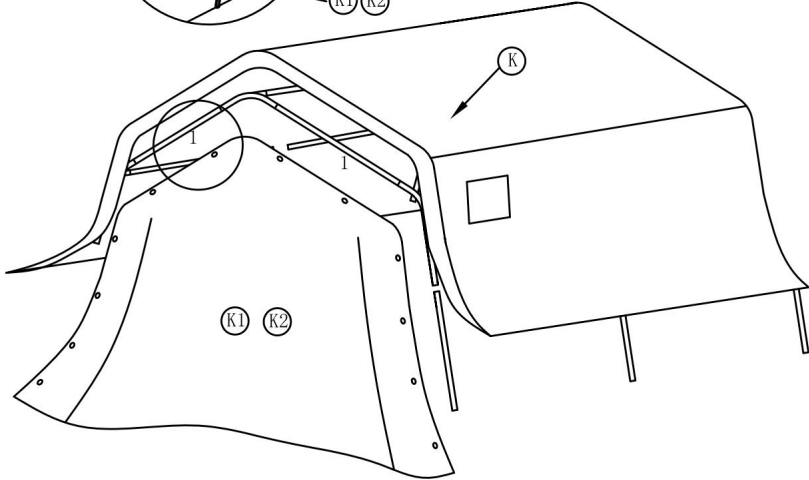

6

Assemble the long pipes using each Steel Pipes(3,3A).

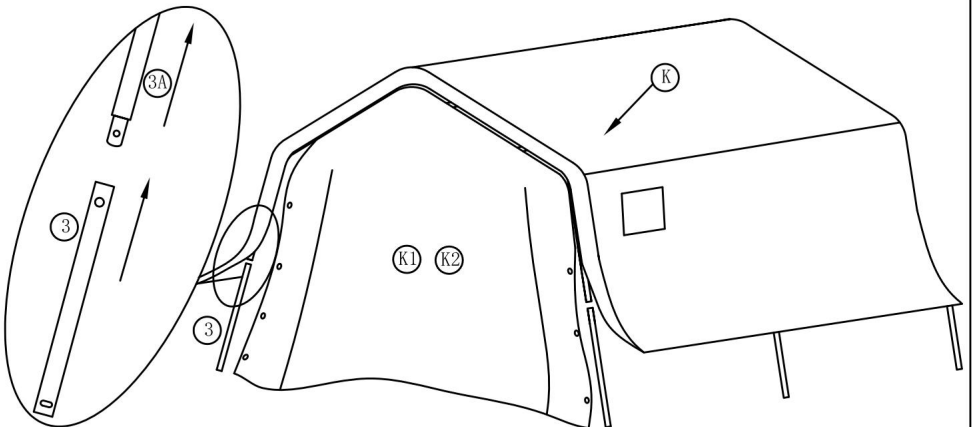

7

Fix the Door Cover(K1) and Back Cover(K2) on the long pipes (step 6) with the Bungee Cord(F)

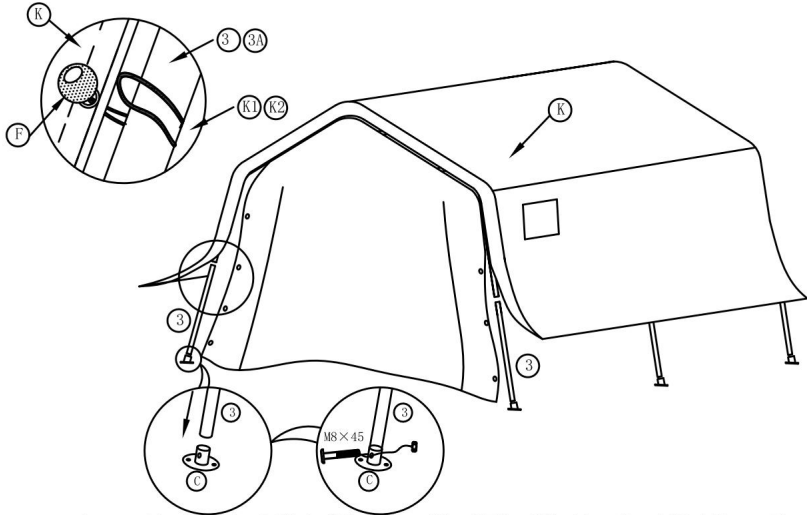

Assemble the Foot Plate(C) to the Steel Pipe(3) .Use the M8×50mm Screw (M) to four corners,As shown in the figure

8

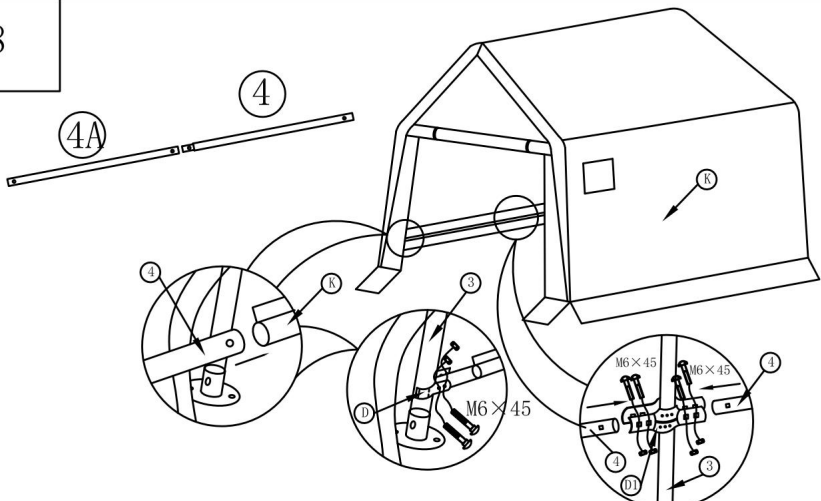

Connect the steel pipe 4#/4A# and insert it into the pipe sleeve at the lower end of both sides of the cover, and use M6\*45mm screws to fix it to the 3# steel pipe through the clamps D,D1.

Note: After all the clamps D,D1 on both sides are completely fixed, you need to tighten the cover at the same time to tighten the screws!



9

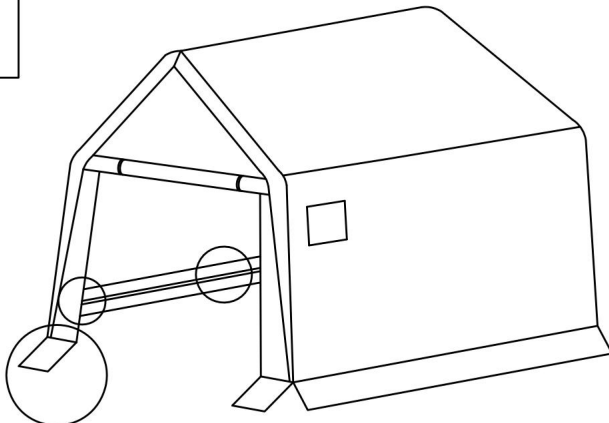

thread the Anchor(I) into the ground. Fix the Foot Plate (C)

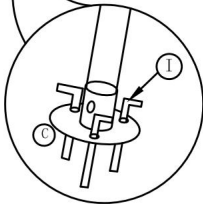

10

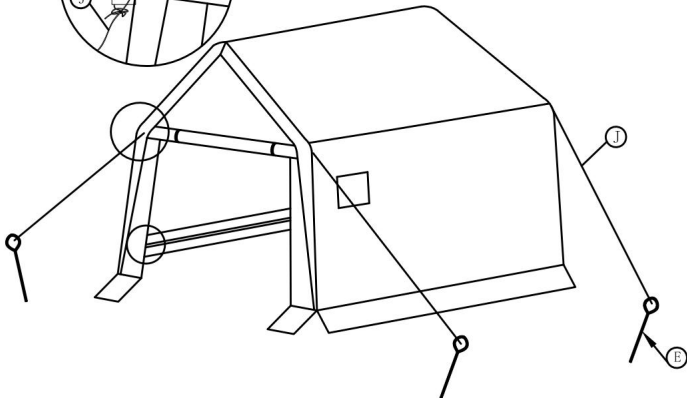
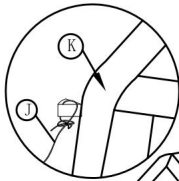

Tie one end of the rope J to the upper end of the door on both sides of the pull rope climb, the other end is tied to the ring with the ground nail, 4pcs pull rope at the same time to tighten the ground nail knocked into the ground soil, pay attention to the pull rope needs to be fixed firmly, can not be in a state of slack, correctly fixed after the completion of the installation!

### Nettoyage et entretien 1. S'il y a de

la neige ou de la glace sur le dessus du garage instantané, veuillez le nettoyer à temps.

2. Il est recommandé de nettoyer régulièrement la surface du garage instantané avec du savon doux et de l'eau.

Sanven Technologie Ltée.

Adresse : Suite 250, 9166 Anaheim Place, Rancho Cucamonga, CA 91730



**VEVOR<sup>®</sup>**

**TOUGH TOOLS, HALF PRICE**

Assistance technique et certificat de garantie  
électronique [www.vevor.com/support](http://www.vevor.com/support)

# VEVOR<sup>®</sup>

## TOUGH TOOLS, HALF PRICE

Technische ondersteuning en e-garantiecertificaat

[www.vevor.com/support](http://www.vevor.com/support)

## BUITEN OPSLAGSCHUILPLAATS

### GEBRUIKERSHANDLEIDING

Wij streven er voortdurend naar om u gereedschappen tegen concurrerende prijzen te leveren.

"Save Half", "Half Price" of andere soortgelijke uitdrukkingen die wij gebruiken, geven alleen een schatting van de besparingen die u kunt behalen door bepaalde gereedschappen bij ons te kopen in vergelijking met de grote topmerken en betekent niet noodzakelijkerwijs dat alle categorieën gereedschappen die wij aanbieden, worden gedekt. Wij herinneren u eraan om zorgvuldig te controleren of u daadwerkelijk de helft bespaart in vergelijking met de grote topmerken wanneer u een bestelling bij ons plaatst.

# VEVOR<sup>®</sup> BUITENOPSLAG

SCHUILPLAATS

MODEL:SCP0712/SCP0814

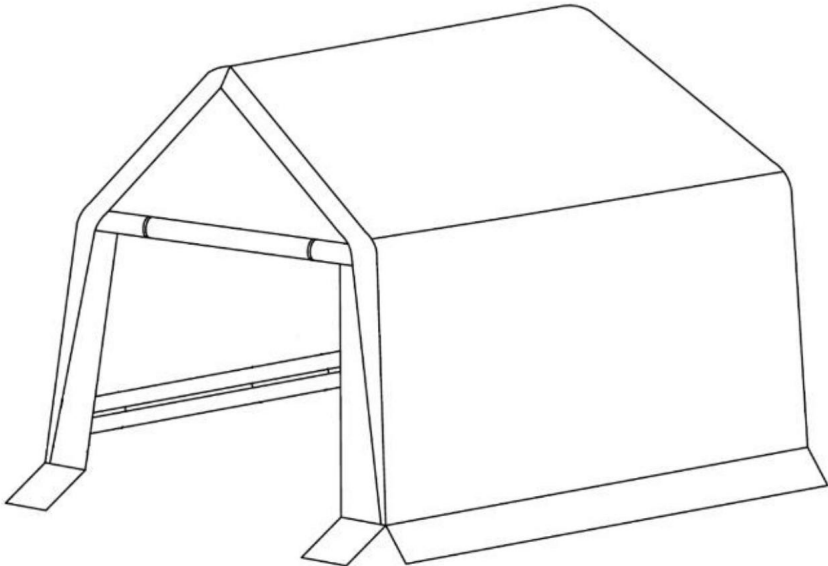

## HULP NODIG? NEEM CONTACT MET ONS OP!

Heeft u vragen over het product? Heeft u technische ondersteuning nodig? Neem dan gerust contact met ons op:

**Technische ondersteuning en e-garantiecertificaat [www.vevor.com/support](http://www.vevor.com/support)**

Dit is de originele instructie, lees alle handleidingen zorgvuldig door voordat u het product gebruikt. VEVOR behoudt zich een duidelijke interpretatie van onze gebruikershandleiding voor. Het uiterlijk van het product is afhankelijk van het product dat u hebt ontvangen. Vergeef ons dat we u niet opnieuw zullen informeren als er technologie- of software-updates voor ons product zijn.

## VEILIGHEIDSINSTRUCTIES





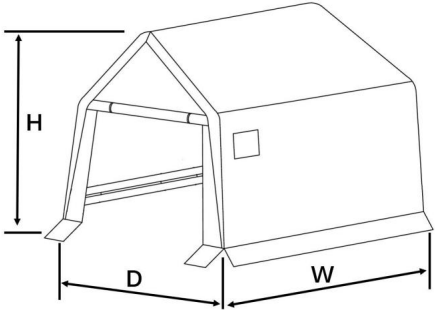



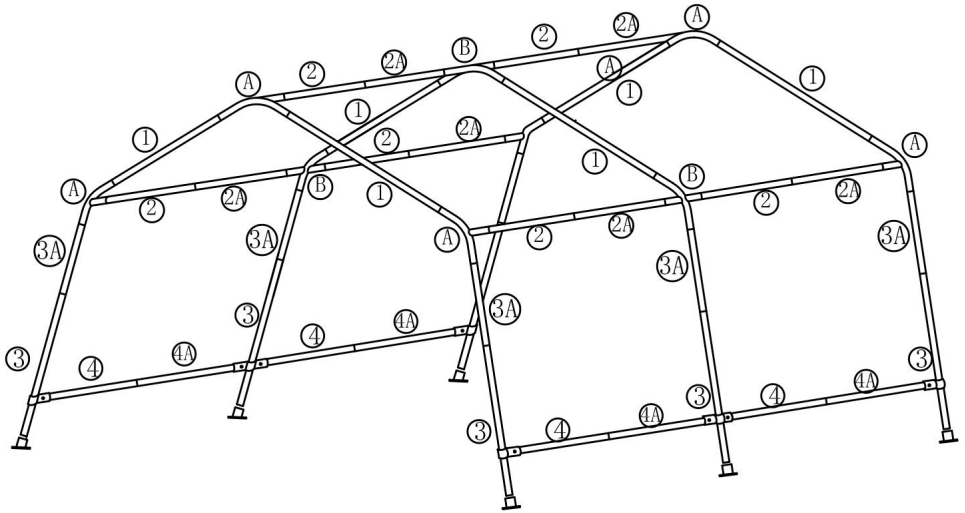

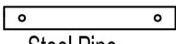

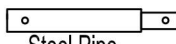
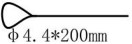



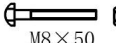
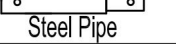

1. De garage moet op een vlakke ondergrond worden geplaatst.
2. Het wordt aanbevolen om handschoenen te dragen tijdens de montage.
3. Mogelijk moet u een ladder gebruiken tijdens de montage. Let op de veiligheid.
4. Als een onderdeel van het product beschadigd is, gebruik het dan niet.
5. Ga niet op de garage staan of zitten.
6. Rook niet en gebruik geen open vuur in en rond de garage om Vermijd vuur.
7. Bij slecht weer moet de garage worden opgeborgen.
8. Het wordt afgeraden om het te gebruiken bij sneeuwval.
9. Monteer het geheel strikt volgens de instructies en gebruik touw, anker en andere accessoires in het montageproces.

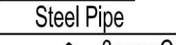
## MODEL EN PARAMETERS

Verschijning	Kleur	Maat (D*B*H)	Netto Gewicht
	Grijs	<b>(SCP0712)</b> 7*12*7,36 voet	79,3 pond
	Grijs	<b>(SCP0814)</b> 8*14*7.6FT	87,7 pond

## COMPONENTEN



1#	 Steel Pipe	6pcs	D1#	 Rail Clamp	4pcs
2#	 Steel Pipe	6pcs	E#	 Anchor $\phi 4.4 \times 200\text{mm}$	4pcs
2A#	 Steel Pipe	6pcs	F#	 Bungee Cord	32+4pcs
3#	 Steel Pipe	6pcs	G#	 M8×50 Screw	6+4pcs
3A#	 Steel Pipe	6pcs	H#	 M6×45mm Screw	16+1pcs
4#	 Steel Pipe	4pcs	I#	 Ground Peg $\phi 4.2 \times 160$	18pcs
4A#	 Steel Pipe	4pcs	J#	 Rope $\phi 5$	4pcs
A#	 3-way Corner Connector	6pcs	K#	 Roof Cover	1pc
B#	 4-way Corner Connector	3pcs	K1#	 Door Cover	1pc
C#	 Foot Plate	6pcs	K2#	 Back Cover	1pc
D#	 Rail Clamp	8pcs			



## MONTAGE

1

Find out (A,B,1,2,2A) parts, and place them according to the position of the parts in the picture.

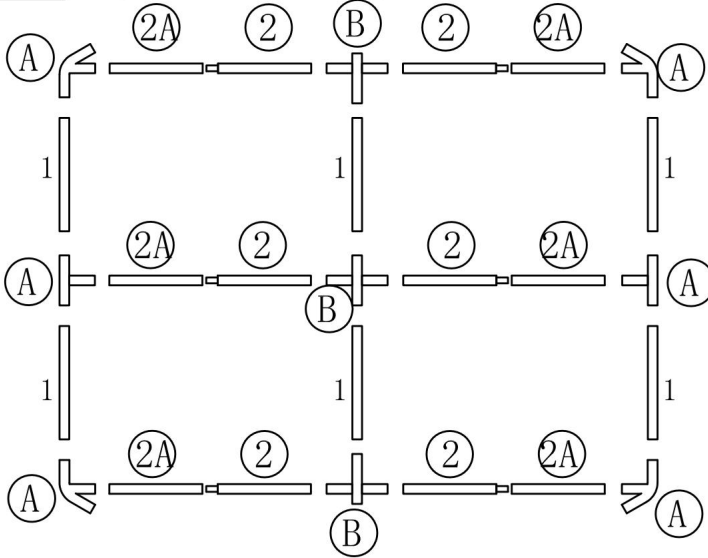

2

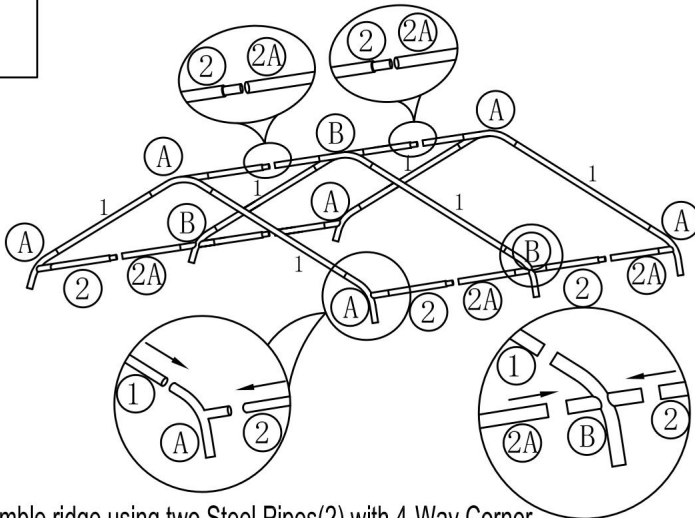

Assemble ridge using two Steel Pipes(2) with 4-Way Corner Connectors(B) between them, and a 3-Way Corner Connector(A) on each end. Connect a Steel Pipe(1) to each end of every connector (A,B) to get the roof frame.

3

Put the flat end of 3A# into connector A#,B# and then connect 3# pipe to 3A#.

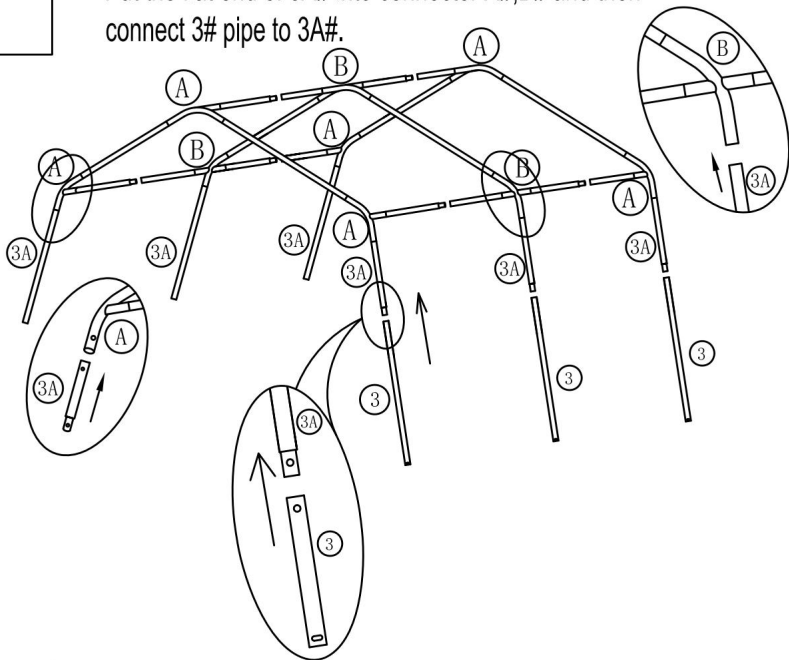

4

Put the Roof Cover(K) on the top frame.

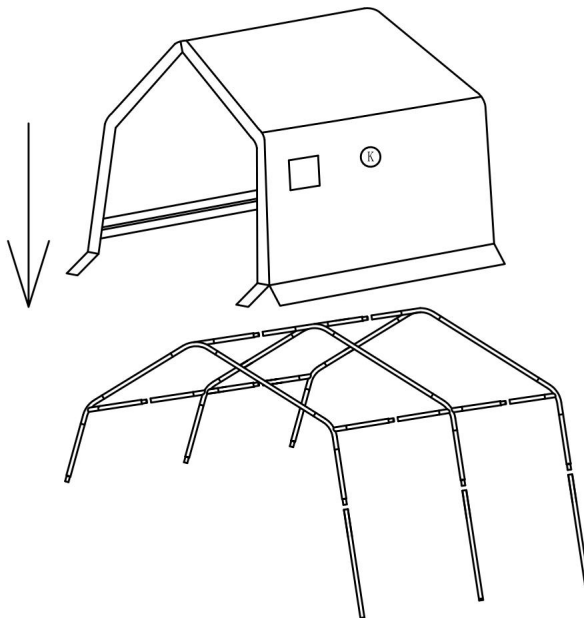

5

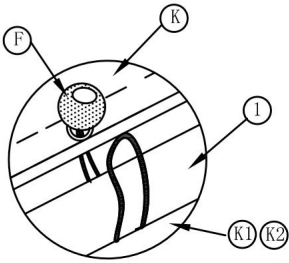

Assemble the Door Cover(K1) and Back Cover(K2) to the Steel Pipe(1) with the Bungee Cord(F)

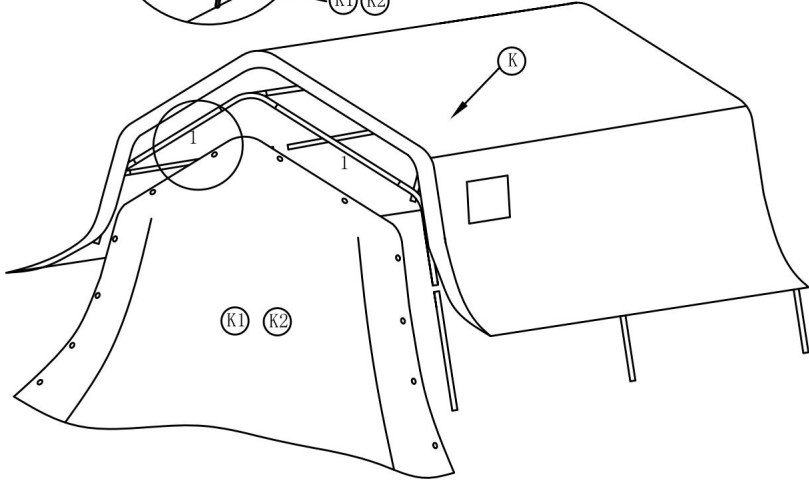

6

Assemble the long pipes using each Steel Pipes(3,3A).

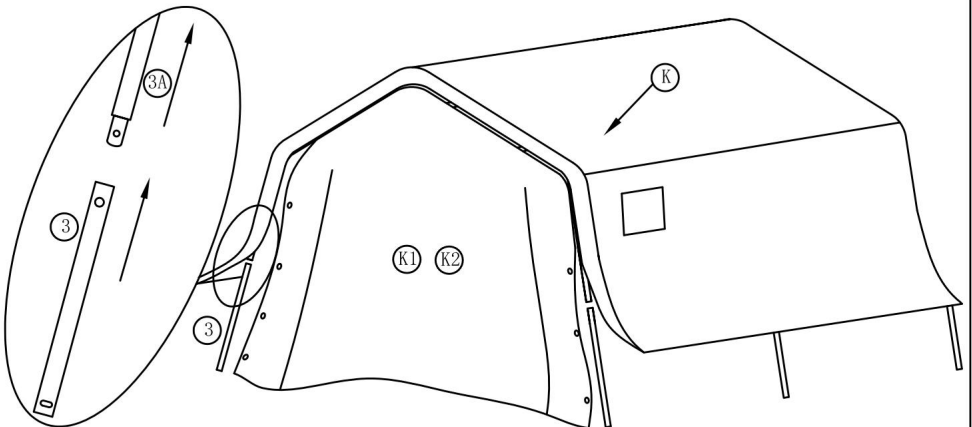

7

Fix the Door Cover(K1) and Back Cover(K2) on the long pipes (step 6) with the Bungee Cord(F)

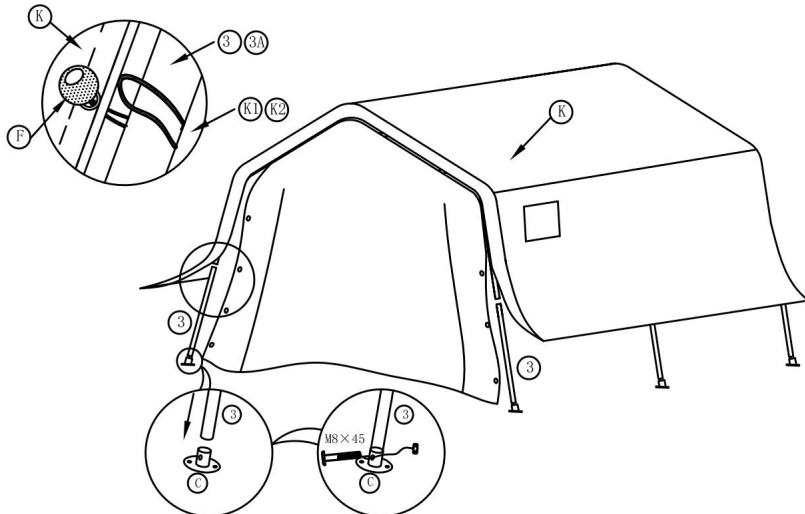

Assemble the Foot Plate(C) to the Steel Pipe(3) .Use the M8×50mm Screw (M) to four corners,As shown in the figure

8

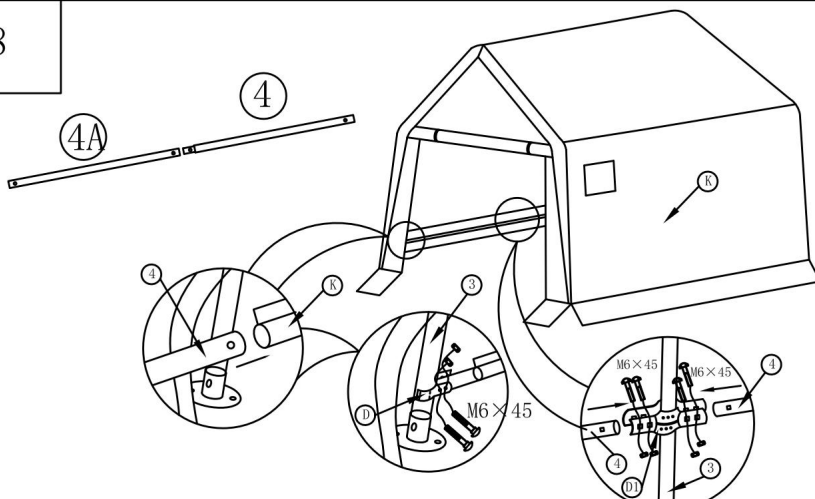

Connect the steel pipe 4#/4A# and insert it into the pipe sleeve at the lower end of both sides of the cover, and use M6\*45mm screws to fix it to the 3# steel pipe through the clamps D,D1.

Note: After all the clamps D,D1 on both sides are completely fixed, you need to tighten the cover at the same time to tighten the screws!

9

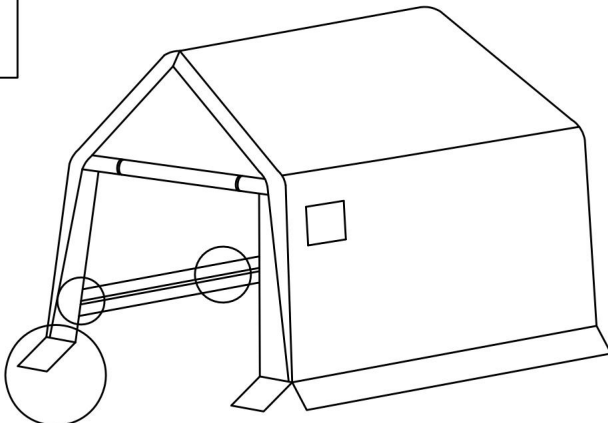

thread the Anchor(I) into the ground. Fix the Foot Plate (C)

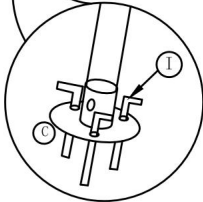

10

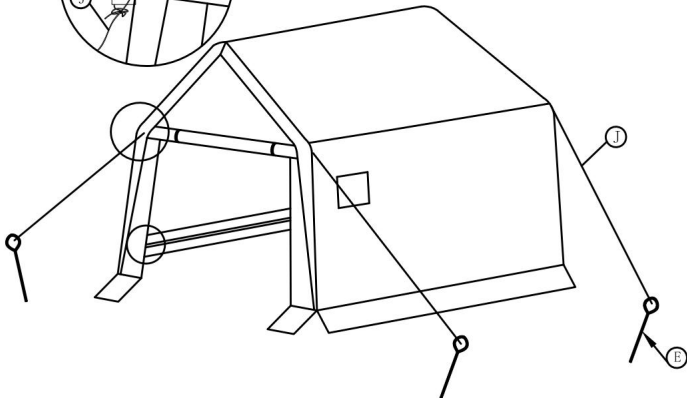
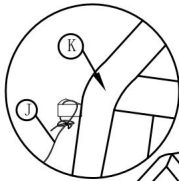

Tie one end of the rope J to the upper end of the door on both sides of the pull rope climb, the other end is tied to the ring with the ground nail, 4pcs pull rope at the same time to tighten the ground nail knocked into the ground soil, pay attention to the pull rope needs to be fixed firmly, can not be in a state of slack, correctly fixed after the completion of the installation!

### **Schoonmaken en onderhoud 1.**

Als er sneeuw of ijs op het dak van de garage ligt, ruim dit dan tijdig op.

2. Het is aan te raden om het oppervlak van de instant garage regelmatig schoon te maken met milde zeep en water.

Sanven Technologie Ltd.

Adres: Suite 250, 9166 Anaheim Place, Rancho Cucamonga, CA 91730



**VEVOR**<sup>®</sup>

**TOUGH TOOLS, HALF PRICE**

Technische ondersteuning en e-garantiecertificaat

[www.vevor.com/support](http://www.vevor.com/support)



# VEVOR®

## TOUGH TOOLS, HALF PRICE

Teknisk support och e-garanticertifikat

[www.vevor.com/support](http://www.vevor.com/support)

### UTOMHUS FÖRVARING SKYDD

### ANVÄNDARMANUAL

Vi fortsätter att vara engagerade i att ge dig verktyg till konkurrenskraftiga priser.

"Spara hälften", "halva priset" eller andra liknande uttryck som används av oss representerar bara en uppskattning av besparingar du kan dra nytta av att köpa vissa verktyg hos oss jämfört med de stora toppmärkena och betyder inte nödvändigtvis att täcka alla kategorier av verktyg som erbjuds av oss. Du påminns vänligen om att noggrant kontrollera när du gör en beställning hos oss om du faktiskt sparar hälften i jämförelse med de främsta stora varumärkena.

# VEVOR<sup>®</sup> UTOMHUSFÖRVARING

SKYDD

**MODELL: SCP0712/SCP0814**

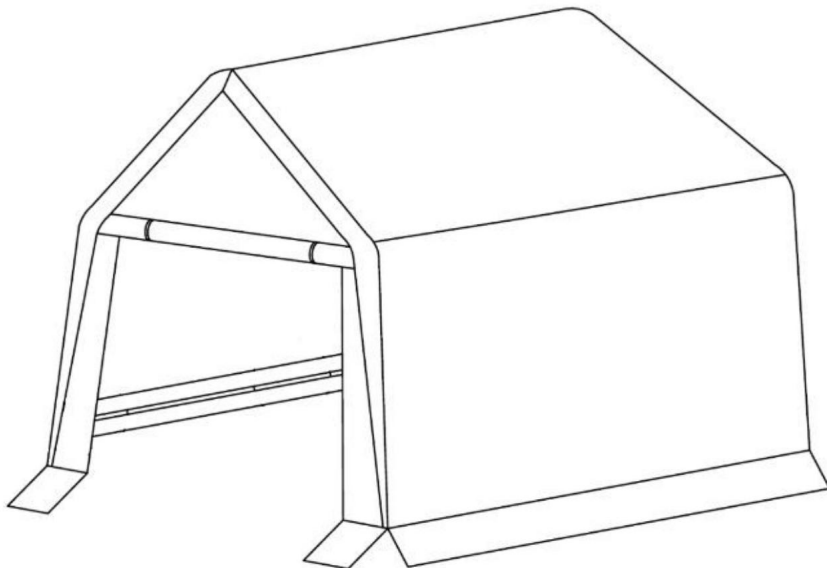

## BEHÖVER HJÄLP? KONTAKTA OSS!

Har du produktfrågor? Behöver du teknisk support? Kontakta oss gärna:

**Teknisk support och e-garanticertifikat [www.vevor.com/support](http://www.vevor.com/support)**

Detta är den ursprungliga instruktionen, läs alla instruktioner noggrant innan du använder den. VEVOR reserverar sig för en tydlig tolkning av vår användarmanual. Utseendet på produkten är beroende av den produkt du fått. Ursäkta oss att vi inte kommer att informera dig igen om det finns någon teknik eller mjukvaruuppdateringar på vår produkt.

## SÄKERHETSINSTRUKTIONER





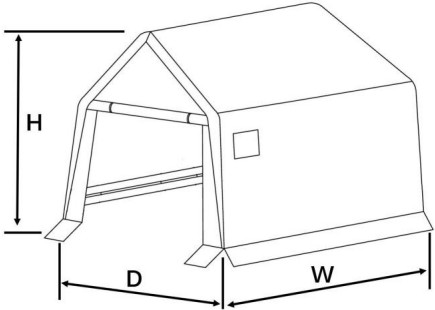



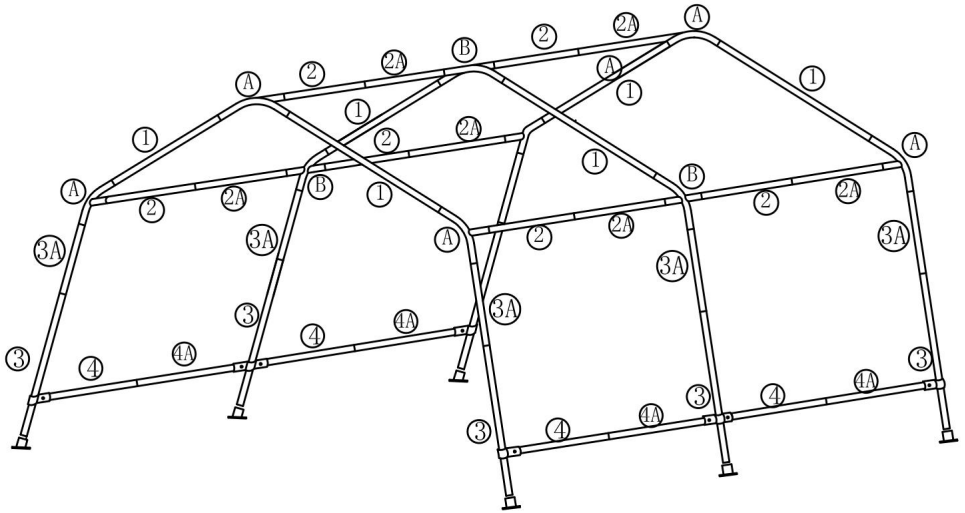

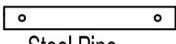

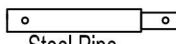
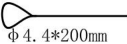

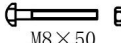
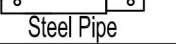
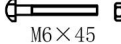

1. Snabbgaraget måste installeras på det släta gräset.
2. Det rekommenderas att bära handskar vid montering.
3. Du kan behöva använda en stega under monteringen. Var uppmärksam på säkerheten.
4. Om någon del av produkten är skadad, använd den inte.
5. Stå eller sitt inte ovanpå snabbgaraget.
6. Rök inte och använd inte anordningar med öppen låga i och runt garaget undvika brand.
7. Vid dåligt väder måste snabbgaraget ställas undan.
8. Det rekommenderas inte att använda det i snöiga förhållanden.
9. Montera i strikt enlighet med instruktionerna och använd rep, ankare och andra tillbehör i monteringsprocessen.

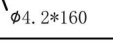
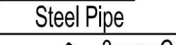
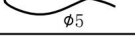
## MODELL OCH PARAMETRAR

Utseende	Färg	Storlek (D*B*H)	Netto Vikt
	Grå	<b>(SCP0712)</b> 7*12*7,36FT	79,3 pund
	Grå	<b>(SCP0814)</b> 8*14*7,6FT	87,7 pund

## KOMPONENTER



1#	 Steel Pipe	6pcs	D1#	 Rail Clamp	4pcs
2#	 Steel Pipe	6pcs	E#	 Anchor $\phi 4.4 \times 200\text{mm}$	4pcs
2A#	 Steel Pipe	6pcs	F#	 Bungee Cord	32+4pcs
3#	 Steel Pipe	6pcs	G#	 M8×50mm Screw	6+4pcs
3A#	 Steel Pipe	6pcs	H#	 M6×45mm Screw	16+1pcs
4#	 Steel Pipe	4pcs	I#	 Ground Peg $\phi 4.2 \times 160$	18pcs
4A#	 Steel Pipe	4pcs	J#	 Rope $\phi 5$	4pcs
A#	 3-way Corner Connector	6pcs	K#	 Roof Cover	1pc
B#	 4-way Corner Connector	3pcs	K1#	 Door Cover	1pc
C#	 Foot Plate	6pcs	K2#	 Back Cover	1pc
D#	 Rail Clamp	8pcs			

## MONTERING

1

Find out (A,B,1,2,2A)parts, and place them according to the position of the parts in the picture.

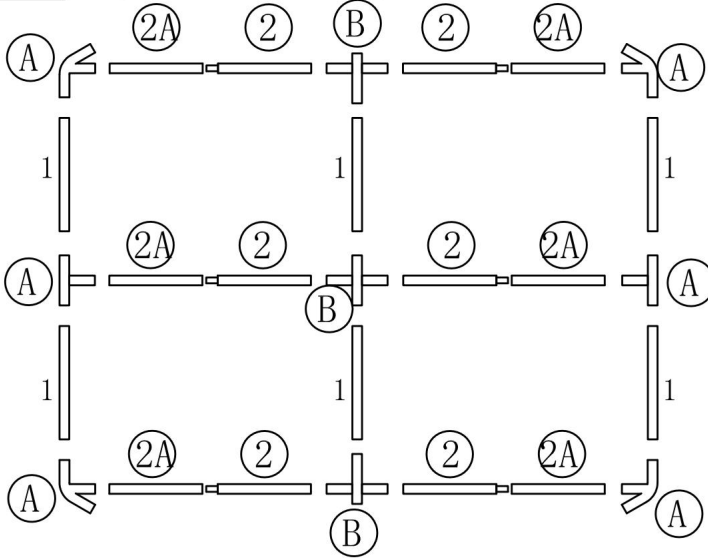

2

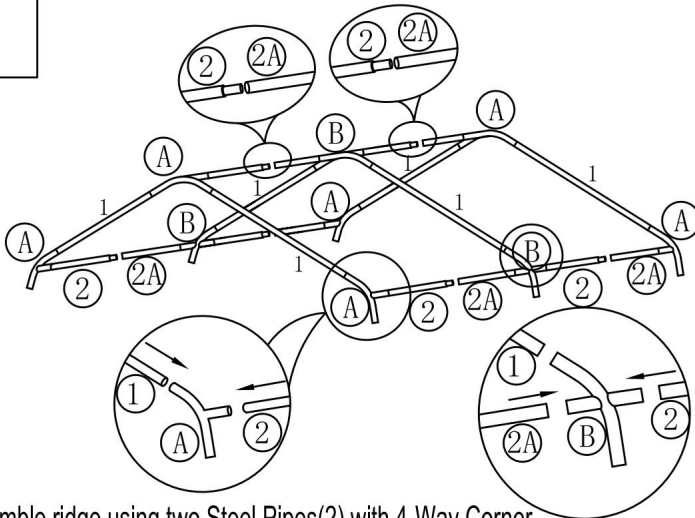

Assemble ridge using two Steel Pipes(2) with 4-Way Corner Connectors(B) between them, and a 3-Way Corner Connector(A) on each end. Connect a Steel Pipe(1) to each end of every connector (A,B) to get the roof frame.

3

Put the flat end of 3A# into connector A#,B# and then connect 3# pipe to 3A#.

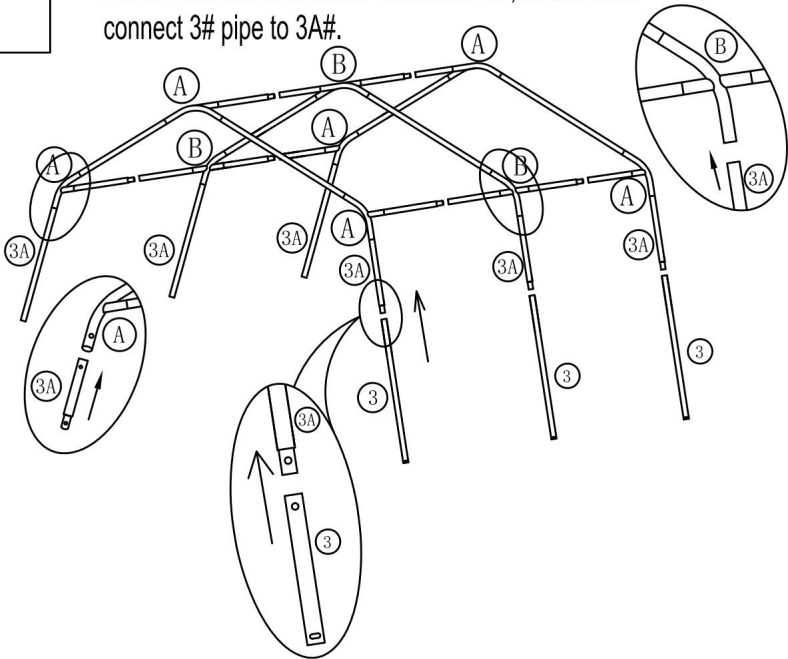

4

Put the Roof Cover(K) on the top frame.

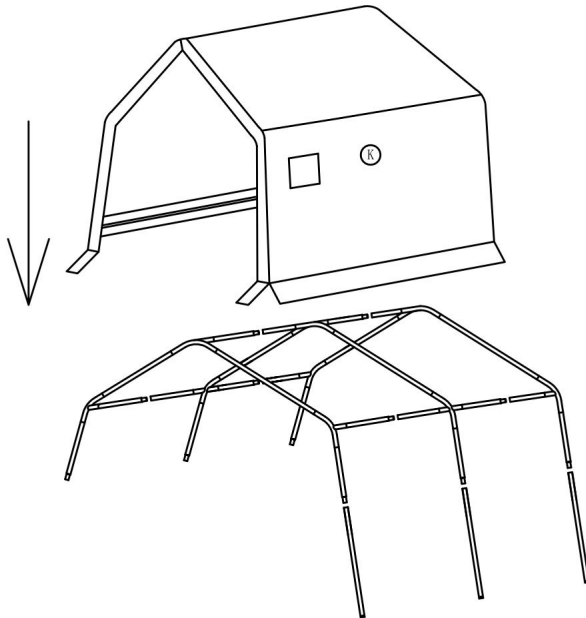

5

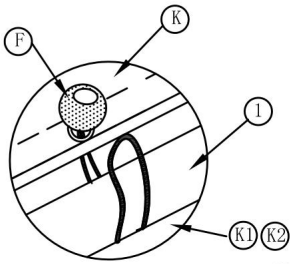

Assemble the Door Cover(K1) and Back Cover(K2) to the Steel Pipe(1) with the Bungee Cord(F)

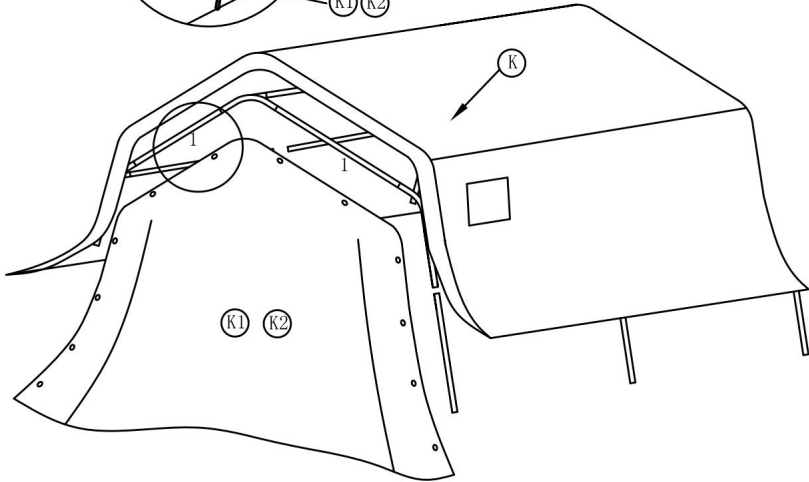

6

Assemble the long pipes using each Steel Pipes(3,3A).

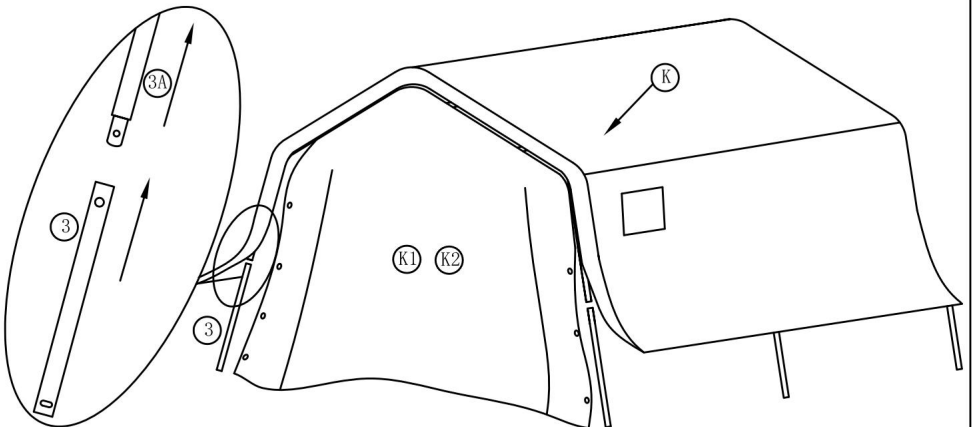

7

Fix the Door Cover(K1) and Back Cover(K2) on the long pipes (step 6) with the Bungee Cord(F)

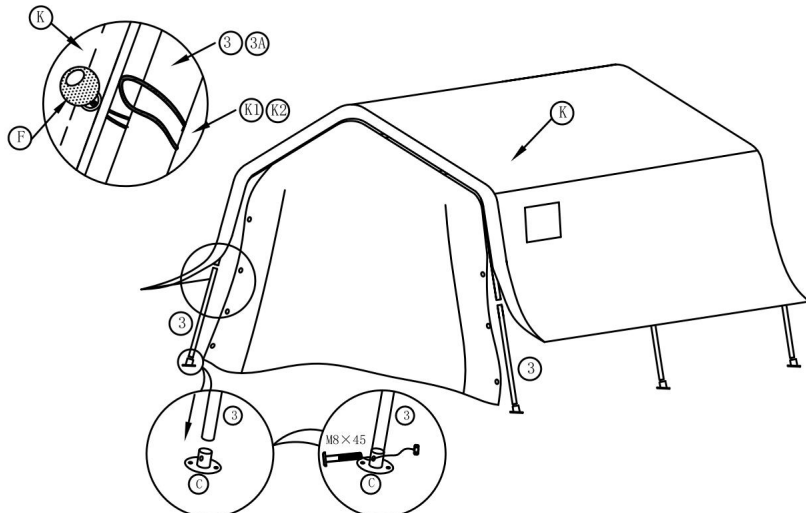

Assemble the Foot Plate(C) to the Steel Pipe(3) .Use the M8×50mm Screw (M) to four corners,As shown in the figure

8

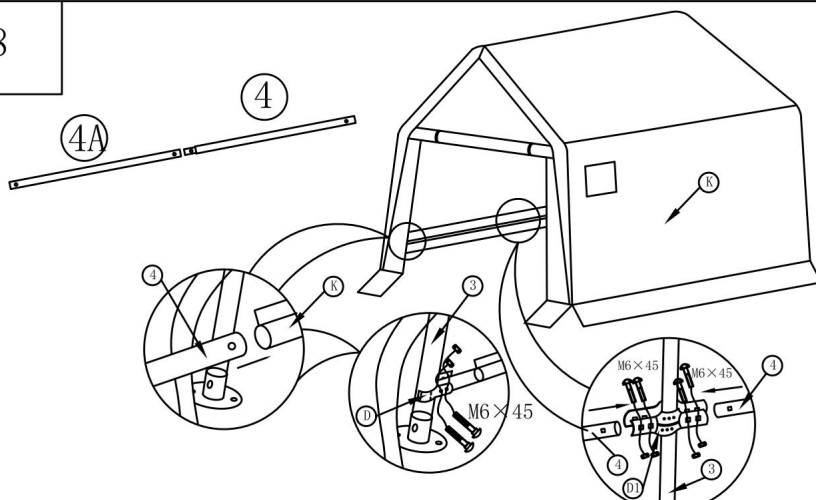

Connect the steel pipe 4#/4A# and insert it into the pipe sleeve at the lower end of both sides of the cover, and use M6\*45mm screws to fix it to the 3# steel pipe through the clamps D,D1.

Note: After all the clamps D,D1 on both sides are completely fixed, you need to tighten the cover at the same time to tighten the screws!



9

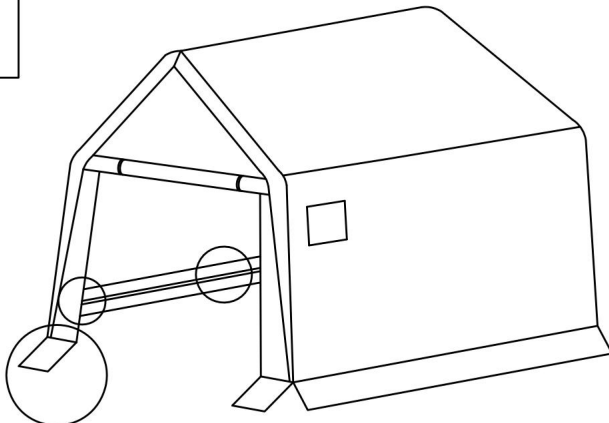

thread the Anchor(I) into the ground. Fix the Foot Plate (C)

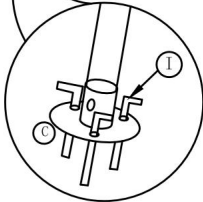

10

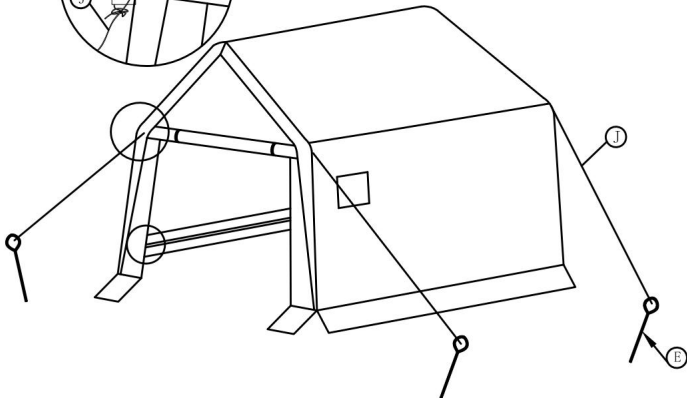
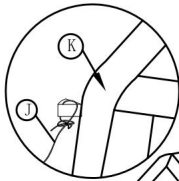

Tie one end of the rope J to the upper end of the door on both sides of the pull rope climb, the other end is tied to the ring with the ground nail, 4pcs pull rope at the same time to tighten the ground nail knocked into the ground soil, pay attention to the pull rope needs to be fixed firmly, can not be in a state of slack, correctly fixed after the completion of the installation!

### **Rengöring och underhåll 1. Om**

det finns snö eller is på toppen av snabbgaraget, vänligen rensa det i tid.

2. Det rekommenderas att rengöra ytan på snabbgaraget regelbundet med mild tvål och vatten.

Sanven Technology Ltd.

Adress: Suite 250, 9166 Anaheim Place, Rancho Cucamonga, CA 91730



**VEVOR<sup>®</sup>**

**TOUGH TOOLS, HALF PRICE**

Teknisk support och e-garanticertifikat

[www.vevor.com/support](http://www.vevor.com/support)

# VEVOR<sup>®</sup>

## TOUGH TOOLS, HALF PRICE

Soporte técnico y certificado de garantía electrónica

[www.vevor.com/support](http://www.vevor.com/support)

### REFUGIO DE ALMACENAMIENTO AL AIRE LIBRE

### MANUAL DEL USUARIO

Seguimos comprometidos a brindarle herramientas a precios competitivos.

"Ahorre la mitad", "mitad de precio" o cualquier otra expresión similar que utilicemos solo representa una estimación del ahorro que podría obtener al comprar ciertas herramientas con nosotros en comparación con las principales marcas y no necesariamente significa que cubra todas las categorías de herramientas que ofrecemos. Le recordamos que, al realizar un pedido con nosotros, verifique cuidadosamente si realmente está ahorrando la mitad en comparación con las principales marcas.

# VEVOR<sup>®</sup>

ALMACENAMIENTO AL AIRE LIBRE

REFUGIO

MODELO:SCP0712/SCP0814

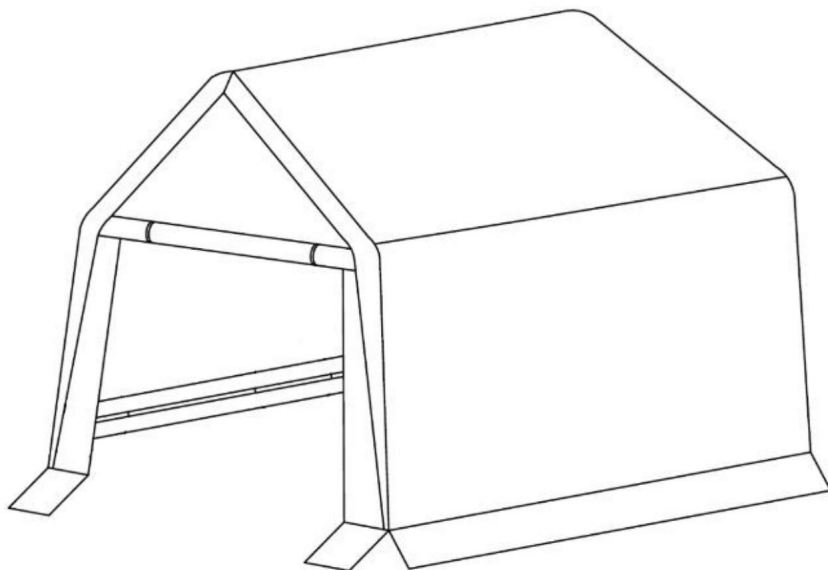

¿NECESITA AYUDA? ¡CONTÁCTENOS!

¿Tiene preguntas sobre el producto? ¿Necesita asistencia técnica? No dude en ponerse en contacto con nosotros:

Soporte técnico y certificado de garantía electrónica [www.vevor.com/support](http://www.vevor.com/support)

Estas son las instrucciones originales, lea atentamente todas las instrucciones del manual antes de utilizar el producto. VEVOR se reserva una interpretación clara de nuestro manual de usuario. La apariencia del producto estará sujeta al producto que recibió. Perdónenos por no informarle nuevamente si hay actualizaciones de tecnología o software en nuestro producto.

## INSTRUCCIONES DE SEGURIDAD





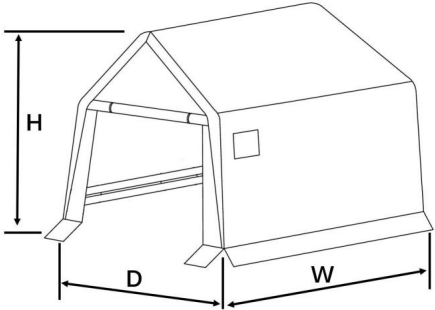



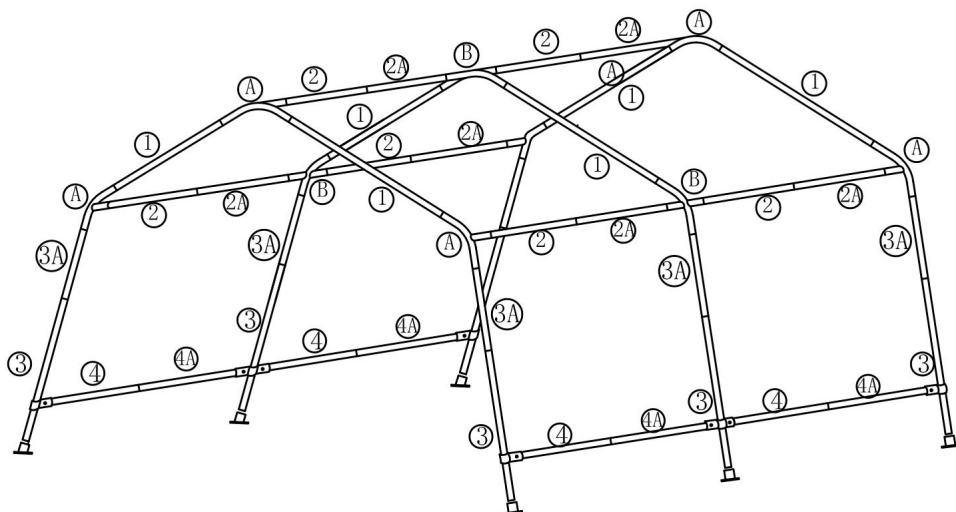

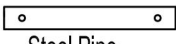

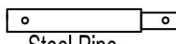
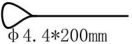

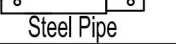

1. El garaje instantáneo debe instalarse sobre césped liso.
2. Se recomienda utilizar guantes durante el montaje.
3. Es posible que necesites usar una escalera durante el montaje. Presta atención a las medidas de seguridad.
4. Si alguna parte del producto está dañada, no lo utilice.
5. No se pare ni se sienta sobre el garaje instantáneo.
6. No fume ni utilice dispositivos de llama abierta dentro y alrededor del garaje instantáneo.  
evitar el fuego.
7. En caso de mal tiempo, es necesario guardar el garaje instantáneo.
8. No se recomienda su uso en condiciones de nieve.
9. Realice el montaje siguiendo estrictamente las instrucciones y utilice cuerda, ancla y  
Otros accesorios en el proceso de montaje.

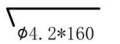
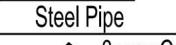
## MODELO Y PARÁMETROS

Apariencia	Color	Tamaño <small>(Profundidad*ancho*alto)</small>	Neto Peso
	Gris	(SCP0712) 7*12*7,36 pies	79,3 libras
	Gris	(SCP0814) 8 x 14 x 7,6 pies	87,7 libras

## COMPONENTES



1#	 Steel Pipe	6pcs	D1#	 Rail Clamp	4pcs
2#	 Steel Pipe	6pcs	E#	 Anchor $\phi 4.4 \times 200\text{mm}$	4pcs
2A#	 Steel Pipe	6pcs	F#	 Bungee Cord	32+4pcs
3#	 Steel Pipe	6pcs	G#	 M8×50 Screw	6+4pcs
3A#	 Steel Pipe	6pcs	H#	 M6×45mm Screw	16+1pcs
4#	 Steel Pipe	4pcs	I#	 Ground Peg $\phi 4.2 \times 160$	18pcs
4A#	 Steel Pipe	4pcs	J#	 Rope $\phi 5$	4pcs
A#	 3-way Corner Connector	6pcs	K#	 Roof Cover	1pc
B#	 4-way Corner Connector	3pcs	K1#	 Door Cover	1pc
C#	 Foot Plate	6pcs	K2#	 Back Cover	1pc
D#	 Rail Clamp	8pcs			



## ASAMBLEA

1

Find out (A,B,1,2,2A)parts, and place them according to the position of the parts in the picture.

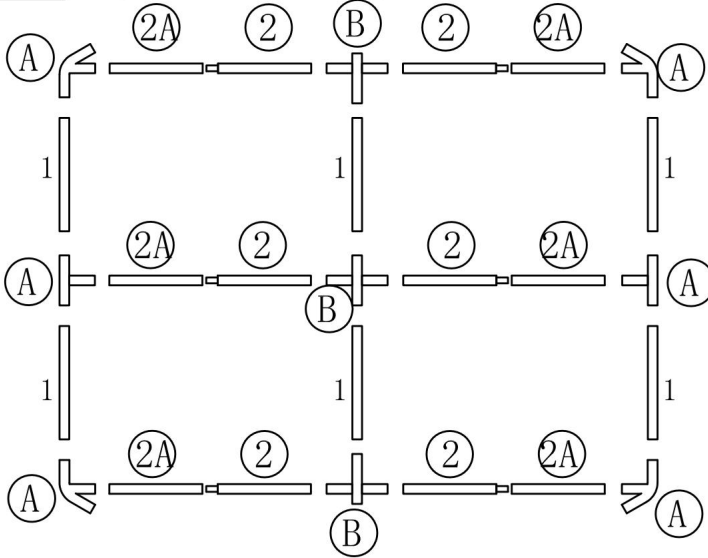

2

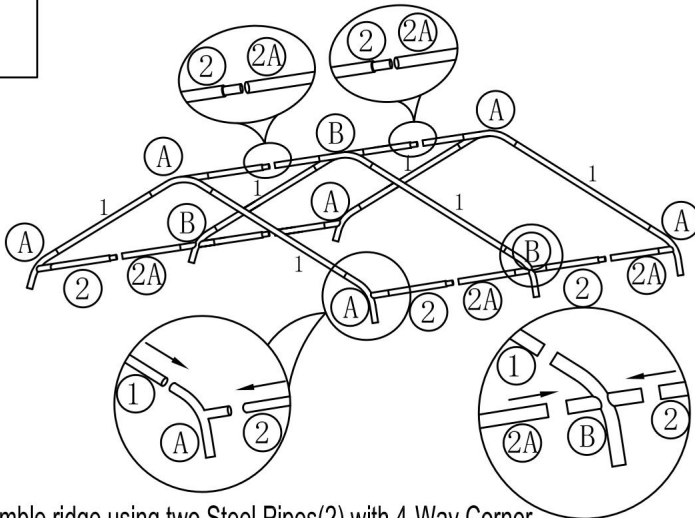

Assemble ridge using two Steel Pipes(2) with 4-Way Corner Connectors(B) between them, and a 3-Way Corner Connector(A) on each end. Connect a Steel Pipe(1) to each end of every connector (A,B) to get the roof frame.

3

Put the flat end of 3A# into connector A#,B# and then connect 3# pipe to 3A#.

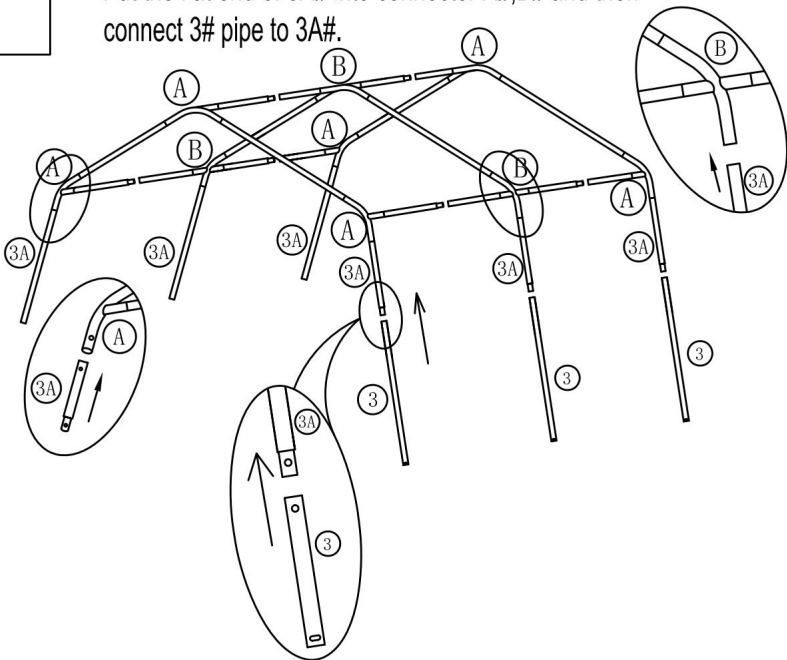

4

Put the Roof Cover(K) on the top frame.

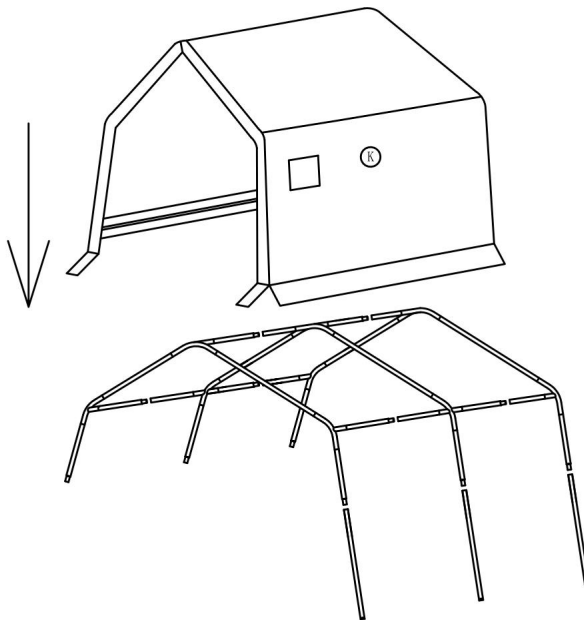

5

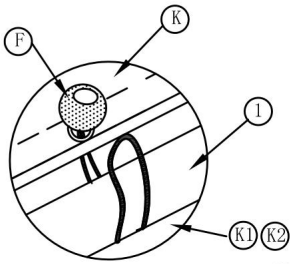

Assemble the Door Cover(K1) and Back Cover(K2) to the Steel Pipe(1) with the Bungee Cord(F)

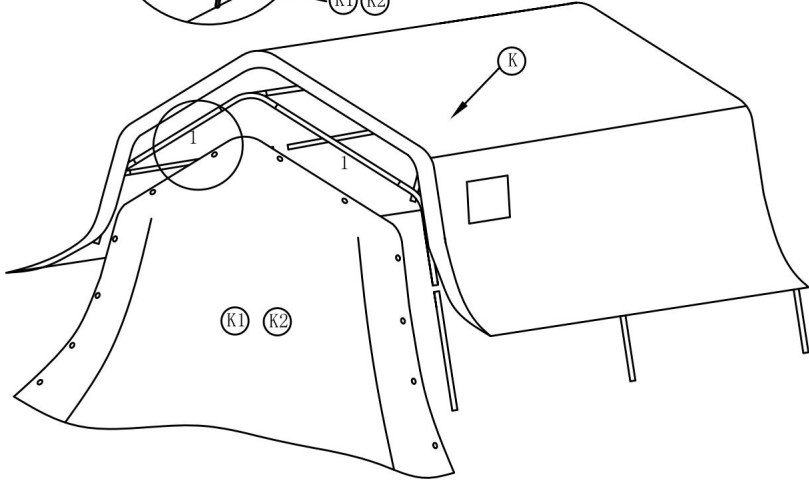

6

Assemble the long pipes using each Steel Pipes(3,3A).

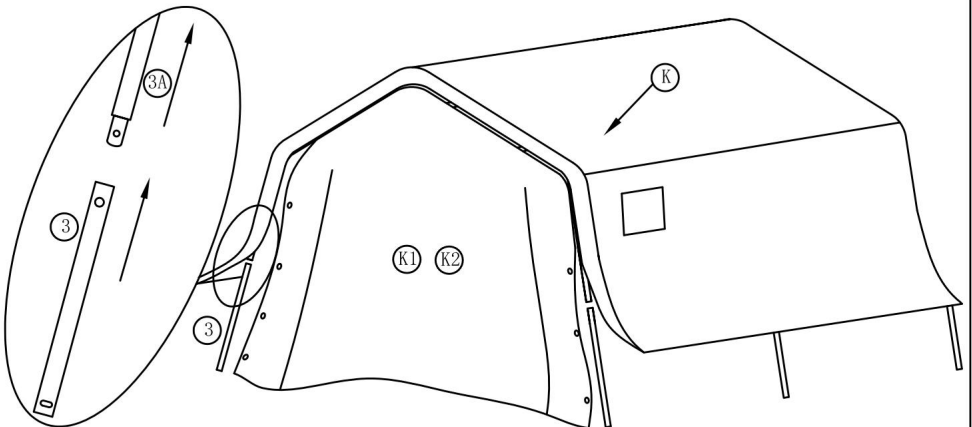

7

Fix the Door Cover(K1) and Back Cover(K2) on the long pipes (step 6) with the Bungee Cord(F)

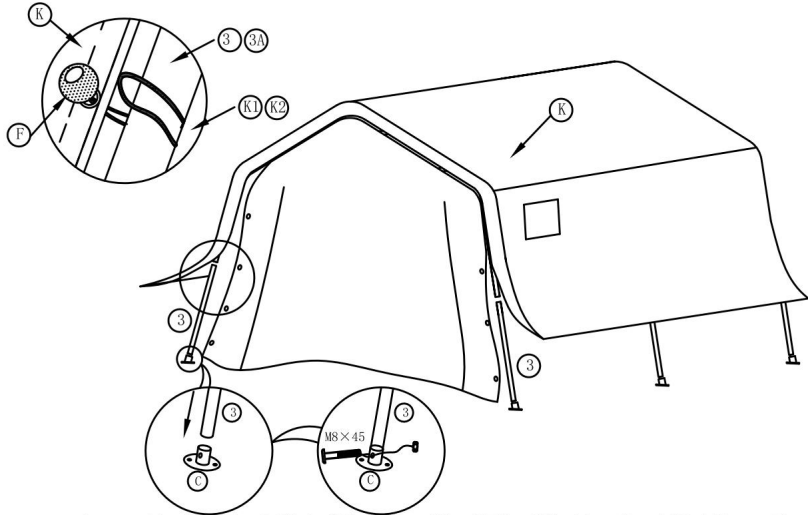

Assemble the Foot Plate(C) to the Steel Pipe(3) .Use the M8×50mm Screw (M) to four corners,As shown in the figure

8

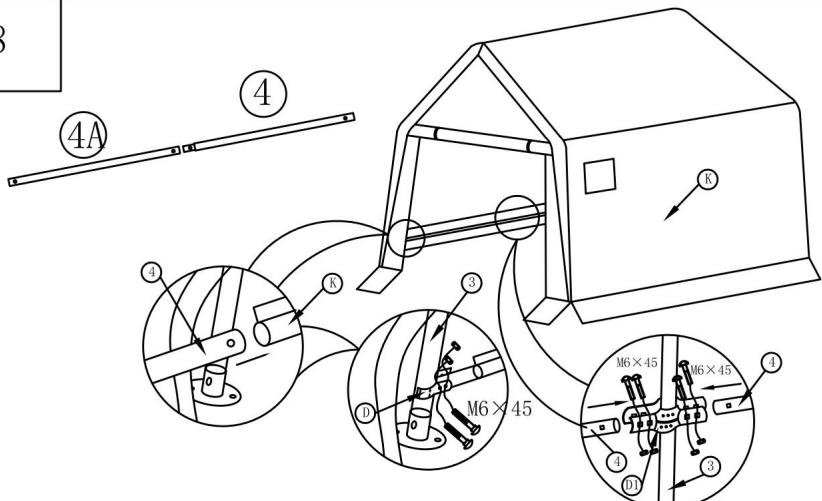

Connect the steel pipe 4#/4A# and insert it into the pipe sleeve at the lower end of both sides of the cover, and use M6\*45mm screws to fix it to the 3# steel pipe through the clamps D,D1.

Note: After all the clamps D,D1 on both sides are completely fixed, you need to tighten the cover at the same time to tighten the screws!

9

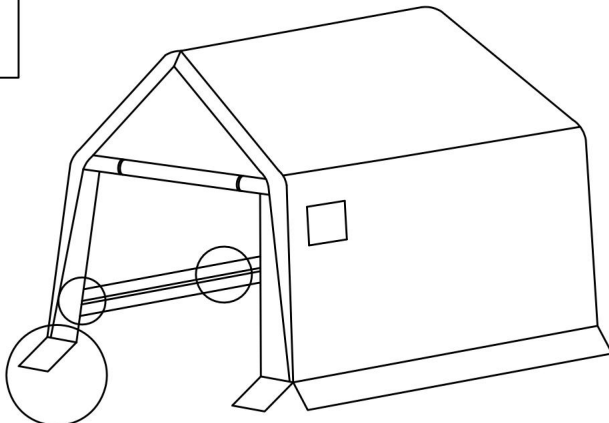

thread the Anchor(I) into the ground. Fix the Foot Plate (C)

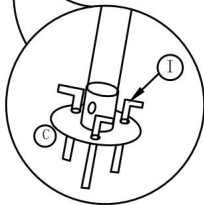

10

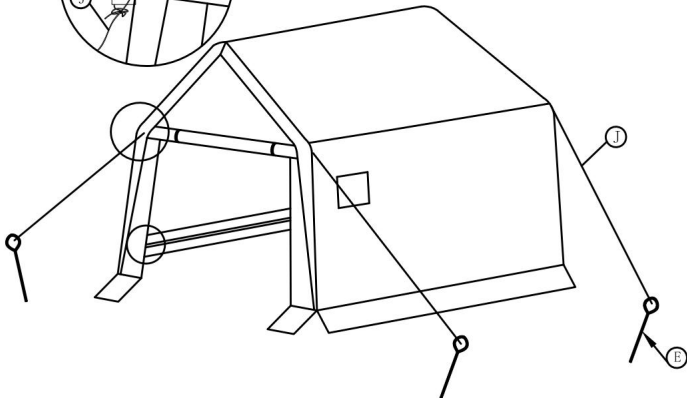
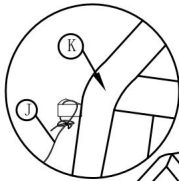

Tie one end of the rope J to the upper end of the door on both sides of the pull rope climb, the other end is tied to the ring with the ground nail, 4pcs pull rope at the same time to tighten the ground nail knocked into the ground soil, pay attention to the pull rope needs to be fixed firmly, can not be in a state of slack, correctly fixed after the completion of the installation!

### Limpieza y mantenimiento 1. Si

- hay nieve o hielo en la parte superior del garaje instantáneo, límpielo a tiempo.
- Se recomienda limpiar periódicamente la superficie del garaje instantáneo con agua y jabón suave.

Tecnología Sanven Ltd.

Dirección: Suite 250, 9166 Anaheim Place, Rancho Cucamonga, CA 91730



**VEVOR<sup>®</sup>**

**TOUGH TOOLS, HALF PRICE**

Soporte técnico y certificado de garantía

electrónica [www.vevor.com/support](http://www.vevor.com/support)



# VEVOR®

## TOUGH TOOLS, HALF PRICE

Supporto tecnico e certificato di garanzia elettronica

[www.vevor.com/support](http://www.vevor.com/support)

## RIFUGIO PER STOCCAGGIO ESTERNO

### MANUALE D'USO

Continuiamo a impegnarci per fornirvi strumenti a prezzi competitivi.

"Risparmia la metà", "Metà prezzo" o qualsiasi altra espressione simile da noi utilizzata rappresenta solo una stima del risparmio che potresti ottenere acquistando determinati utensili con noi rispetto ai principali marchi principali e non significa necessariamente coprire tutte le categorie di utensili da noi offerti. Ti ricordiamo gentilmente di verificare attentamente quando effettui un ordine con noi se stai effettivamente risparmiando la metà rispetto ai principali marchi principali.

# VEVOR<sup>®</sup> STOCCAGGIO ESTERNO

## RIPARO

**MODELLO:SCP0712/SCP0814**

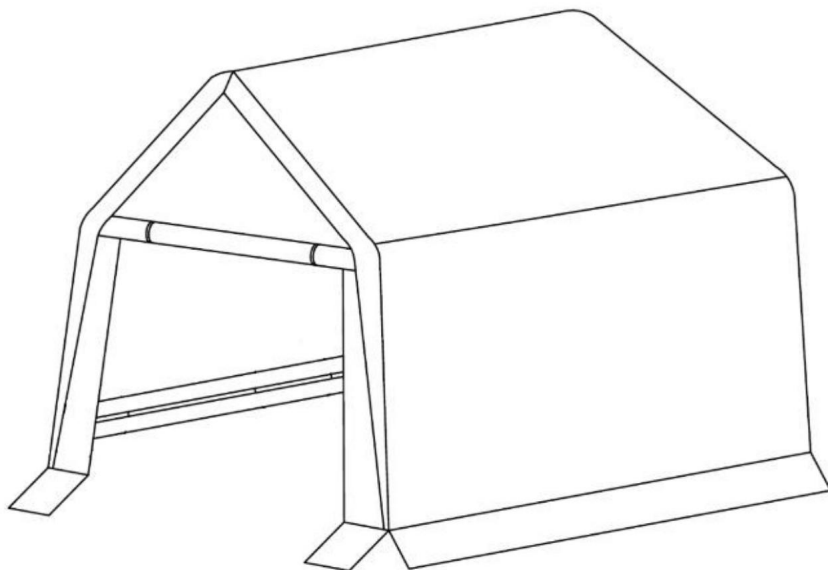

### HAI BISOGNO DI AIUTO? CONTATTACI!

Hai domande sui prodotti? Hai bisogno di supporto tecnico? Non esitare a contattarci:

**Supporto tecnico e certificato di garanzia elettronica [www.vevor.com/support](http://www.vevor.com/support)**

Questa è l'istruzione originale, si prega di leggere attentamente tutte le istruzioni del manuale prima di utilizzare. VEVOR si riserva una chiara interpretazione del nostro manuale utente. L'aspetto del prodotto sarà soggetto al prodotto ricevuto. Vi preghiamo di perdonarci se non vi informeremo di nuovo se ci sono aggiornamenti tecnologici o software sul nostro prodotto.

## ISTRUZIONI DI SICUREZZA





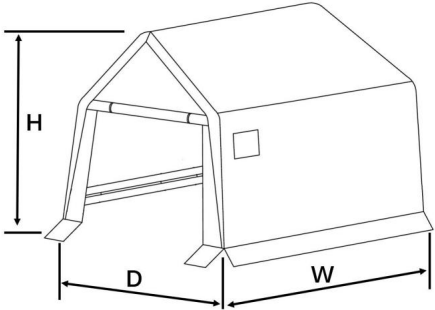



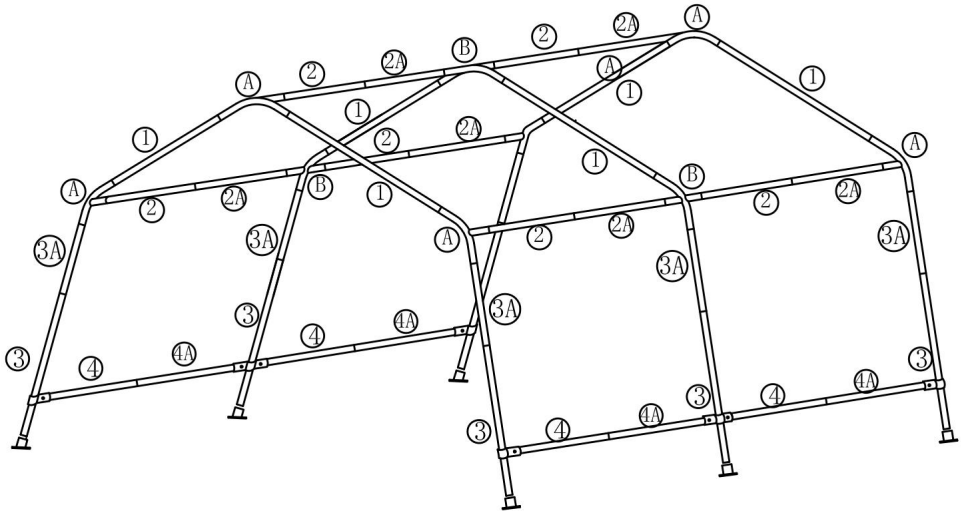

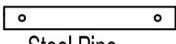

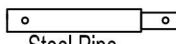
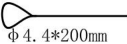

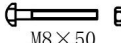
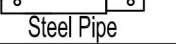
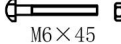

1. Il garage istantaneo deve essere installato su un prato liscio.
2. Si consiglia di indossare guanti durante il montaggio.
3. Potrebbe essere necessario utilizzare una scala durante il montaggio. Si prega di prestare attenzione alla sicurezza.
4. Se una qualsiasi parte del prodotto è danneggiata, non utilizzarla.
5. Non sostare o sedersi sopra il garage istantaneo.
6. Non fumare o utilizzare dispositivi a fiamma libera all'interno e nei pressi del garage.  
evitare il fuoco.
7. In caso di maltempo, il garage immediato deve essere riposto.
8. Si sconsiglia l'utilizzo in condizioni di neve.
9. Montare seguendo scrupolosamente le istruzioni e utilizzare corda, ancora e altri accessori nel processo di assemblaggio.

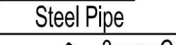
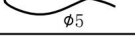
## MODELLO E PARAMETRI

Aspetto	Colore	Misurare (P*L*A)	Netto Peso
	Grigio	<b>(SCP0712)</b> 7*12*7.36FT	79,3 libbre
	Grigio	<b>(SCP0814)</b> 8*14*7.6 PIEDI	87,7 libbre

## COMPONENTI



1#	 Steel Pipe	6pcs	D1#	 Rail Clamp	4pcs
2#	 Steel Pipe	6pcs	E#	 Anchor $\phi 4.4 \times 200\text{mm}$	4pcs
2A#	 Steel Pipe	6pcs	F#	 Bungee Cord	32+4pcs
3#	 Steel Pipe	6pcs	G#	 M8×50 Screw	6+4pcs
3A#	 Steel Pipe	6pcs	H#	 M6×45mm Screw	16+1pcs
4#	 Steel Pipe	4pcs	I#	 Ground Peg $\phi 4.2 \times 160$	18pcs
4A#	 Steel Pipe	4pcs	J#	 Rope $\phi 5$	4pcs
A#	 3-way Corner Connector	6pcs	K#	 Roof Cover	1pc
B#	 4-way Corner Connector	3pcs	K1#	 Door Cover	1pc
C#	 Foot Plate	6pcs	K2#	 Back Cover	1pc
D#	 Rail Clamp	8pcs			

## ASSEMBLAGGIO

1

Find out (A,B,1,2,2A) parts, and place them according to the position of the parts in the picture.

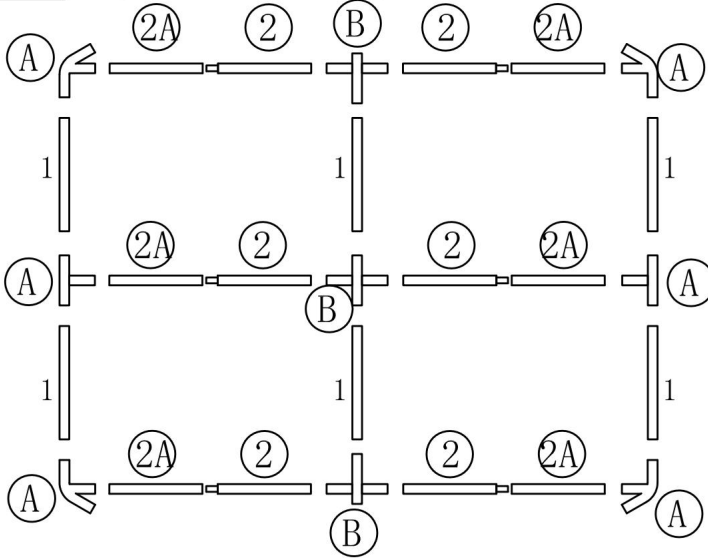

2

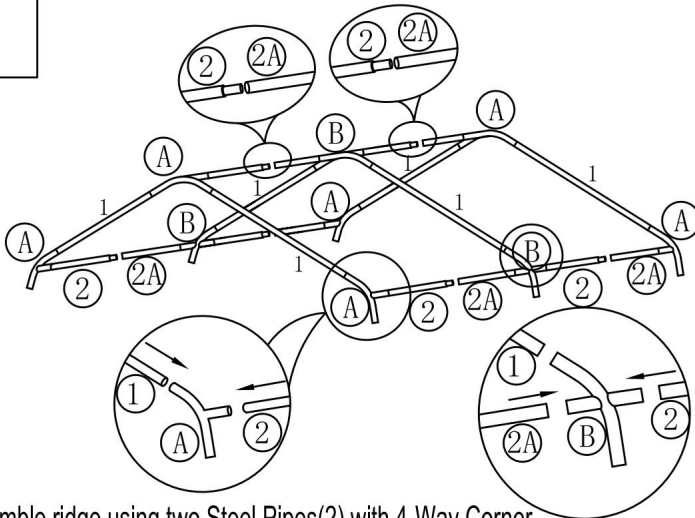

Assemble ridge using two Steel Pipes(2) with 4-Way Corner Connectors(B) between them, and a 3-Way Corner Connector(A) on each end. Connect a Steel Pipe(1) to each end of every connector (A,B) to get the roof frame.

3

Put the flat end of 3A# into connector A#,B# and then connect 3# pipe to 3A#.

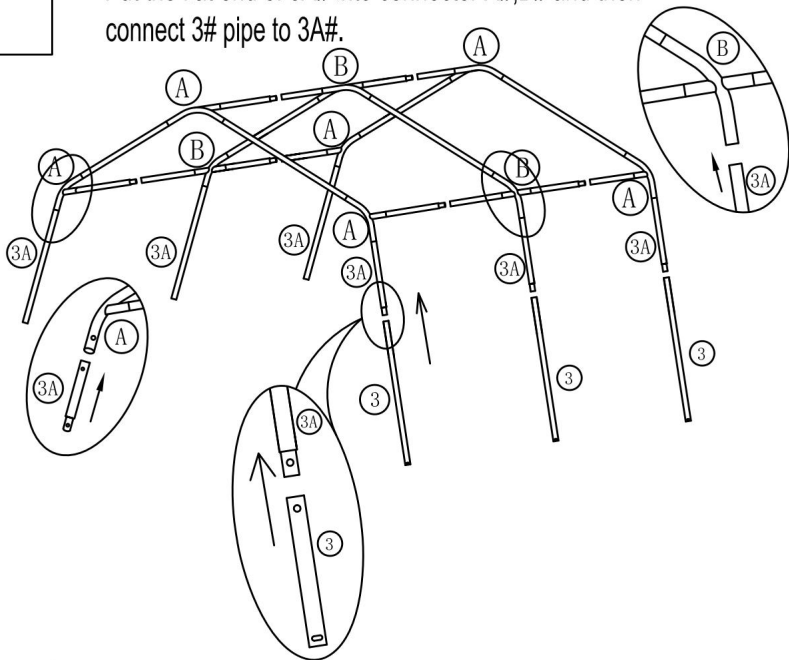

4

Put the Roof Cover(K) on the top frame.

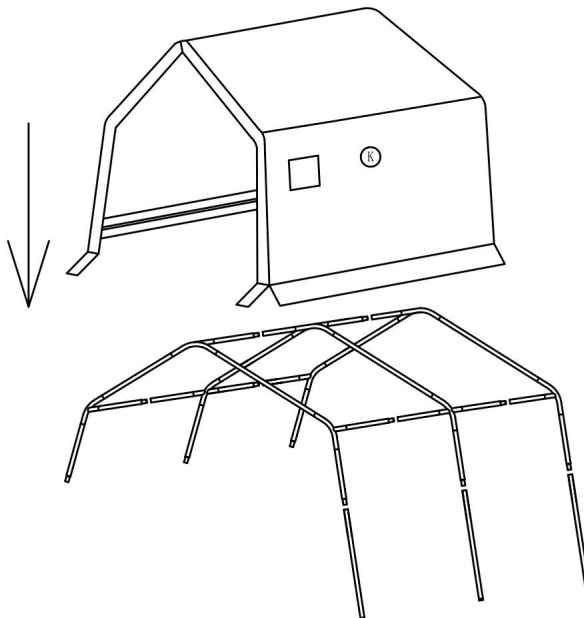

5

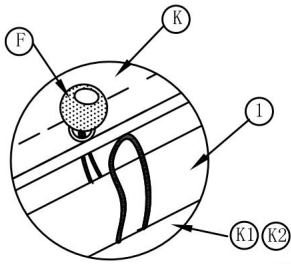

Assemble the Door Cover(K1) and Back Cover(K2) to the Steel Pipe(1) with the Bungee Cord(F)

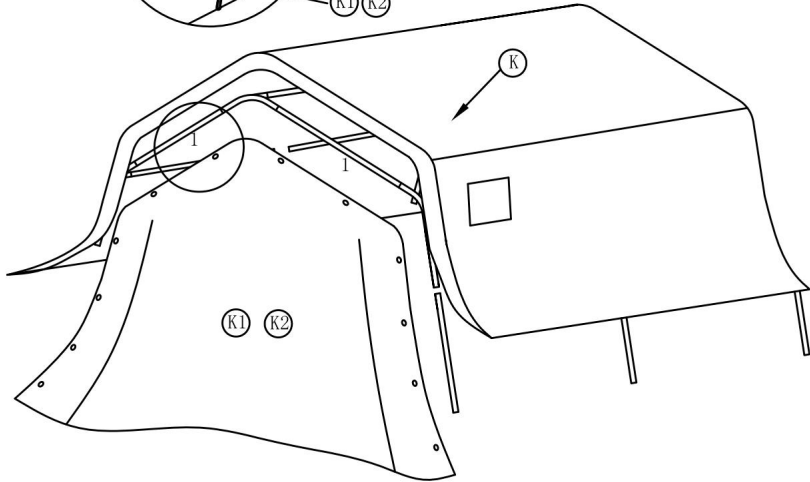

6

Assemble the long pipes using each Steel Pipes(3,3A).

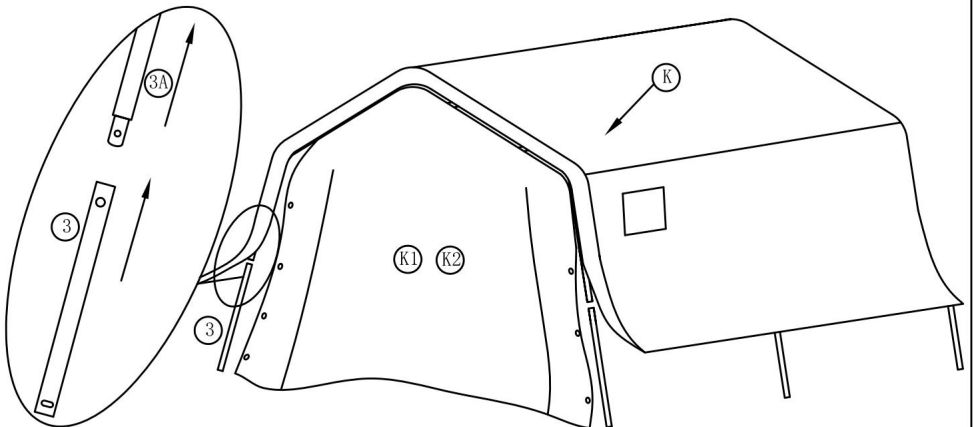

7

Fix the Door Cover(K1) and Back Cover(K2) on the long pipes (step 6) with the Bungee Cord(F)

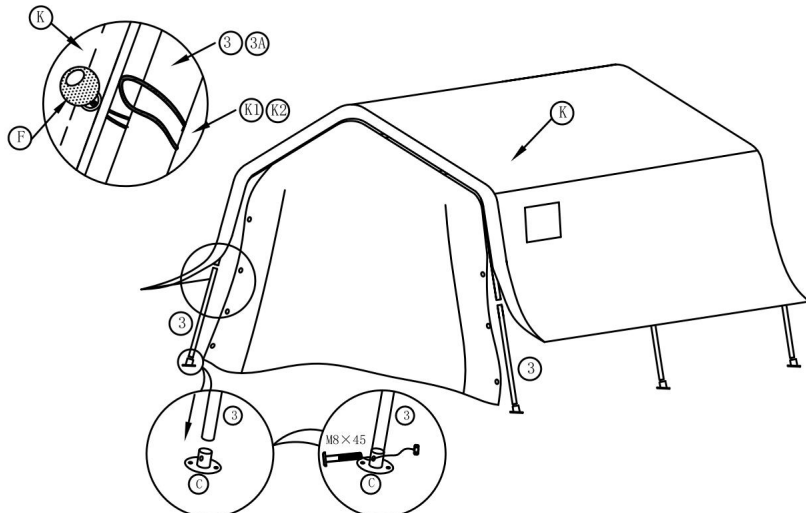

Assemble the Foot Plate(C) to the Steel Pipe(3) .Use the M8×50mm Screw (M) to four corners,As shown in the figure

8

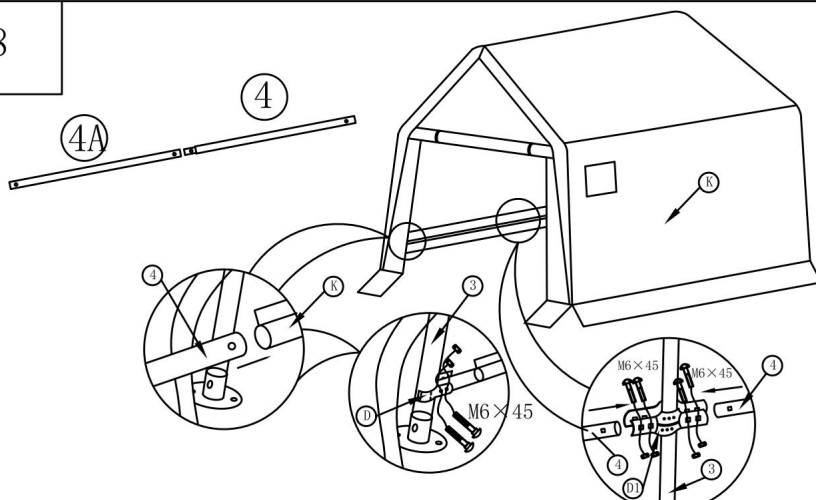

Connect the steel pipe 4#/4A# and insert it into the pipe sleeve at the lower end of both sides of the cover, and use M6\*45mm screws to fix it to the 3# steel pipe through the clamps D,D1.

Note: After all the clamps D,D1 on both sides are completely fixed, you need to tighten the cover at the same time to tighten the screws!



9

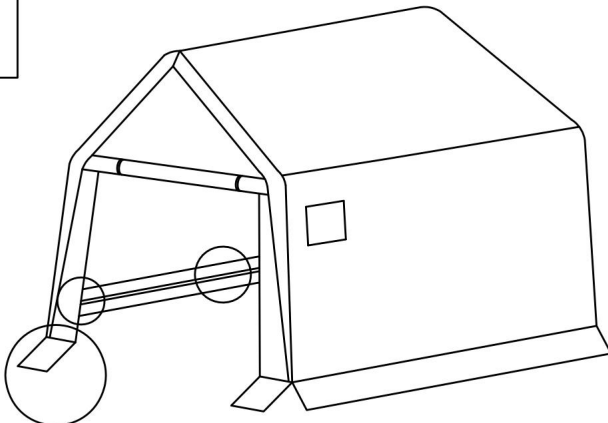

thread the Anchor(I) into the ground. Fix the Foot Plate (C)

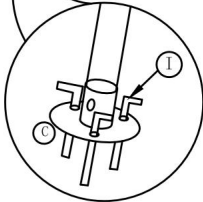

10

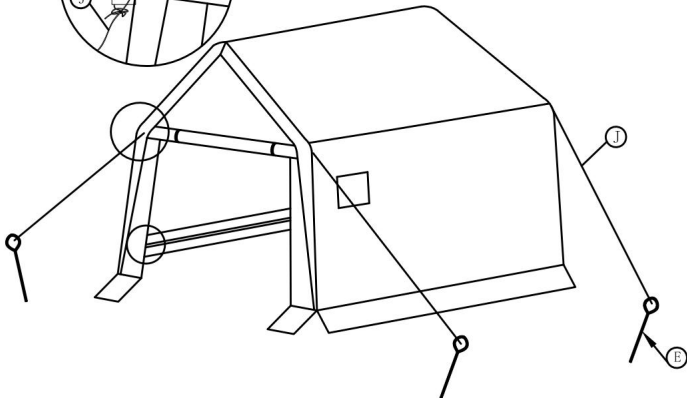
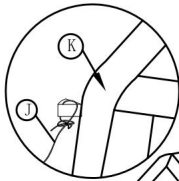

Tie one end of the rope J to the upper end of the door on both sides of the pull rope climb, the other end is tied to the ring with the ground nail, 4pcs pull rope at the same time to tighten the ground nail knocked into the ground soil, pay attention to the pull rope needs to be fixed firmly, can not be in a state of slack, correctly fixed after the completion of the installation!

### **Pulizia e manutenzione 1. Se**

sulla parte superiore del garage si trova neve o ghiaccio, si prega di rimuoverli in tempo.

2. Si consiglia di pulire regolarmente la superficie del garage istantaneo con acqua e sapone neutro.

### **Azienda**

Indirizzo: Suite 250, 9166 Anaheim Place, Rancho Cucamonga, CA 91730



**VEVOR<sup>®</sup>**

**TOUGH TOOLS, HALF PRICE**

Supporto tecnico e certificato di garanzia  
elettronica [www.vevor.com/support](http://www.vevor.com/support)

# VEVOR<sup>®</sup>

## TOUGH TOOLS, HALF PRICE

Wsparcie techniczne i certyfikat e-gwarancji

[www.vevor.com/support](http://www.vevor.com/support)

Schron do przechowywania na zewnątrz

### INSTRUKCJA OBSŁUGI

Nadal staramy się oferować Państwu narzędzia w konkurencyjnych cenach.

„Oszczędź połowę”, „Połowa ceny” lub inne podobne wyrażenia używane przez nas stanowią jedynie szacunkowe oszczędności, jakie możesz uzyskać, kupując u nas określone narzędzia w porównaniu z głównymi markami i niekoniecznie oznaczają one objęcie wszystkich kategorii narzędzi oferowanych przez nas. Uprzejmie przypominamy, aby dokładnie sprawdzić, czy składając u nas zamówienie faktycznie oszczędzasz połowę w porównaniu z głównymi markami.

# VEVOR<sup>®</sup>

PRZECHOWYWANIE NA ZEWNĄTRZ

SCHRONIENIE

MODEL:SCP0712/SCP0814

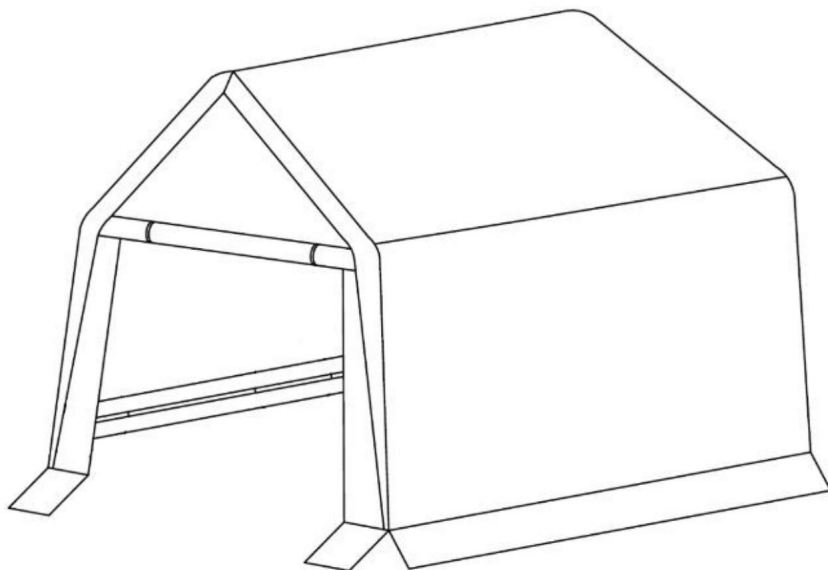

POTRZEBUJESZ POMOCY? SKONTAKTUJ SIĘ Z NAMI!!

Masz pytania dotyczące produktu? Potrzebujesz wsparcia technicznego? Skontaktuj się z nami:

Wsparcie techniczne i certyfikat gwarancji elektronicznej [www.vevor.com/support](http://www.vevor.com/support)

To jest oryginalna instrukcja, przed użyciem należy uważnie przeczytać wszystkie instrukcje. VEVOR zastrzega sobie jasną interpretację naszej instrukcji obsługi. Wygląd produktu będzie zależał od produktu, który otrzymałeś. Prosimy o wybaczenie, że nie poinformujemy Cię ponownie, jeśli w naszym produkcie pojawią się jakiegokolwiek aktualizacje technologiczne lub oprogramowania.

## INSTRUKCJE BEZPIECZEŃSTWA





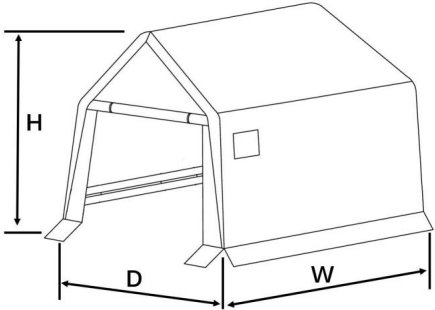



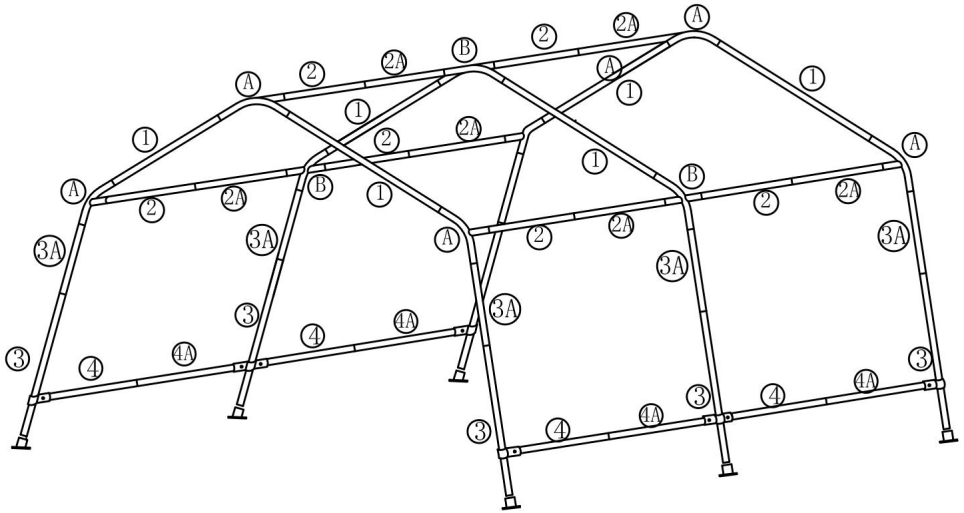

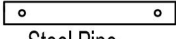

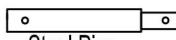
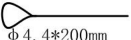
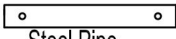

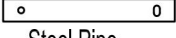
1. Garaż błyskawiczny należy zainstalować na gładkiej trawie.
2. Zaleca się założenie rękawiczek podczas montażu.
3. Podczas montażu może być konieczne użycie drabiny. Prosimy zwrócić uwagę na bezpieczeństwo.
4. Jeśli jakkolwiek część produktu jest uszkodzona, nie należy go używać.
5. Nie stawaj i nie siadaj na górze garażu.
6. W garażu i wokół niego nie wolno palić tytoniu ani używać urządzeń z otwartym ogniem. unikać ognia.
7. Przy złej pogodzie garaż należy schować.
8. Nie zaleca się używania urządzenia w warunkach śnieżnych.
9. Montaż należy wykonać ściśle według instrukcji, używając liny, kotwicy i inne akcesoria w procesie montażu.

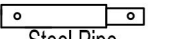
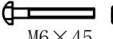
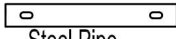
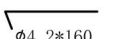
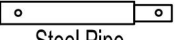
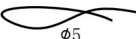
## MODEL I PARAMETRY

Wygląd	Kolor	Rozmiar (D*S*W)	Internet Waga
	Szary	(SCP0712) 7*12*7,36 stóp	79,3 funta
	Szary	(SCP0814) 8*14*7,6 stóp	87,7 funtów

## SKŁADNIKI



1#	 Steel Pipe	6pcs	D1#	 Rail Clamp	4pcs
2#	 Steel Pipe	6pcs	E#	 Anchor $\phi 4.4 \times 200\text{mm}$	4pcs
2A#	 Steel Pipe	6pcs	F#	 Bungee Cord	32+4pcs
3#	 Steel Pipe	6pcs	G#	 M8×50 Screw	6+4pcs
3A#	 Steel Pipe	6pcs	H#	 M6×45mm Screw	16+1pcs
4#	 Steel Pipe	4pcs	I#	 Ground Peg $\phi 4.2 \times 160$	18pcs
4A#	 Steel Pipe	4pcs	J#	 Rope $\phi 5$	4pcs
A#	 3-way Corner Connector	6pcs	K#	 Roof Cover	1pc
B#	 4-way Corner Connector	3pcs	K1#	 Door Cover	1pc
C#	 Foot Plate	6pcs	K2#	 Back Cover	1pc
D#	 Rail Clamp	8pcs			



## MONTAŽ

1

Find out (A,B,1,2,2A)parts, and place them according to the position of the parts in the picture.

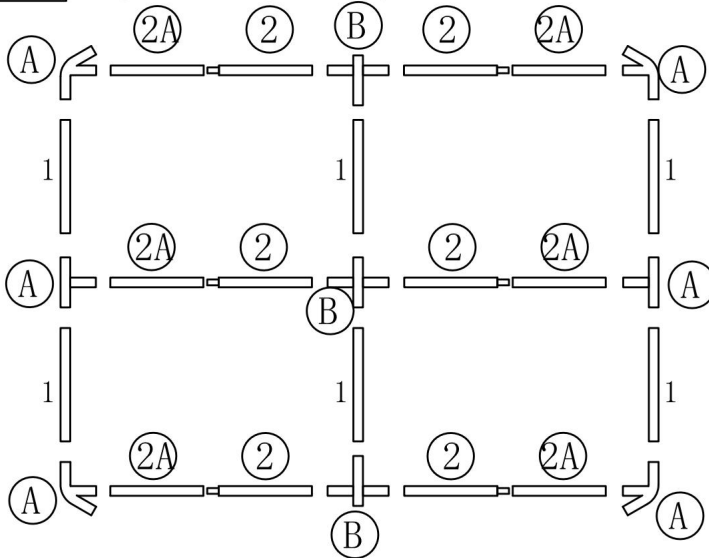

2

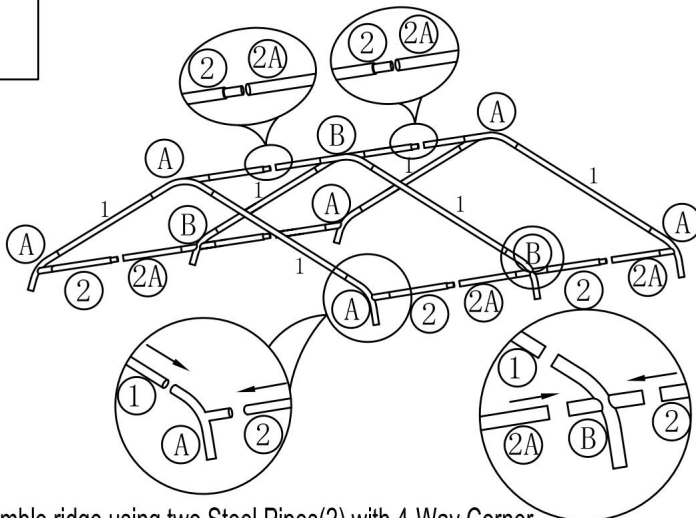

Assemble ridge using two Steel Pipes(2) with 4-Way Corner Connectors(B) between them, and a 3-Way Corner Connector(A) on each end. Connect a Steel Pipe(1) to each end of every connector (A,B) to get the roof frame.

3

Put the flat end of 3A# into connector A#,B# and then connect 3# pipe to 3A#.

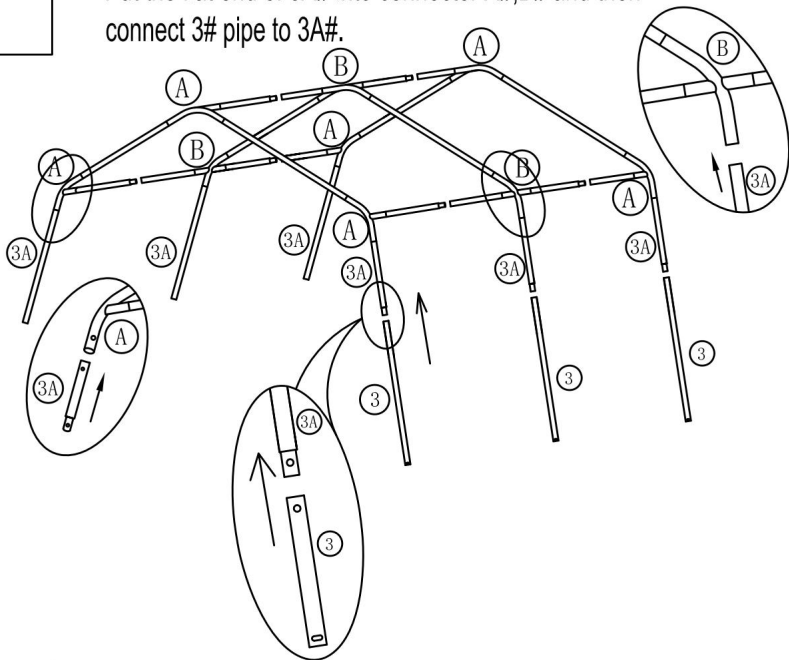

4

Put the Roof Cover(K) on the top frame.

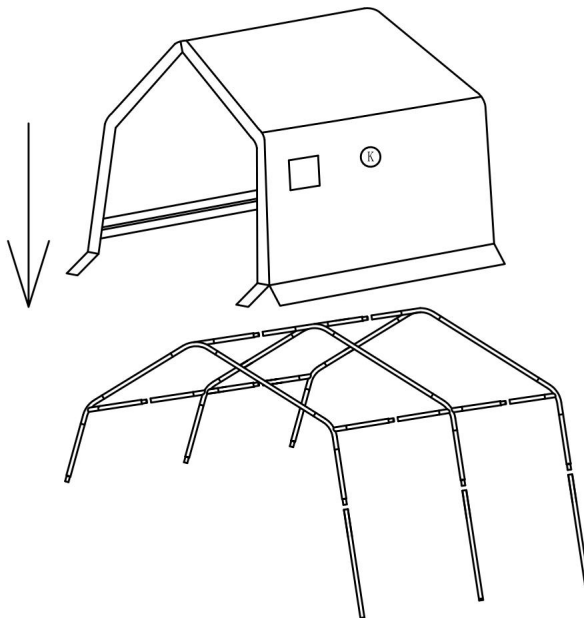

5

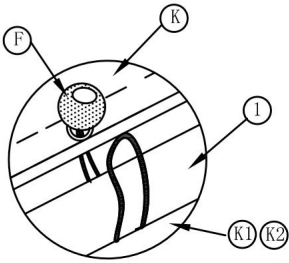

Assemble the Door Cover(K1) and Back Cover(K2) to the Steel Pipe(1) with the Bungee Cord(F)

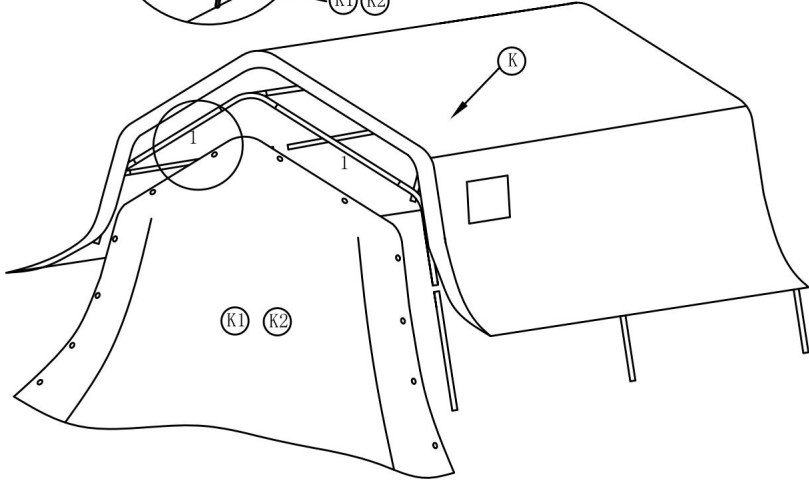

6

Assemble the long pipes using each Steel Pipes(3,3A).

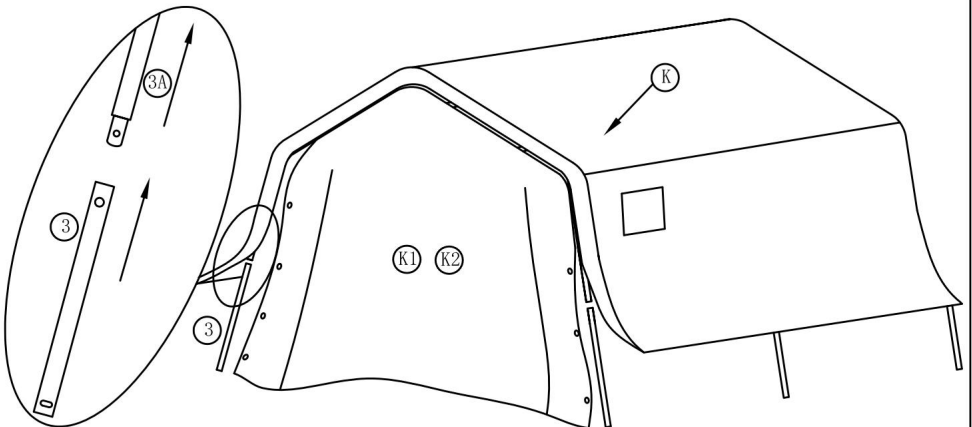

7

Fix the Door Cover(K1) and Back Cover(K2) on the long pipes (step 6) with the Bungee Cord(F)

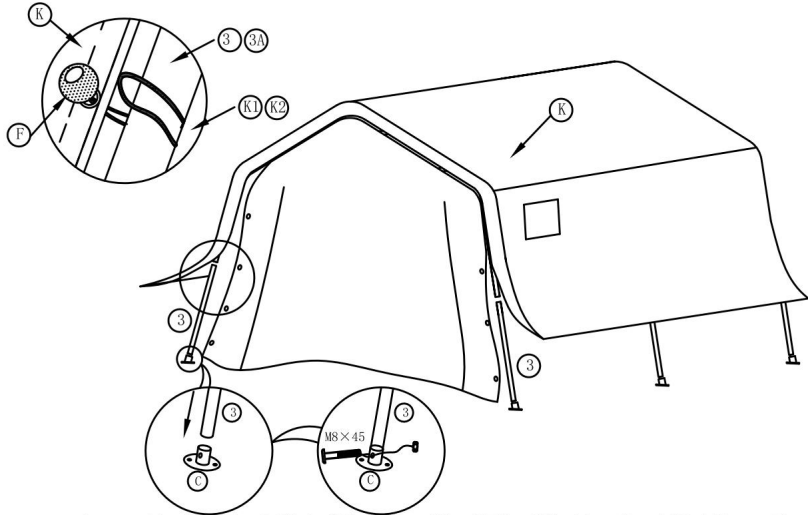

Assemble the Foot Plate(C) to the Steel Pipe(3) .Use the M8×50mm Screw (M) to four corners,As shown in the figure

8

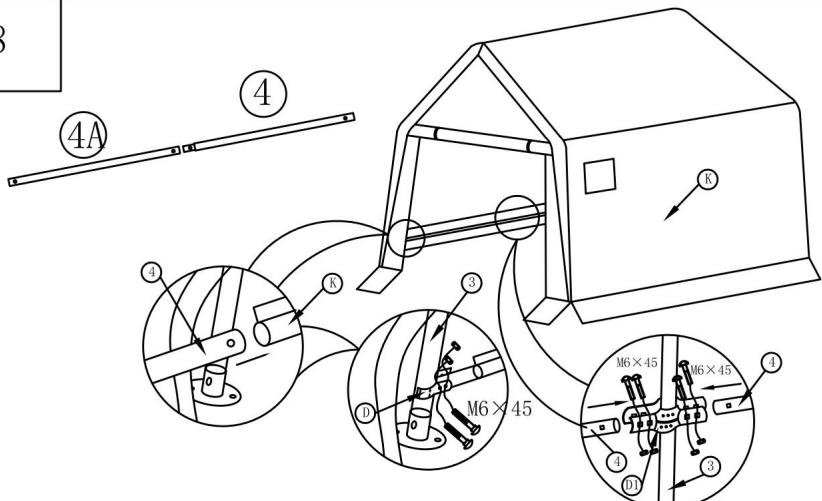

Connect the steel pipe 4#/4A# and insert it into the pipe sleeve at the lower end of both sides of the cover, and use M6\*45mm screws to fix it to the 3# steel pipe through the clamps D,D1.

Note: After all the clamps D,D1 on both sides are completely fixed, you need to tighten the cover at the same time to tighten the screws!

9

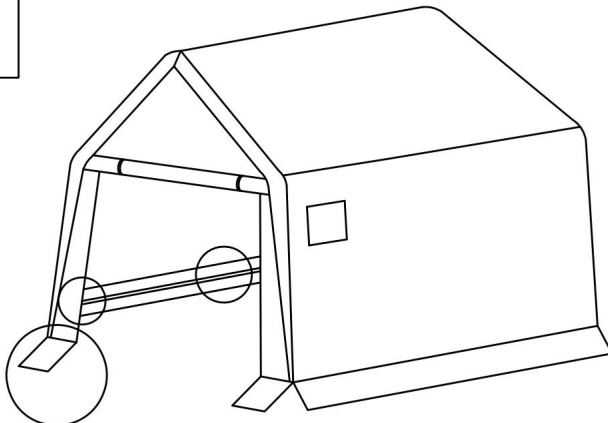

thread the Anchor(I) into the ground. Fix the Foot Plate (C)

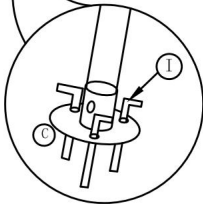

10

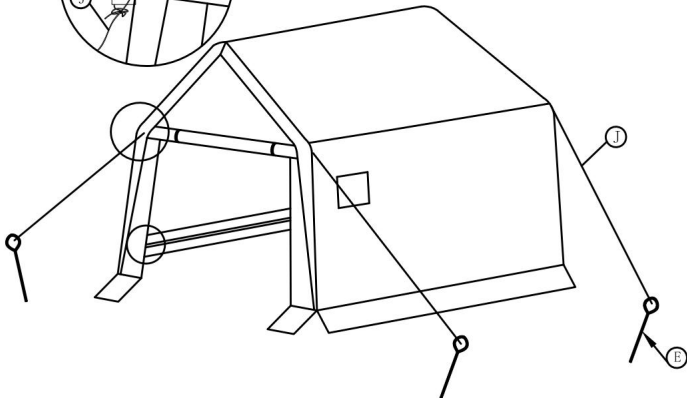
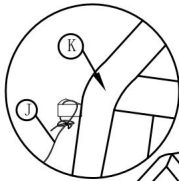

Tie one end of the rope J to the upper end of the door on both sides of the pull rope climb, the other end is tied to the ring with the ground nail, 4pcs pull rope at the same time to tighten the ground nail knocked into the ground soil, pay attention to the pull rope needs to be fixed firmly, can not be in a state of slack, correctly fixed after the completion of the installation!

### Czyszczenie i konserwacja 1. Jeśli

na górze garażu znajduje się śnieg lub lód, należy go usunąć na czas.

2. Zaleca się regularne czyszczenie powierzchni garażu błyskawicznego łagodnym mydłem i wodą.

Sanven Technology Ltd.

Adres: Suite 250, 9166 Anaheim Place, Rancho Cucamonga, CA 91730



**VEVOR<sup>®</sup>**

**TOUGH TOOLS, HALF PRICE**

Wsparcie techniczne i certyfikat gwarancji  
elektronicznej [www.vevor.com/support](http://www.vevor.com/support)