





# SMART DEADBOLT

## Installation and User Guide

Required tools (not included)

- Ruler 
- Philips head screwdriver 
- Hammer 
- Chisel 

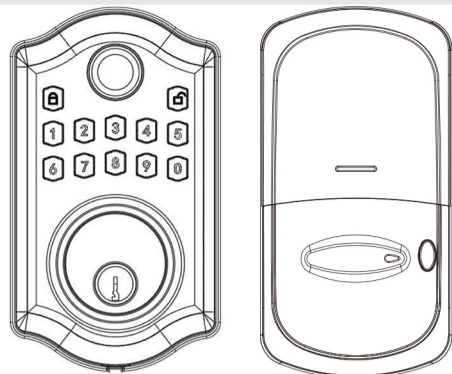

### What's in the box

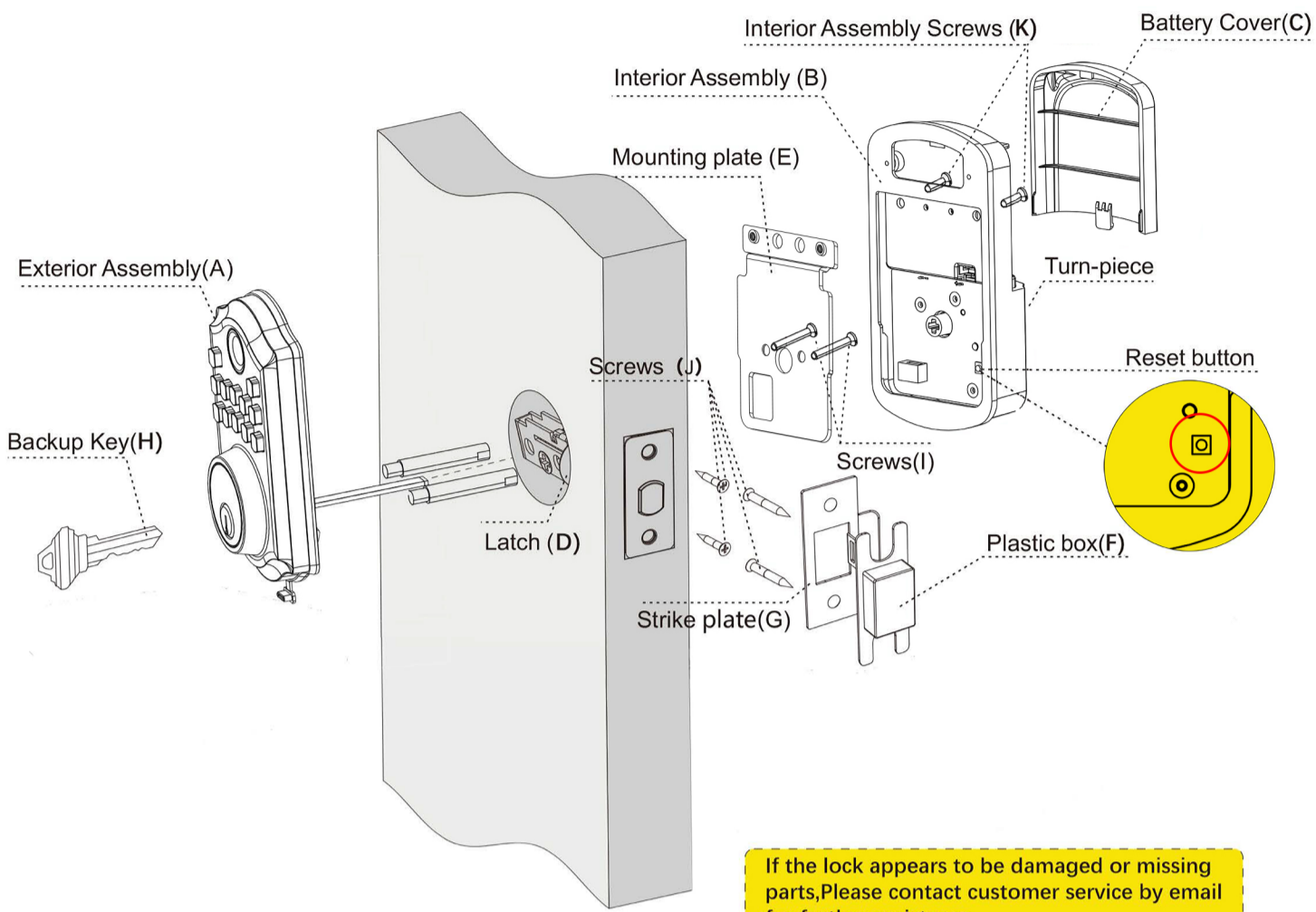

If the lock appears to be damaged or missing parts, please contact customer service by email for further assistance.

### Parts List

<b>A</b> Exterior Assembly	<b>B</b> Interior Assembly	<b>C</b> Battery Cover	<b>D</b> Latch Bolt	<b>E</b> Mounting plate
<b>F</b> Plastic box	<b>G</b> Strike Plate	<b>H</b> Backup Key	<b>I</b> Mounting Plate Screws (Longer)	<b>J</b> Latch and Strike Screws
				<b>K</b> Interior Assembly Screws (Shorter)

### Installation instructions

- 1 Don't insert the key to the cylinder when installing the deadbolt!!!
  - 2 Battery:
    - a. Use new and **NON**-rechargeable 4 AA batteries for the best use.
    - b. Don't load batteries until the lock is completely installed.
  - 3 Adjust latch to insert horizontally.
- If you have any problems, don't hesitate to contact with us through Amazon messaging at the first time.

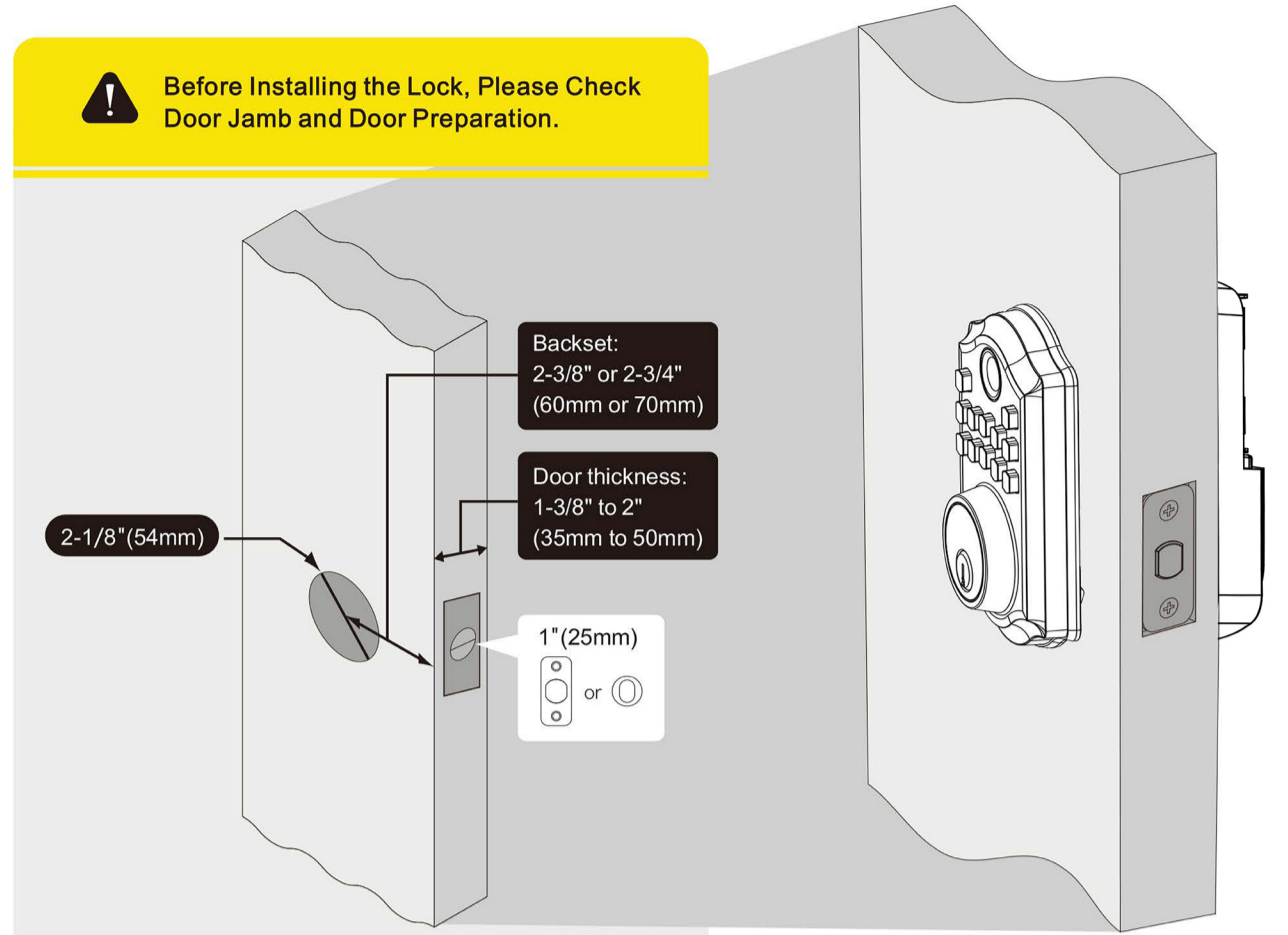

### Simple flowchart of installation

Please refer to the next section if you need a more detailed installation process.

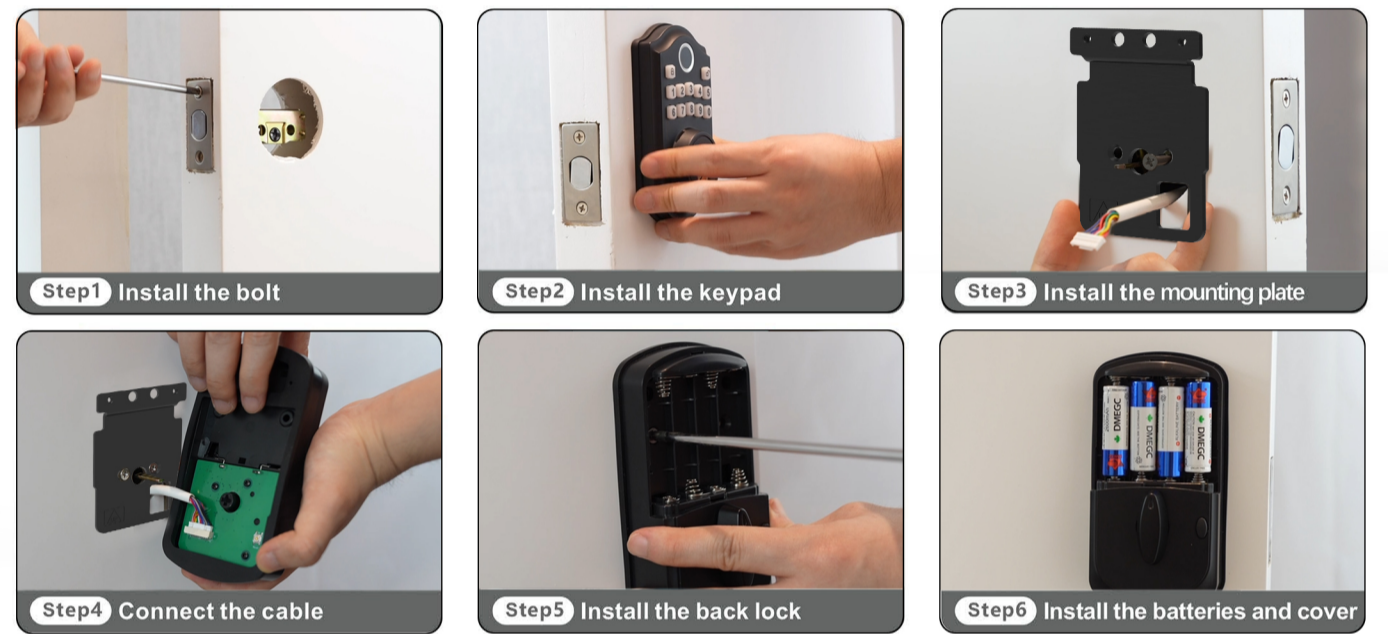

### 1. Remove existing deadbolt

- 1 Do not discard old lock + hardware until new Lock has been successfully installed.
- 2 Remove the lock from the door, including the old latch.

### 2. Prepare the door and check dimensions

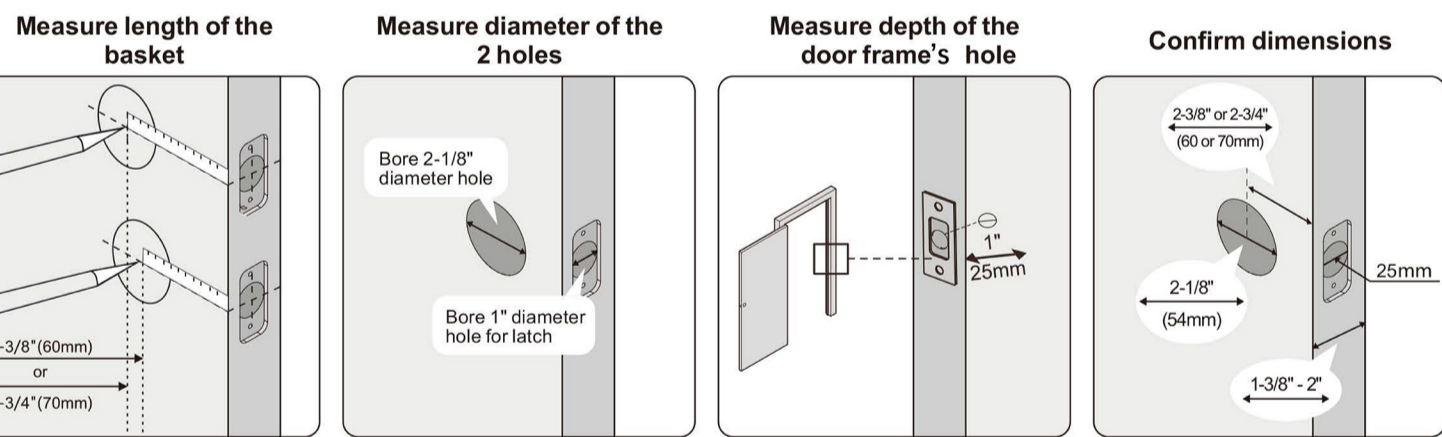

### 3. Install the latch and strike plate

#### A. Check backset and adjust the latch

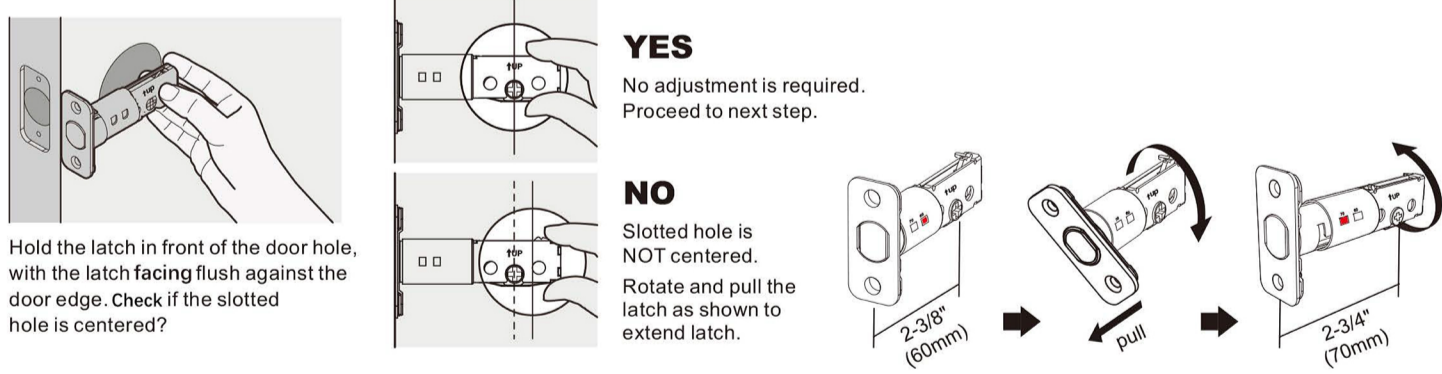

#### B. Install the latch

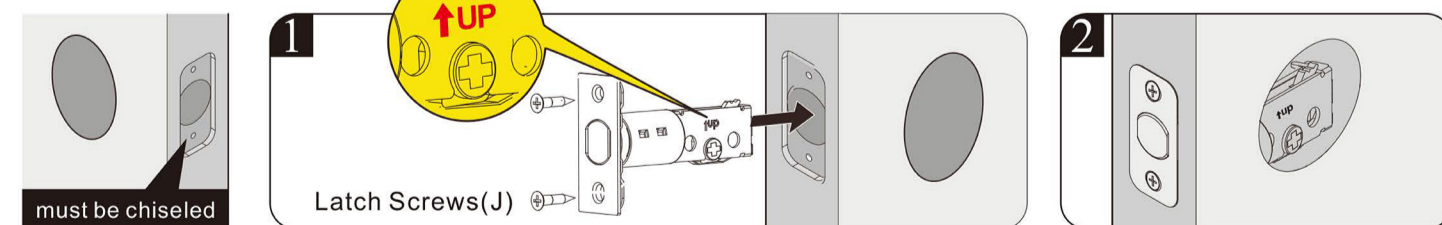

### 4. Install the exterior keypad and the interior assembly

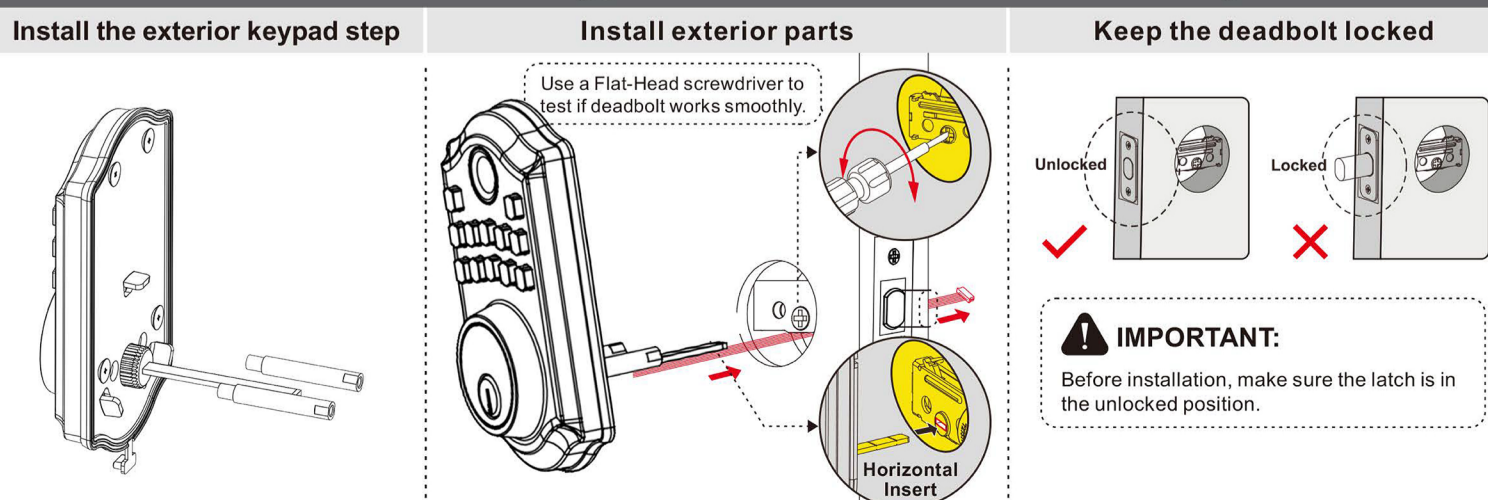

### 5. Install interior assembly

#### A. Mounting plate installation tips

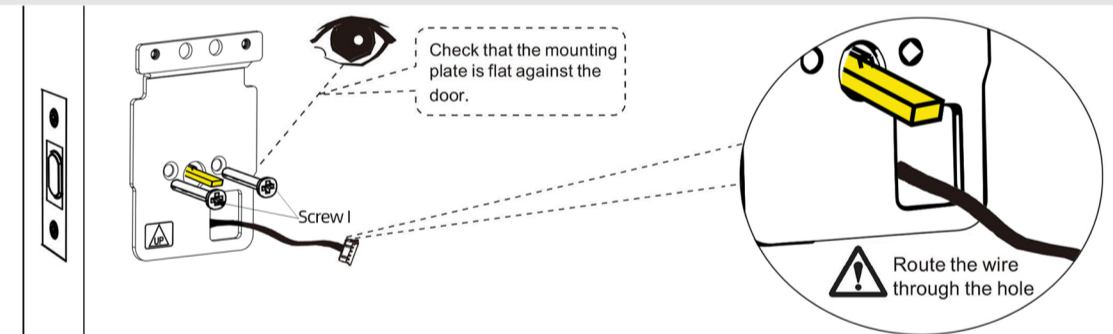

#### B. Door lock left/right direction

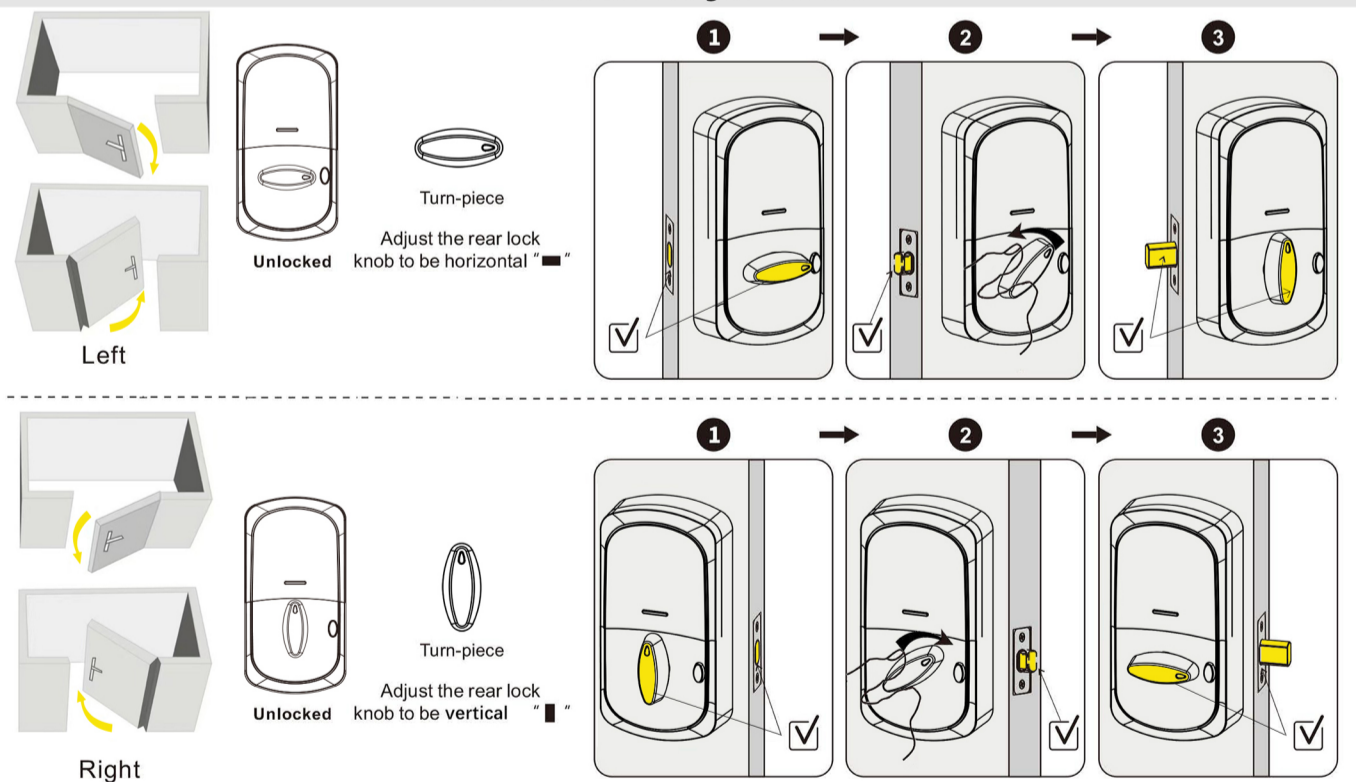

#### C. Insert IC port

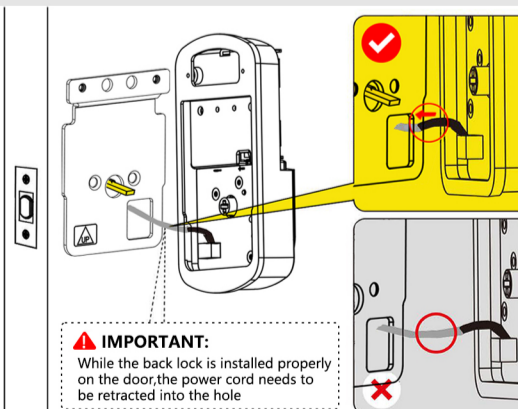

#### D. Check installation status

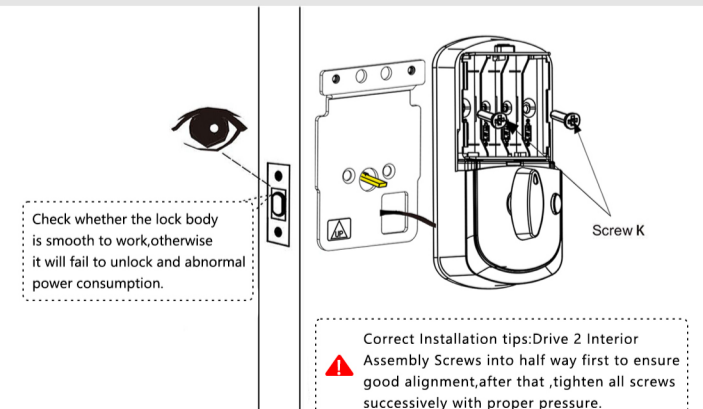

#### E. Install the batteries and cover

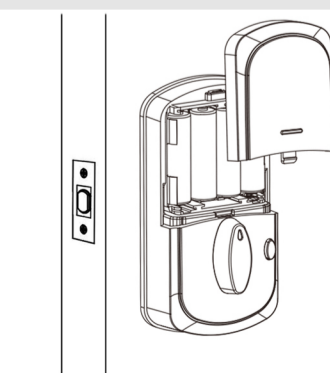

#### F. Detect door's opening direction

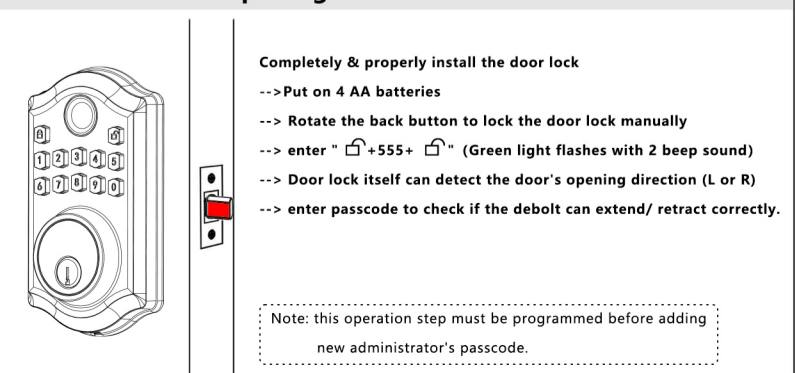

# PROGRAMMING INSTRUCTION

## 1. How to use?

### • Unlock the door from outside

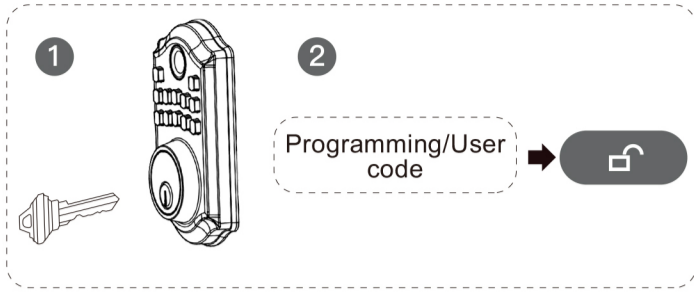

### • Indicator light signals and beep

- Green:** A correct code was entered, one long beep sound
- Blue:** Programming in progress, blue light flashing.
- Red:**
- An incorrect code was entered, three short beep sound.
  - Programming error, three short beep sound.
  - Red blinking and beep after keypad backlit off indicates critically low battery.

### • Lock the door from outside

- Auto lock mode**
- Auto lock mode is disabled by default, please refer "Quick set" turn Auto-lock on steps.
  - In auto lock mode, the bolt will extend out automatically in 5-59 seconds after unlocking.

- Manual mode**
- Press "B" button on keypad to lock.

### • Lock the door from inside

- Deadlock/Privacy Button**
- Privacy mode is disabled by default
  - All Entry Codes are disabled except the programming code.

- Manual mode**
- Rotate the turn piece to lock position.

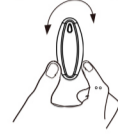

### Fingerprint register steps

- Tips:**
- Register (add) complete fingerprint area including up, down, left and right edges.
  - Move finger slightly each time when programming to improve accuracy.



## 2. Privacy mode

- Reset mode**
- Step1.** Remove the battery.
- Step2.** Long press the "Deadbolt" button, put in 4 AA batteries, the blue light flashes.
- Step3.** Enter "000 + ⏏" and the green light flashes means the reset is successful.

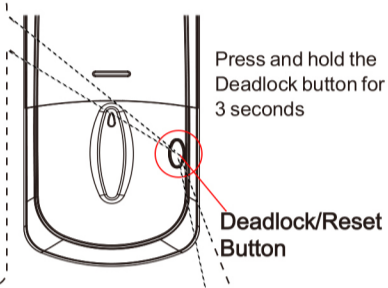

## 3. Restore factory settings

Delete all user codes, including master code:

- Use a screwdriver to remove the interior assembly.
- Press and hold the reset button for 5 seconds until "bi bi" & green light flashing. The master code will return to the manufacturer default code '123456'

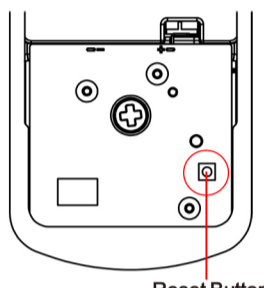

- Deadlock Button**
- After the Deadlock function is turned on, only the Programming Code can unlock, and all user code cannot unlock (use the Programming Code to unlock the lock will remove the Deadlock restriction).

- Warning!** After restore factory, Change the master passcode as soon as possible because of the master passcode can unlock the door.

## 4. Features

- Three ways to access: code, key and fingerprint.
- Low power consumption, 4 AA batteries can work for 1 year or 50,000 times
- Backlit keypad for use in low light environments.
- 1 Programming Code and 300 user codes ( Including 50 Fingerprints).
- Built-in disguise feature to protect your codes from prying eyes.
- Low battery warning indication.

## 5. Setting definitions

Settings	Default Setting	Definitions
Programming Code	123456	<ul style="list-style-type: none"> <li>It's required to change it to a code of your own before programming.</li> <li>In manually mode, Long press the "B" to lock.</li> <li>4 - 9 digits in length, Must be different from all other existed User Codes.</li> <li>If you forget the master passcode, you can reset the lock to factory settings, which restores the default programming code.</li> </ul>
Auto Lock	Disable	<ul style="list-style-type: none"> <li>This feature is optional and can be turned off.</li> <li>When enabled, the lock will automatically re-lock after 05-59 seconds.</li> <li>After a successful code entry or manual unlock with the key, the lock will automatically re-lock after each unlock to keep your home secure.</li> </ul>
Manually Lock	Hold "B"	<ul style="list-style-type: none"> <li>If auto-lock is not set on, you need to do the locking manually.</li> </ul>
Silent Mode	Disable	<ul style="list-style-type: none"> <li>The beep sounds when pressing keypad can be muted.</li> </ul>
Privacy Button	Disable	<ul style="list-style-type: none"> <li>Privacy mode is disabled by default.</li> <li>When enabled, activate Privacy mode by pressing the privacy button for 3 seconds to put the lock in do-not-disturb mode ( All Entry Codes are disabled except the programming code ).</li> </ul>
Wrong Code Entry Limit	Enabled	<ul style="list-style-type: none"> <li>Once the wrong code entry limits reach to 5 attempts, the lock will shutdown (flashing RED) for sixty (60) seconds.</li> </ul>
Peek-proof digital keypad	Enabled	<ul style="list-style-type: none"> <li>Prevent code exposure to strangers by entering random digits.</li> </ul>
User Code	Disable	<ul style="list-style-type: none"> <li>The lock comes out without any default User Codes.</li> <li>Must be different from the master code and other user codes.</li> <li>Up to 300 possible User Codes can be stored in the lock at one time.</li> </ul>

## Warranty

Lifetime Limited Mechanical and Finish Warranty and 1-Year Limited Electronics Warranty Subject to the terms and conditions of the warranty. We extend a lifetime limited mechanical and finish warranty and a one-year limited electronics warranty to the original consumer user ("Original User") of our brand product against defects in material and workmanship, as long as the original User occupies the residential premises upon which the product was originally installed.

## Warning

This manufacturer advises that no lock can provide complete security by itself, this lock maybe defeated by forcible or technical means or evaded by entry elsewhere on the property. No lock can substitute for caution, awareness of your environment, and common sense. Builder's hardware is available in multiple performance grades to suit the application. In order to enhance security and reduce risk, you should consult a qualified locksmith or other security professional.

## 6. Troubleshooting

### • Installation

Question	Suggested Action
Motor turns but will not extend or retrieve the deadbolt.	<ol style="list-style-type: none"> <li>Make sure the key is not in the lockset when installing the deadbolt. Refer to Installation Instructions.</li> <li>Make sure the backset on the latch is set to the proper length. Refer to Installation Instructions.</li> <li>Please restore to the factory setting and enter the default Master Code to set up the lock.</li> </ol>
Why does my lock only work properly when the backup key is in? Why am I unable to pull the key out in the unlocked position?	<ol style="list-style-type: none"> <li>You may need to re-install the whole lock.</li> <li>Please do not put the backup key in the lock when install.</li> <li>Please make sure when you start to install, the lock is in unlocked status.</li> <li>Please make sure the thumb turn is horizontal.</li> </ol>
Fail to programming the lock.	<ol style="list-style-type: none"> <li>Before installation, restore the lock to complete the bolt direction setting.</li> <li>Please make sure the lock is installed correctly.</li> <li>Please install fresh batteries and make sure the cable is connected correctly.</li> </ol>

### • Operation

Question	Suggested Action
The battery indicator keeps flashing.	<ol style="list-style-type: none"> <li>The batteries are getting low. Please replace with 4 AA new batteries for the best performance ( Alkaline batteries, do not use recharge batteries ).</li> </ol>
Keypad not responding.	<ol style="list-style-type: none"> <li>Make sure the batteries are installed properly.</li> <li>The batteries are getting low if the battery indicator keeps flashing.</li> <li>Please replace with four new batteries for the best performance ( Alkaline batteries, do not use recharge batteries ).</li> <li>Make sure the cable is well-connected to the port, and was not damaged during installation.</li> <li>Make sure the lock has been set up and complete the bolt direction determination.</li> </ol>
Forgot master code/Default programming code is incorrect.	<ol style="list-style-type: none"> <li>Press the reset button on the circuit board to erase all codes. Once the resetting work is complete, all passcodes will be erased and the programming code will return to the default programming code 123456.</li> </ol>
Lockset is not able to unlock/lock by keypad.	<ol style="list-style-type: none"> <li>Make sure you have entered the correct User Code.</li> <li>The battery is low if the battery indicator light keeps flashing. Please replace it with four new batteries.</li> <li>Make sure the cable is firmly connected.</li> <li>Check the cable for any damage that may have occurred during installation.</li> <li>Make sure the batteries are properly installed ( Alkaline batteries, do not recharge batteries ).</li> <li>Check the strike plate to make sure it is properly aligned and clear so the bolt can freely move in the hole.</li> </ol>
The lockset locks when I enter my code and unlocks when I press the lock button/the auto set was set to open the door.	<ol style="list-style-type: none"> <li>Make sure the bolt latch is in the unlocked position.</li> <li>Do not have any key in the cylinder during installation.</li> <li>Make sure the turn piece is inserted horizontally.</li> <li>Follow steps to reorient: Press ⏏ → 2 → ⏏ → Programming Code → ⏏ → 1(left door) or 2(right door) → ⏏</li> </ol>

## 7. Quick set

**Quick Set:** The default programming code is "123456". It's required that you change it to a code of your own before programming.

**1. Recommend you hit the small reset button on the circuit board before assembling the unit to the bracket.**

**2. Test the master code to open the lock, whether the latch will retract.**

Ⓜ If the latch retracts, program it directly from step 2.  
Ⓜ If the latch does not retract, adjust the direction by step 1.

Programming Code=PC User Code=UC

⏏ click+number to entry the programming mode.

**Add Programming Code**

⏏ + 1 + ⏏ → PC + ⏏ → New PC + ⏏

Remark: User Code should be 4-9 digits in length. And you need to enter the new password again to confirm.

**Detect Left/Right Hand Door Installation**

⏏ + 2 + ⏏ → PC + ⏏ → 1(Left) + ⏏ → 2(Right) + ⏏

Remark: Please Detect 1(Left)/2(Right) Direction before initial setup or once default settings are restored. Leave lock unlocked while programming. (Please ignore this step if the door's opening direction is correct)

**Add New User Code**

⏏ + 3 + ⏏ → PC + ⏏ → New UC + ⏏

Remark: User Code should be 4-9 digits in length. And you need to enter the new password again to confirm.

**Add New Fingerprint**

⏏ + 4 + ⏏ → PC + ⏏ → Fingerprint 5 times

Remark: After the green light flashes twice and the fingerprint is recorded successfully.

**Auto-lock Off**

⏏ + 5 + ⏏ → PC + ⏏ → Auto-lock function cancellation

Auto lock function is off by default. Adding administrator's passcode to enable auto lock on (default time delay is 10s)

**Turn Auto-lock On & Set Time Delay**

⏏ + 6 + ⏏ → PC + ⏏ → Enter new duration time + ⏏ (05-59s)

Remark: 05-59 seconds delay-time available. Press "05" to note the two-digit length.

**Add One-Time Code**

⏏ + 7 + ⏏ → PC + ⏏ → New UC + ⏏

Remark: User Code should be 4-9 digits in length. And you need to enter the new password again to confirm.

**Turn Sound On & Turn Sound Off**

⏏ + 8 + ⏏ → PC + ⏏ → 1(on) + ⏏ → 2(off) + ⏏

Remark: The beeper can be turned off.

**Delete User Code**

⏏ + 9 + ⏏ → PC + ⏏ → User Code + ⏏

Remark: The Programming code remains. Delete the specified user password.

**Delete User Fingerprint**

⏏ + 10 + ⏏ → PC + ⏏ → User Fingerprint + ⏏

Remark: The Programming code remains. Delete the specified user fingerprint.

# VEVOR<sup>®</sup>

## TOUGH TOOLS, HALF PRICE

Technical Support and E-Warranty Certificate [www.vevor.com/support](http://www.vevor.com/support)

We continue to be committed to provide you tools with competitive price. "Save Half", "Half Price" or any other similar expressions used by us only represents an estimate of savings you might benefit from buying certain tools with us compared to the major top brands and does not necessarily mean to cover all categories of tools offered by us. You are kindly reminded to verify carefully when you are placing an order with us if you are actually saving half in comparison with the top major brands.

## **FCC Information:**

**CAUTION:** Changes or modifications not expressly approved by the party responsible for compliance could void the user's authority to operate the equipment!

This device complies with Part 15 of the FCC Rules. Operation is subject to the following two conditions:

- 1) This product may cause harmful interference.
- 2) This product must accept any interference received, including interference that may cause undesired operation.

**WARNING:** Changes or modifications to this product are not expressly approved by the party. Responsible for compliance could void the user's authority to operate the product.

**Note:** This product has been tested and found to comply with the limits for a Class B digital device pursuant to Part 15 of the FCC Rules. These limits are designed to provide reasonable protection against harmful interference in a residential installation.

This product generates, uses and can radiate radio frequency energy, and if not installed and used in accordance with the instructions, may cause harmful interference to radio communications. However, there is no guarantee that interference will not occur in a particular installation. If this product does cause harmful interference to radio or television reception, which can be determined by turning the product off and on, the user is encouraged to try to correct the interference by one or more of the following measures.

- Reorient or relocate the receiving antenna.
- Increase the distance between the product and the receiver.
- Connect the product to an outlet on a circuit different from that to which the receiver is connected.

This is the original instruction, please read all manual instructions carefully before operating. VEVOR reserves a clear interpretation of our user manual. The appearance of the product shall be subject to the product you received. Please forgive us that we won't inform you again if there are any technology or software updates on our product.

### DS10

#### Left door installation template tips (Step 1)

Unlocked ✓  
Locked ✗  
Latch must be in retracted

Horizontal Insert

Do not insert the key when installing

#### Step 2

the power cord needs to be retracted into the hole

Turn-piece to be horizontal

Left door locking process

**Please identify the direction of the door before you do any programming.**  
When the latch is open (as shown in the picture): → → 555 →

(If you have modified the programming code, please enter the new programming code)

#### Step 3

Left door's turn-piece horizontal →

**Remark:** Please Detect 1(Left) / 2(Right) Direction before initial setup or once default settings are restored. Default setting is right door unlock.  
**PC=Programming Code=123456 (Default initial code)**

### DS10

#### Right door installation template tips (Step 1)

Unlocked ✓  
Locked ✗  
Latch must be in retracted

Horizontal Insert

Do not insert the key when installing

#### Step 2

the power cord needs to be retracted into the hole

Turn-piece to be vertical

Right door locking process

**Please identify the direction of the door before you do any programming.**  
When the latch is open (as shown in the picture): → → 555 →

(If you have modified the programming code, please enter the new programming code)

#### Step 3

Right door's turn-piece vertical →

**Remark:** Please Detect 1(Left) / 2(Right) Direction before initial setup or once default settings are restored. Default setting is right door unlock.  
**PC=Programming Code=123456 (Default initial code)**

170x136mm DS10卡纸