

VEVOR[®]

TOUGH TOOLS, HALF PRICE

Technical Support and E-Warranty Certificate www.vevor.com/support

FLOATING DESK USER MANUAL

MODEL:HZCD003

We continue to be committed to provide you tools with competitive price.

"Save Half", "Half Price" or any other similar expressions used by us only represents an estimate of savings you might benefit from buying certain tools with us compared to the major top brands and does not necessarily mean to cover all categories of tools offered by us. You are kindly reminded to verify carefully when you are placing an order with us if you are actually saving half in comparison with the top major brands.

VEVOR[®]

TOUGH TOOLS, HALF PRICE

FLOATING DESK

MODEL:HZCD003

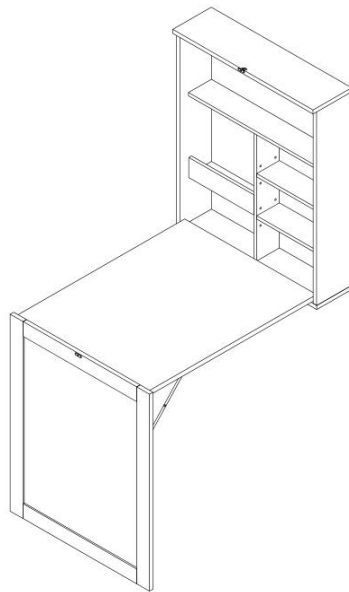

NEED HELP? CONTACT US!

Have product questions? Need technical support? Please feel free to contact us:

Technical Support and E-Warranty Certificate
www.vevor.com/support

This is the original instruction, please read all manual instructions carefully before operating. VEVOR reserves a clear interpretation of our user manual. The appearance of the product shall be subject to the product you received. Please forgive us that we won't inform you again if there are any technology or software updates on our product.

SAFETY INSTRUCTIONS

WARNING:

Read this material before using this product. Failure to do so can result in serious injury.

Assembly precautions

1. Assemble only according to these instructions. Improper assembly can create hazards.
2. Wear ANSI-approved safety goggles and heavy-duty work gloves during assembly.
3. Keep the assembly area clean and well-lit.
4. Keep bystanders out of the area during assembly.
5. Do not assemble when tired or when under the influence of alcohol, drugs or medication.
6. The product capabilities apply to properly and completely assembled products only.
7. Assemble on a flat, level, hard and smooth surface capable of safely supporting the Floating Desk.
8. For additional information regarding the parts listed in the following pages, please refer to the Assembly Diagram of this manual. Unwrap and separate all parts in a clean work area.









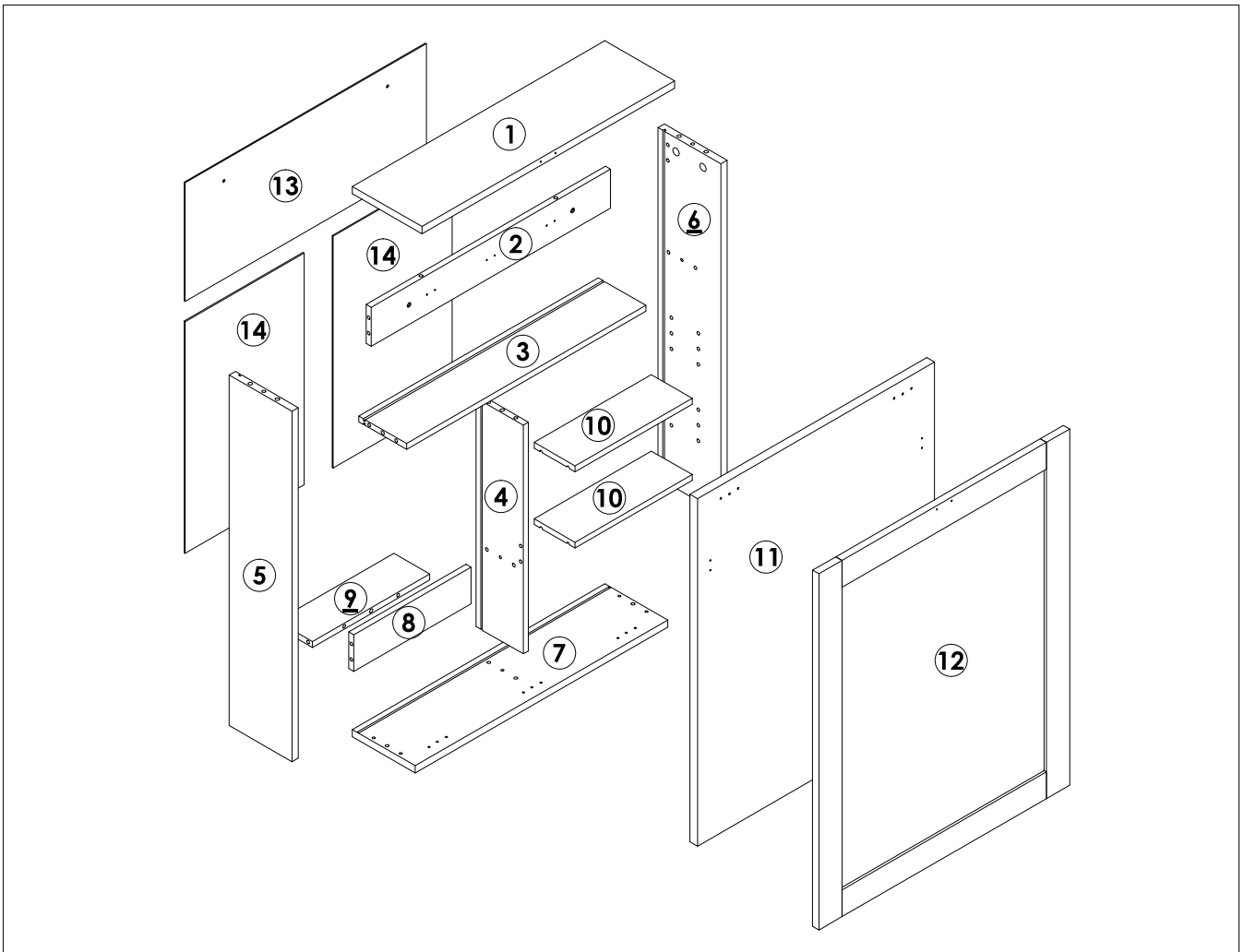

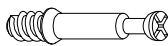

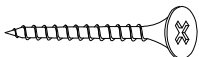
Use precautions

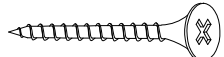
1. DO NOT SIT OR STAND ON THIS ITEM.
2. This product is not a toy. Do not allow children to play with or near this item.
3. Do not exceed weight capacities.
4. Use as intended only.
5. Inspect before every use; do not use if parts are loose or damaged.

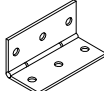
SAVE THIS MANUAL

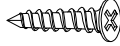
PARTS LIST

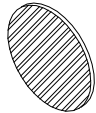
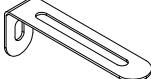
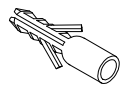
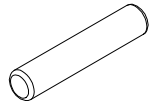

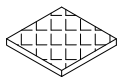
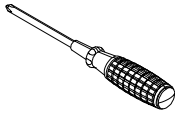
<p>A</p>  <p>M6x35mm 10+1PCS</p>	<p>B</p>  <p>Ø15x9mm 10+1PCS</p>	<p>C</p>  <p>M4x40mm 5PCS</p>	<p>D</p>  <p>Ø6x30mm 30+2PCS</p>	<p>E</p>  <p>M5x60mm 4PCS</p>
<p>F</p>  <p>2PCS</p>	<p>G</p>  <p>1PC</p>	<p>H</p>  <p>5PCS</p>	<p>I</p>  <p>3PCS</p>	<p>J</p>  <p>M3x14mm 6PCS</p>
<p>K</p>  <p>M3x12mm 42+2PCS</p>	<p>L</p>  <p>Ø20mm 7PCS</p>	<p>M</p>  <p>2PCS</p>	<p>N</p>  <p>M8x40mm 4PCS</p>	<p>O</p>  <p>M5x20mm 8+1PCS</p>
<p>P</p>  <p>M4x12mm 4PCS</p>	<p>Q</p>  <p>16x16mm 2PCS</p>	 <p>1PC</p>		

INSTRUCTIONS

STEP 1

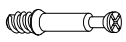
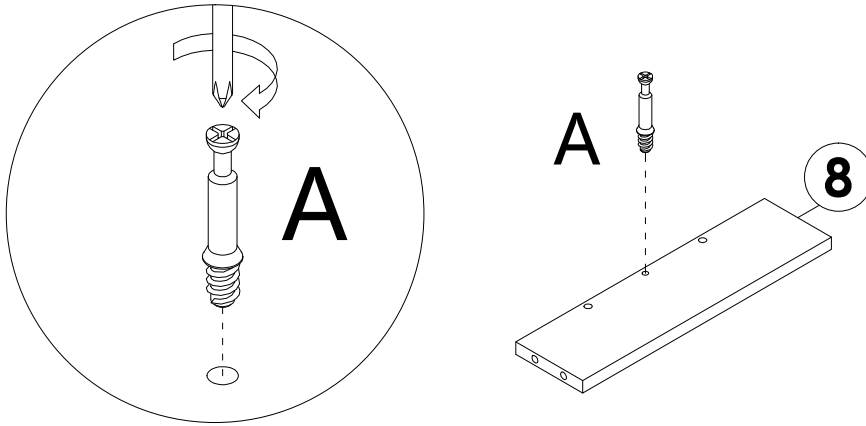

A x 1PC

STEP 2

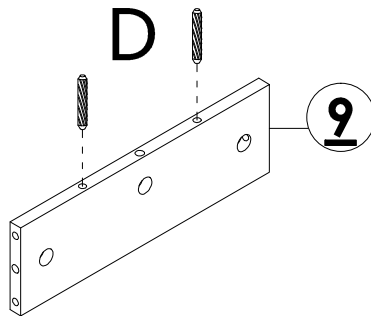

D x 2PCS

STEP 3

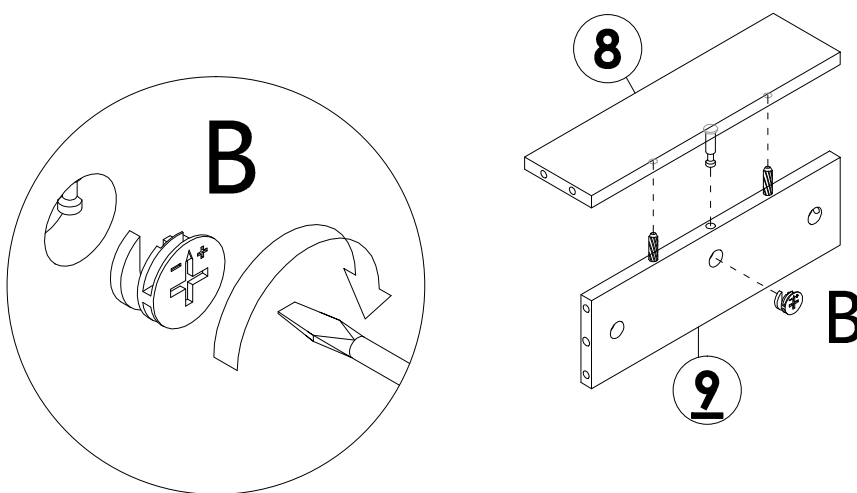

B x 1PC

STEP 4

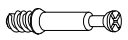
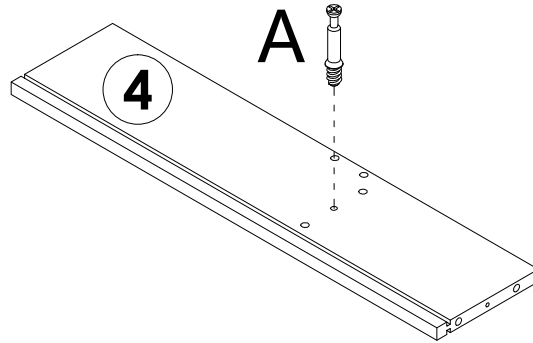
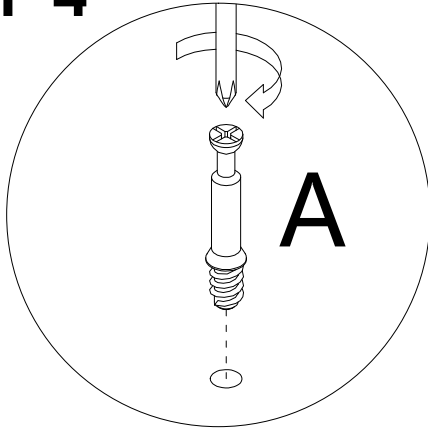

A x 1PC

STEP 5

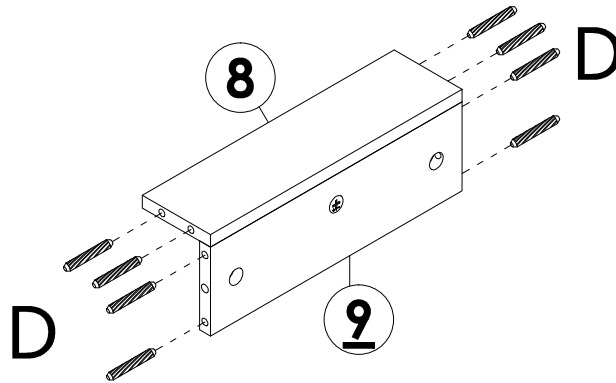

D x 8PCS

STEP 6

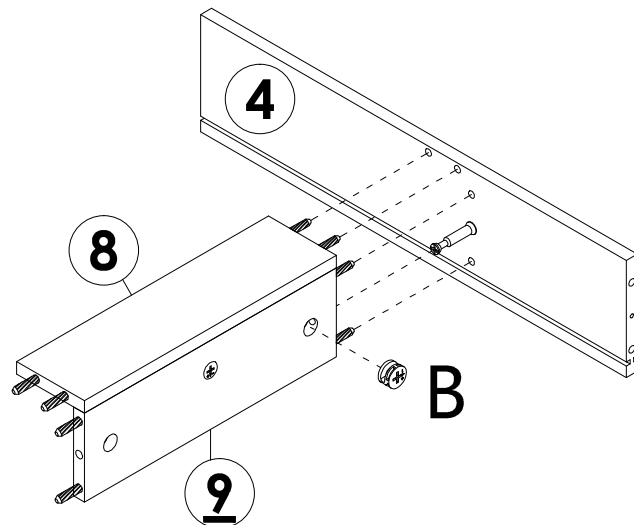
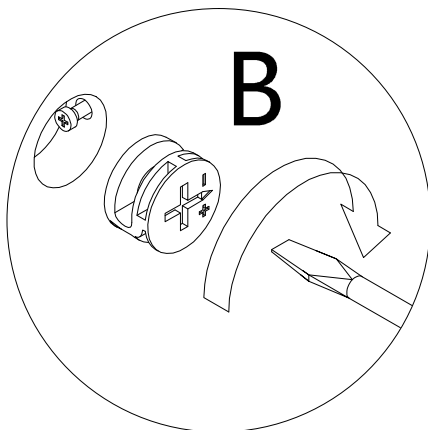

B x 1PC

STEP 7

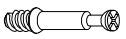
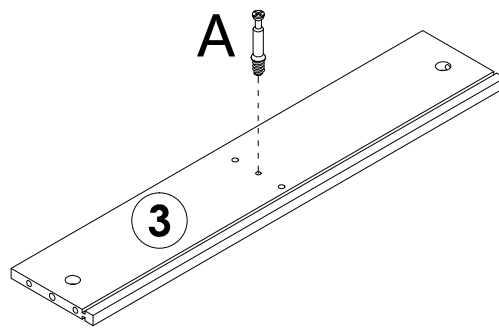
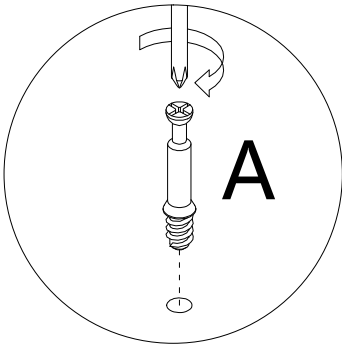

A x 1PC

STEP 8

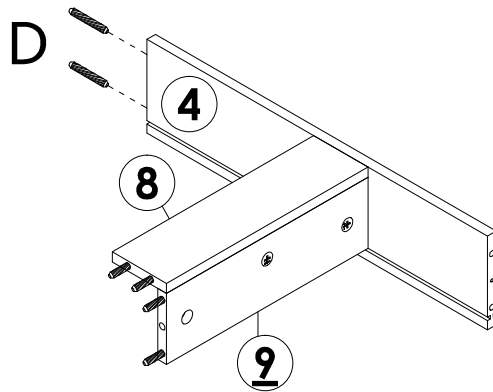

D x 2PCS

STEP 9

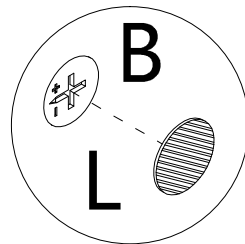
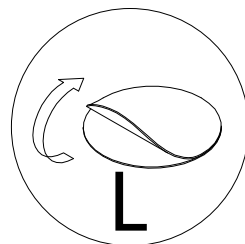
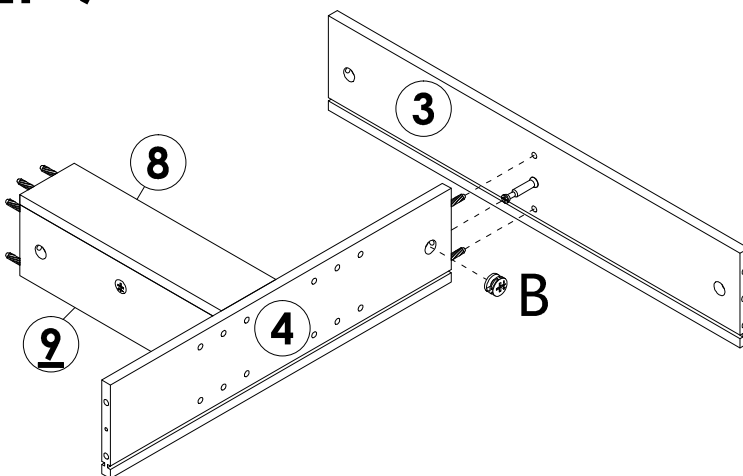



B x 1PC

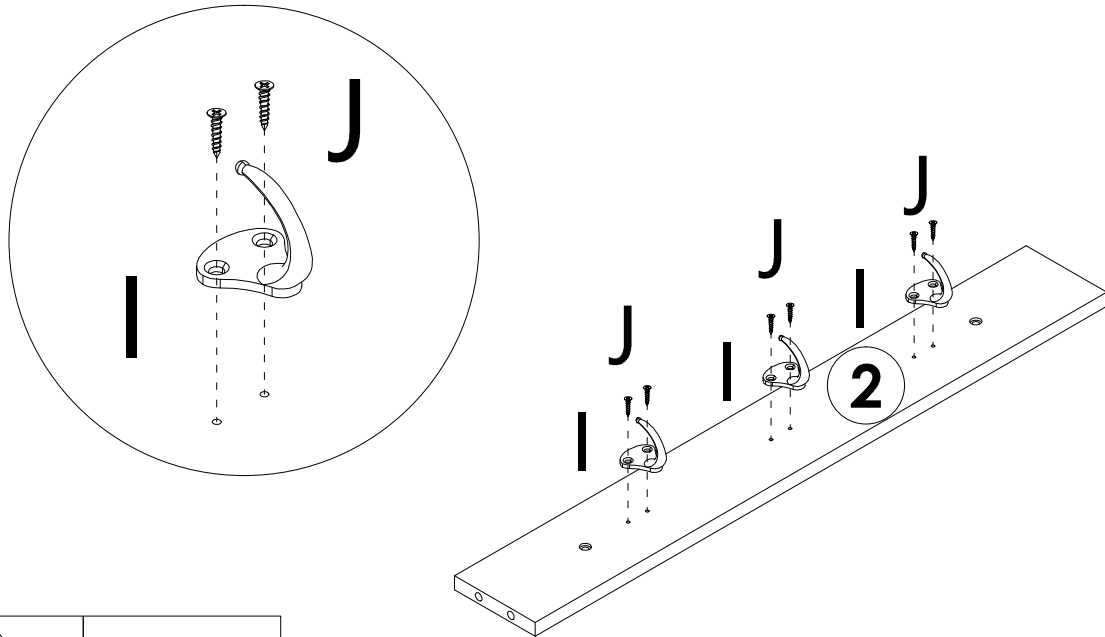

L x 1PC

STEP 10



	I x 3PCS
	J x 6PCS

STEP 11

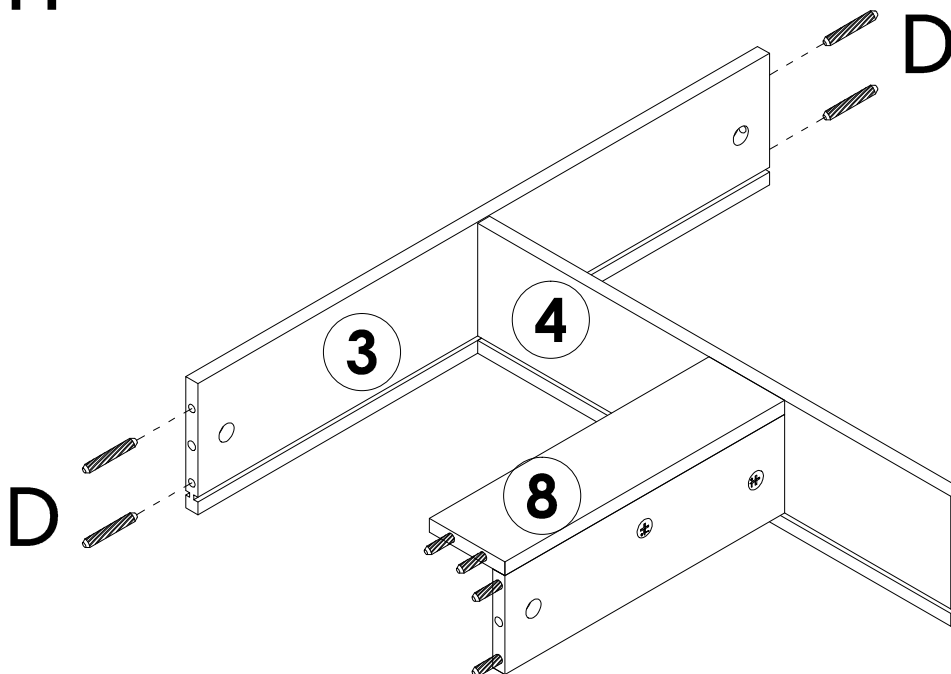

	D x 4PCS
---	----------

STEP 12

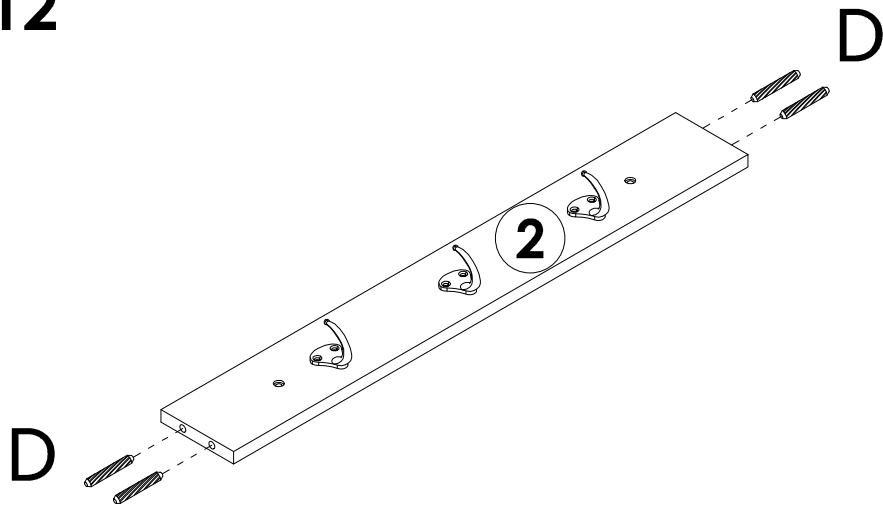

D x 4PCS

STEP 13

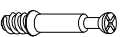
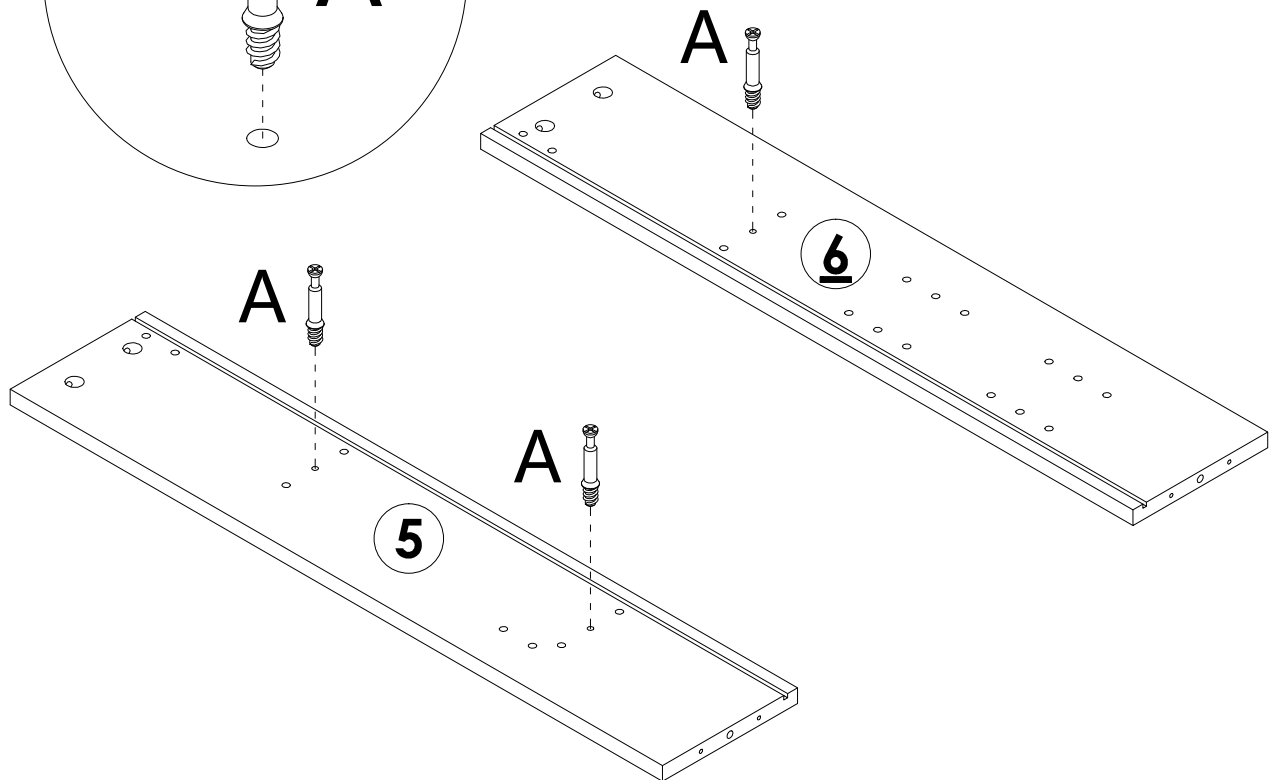
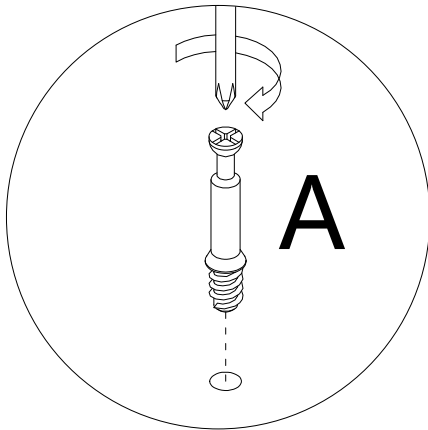

A x 3PCS

STEP 14

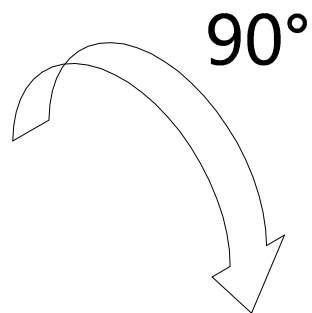
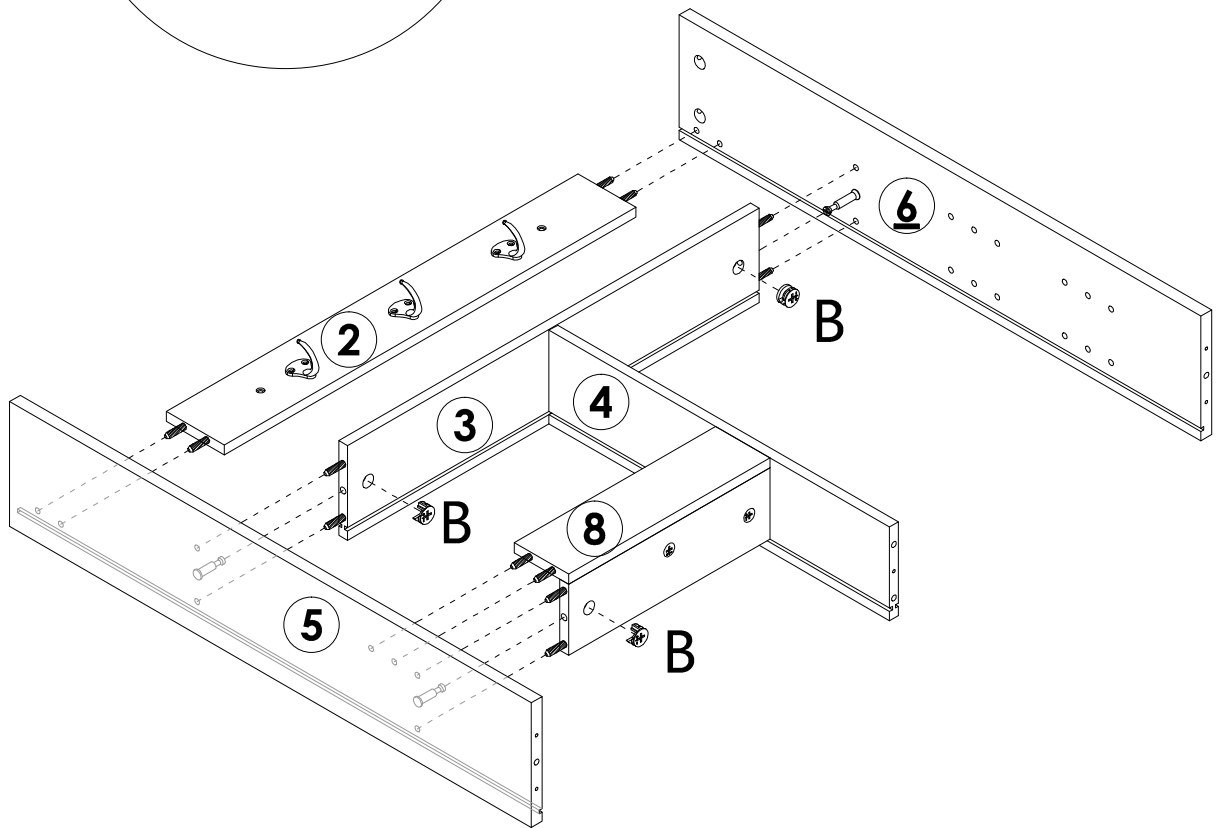
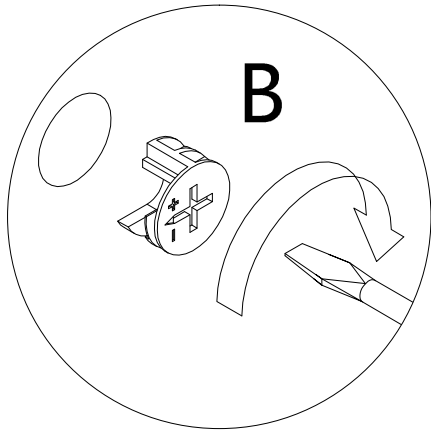

B x 3PCS

STEP 15

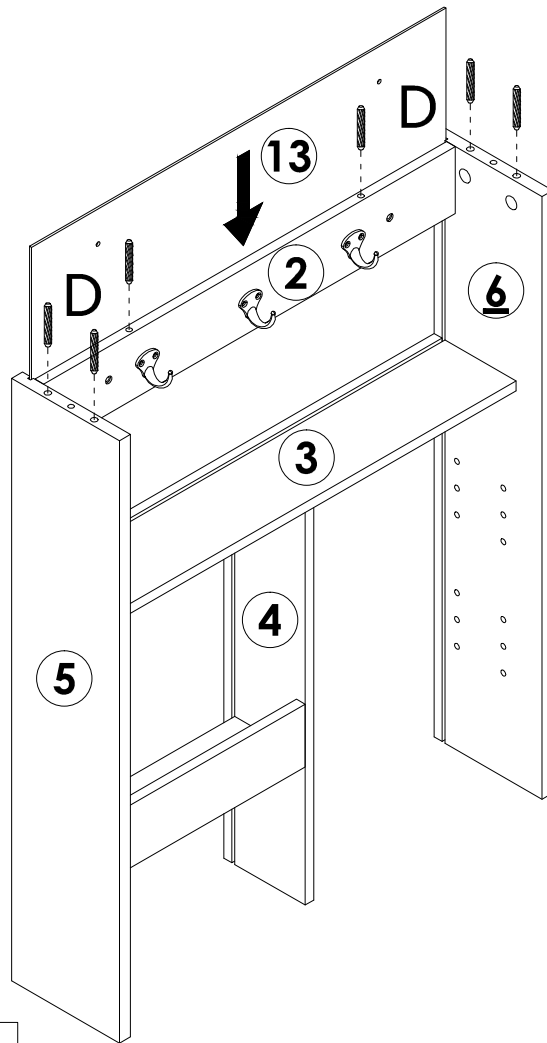

D x 6PCS

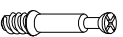
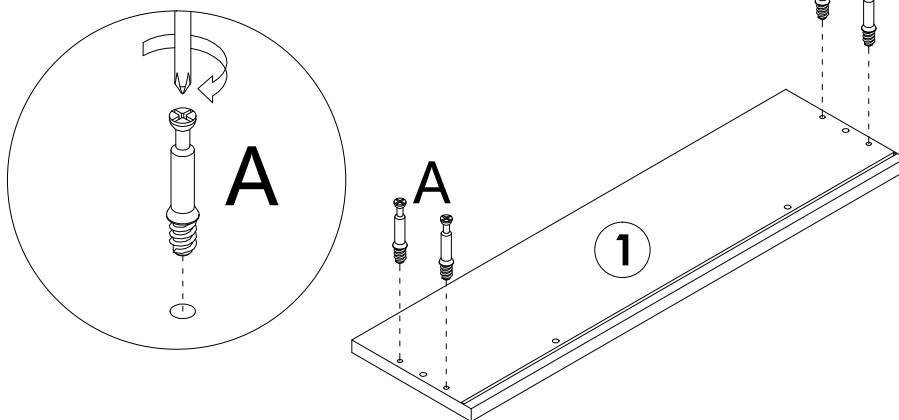

STEP 16

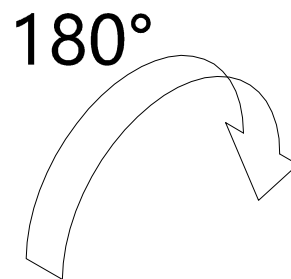
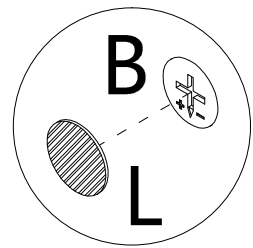
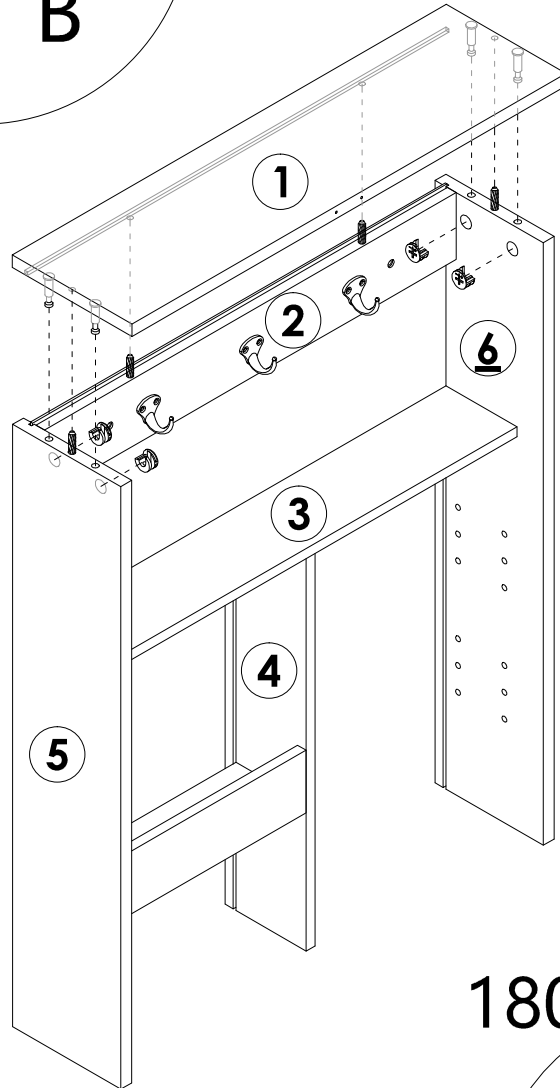
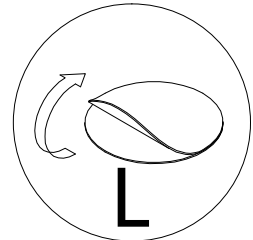
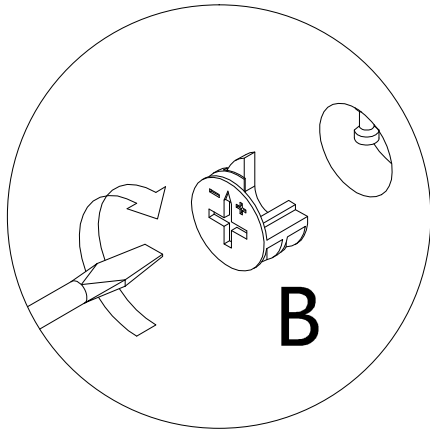

A x 4PCS

STEP 17



	B x 4PCS
	L x 4PCS

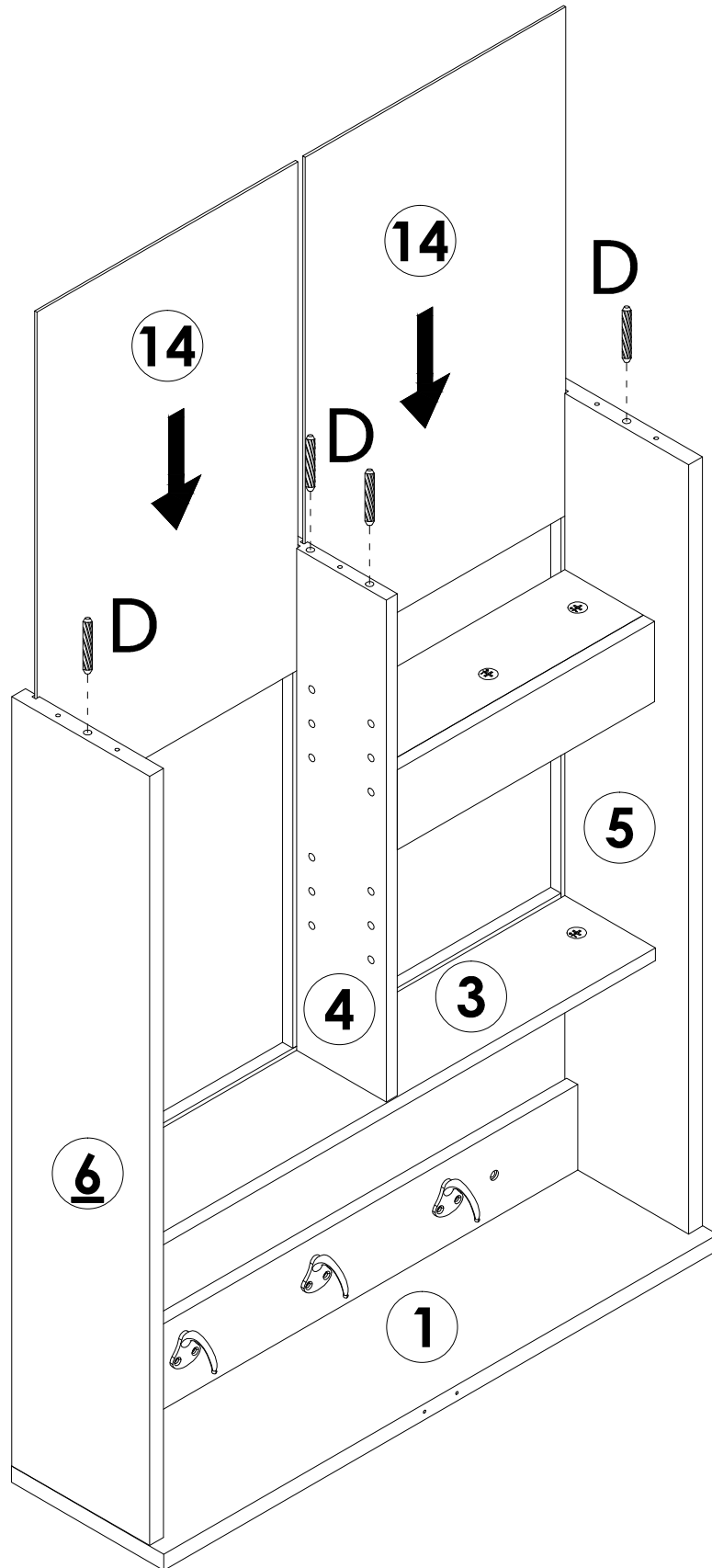

STEP 18

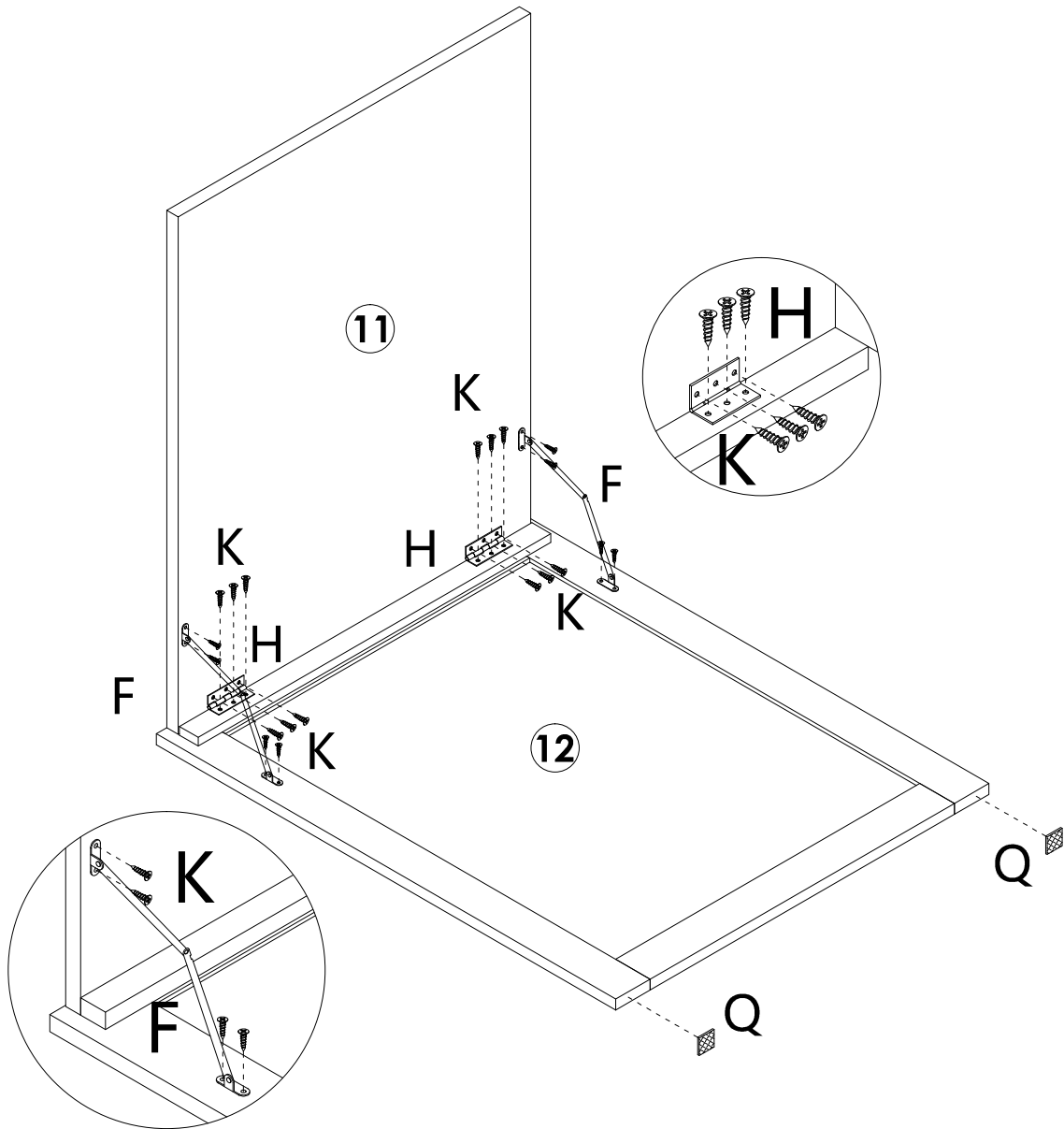

D x 4PCS

STEP 19



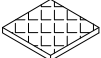

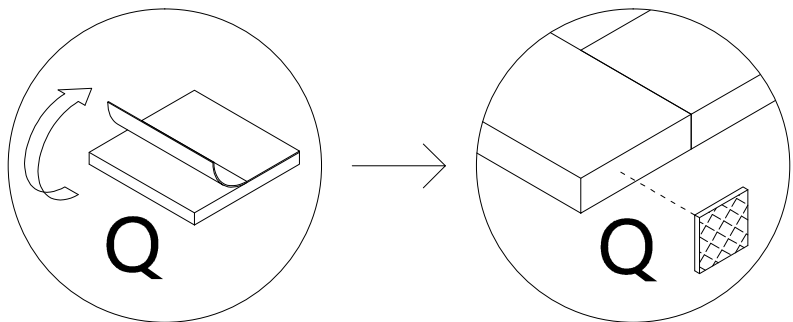
	F x 2PCS
	H x 2PCS
	K x 20PCS
	Q x 2PCS

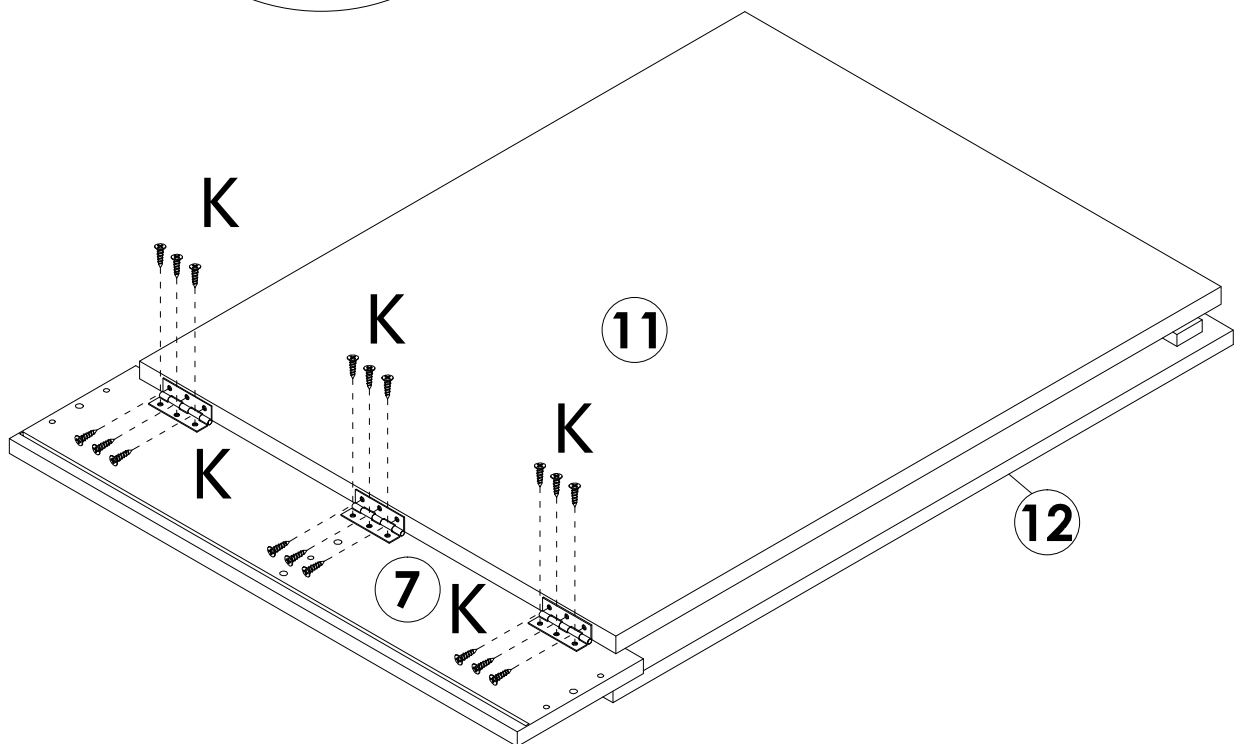
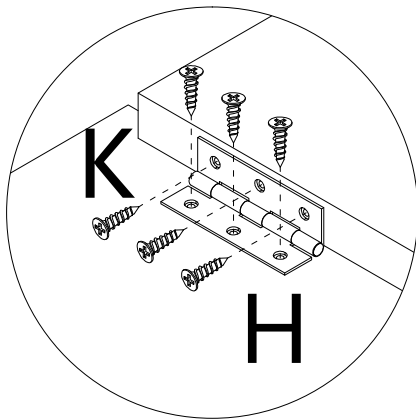

STEP 20



	H x 3PCS
	K x 18PCS

STEP 21

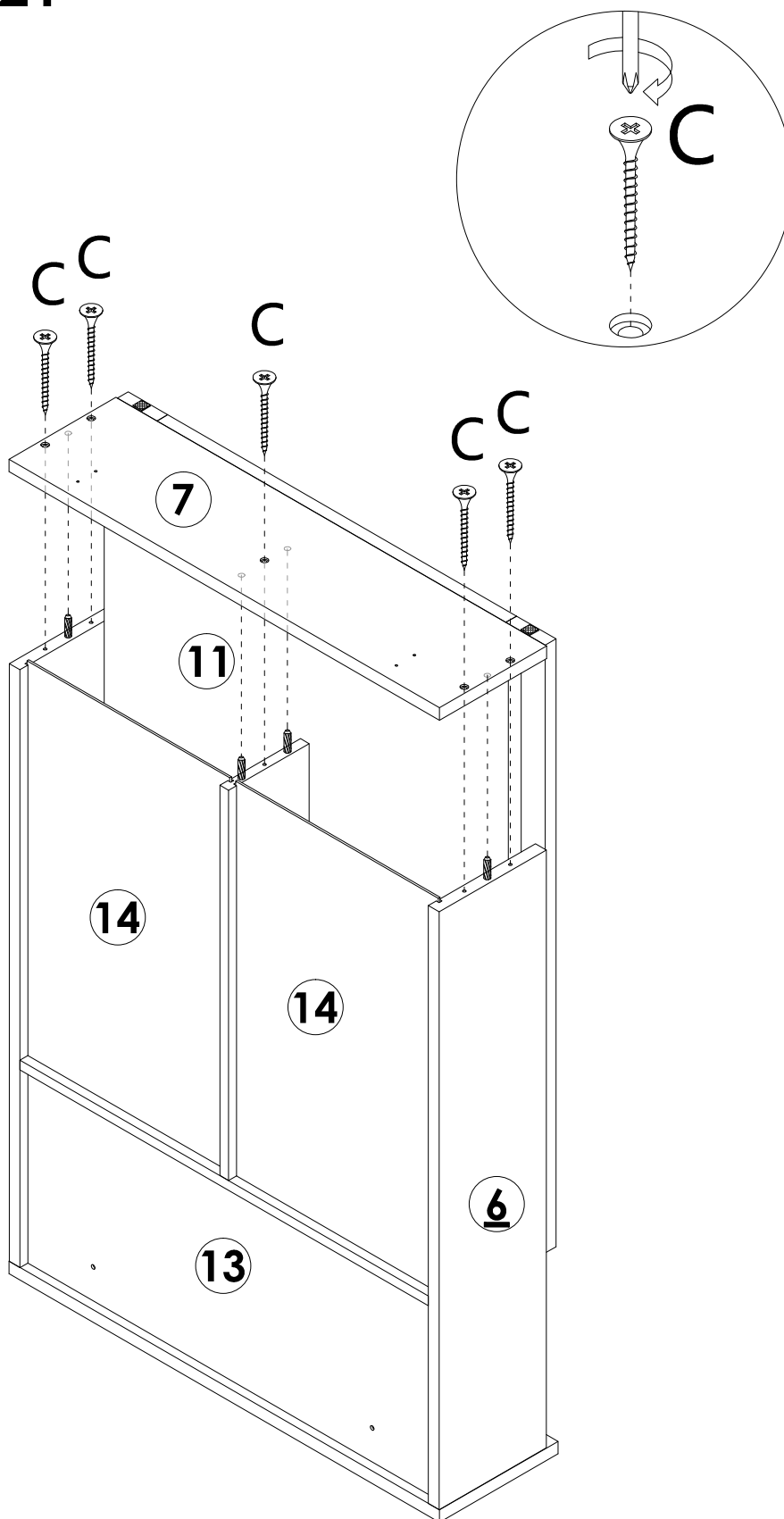

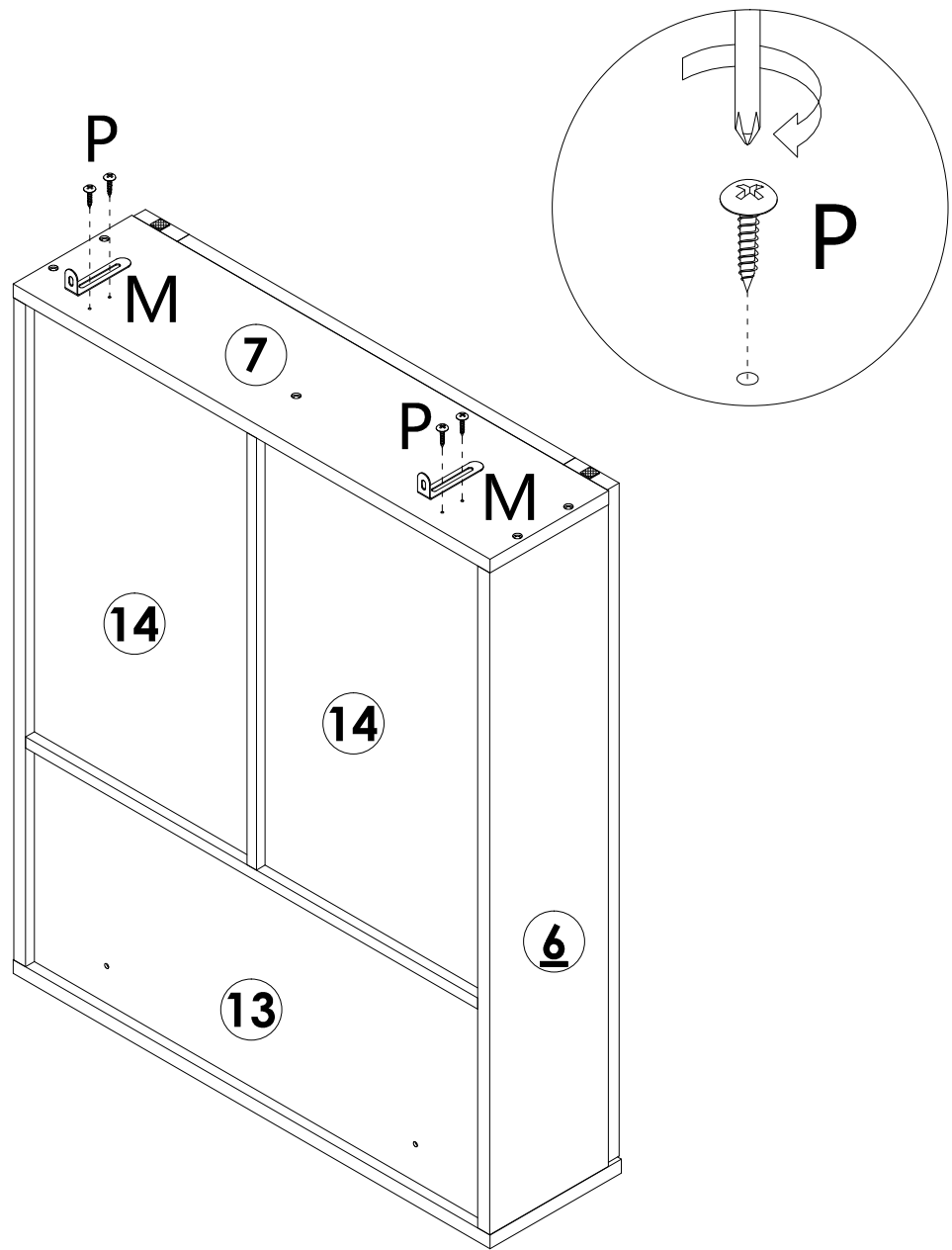

 C x 5PCS

STEP 22

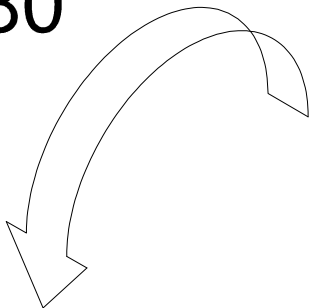

180°



	P x 4PCS
	M x 2PCS

STEP 23

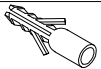
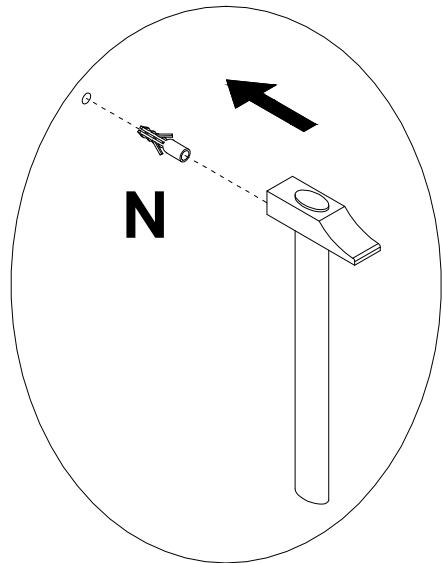
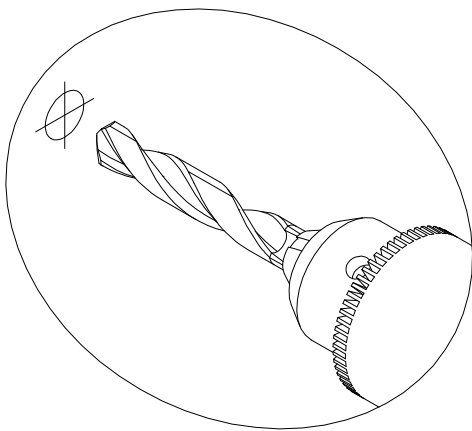
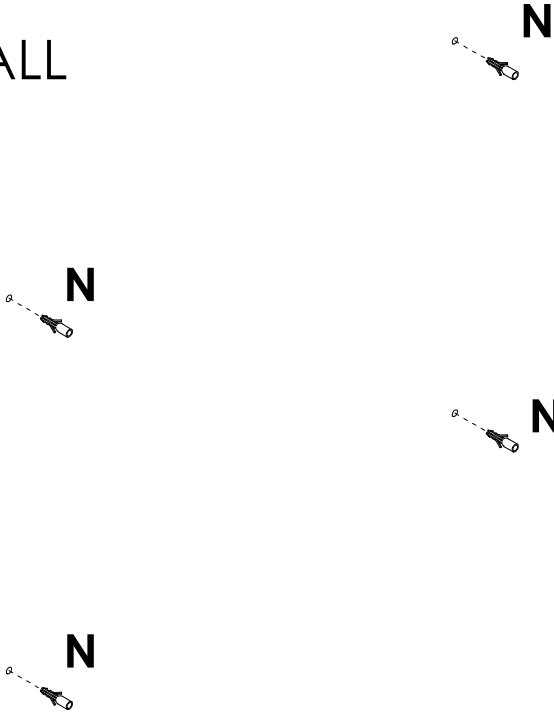

WALL

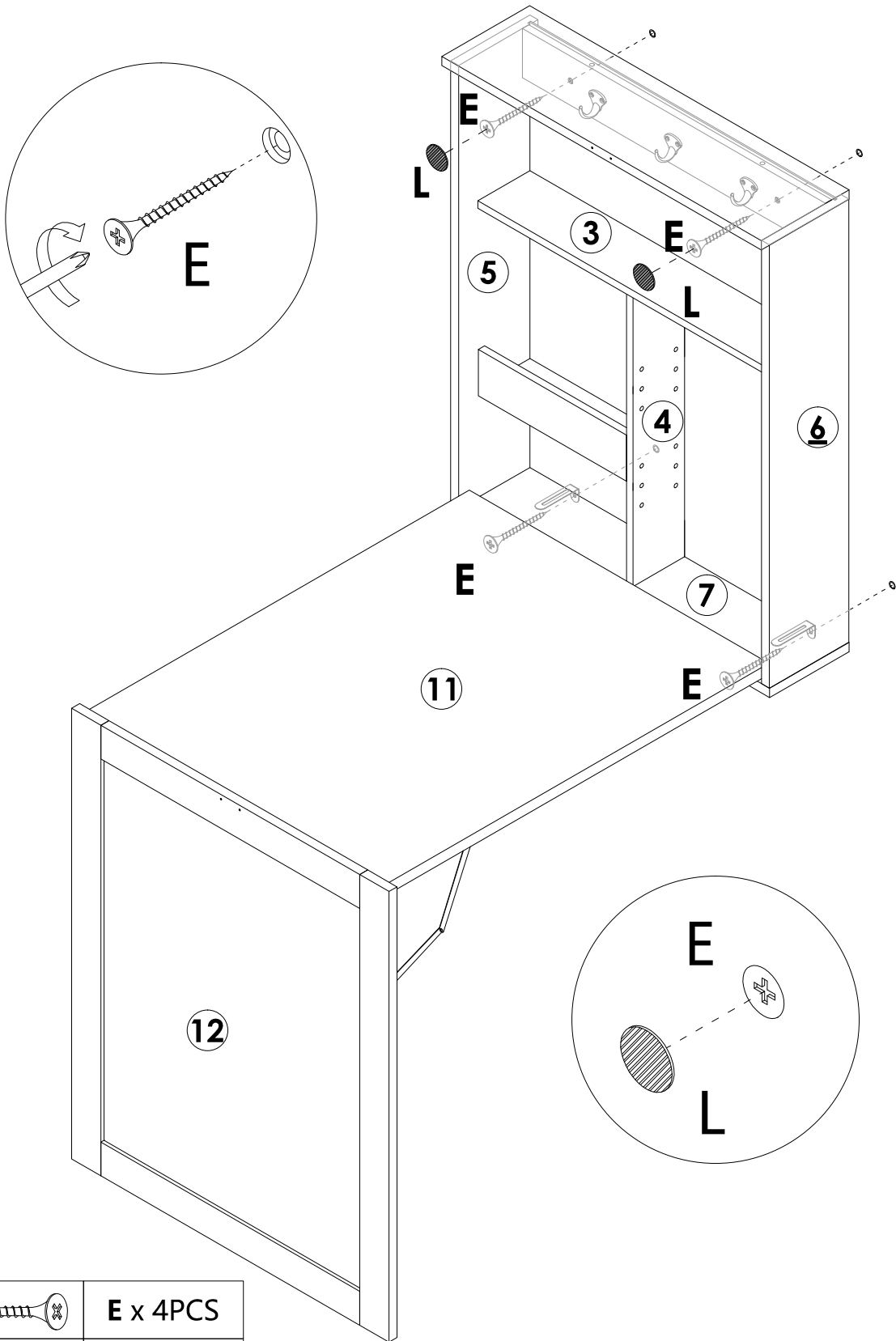

N x 4PCS

STEP 24

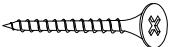

	E x 4PCS
	L x 2PCS

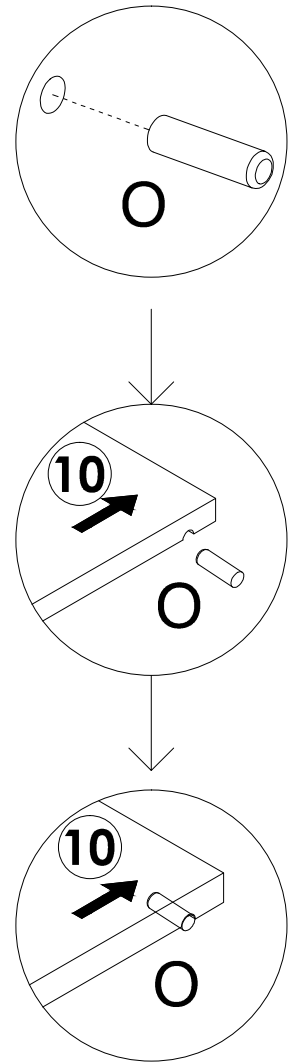
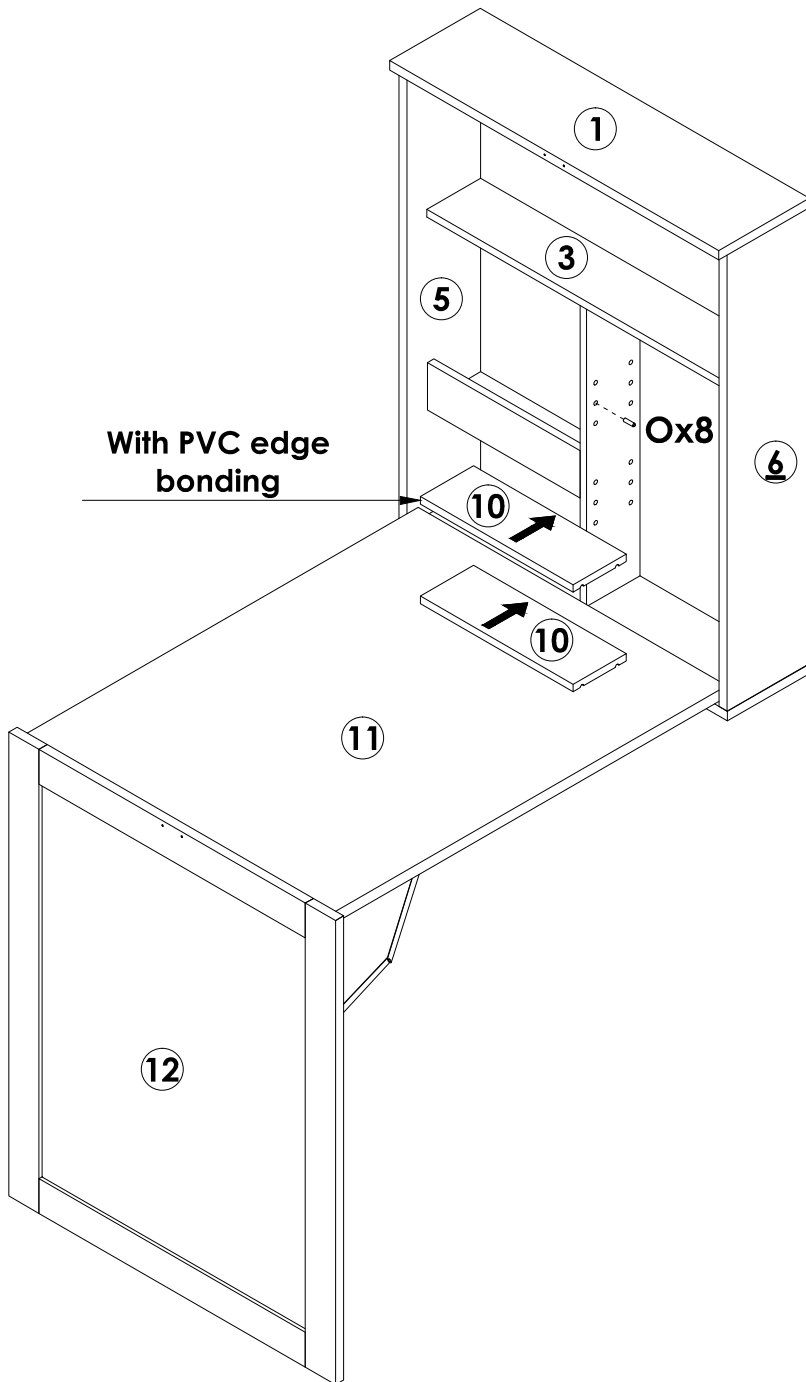

STEP 25

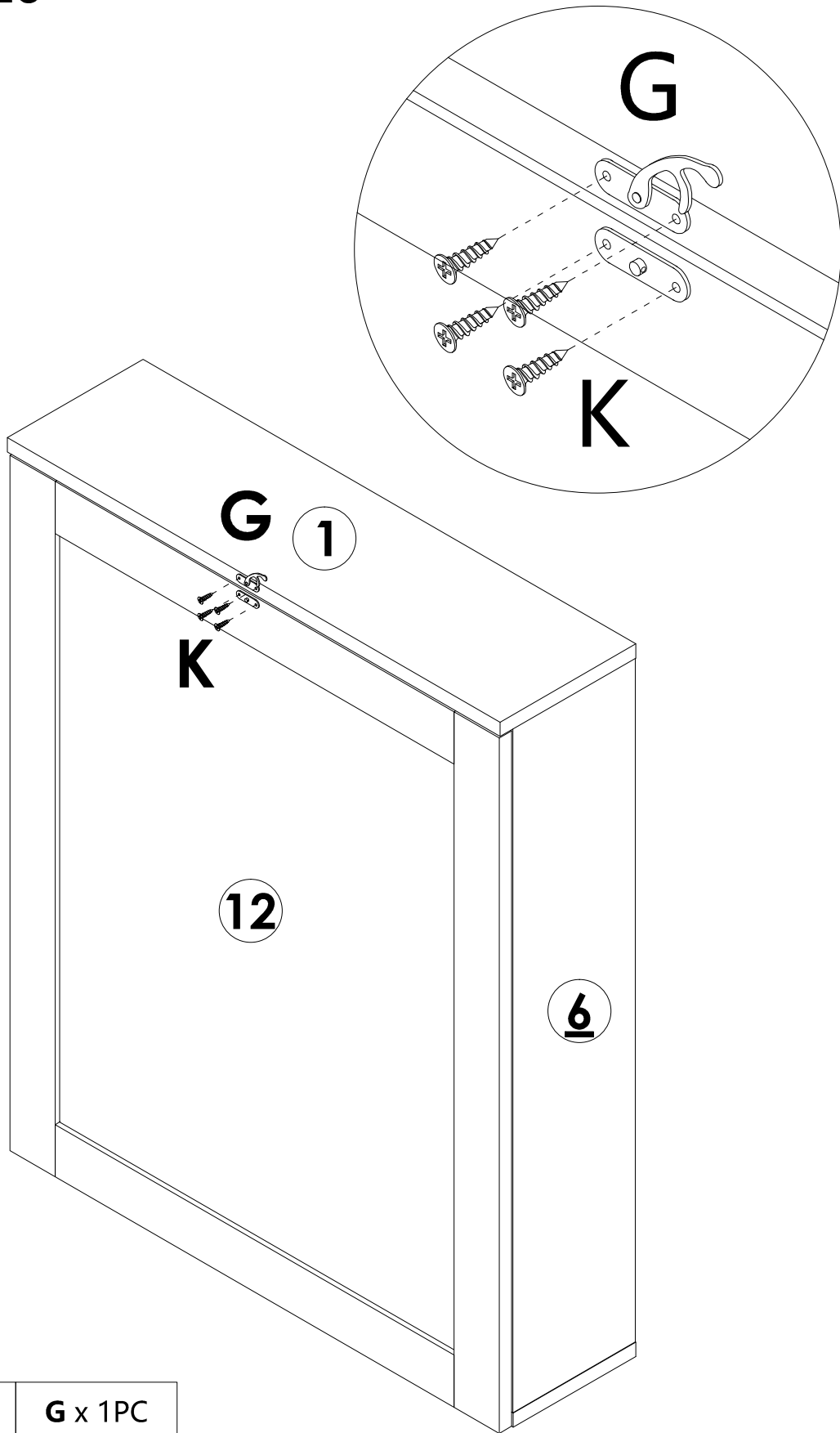

O x 8PCS

STEP 26



	G x 1PC
	K x 4PCS

COMPLETION

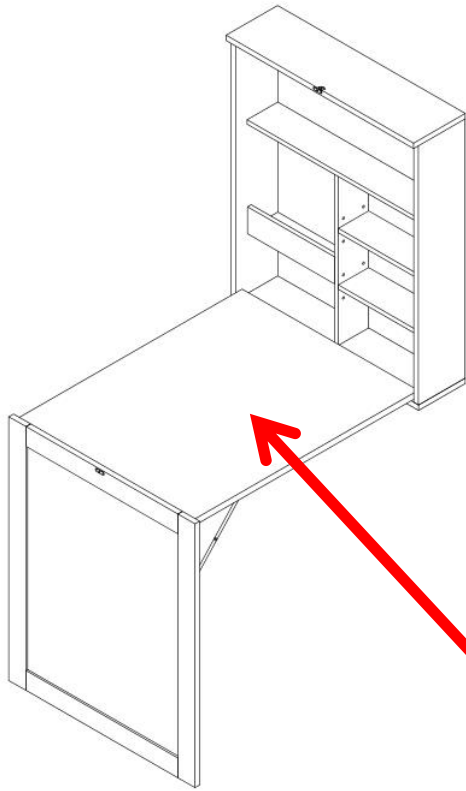

45.35kg, Even Distribution

PRODUCT PARAMETER

Model	HZCD003
Safe Loading Weight	45.35kg
Product Size	600*165*1470mm

Address: Shuangchenglu 803nong11hao1602A-1609shi, baoshanqu, shanghai 200000 CN.

Imported to AUS: SIHAO PTY LTD, 1 ROKEVA STREET EASTWOOD NSW 2122 Australia

Imported to USA: Sanven Technology Ltd. Suite 250, 9166 Anaheim Place, Rancho Cucamonga, CA 91730

EC	REP
-----------	------------

E-CrossStu GmbH.
Mainzer Landstr.69, 60329 Frankfurt am Main.

UK	REP
-----------	------------

YH CONSULTING LIMITED.
C/O YH Consulting Limited Office 147, Centurion House, London Road, Staines-upon-Thames, Surrey, TW18 4AX

VEVOR[®]

TOUGH TOOLS, HALF PRICE

Technical Support and E-Warranty Certificate

www.vevor.com/support

VEVOR®

TOUGH TOOLS, HALF PRICE

Assistance technique et certificat de garantie électronique www.vevor.com/support

BUREAU FLOTTANT

MANUEL D'UTILISATION

MODÈLE : HZCD003

Nous continuons à nous engager à vous fournir des outils à des prix compétitifs.

« Économisez la moitié », « Moitié prix » ou toute autre expression similaire utilisée par nous ne représente qu'une estimation des économies que vous pourriez réaliser en achetant certains outils chez nous par rapport aux grandes marques et ne couvre pas nécessairement toutes les catégories d'outils que nous proposons. Nous vous rappelons de bien vouloir vérifier soigneusement lorsque vous passez une commande chez nous si vous économisez réellement la moitié par rapport aux grandes marques.

VEVOR[®]
TOUGH TOOLS, HALF PRICE

BUREAU FLOTTANT

MODÈLE : HZCD003



BESOIN D'AIDE? CONTACTEZ-NOUS!

Vous avez des questions sur nos produits ? Vous avez besoin d'assistance technique ? N'hésitez pas à nous contacter :

Assistance technique et certificat de garantie
électronique www.vevor.com/support

Il s'agit de la notice d'utilisation d'origine. Veuillez lire attentivement toutes les instructions du manuel avant de l'utiliser. VEVOR se réserve le droit d'interpréter clairement notre manuel d'utilisation. L'apparence du produit dépend du produit que vous avez reçu. Veuillez nous excuser, nous ne vous informerons plus en cas de mise à jour technologique ou logicielle de notre produit.

CONSIGNES DE SÉCURITÉ

AVERTISSEMENT:

Lisez ce document avant d'utiliser ce produit. Le non-respect de cette consigne peut entraîner des blessures graves.

Précautions de montage

1. Assemblez uniquement selon ces instructions. Un assemblage incorrect peut créer des dangers.
2. Portez des lunettes de sécurité homologuées ANSI et des gants de travail robustes pendant le montage.
3. Gardez la zone de montage propre et bien éclairée.
4. Gardez les spectateurs hors de la zone pendant le montage.
5. Ne montez pas lorsque vous êtes fatigué ou sous l'influence de l'alcool, de drogues ou de médicaments.
6. Les capacités du produit s'appliquent aux produits correctement et complètement assemblés.
produits uniquement.
7. Assemblez sur une surface plane, de niveau, dure et lisse capable de supporter en toute sécurité soutenir le Floating Desk.
8. Pour plus d'informations sur les pièces répertoriées ci-dessous pages, veuillez vous référer au schéma d'assemblage de ce manuel. Déballer et séparer toutes les pièces dans une zone de travail propre.









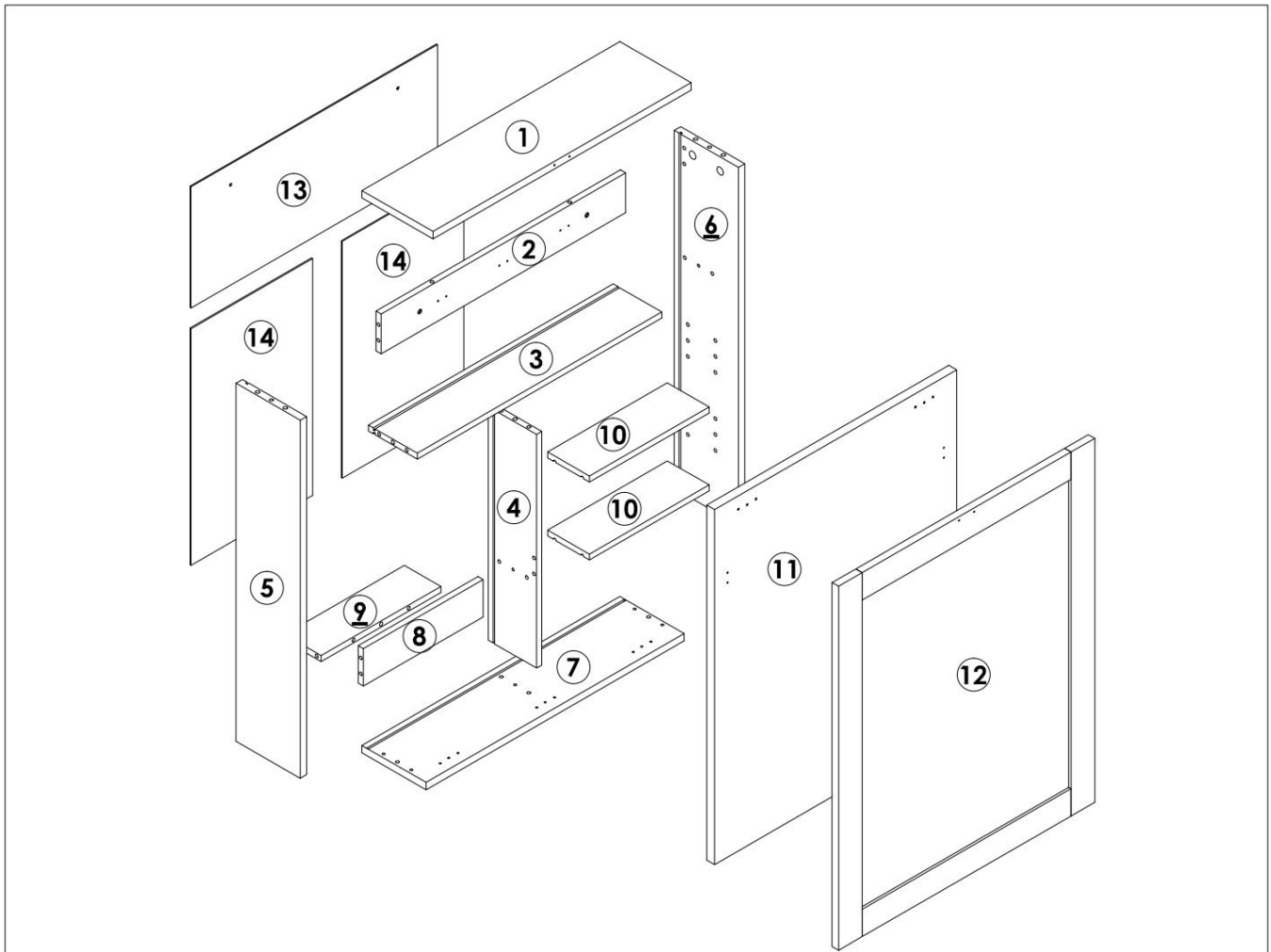

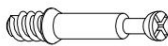



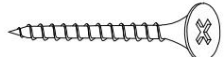
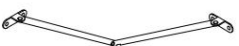

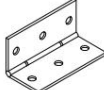
Précautions d'emploi

1. NE VOUS ASSIEZ PAS ET NE VOUS TENEZ PAS DEBOUT SUR CET ARTICLE.
2. Ce produit n'est pas un jouet. Ne laissez pas les enfants jouer avec ou à proximité de ce produit.
article.
3. Ne pas dépasser les capacités de poids.
4. Utiliser uniquement comme prévu.
5. Inspectez avant chaque utilisation ; ne pas utiliser si des pièces sont desserrées ou endommagées.

CONSERVER CE MANUEL

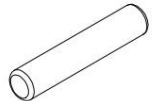
LISTE DES PIÈCES

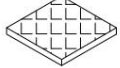

<p>A</p>  <p>M6x35mm 10+1PCS</p>	<p>B</p>  <p>Ø15x9mm 10+1PCS</p>	<p>C</p>  <p>M4x40mm 5PCS</p>	<p>D</p>  <p>Ø6x30mm 30+2PCS</p>	<p>E</p>  <p>M5x60mm 4PCS</p>
<p>F</p>  <p>2PCS</p>	<p>G</p>  <p>1PC</p>	<p>H</p>  <p>5PCS</p>	<p>I</p>  <p>3PCS</p>	<p>J</p>  <p>M3x14mm 6PCS</p>
<p>K</p>  <p>M3x12mm 42+2PCS</p>	<p>L</p>  <p>Ø20mm 7PCS</p>	<p>M</p>  <p>2PCS</p>	<p>N</p>  <p>M8x40mm 4PCS</p>	<p>O</p>  <p>M5x20mm 8+1PCS</p>
<p>P</p>  <p>M4x12mm 4PCS</p>	<p>Q</p>  <p>16x16mm 2PCS</p>	<p>R</p>  <p>1PC</p>		

INSTRUCTIONS

STEP 1

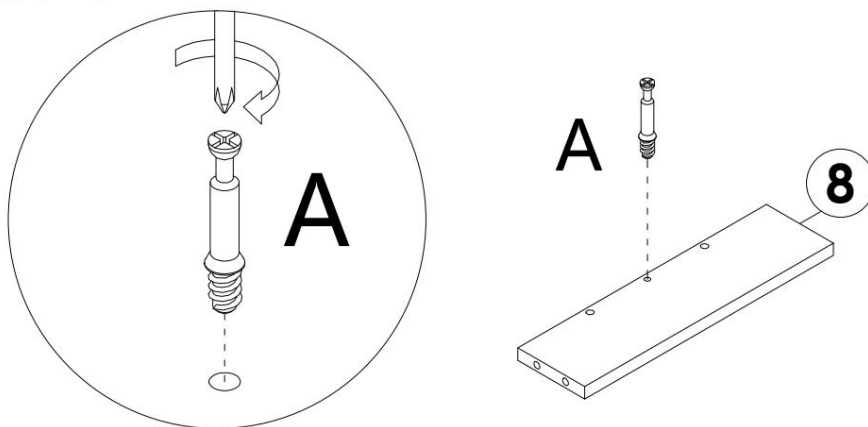

A x 1PC

STEP 2

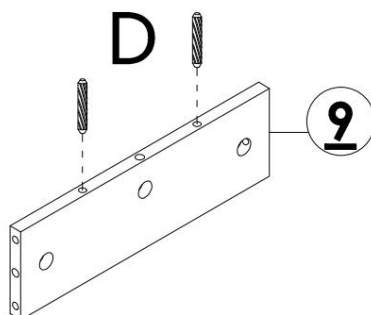

D x 2PCS

STEP 3

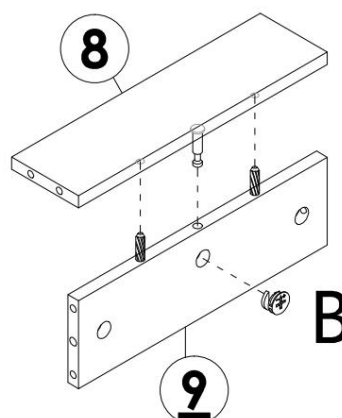
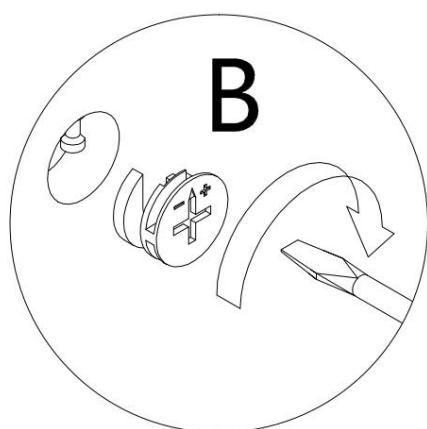

B x 1PC

STEP 4

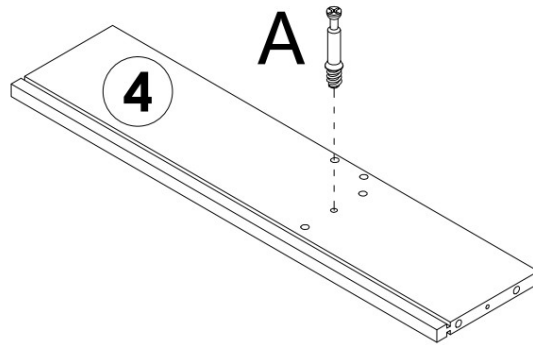
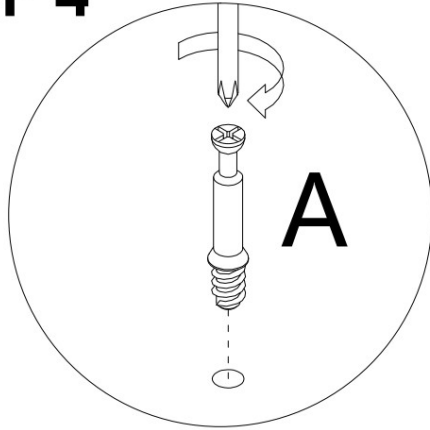

A x 1PC

STEP 5

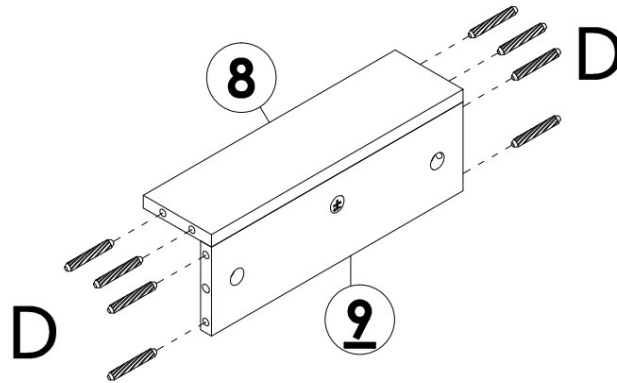

D x 8PCS

STEP 6

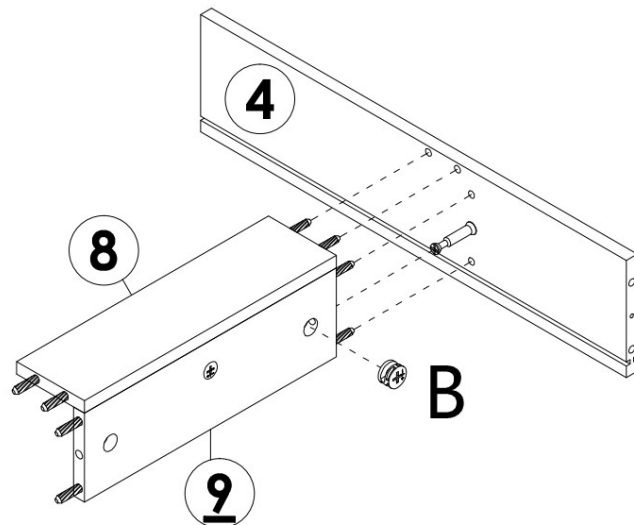
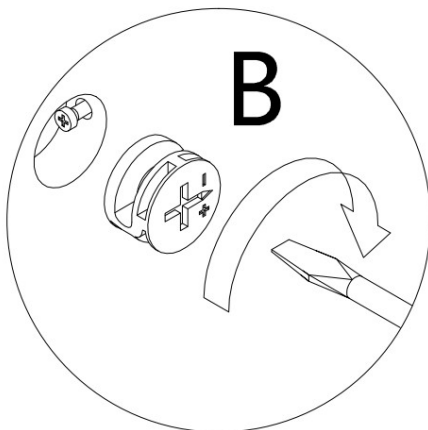

B x 1PC

STEP 7

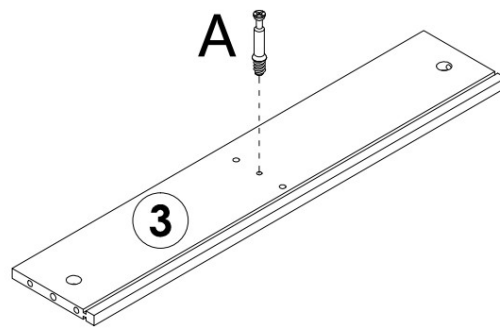
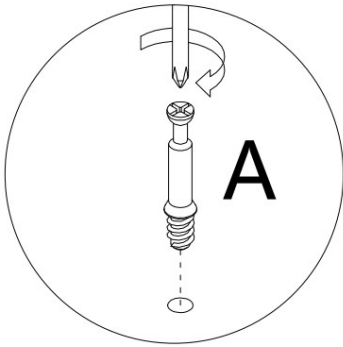

A x 1PC

STEP 8

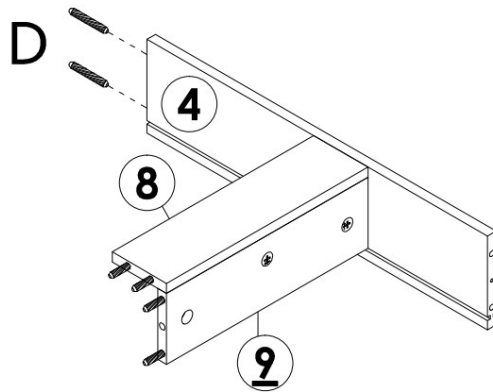

D x 2PCS

STEP 9

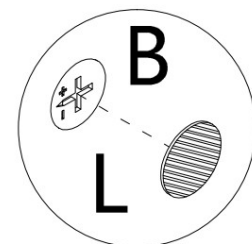
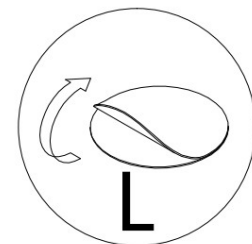
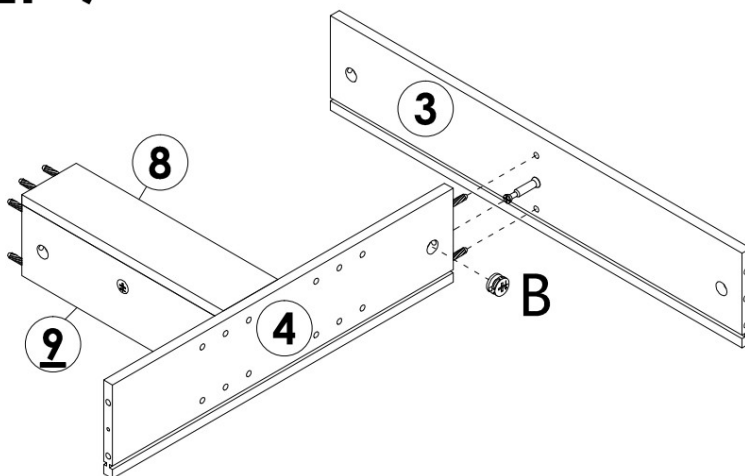



B x 1PC

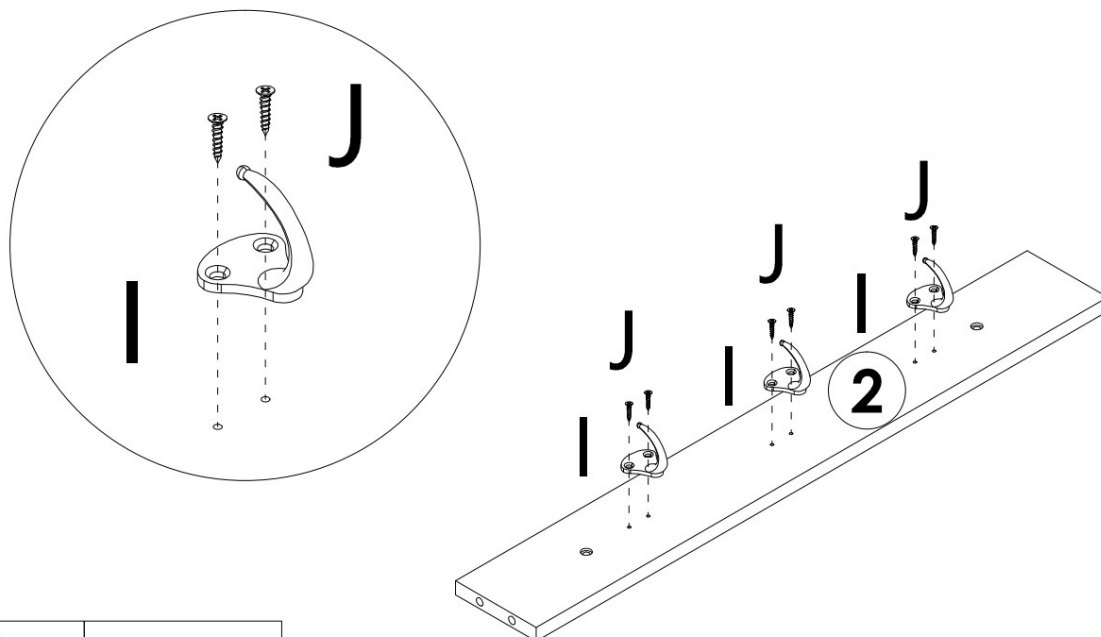

L x 1PC

STEP 10

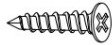

	I x 3PCS
	J x 6PCS

STEP 11

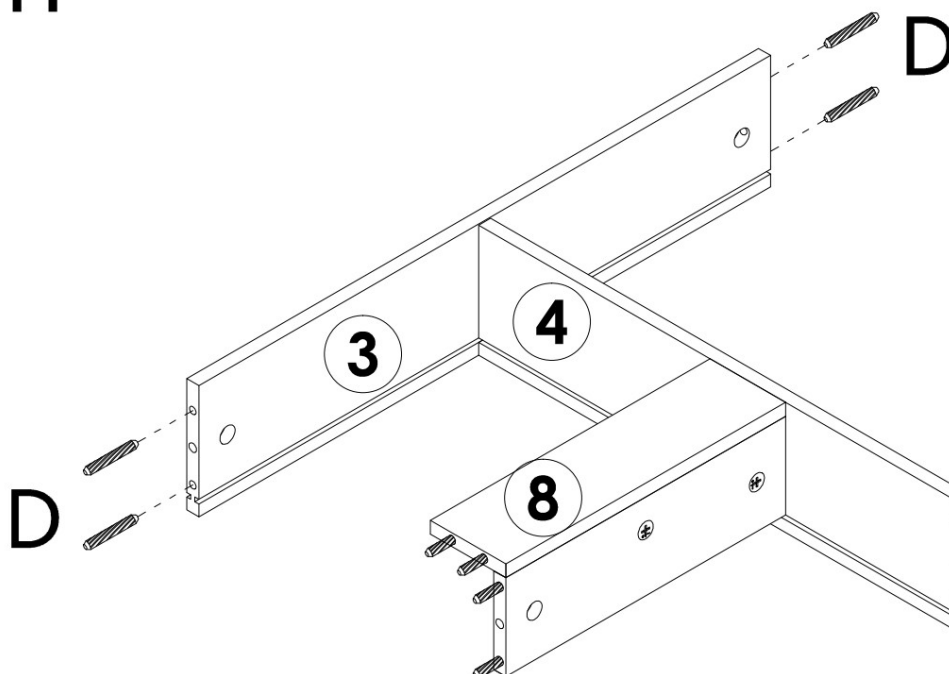

	D x 4PCS
---	----------

STEP 12

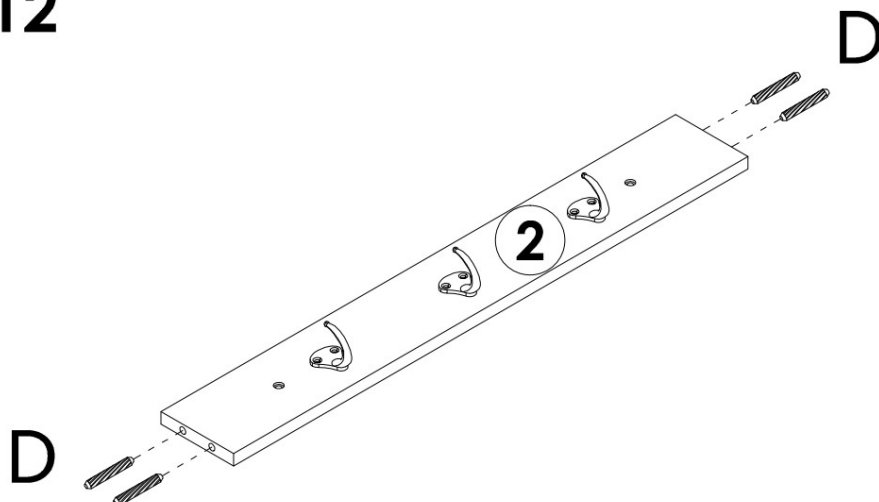

D x 4PCS

STEP 13

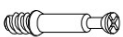
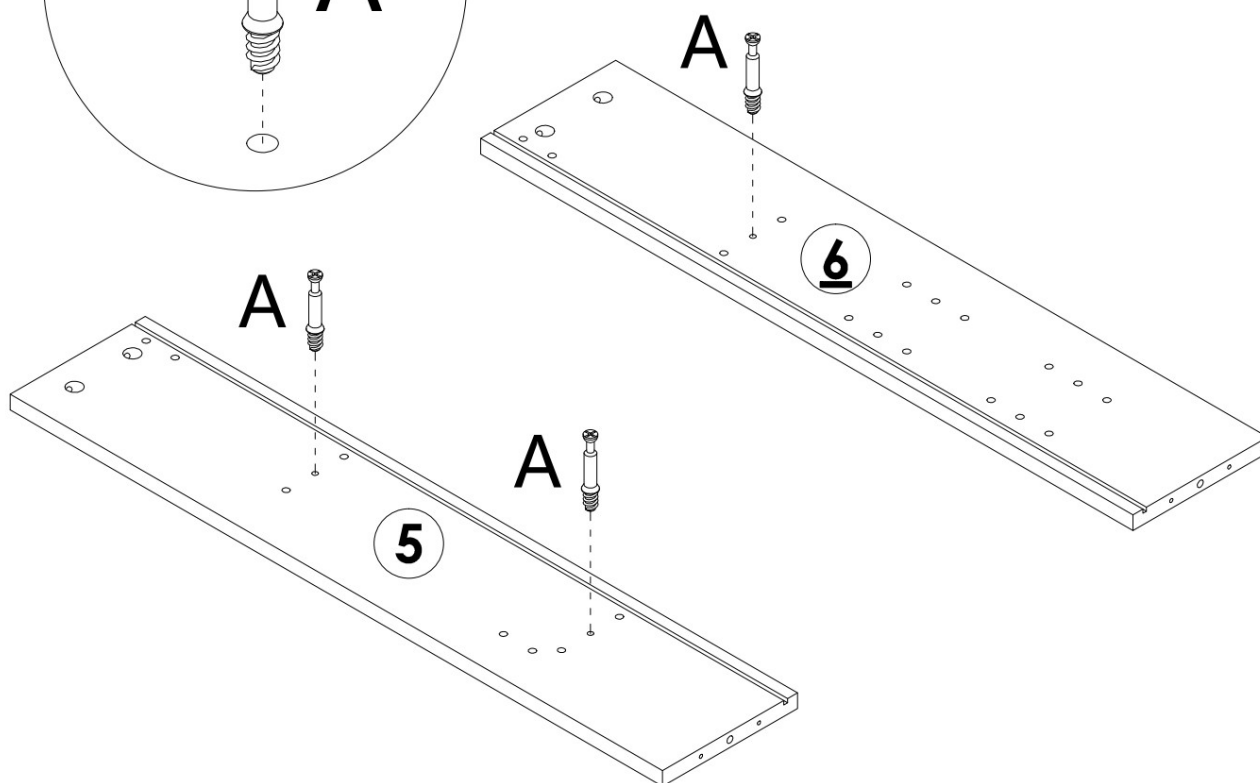
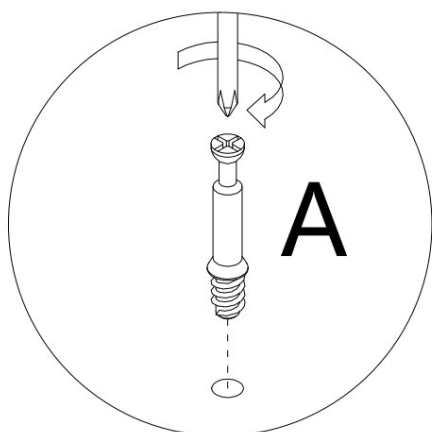

A x 3PCS

STEP 14

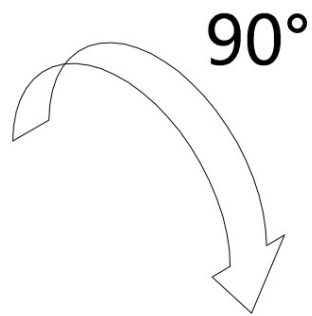
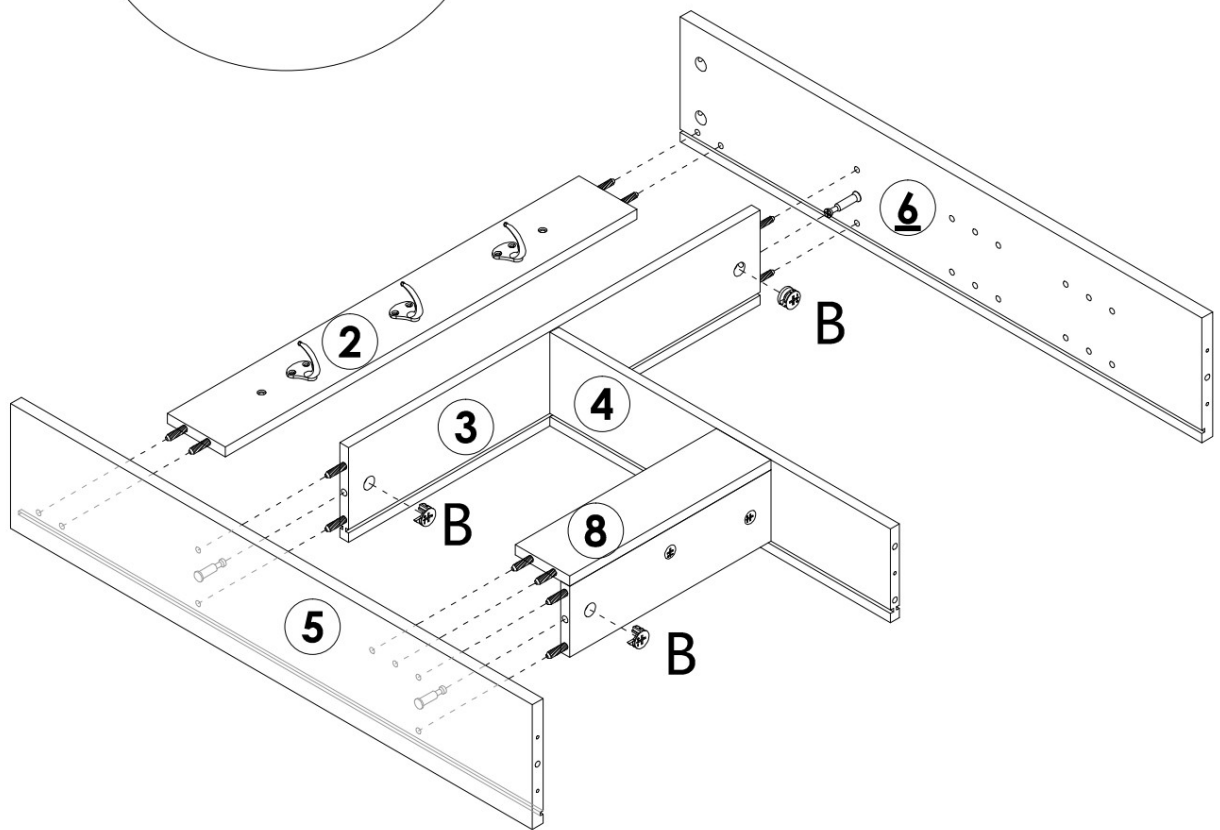
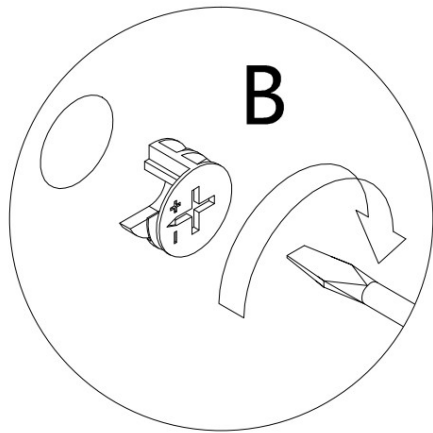

B x 3PCS

STEP 15

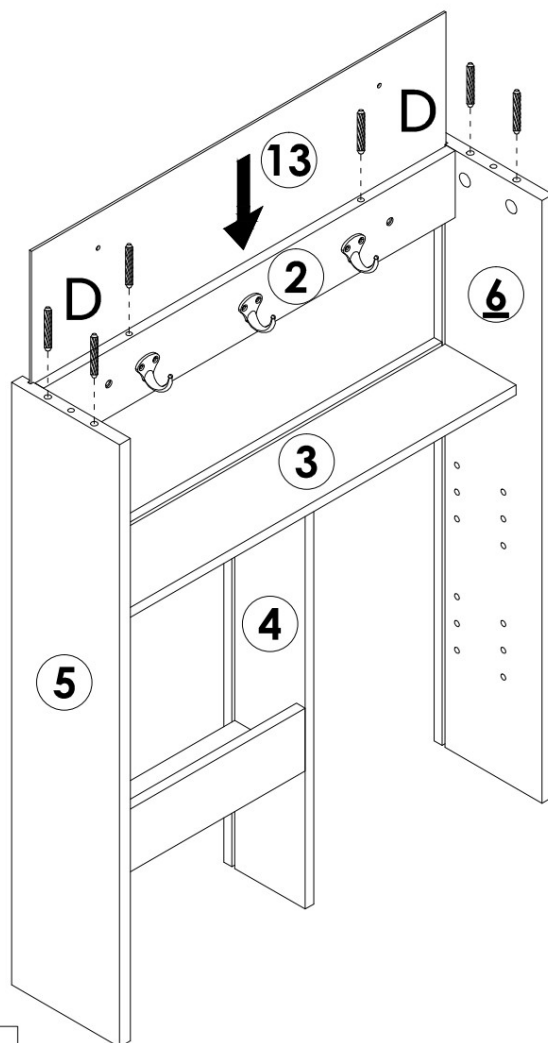

 **D x 6PCS**

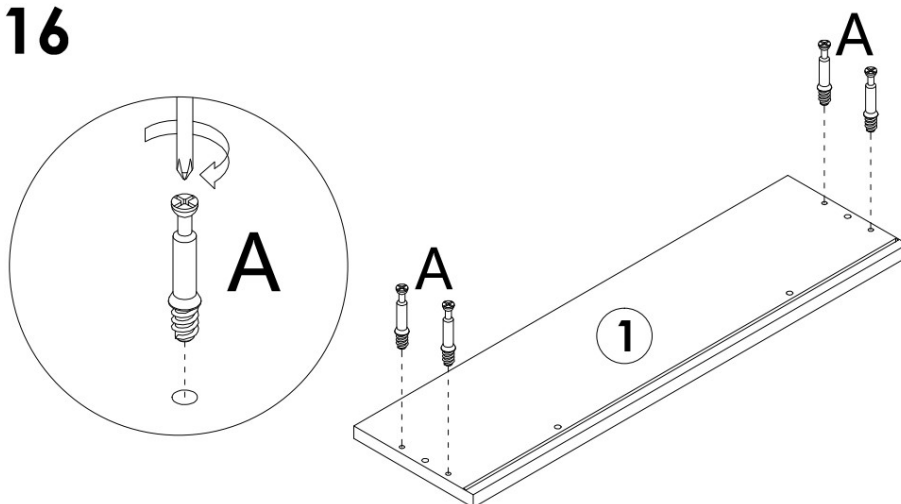

STEP 16

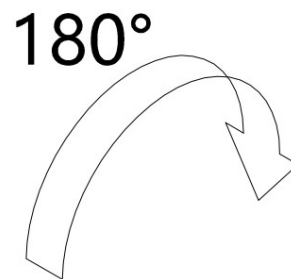
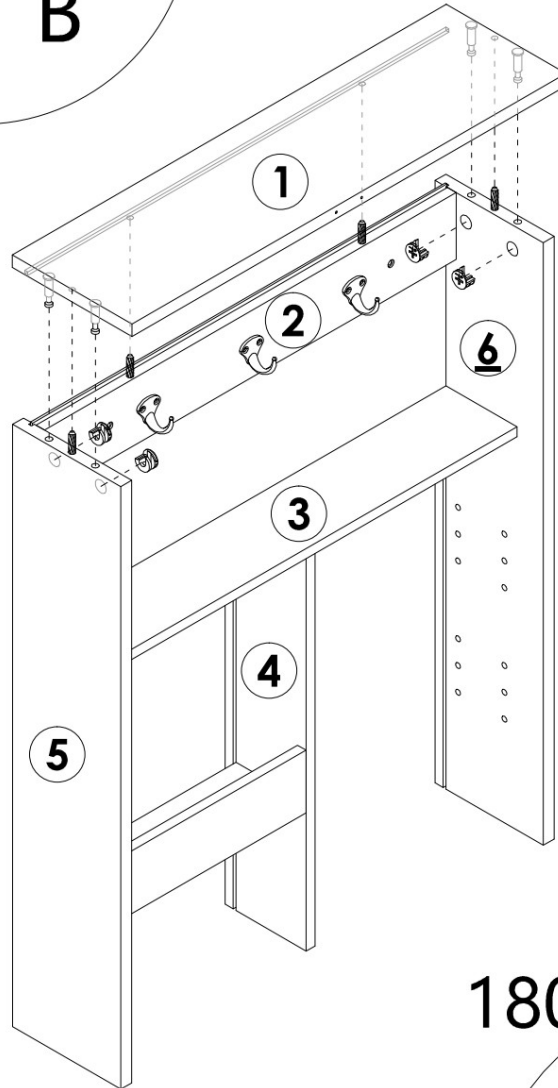
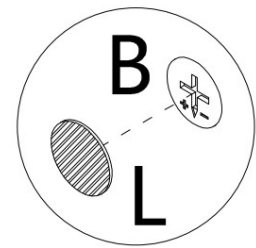
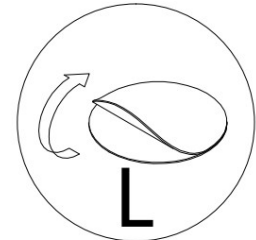
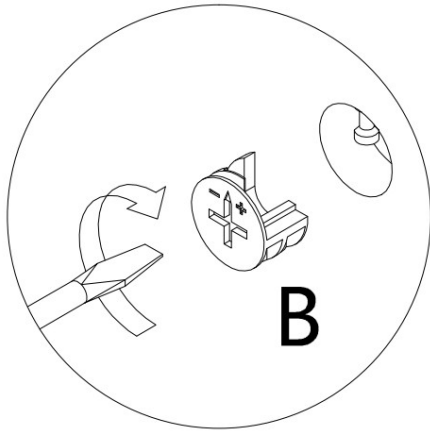

 **A x 4PCS**

STEP 17



	B x 4PCS
	L x 4PCS

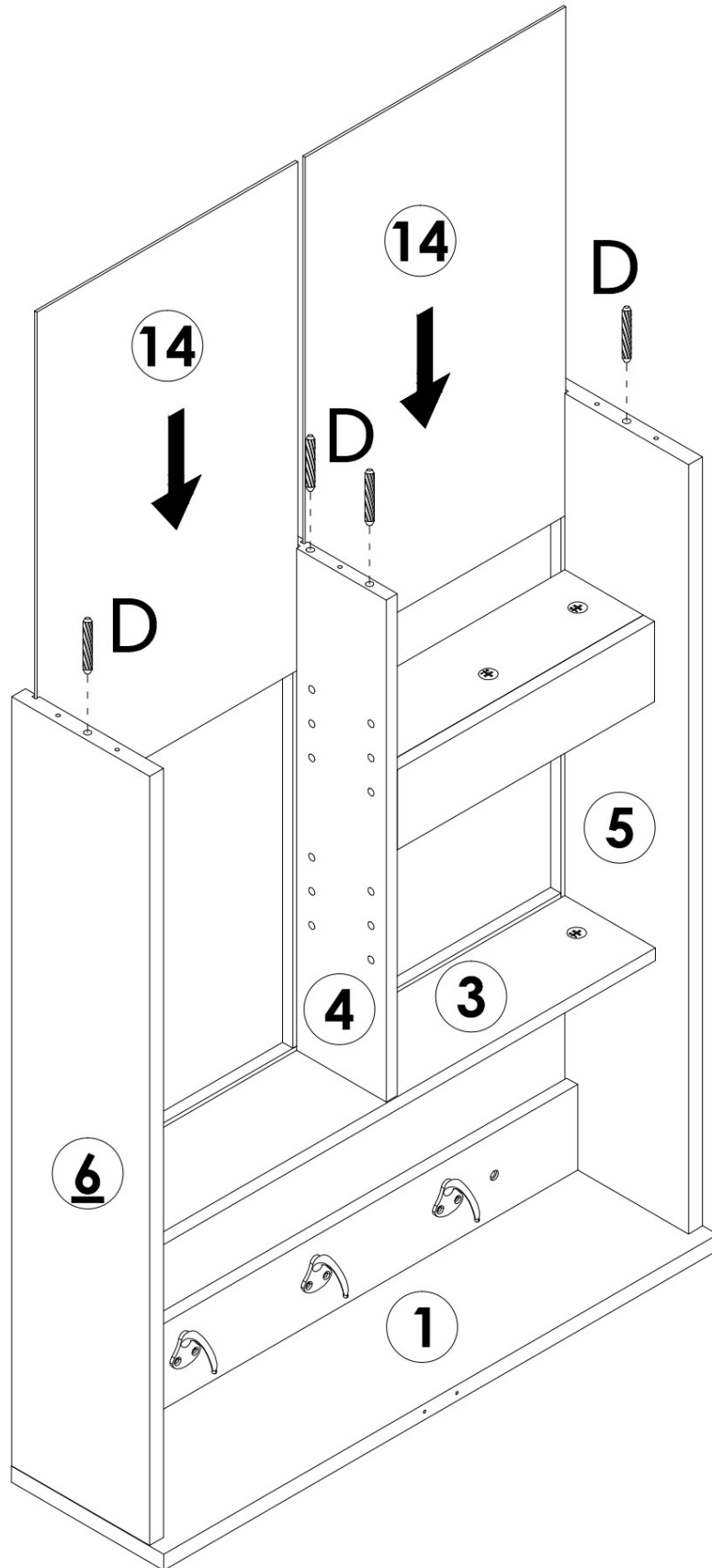

STEP 18

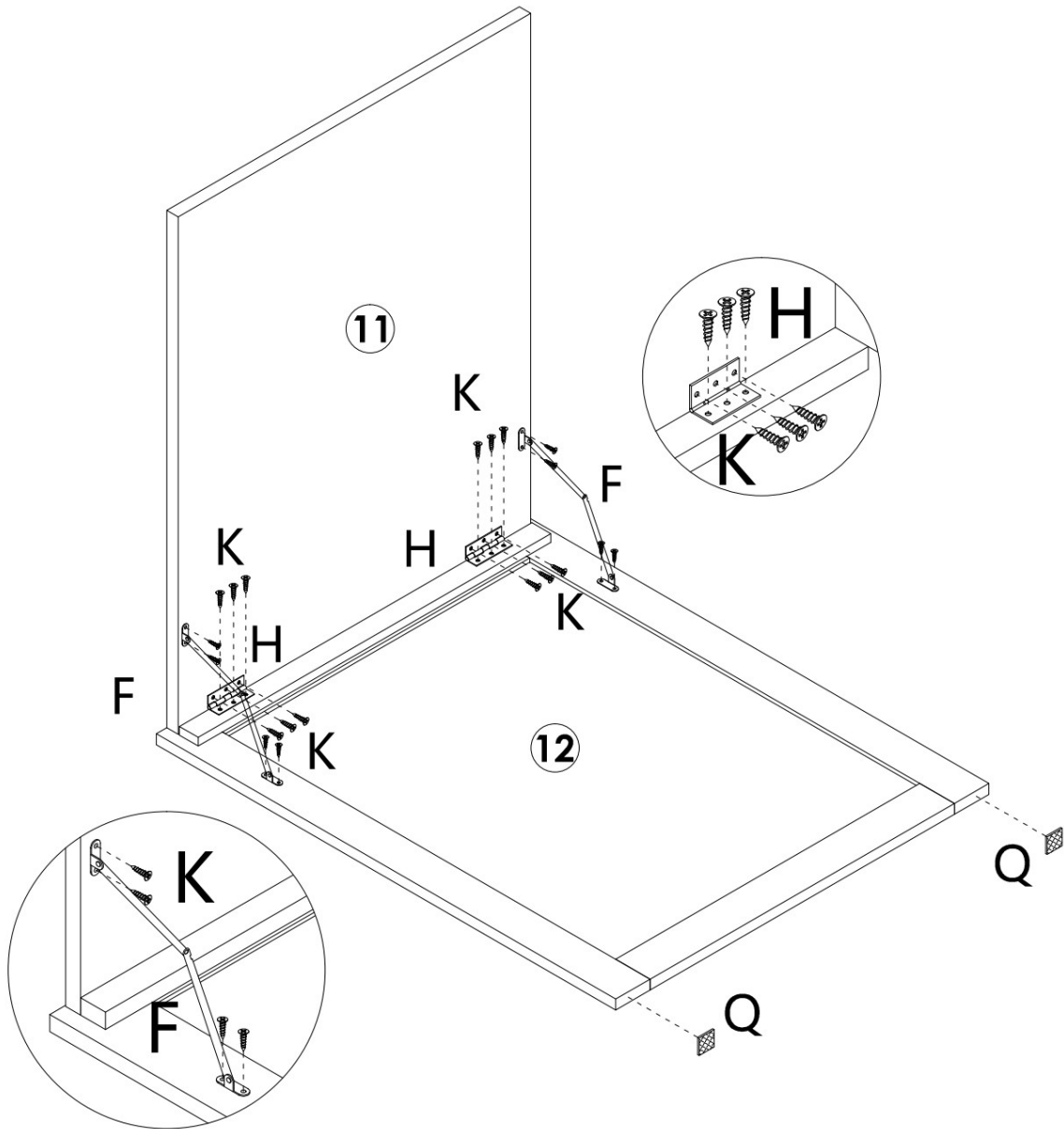

D x 4PCS

STEP 19



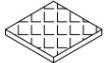

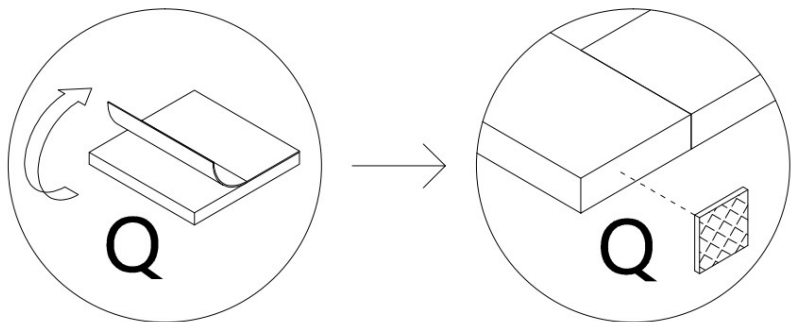
	F x 2PCS
	H x 2PCS
	K x 20PCS
	Q x 2PCS

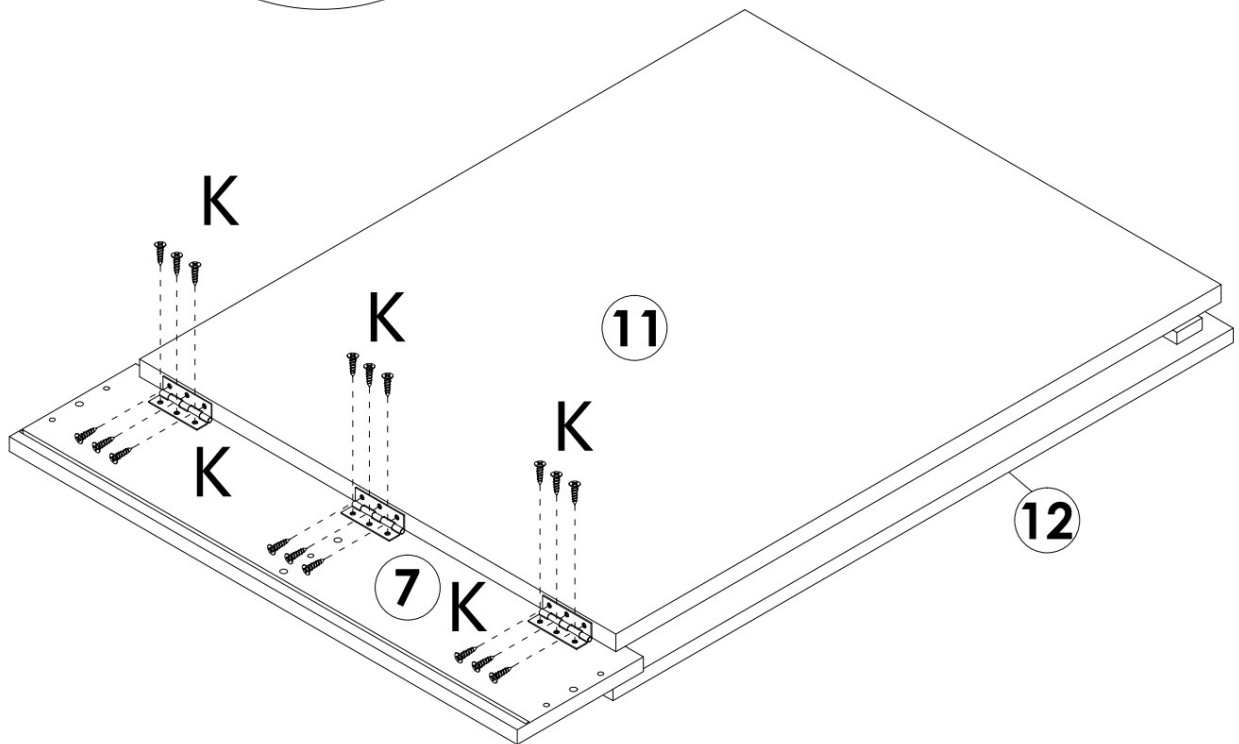
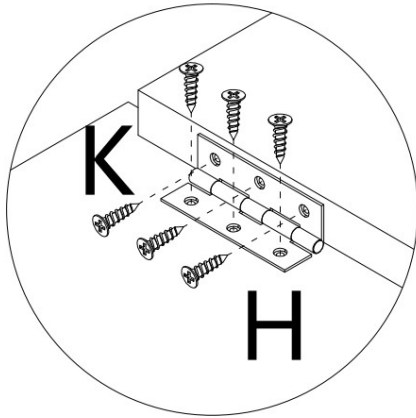

STEP 20



	H x 3PCS
	K x 18PCS

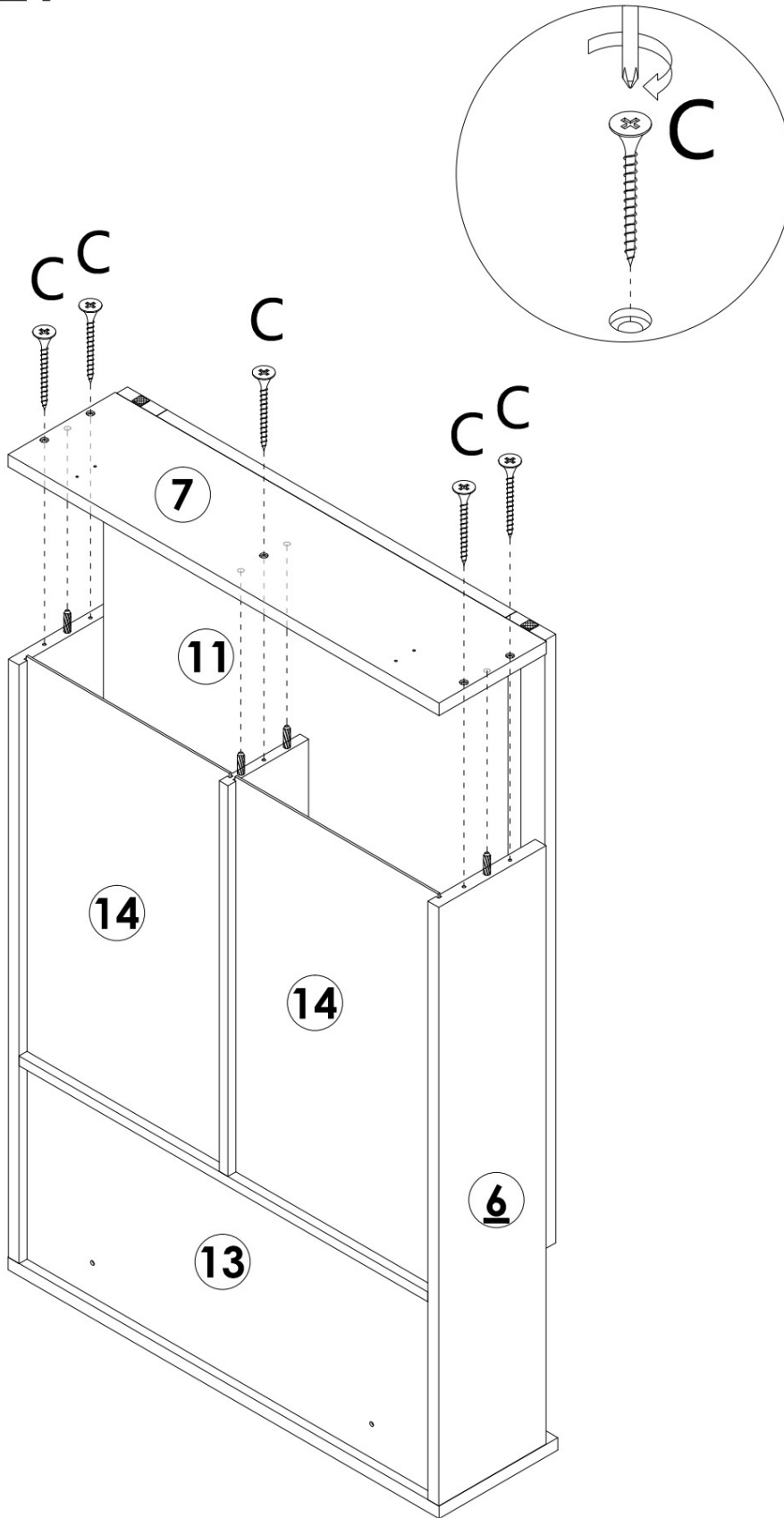

STEP 21

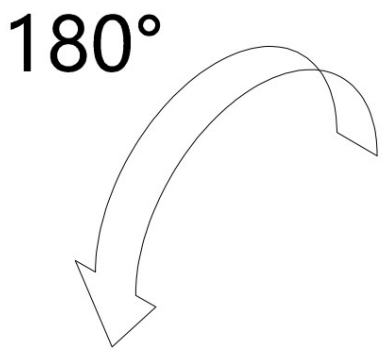
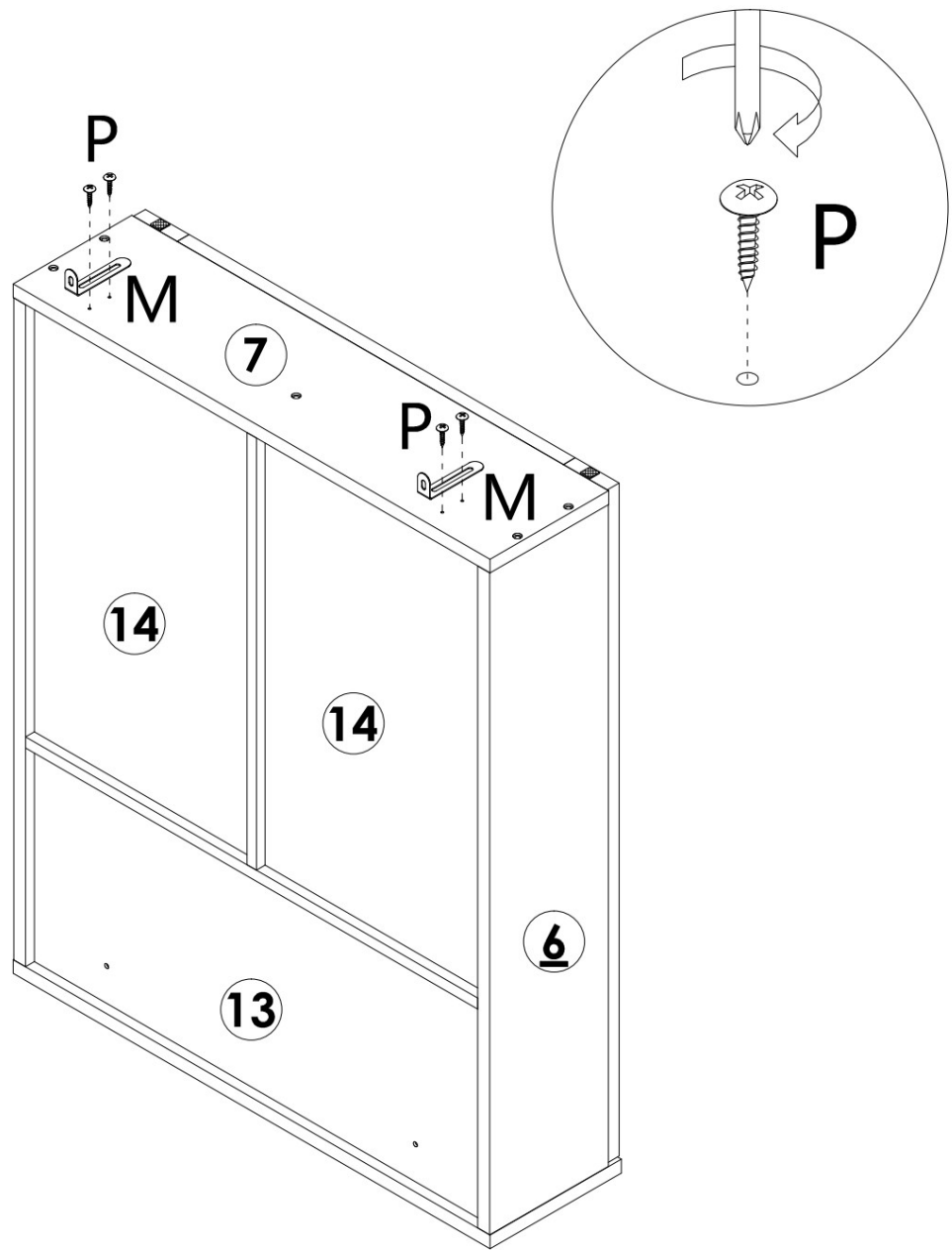

 **C x 5PCS**

STEP 22

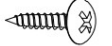

	P x 4PCS
	M x 2PCS

STEP 23

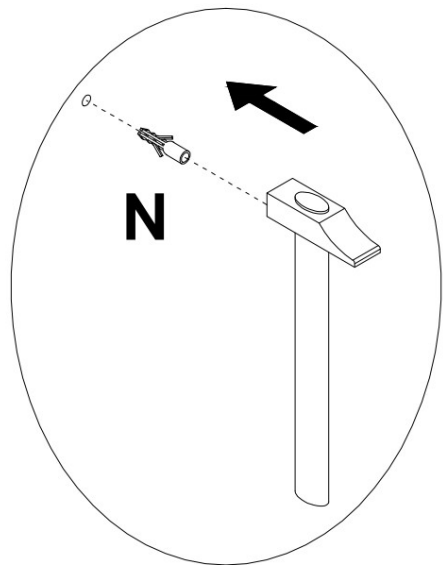
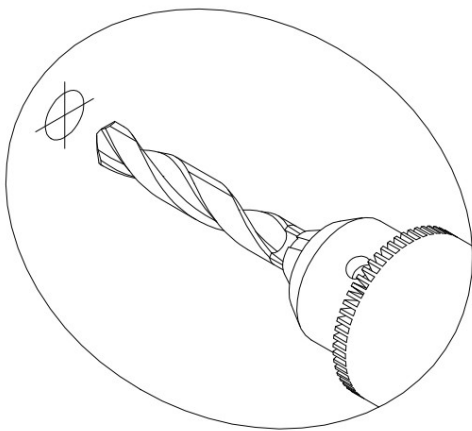
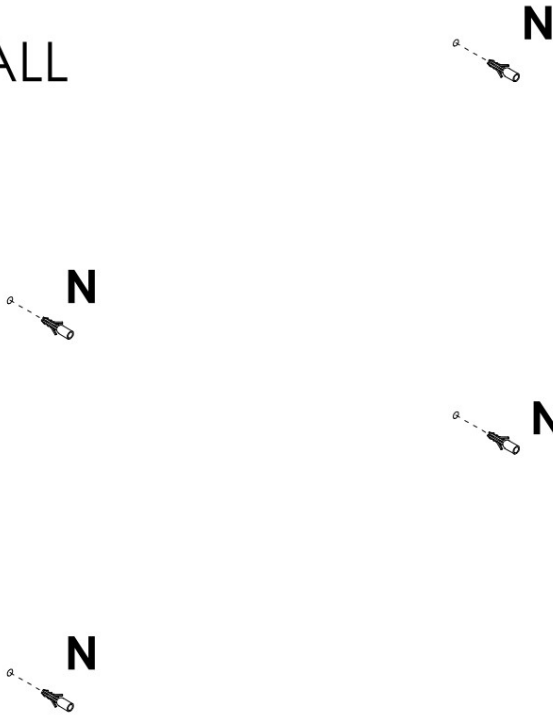

WALL

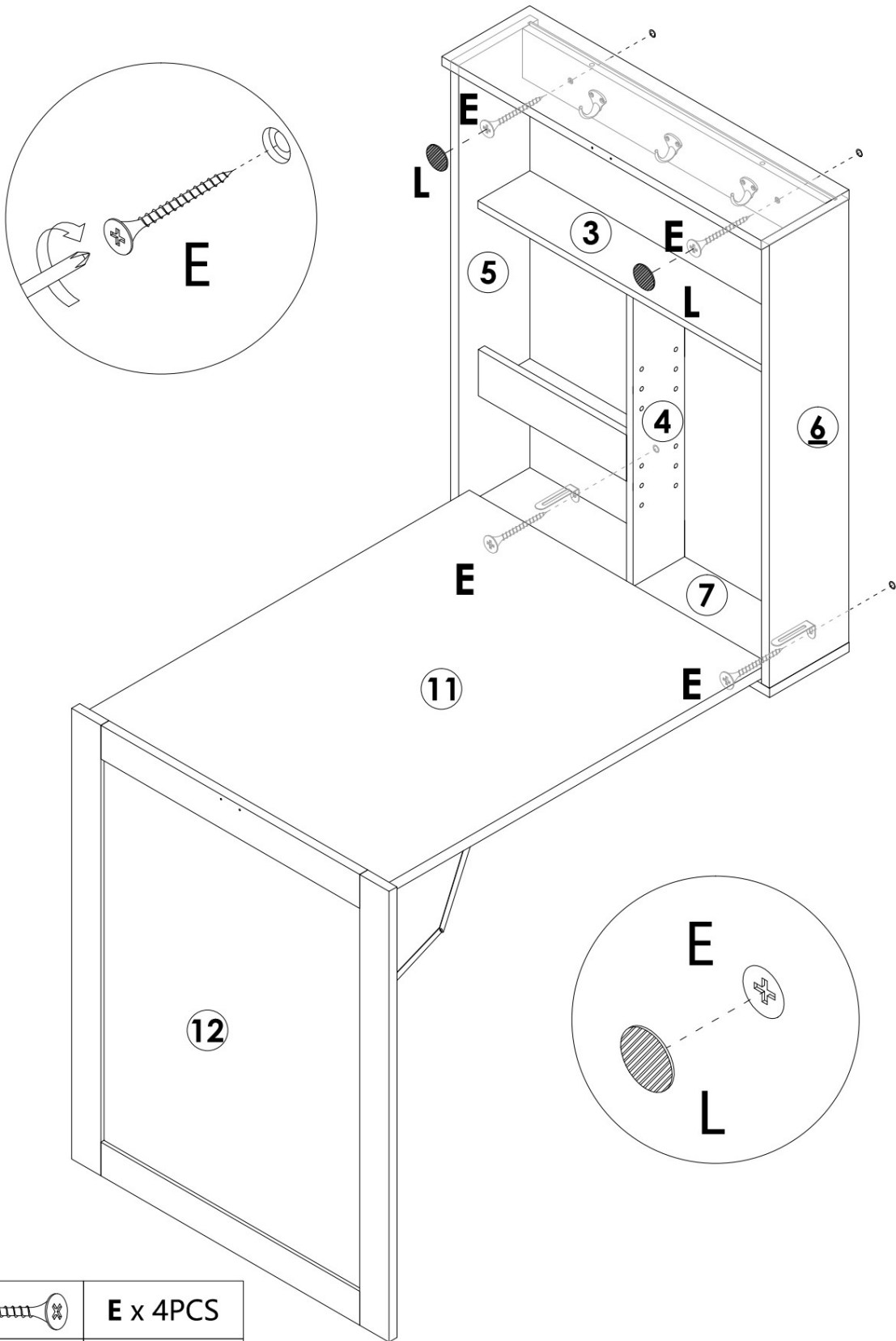

N x 4PCS

STEP 24

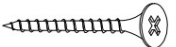

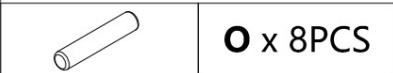
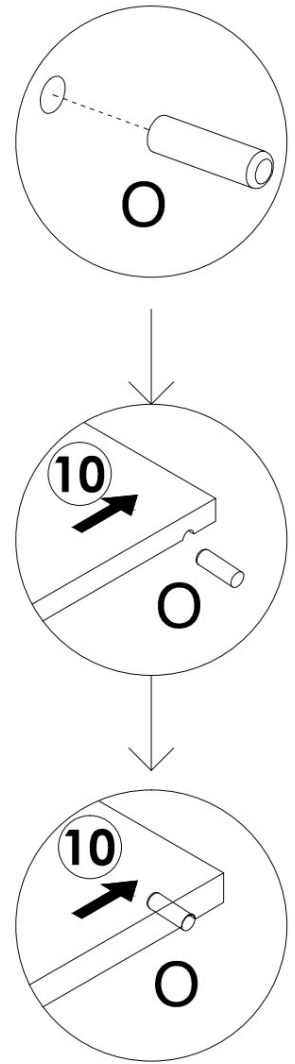
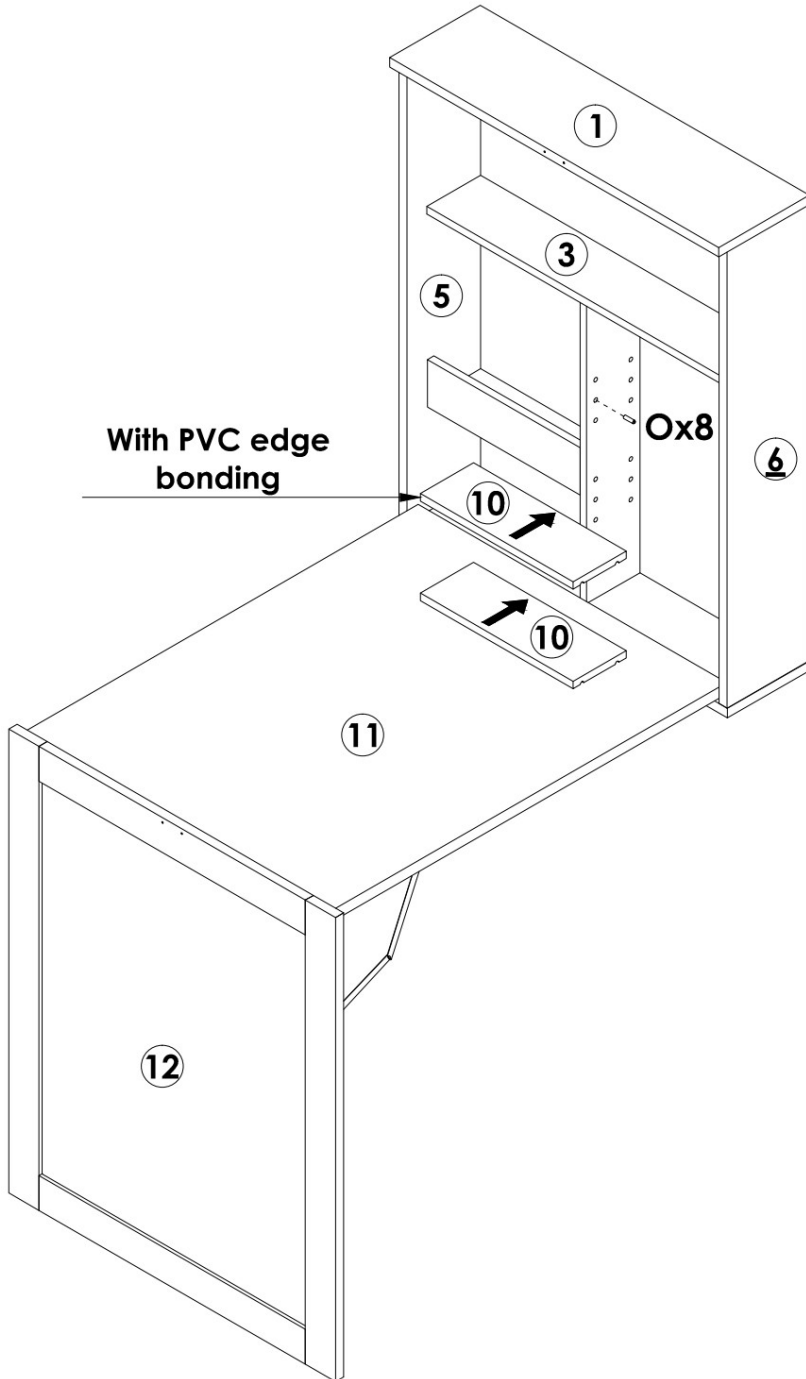

	E x 4PCS
	L x 2PCS

STEP 25

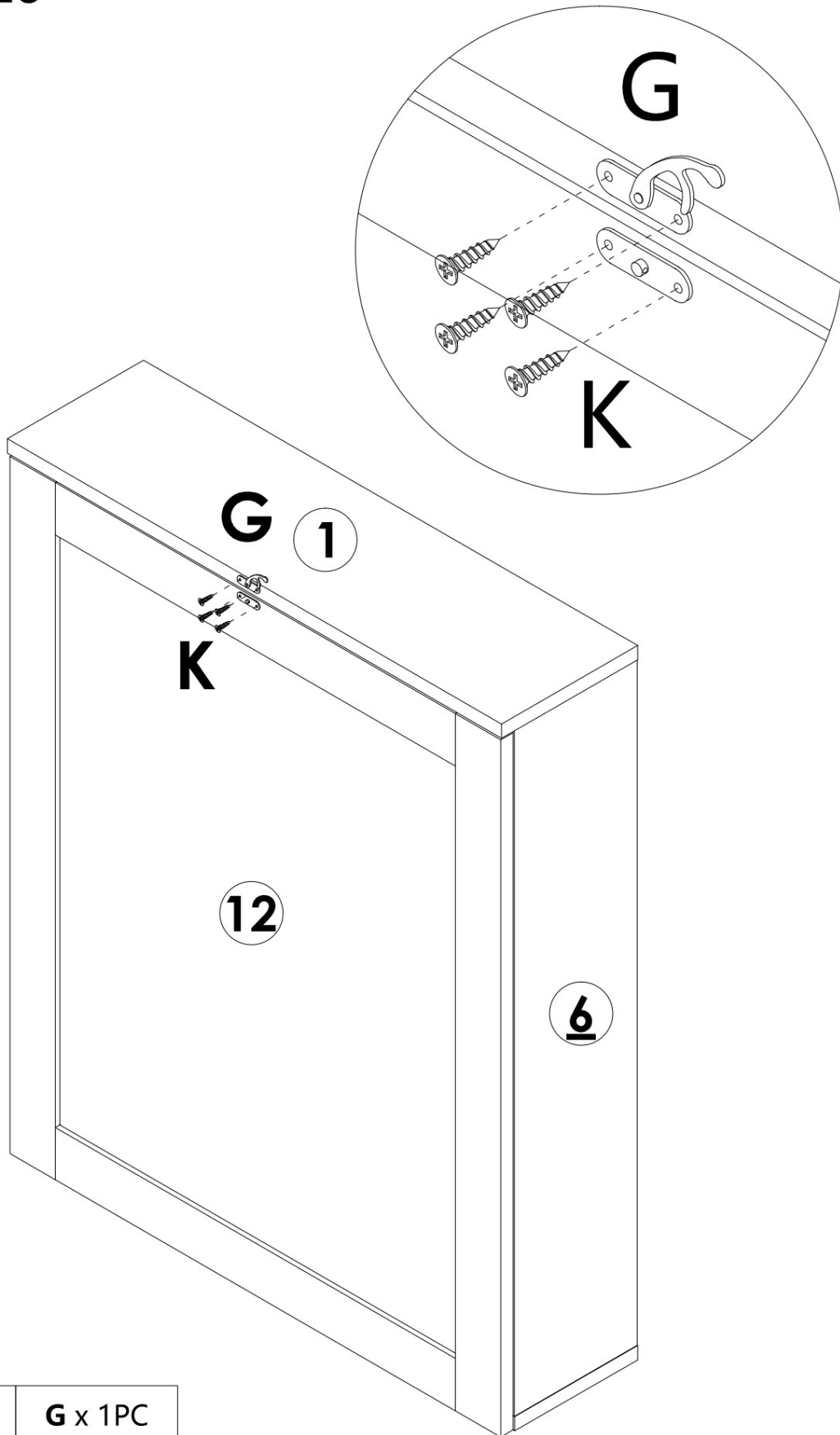

STEP 26



	G x 1PC
	K x 4PCS

ACHÈVEMENT

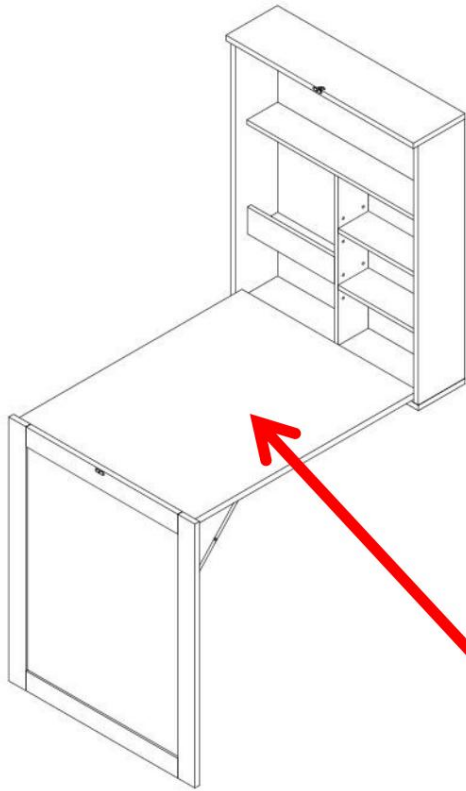

45,35 kg, répartition uniforme

PARAMÈTRE DU PRODUIT

Modèle	HZCD003
Poids de chargement sécuritaire	45,35 kg
Taille du produit	600*165*1470mm

Adresse : Shuangchenglu 803nong11hao1602A-1609shi, baoshanqu, Shanghai 200000 CN.

Importé en Australie : SIHAO PTY LTD, 1 ROKEVA STREET, ASTWOOD NSW 2122 Australie

Importé aux États-Unis : Sanven Technology Ltd. Suite 250, 9166 Anaheim Place, Rancho Cucamonga, CA 91730



E-CrossStu GmbH.

Mainzer Landstr.69, 60329 Francfort-sur-le-Main.

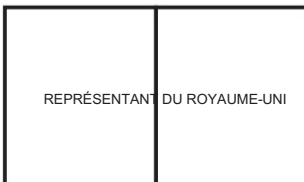

YH CONSULTING LIMITÉE.

C/O YH Consulting Limited Bureau 147, Centurion House, Route de Londres, Staines-upon-Thames, Surrey, TW18 4AX

VEVOR[®]
TOUGH TOOLS, HALF PRICE

Assistance technique et certificat de garantie
électronique www.vevor.com/support

VEVOR[®]

TOUGH TOOLS, HALF PRICE

Technischer Support und E-Garantie-Zertifikat www.vevor.com/support

SCHWEBENDER SCHREIBTISCH

BENUTZERHANDBUCH

MODELL:HZCD003

Wir sind weiterhin bestrebt, Ihnen Werkzeuge zu wettbewerbsfähigen Preisen anzubieten.

„Sparen Sie die Hälfte“, „Halber Preis“ oder andere ähnliche Ausdrücke, die wir verwenden, stellen nur eine Schätzung der Ersparnis dar, die Sie beim Kauf bestimmter Werkzeuge bei uns im Vergleich zu den großen Topmarken erzielen können, und bedeuten nicht notwendigerweise, dass sie alle von uns angebotenen Werkzeugkategorien abdecken. Wir möchten Sie freundlich daran erinnern, bei Ihrer Bestellung bei uns sorgfältig zu prüfen, ob Sie im Vergleich zu den großen Topmarken tatsächlich die Hälfte sparen.

VEVOR[®]
TOUGH TOOLS, HALF PRICE

SCHWEBENDER SCHREIBTISCH

MODELL:HZCD003



Brauchen Sie Hilfe? Kontaktieren Sie uns!

Sie haben Fragen zu unseren Produkten? Sie benötigen technischen Support? Dann kontaktieren Sie uns gerne:

Technischer Support und E-Garantie-Zertifikat
www.vevor.com/support

Dies ist die Originalanleitung. Bitte lesen Sie alle Anweisungen sorgfältig durch, bevor Sie das Gerät in Betrieb nehmen. VEVOR behält sich eine klare Auslegung unserer Bedienungsanleitung vor. Das Erscheinungsbild des Produkts richtet sich nach dem Produkt, das Sie erhalten haben. Bitte verzeihen Sie uns, dass wir Sie nicht erneut informieren, wenn es Technologie- oder Software-Updates für unser Produkt gibt.

SICHERHEITSHINWEISE

WARNUNG:

Lesen Sie dieses Material, bevor Sie dieses Produkt verwenden.

kann zu schweren Verletzungen führen.

Vorsichtsmaßnahmen bei der Montage

1. Die Montage muss gemäß dieser Anleitung erfolgen. Eine unsachgemäße Montage kann Gefahren schaffen.
2. Tragen Sie ANSI-zugelassene Schutzbrillen und strapazierfähige Arbeitshandschuhe bei der Montage.
3. Halten Sie den Versammlungsbereich sauber und gut beleuchtet.
4. Halten Sie während der Montage unbeteiligte Zuschauer vom Bereich fern.
5. Nicht montieren, wenn Sie müde sind oder unter dem Einfluss von Alkohol, Drogen oder Medikamenten stehen.
6. Die Produkteigenschaften gelten für ordnungsgemäß und vollständig montierte Produkte.
Nur Produkte.
7. Auf einer flachen, ebenen, harten und glatten Oberfläche montieren, die sicher Unterstützung des Floating Desk.
8. Weitere Informationen zu den im Folgenden aufgeführten Teilen finden Sie
Seiten finden Sie im Montageplan dieses Handbuchs. Auspacken
und trennen Sie alle Teile in einem sauberen Arbeitsbereich.









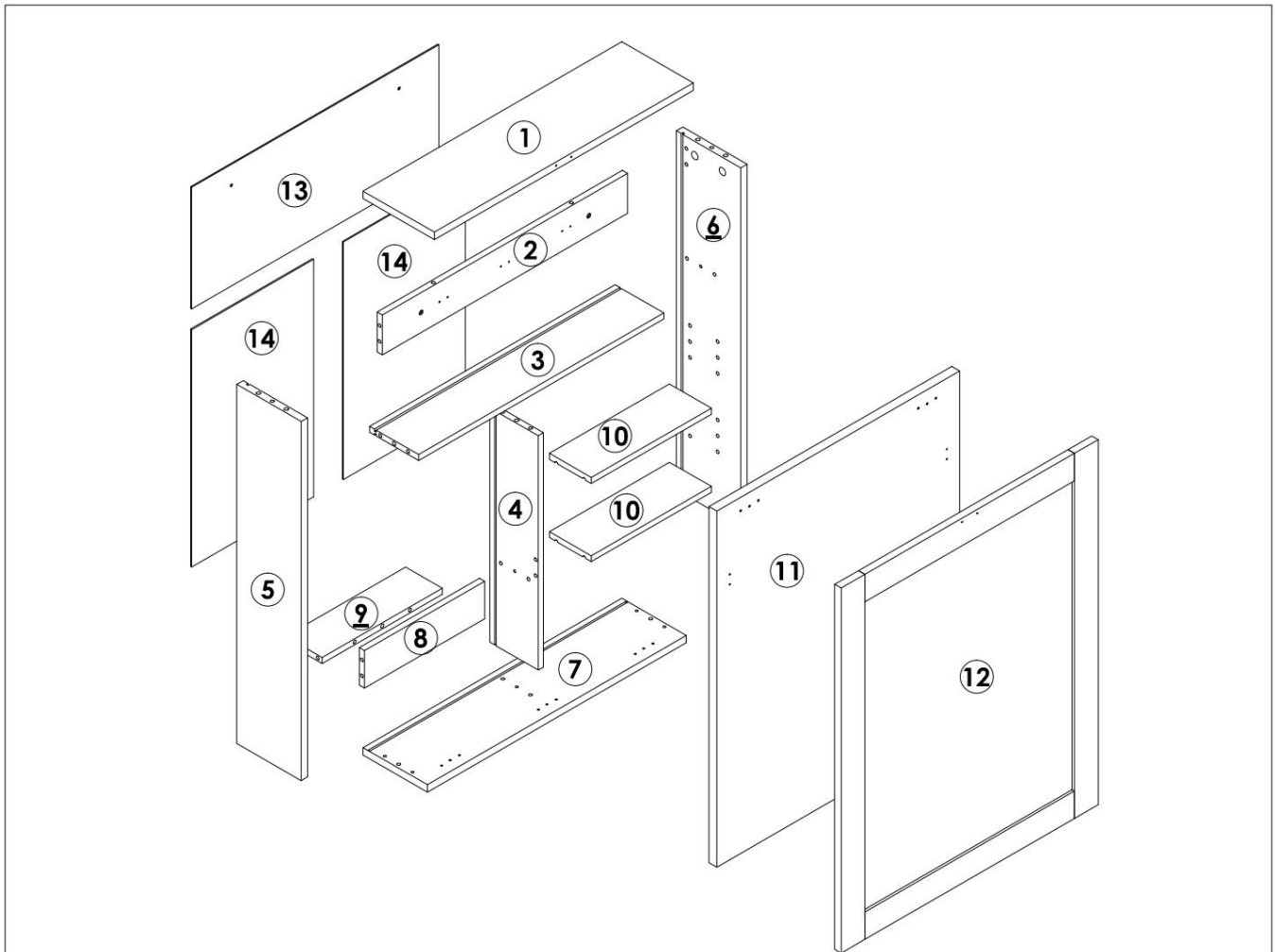

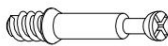



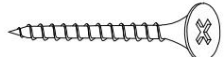
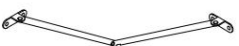

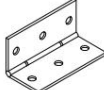
Vorsichtsmaßnahmen treffen

1. Setzen oder stellen Sie sich nicht auf diesen Gegenstand.
2. Dieses Produkt ist kein Spielzeug. Erlauben Sie Kindern nicht, mit oder in der Nähe dieses Artikel.
3. Überschreiten Sie nicht die zulässige Gewichtsgrenze.
4. Nur bestimmungsgemäß verwenden.
5. Vor jedem Gebrauch prüfen; nicht verwenden, wenn Teile lose oder beschädigt sind.

BEWAHREN SIE DIESES HANDBUCH AUF

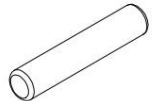
TEILELISTE

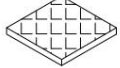

<p>A</p>  <p>M6x35mm 10+1PCS</p>	<p>B</p>  <p>Ø15x9mm 10+1PCS</p>	<p>C</p>  <p>M4x40mm 5PCS</p>	<p>D</p>  <p>Ø6x30mm 30+2PCS</p>	<p>E</p>  <p>M5x60mm 4PCS</p>
<p>F</p>  <p>2PCS</p>	<p>G</p>  <p>1PC</p>	<p>H</p>  <p>5PCS</p>	<p>I</p>  <p>3PCS</p>	<p>J</p>  <p>M3x14mm 6PCS</p>
<p>K</p>  <p>M3x12mm 42+2PCS</p>	<p>L</p>  <p>Ø20mm 7PCS</p>	<p>M</p>  <p>2PCS</p>	<p>N</p>  <p>M8x40mm 4PCS</p>	<p>O</p>  <p>M5x20mm 8+1PCS</p>
<p>P</p>  <p>M4x12mm 4PCS</p>	<p>Q</p>  <p>16x16mm 2PCS</p>	<p>R</p>  <p>1PC</p>		

ANWEISUNGEN

STEP 1

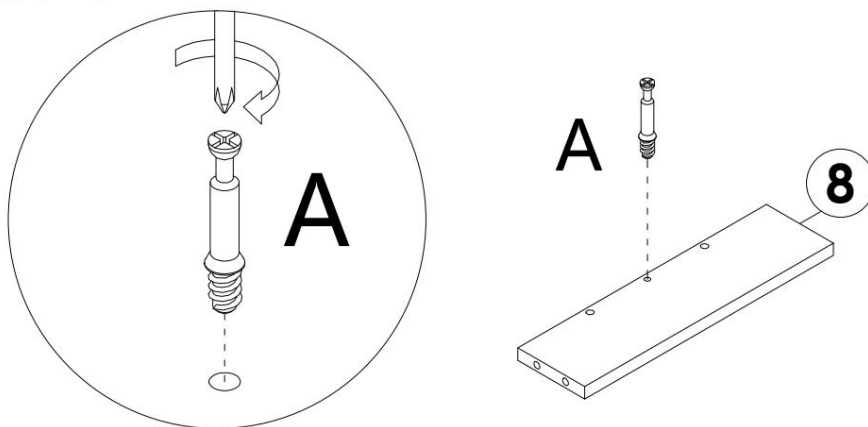

A x 1PC

STEP 2

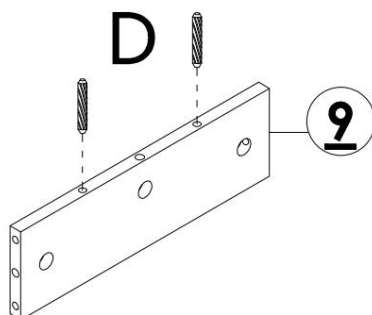

D x 2PCS

STEP 3

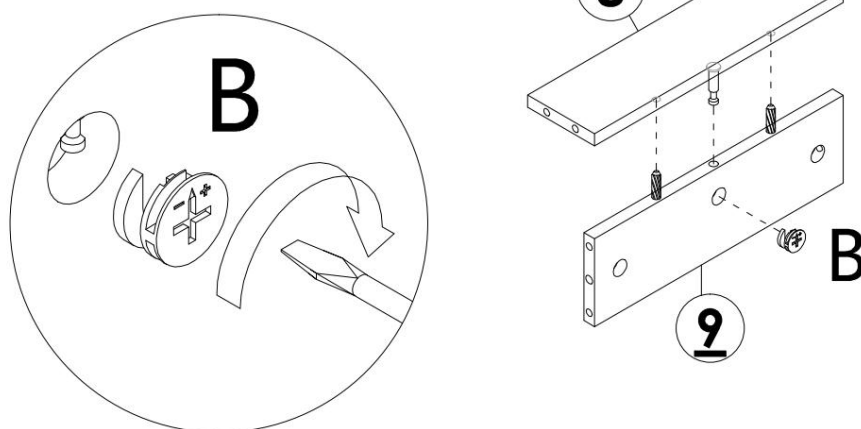

B x 1PC

STEP 4

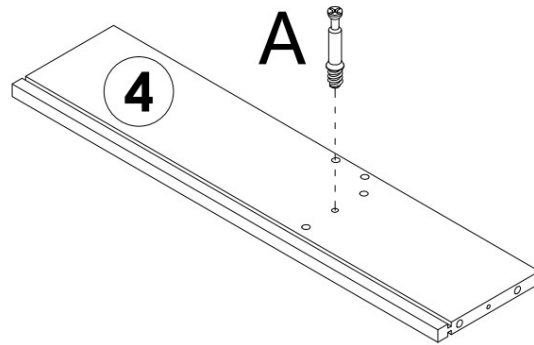
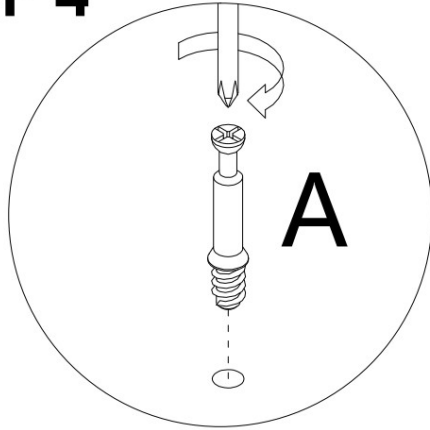

A x 1PC

STEP 5

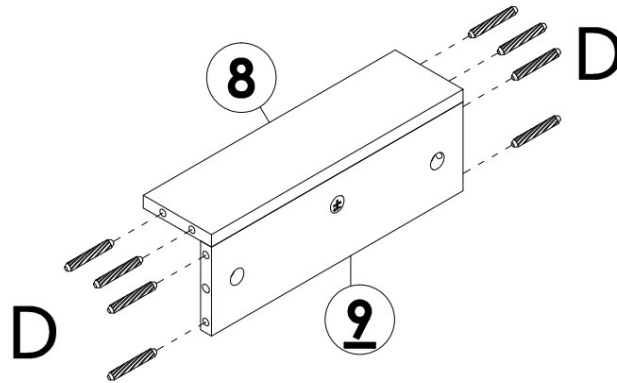

D x 8PCS

STEP 6

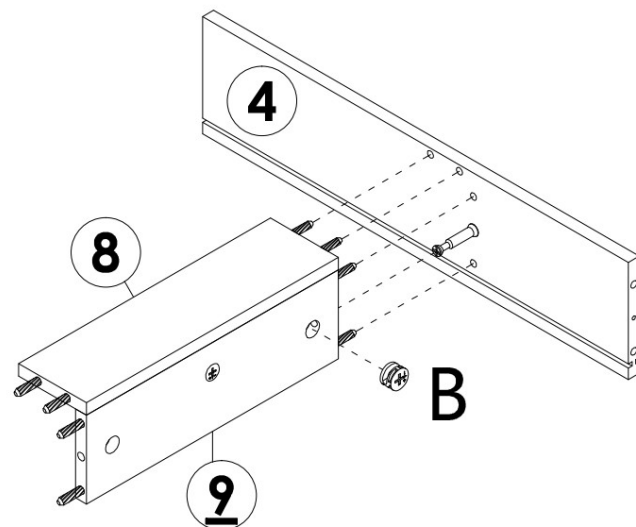
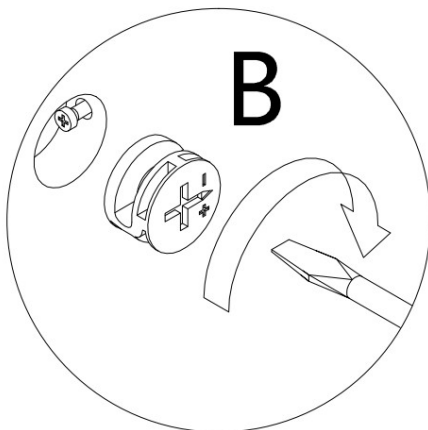

B x 1PC

STEP 7

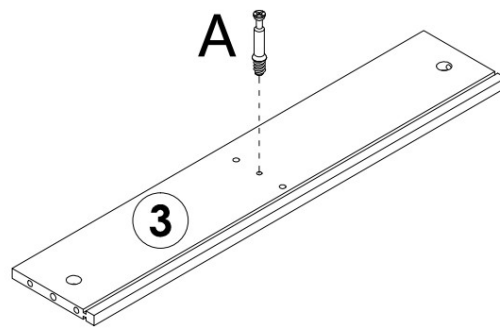
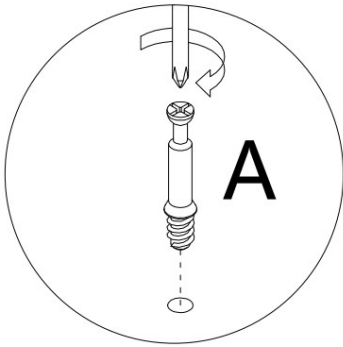

A x 1PC

STEP 8

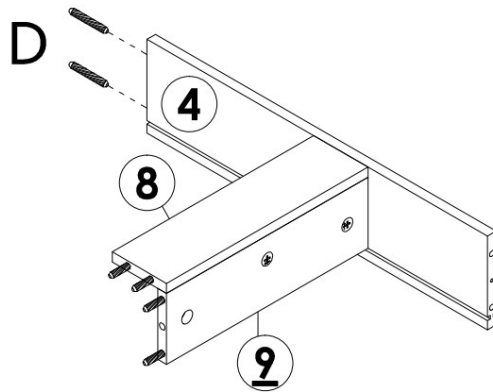

D x 2PCS

STEP 9

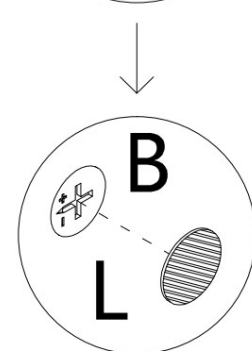
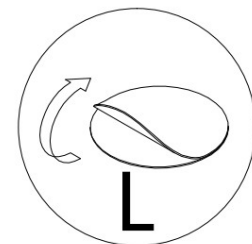
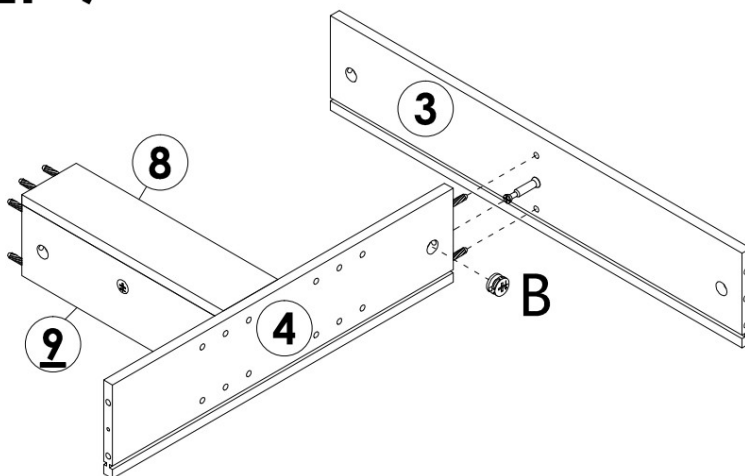



B x 1PC

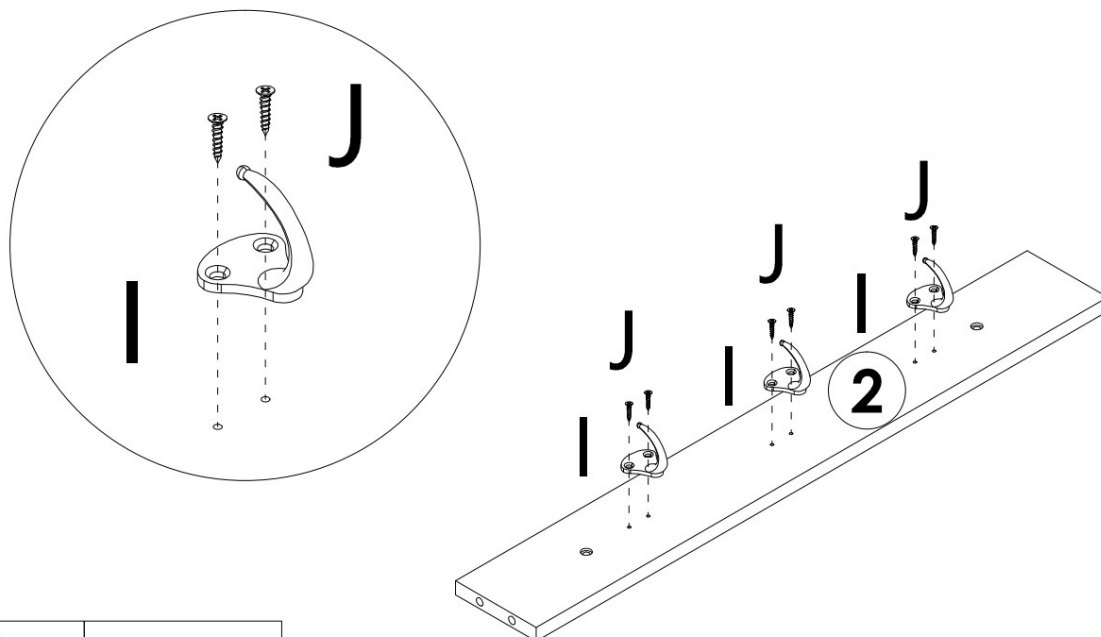

L x 1PC

STEP 10

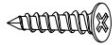

	I x 3PCS
	J x 6PCS

STEP 11

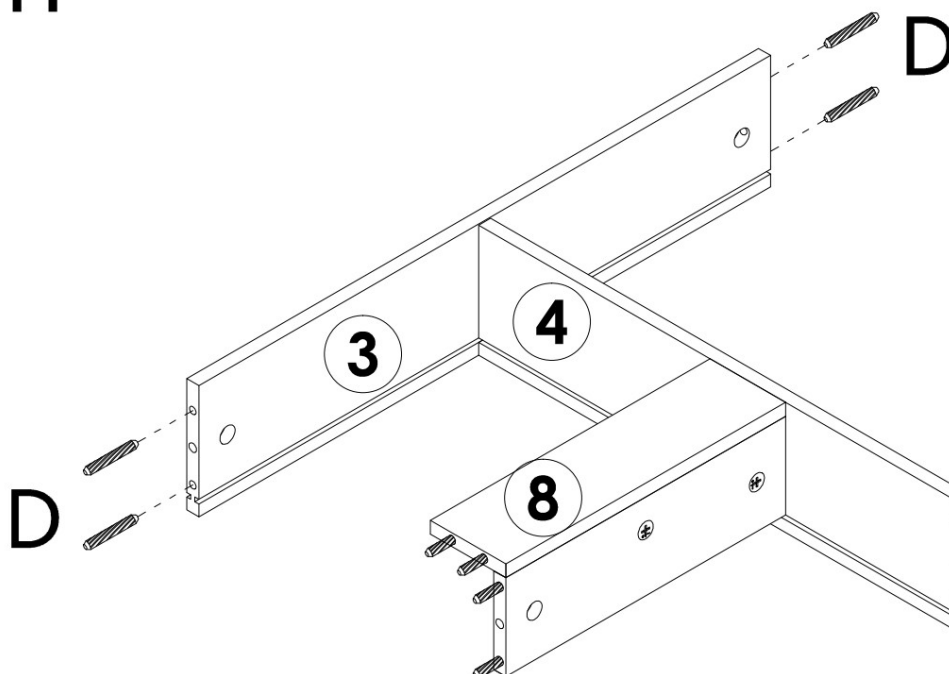

	D x 4PCS
---	----------

STEP 12

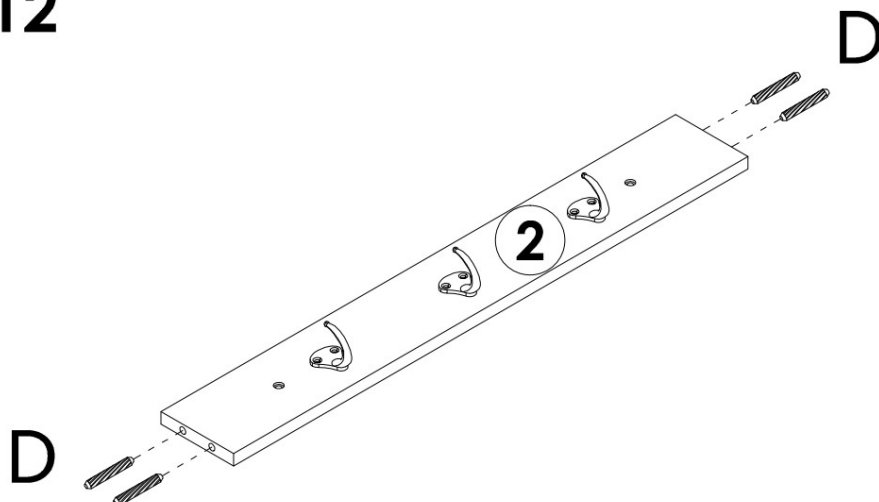

D x 4PCS

STEP 13

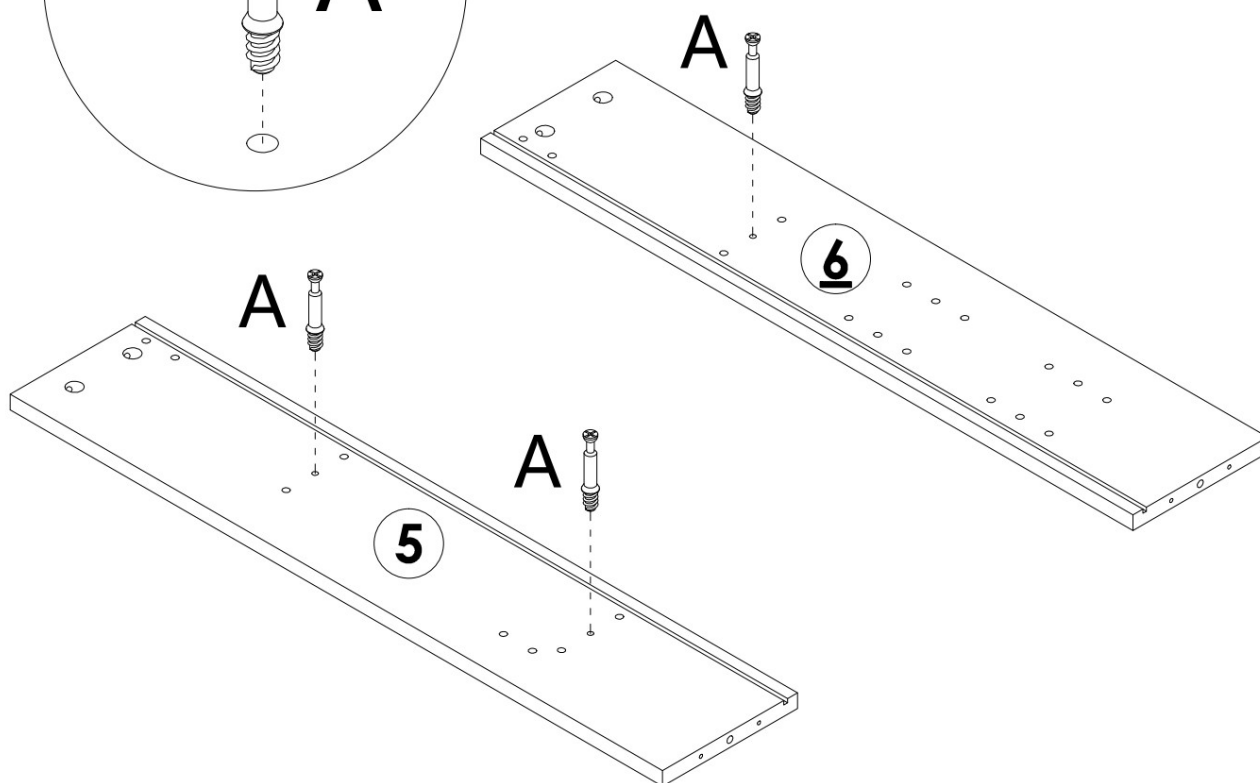
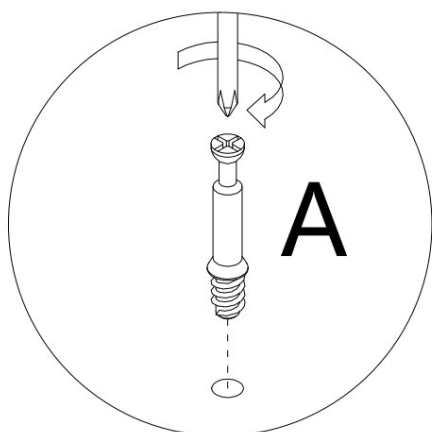

A x 3PCS

STEP 14

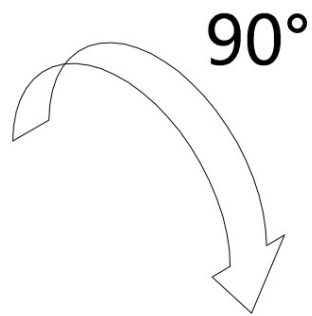
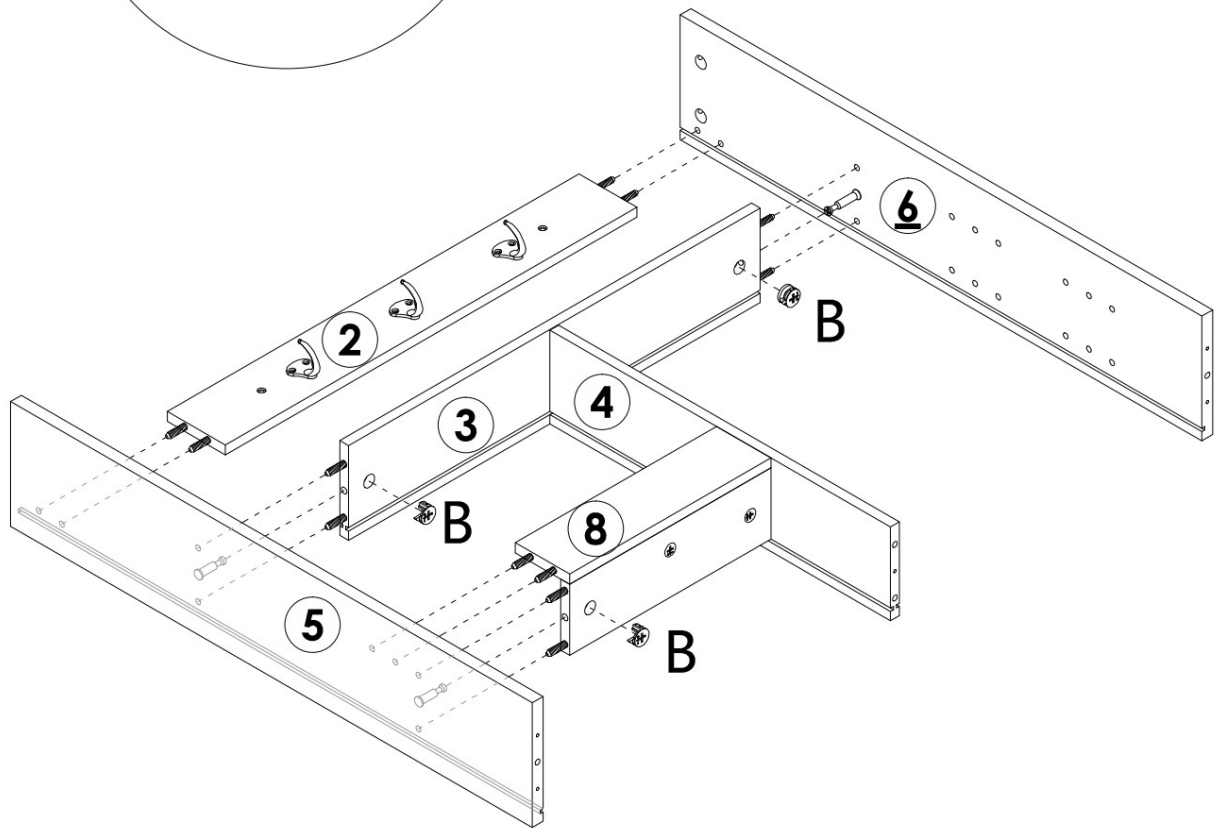
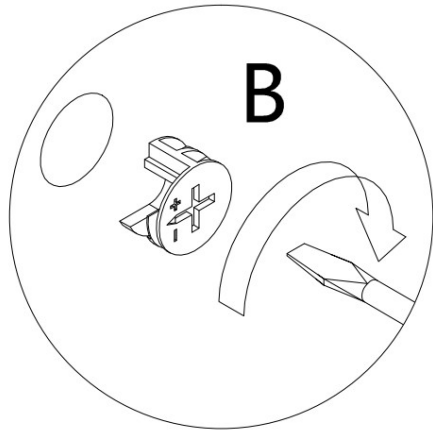

B x 3PCS

STEP 15

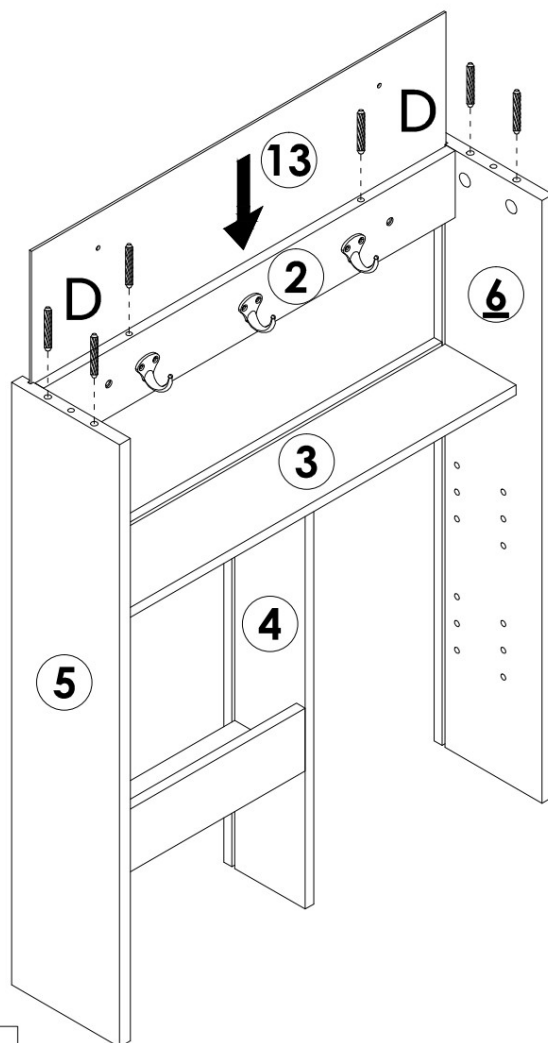

D x 6PCS

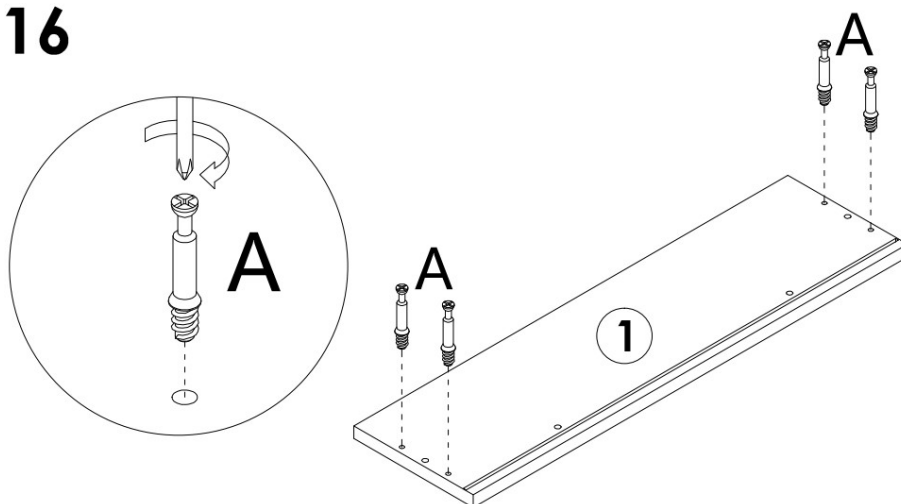

STEP 16

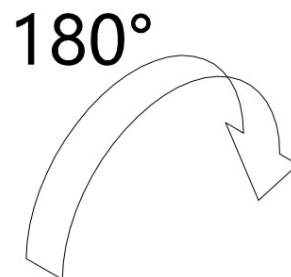
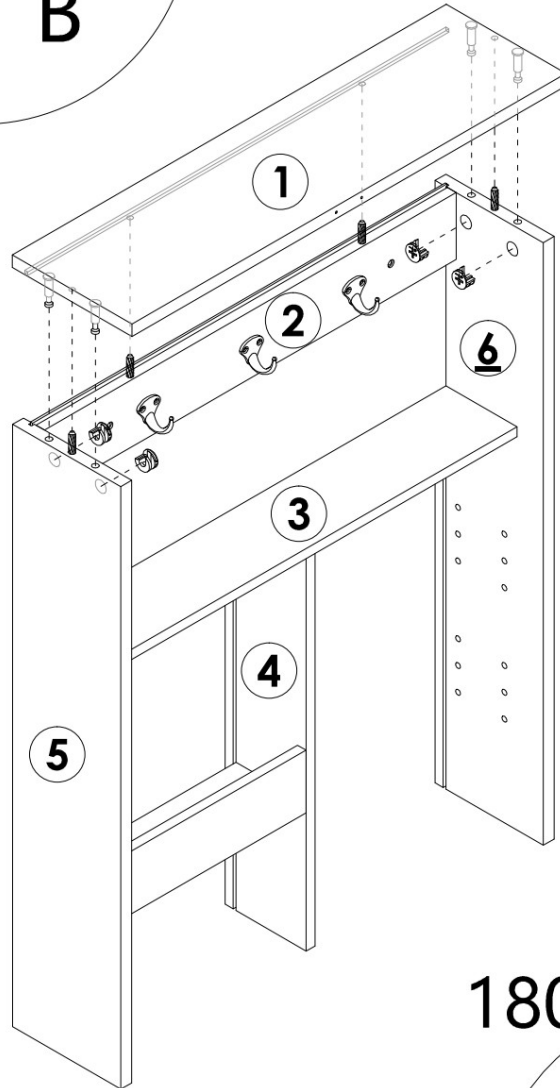
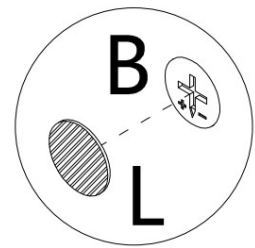
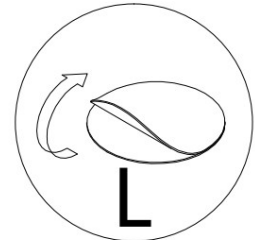
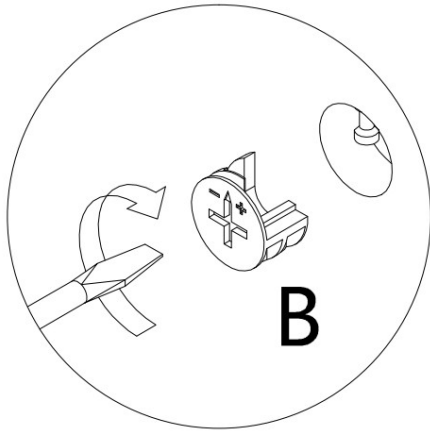

A x 4PCS

STEP 17



	B x 4PCS
	L x 4PCS

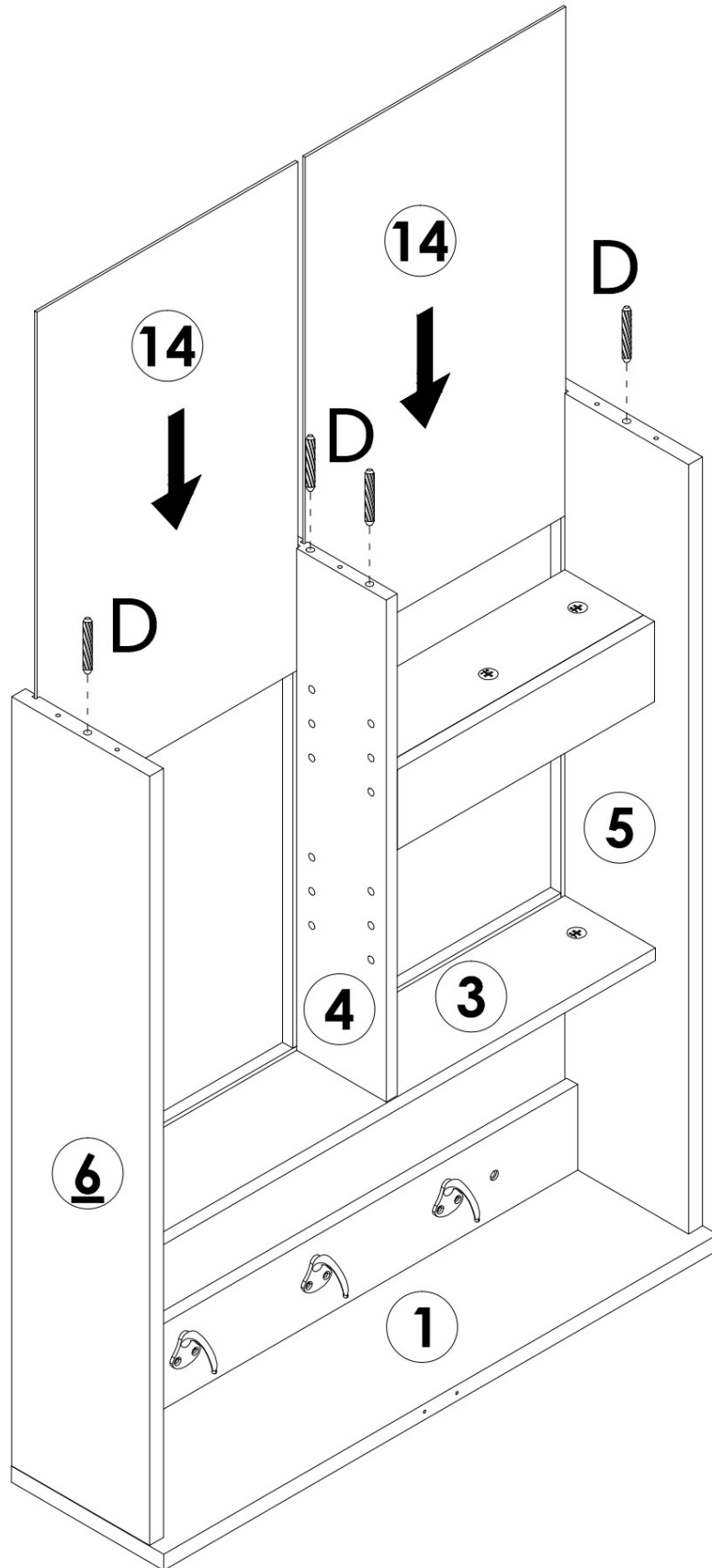

STEP 18

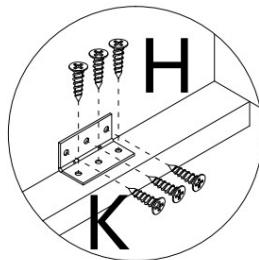
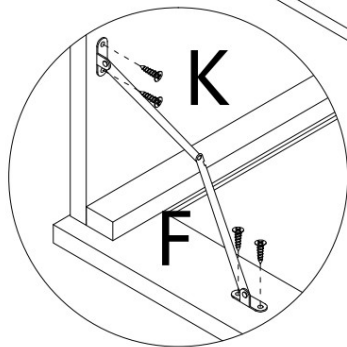
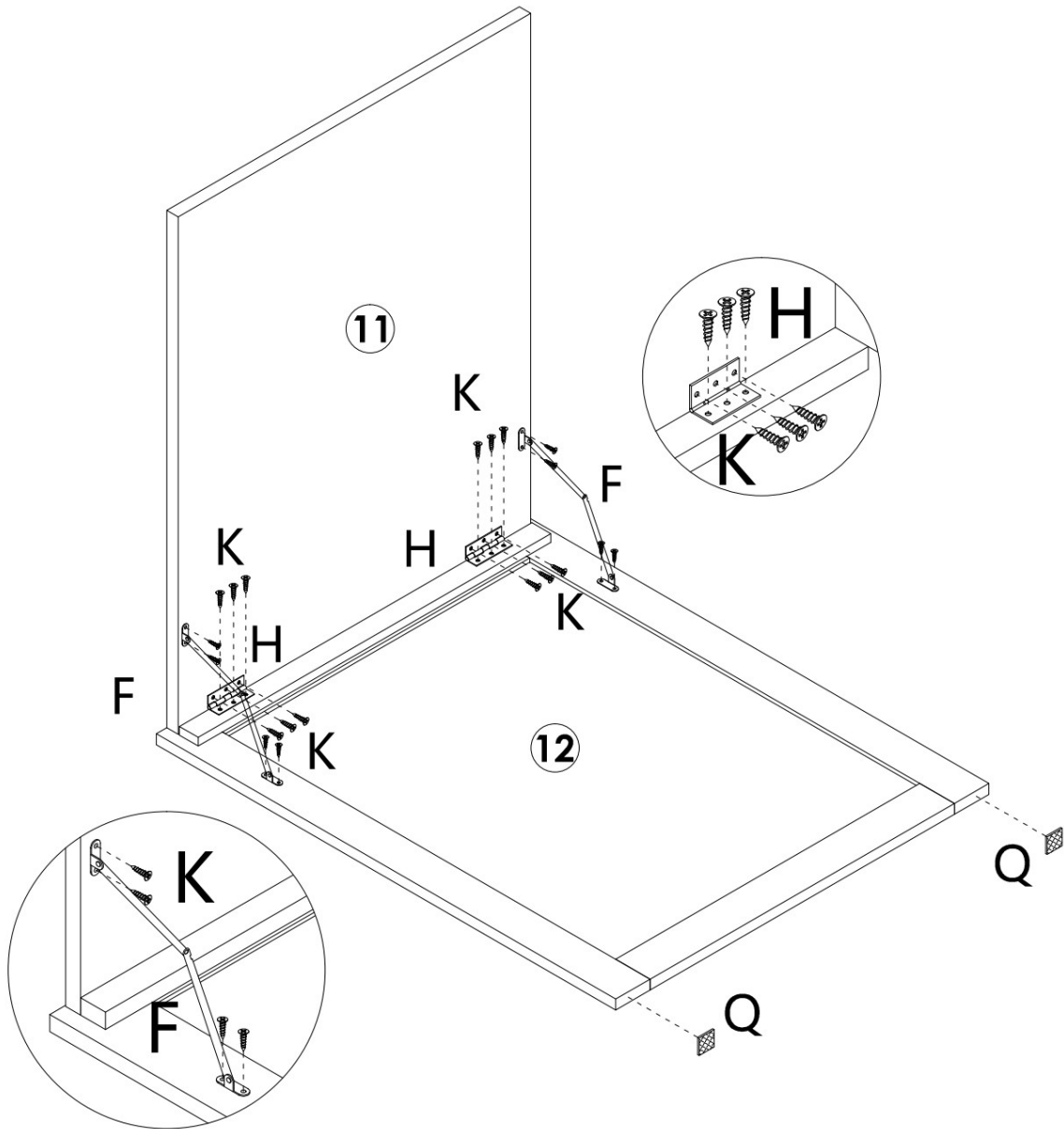

D x 4PCS

STEP 19



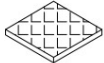

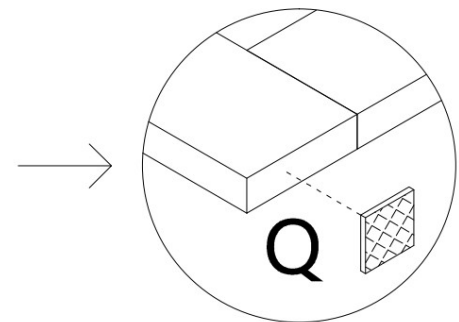
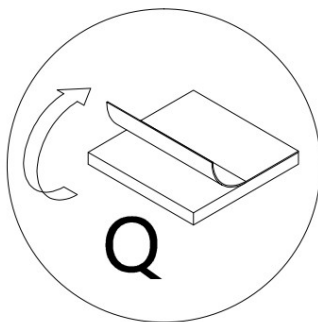
	F x 2PCS
	H x 2PCS
	K x 20PCS
	Q x 2PCS

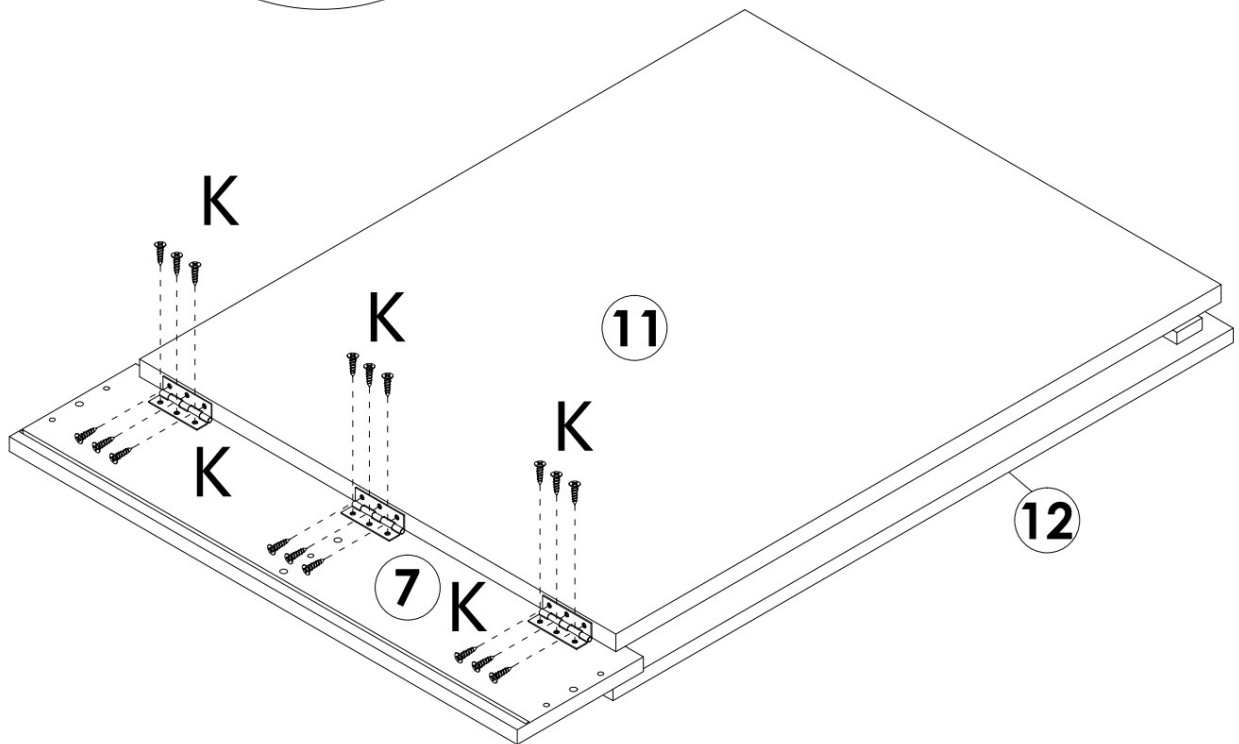
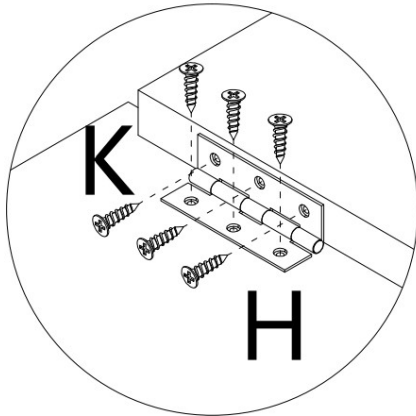

STEP 20



	H x 3PCS
	K x 18PCS

STEP 21

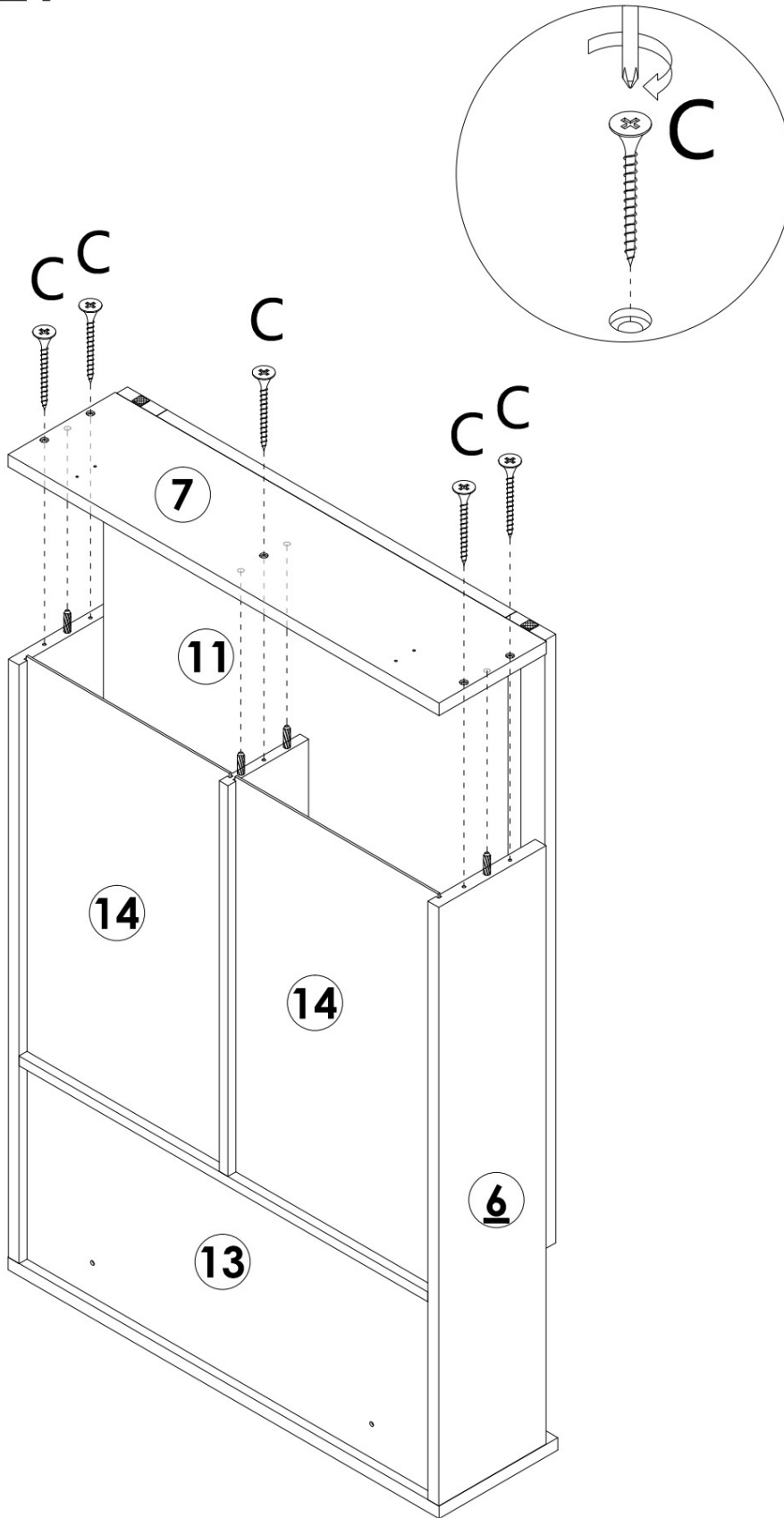

 **C x 5PCS**

STEP 22

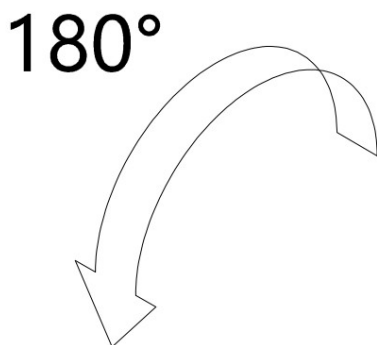
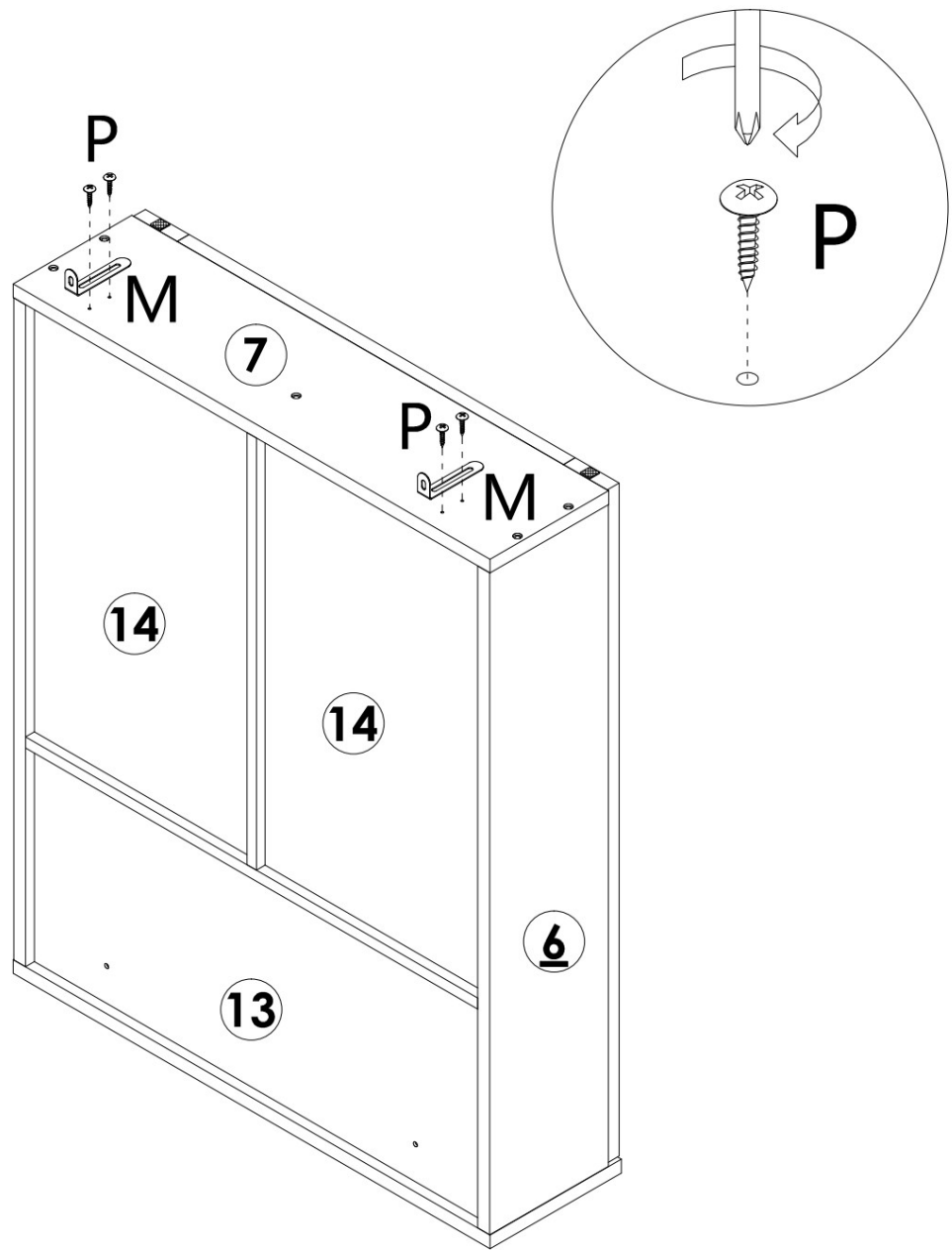

	P x 4PCS
	M x 2PCS

STEP 23

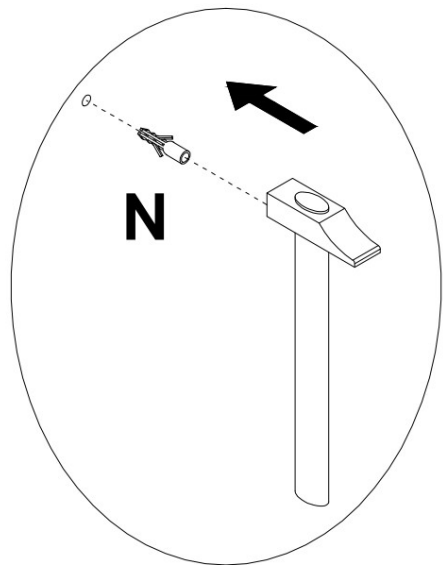
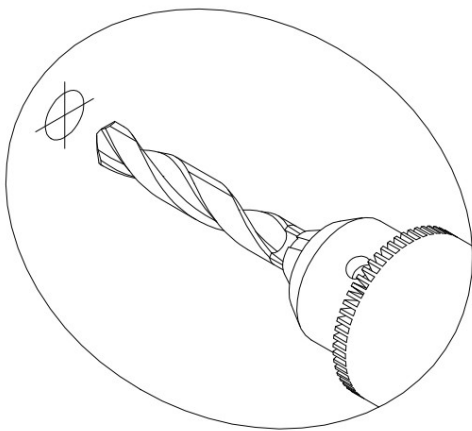
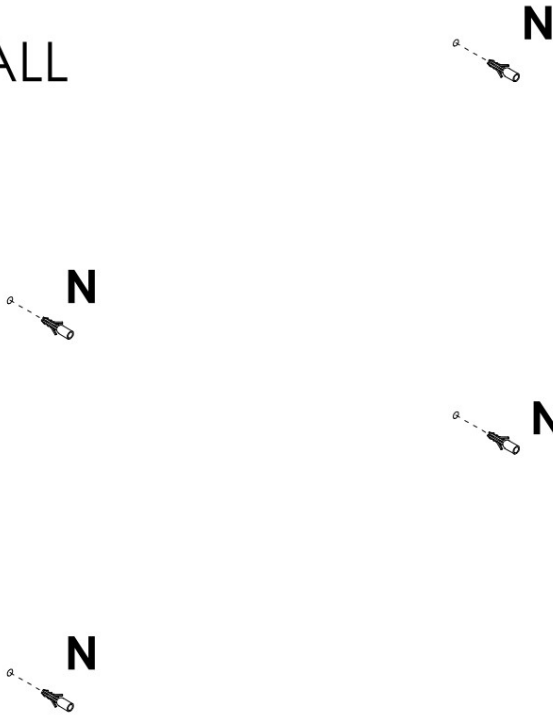

WALL

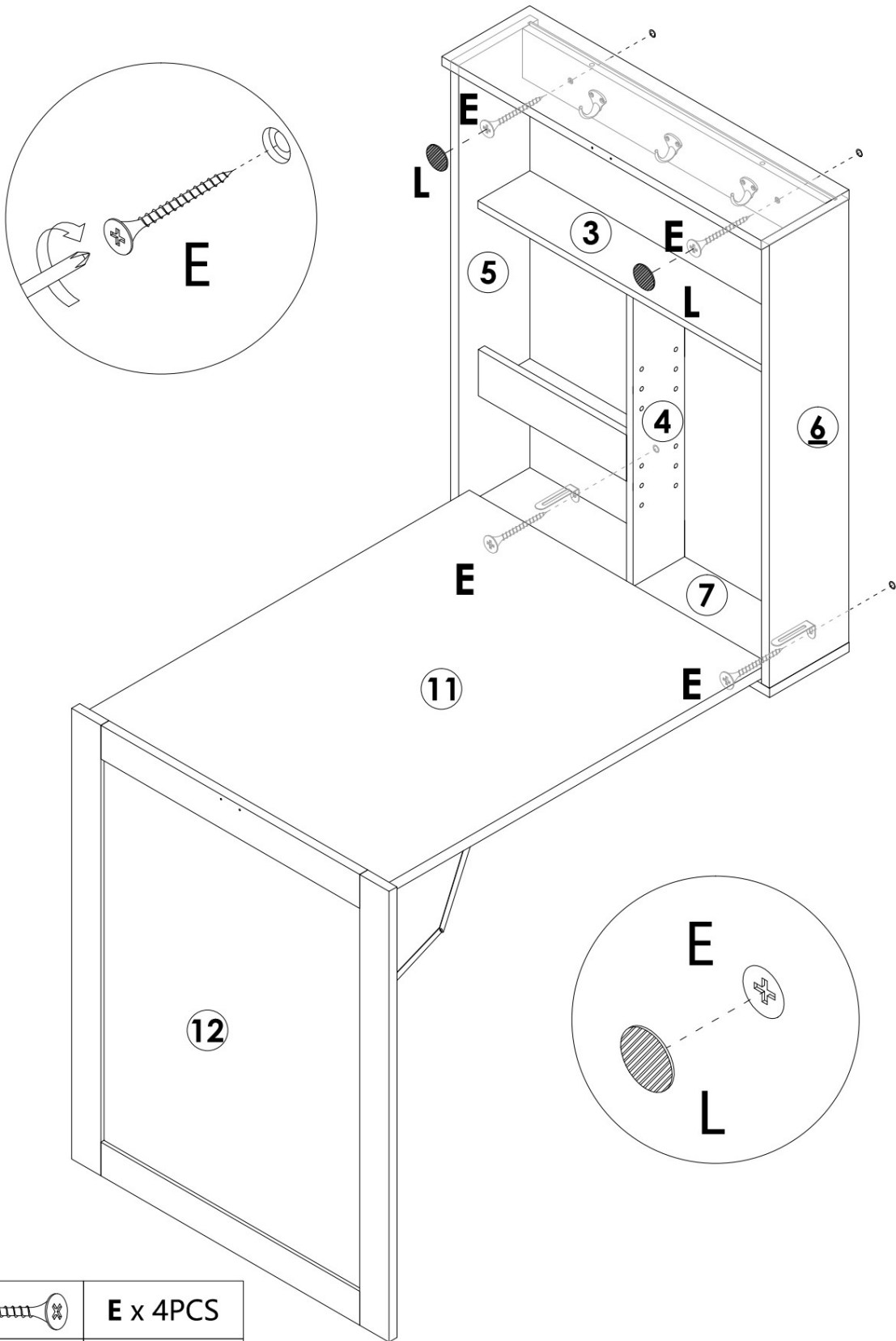

N x 4PCS

STEP 24

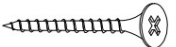

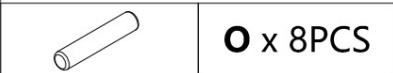
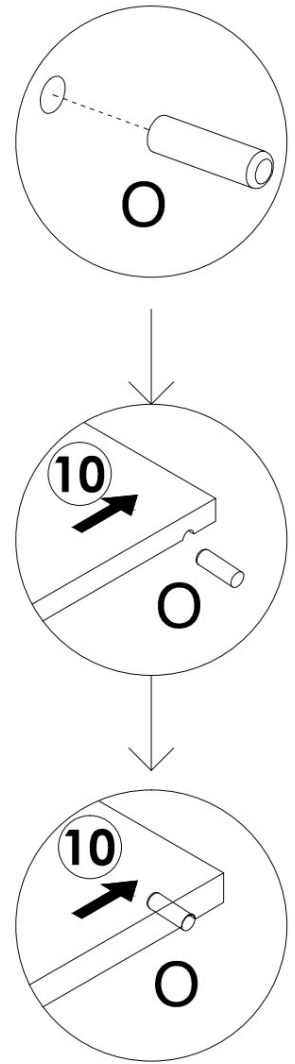
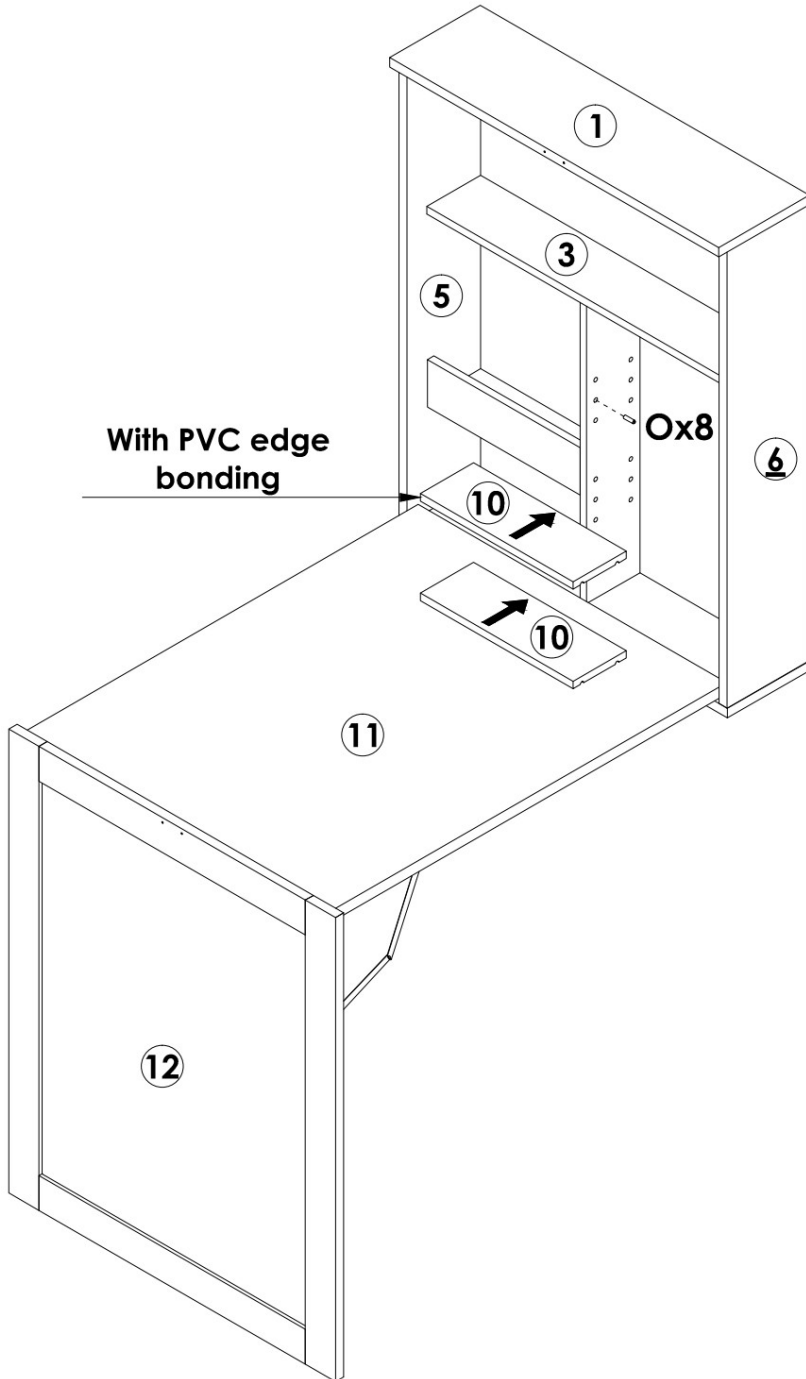

	E x 4PCS
	L x 2PCS

STEP 25

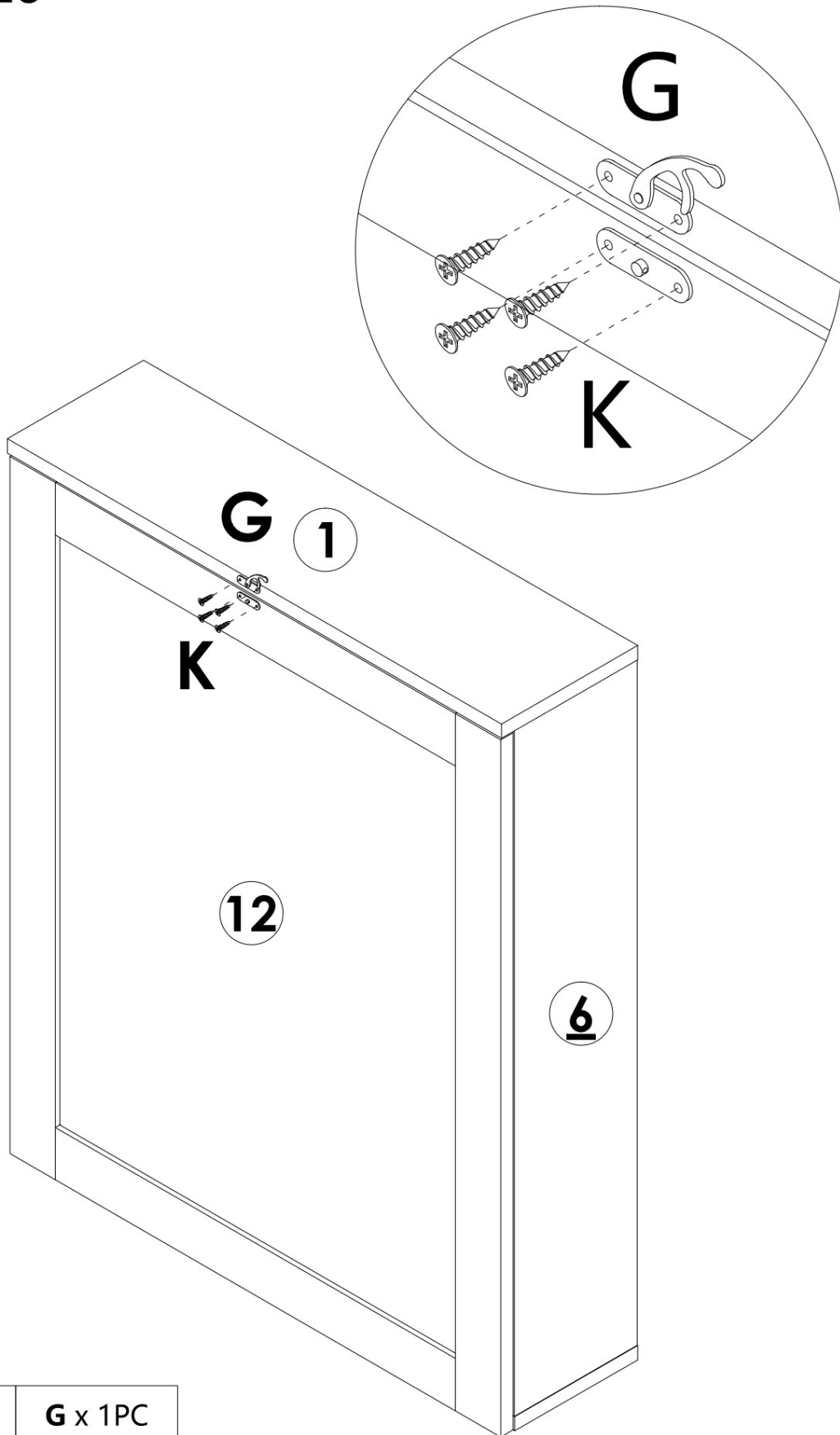

STEP 26



	G x 1PC
	K x 4PCS

FERTIGSTELLUNG

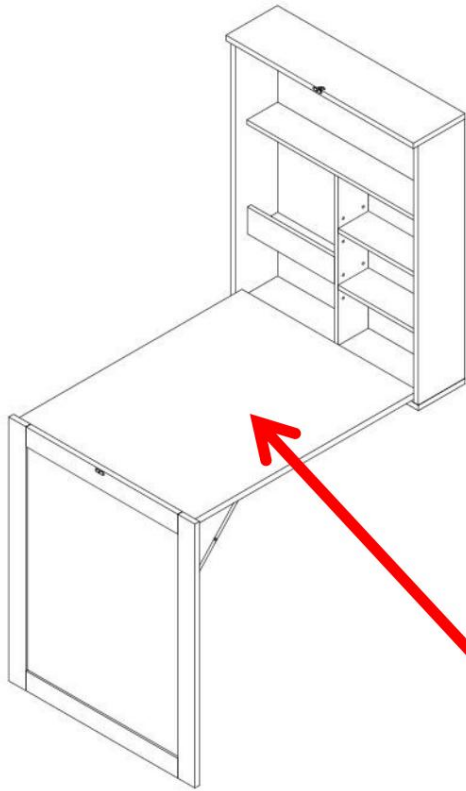

45,35 kg, gleichmäßige Verteilung

PRODUKTPARAMETER

Modell	HZCD003
Sicheres Ladegewicht	45,35 kg
Produktgröße	600*165*1470 mm

Adresse: Shuangchenglu 803nong11hao1602A-1609shi, baoshanqu, Shanghai 200000 CN.

Nach AUS importiert: SIHAO PTY LTD, 1 ROKEVA STREETEASTWOOD NSW 2122 Australien

Importiert in die USA: Sanven Technology Ltd.Suite 250, 9166 Anaheim Place, Rancho Cucamonga, CA 91730

Vertreter der EG

E-CrossStu GmbH.
Mainzer Landstr.69, 60329 Frankfurt am Main.

UK REP

YH CONSULTING LIMITED.
C/O YH Consulting Limited Office 147, Centurion House, London Road, Staines-upon-Thames, Surrey, TW18 4AX

VEVOR®

TOUGH TOOLS, HALF PRICE

Technischer Support und E-Garantie-Zertifikat

www.vevor.com/support

VEVOR[®]

TOUGH TOOLS, HALF PRICE

Supporto tecnico e certificato di garanzia elettronica www.vevor.com/support

SCRIVANIA FLUTTUANTE

MANUALE D'USO

MODELLO:HZCD003

Continuiamo a impegnarci per fornirvi strumenti a prezzi competitivi.

"Risparmia la metà", "Metà prezzo" o qualsiasi altra espressione simile da noi utilizzata rappresenta solo una stima del risparmio che potresti ottenere acquistando determinati utensili con noi rispetto ai principali marchi principali e non necessariamente intende coprire tutte le categorie di utensili da noi offerti. Ti ricordiamo cortesemente di verificare attentamente quando effettui un ordine con noi se stai effettivamente risparmiando la metà rispetto ai principali marchi principali.

VEVOR[®]
TOUGH TOOLS, HALF PRICE

SCRIVANIA FLUTTUANTE

MODELLO:HZCD003



HAI BISOGNO DI AIUTO? CONTATTACI!

Hai domande sui prodotti? Hai bisogno di supporto tecnico? Non esitare a contattarci:

**Supporto tecnico e certificato di garanzia
elettronica www.vevor.com/support**

Questa è l'istruzione originale, si prega di leggere attentamente tutte le istruzioni del manuale prima di utilizzare. VEVOR si riserva una chiara interpretazione del nostro manuale utente. L'aspetto del prodotto sarà soggetto al prodotto ricevuto. Vi preghiamo di perdonarci se non vi informeremo di nuovo se ci sono aggiornamenti tecnologici o software sul nostro prodotto.

ISTRUZIONI DI SICUREZZA

AVVERTIMENTO:

Leggere questo materiale prima di utilizzare questo prodotto. La mancata osservanza di questa norma può provocare lesioni gravi.

Precauzioni di montaggio

1. Montare solo secondo queste istruzioni. Un montaggio non corretto può creare pericoli.
2. Indossare occhiali di sicurezza approvati ANSI e guanti da lavoro resistenti durante l'assemblaggio.
3. Mantenere l'area di assemblaggio pulita e ben illuminata.
4. Tenere gli astanti fuori dall'area durante l'assemblea.
5. Non riunirsi quando si è stanchi o sotto l'effetto di alcol, droghe o farmaci.
6. Le capacità del prodotto si applicano a prodotti correttamente e completamente assemblati solo prodotti.
7. Montare su una superficie piana, livellata, dura e liscia in grado di sostenere in modo sicuro a supporto della Floating Desk.
8. Per ulteriori informazioni sulle parti elencate di seguito pagine, fare riferimento allo schema di montaggio di questo manuale. Disimballare e separare tutte le parti in un'area di lavoro pulita.









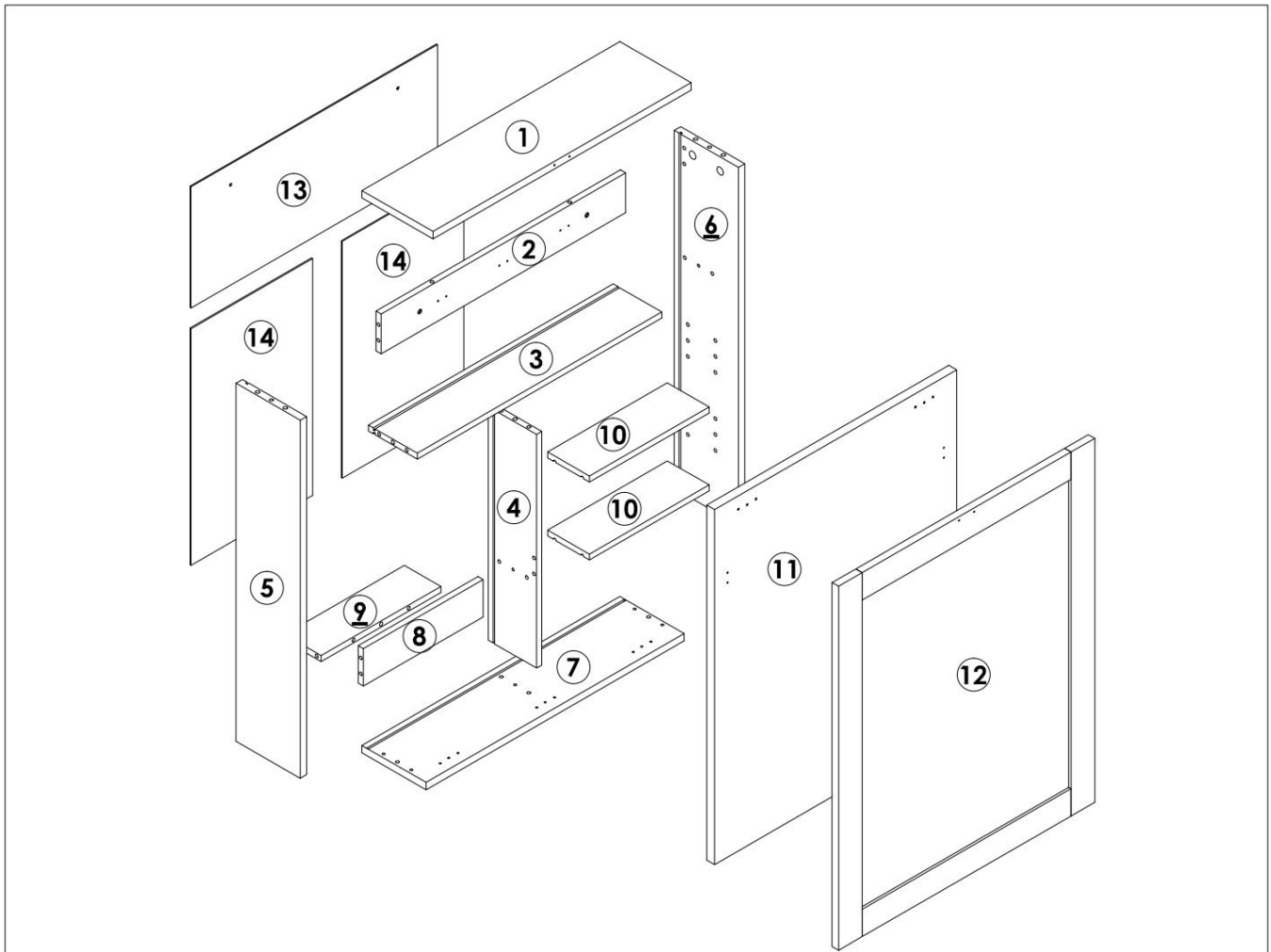

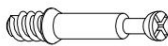



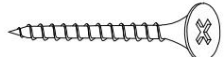
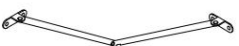

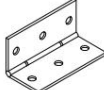
Usare precauzioni

1. NON SEDERSI O STARE IN PIEDI SU QUESTO OGGETTO.
2. Questo prodotto non è un giocattolo. Non permettere ai bambini di giocare con o vicino a questo articolo.
3. Non superare la capacità di peso.
4. Utilizzare solo come previsto.
5. Ispezionare prima di ogni utilizzo; non utilizzare se alcune parti sono allentate o danneggiate.

SALVA QUESTO MANUALE

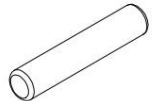
ELENCO DELLE PARTI

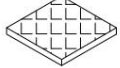

<p>A</p>  <p>M6x35mm 10+1PCS</p>	<p>B</p>  <p>Ø15x9mm 10+1PCS</p>	<p>C</p>  <p>M4x40mm 5PCS</p>	<p>D</p>  <p>Ø6x30mm 30+2PCS</p>	<p>E</p>  <p>M5x60mm 4PCS</p>
<p>F</p>  <p>2PCS</p>	<p>G</p>  <p>1PC</p>	<p>H</p>  <p>5PCS</p>	<p>I</p>  <p>3PCS</p>	<p>J</p>  <p>M3x14mm 6PCS</p>
<p>K</p>  <p>M3x12mm 42+2PCS</p>	<p>L</p>  <p>Ø20mm 7PCS</p>	<p>M</p>  <p>2PCS</p>	<p>N</p>  <p>M8x40mm 4PCS</p>	<p>O</p>  <p>M5x20mm 8+1PCS</p>
<p>P</p>  <p>M4x12mm 4PCS</p>	<p>Q</p>  <p>16x16mm 2PCS</p>	<p>R</p>  <p>1PC</p>		

ISTRUZIONI

STEP 1

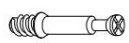
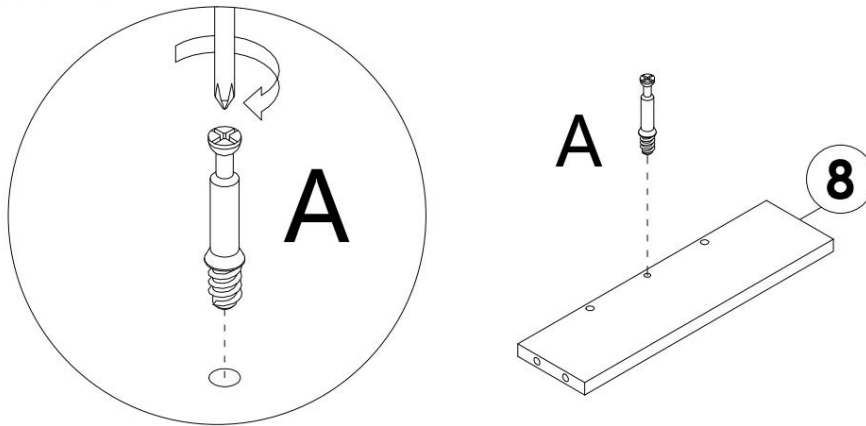

A x 1PC

STEP 2

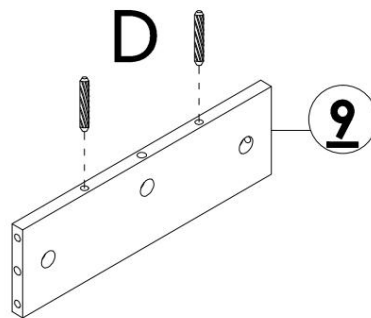

D x 2PCS

STEP 3

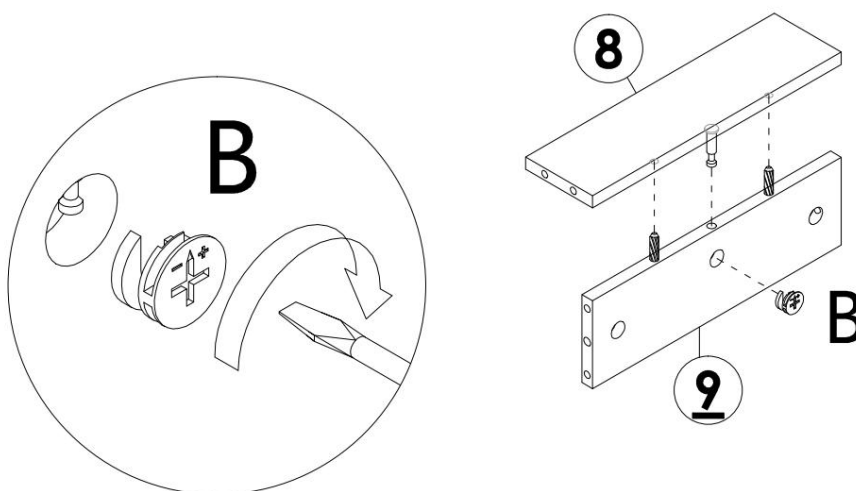

B x 1PC

STEP 4

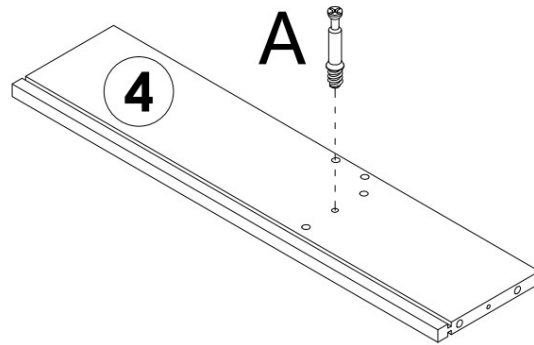
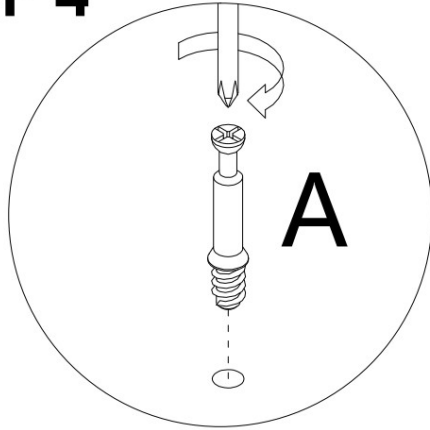

A x 1PC

STEP 5

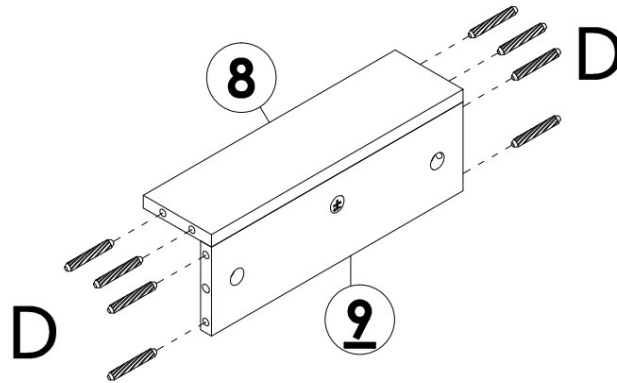

D x 8PCS

STEP 6

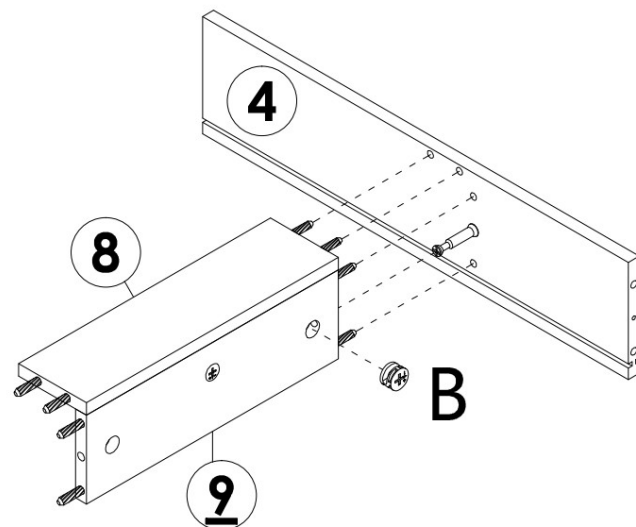
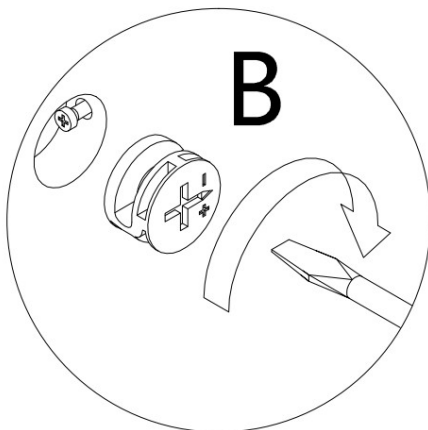

B x 1PC

STEP 7

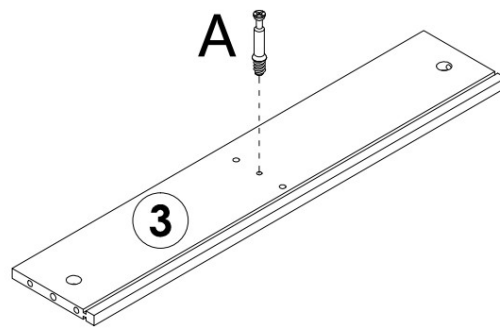
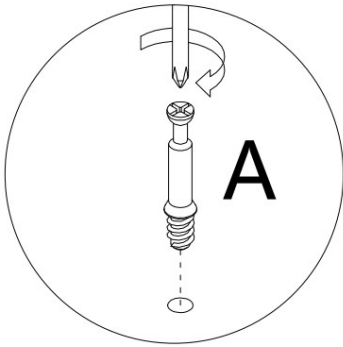

A x 1PC

STEP 8

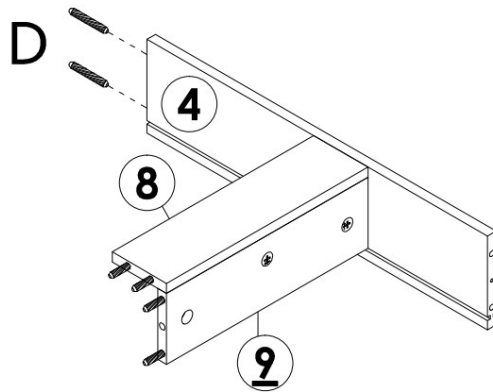

D x 2PCS

STEP 9

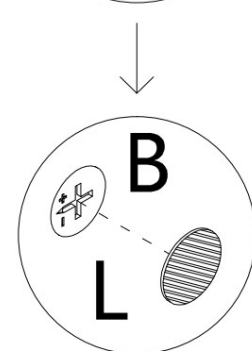
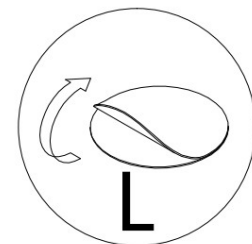
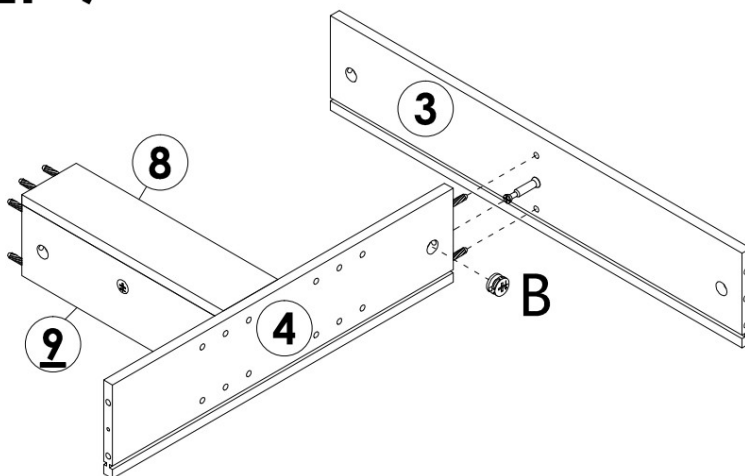



B x 1PC

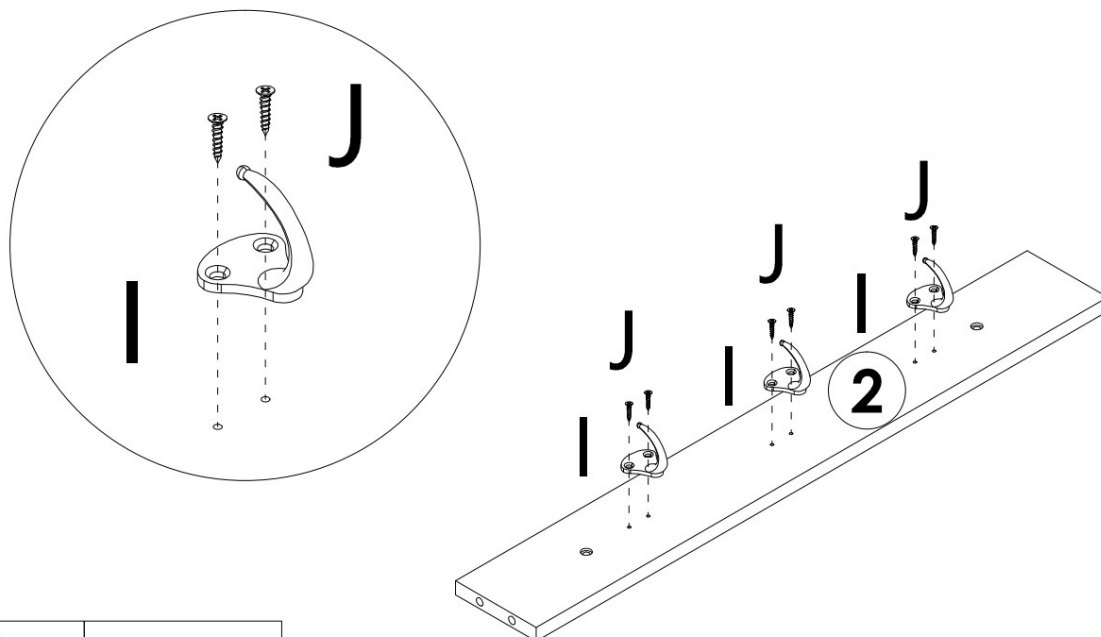

L x 1PC

STEP 10

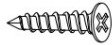

	I x 3PCS
	J x 6PCS

STEP 11

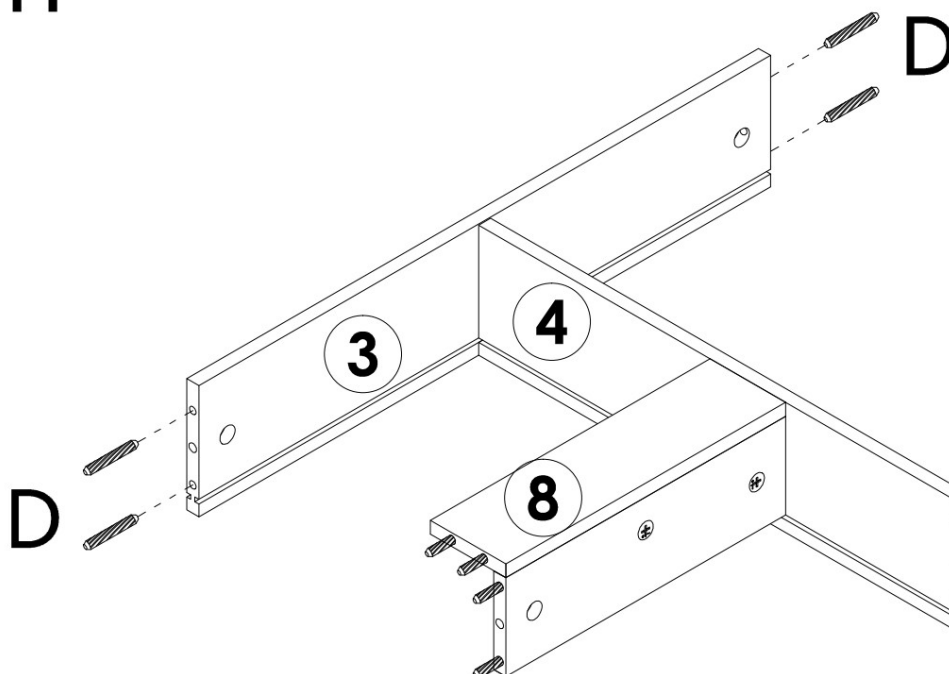

	D x 4PCS
---	----------

STEP 12

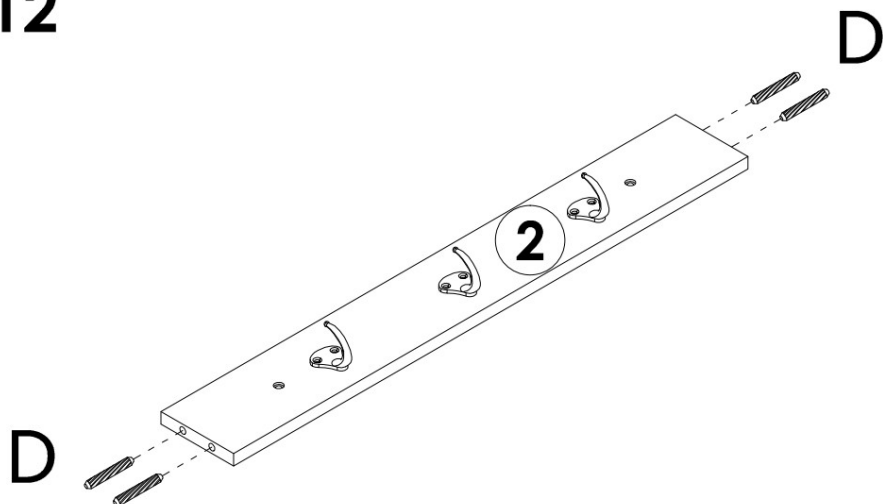

D x 4PCS

STEP 13

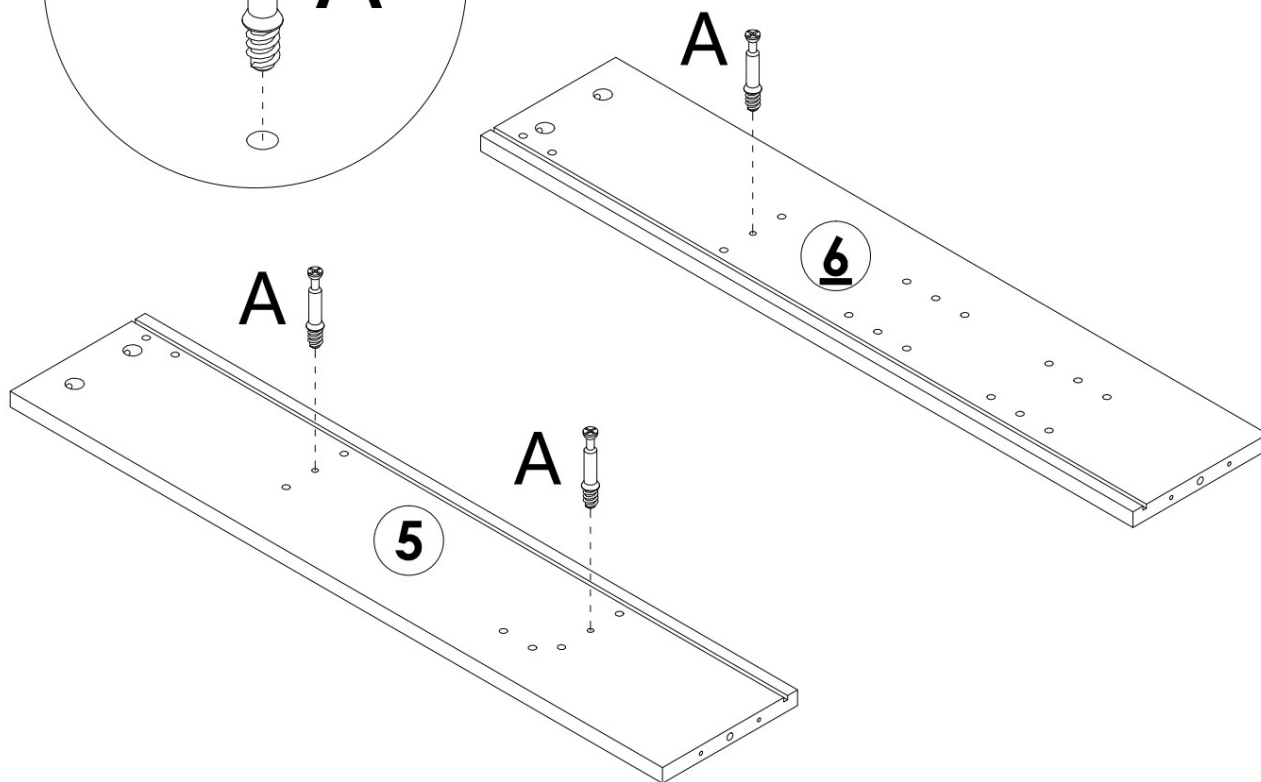
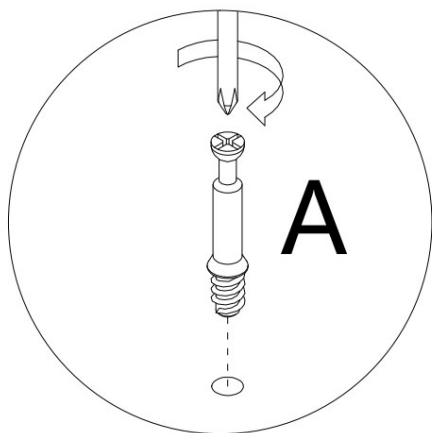

A x 3PCS

STEP 14

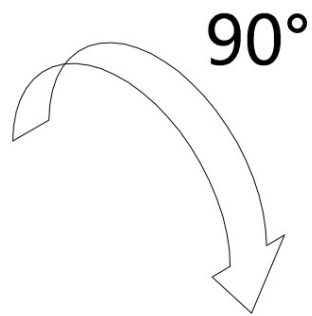
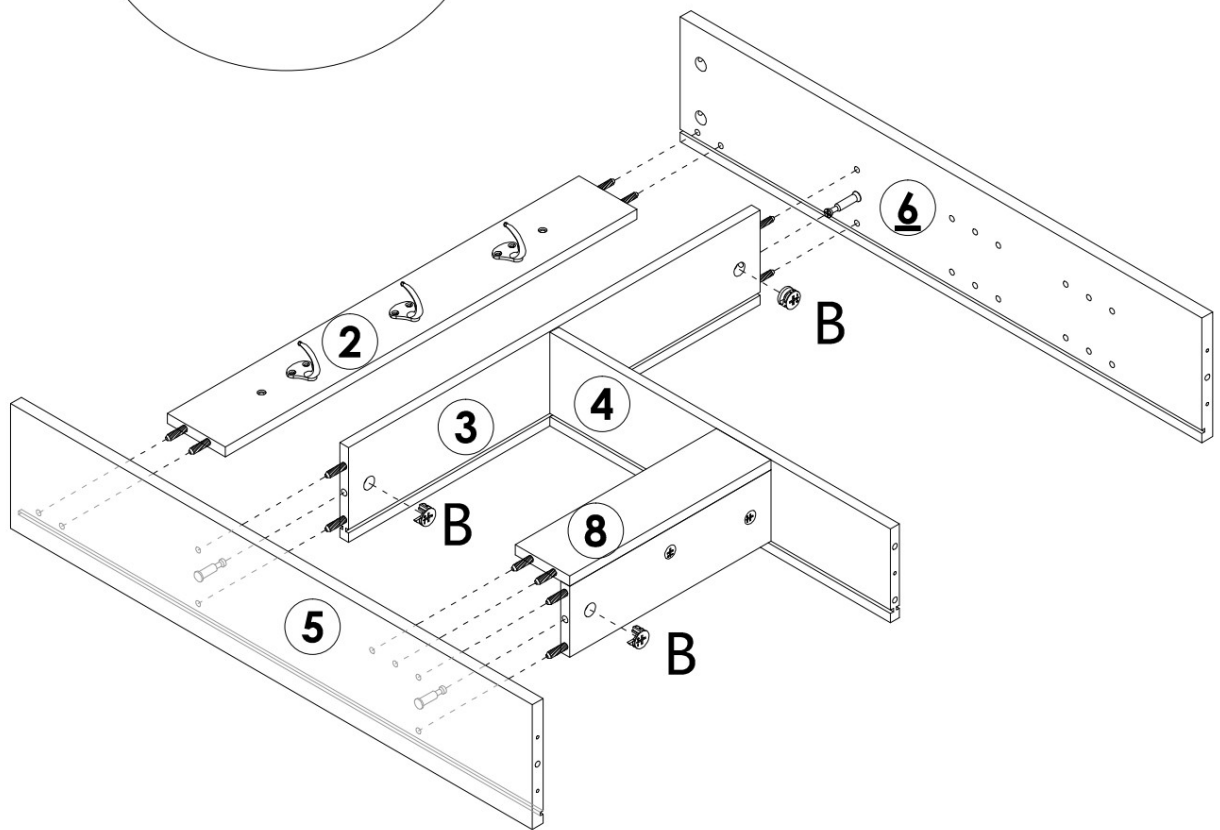
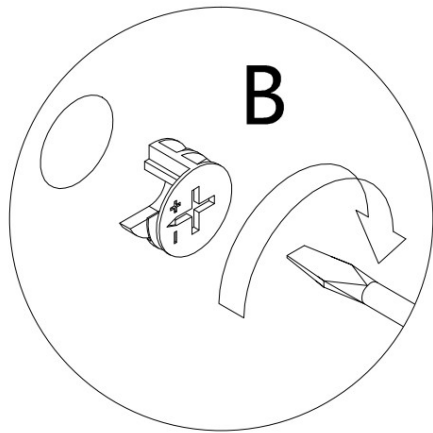

B x 3PCS

STEP 15

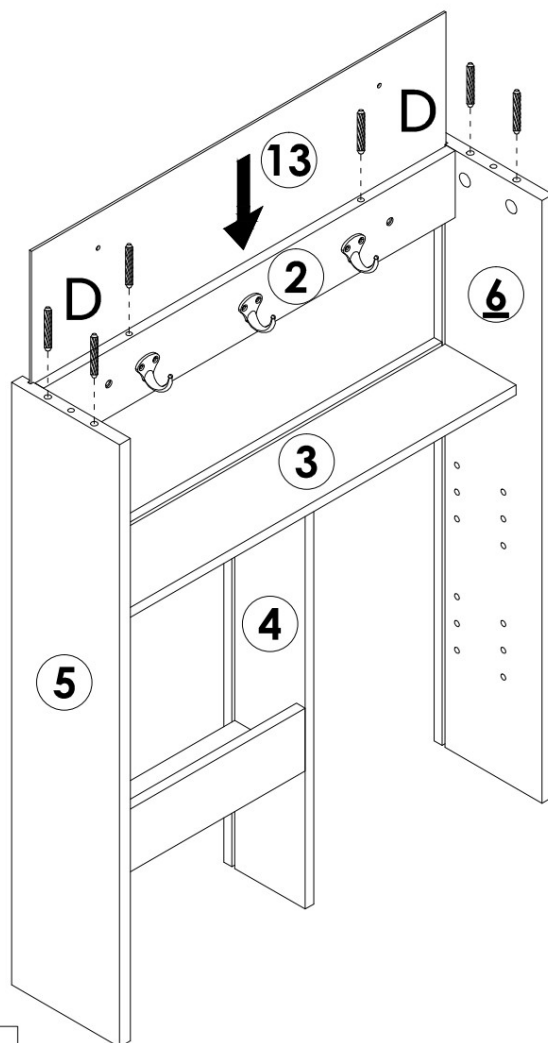

 **D x 6PCS**

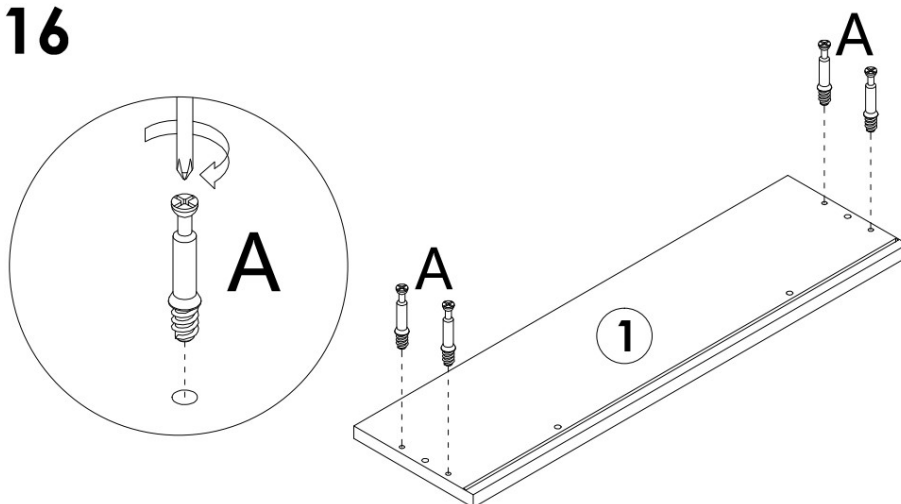

STEP 16

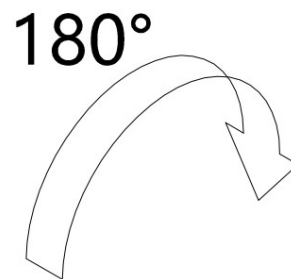
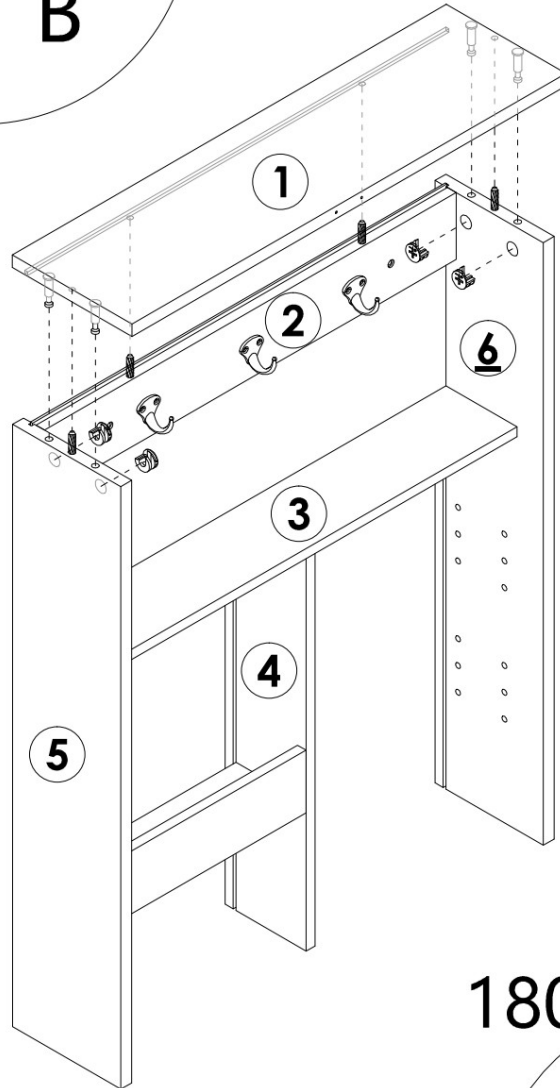
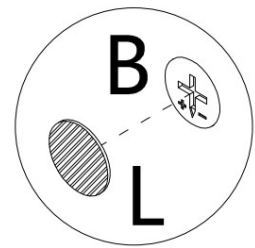
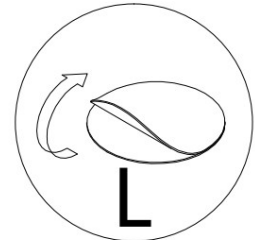
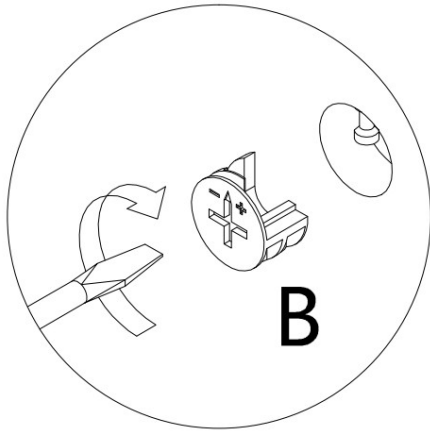

 **A x 4PCS**

STEP 17



	B x 4PCS
	L x 4PCS



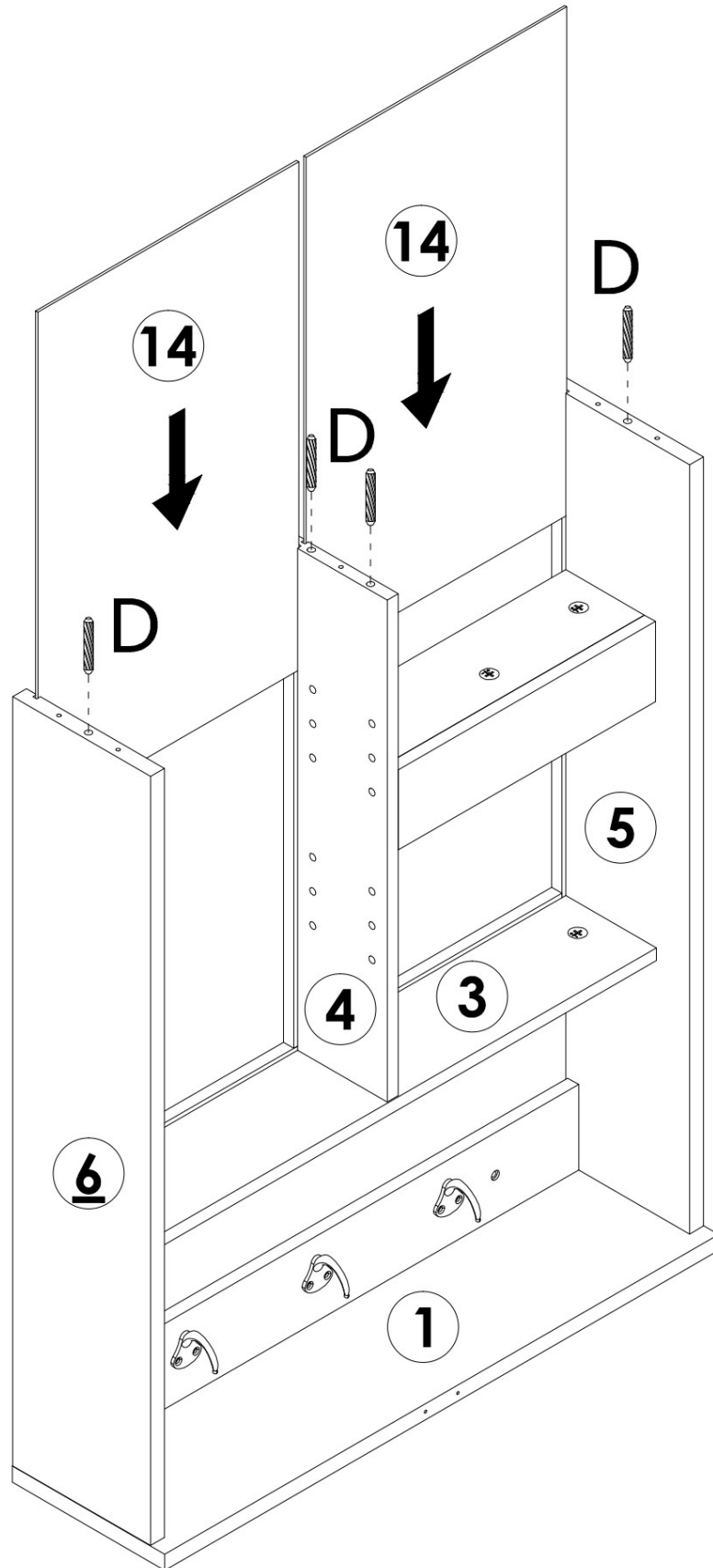

STEP 18

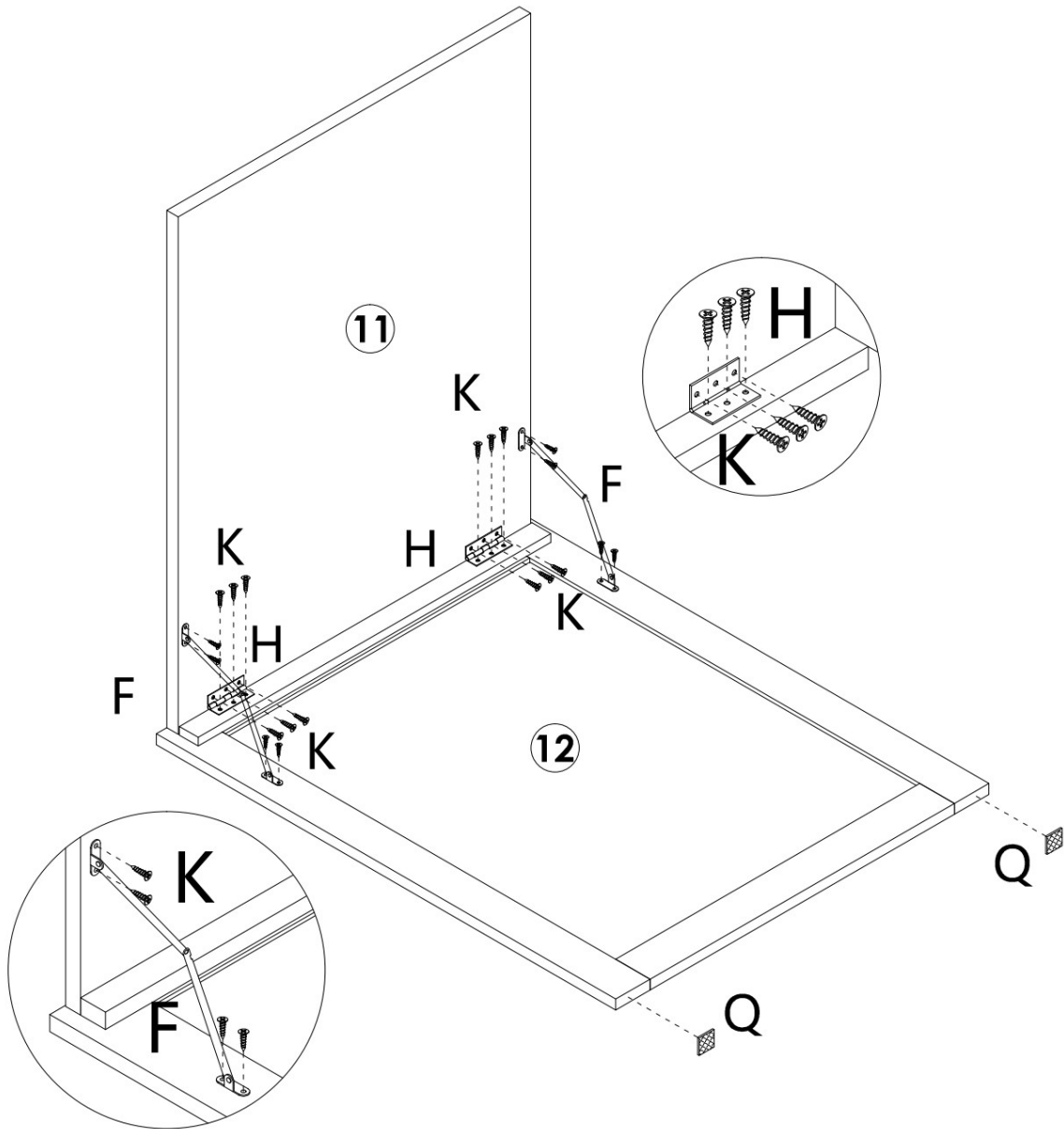

D x 4PCS

STEP 19



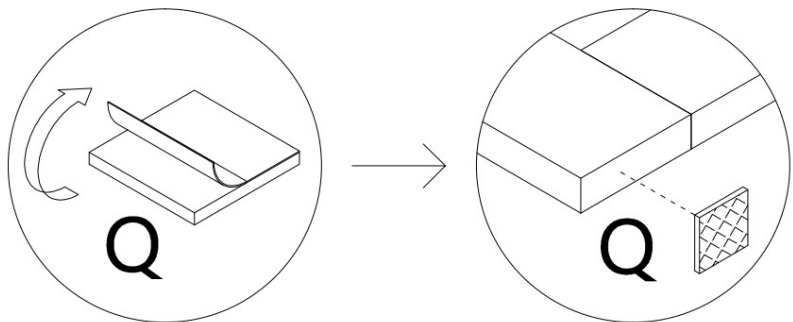

	F x 2PCS
	H x 2PCS
	K x 20PCS
	Q x 2PCS

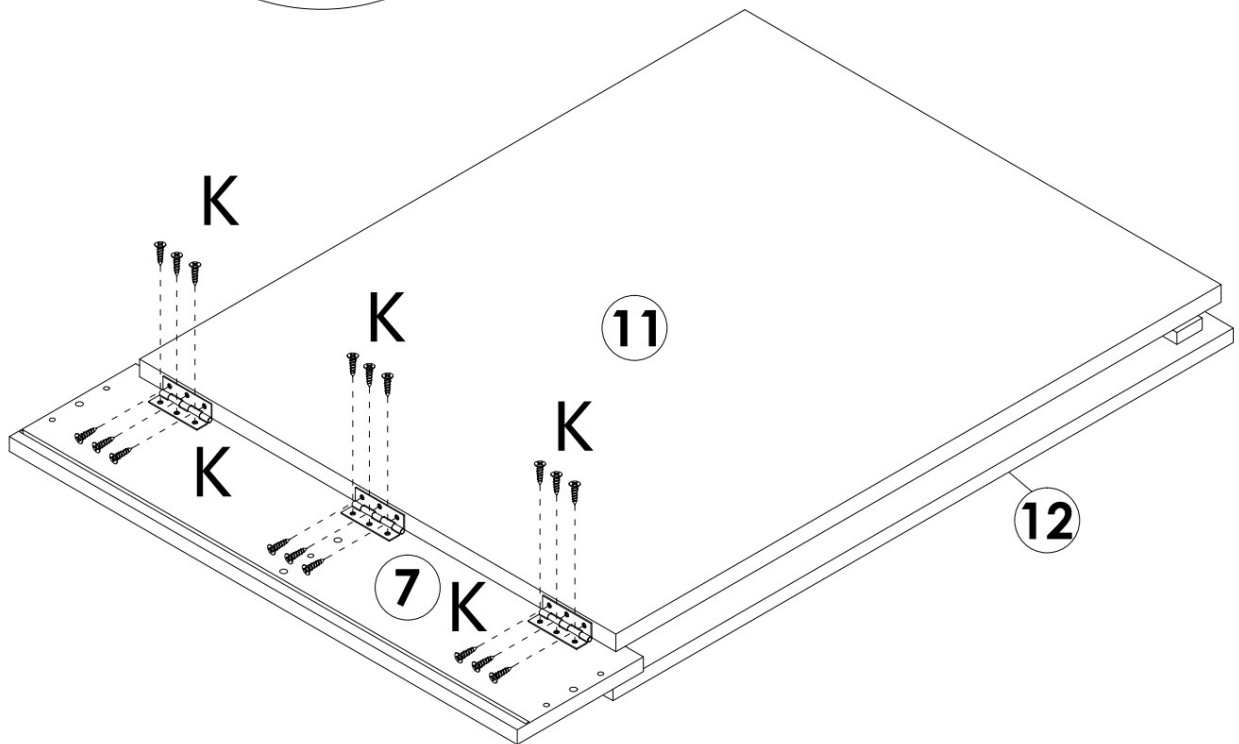
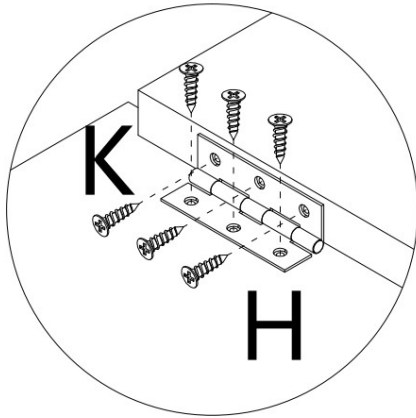

STEP 20



	H x 3PCS
	K x 18PCS

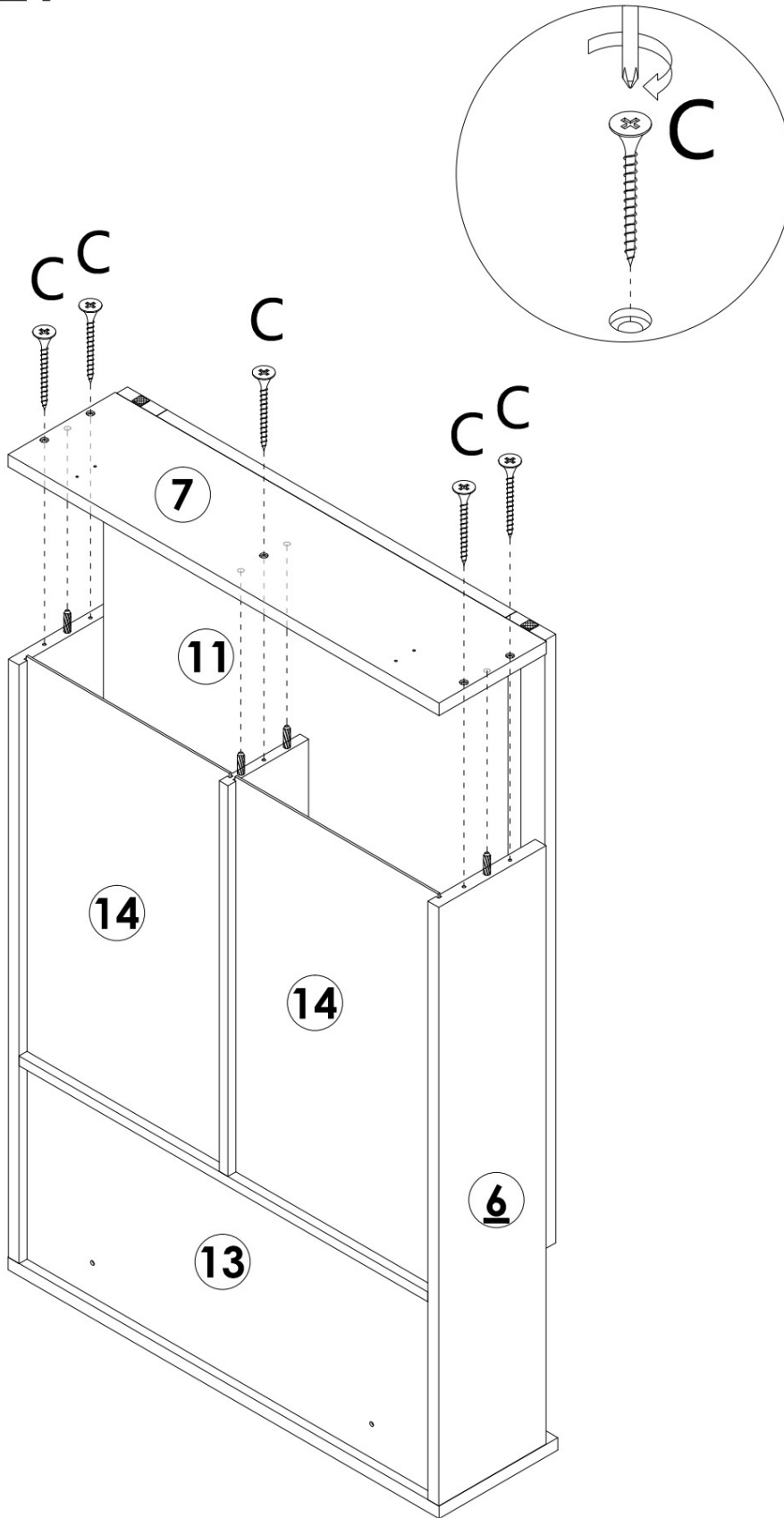

STEP 21

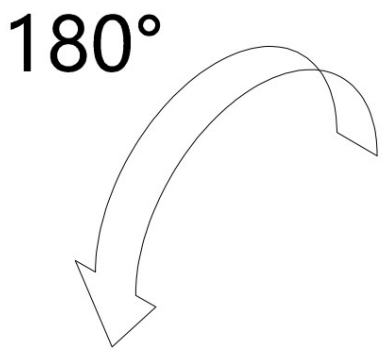
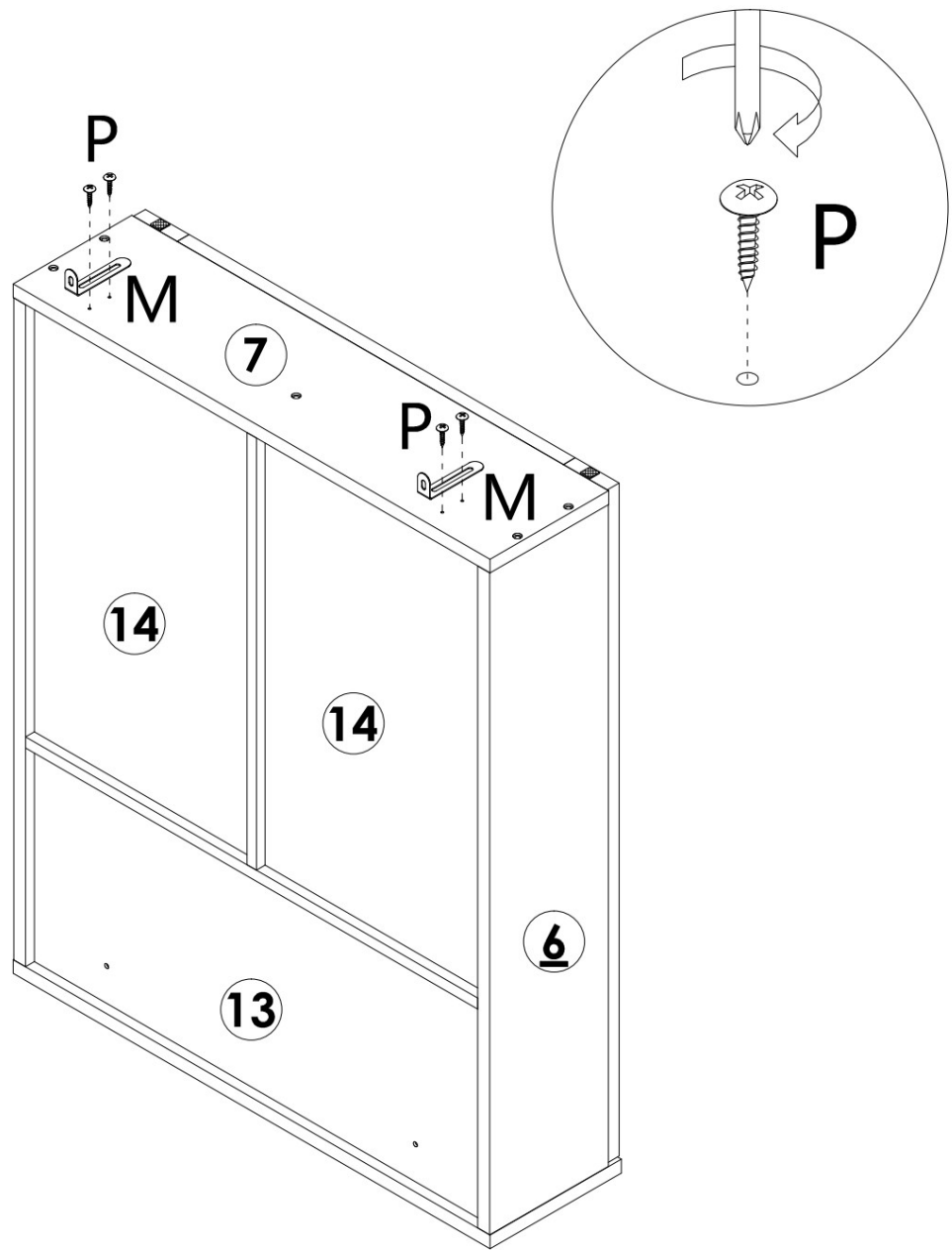

 **C x 5PCS**

STEP 22

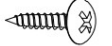

	P x 4PCS
	M x 2PCS

STEP 23

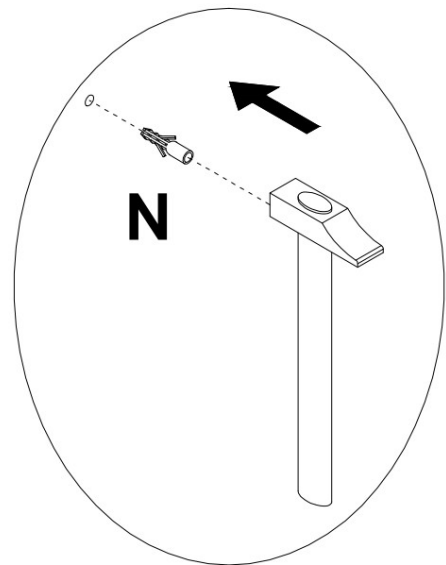
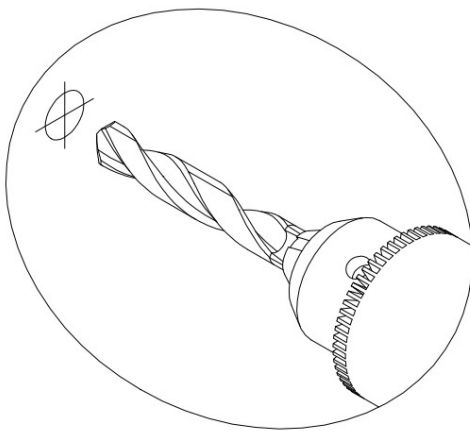
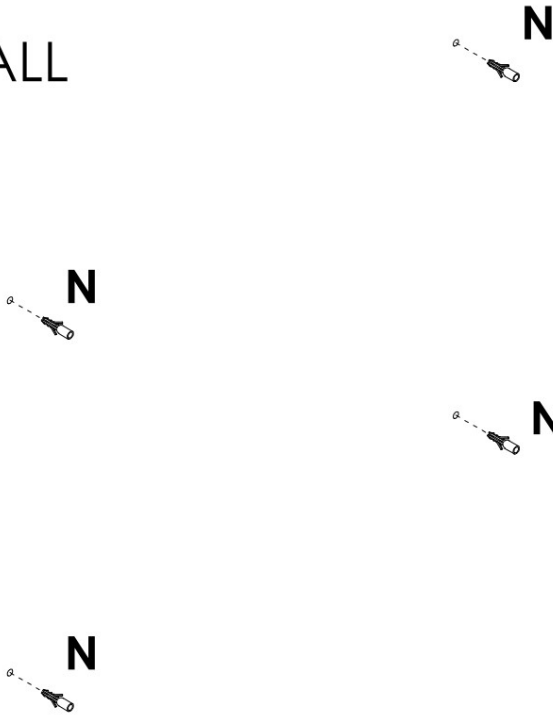

WALL

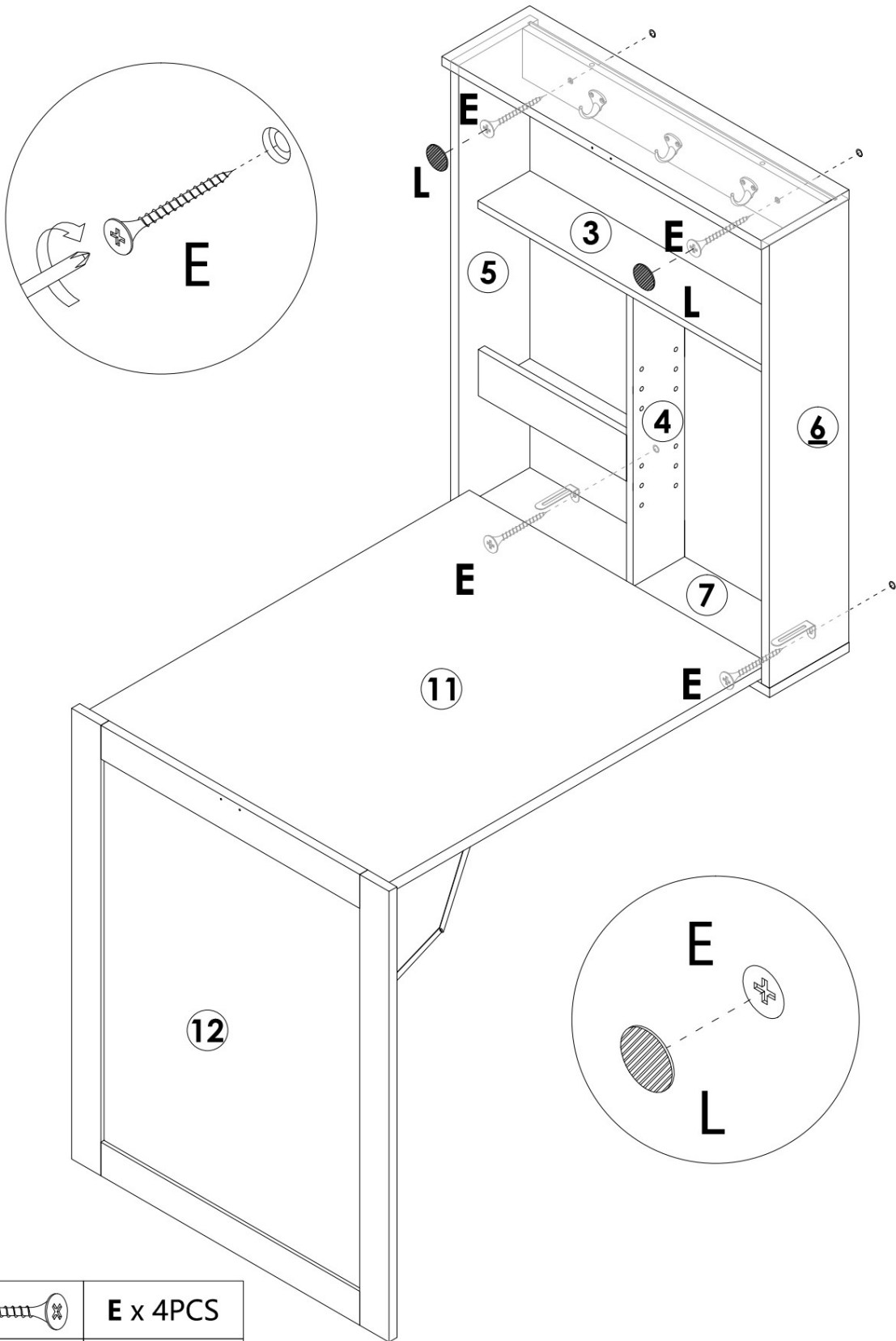

N x 4PCS

STEP 24

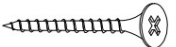

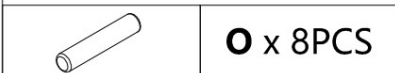
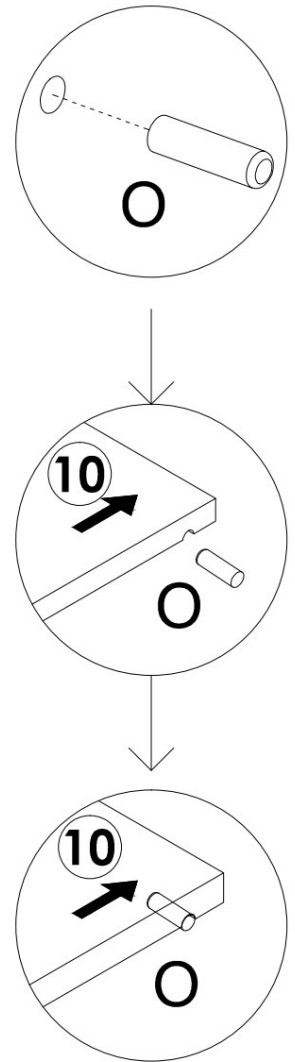
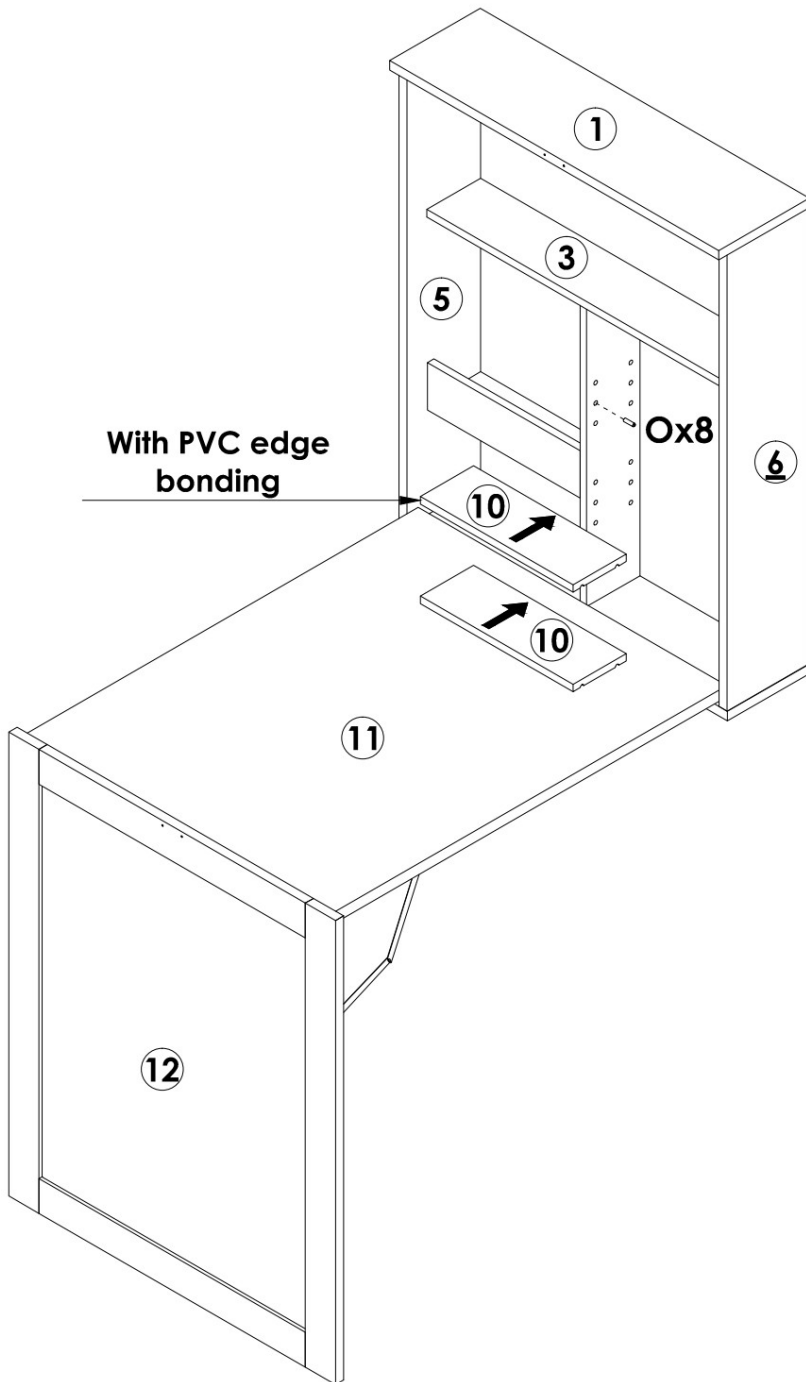

	E x 4PCS
	L x 2PCS

STEP 25

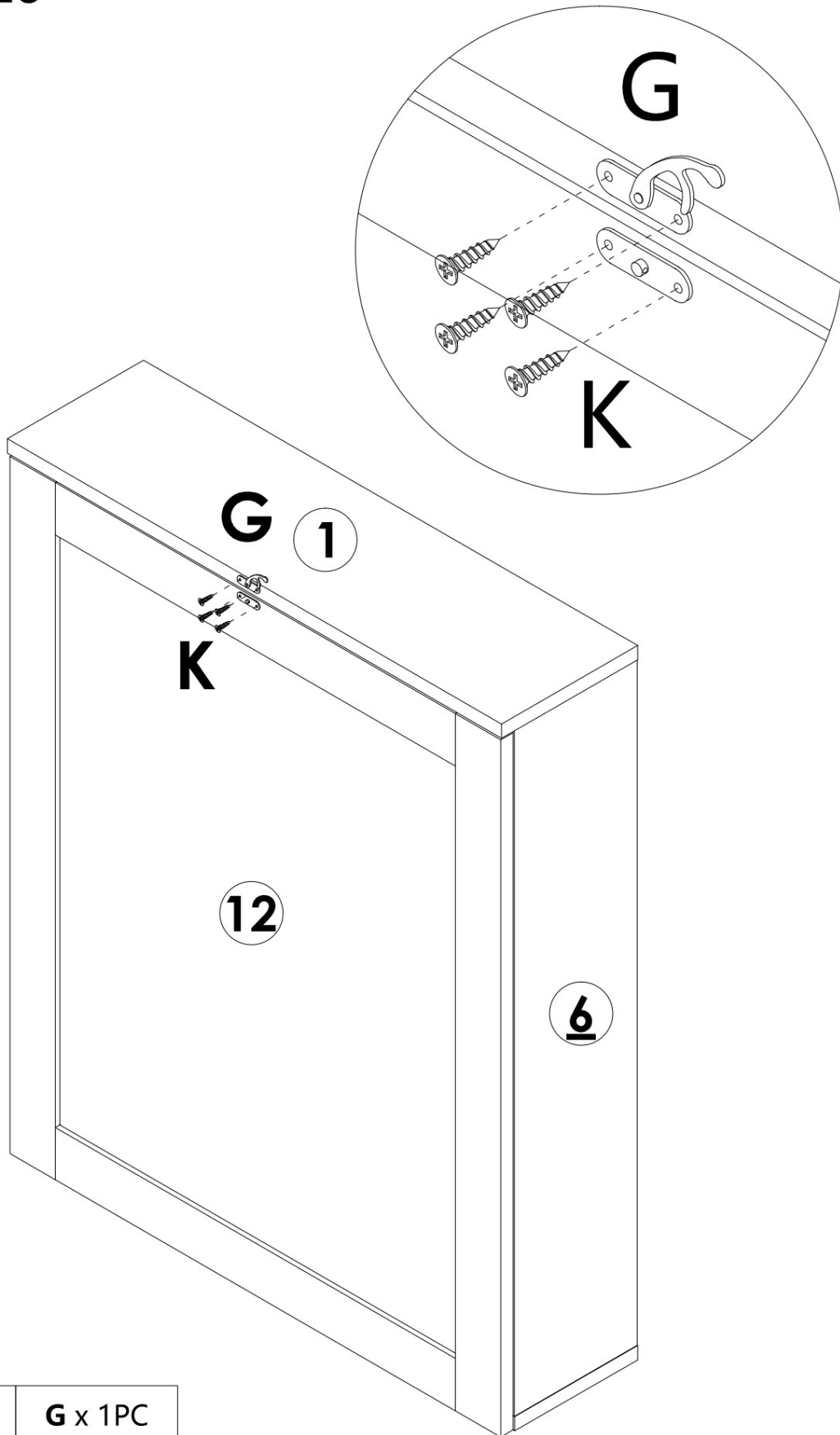

STEP 26



	G x 1PC
	K x 4PCS

COMPLETAMENTO

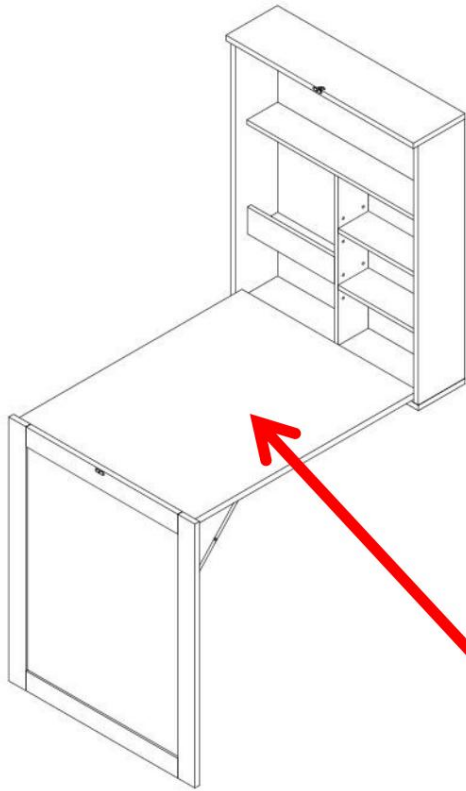

45,35 kg, distribuzione uniforme

PARAMETRO PRODOTTO

Modello	HZCD003
Peso di carico sicuro	45,35 kg
Dimensioni del prodotto	600*165*1470mm

Indirizzo: Shuangchenglu 803nong11hao1602A-1609shi, baoshanqu, shanghai 200000 CN.

Importato in AUS: SIHAO PTY LTD, 1 ROKEVA STREETEASTWOOD

Nuovo Galles del Sud 2122 Australia

Importato negli USA: Sanven Technology Ltd. Suite 250, 9166 Anaheim Place, Rancho Cucamonga, CA 91730

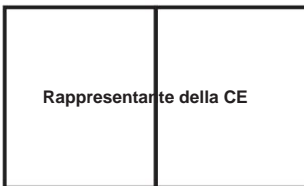

E-CrossStu GmbH.
Mainzer Landstr.69, 60329 Francoforte sul Meno.



CONSULENZA YH LIMITATA.
C/O YH Consulting Limited Ufficio 147, Centurion House,
Via Roma, 101, 00186 Roma, Italia

VEVOR®
TOUGH TOOLS, HALF PRICE

Supporto tecnico e certificato di garanzia
elettronica www.vevor.com/support

VEVOR[®]

TOUGH TOOLS, HALF PRICE

Soporte técnico y certificado de garantía electrónica www.vevor.com/support

ESCRITORIO FLOTANTE

MANUAL DEL USUARIO

MODELO:HZCD003

Seguimos comprometidos a brindarle herramientas a precios competitivos.

"Ahorre la mitad", "mitad de precio" o cualquier otra expresión similar que utilicemos solo representa una estimación del ahorro que podría obtener al comprar ciertas herramientas con nosotros en comparación con las principales marcas y no necesariamente significa que cubra todas las categorías de herramientas que ofrecemos. Le recordamos que, al realizar un pedido con nosotros, verifique cuidadosamente si realmente está ahorrando la mitad en comparación con las principales marcas.

VEVOR[®]
TOUGH TOOLS, HALF PRICE

ESCRITORIO FLOTANTE

MODELO:HZCD003

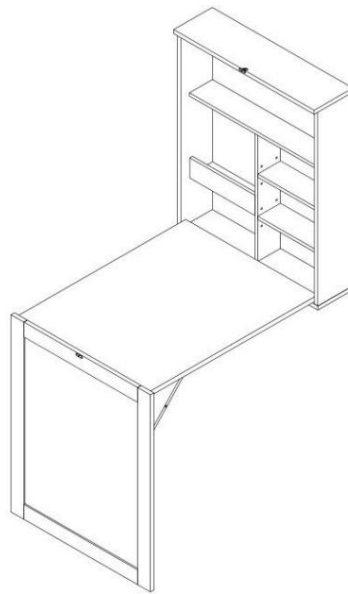

¿NECESITA AYUDA? ¡CONTÁCTENOS!

¿Tiene preguntas sobre el producto? ¿Necesita asistencia técnica? No dude en ponerse en contacto con nosotros:

**Soporte técnico y certificado de garantía
electrónica www.vevor.com/support**

Estas son las instrucciones originales, lea atentamente todas las instrucciones del manual antes de utilizar el producto. VEVOR se reserva una interpretación clara de nuestro manual de usuario. La apariencia del producto estará sujeta al producto que recibió. Perdónenos por no informarle nuevamente si hay actualizaciones de tecnología o software en nuestro producto.

INSTRUCCIONES DE SEGURIDAD

ADVERTENCIA:

Lea este material antes de utilizar este producto. De lo contrario, puede provocar lesiones graves.

Precauciones de montaje

1. Realice el montaje únicamente de acuerdo con estas instrucciones. Un montaje incorrecto puede crear peligros
2. Use gafas de seguridad aprobadas por ANSI y guantes de trabajo resistentes.
Durante el montaje.
3. Mantenga el área de reunión limpia y bien iluminada.
4. Mantenga a los transeúntes fuera del área durante el montaje.
5. No se reúna cuando esté cansado o bajo la influencia del alcohol, drogas o medicamentos.
6. Las capacidades del producto se aplican a productos ensamblados de manera correcta y completa.
Sólo productos.
7. Montar sobre una superficie plana, nivelada, dura y lisa capaz de soportar cargas de forma segura.
apoyando el escritorio flotante.
8. Para obtener información adicional sobre las piezas enumeradas a continuación, páginas, consulte el diagrama de ensamblaje de este manual.
y separar todas las piezas en un área de trabajo limpia.









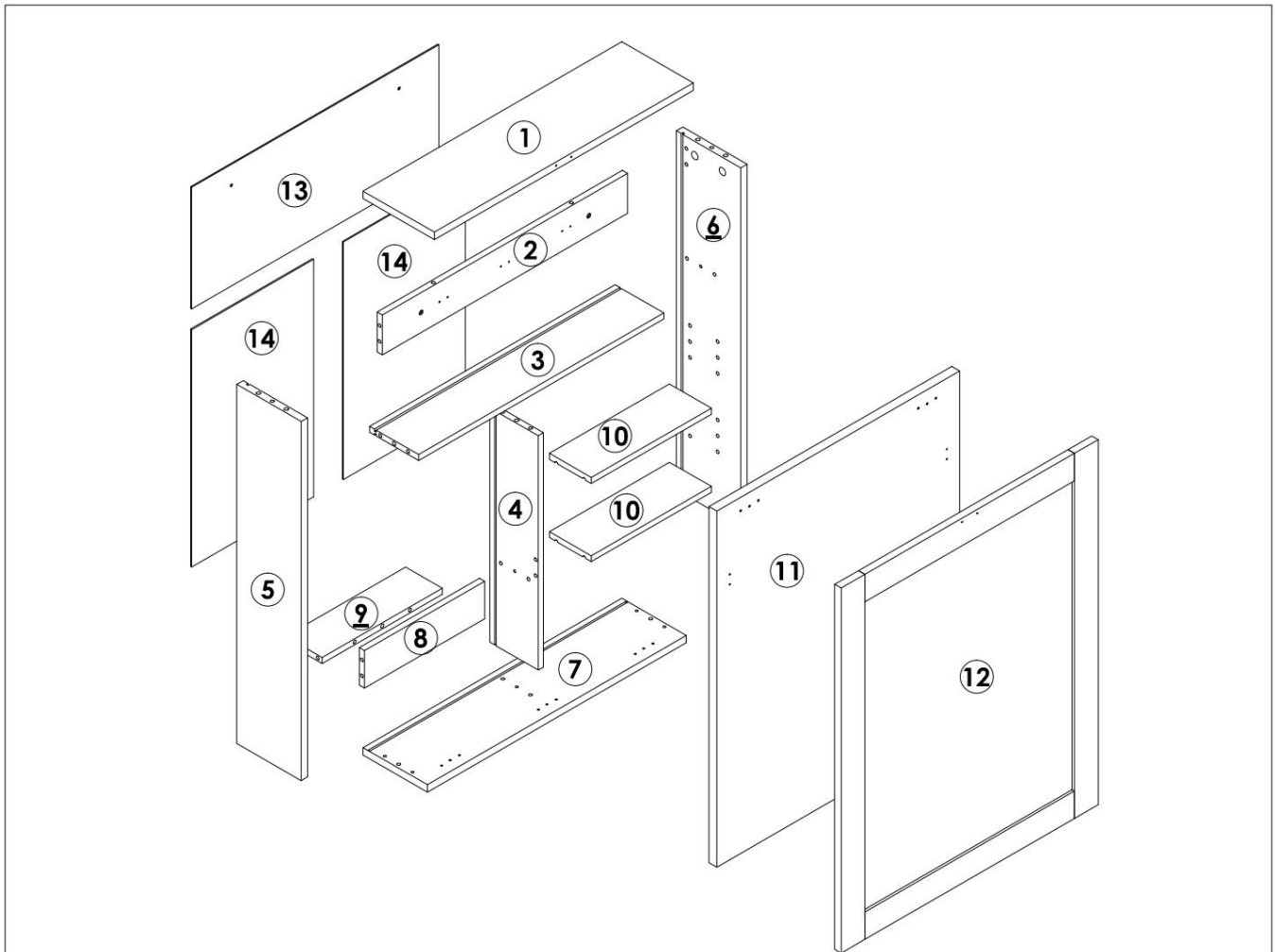

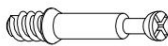



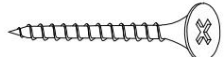
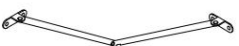

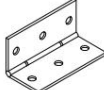
Tome precauciones

1. NO SE SIENTA NI SE PARE SOBRE ESTE ARTÍCULO.
2. Este producto no es un juguete. No permita que los niños jueguen con él o cerca de él.
artículo.
3. No exceda las capacidades de peso.
4. Utilícelo únicamente según lo previsto.
5. Inspeccione antes de cada uso; no utilice si las piezas están sueltas o dañadas.

GUARDE ESTE MANUAL

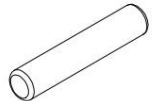
LISTA DE PIEZAS

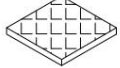

A  M6x35mm 10+1PCS	B  Ø15x9mm 10+1PCS	C  M4x40mm 5PCS	D  Ø6x30mm 30+2PCS	E  M5x60mm 4PCS
F  2PCS	G  1PC	H  5PCS	I  3PCS	J  M3x14mm 6PCS
K  M3x12mm 42+2PCS	L  Ø20mm 7PCS	M  2PCS	N  M8x40mm 4PCS	O  M5x20mm 8+1PCS
P  M4x12mm 4PCS	Q  16x16mm 2PCS	 1PC		

INSTRUCCIONES

STEP 1

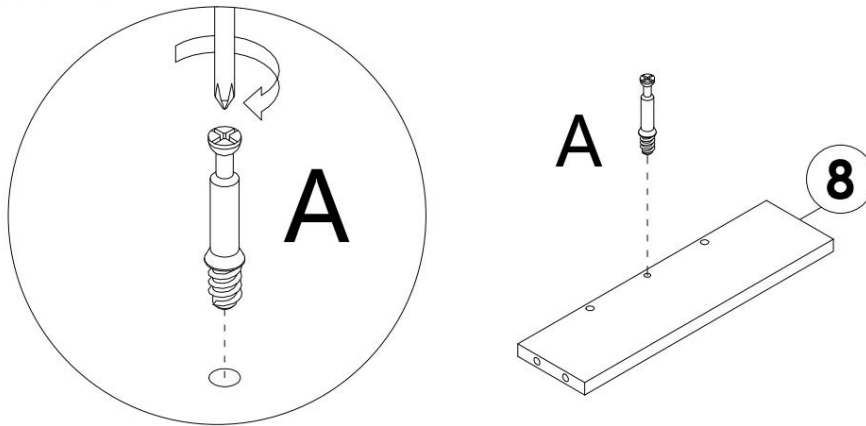

A x 1PC

STEP 2

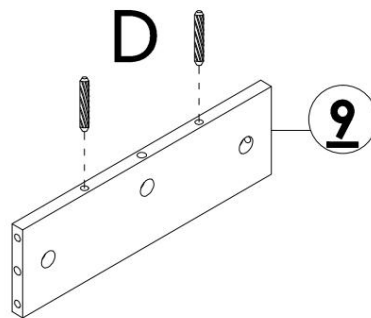

D x 2PCS

STEP 3

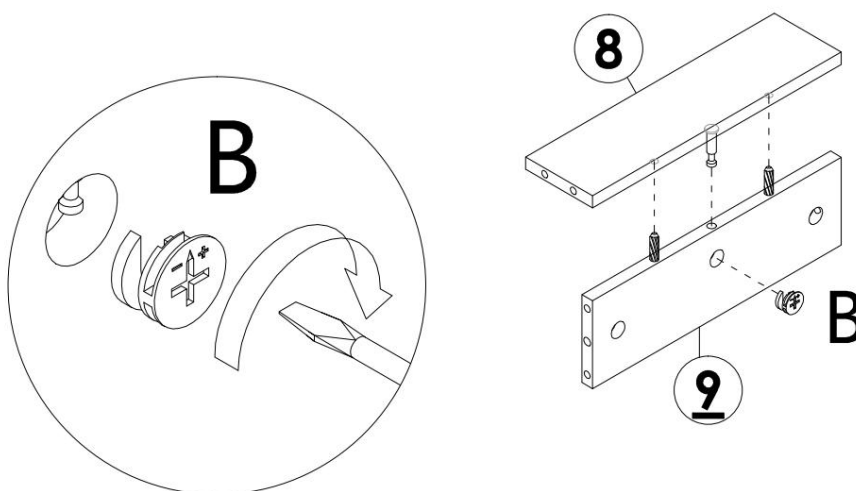

B x 1PC

STEP 4

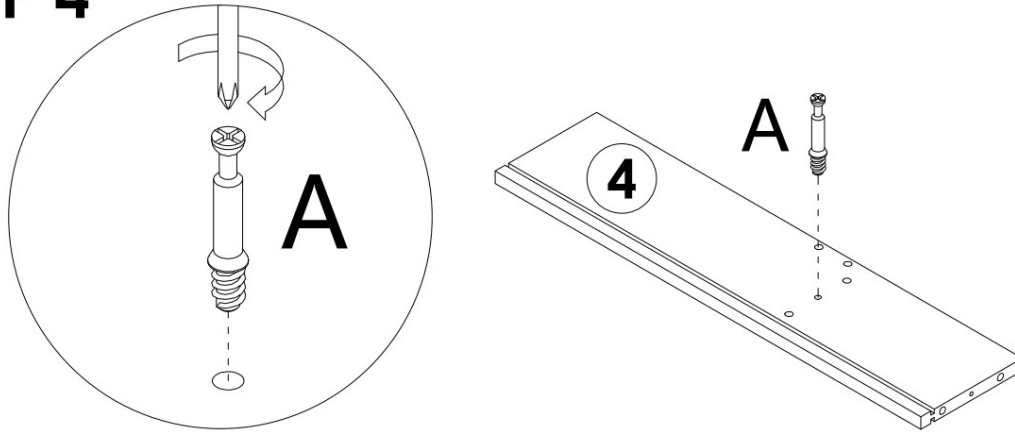

A x 1PC

STEP 5

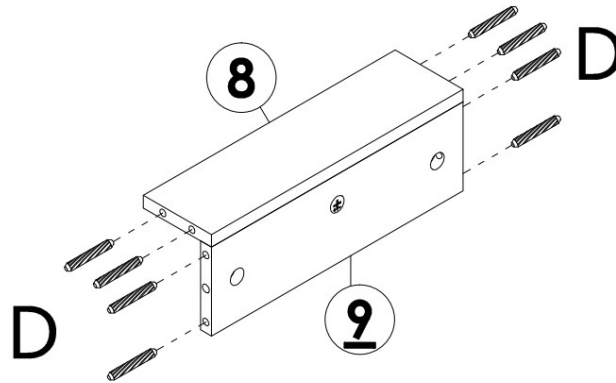

D x 8PCS

STEP 6

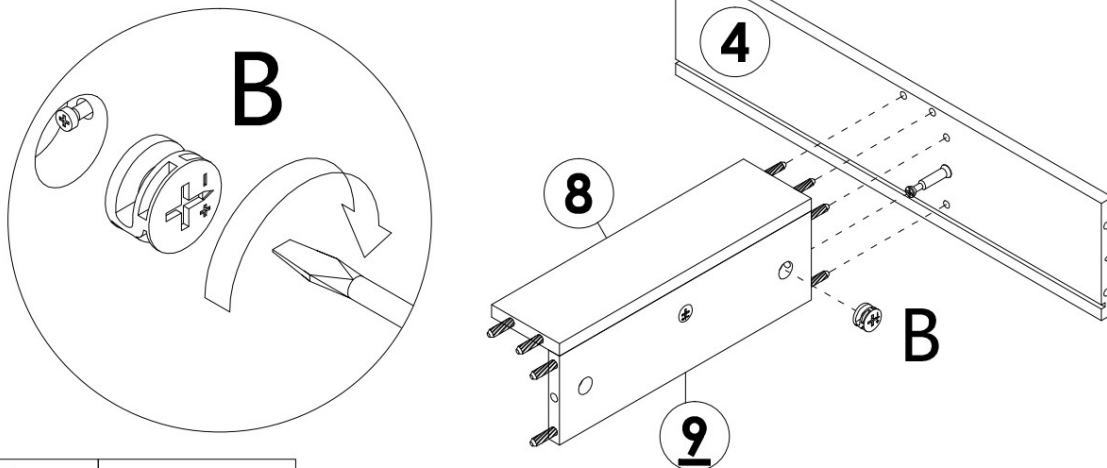

B x 1PC

STEP 7

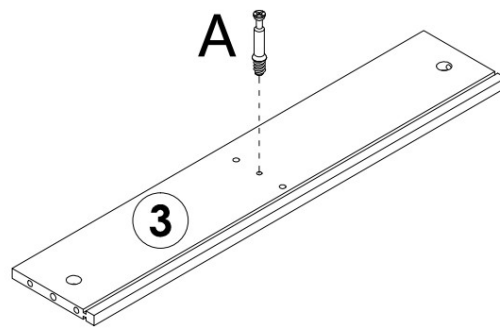
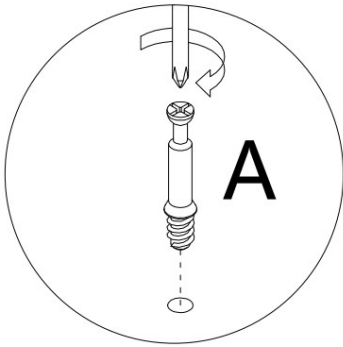

A x 1PC

STEP 8

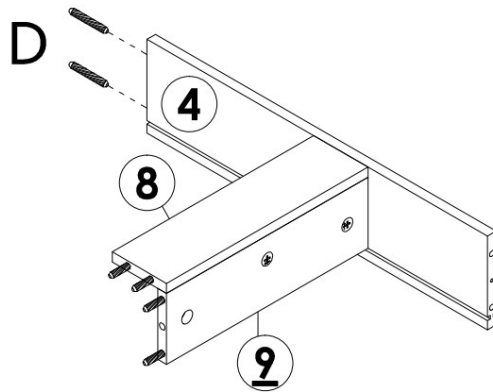

D x 2PCS

STEP 9

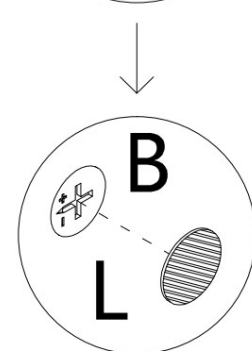
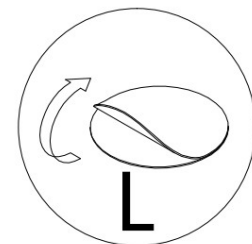
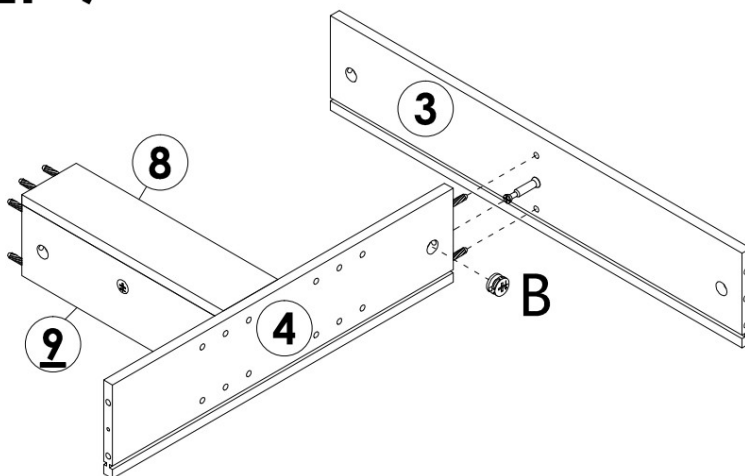



B x 1PC

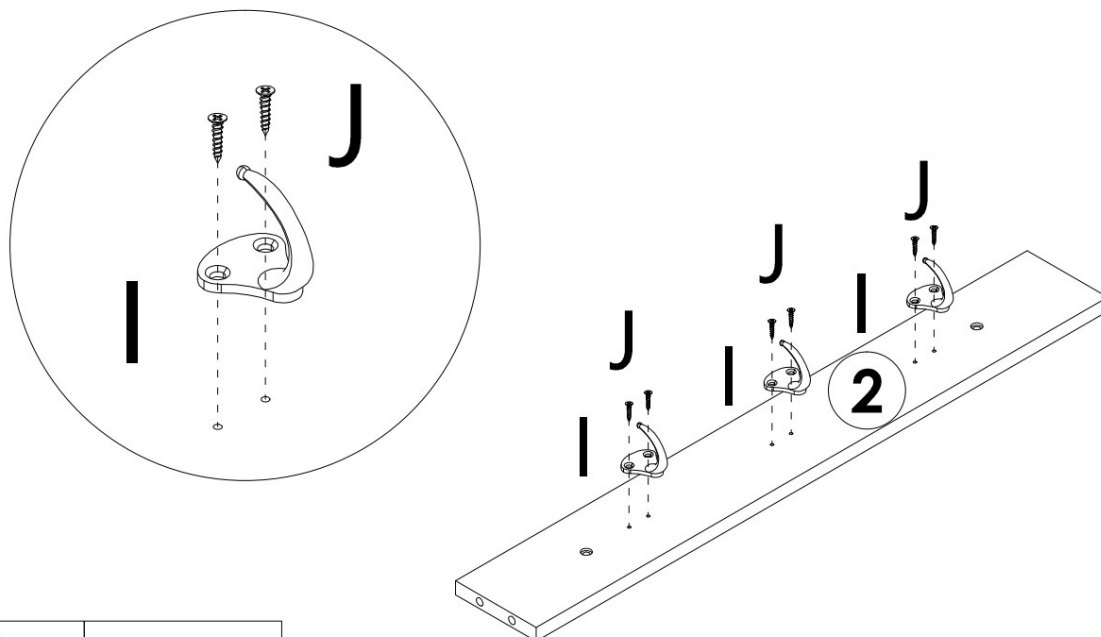

L x 1PC

STEP 10

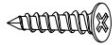

	I x 3PCS
	J x 6PCS

STEP 11

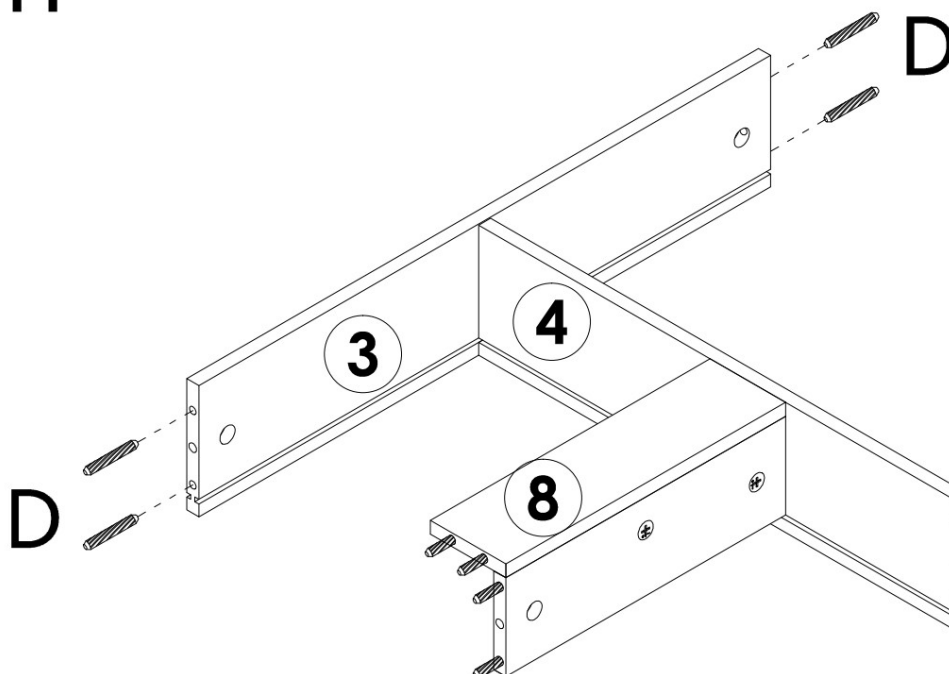

	D x 4PCS
---	----------

STEP 12

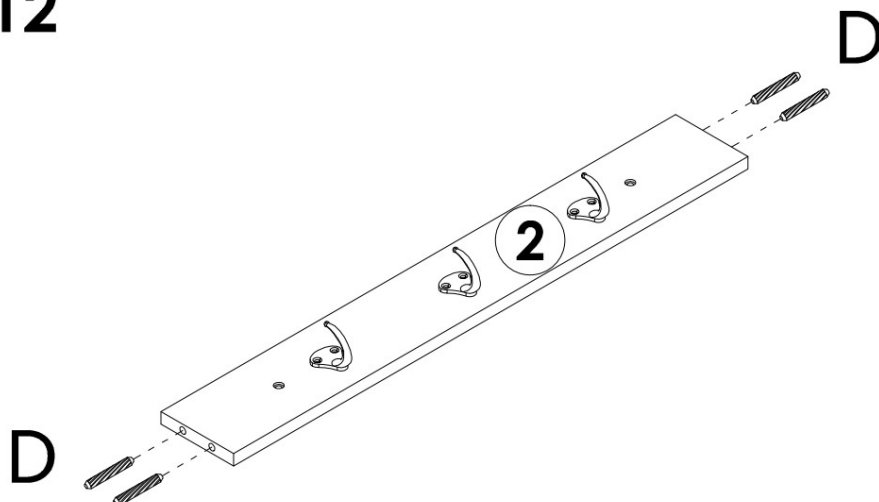

D x 4PCS

STEP 13

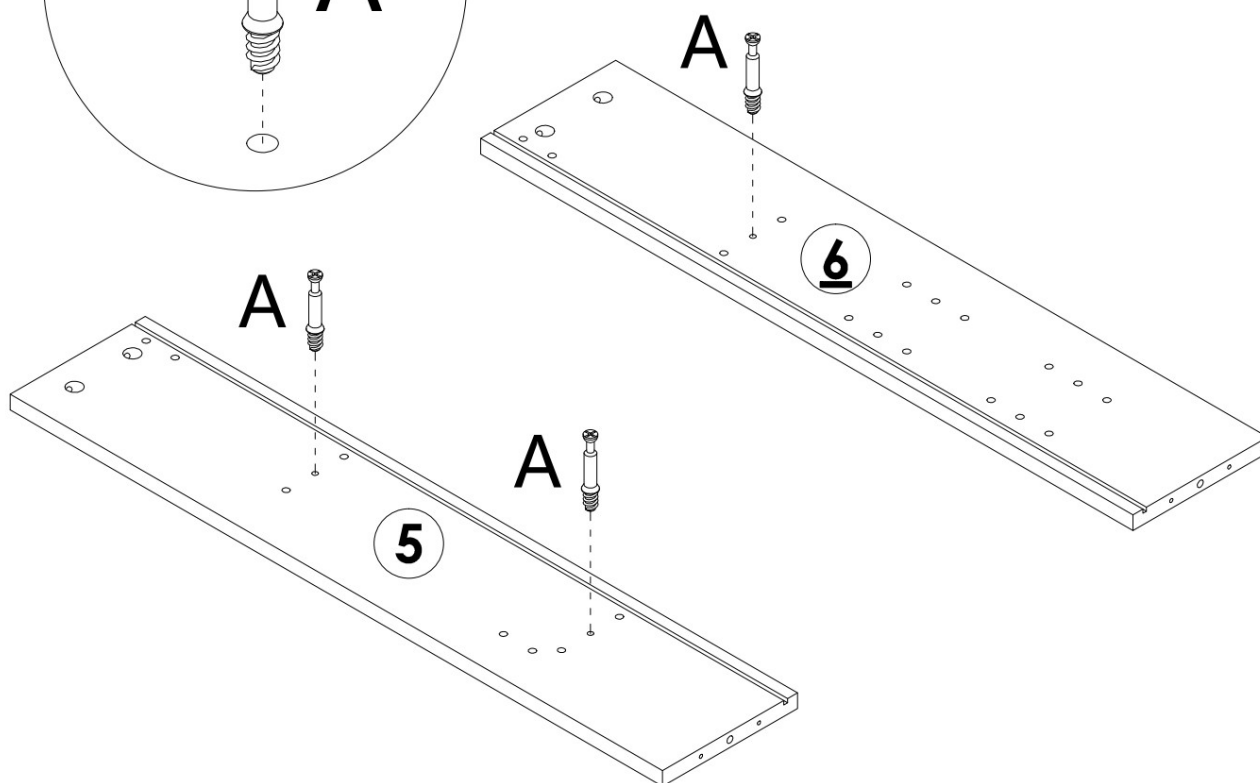
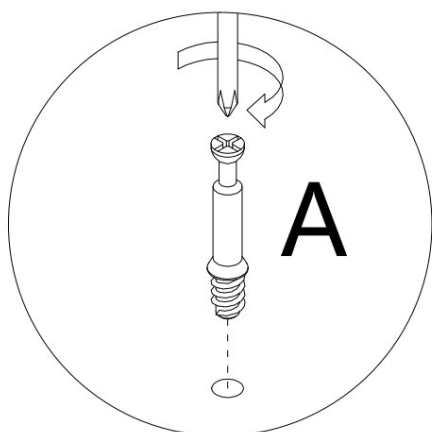

A x 3PCS

STEP 14

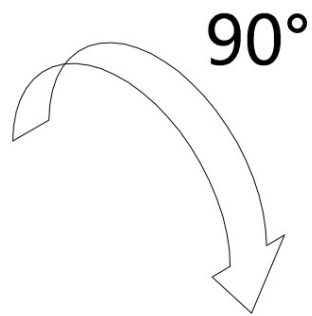
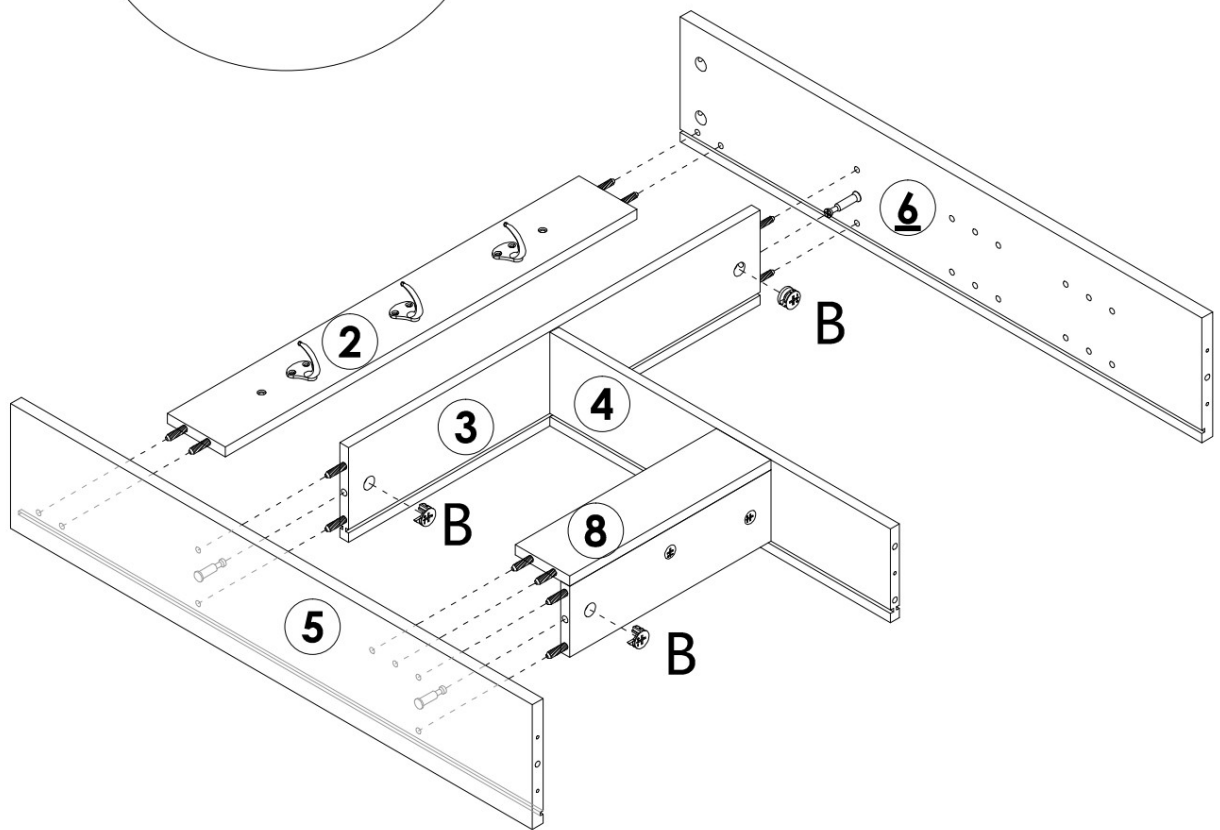
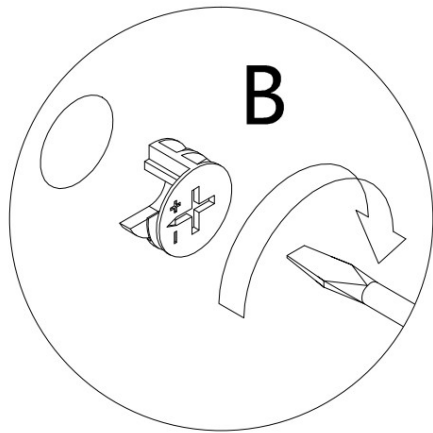

B x 3PCS

STEP 15

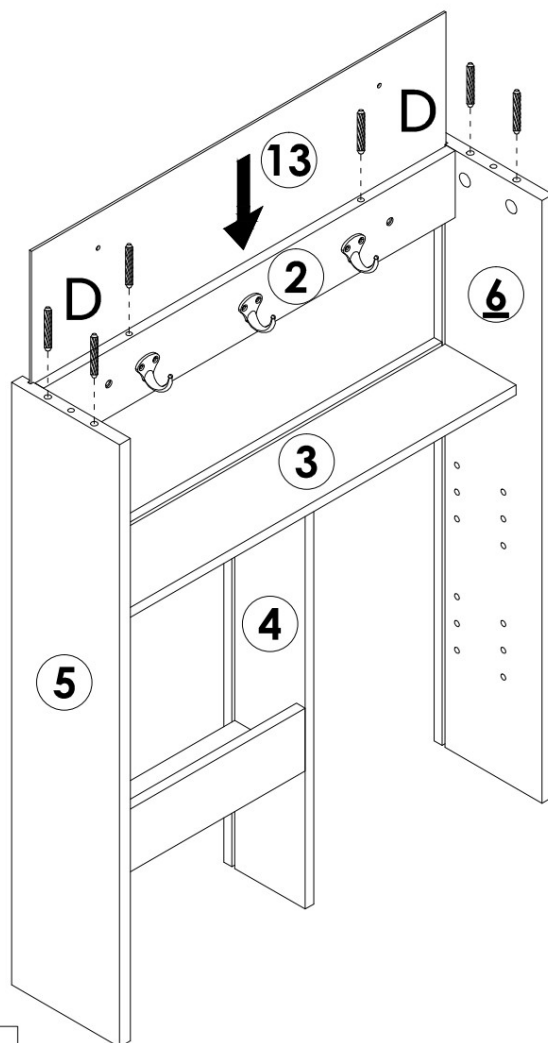

 **D x 6PCS**

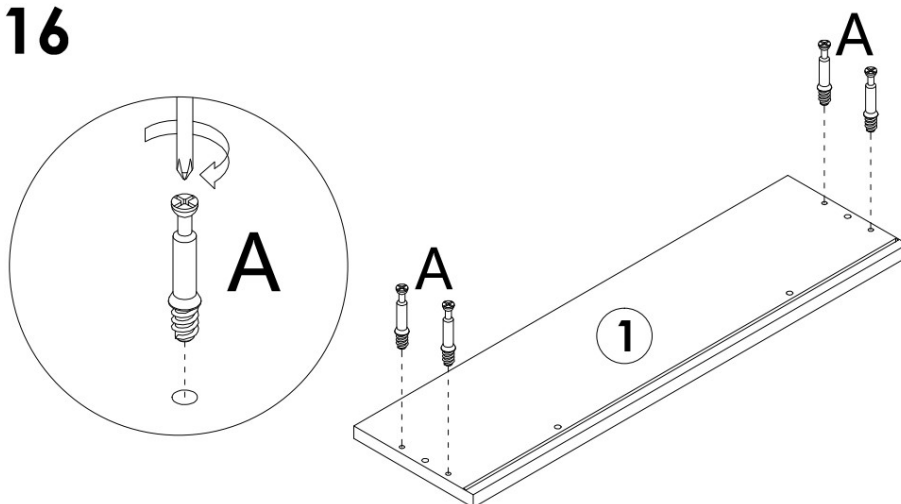

STEP 16

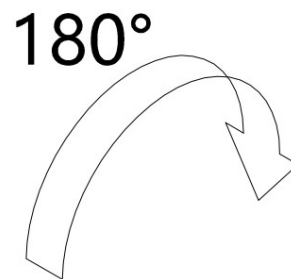
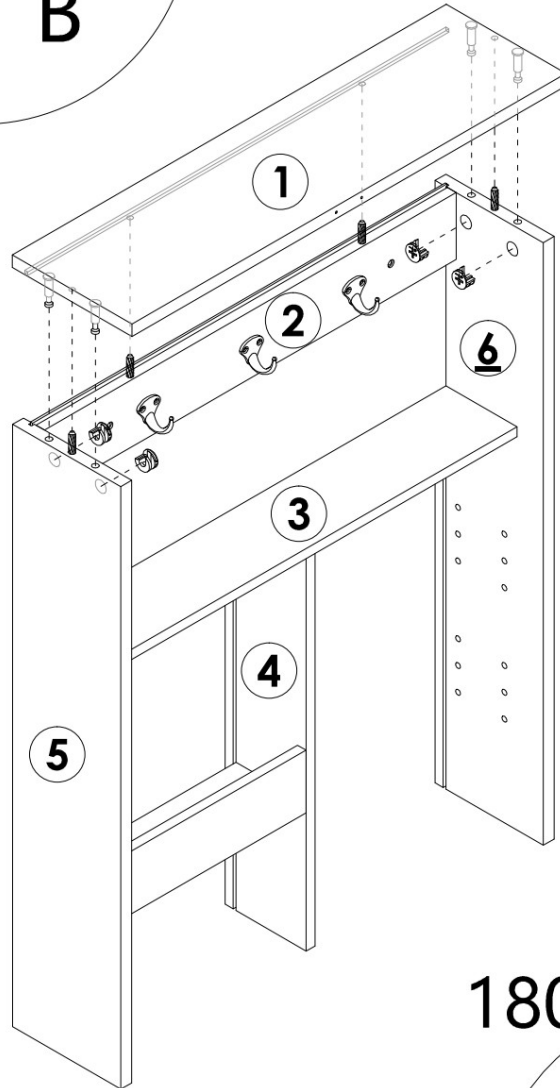
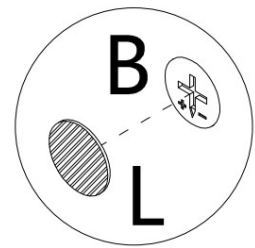
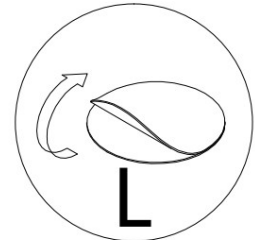
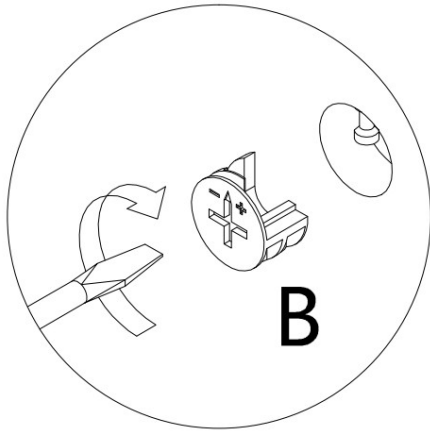

 **A x 4PCS**

STEP 17



	B x 4PCS
	L x 4PCS

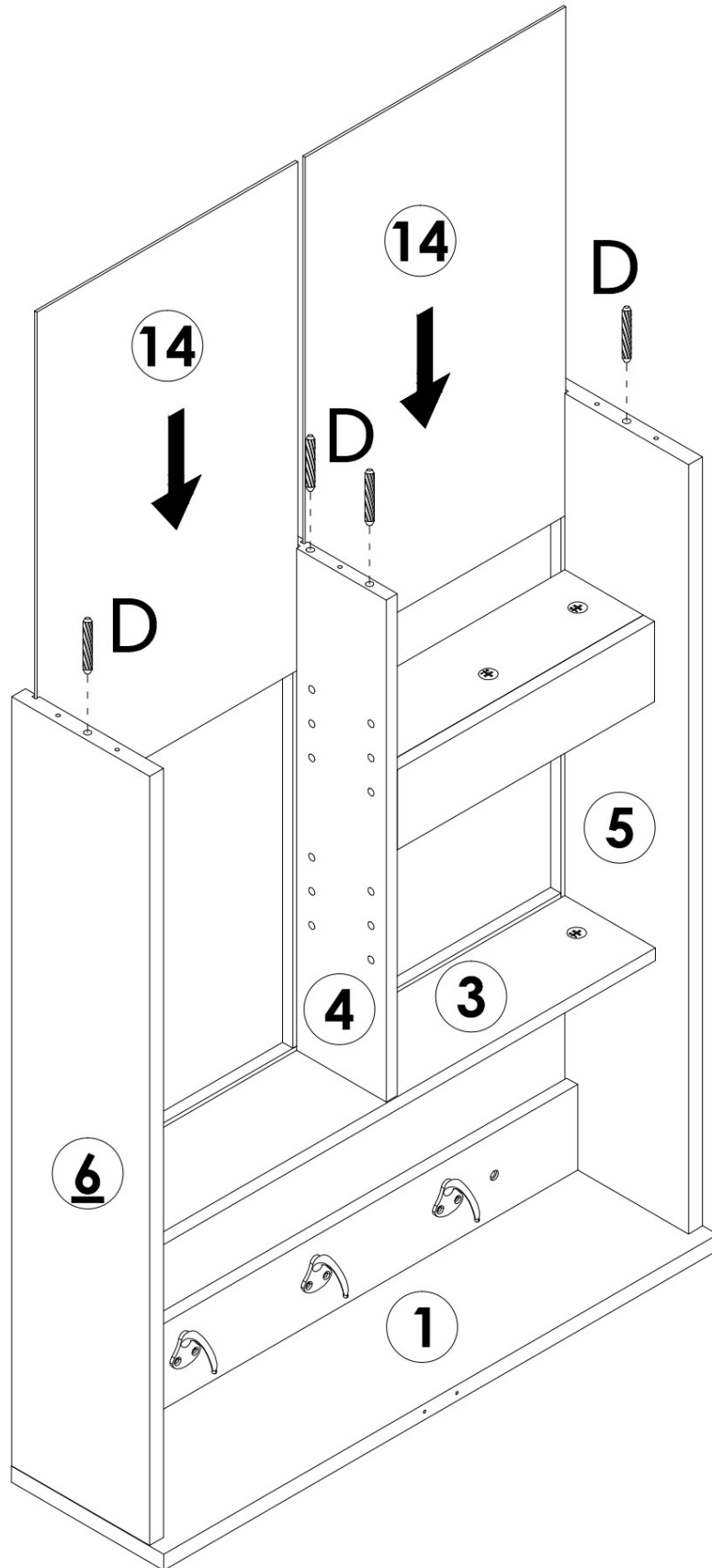

STEP 18

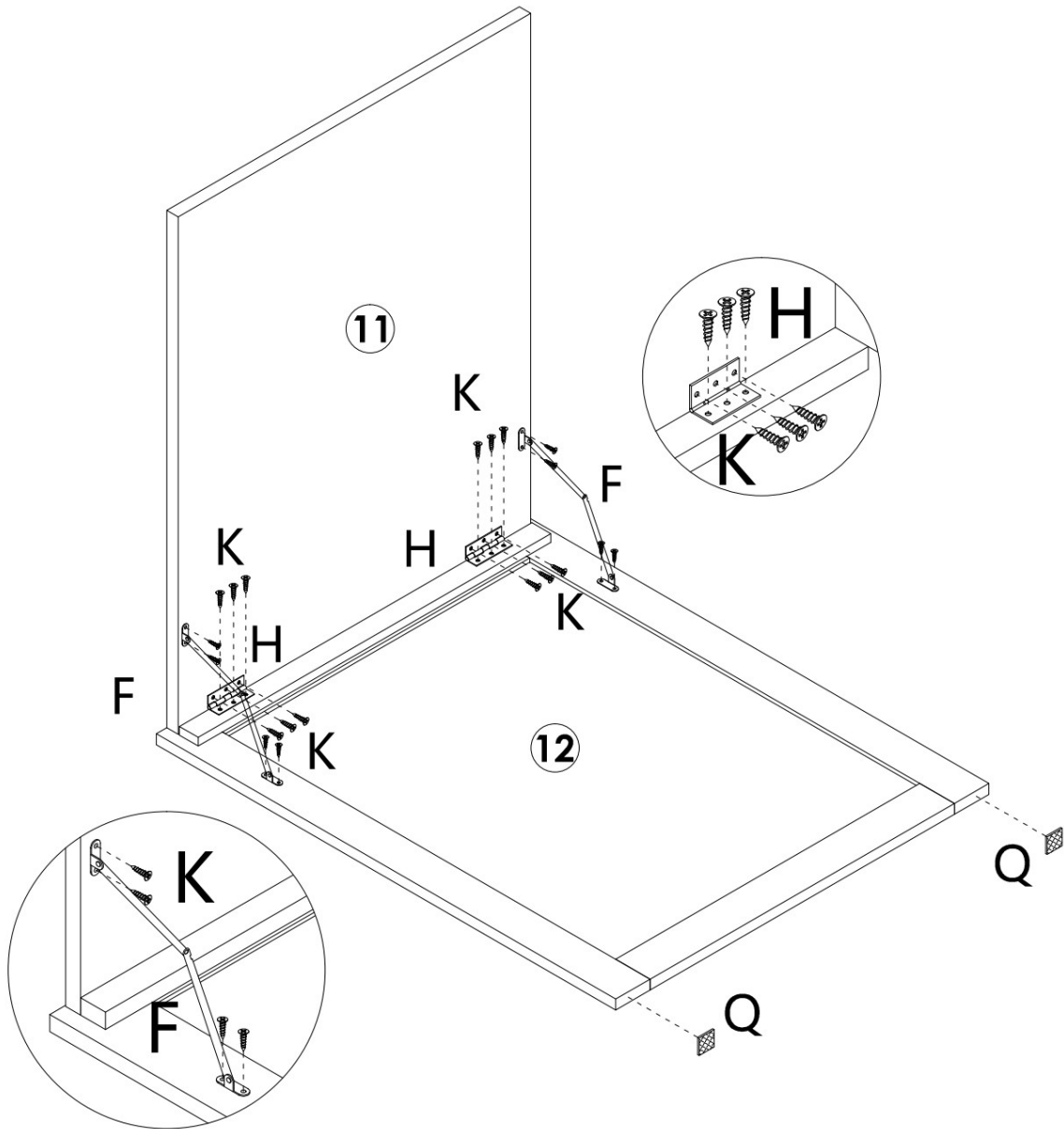

D x 4PCS

STEP 19



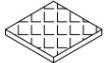

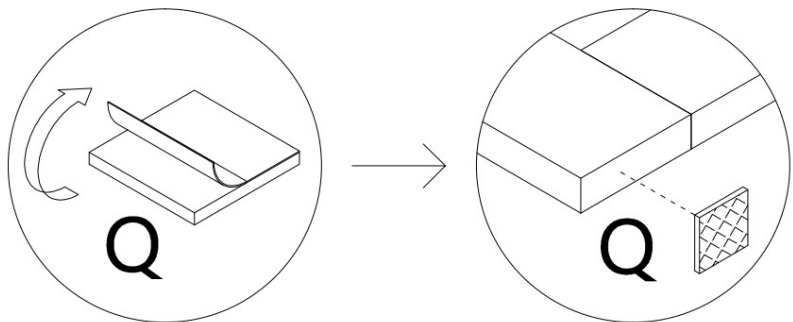
	F x 2PCS
	H x 2PCS
	K x 20PCS
	Q x 2PCS

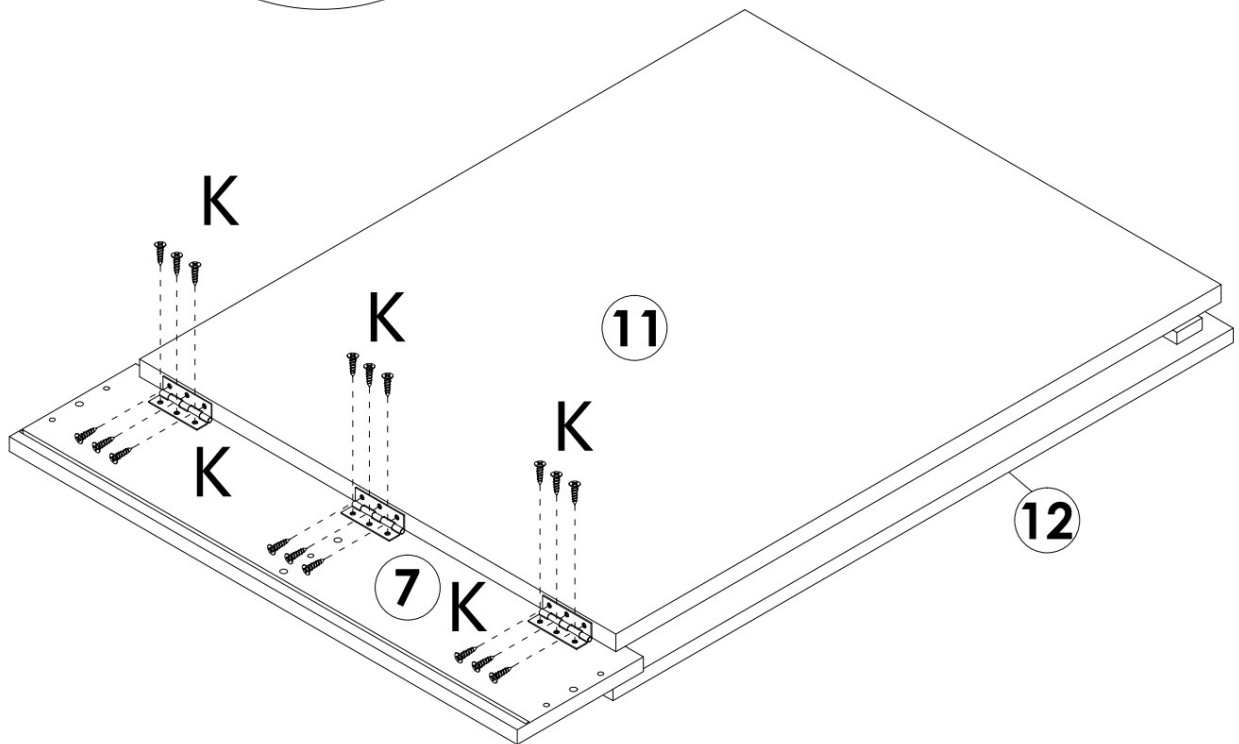
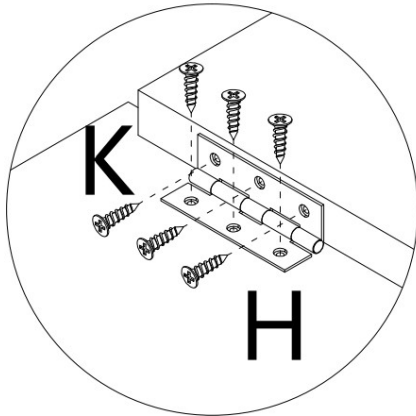

STEP 20



	H x 3PCS
	K x 18PCS

STEP 21

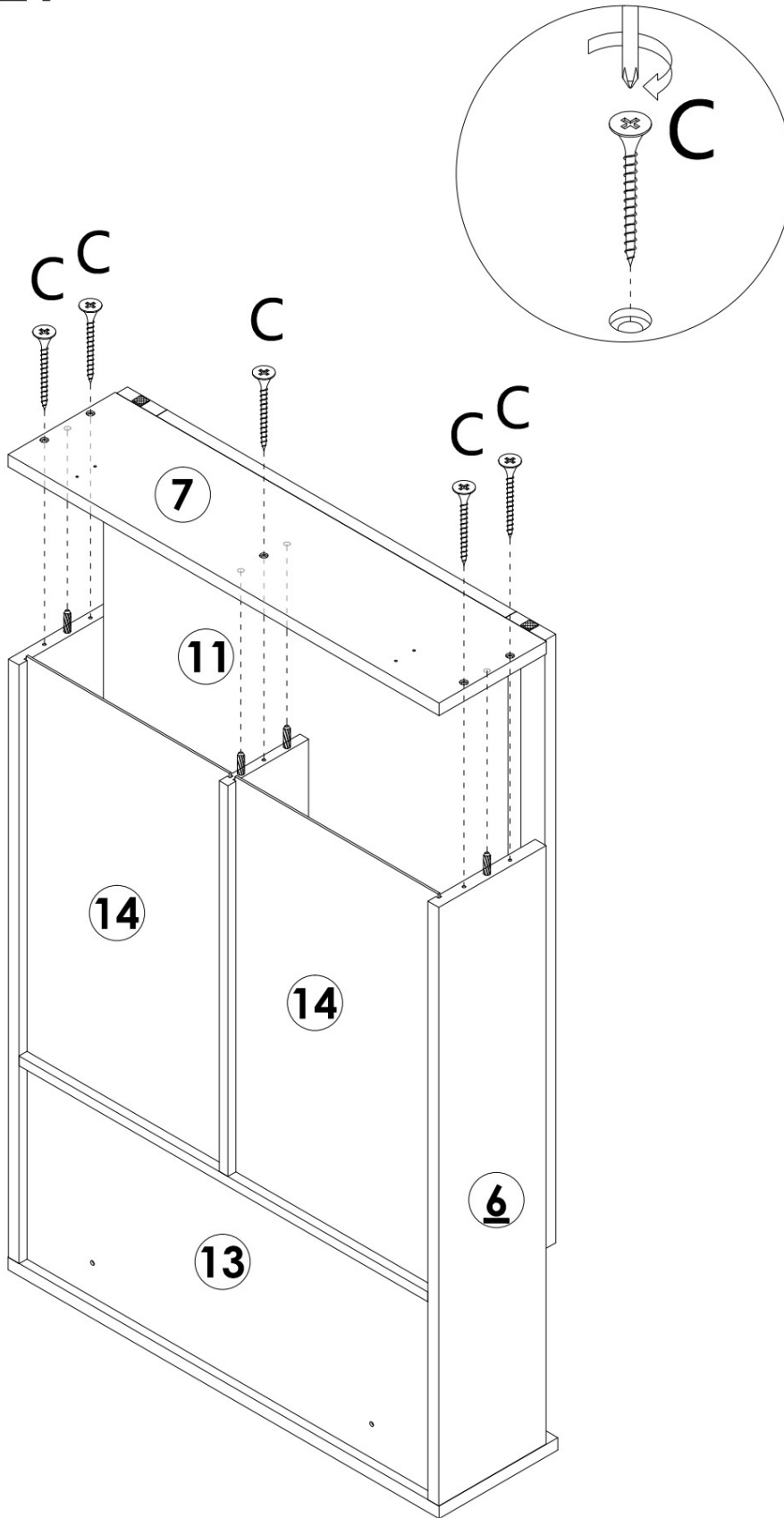

 **C x 5PCS**

STEP 22

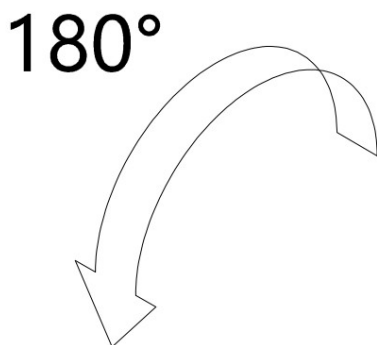
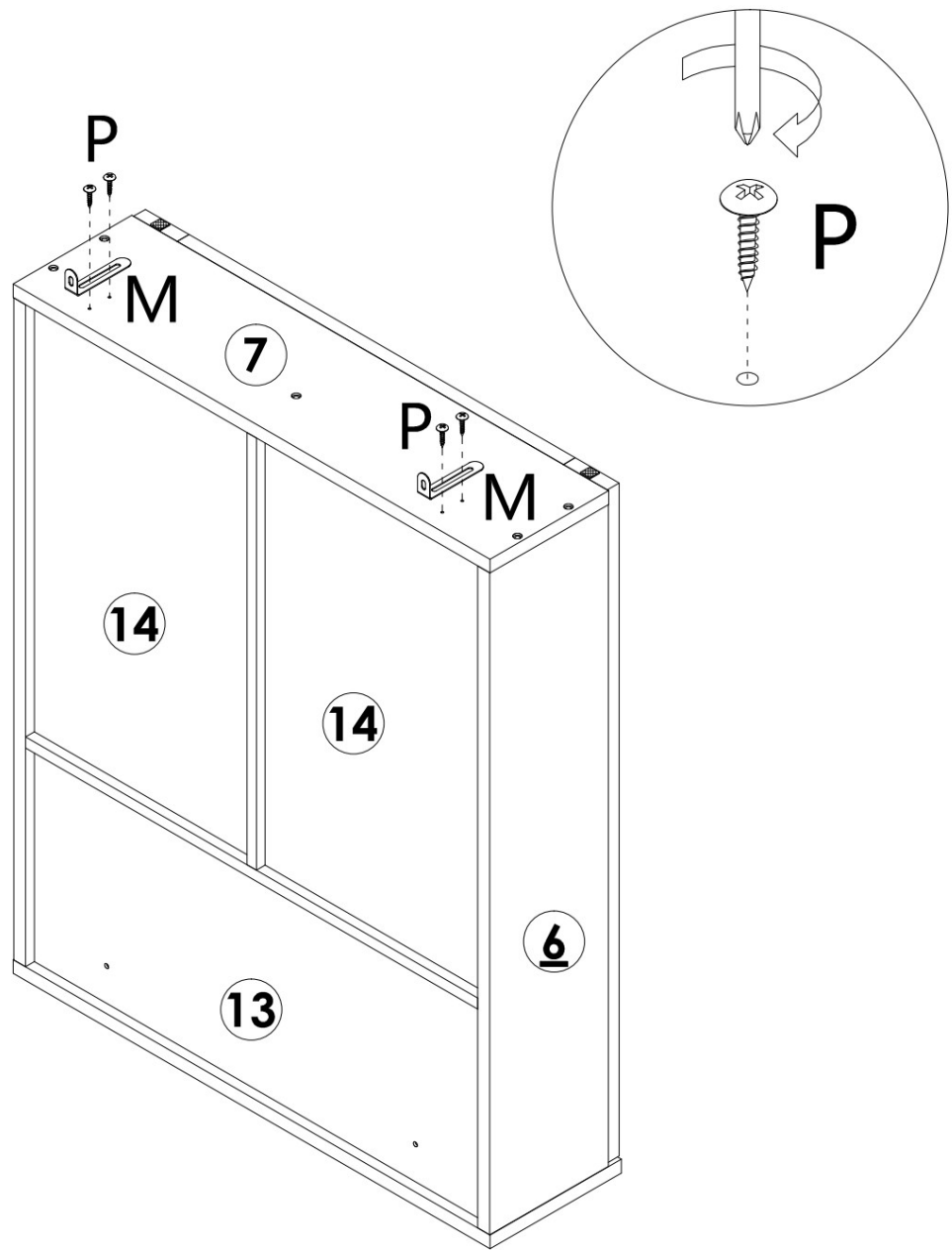

	P x 4PCS
	M x 2PCS

STEP 23

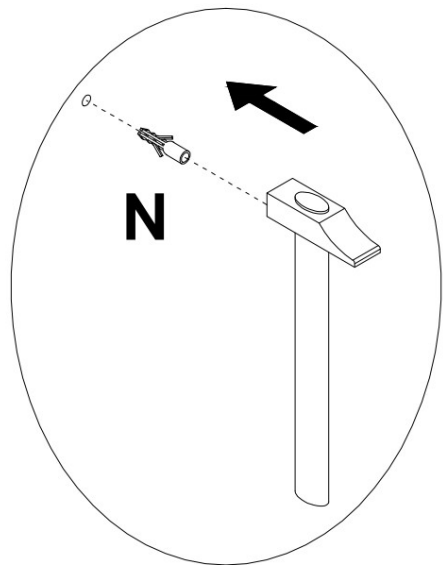
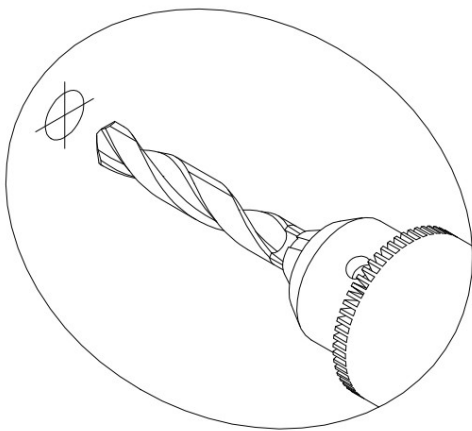
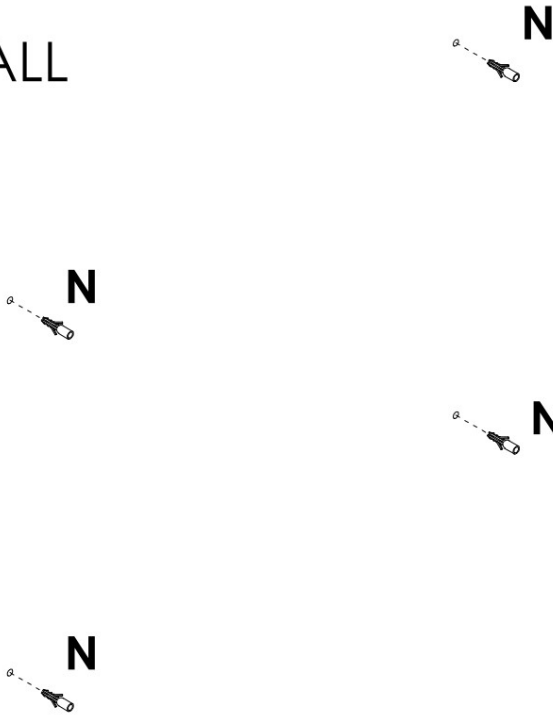

WALL

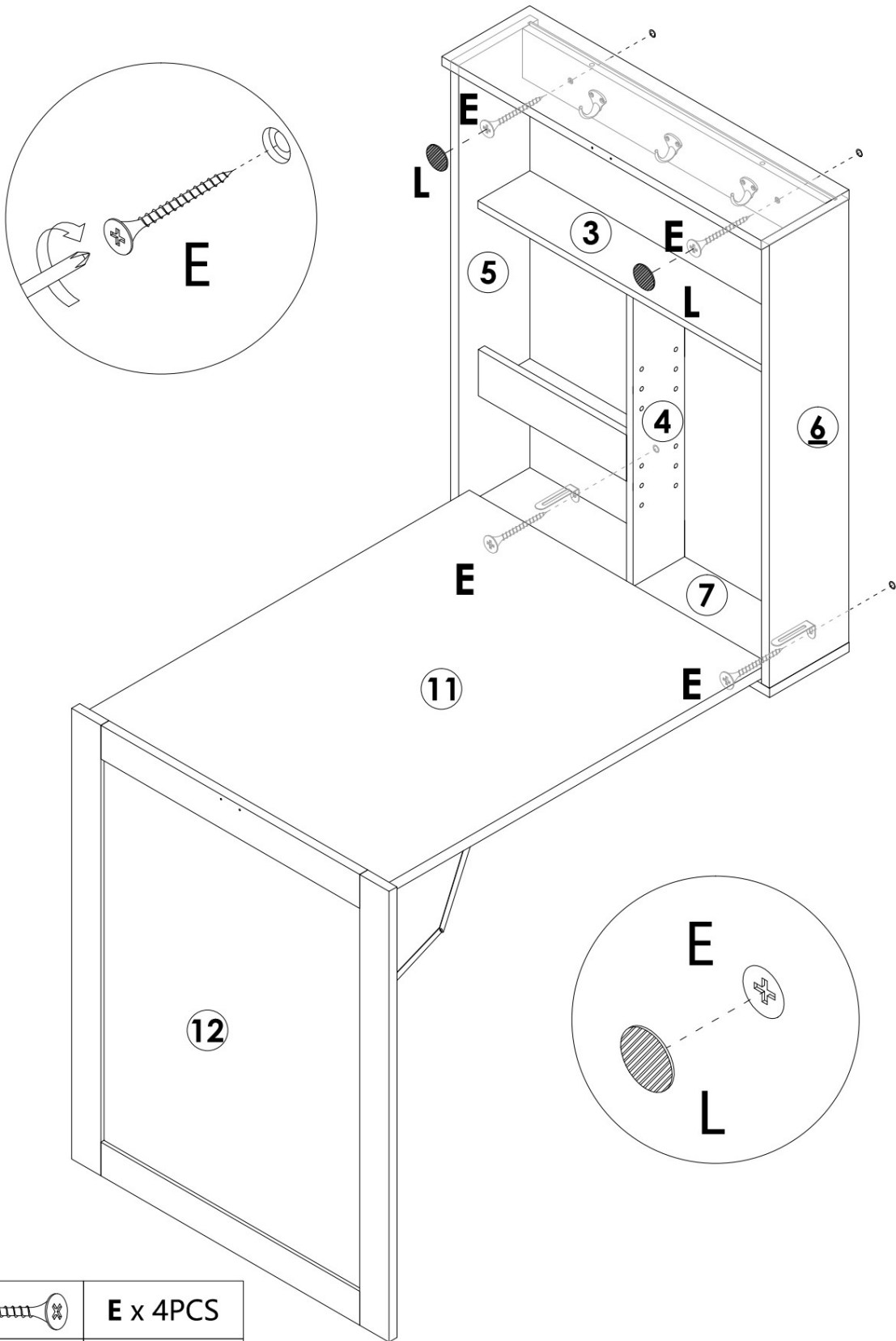

N x 4PCS

STEP 24

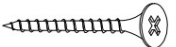

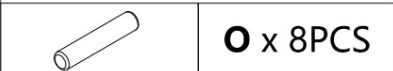
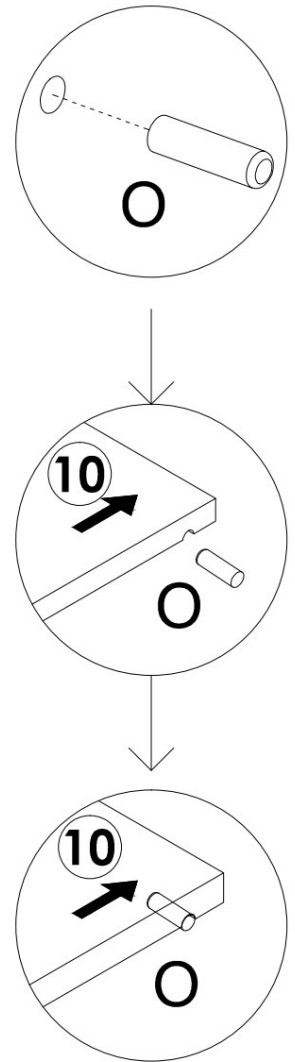
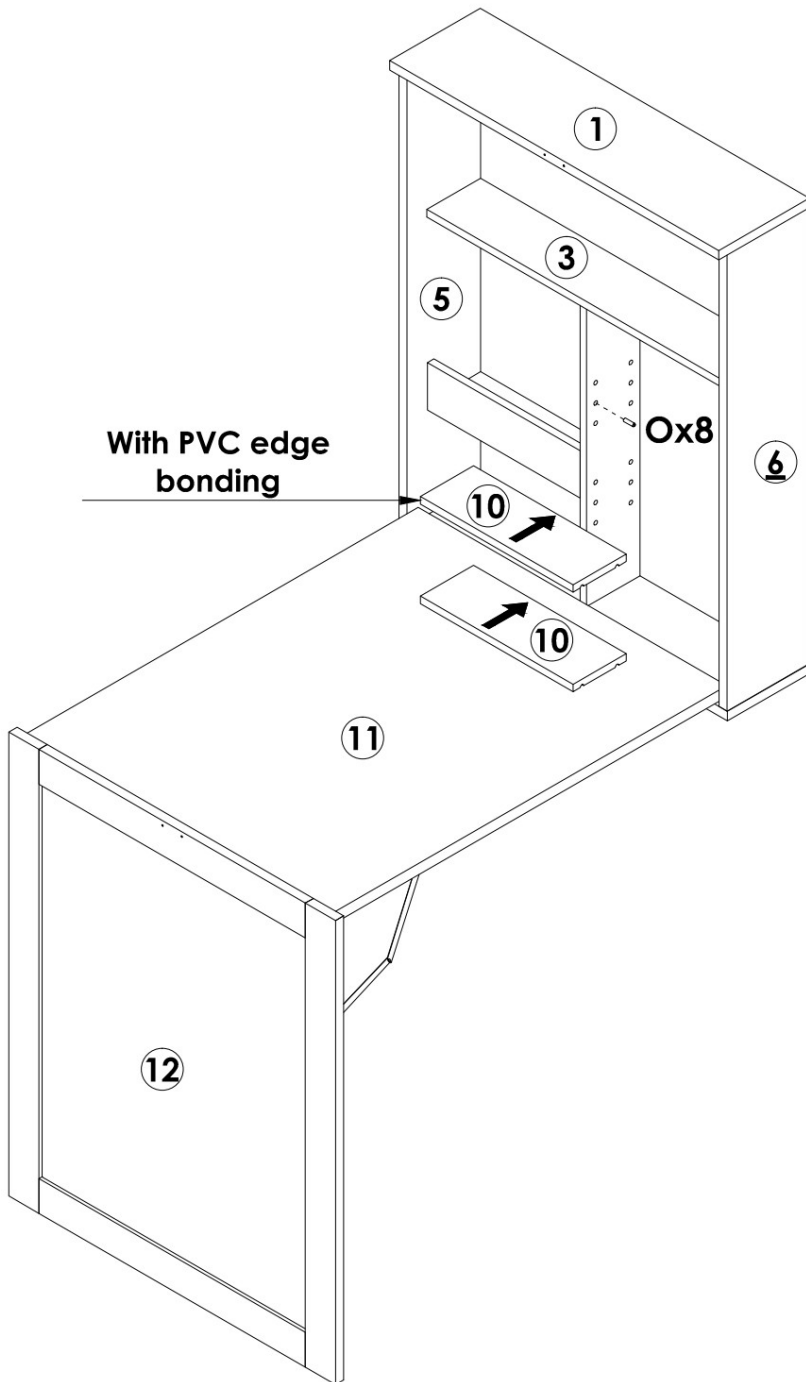

	E x 4PCS
	L x 2PCS

STEP 25

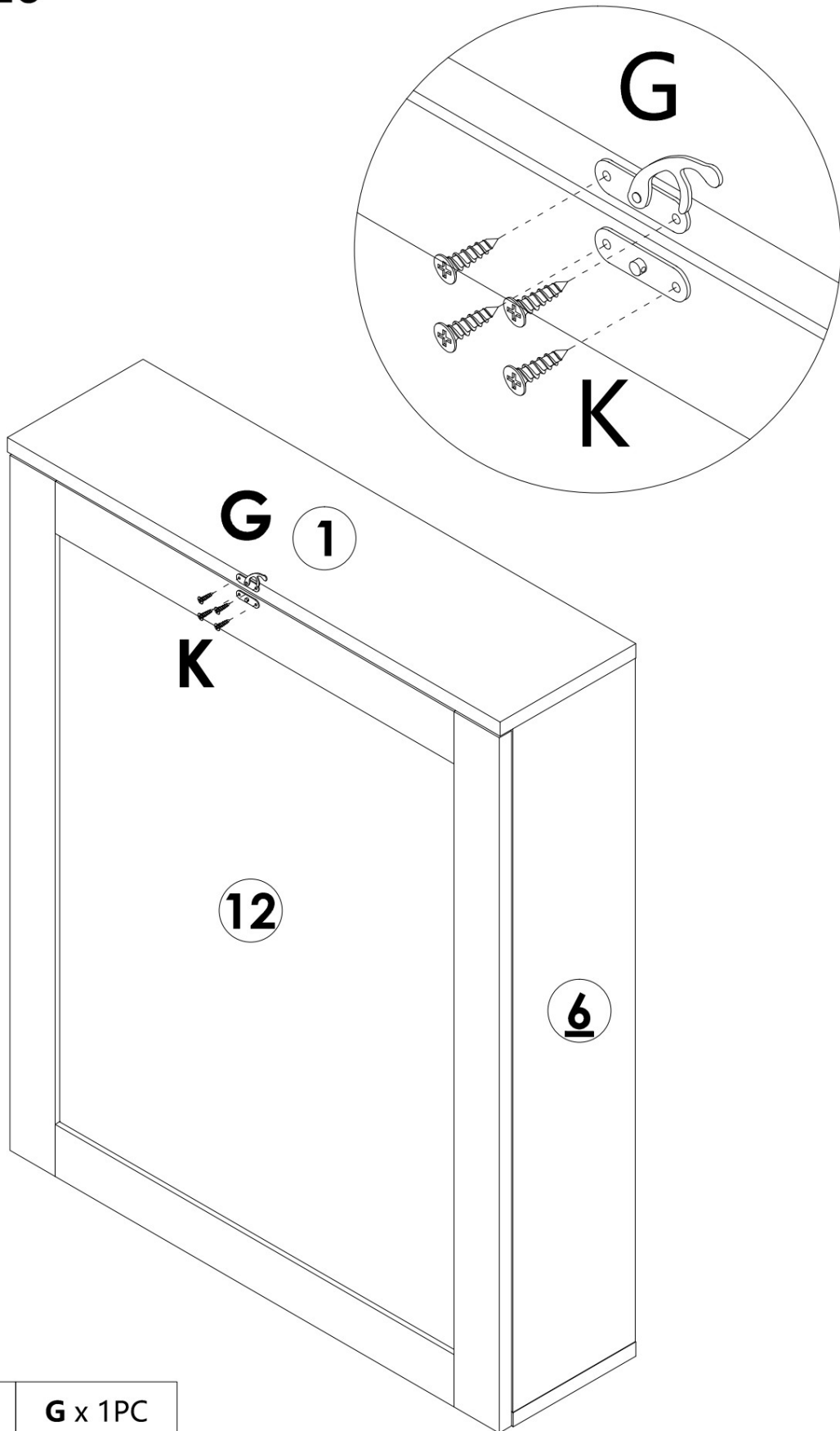

STEP 26



	G x 1PC
	K x 4PCS

TERMINACIÓN

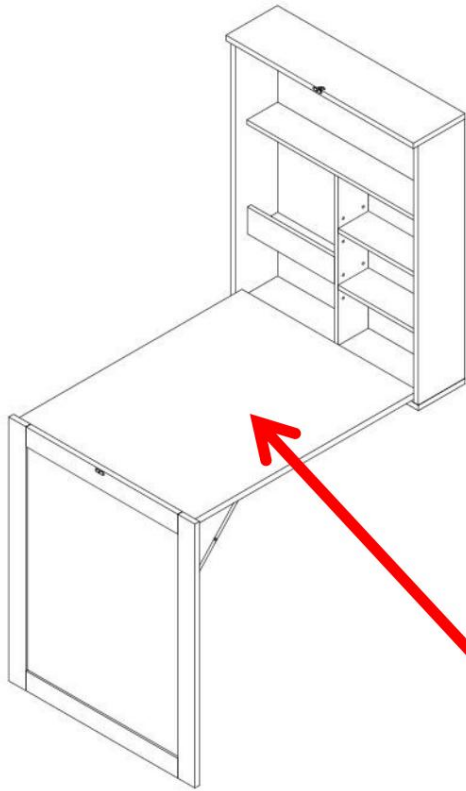

45,35 kg, distribución uniforme

PARÁMETRO DEL PRODUCTO

Modelo	HZCD003
Peso de carga segura	45,35 kilos
Tamaño del producto	600*165*1470 mm

Dirección: Shuangchenglu 803nong11hao1602A-1609shi, baoshanqu, shanghai 200000 CN.

Importado a Australia: SIHAO PTY LTD, 1 ROKEVA STREET EASTWOOD

Nueva Gales del Sur 2122 Australia

Importado a EE. UU.: Sanven Technology Ltd. Suite 250, 9166 Anaheim Place, Rancho Cucamonga, CA 91730

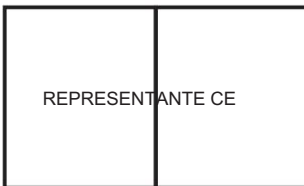

E-CrossStu GmbH.

Mainzer Landstr.69, 60329 Fráncfort del Meno.

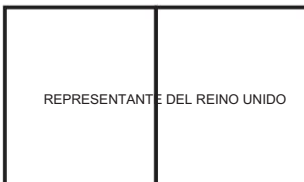

YH CONSULTING LIMITADA.

C/O YH Consulting Limited Oficina 147, Centurion House,
Carretera de Londres, Staines-upon-Thames, Surrey, TW18 4AX

VEVOR®
TOUGH TOOLS, HALF PRICE

Soporte técnico y certificado de garantía
electrónica www.vevor.com/support

VEVOR®

TOUGH TOOLS, HALF PRICE

Wsparcie techniczne i certyfikat gwarancji elektronicznej www.vevor.com/support

PŁYWAJĄCE BIURKO

INSTRUKCJA OBSŁUGI

MODEL:HZCD003

Nadal staramy się oferować Państwu narzędzia w konkurencyjnych cenach.

„Oszczędź połowę”, „Połowa ceny” lub inne podobne wyrażenia używane przez nas stanowią jedynie szacunkowe oszczędności, jakie możesz uzyskać kupując u nas określone narzędzia w porównaniu z głównymi markami i niekoniecznie oznaczają one objęcie wszystkich kategorii narzędzi oferowanych przez nas. Uprzejmie przypominamy, aby dokładnie sprawdzić, czy składając u nas zamówienie faktycznie oszczędzasz połowę w porównaniu z głównymi markami.

VEVOR[®]
TOUGH TOOLS, HALF PRICE

PŁYWAJĄCE BIURKO

MODEL:HZCD003



POTRZEBUJESZ POMOCY? SKONTAKTUJ SIĘ Z NAMI!

Masz pytania dotyczące produktu? Potrzebujesz wsparcia technicznego? Skontaktuj się z nami:

Wsparcie techniczne i certyfikat gwarancji
elektronicznej www.vevor.com/support

To jest oryginalna instrukcja, przed użyciem należy uważnie przeczytać wszystkie instrukcje. VEVOR zastrzega sobie jasną interpretację naszej instrukcji obsługi. Wygląd produktu będzie zależał od produktu, który otrzymałeś. Prosimy o wybaczenie, że nie poinformujemy Cię ponownie, jeśli w naszym produkcie pojawią się jakiegokolwiek aktualizacje technologiczne lub oprogramowania.

INSTRUKCJE BEZPIECZEŃSTWA

OSTRZEŻENIE:

Przeczytaj ten materiał przed użyciem tego produktu. Nieprzestrzeganie tego może spowodować poważne obrażenia.

Środki ostrożności podczas montażu

1. Montaż należy wykonywać wyłącznie zgodnie z niniejszą instrukcją. Nieprawidłowy montaż może stwarzać zagrożenia.
2. Noś okulary ochronne zatwierdzone przez ANSI i wytrzymałe rękawice robocze. w trakcie montażu.
3. Utrzymuj miejsce zgromadzenia w czystości i zapewnij dobre oświetlenie.
4. Podczas montażu nie dopuszczaj osób postronnych na teren montażu.
5. Nie przychodź na spotkania, jeśli jesteś zmęczony lub pod wpływem alkoholu, narkotyków lub leków.
6. Możliwości produktu dotyczą prawidłowego i kompletnego montażu tylko produkty.
7. Montaż należy wykonać na płaskiej, równej, twardej i gładkiej powierzchni, która będzie bezpieczna. wspierające Floating Desk.
8. Aby uzyskać dodatkowe informacje dotyczące części wymienionych poniżej, strony, zapoznaj się ze schematem montażu w tym podręczniku. Rozpakuj i oddziel wszystkie części w czystym miejscu pracy.









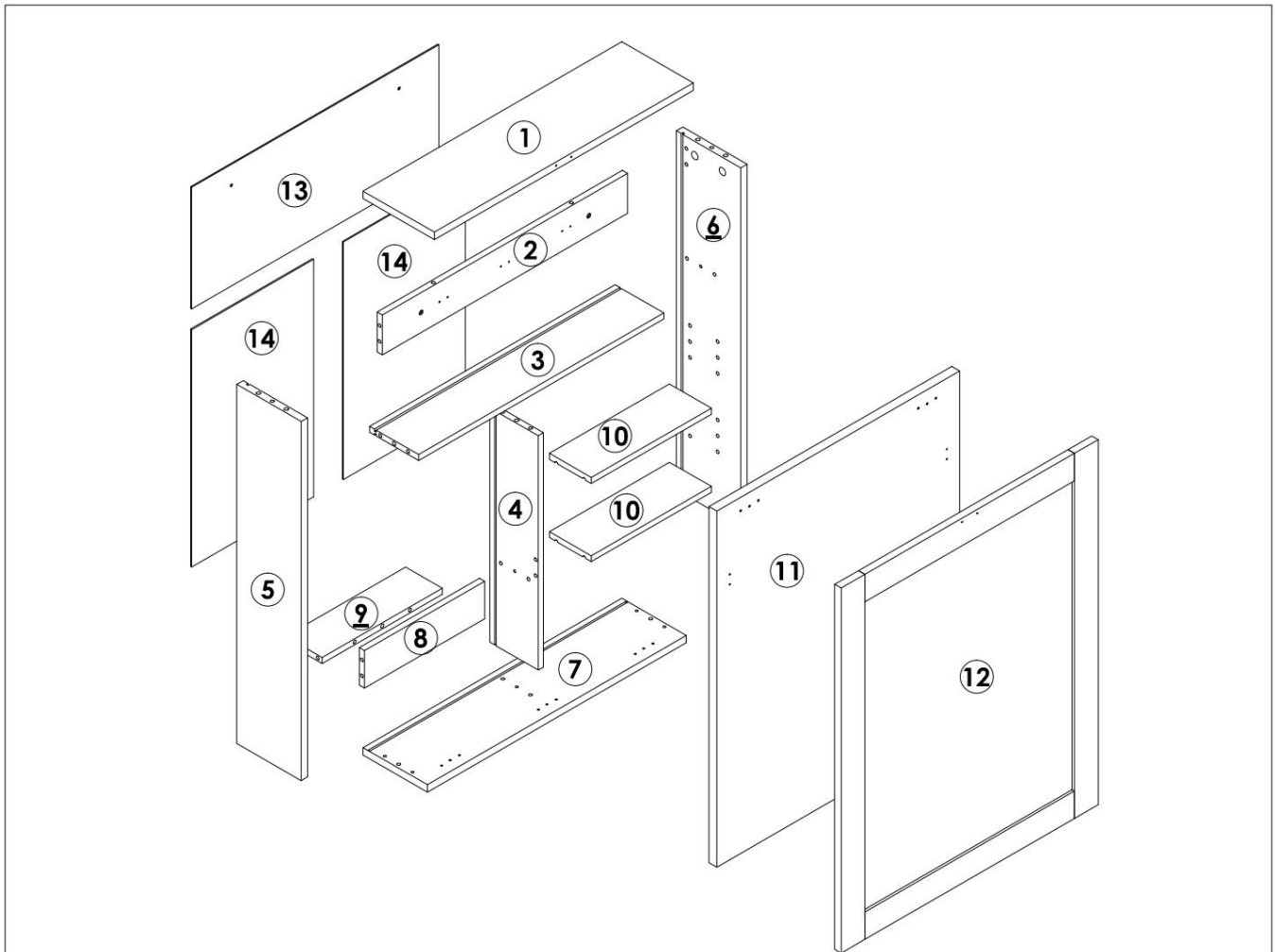

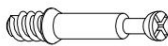



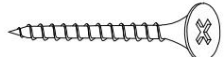
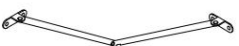

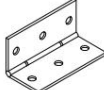
Stosuj środki ostrożności

1. NIE SIADAJ ANI NIE STAWAJ NA TYM PRZEDMIOCIE.
2. Ten produkt nie jest zabawką. Nie pozwalaj dzieciom bawić się nim ani przebywać w jego pobliżu. przedmiot.
3. Nie przekraczać dopuszczalnego obciążenia.
4. Używać wyłącznie zgodnie z przeznaczeniem.
5. Przed każdym użyciem należy przeprowadzić kontrolę. Nie należy używać produktu, jeśli jakieś części są luźne lub uszkodzone.

ZAPISZ TĘ INSTRUKCJĘ

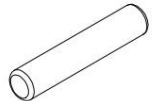
LISTA CZĘŚCI

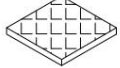

<p>A</p>  <p>M6x35mm 10+1PCS</p>	<p>B</p>  <p>Ø15x9mm 10+1PCS</p>	<p>C</p>  <p>M4x40mm 5PCS</p>	<p>D</p>  <p>Ø6x30mm 30+2PCS</p>	<p>E</p>  <p>M5x60mm 4PCS</p>
<p>F</p>  <p>2PCS</p>	<p>G</p>  <p>1PC</p>	<p>H</p>  <p>5PCS</p>	<p>I</p>  <p>3PCS</p>	<p>J</p>  <p>M3x14mm 6PCS</p>
<p>K</p>  <p>M3x12mm 42+2PCS</p>	<p>L</p>  <p>Ø20mm 7PCS</p>	<p>M</p>  <p>2PCS</p>	<p>N</p>  <p>M8x40mm 4PCS</p>	<p>O</p>  <p>M5x20mm 8+1PCS</p>
<p>P</p>  <p>M4x12mm 4PCS</p>	<p>Q</p>  <p>16x16mm 2PCS</p>	 <p>1PC</p>		

INSTRUKCJE

STEP 1

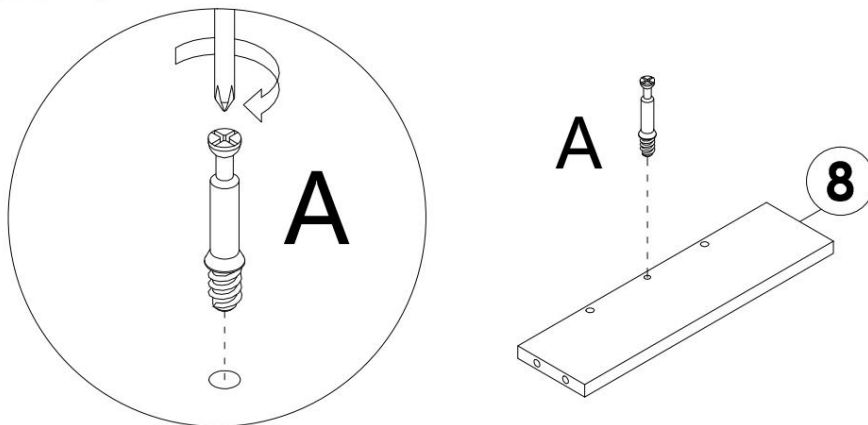

A x 1PC

STEP 2

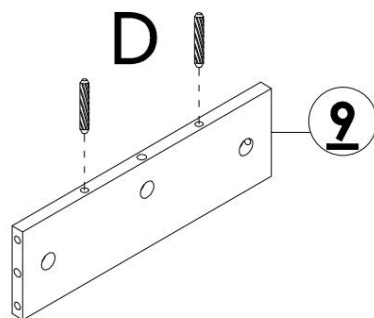

D x 2PCS

STEP 3

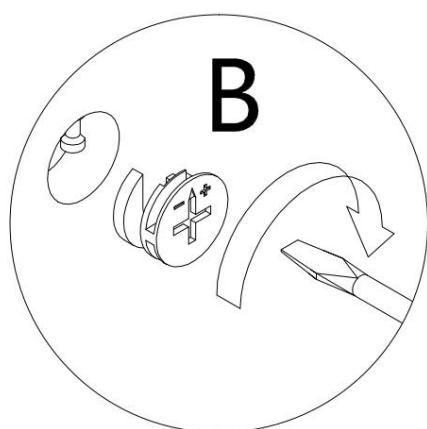

B x 1PC

STEP 4

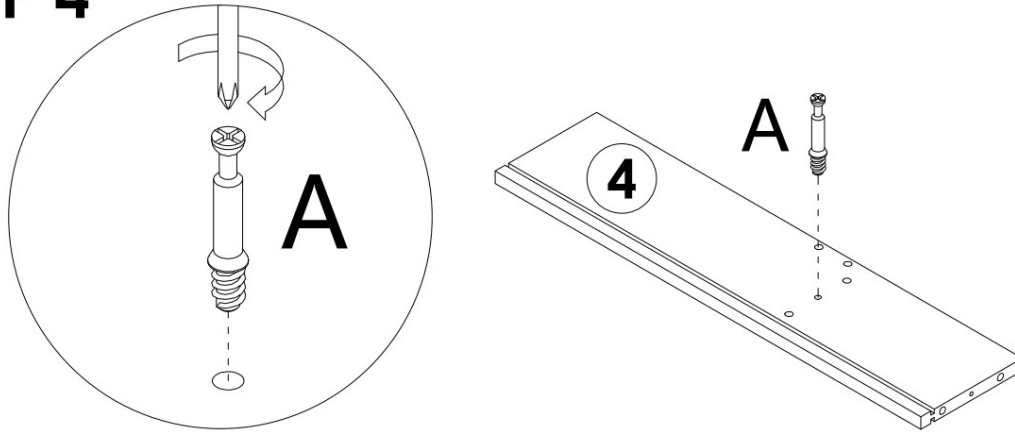

A x 1PC

STEP 5

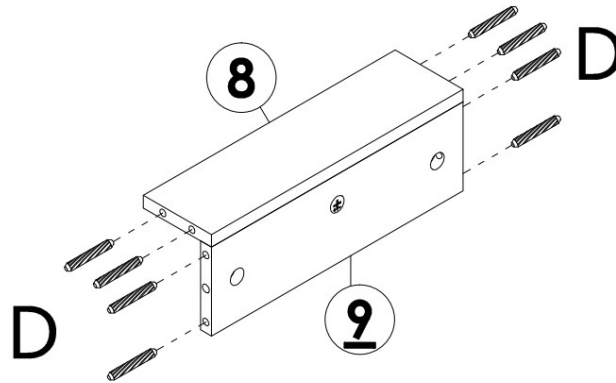

D x 8PCS

STEP 6

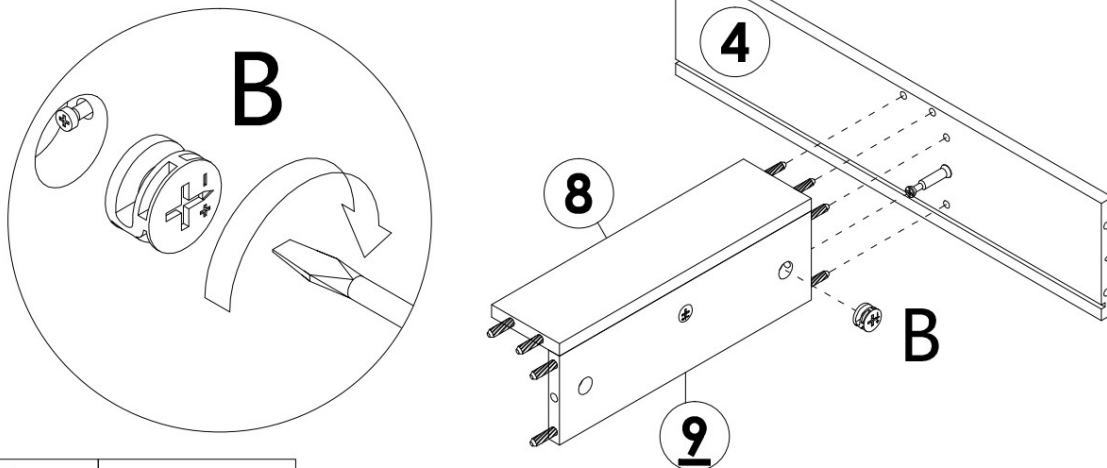

B x 1PC

STEP 7

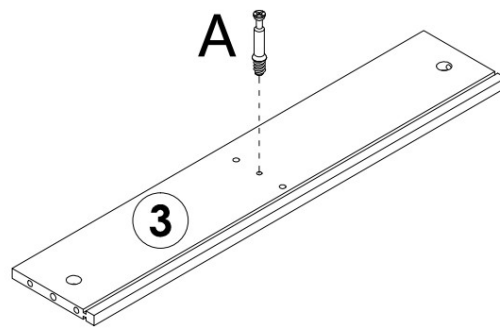
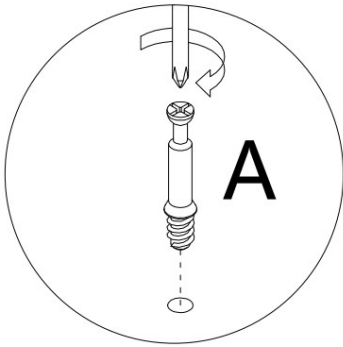

A x 1PC

STEP 8

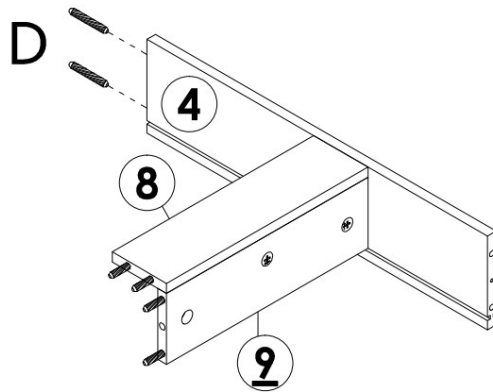

D x 2PCS

STEP 9

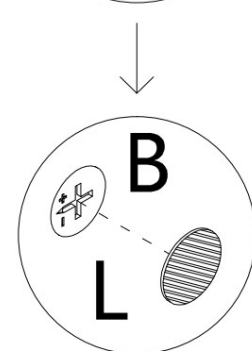
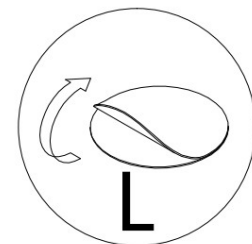
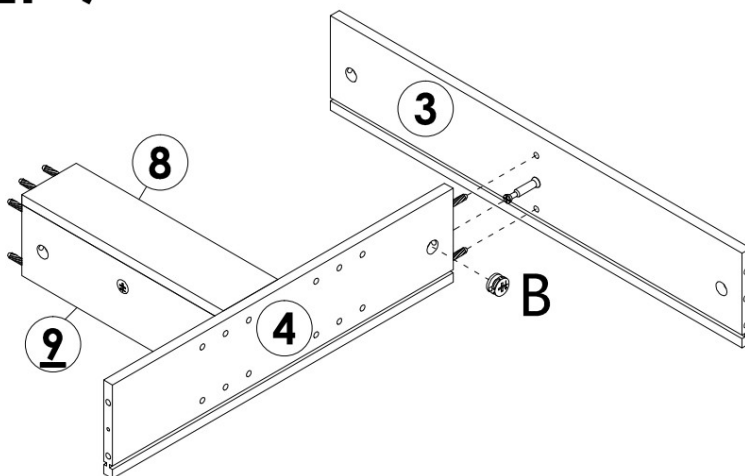



B x 1PC

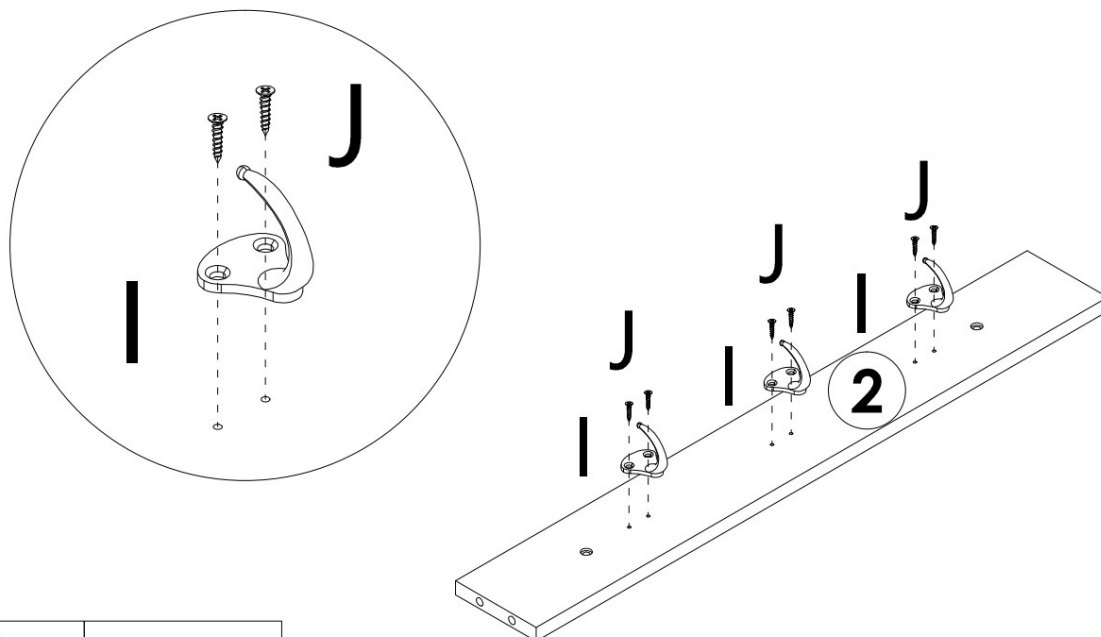

L x 1PC

STEP 10

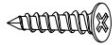

	I x 3PCS
	J x 6PCS

STEP 11

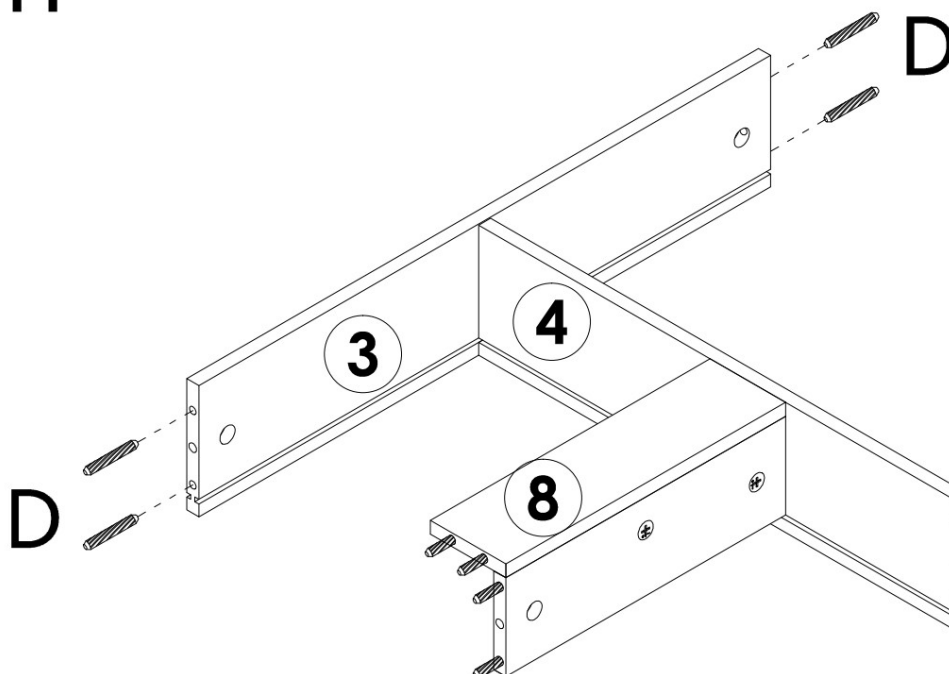

	D x 4PCS
---	----------

STEP 12

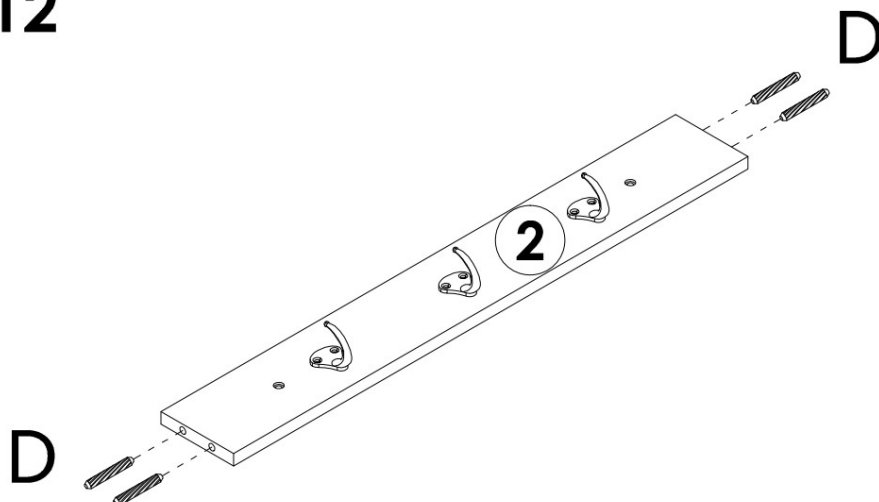

D x 4PCS

STEP 13

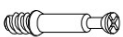
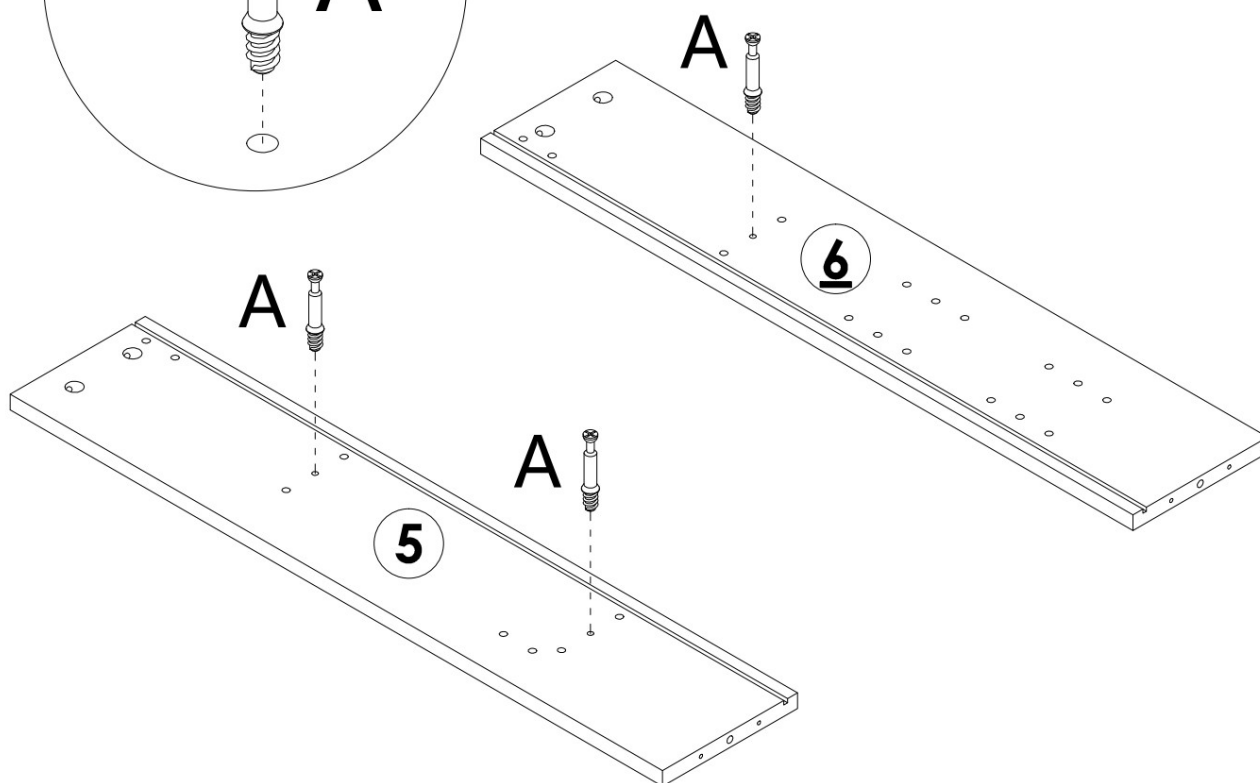
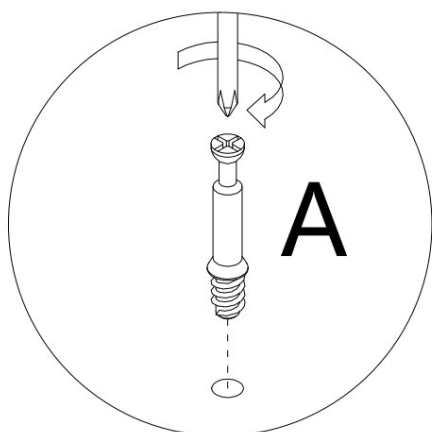

A x 3PCS

STEP 14

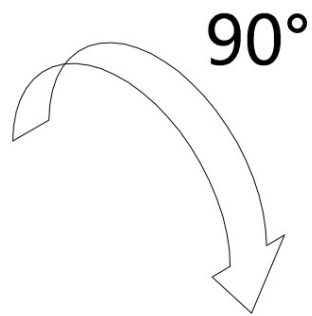
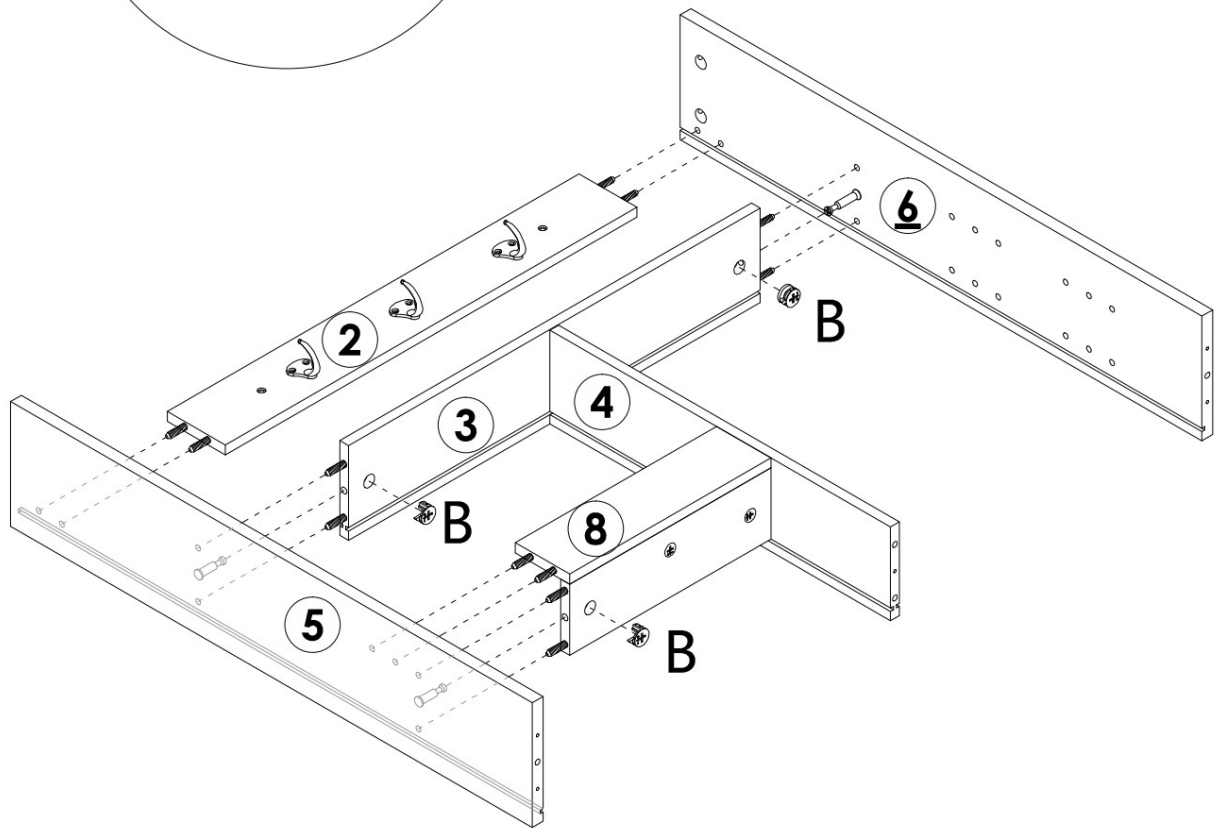
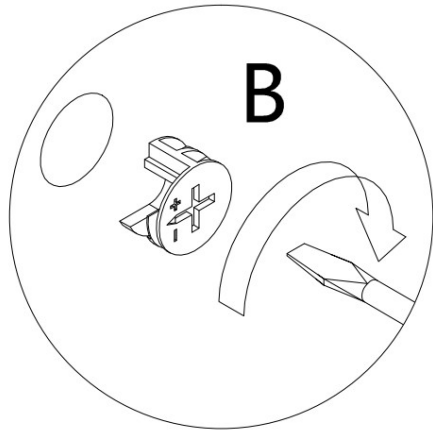

B x 3PCS

STEP 15

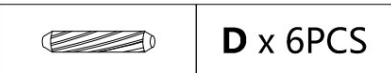
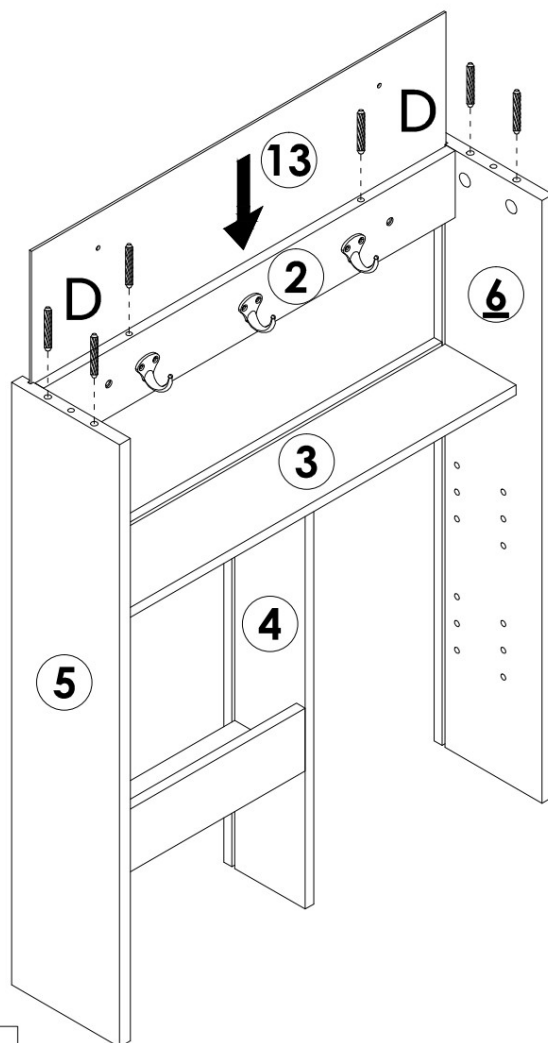

STEP 16

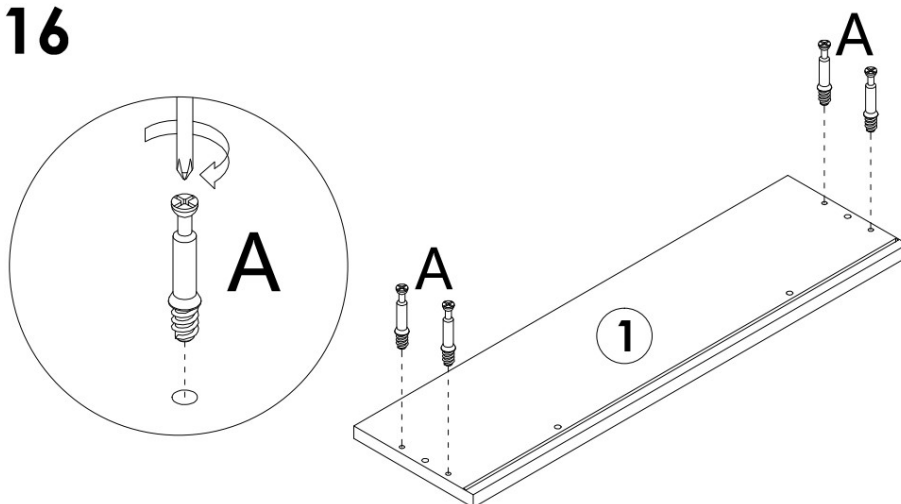

STEP 17

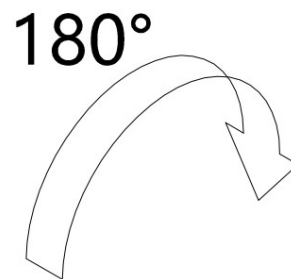
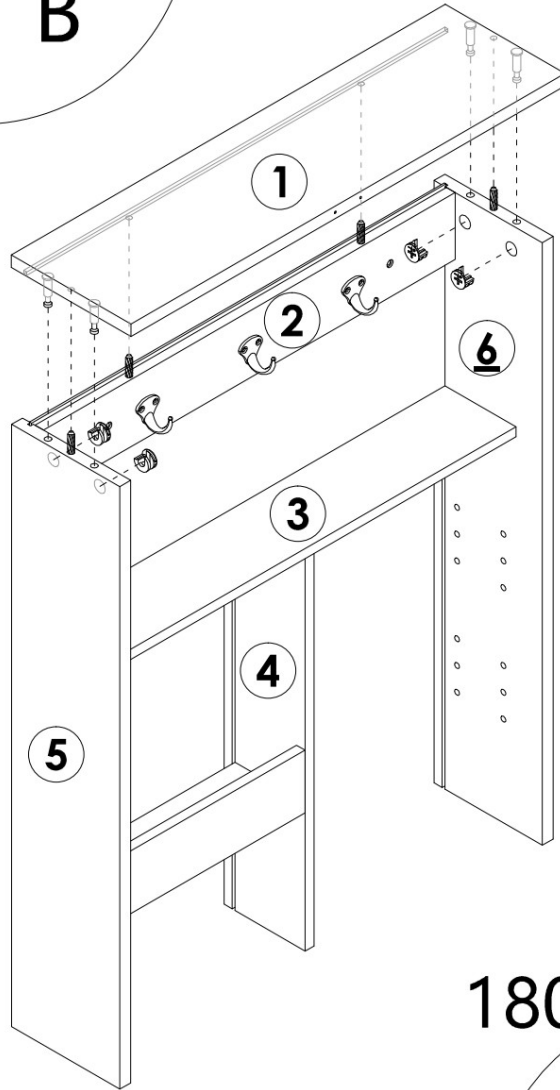
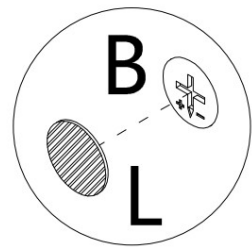
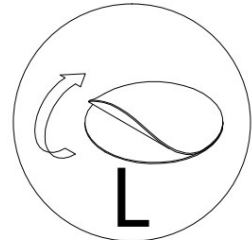
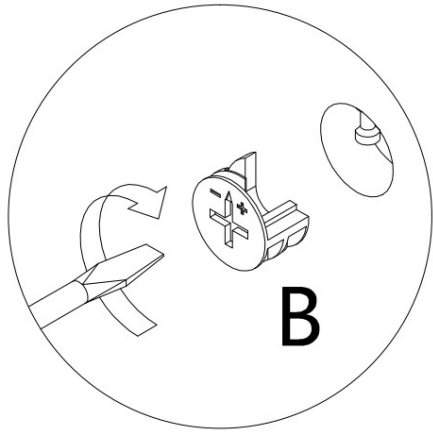

	B x 4PCS
	L x 4PCS



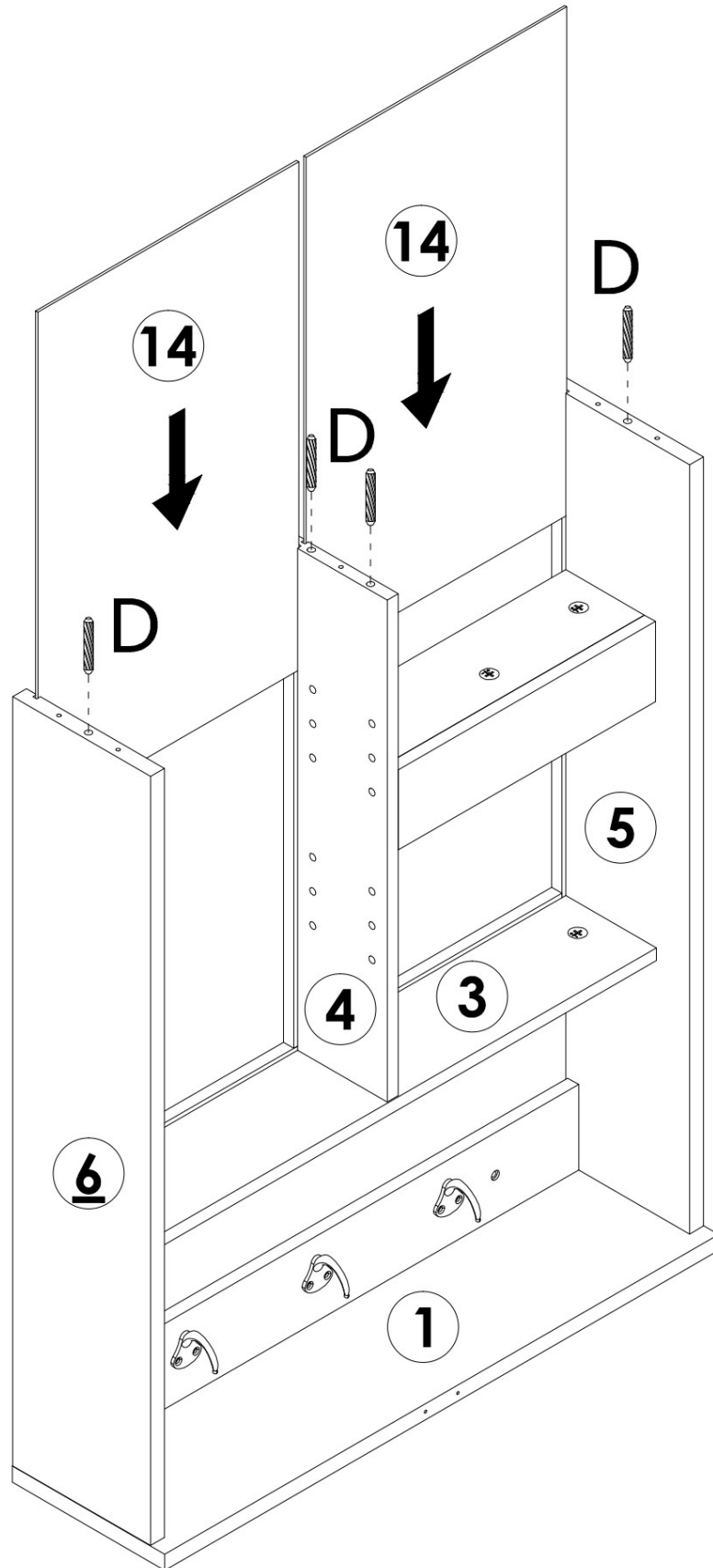

STEP 18

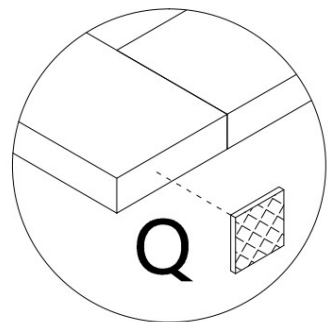
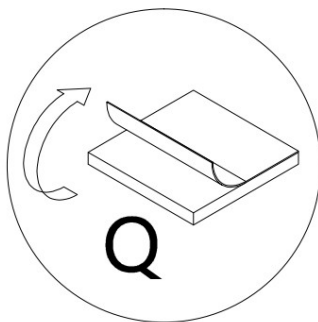
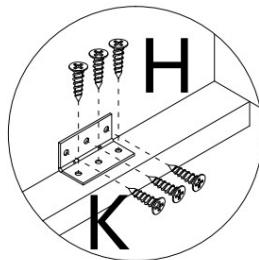
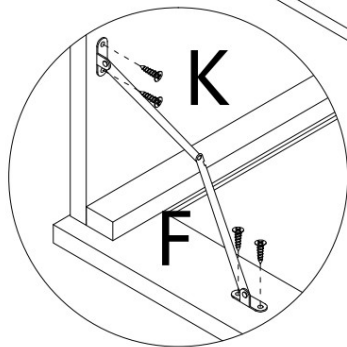
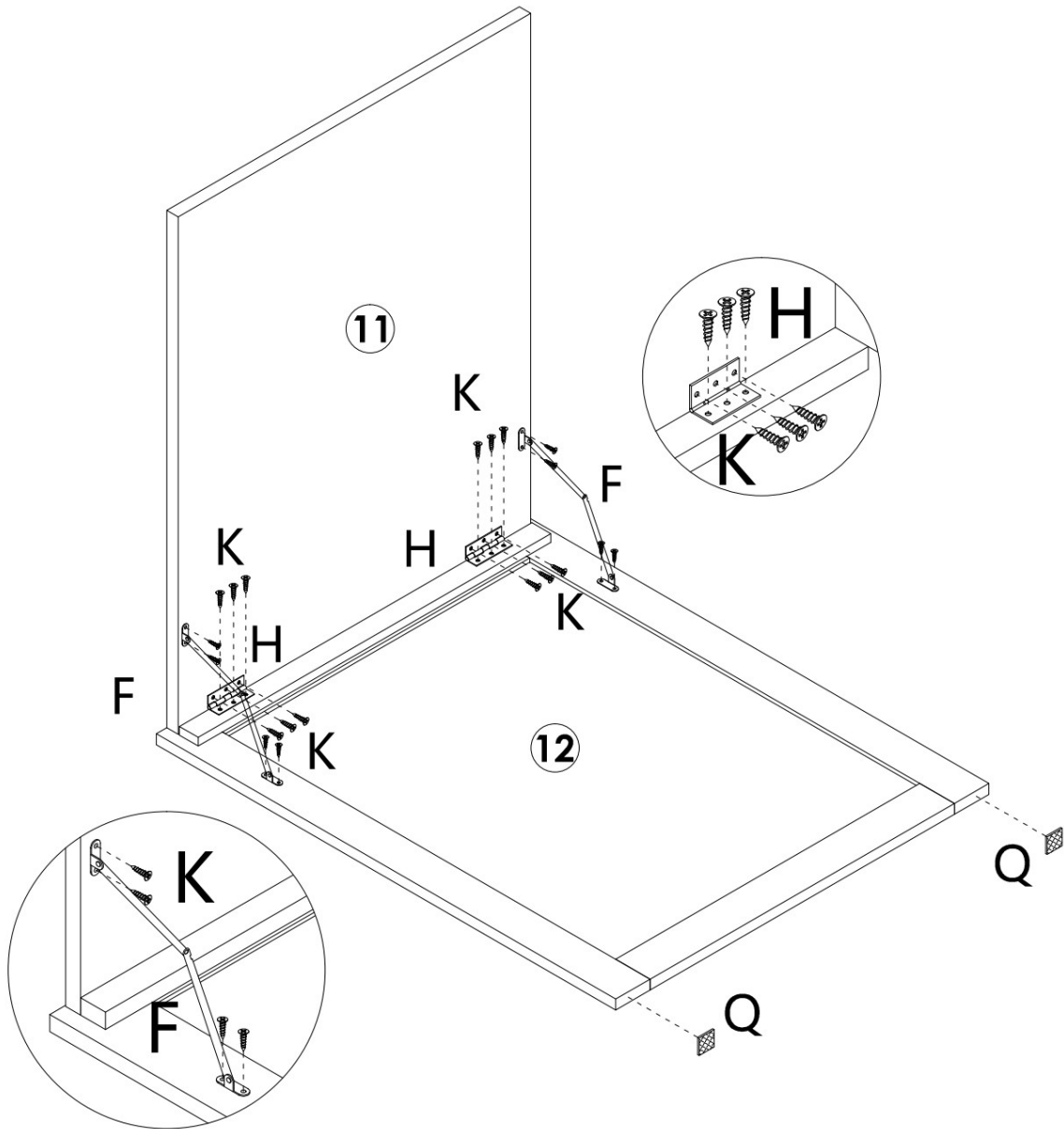

D x 4PCS



STEP 19

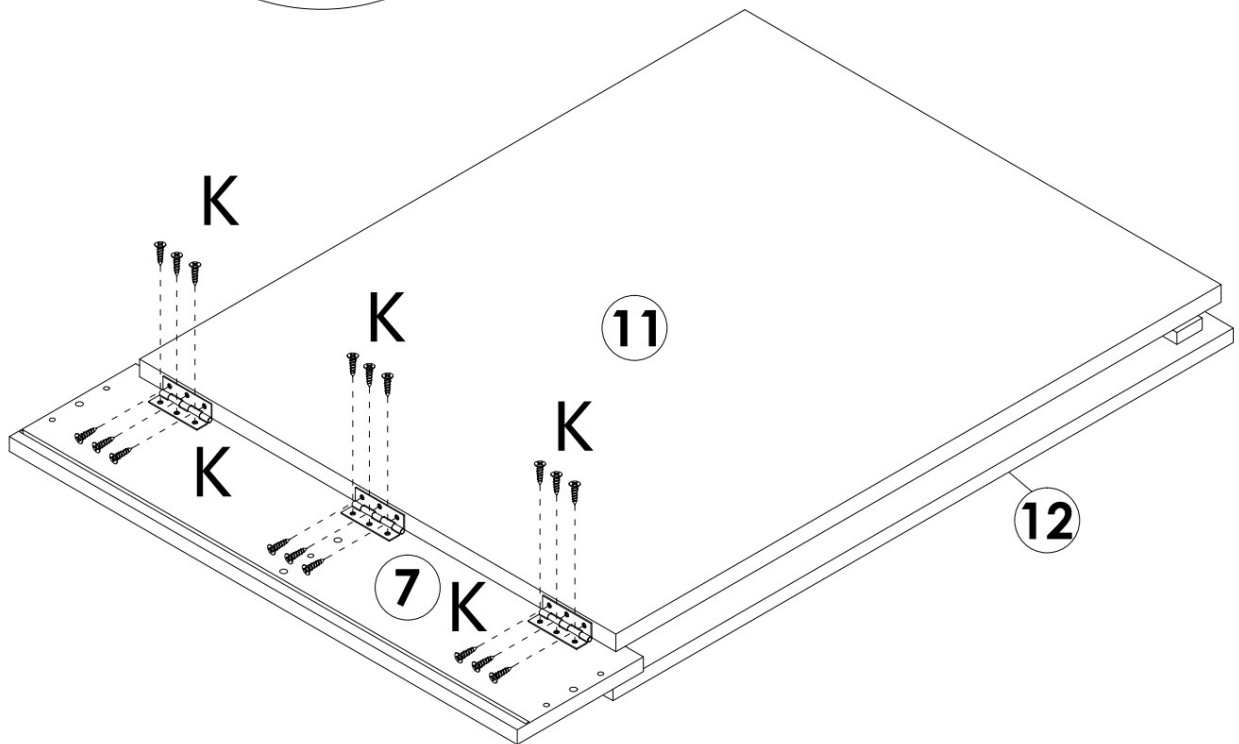
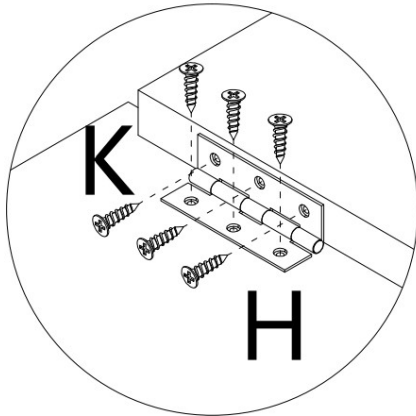

	F x 2PCS
	H x 2PCS
	K x 20PCS
	Q x 2PCS

STEP 20



	H x 3PCS
	K x 18PCS

STEP 21

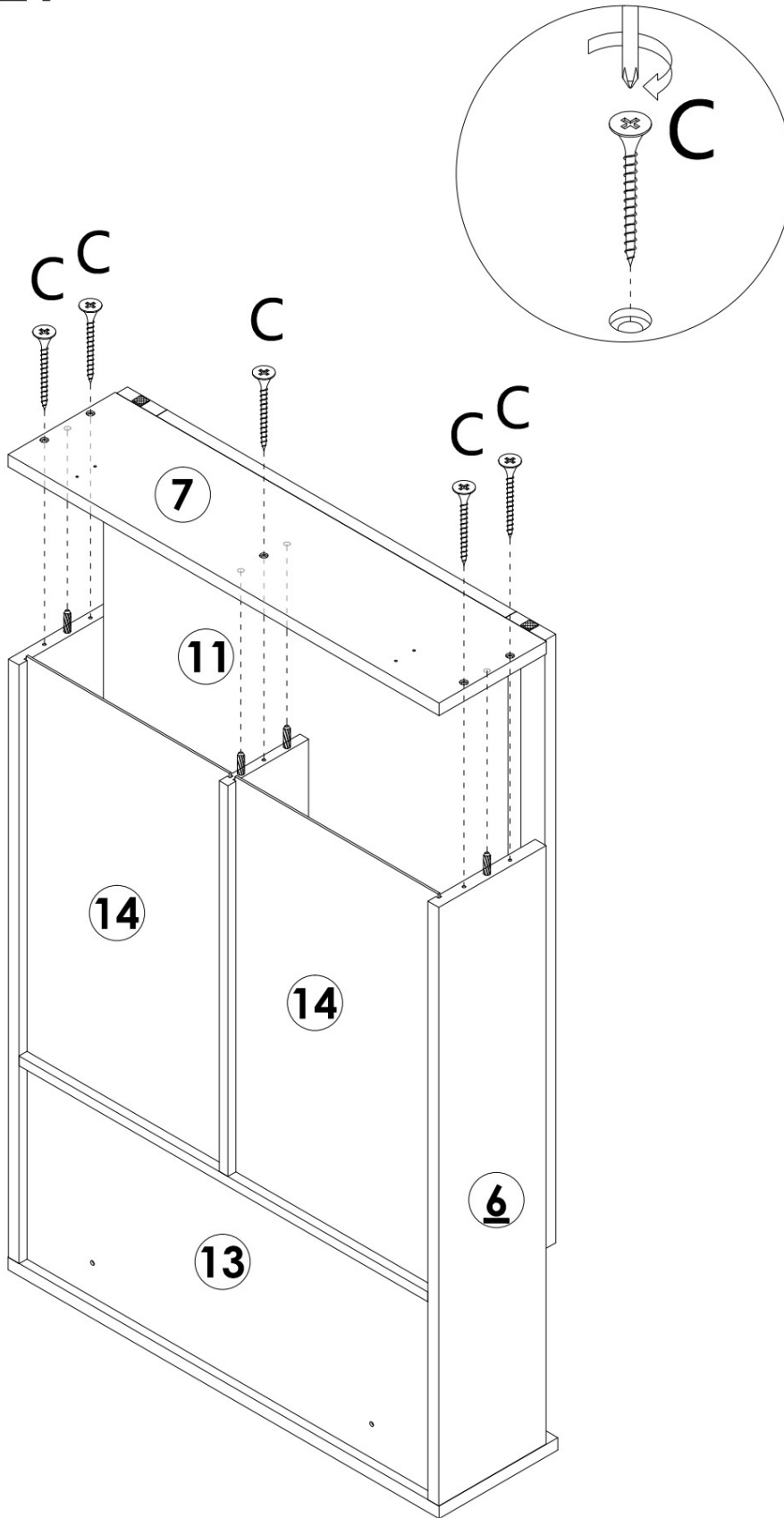

 **C x 5PCS**

STEP 22

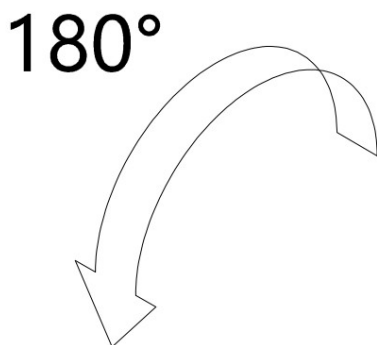
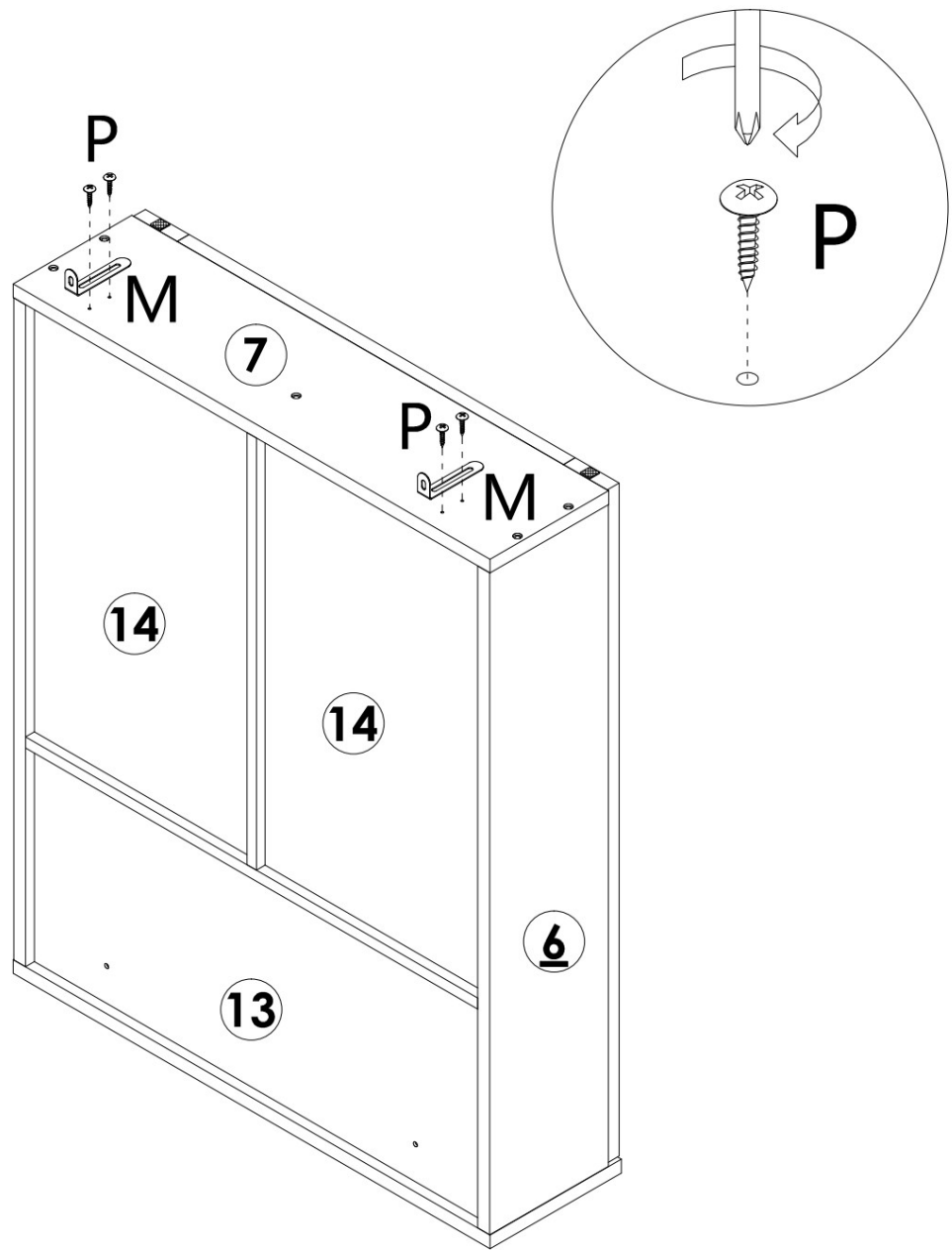

	P x 4PCS
	M x 2PCS

STEP 23

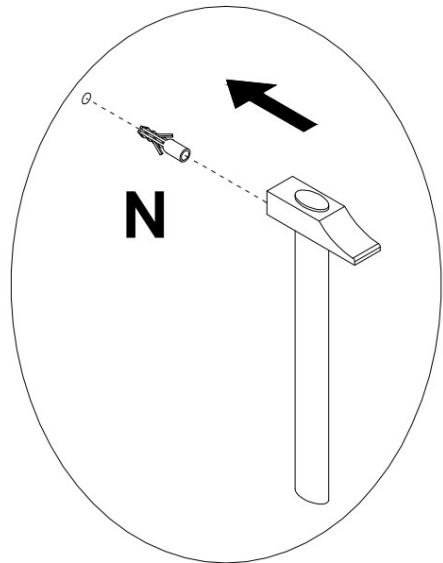
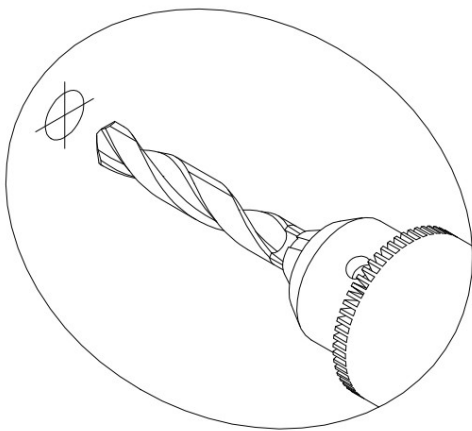
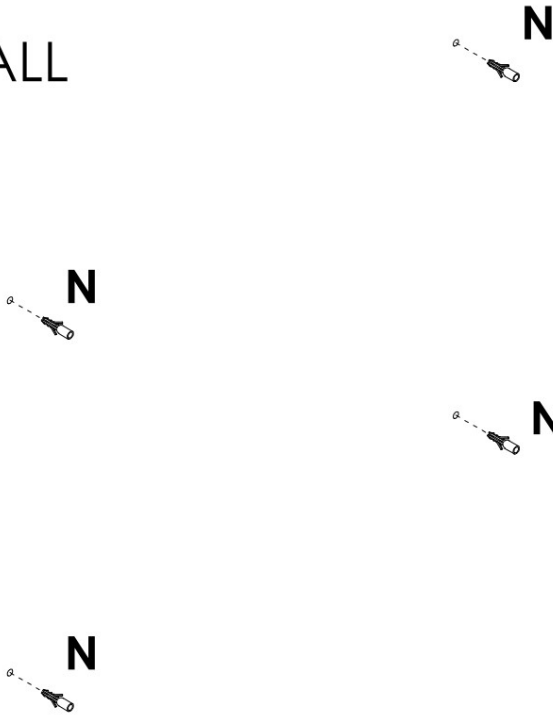

WALL

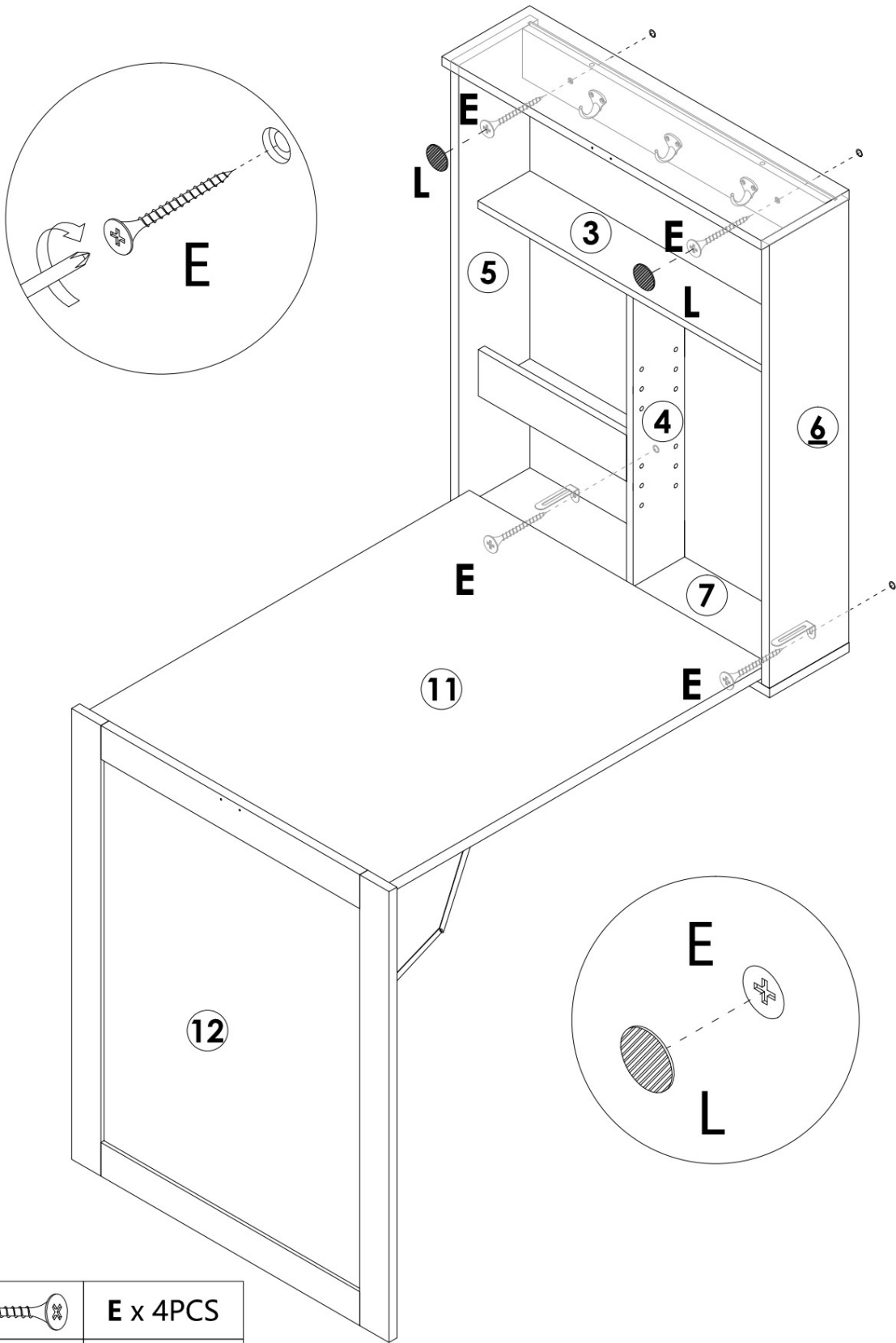

N x 4PCS

STEP 24

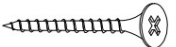

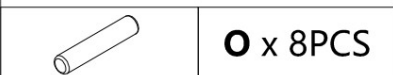
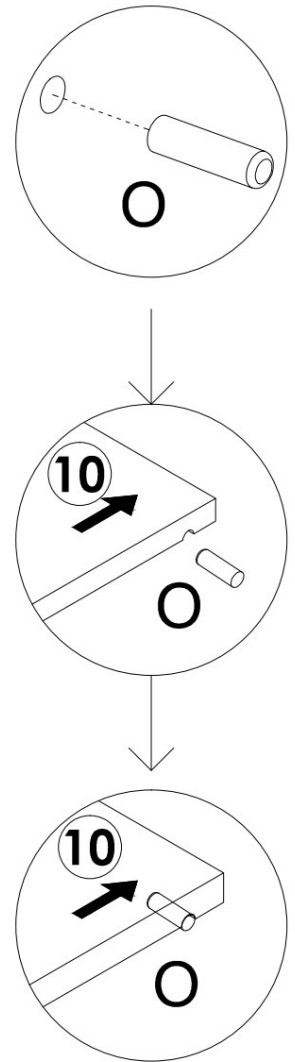
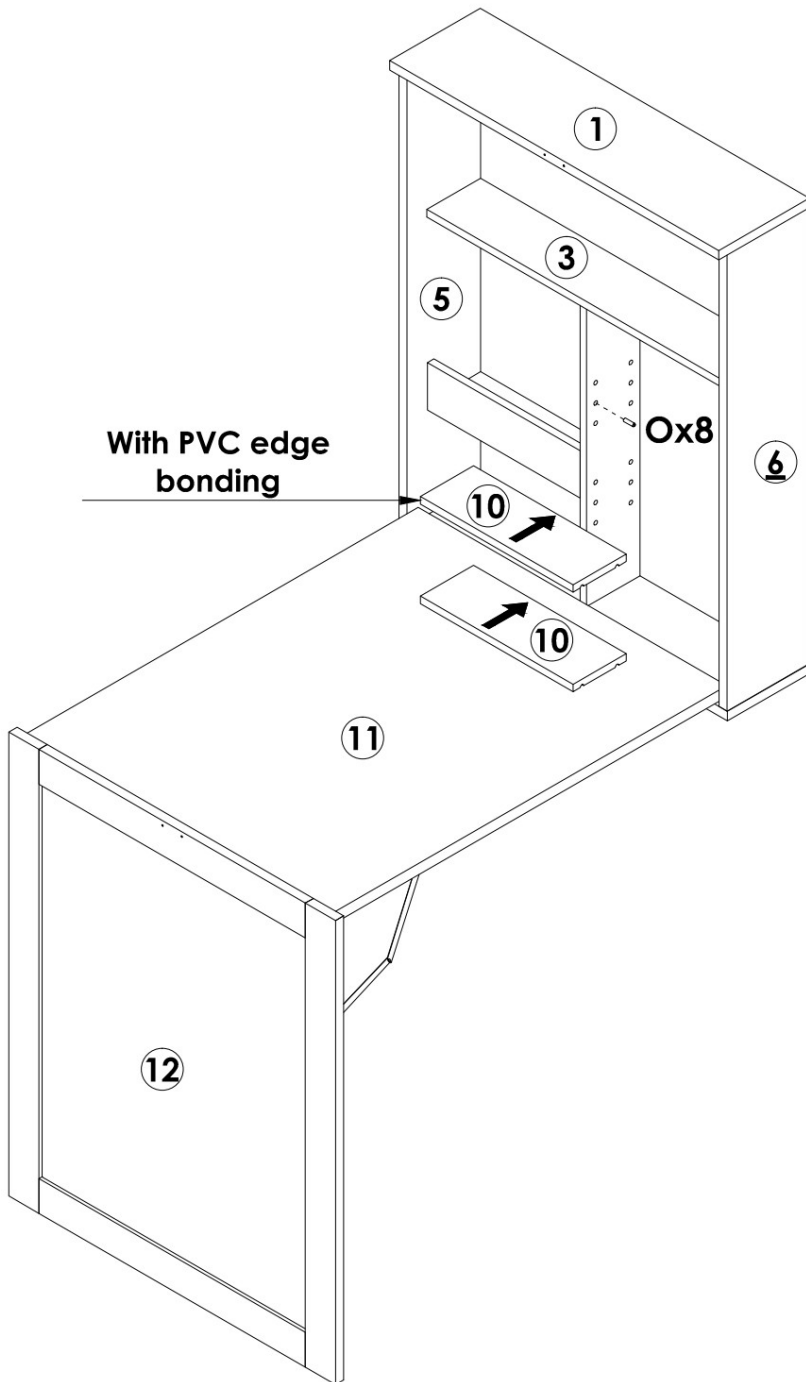

	E x 4PCS
	L x 2PCS

STEP 25

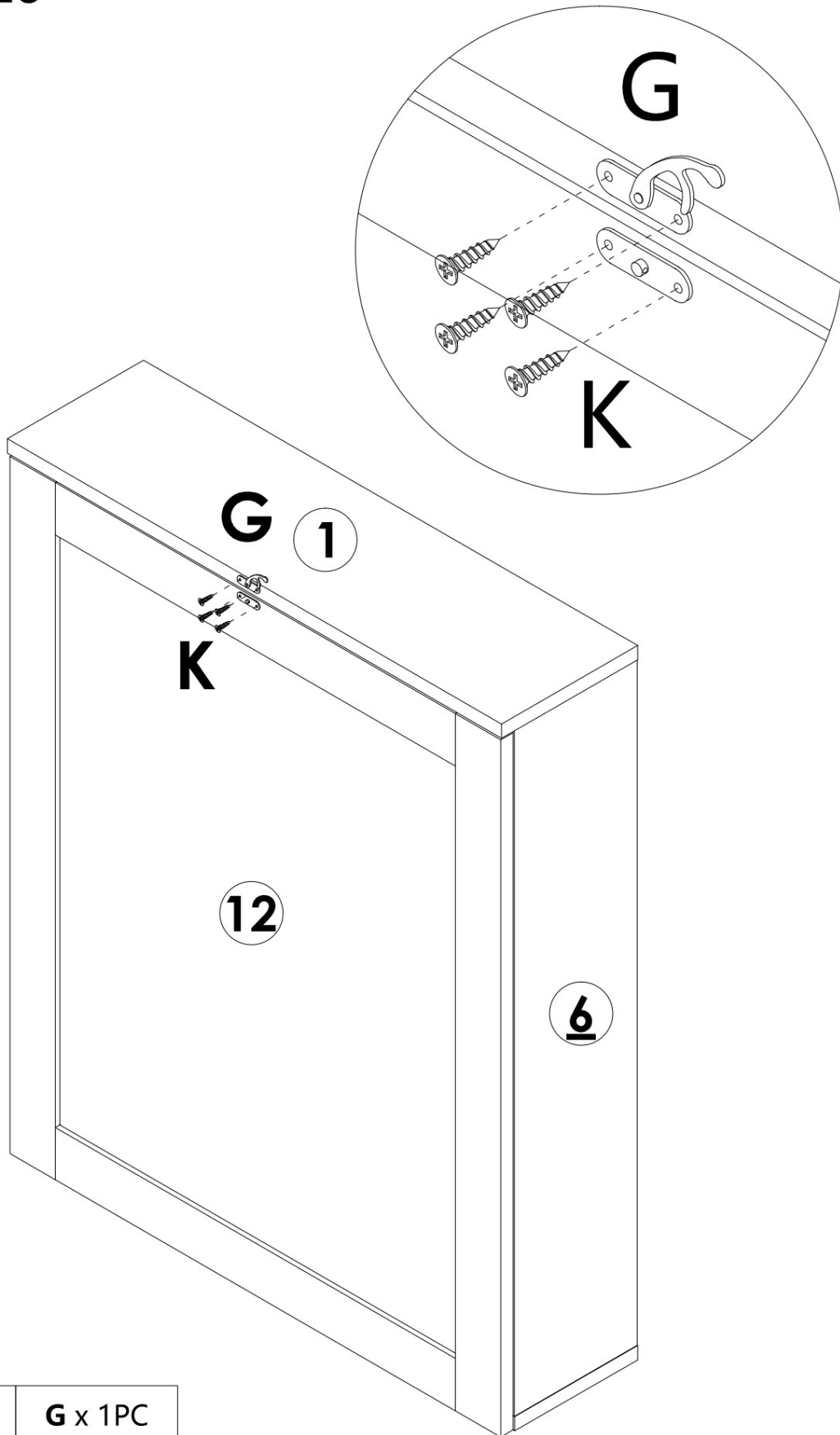

STEP 26



	G x 1PC
	K x 4PCS

UKOŃCZENIE

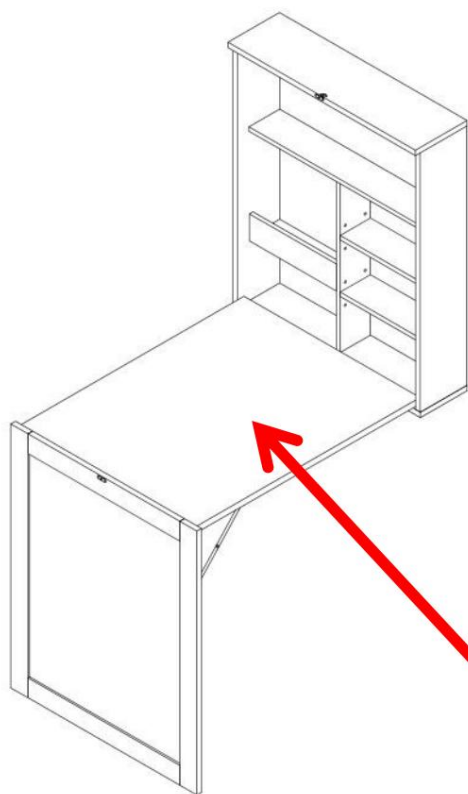

45,35 kg, równomierne rozłożenie

PARAMETR PRODUKTU

Model	HZCD003
Bezpieczna waga załadunkowa	45,35 kg
Rozmiar produktu	600*165*1470 mm

Adres: Shuangchenglu 803nong11hao1602A-1609shi, baoshanqu, szanghaj 200000 CN.

Importowane do AUS: SIHAO PTY LTD, 1 ROKEVA STREET EASTWOOD NSW 2122 Australia

Importowane do USA: Sanven Technology Ltd. Suite 250, 9166 Anaheim Place, Rancho Cucamonga, CA 91730

Przedstawiciel UE

E-CrossStu GmbH.
Mainzer Landstr.69, 60329 Frankfurt nad Menem.

REP WIELKIEJ BRYTANII

YH CONSULTING LIMITED.
C/O YH Consulting Limited Biuro 147, Centurion House, London Road, Staines-upon-Thames, Surrey, TW18 4AX

VEVOR®
TOUGH TOOLS, HALF PRICE

Wsparcie techniczne i certyfikat gwarancji
elektronicznej www.vevor.com/support

VEVOR[®]

TOUGH TOOLS, HALF PRICE

Technische ondersteuning en e-garantiecertificaat www.vevor.com/support

Zwevend bureau

GEBRUIKERSHANDLEIDING

MODEL:HZCD003

Wij streven er voortdurend naar om u gereedschappen tegen concurrerende prijzen te leveren.

"Bespaar de helft", "halve prijs" of andere soortgelijke uitdrukkingen die wij gebruiken, geven alleen een schatting van de besparingen die u kunt behalen door bepaalde gereedschappen bij ons te kopen in vergelijking met de grote topmerken en doseringen betekenen niet noodzakelijkerwijs dat ze alle categorieën gereedschappen dekken die wij aanbieden. Wij herinneren u eraan om zorgvuldig te controleren of u daadwerkelijk de helft bespaart in vergelijking met de grote topmerken wanneer u een bestelling bij ons plaatst.

VEVOR[®]
TOUGH TOOLS, HALF PRICE

Zwevend bureau

MODEL:HZCD003



HULP NODIG? NEEM CONTACT MET ONS OP!

Heeft u vragen over het product? Heeft u technische ondersteuning nodig? Neem dan gerust contact met ons op:

**Technische ondersteuning en e-
garantiecertificaat www.vevor.com/support**

Dit is de originele instructie, lees alle handleidingen zorgvuldig door voordat u het product gebruikt. VEVOR behoudt zich een duidelijke interpretatie van onze gebruikershandleiding voor. Het uiterlijk van het product is afhankelijk van het product dat u hebt ontvangen. Vergeef ons dat we u niet opnieuw zullen informeren als er technologie- of software-updates voor ons product zijn.

VEILIGHEIDSINSTRUCTIES

WAARSCHUWING:

Lees dit materiaal voordat u dit product gebruikt. Als u dit niet doet, kan dit leiden tot ernstig letsel tot gevolg hebben.

Voorzorgsmaatregelen bij de montage

1. Monteer alleen volgens deze instructies. Onjuiste montage kan gevaren creëren.
2. Draag een door ANSI goedgekeurde veiligheidsbril en stevige werkhandschoenen tijdens de montage.
3. Zorg ervoor dat de verzamelplaats schoon en goed verlicht is.
4. Houd omstanders uit de buurt tijdens de montage.
5. Kom niet bijeen als u moe bent of onder invloed van alcohol, drugs of medicijnen.
6. De producteigenschappen gelden voor correct en volledig gemonteerde producten. alleen producten.
7. Monteer op een vlak, egaal, hard en glad oppervlak dat veilig kan worden gebruikt ter ondersteuning van het Floating Desk.
8. Voor aanvullende informatie over de onderdelen die in de volgende lijst staan vermeld, pagina's, raadpleeg dan het montageschema van deze handleiding. Uitpakken en scheid alle onderdelen in een schone werkruimte.









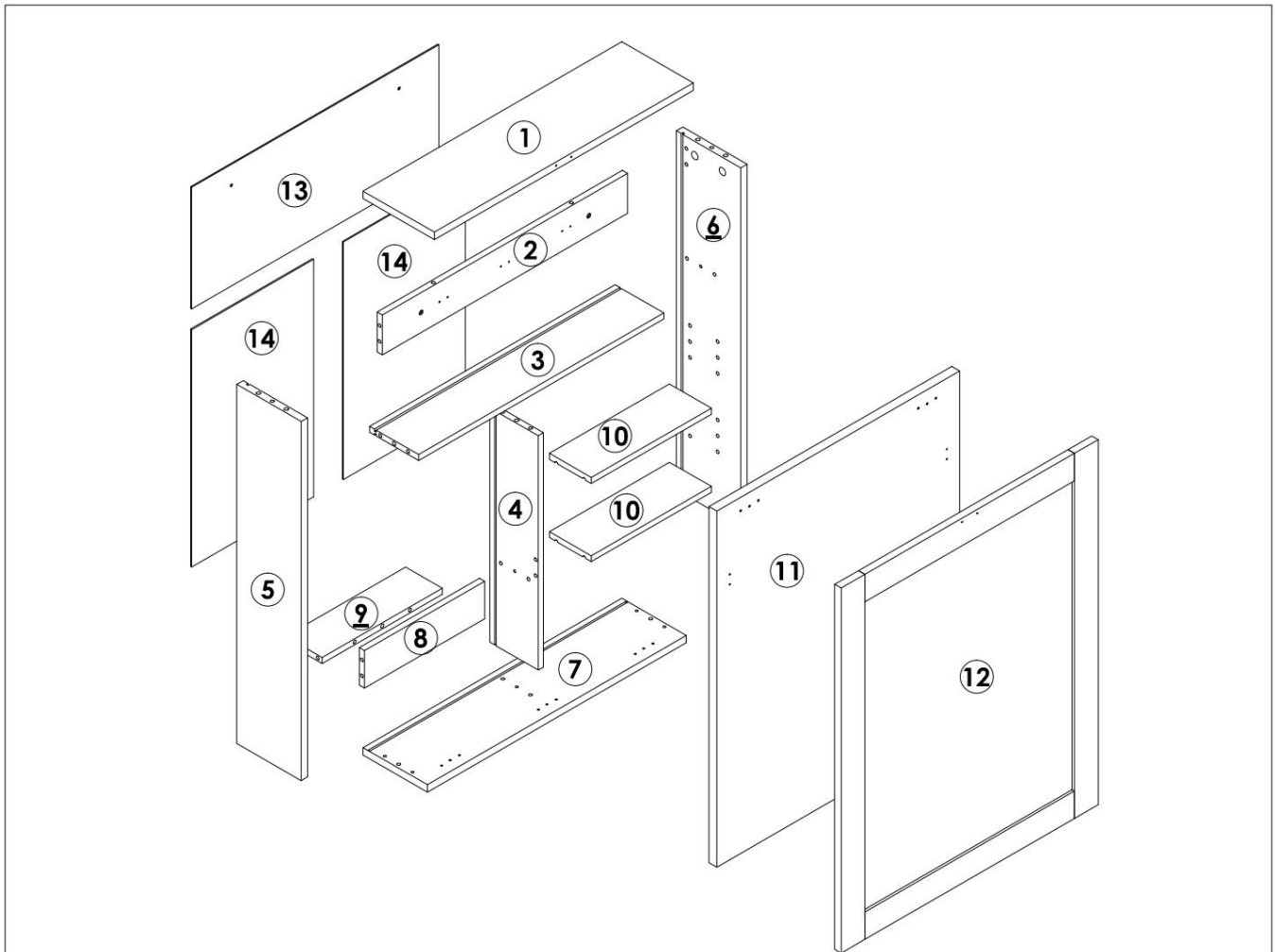

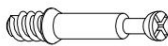



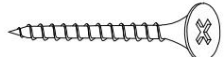
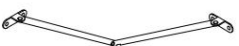

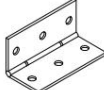
Neem voorzorgsmaatregelen

1. NIET OP DIT ITEM ZITTEN OF STAAN.
2. Dit product is geen speelgoed. Laat kinderen niet met of in de buurt van dit product spelen. item.
3. Overschrijd het toegestane gewicht niet.
4. Gebruik het product alleen zoals bedoeld.
5. Controleer het apparaat voor elk gebruik. Gebruik het apparaat niet als er onderdelen loszitten of beschadigd zijn.

BEWAAR DEZE HANDLEIDING

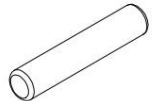
ONDERDELENLIJST

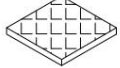

<p>A</p>  <p>M6x35mm 10+1PCS</p>	<p>B</p>  <p>Ø15x9mm 10+1PCS</p>	<p>C</p>  <p>M4x40mm 5PCS</p>	<p>D</p>  <p>Ø6x30mm 30+2PCS</p>	<p>E</p>  <p>M5x60mm 4PCS</p>
<p>F</p>  <p>2PCS</p>	<p>G</p>  <p>1PC</p>	<p>H</p>  <p>5PCS</p>	<p>I</p>  <p>3PCS</p>	<p>J</p>  <p>M3x14mm 6PCS</p>
<p>K</p>  <p>M3x12mm 42+2PCS</p>	<p>L</p>  <p>Ø20mm 7PCS</p>	<p>M</p>  <p>2PCS</p>	<p>N</p>  <p>M8x40mm 4PCS</p>	<p>O</p>  <p>M5x20mm 8+1PCS</p>
<p>P</p>  <p>M4x12mm 4PCS</p>	<p>Q</p>  <p>16x16mm 2PCS</p>	 <p>1PC</p>		

INSTRUCTIES

STEP 1

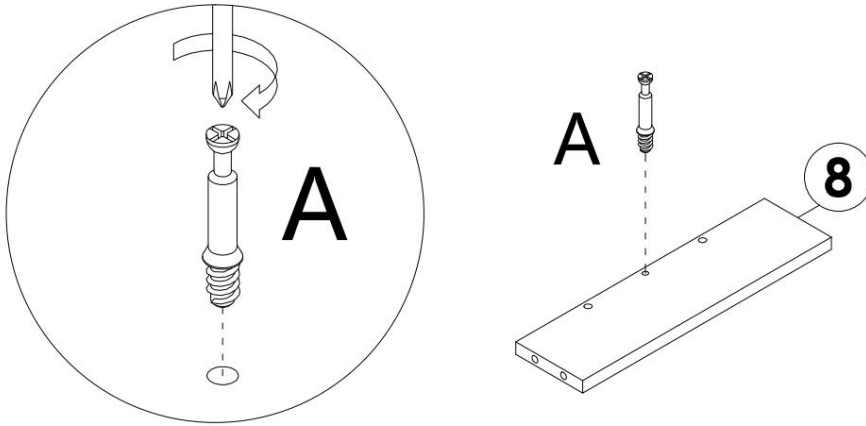

A x 1PC

STEP 2

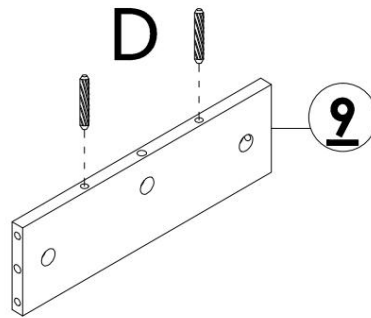

D x 2PCS

STEP 3

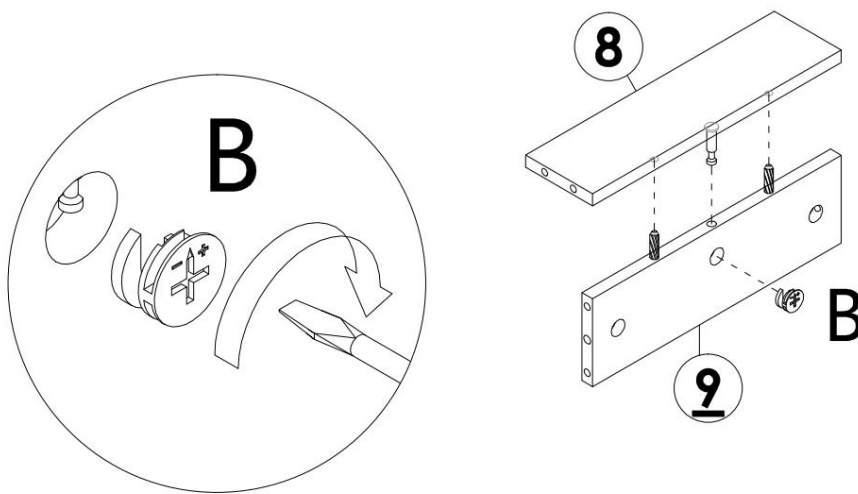

B x 1PC

STEP 4

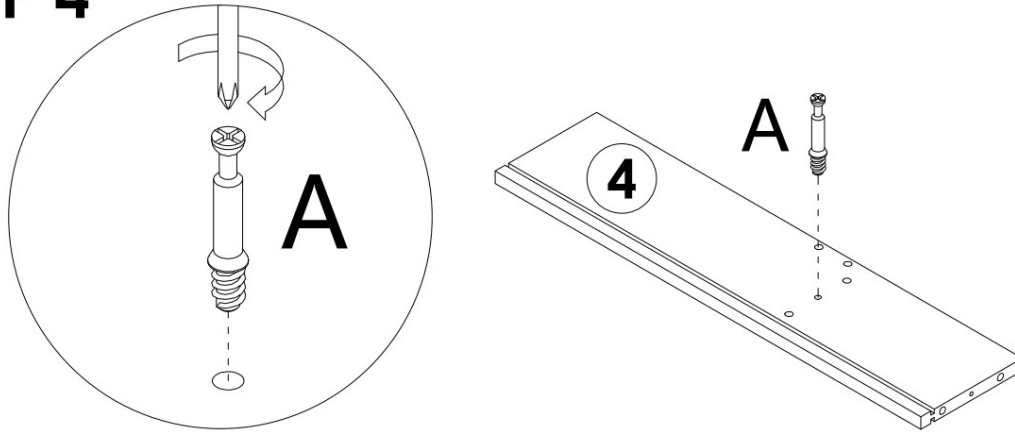

A x 1PC

STEP 5

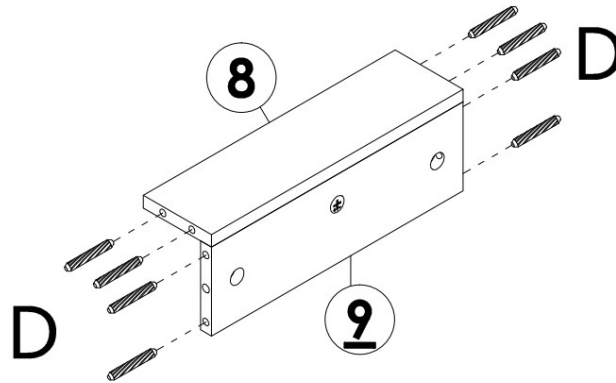

D x 8PCS

STEP 6

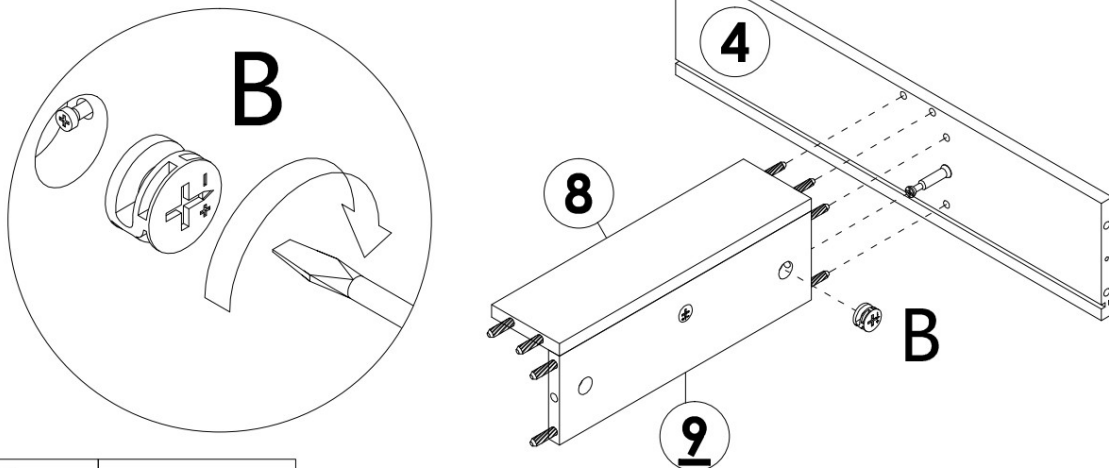

B x 1PC

STEP 7

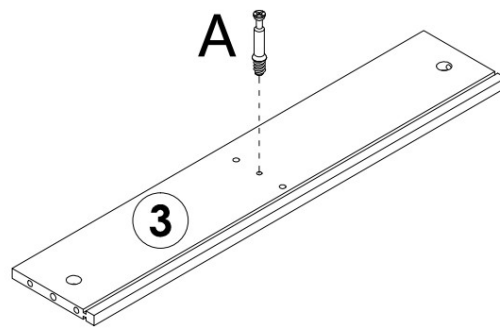
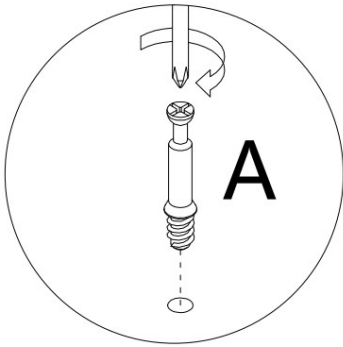

A x 1PC

STEP 8

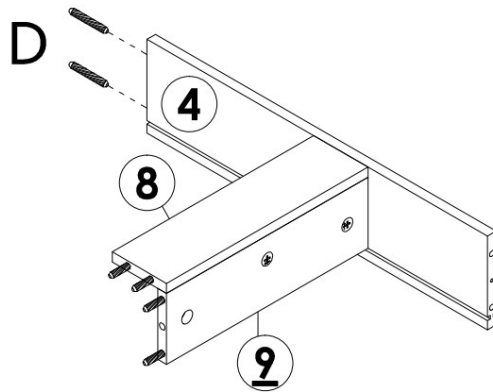

D x 2PCS

STEP 9

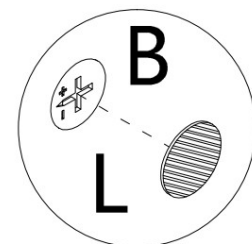
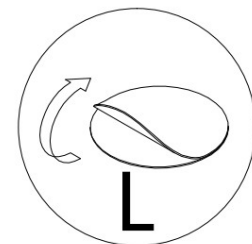
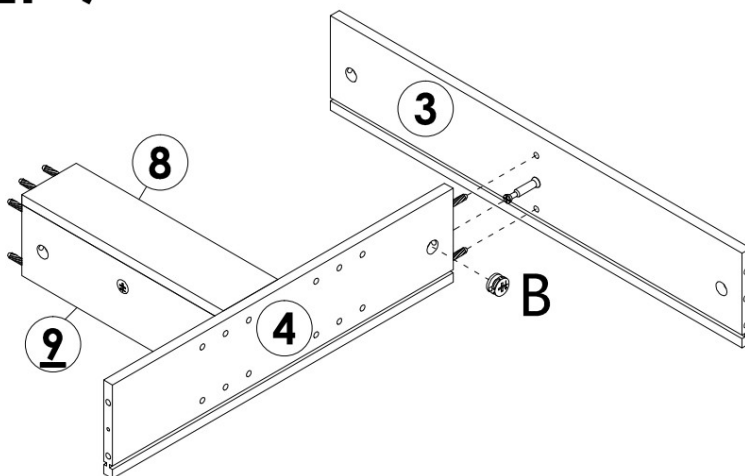



B x 1PC

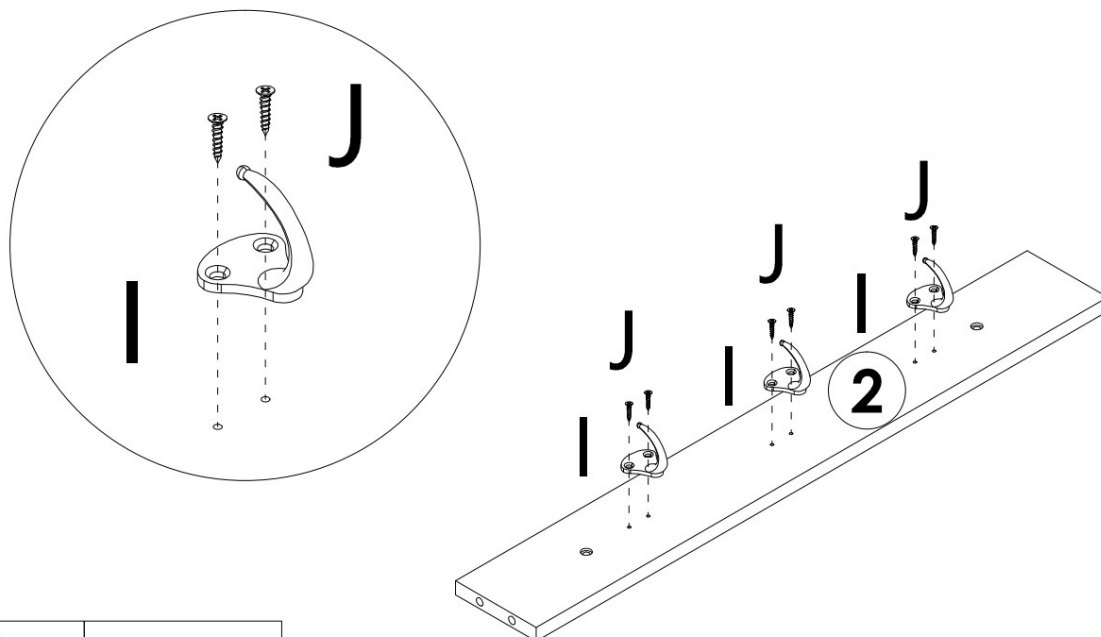

L x 1PC

STEP 10

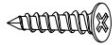

	I x 3PCS
	J x 6PCS

STEP 11

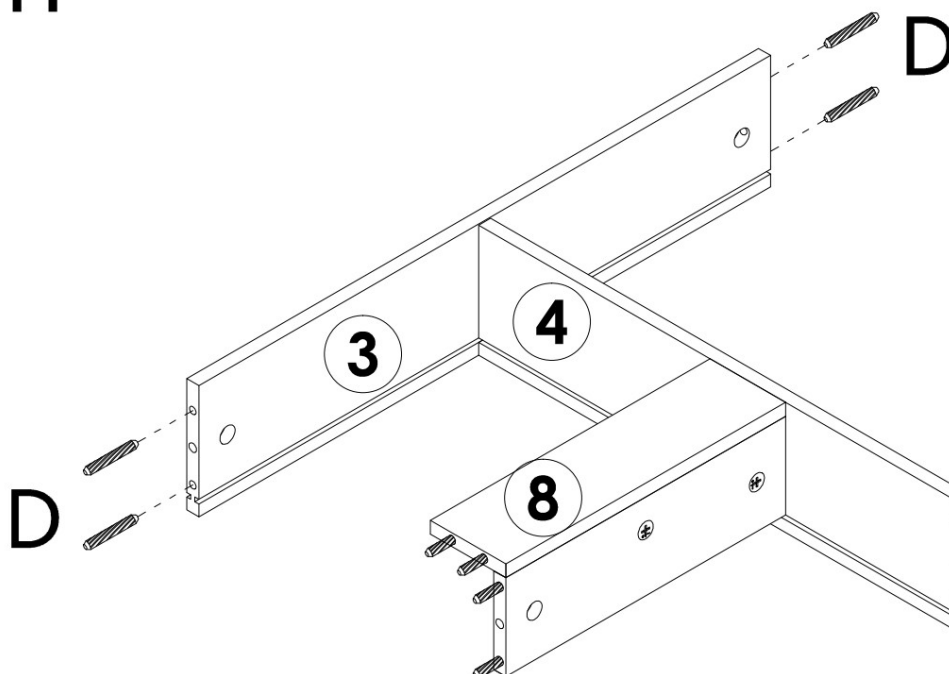

	D x 4PCS
---	----------

STEP 12

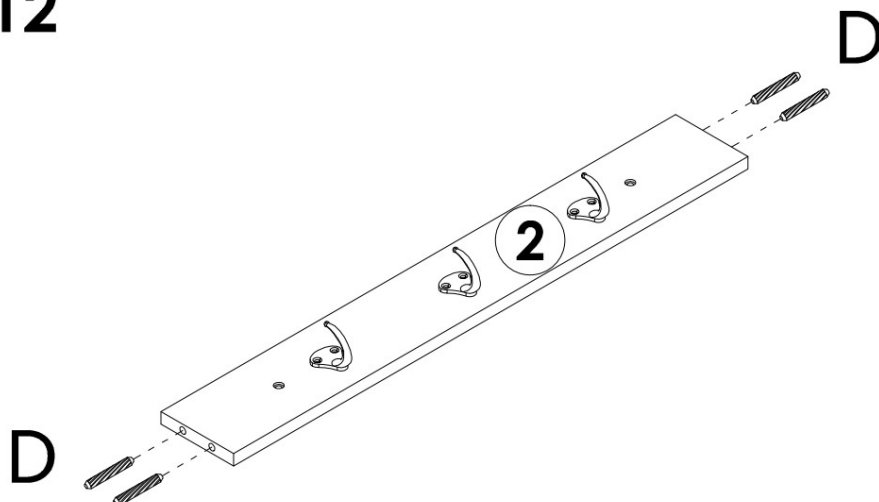

D x 4PCS

STEP 13

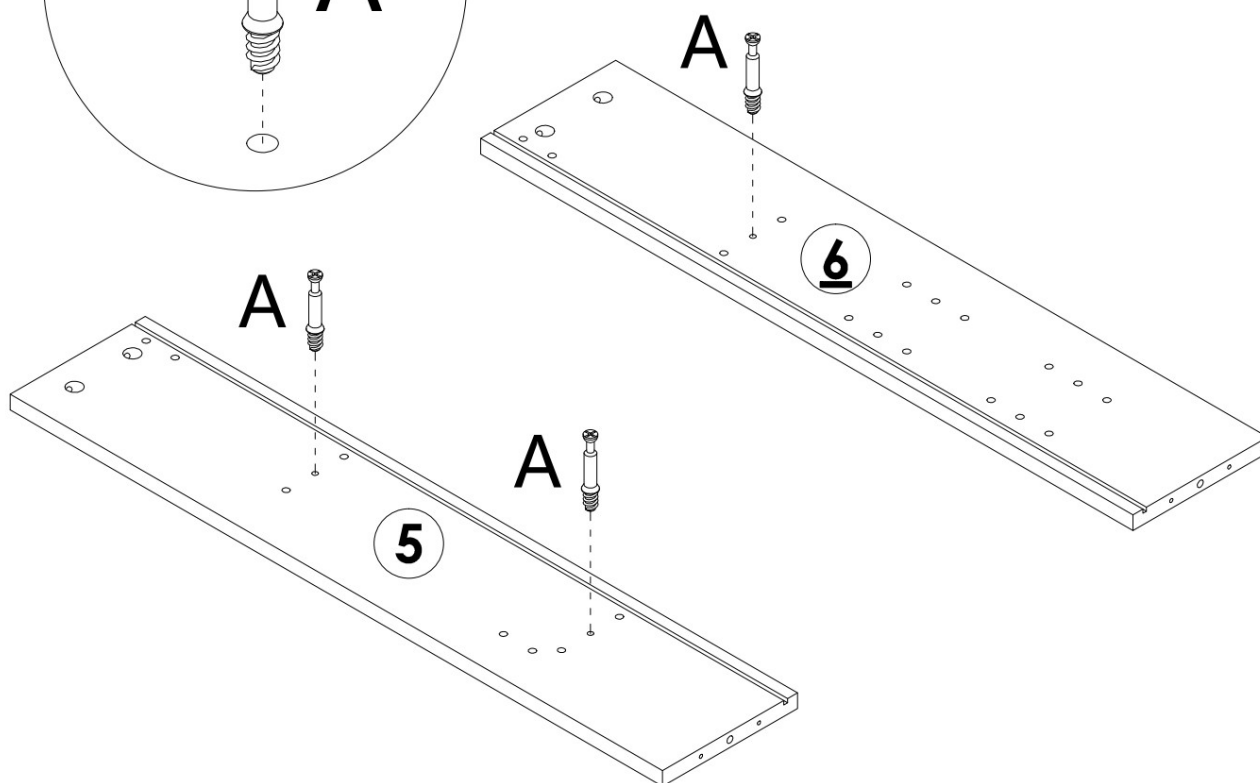
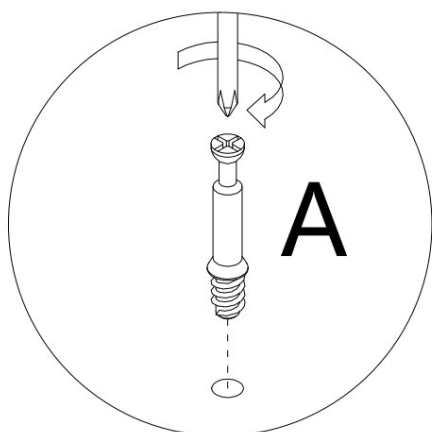

A x 3PCS

STEP 14

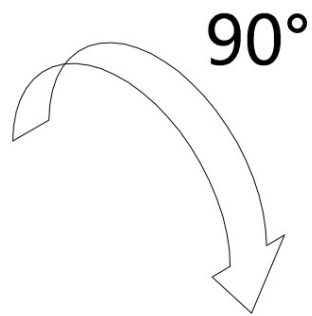
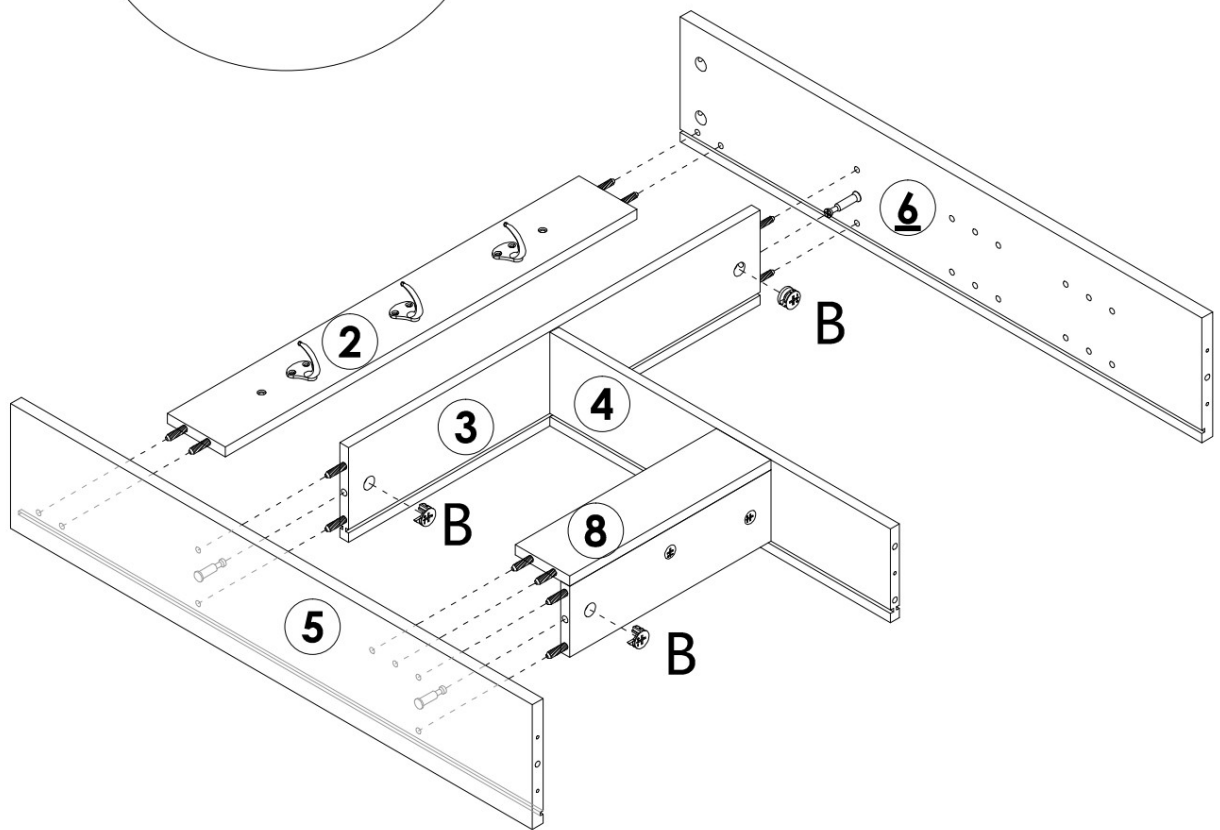
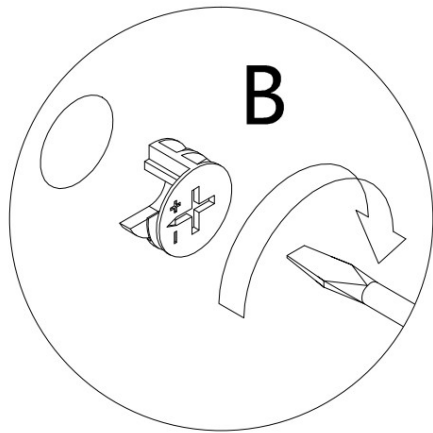

B x 3PCS

STEP 15

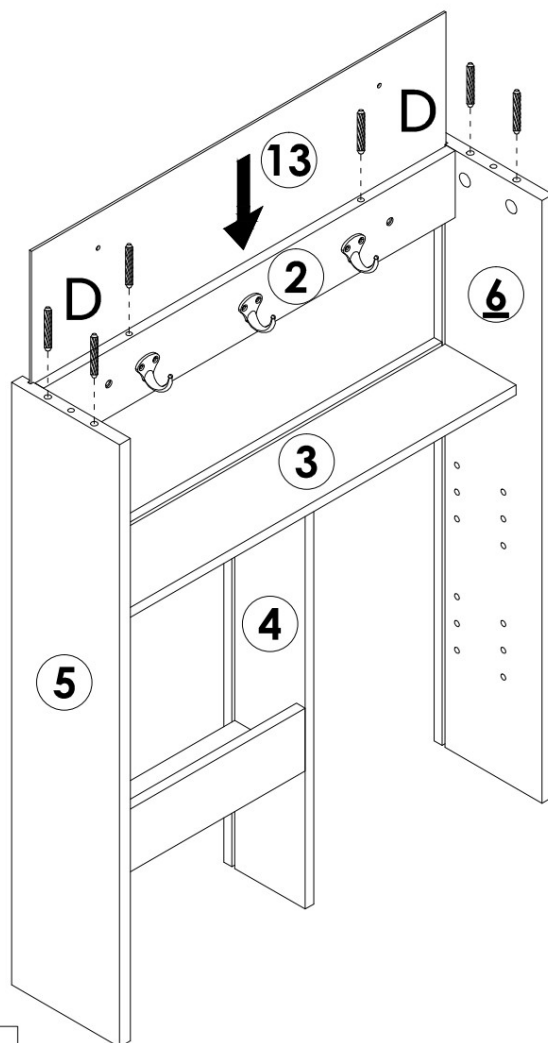

 **D x 6PCS**

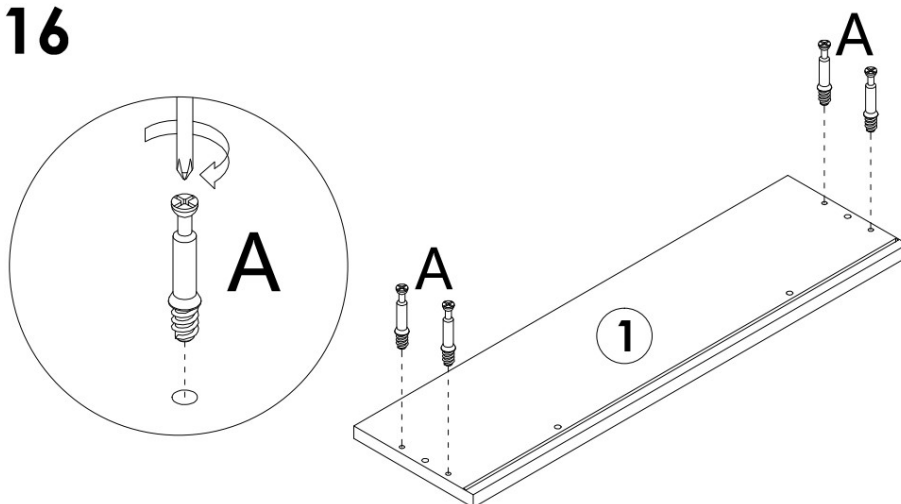

STEP 16

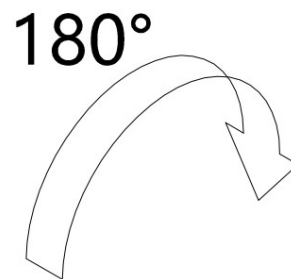
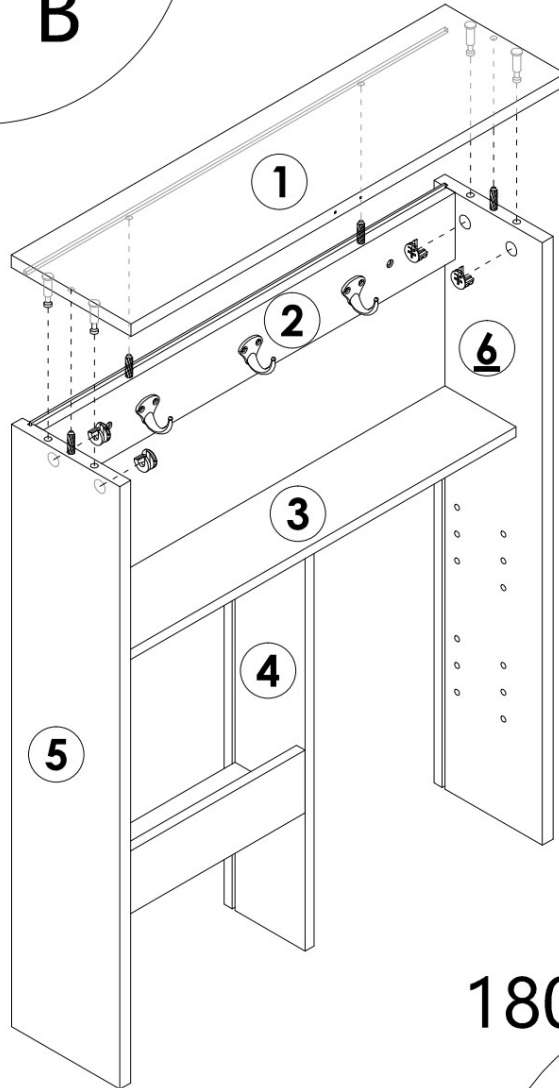
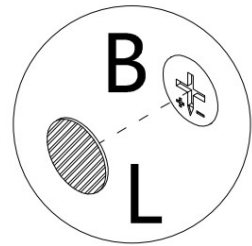
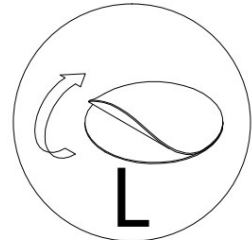
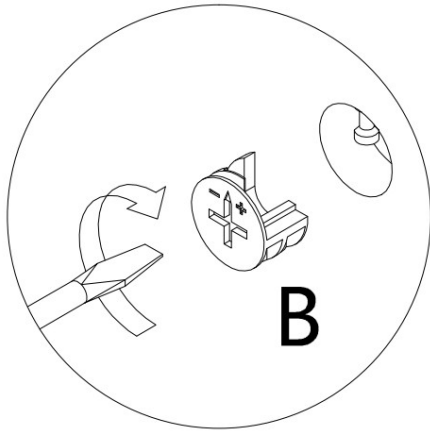

 **A x 4PCS**

STEP 17



	B x 4PCS
	L x 4PCS

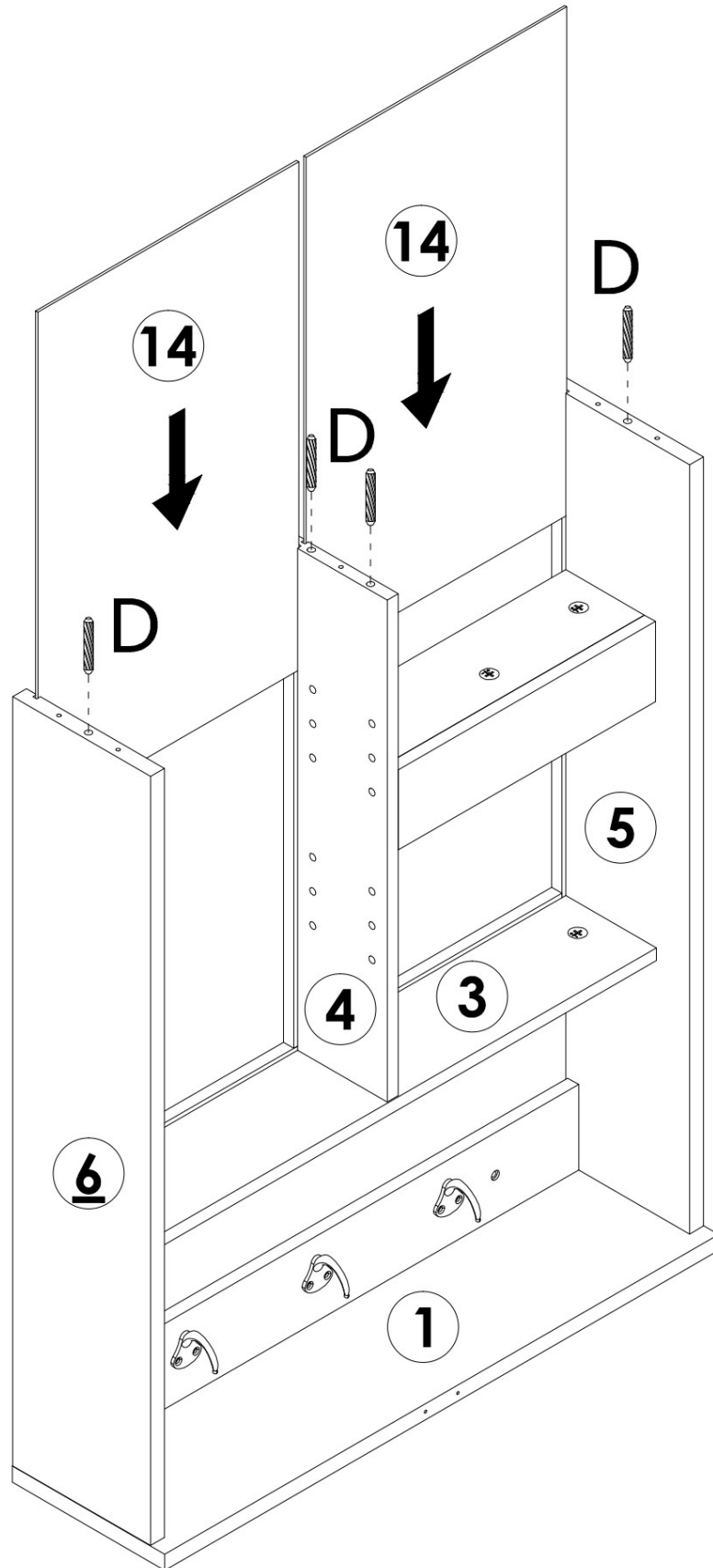

STEP 18

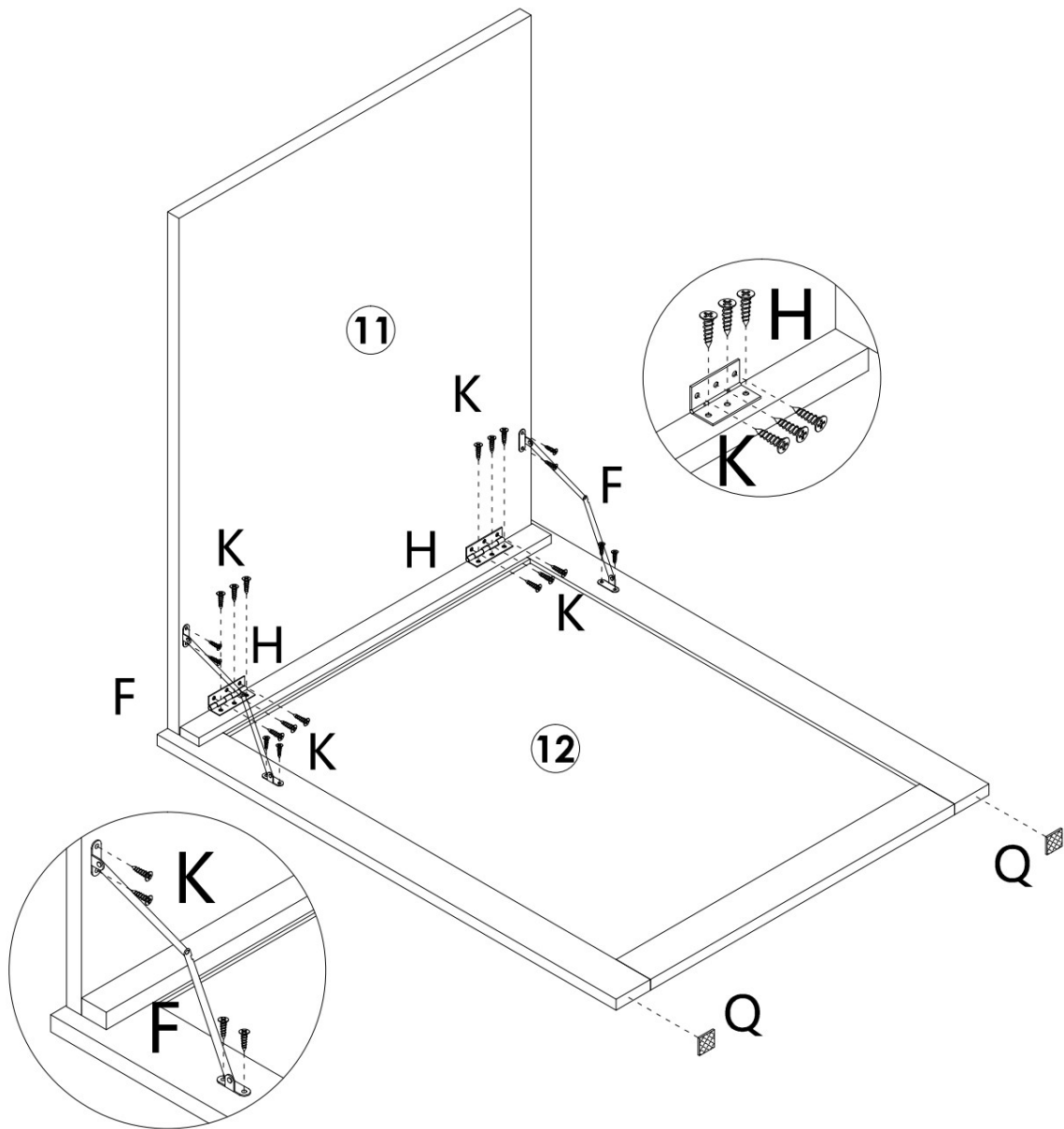

D x 4PCS

STEP 19



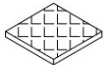

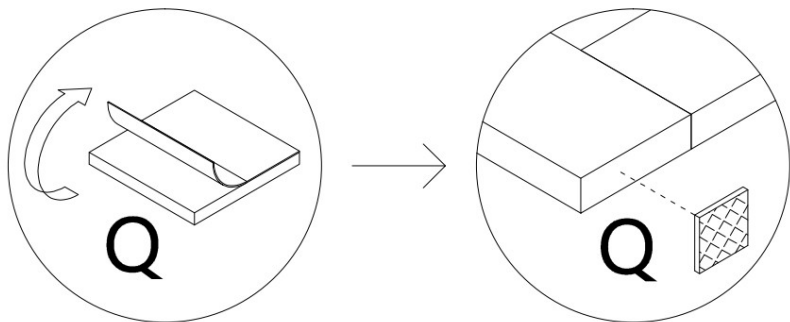
	F x 2PCS
	H x 2PCS
	K x 20PCS
	Q x 2PCS

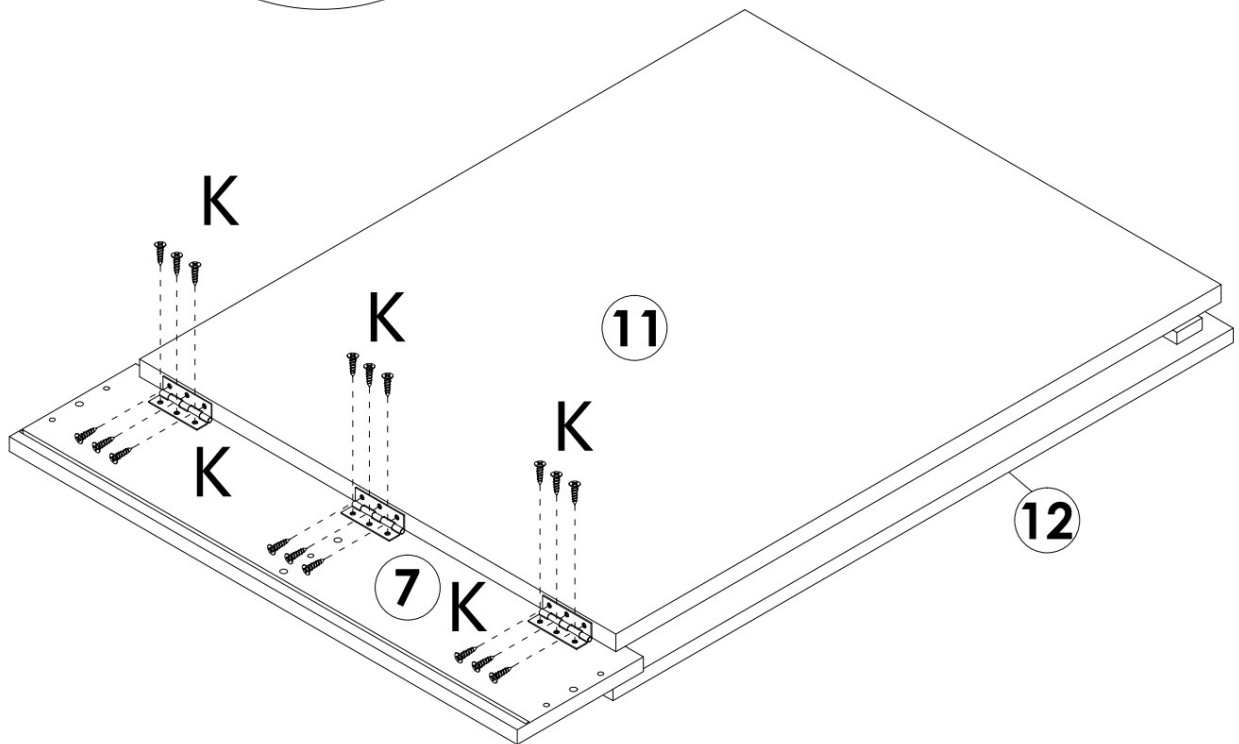
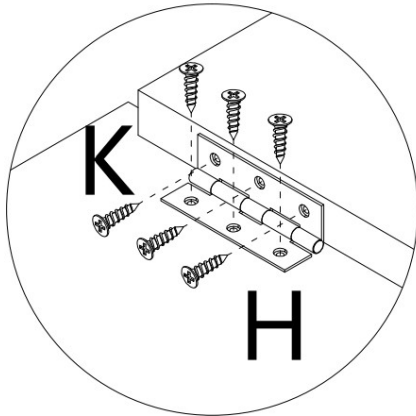

STEP 20



	H x 3PCS
	K x 18PCS

STEP 21

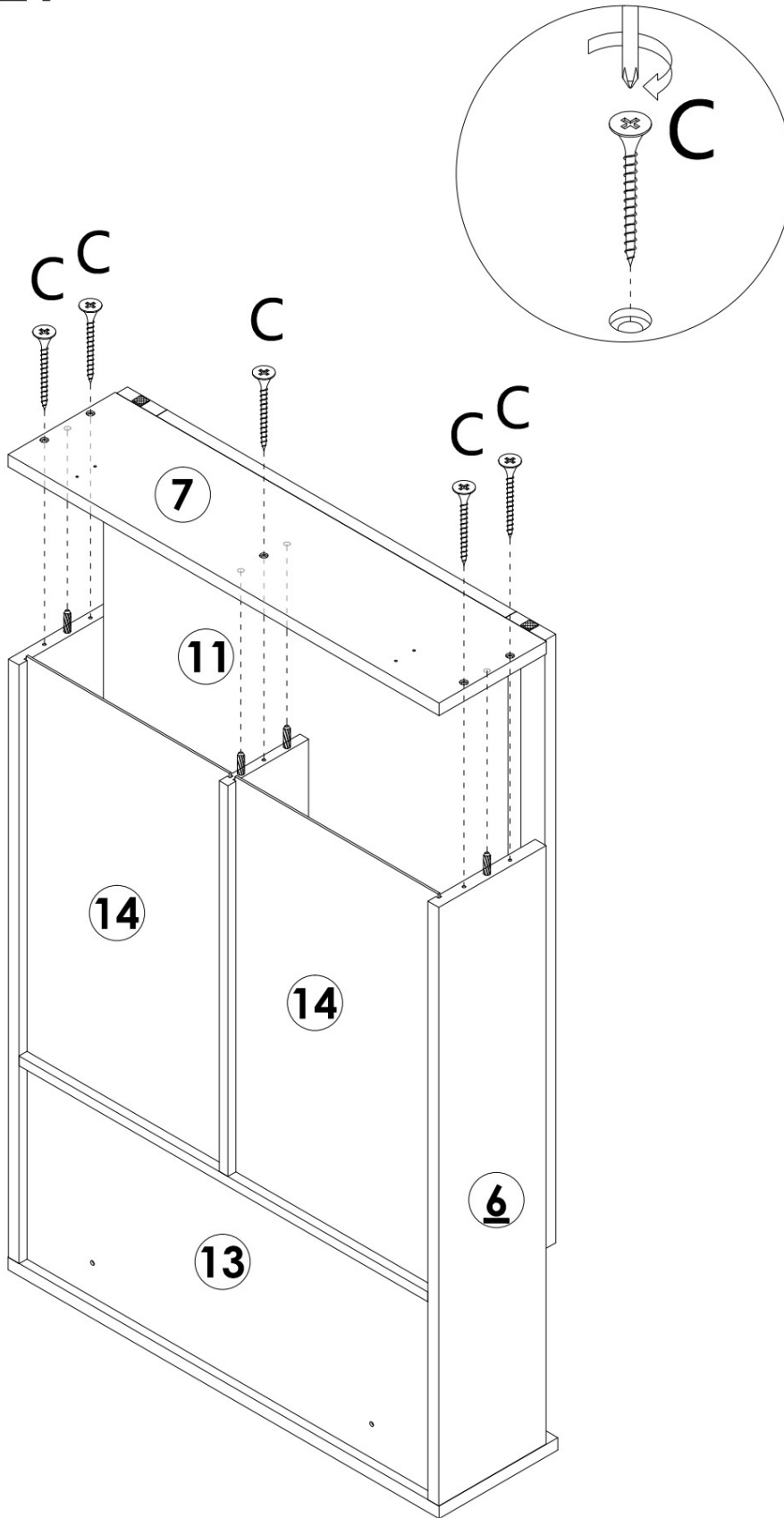

 **C x 5PCS**

STEP 22

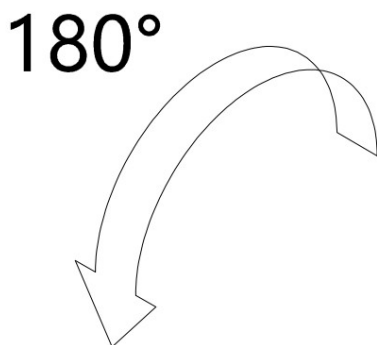
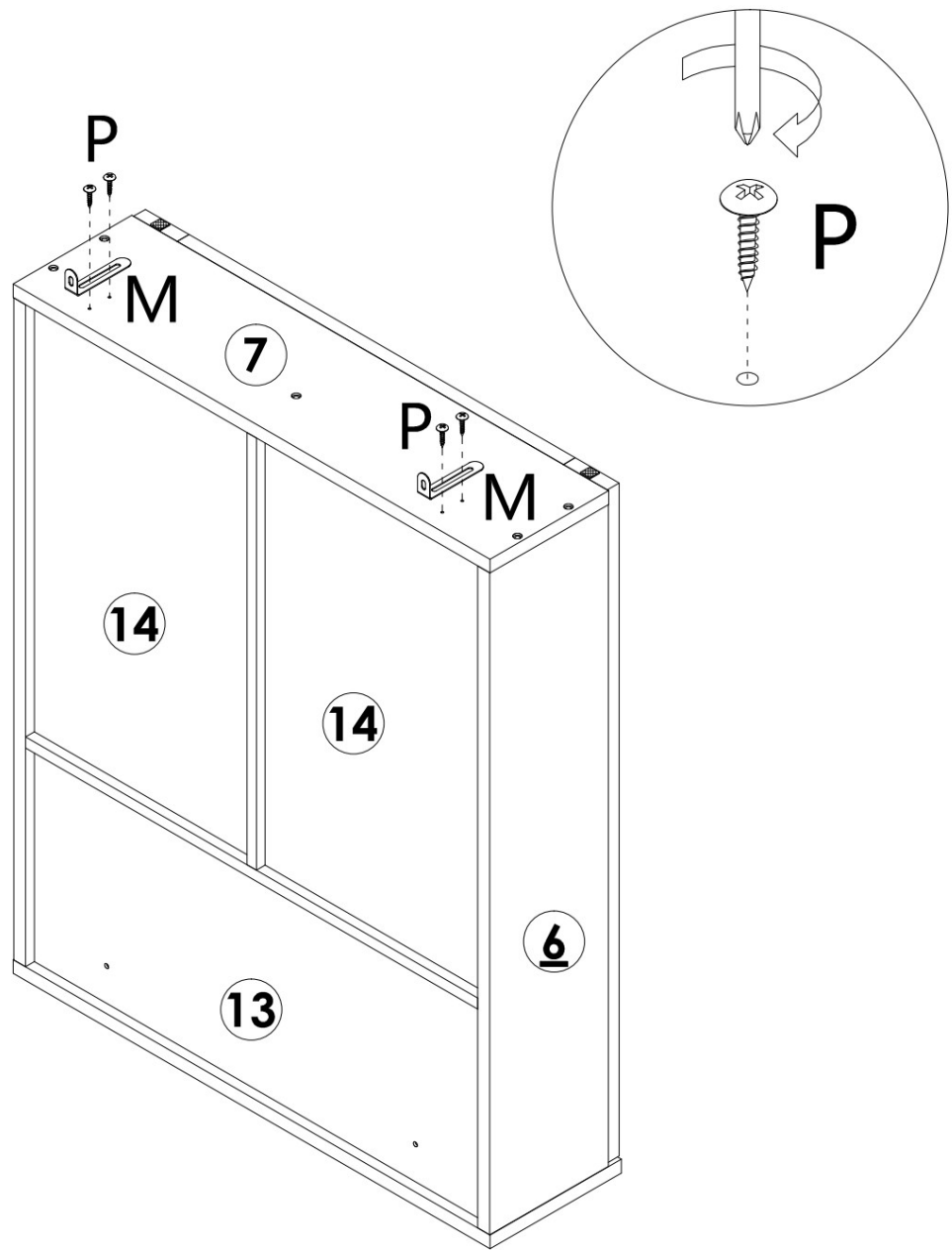

	P x 4PCS
	M x 2PCS

STEP 23

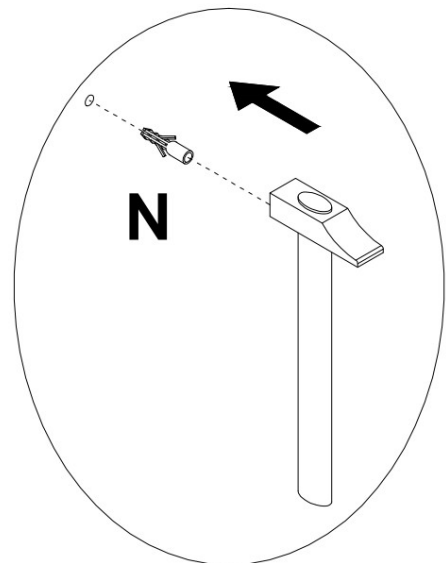
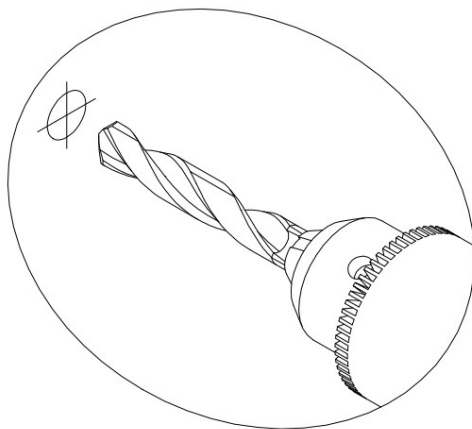
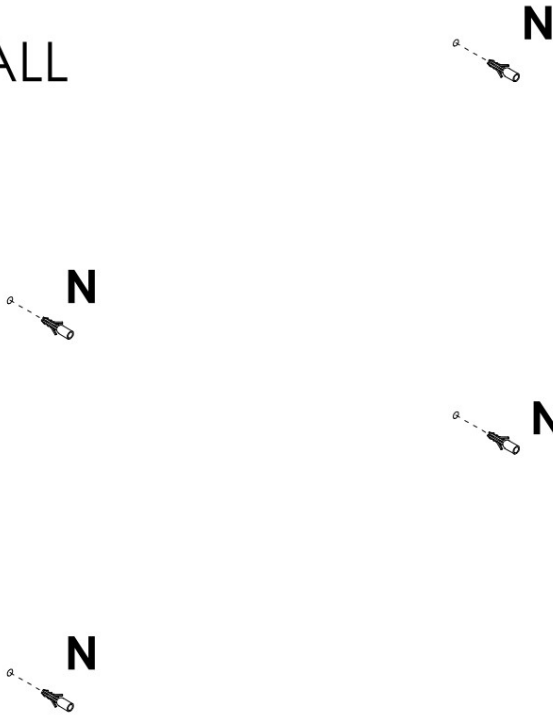

WALL

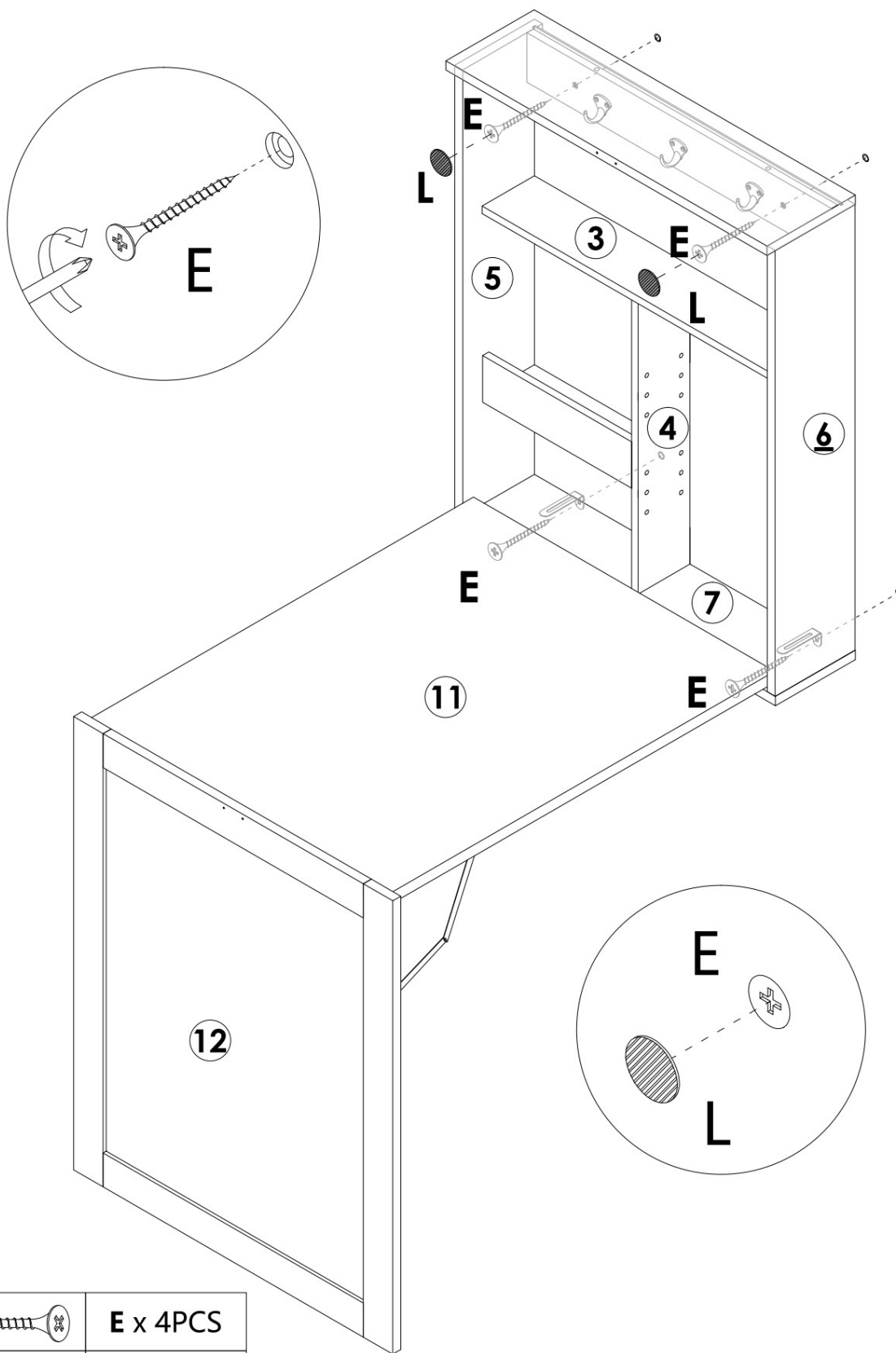

N x 4PCS

STEP 24

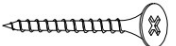

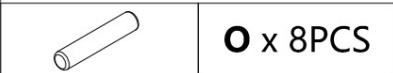
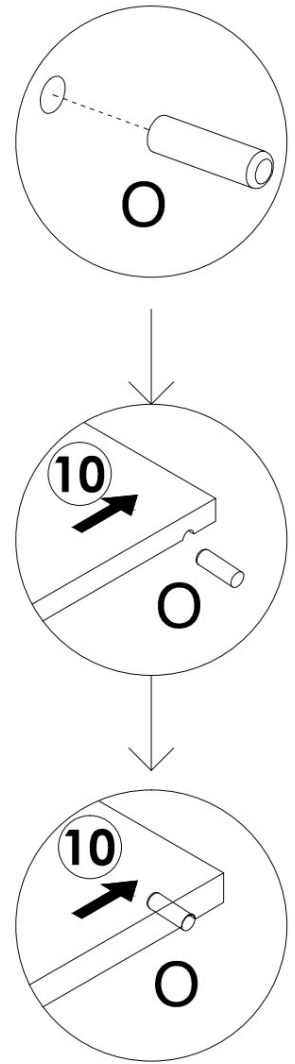
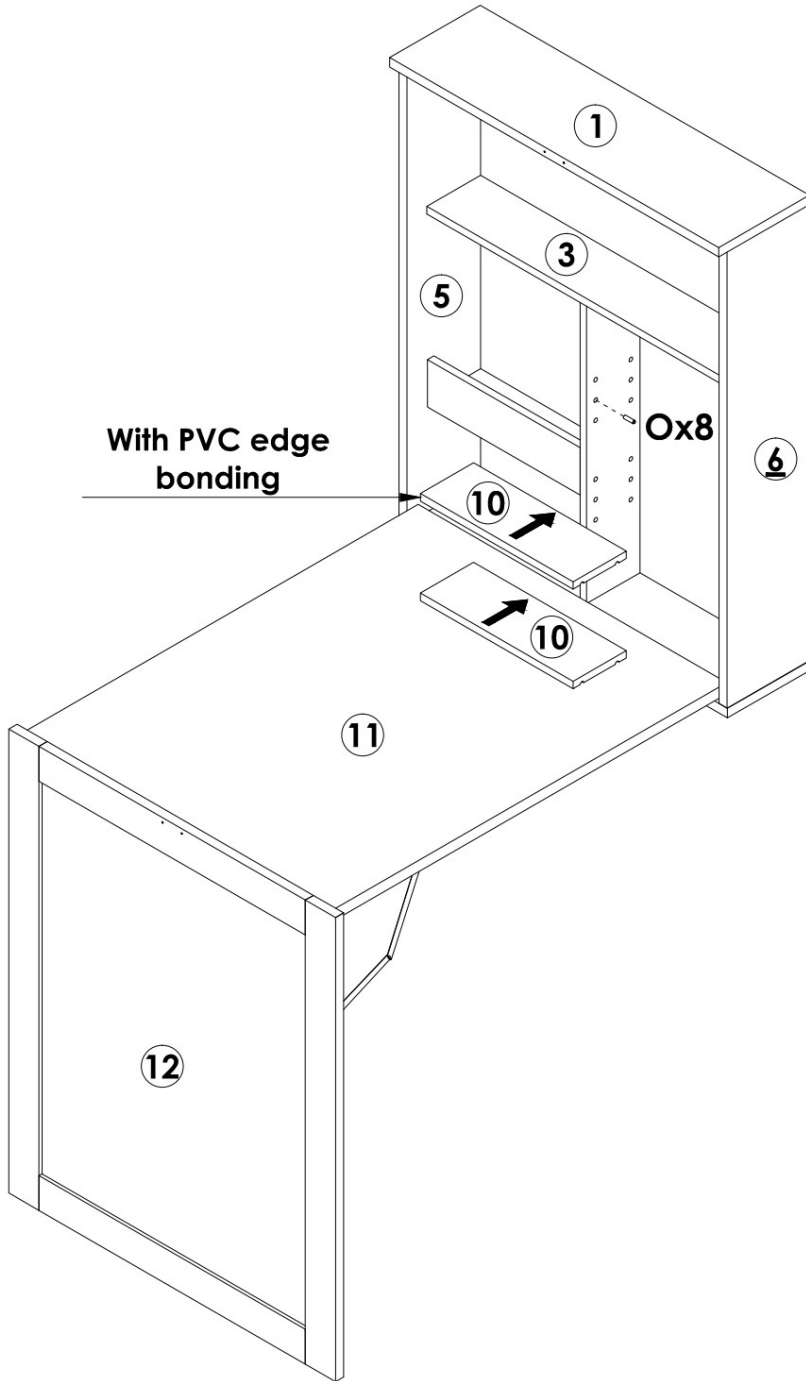

	E x 4PCS
	L x 2PCS

STEP 25

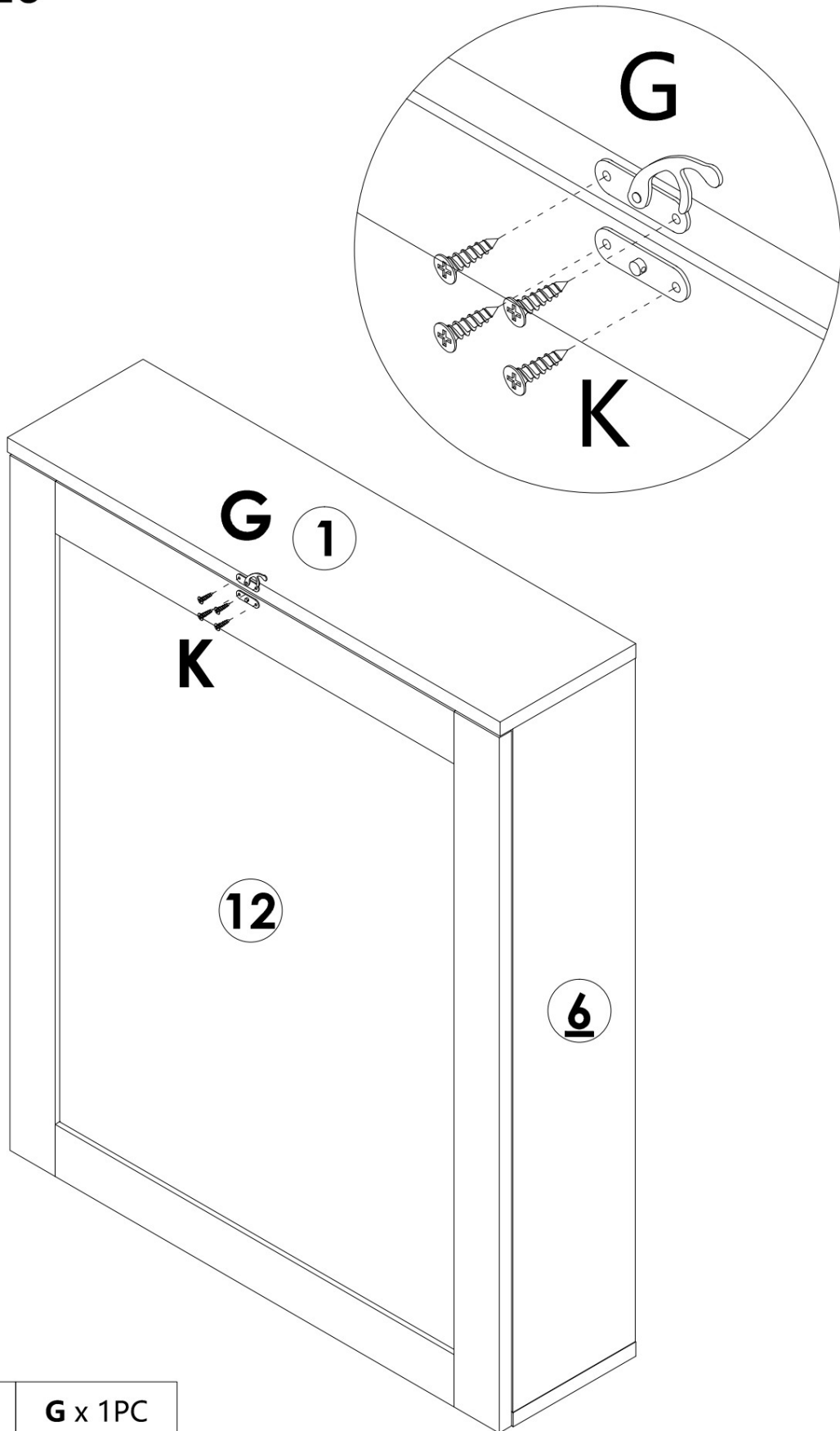

STEP 26



	G x 1PC
	K x 4PCS

VOLTOOIING

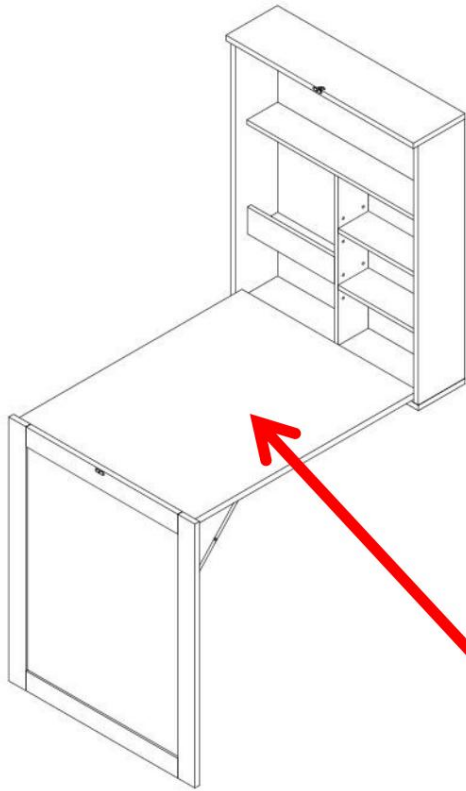

45,35 kg, gelijkmatige verdeling

PRODUCTPARAMETER

Model	HZCD003
Veilig laadgewicht	45,35 kg
Productgrootte	600*165*1470mm

Adres: Shuangchenglu 803nong11hao1602A-1609shi, baoshanqu, shanghai 200000 CN.

Geïmporteerd naar AUS: SIHAO PTY LTD, 1 ROKEVA STREETEASTWOOD NSW 2122 Australië

Geïmporteerd naar de VS: Sanven Technology Ltd.Suite 250, 9166 Anaheim Place, Rancho Cucamonga, CA 91730



E-CrossStu GmbH.
Mainzer Landstr.69, 60329 Frankfurt am Main.



YH CONSULTING LIMITED.
C/O YH Consulting Limited Kantoor 147, Centurion House,
Londen Road, Staines-upon-Thames, Surrey, TW18 4AX

VEVOR[®]
TOUGH TOOLS, HALF PRICE

Technische ondersteuning en e-
garantiecertificaat www.vevor.com/support

VEVOR[®]

TOUGH TOOLS, HALF PRICE

Teknisk support och e-garanticertifikat www.vevor.com/support

FLYTANDE BORD

ANVÄNDARMANUAL

MODELL: HZCD003

Vi fortsätter att vara engagerade i att ge dig verktyg till konkurrenskraftiga priser.

"Spara halva", "halva priset" eller andra liknande uttryck som används av oss representerar bara en uppskattning av besparingar du kan dra nytta av att köpa vissa verktyg hos oss jämfört med de stora toppmärkena och doser behöver inte nödvändigtvis täcka alla kategorier av verktyg som erbjuds av oss. Du påminns vänligen om att noggrant kontrollera när du gör en beställning hos oss om du faktiskt sparar hälften i jämförelse med de främsta stora varumärkena.

VEVOR[®]
TOUGH TOOLS, HALF PRICE

FLYTANDE BORD

MODELL: HZCD003

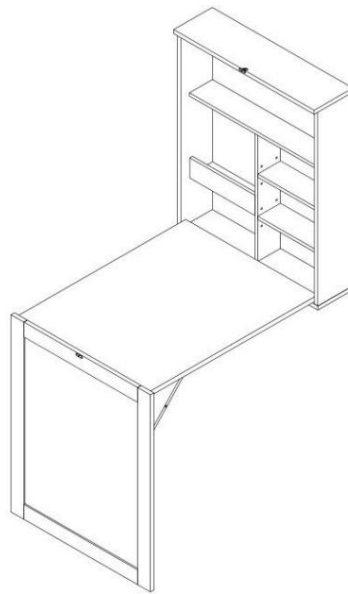

BEHÖVER HJÄLP? KONTAKTA OSS!

Har du produktfrågor? Behöver du teknisk support? Kontakta oss gärna:

Teknisk support och e-garanticertifikat
www.vevor.com/support

Detta är den ursprungliga instruktionen, läs alla instruktioner noggrant innan du använder den. VEVOR reserverar sig för en tydlig tolkning av vår användarmanual. Utseendet på produkten är beroende av den produkt du fått. Ursäkta oss att vi inte kommer att informera dig igen om det finns någon teknik eller mjukvaruuppdateringar på vår produkt.

SÄKERHETSINSTRUKTIONER

VARNING:

Läs detta material innan du använder denna produkt. Underlåtenhet att göra det kan resultera i allvarlig skada.

Försiktighetsåtgärder vid montering

1. Montera endast enligt dessa instruktioner. Felaktig montering kan skapa faror.
2. Bär ANSI-godkända skyddsglasögon och kraftiga arbetshandskar under monteringen.
3. Håll monteringsområdet rent och väl upplyst.
4. Håll åskådare borta från området under monteringen.
5. Sätt dig inte ihop när du är trött eller påverkad av alkohol, droger eller mediciner.
6. Produktens egenskaper gäller för korrekt och fullständigt monterade endast produkter.
7. Montera på en plan, jämn, hård och slät yta som kan säkert stöder det flytande skrivbordet.
8. För ytterligare information om delarna som anges nedan sidorna, se monteringsdiagrammet i denna manual. Packa upp och separera alla delar i ett rent arbetsområde.









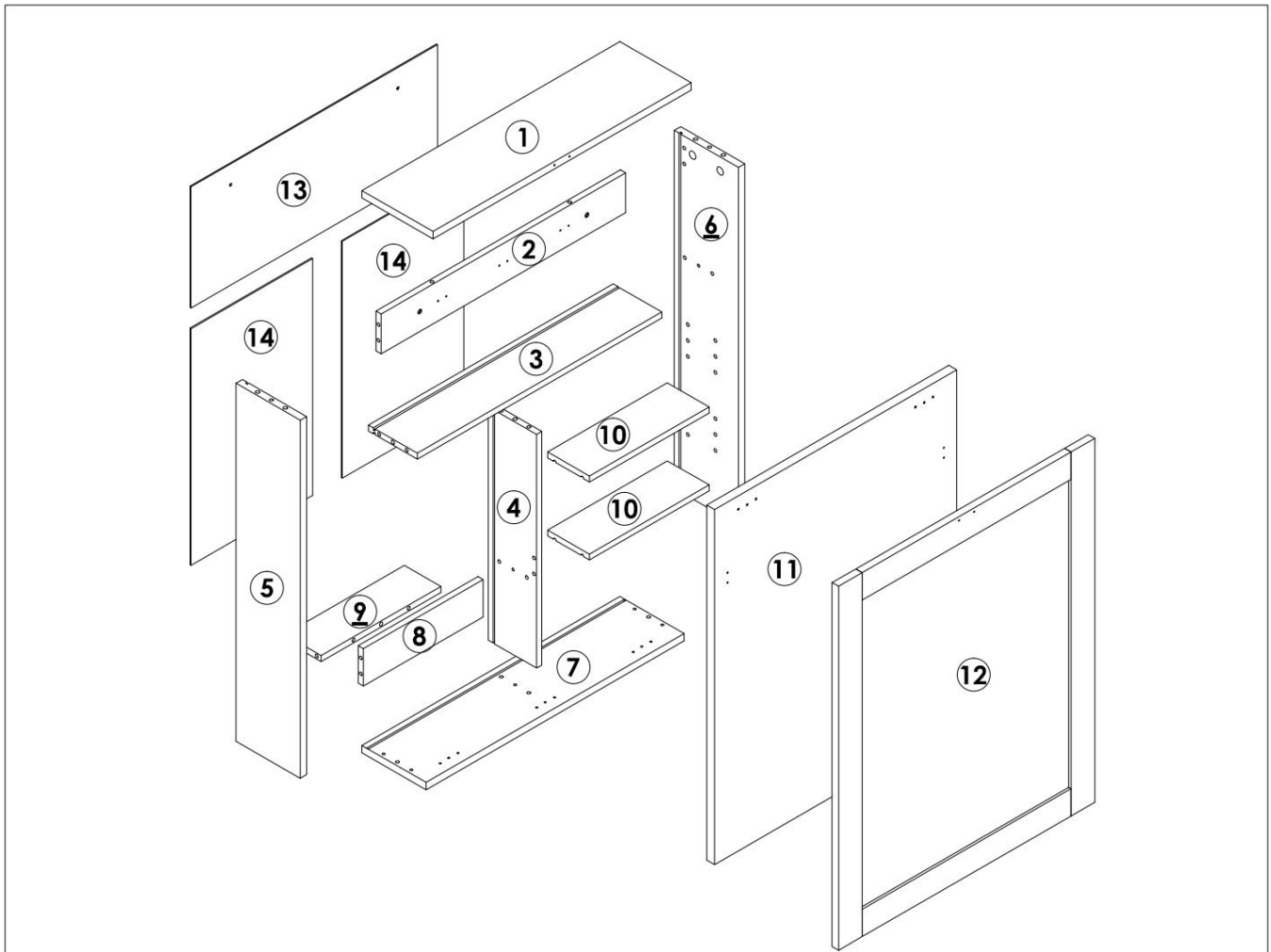

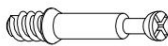



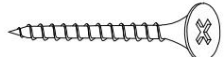
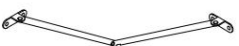

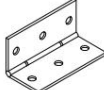
Använd försiktighetsåtgärder

1. SIT ELLER STÅ INTE PÅ DETTA FÖREMÅL.
2. Denna produkt är inte en leksak. Låt inte barn leka med eller i närheten av detta punkt.
3. Överskrid inte viktkapaciteten.
4. Använd endast på avsett sätt.
5. Inspektera före varje användning; Använd inte om delar är lösa eller skadade.

SPARA DENNA MANUAL

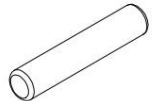
DELLISTA

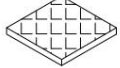

<p>A</p>  <p>M6x35mm 10+1PCS</p>	<p>B</p>  <p>Ø15x9mm 10+1PCS</p>	<p>C</p>  <p>M4x40mm 5PCS</p>	<p>D</p>  <p>Ø6x30mm 30+2PCS</p>	<p>E</p>  <p>M5x60mm 4PCS</p>
<p>F</p>  <p>2PCS</p>	<p>G</p>  <p>1PC</p>	<p>H</p>  <p>5PCS</p>	<p>I</p>  <p>3PCS</p>	<p>J</p>  <p>M3x14mm 6PCS</p>
<p>K</p>  <p>M3x12mm 42+2PCS</p>	<p>L</p>  <p>Ø20mm 7PCS</p>	<p>M</p>  <p>2PCS</p>	<p>N</p>  <p>M8x40mm 4PCS</p>	<p>O</p>  <p>M5x20mm 8+1PCS</p>
<p>P</p>  <p>M4x12mm 4PCS</p>	<p>Q</p>  <p>16x16mm 2PCS</p>	 <p>1PC</p>		

INSTRUKTIONER

STEP 1

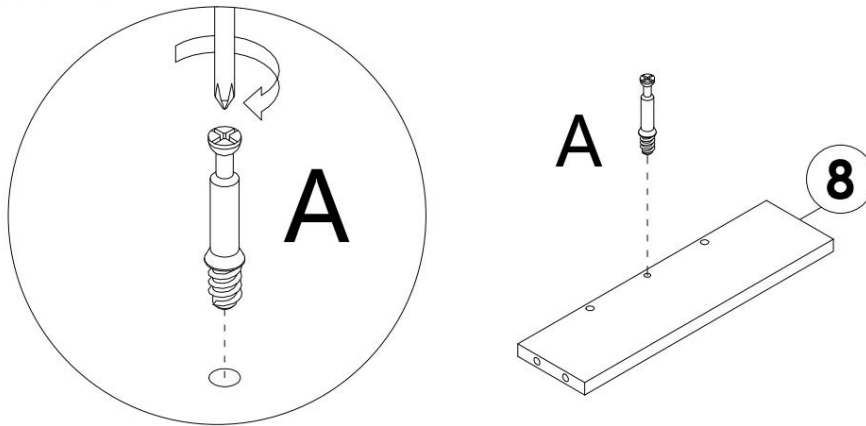

A x 1PC

STEP 2

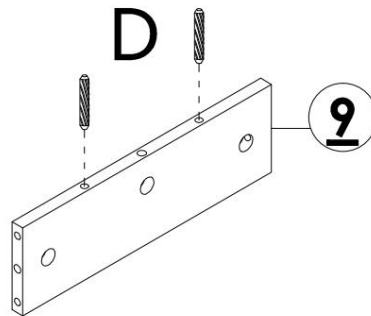

D x 2PCS

STEP 3

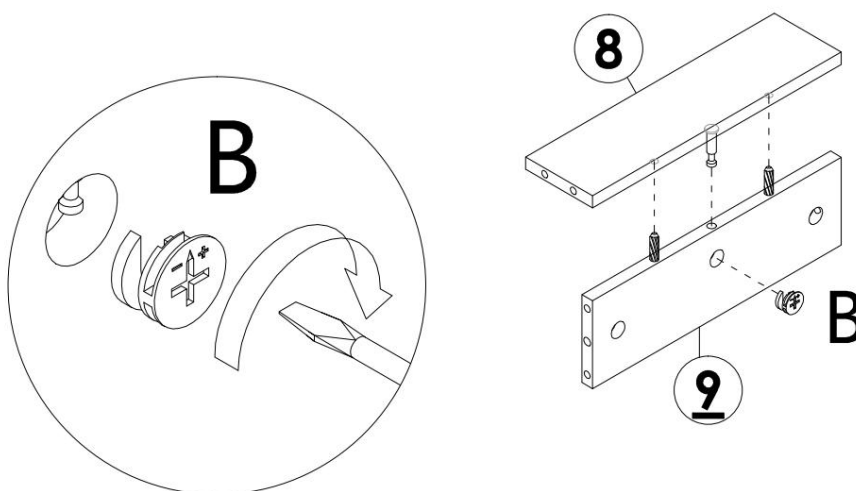

B x 1PC

STEP 4

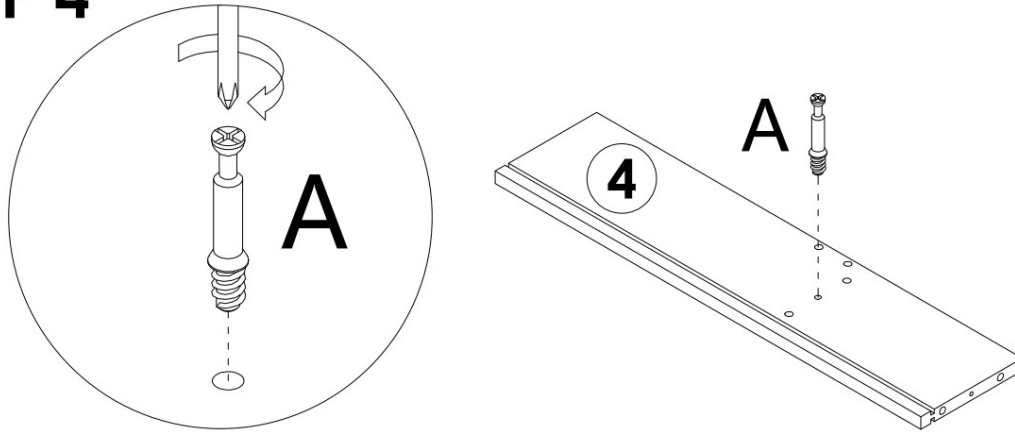

A x 1PC

STEP 5

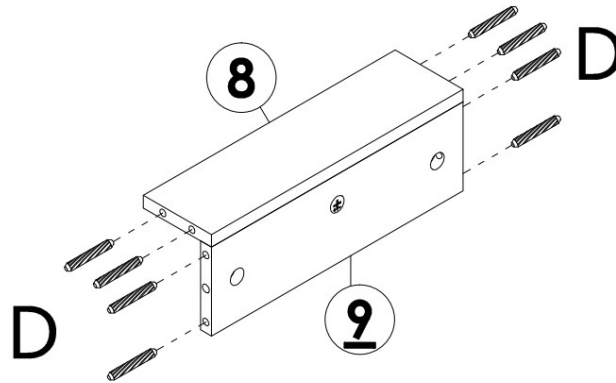

D x 8PCS

STEP 6

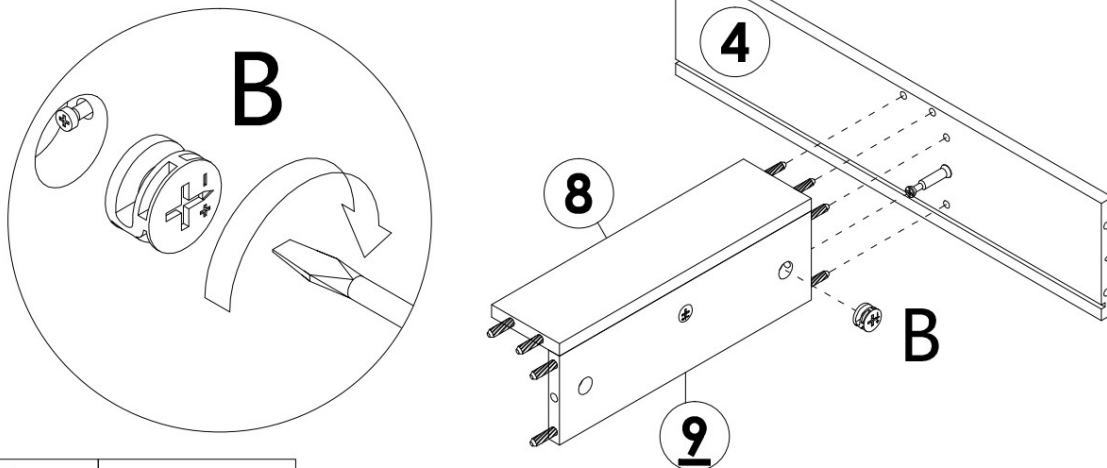

B x 1PC

STEP 7

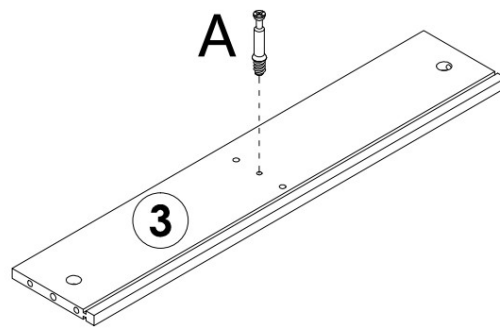
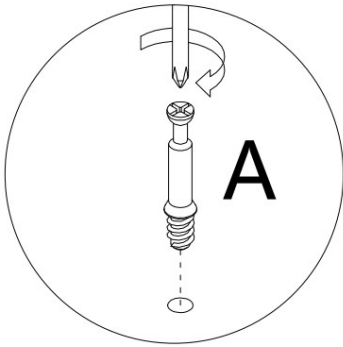

A x 1PC

STEP 8

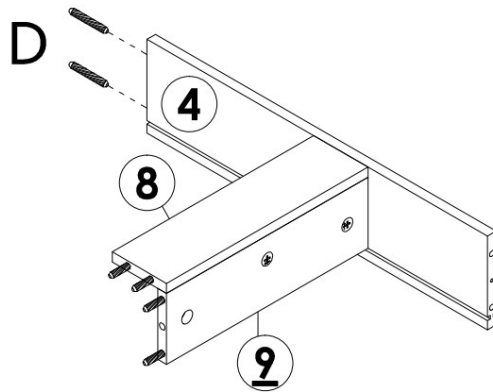

D x 2PCS

STEP 9

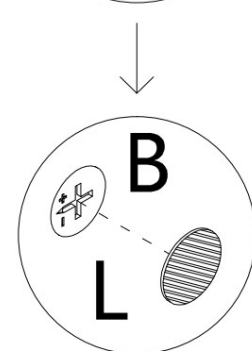
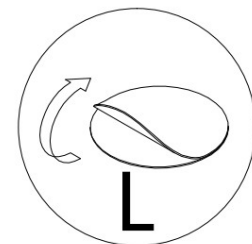
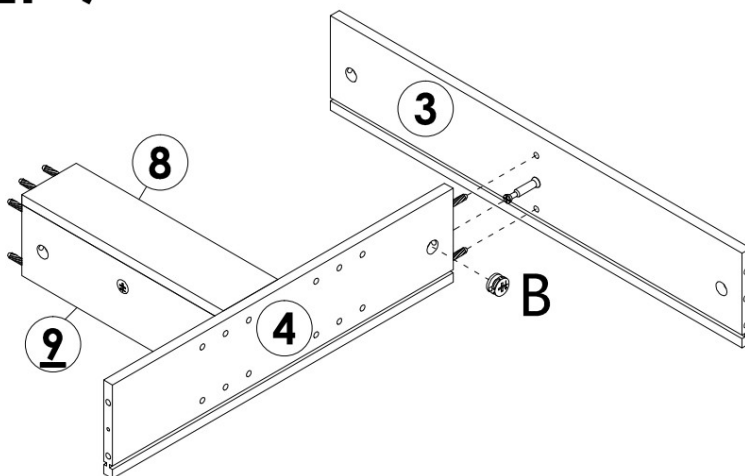



B x 1PC

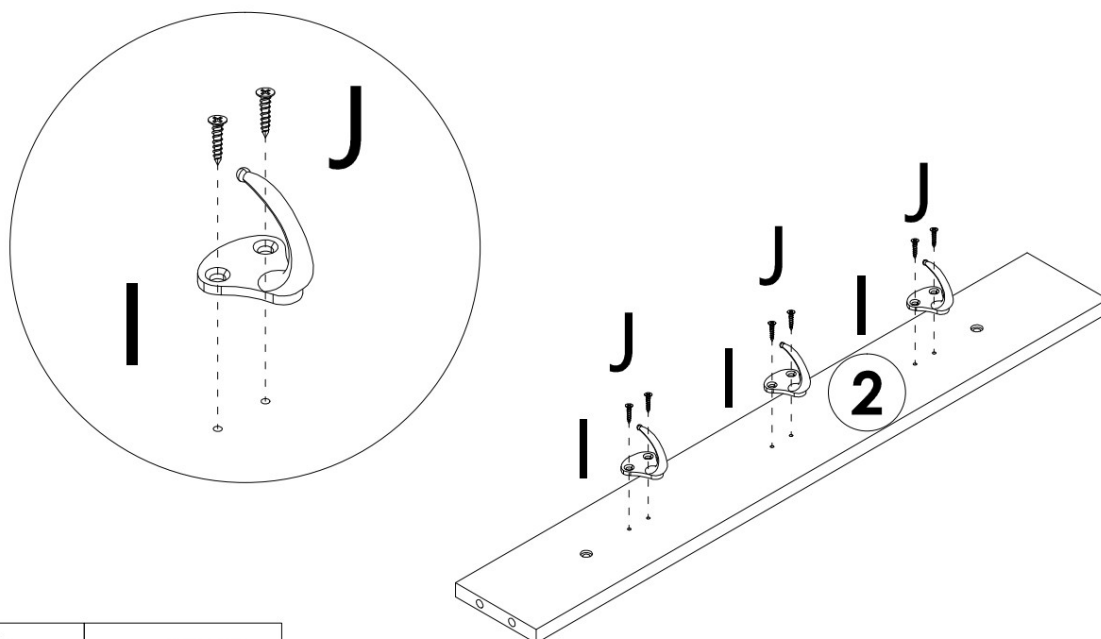

L x 1PC

STEP 10

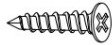

	I x 3PCS
	J x 6PCS

STEP 11

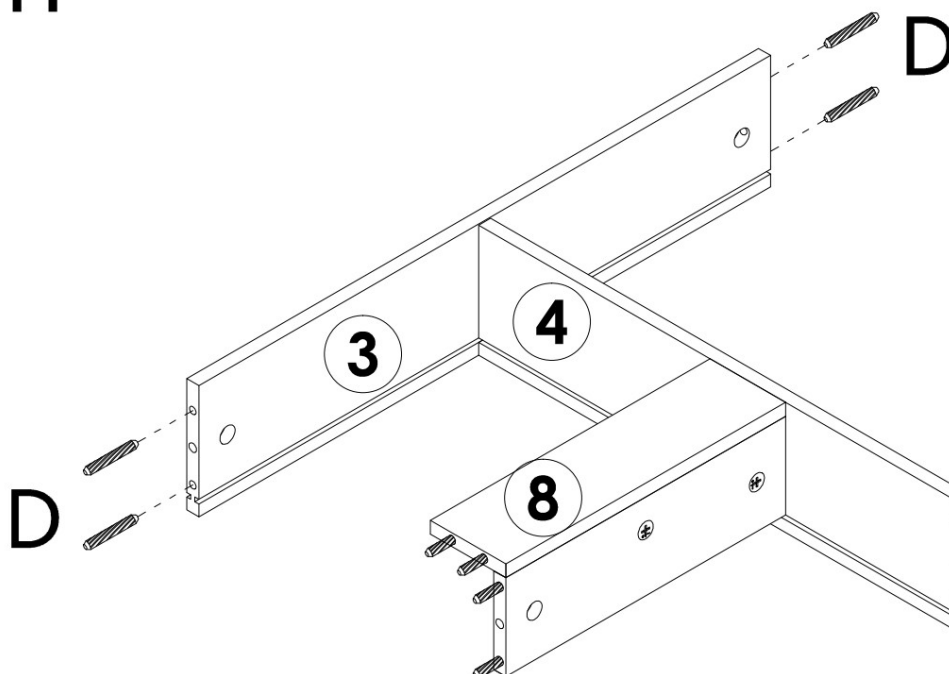

	D x 4PCS
---	----------

STEP 12

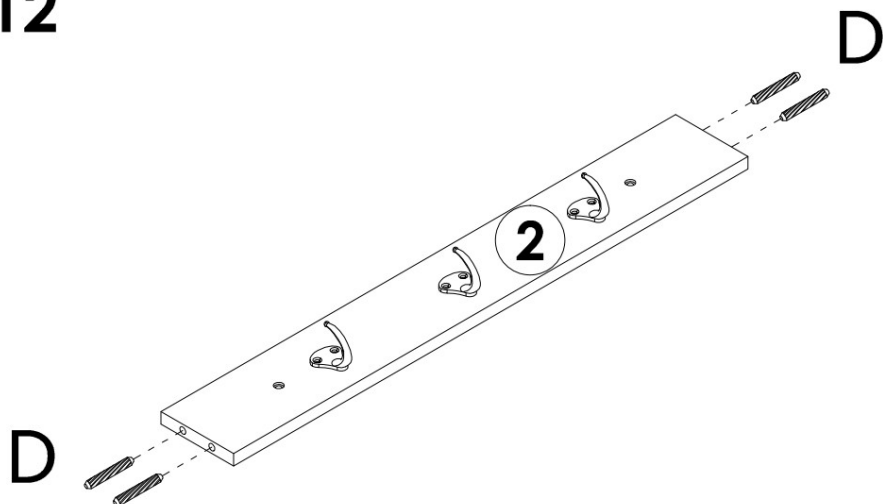

D x 4PCS

STEP 13

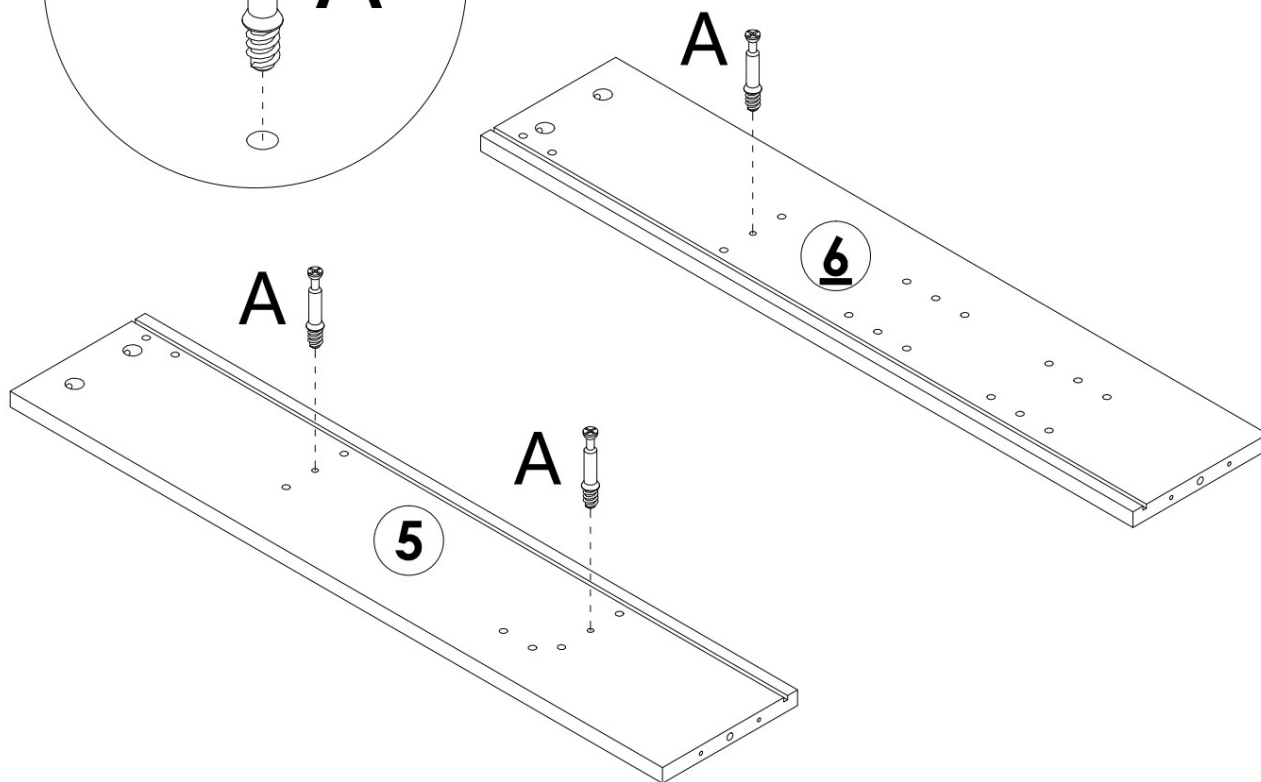
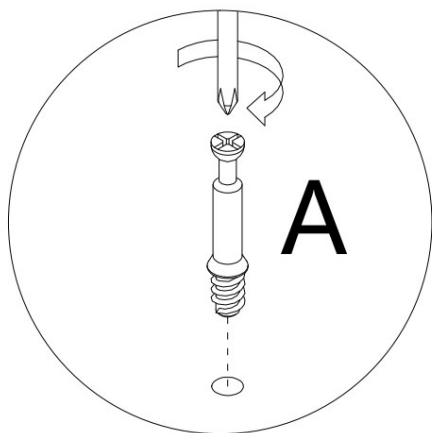

A x 3PCS

STEP 14

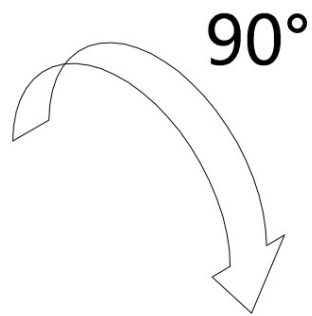
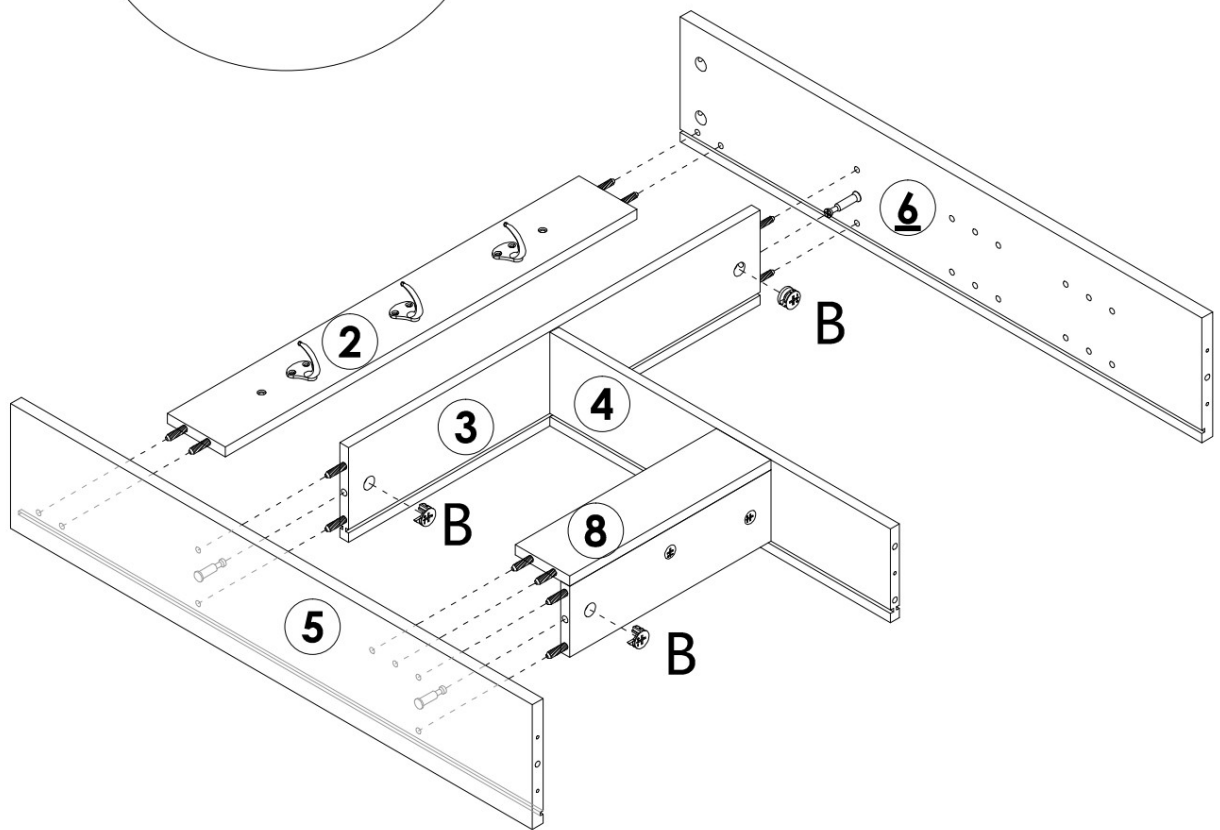
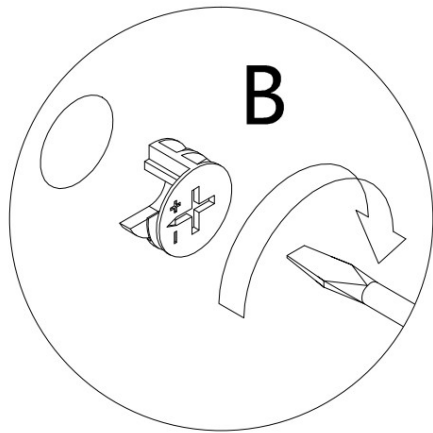

B x 3PCS

STEP 15

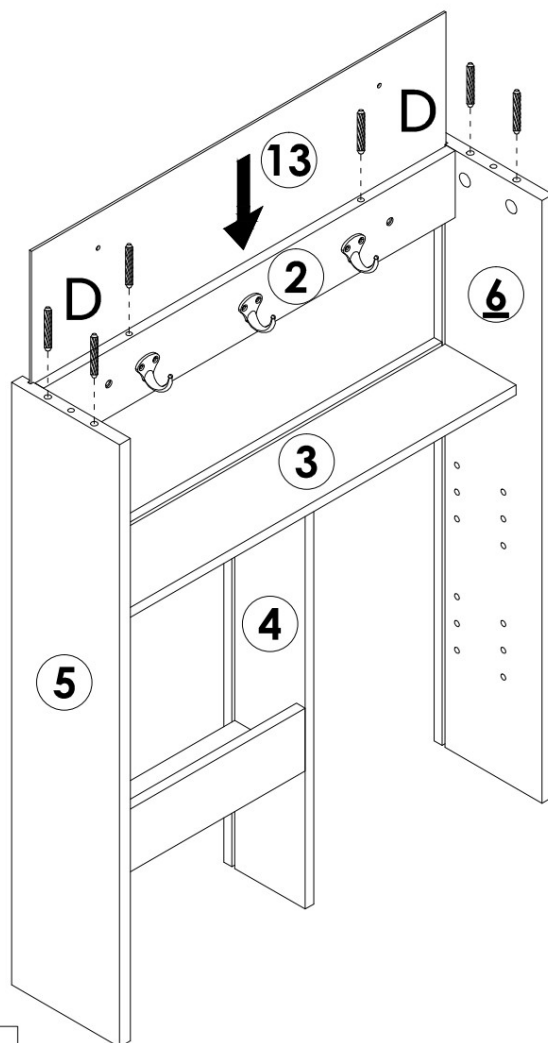

 **D x 6PCS**

STEP 16

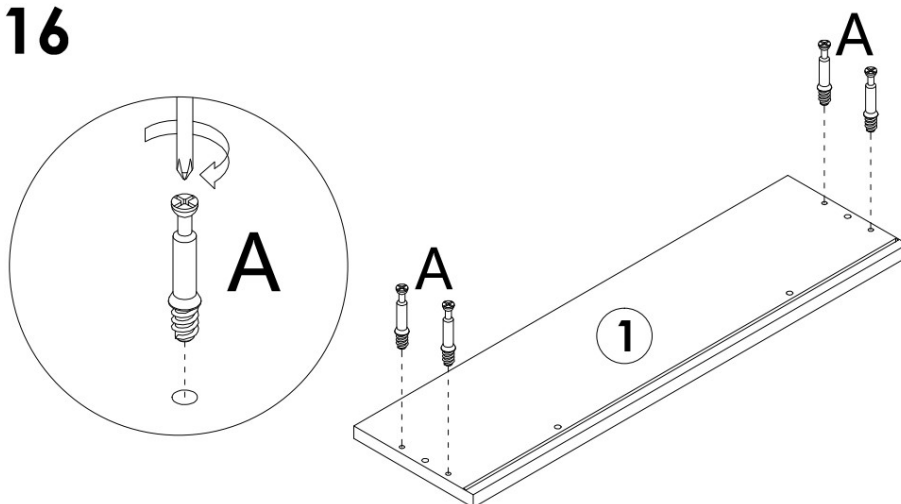

 **A x 4PCS**

STEP 17

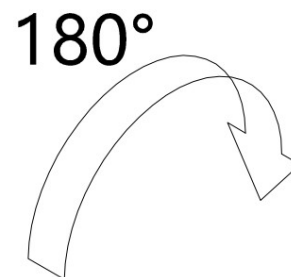
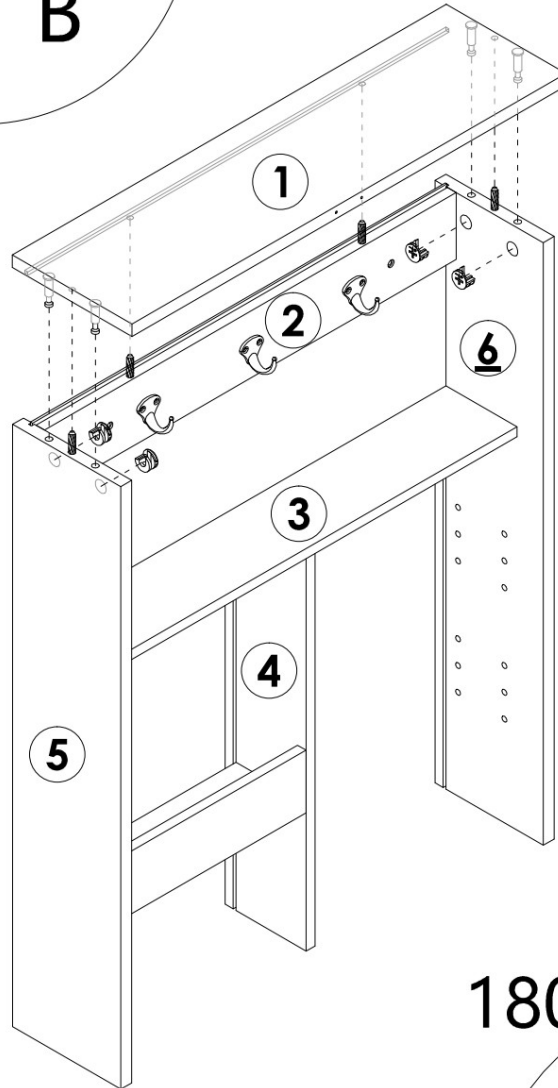
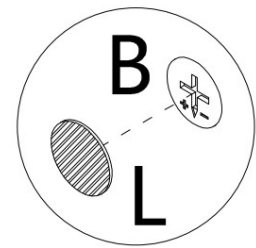
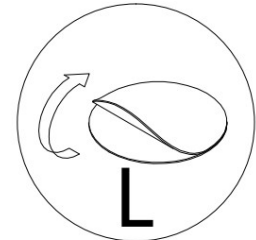
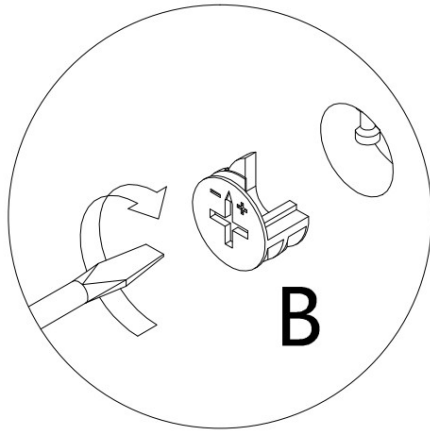

	B x 4PCS
	L x 4PCS

STEP 18

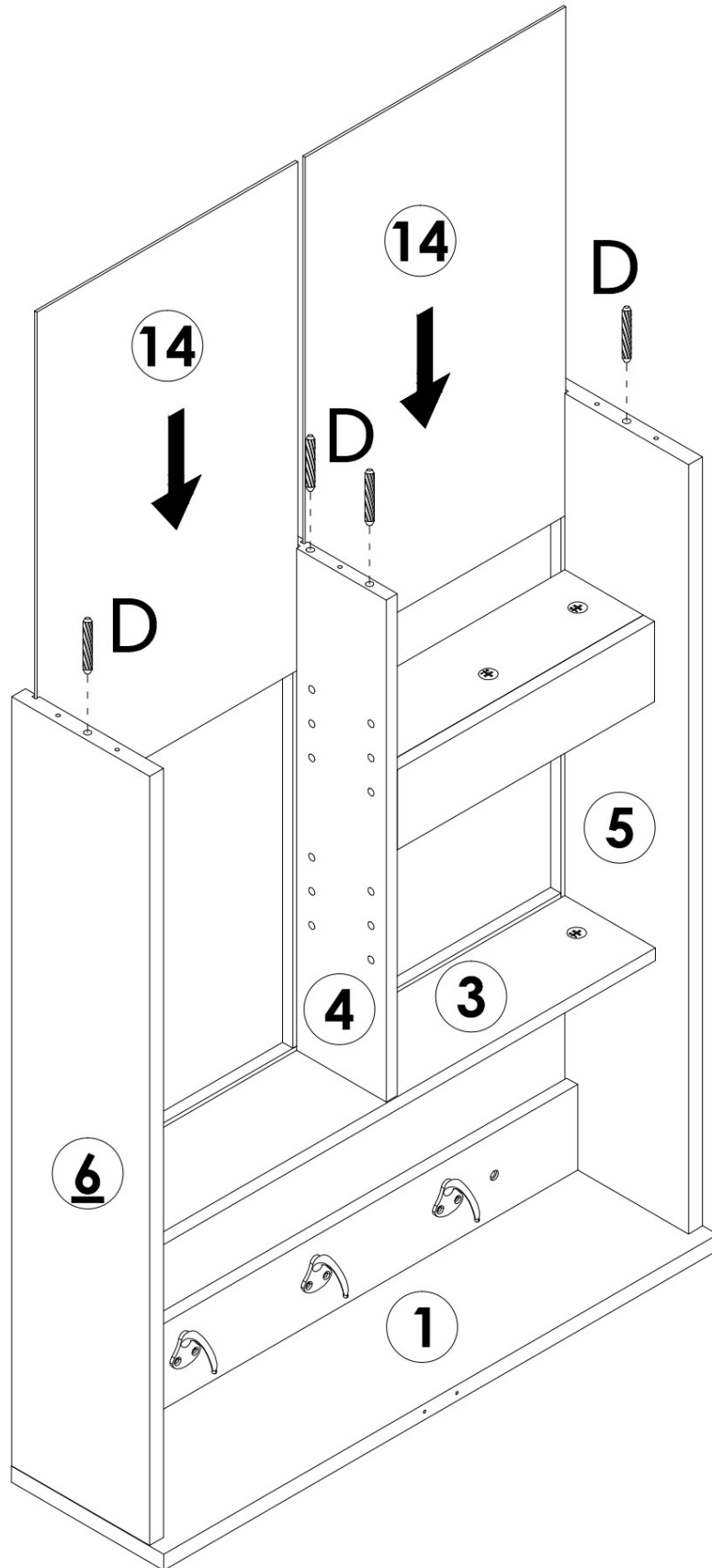

D x 4PCS

STEP 19

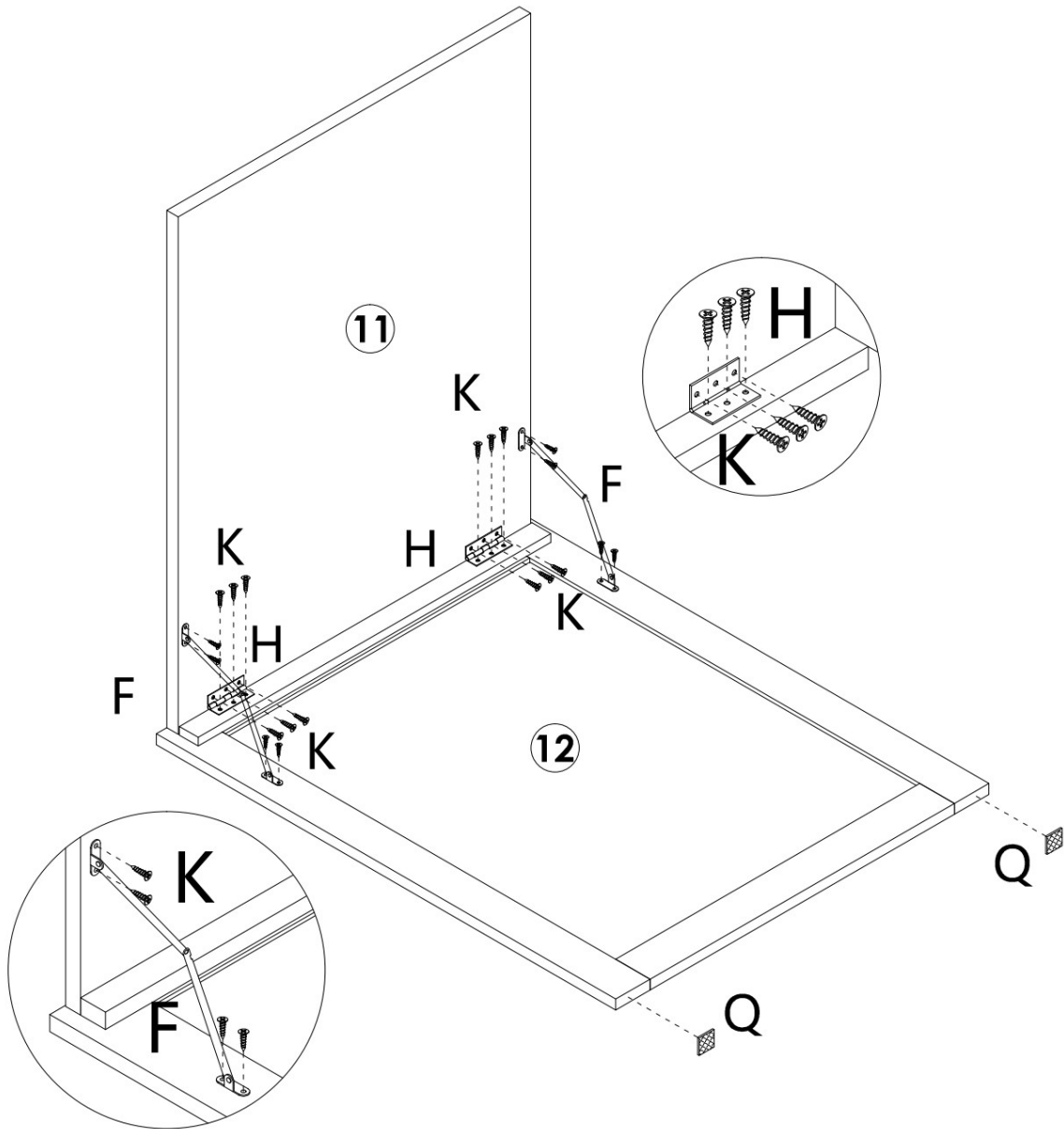

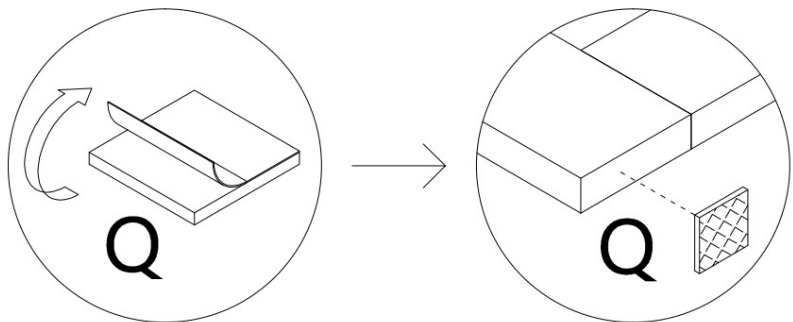

	F x 2PCS
	H x 2PCS
	K x 20PCS
	Q x 2PCS

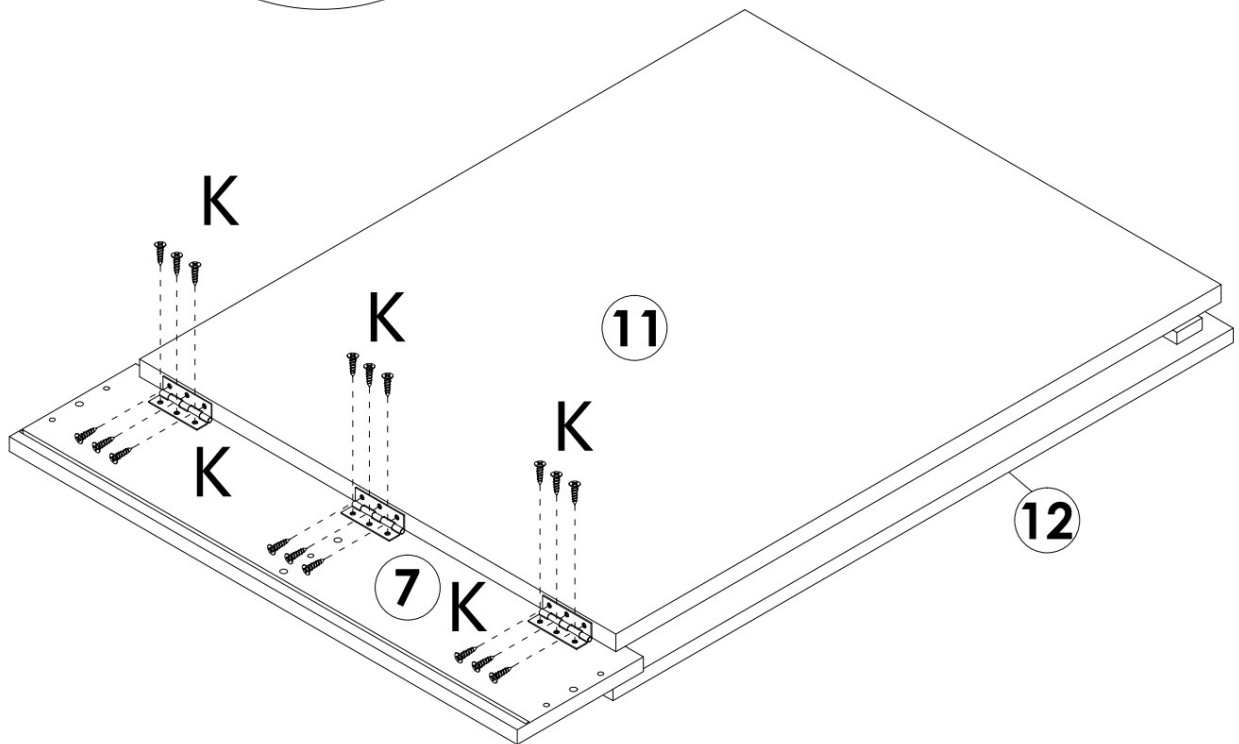
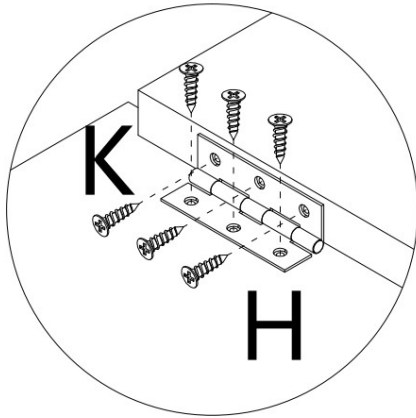

STEP 20



	H x 3PCS
	K x 18PCS

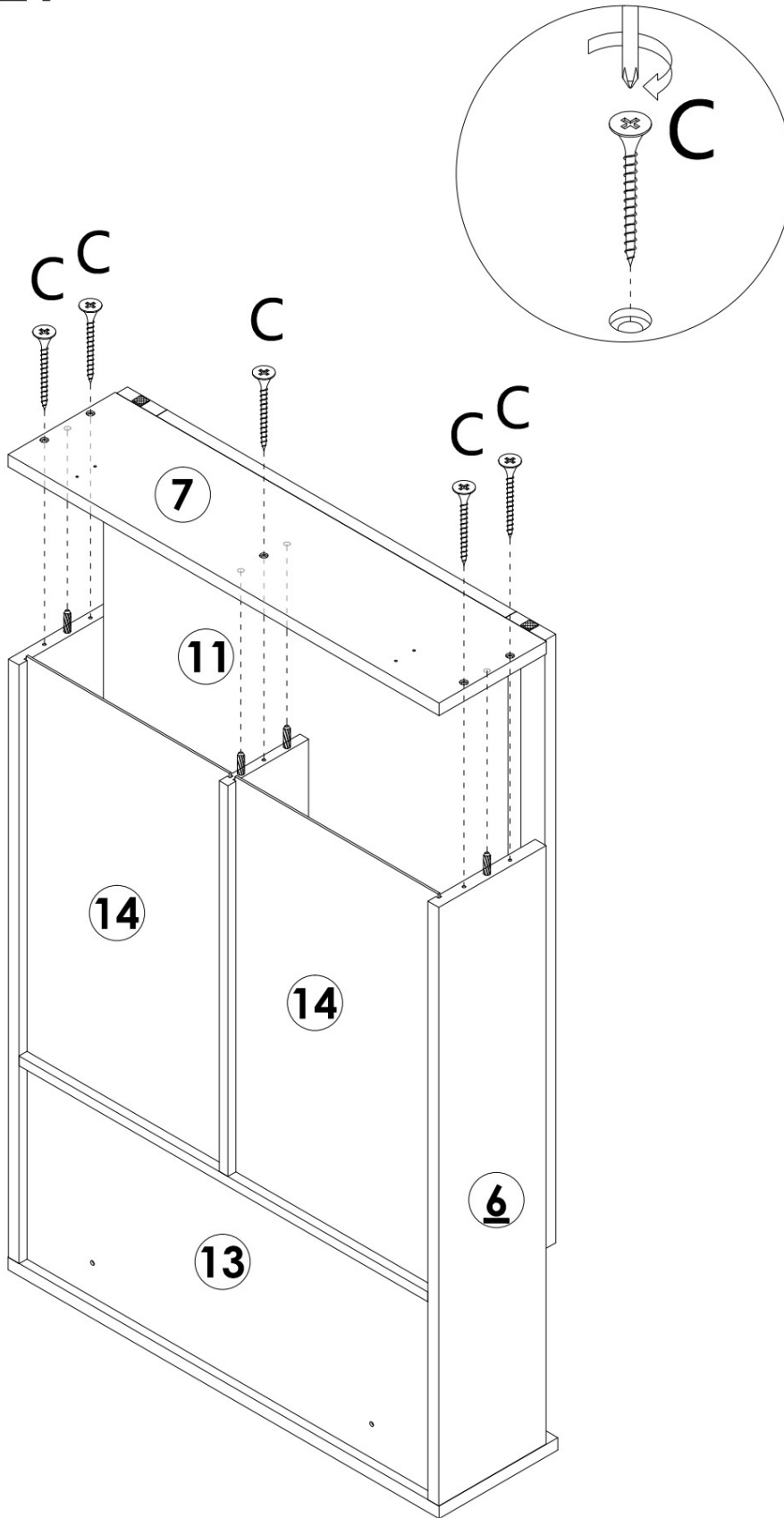

STEP 21

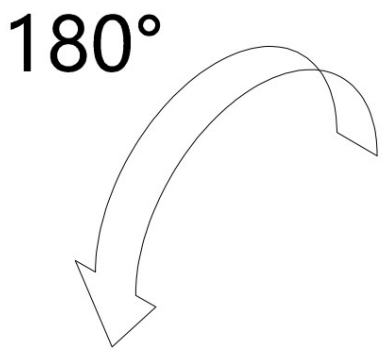
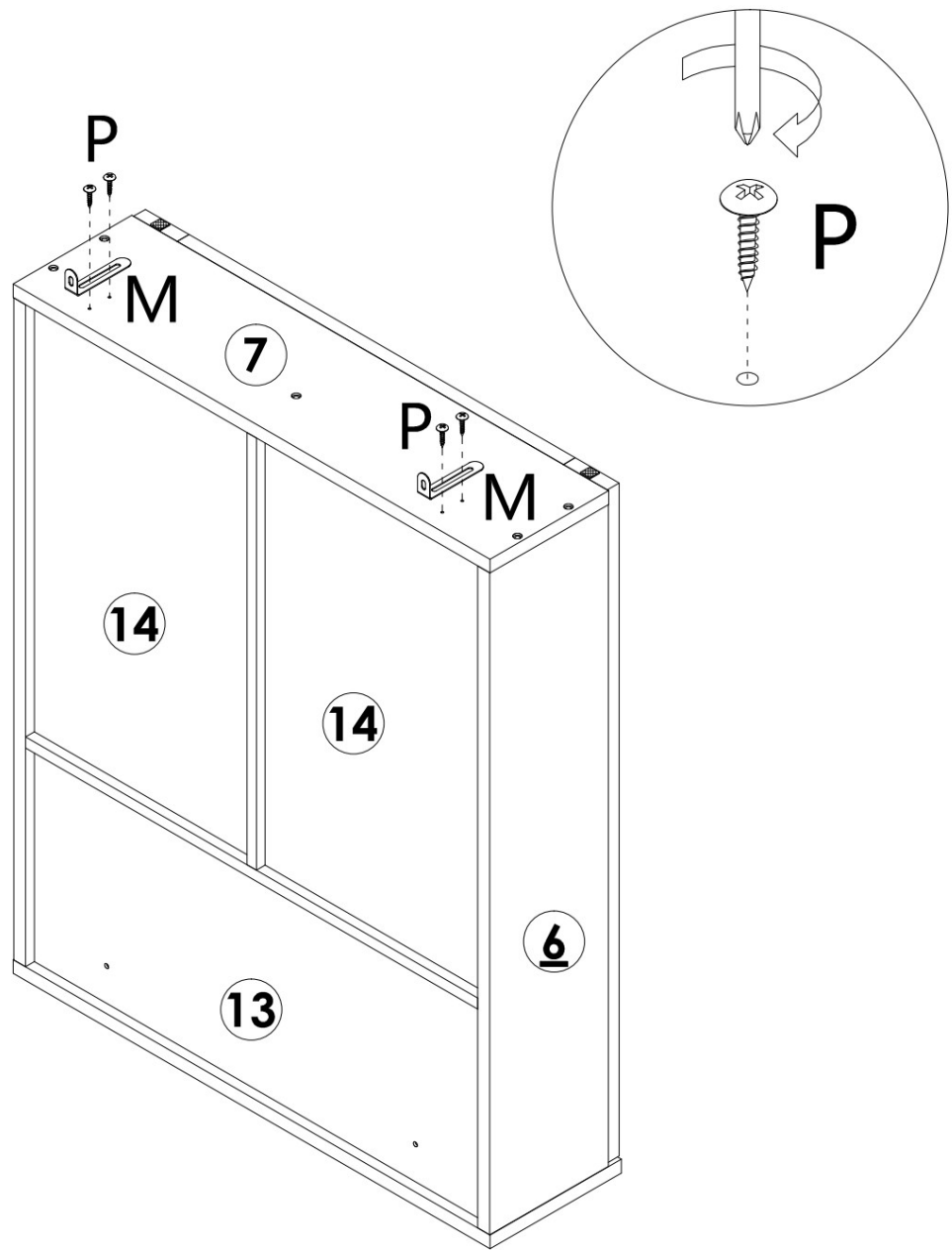

 **C x 5PCS**

STEP 22

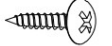

	P x 4PCS
	M x 2PCS

STEP 23

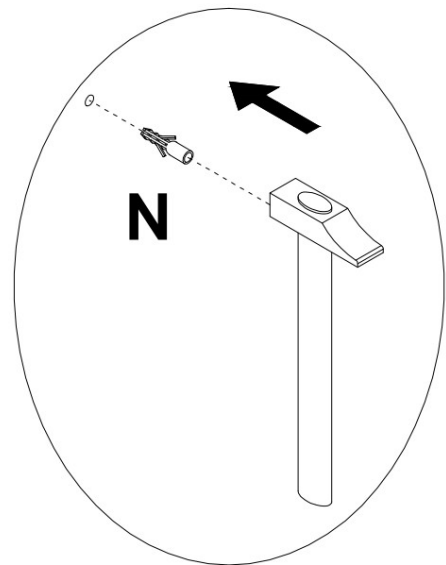
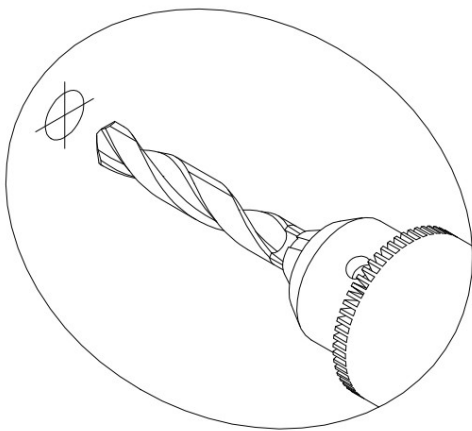
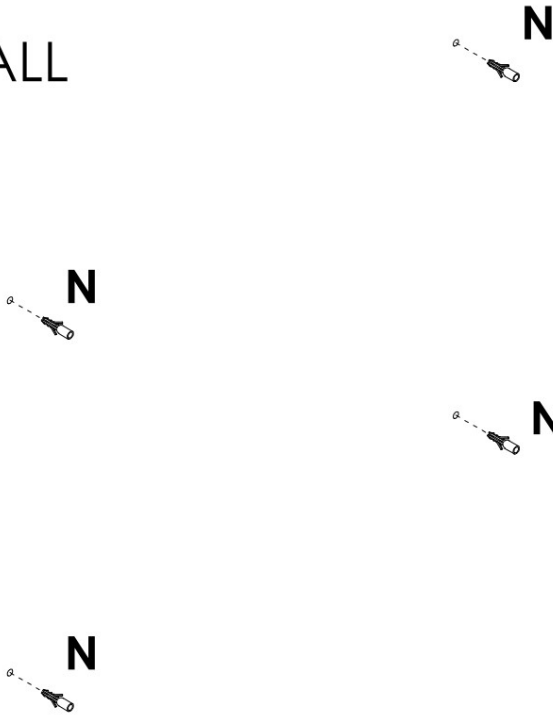

WALL

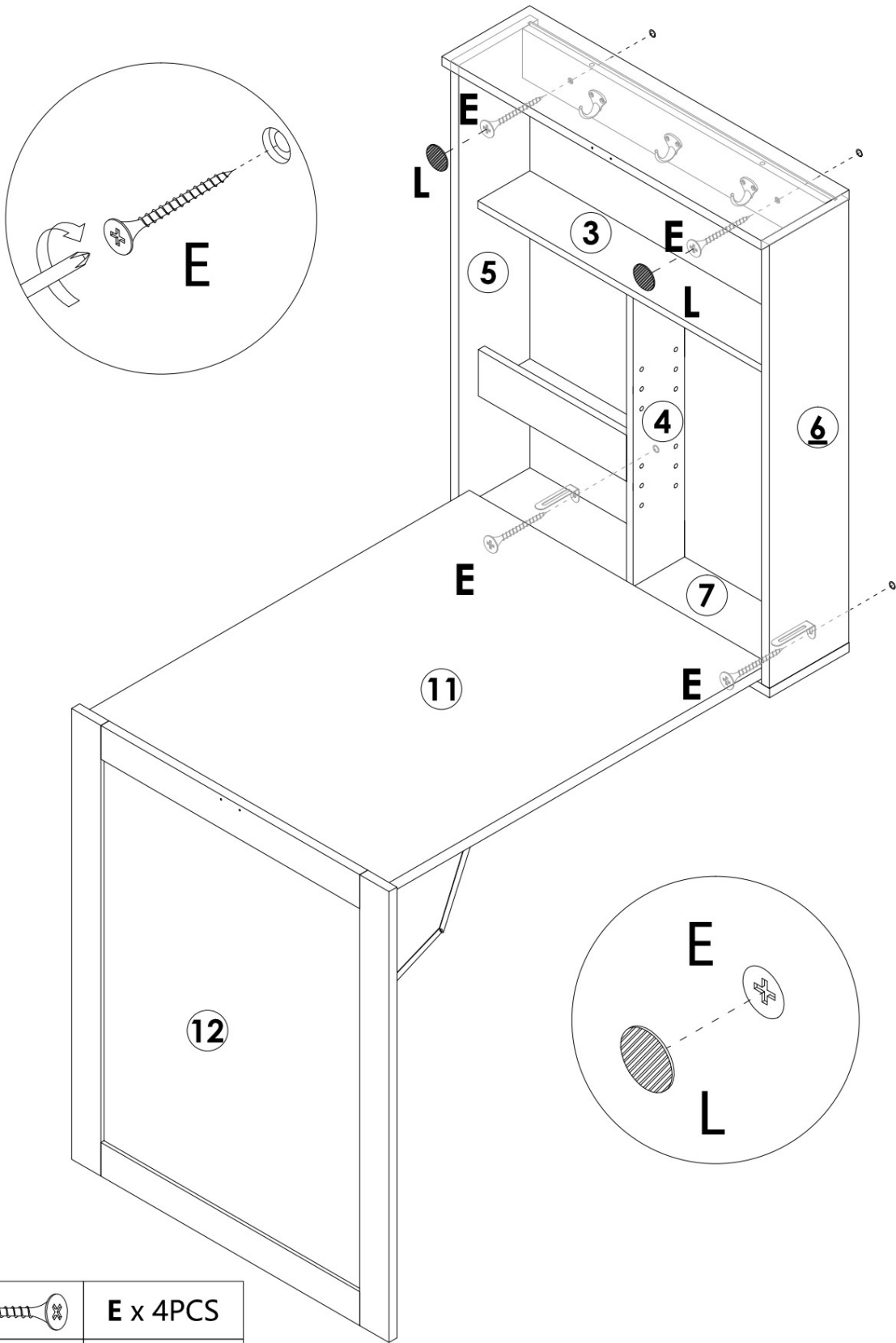

N x 4PCS

STEP 24

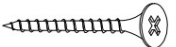

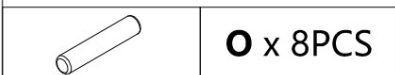
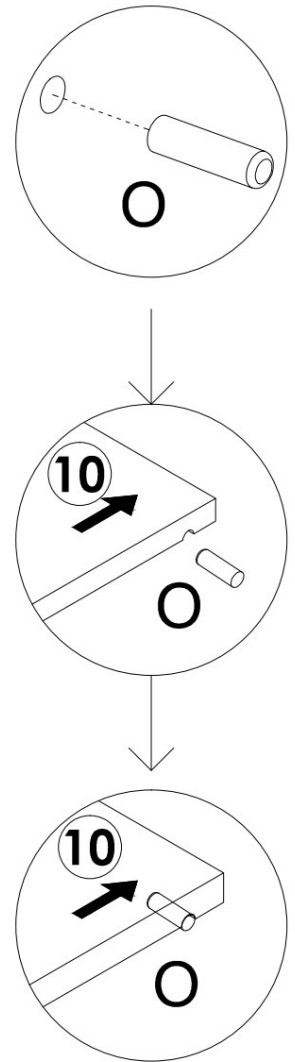
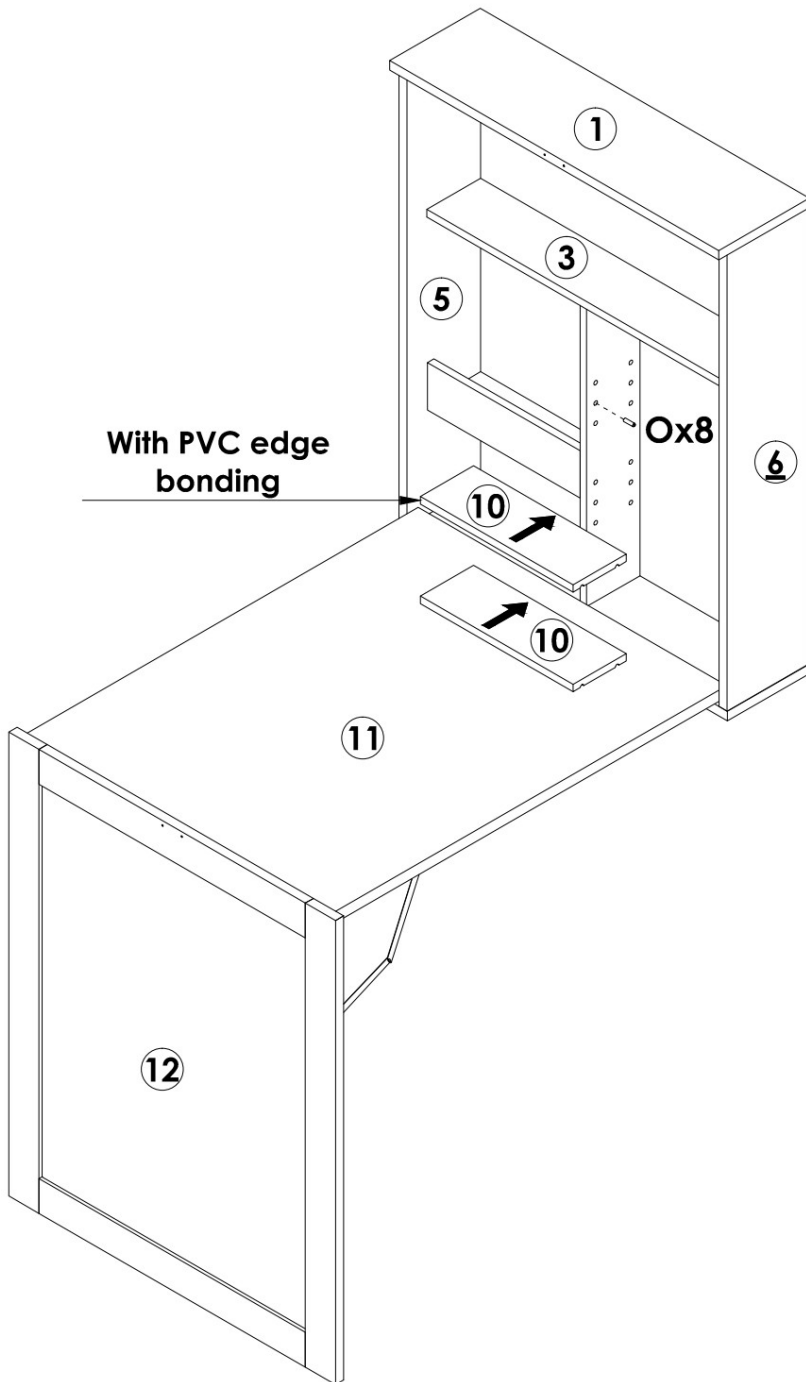

	E x 4PCS
	L x 2PCS

STEP 25

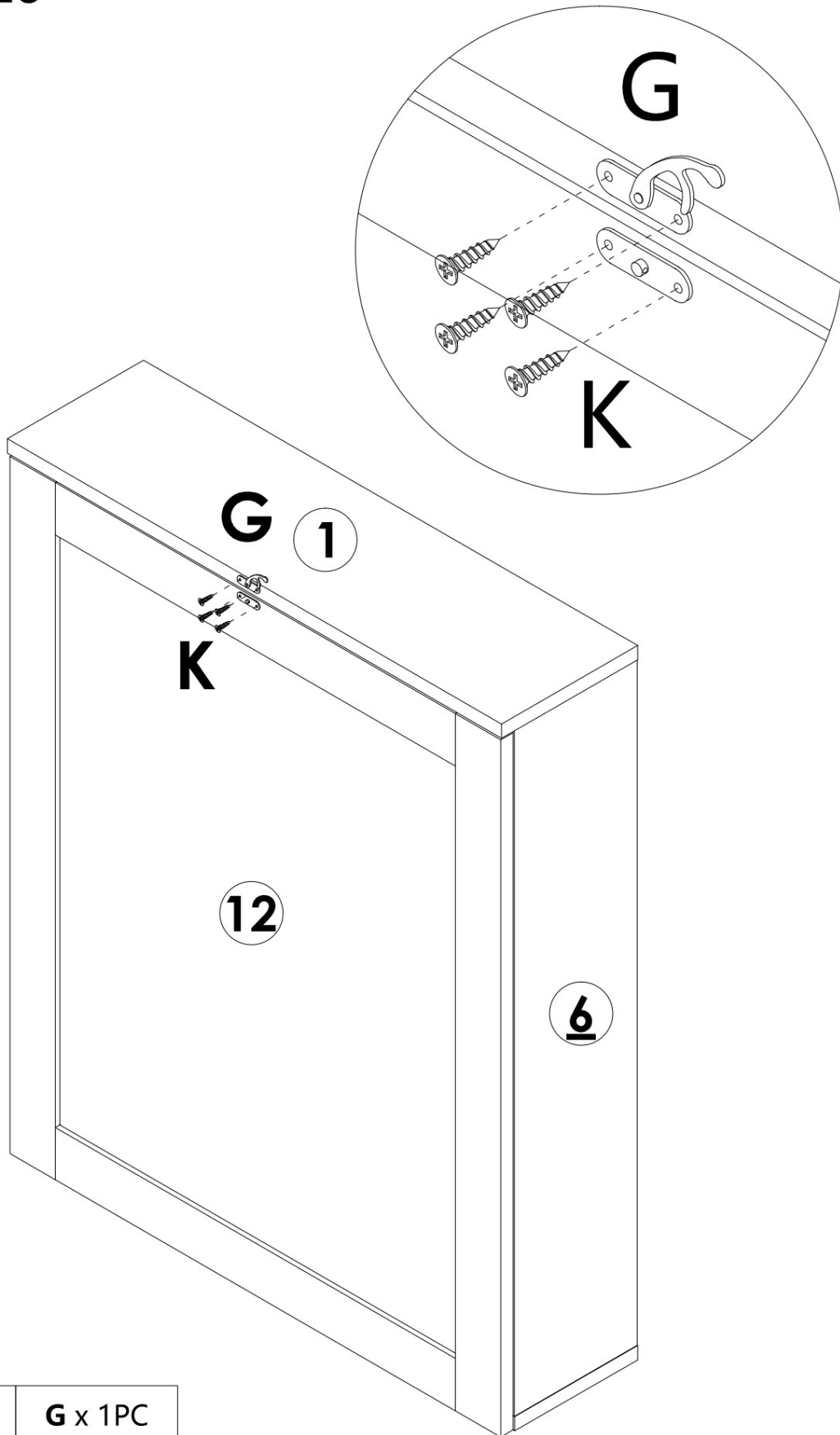

STEP 26



	G x 1PC
	K x 4PCS

KOMPLETTERING

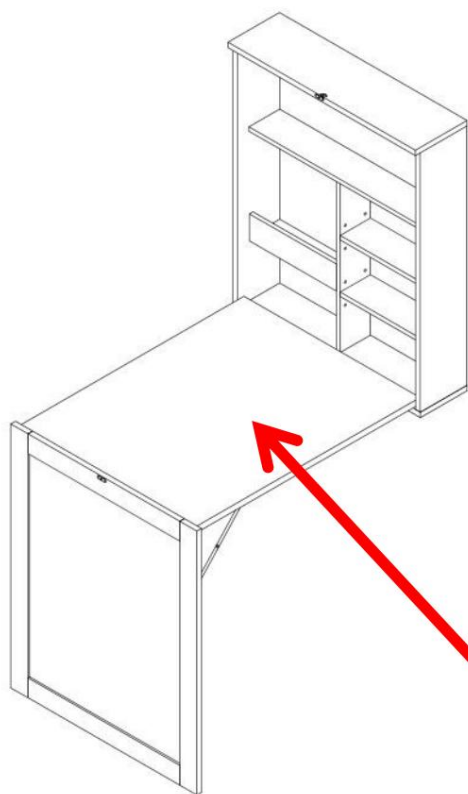

45,35 kg, Jämn fördelning

PRODUKTPARAMETER

Modell	HZCD003
Säker lastvikt	45,35 kg
Produktstorlek	600*165*1470 mm

Address: Shuangchenglu 803nong11hao1602A-1609shi, baoshanqu, shanghai 200000 CN.

Importerad till AUS: SIHAO PTY LTD, 1 ROKEVA STREETEASTWOOD NSW 2122 Australien

Importerad till USA: Sanven Technology Ltd.Suite 250, 9166 Anaheim Place, Rancho Cucamonga, CA 91730



E-CrossStu GmbH.
Mainzer Landstr.69, 60329 Frankfurt am Main.



YH CONSULTING LIMITED.
C/O YH Consulting Limited Office 147, Centurion House,
London Road, Staines-upon-Thames, Surrey, TW18 4AX

VEVOR®
TOUGH TOOLS, HALF PRICE

Teknisk support och e-garanticertifikat
www.vevor.com/support