

# VEVOR<sup>®</sup>

## TOUGH TOOLS, HALF PRICE

Technical Support and E-Warranty Certificate [www.vevor.com/support](http://www.vevor.com/support)

# TELEVISION STAND

## USER MANUAL

**MODEL: FSH28**

We continue to be committed to provide you tools with competitive price. "Save Half, "Half Price" or any other similar expressions used by us only represents an estimate of savings you might benefit from buying certain tools with us compared to the major top brands and does not necessarily mean to cover all categories of tools offered by us. You are kindly reminded to verify carefully when you are placing an order with us if you are actually saving half in comparison with the top major brands.



# VEVOR<sup>®</sup>

TOUGH TOOLS, HALF PRICE

TELEVISION STAND

MODEL: FSH28

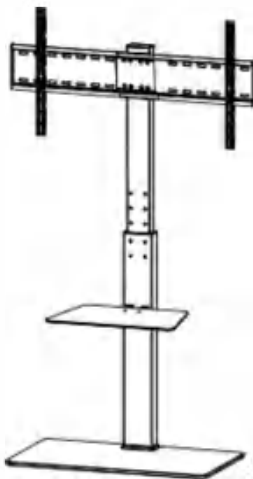

## NEED HELP? CONTACT US!

Have product questions? Need technical support? Please feel free to contact us:



[CustomerService@vevor.com](mailto:CustomerService@vevor.com)

This is the original instruction, please read all manual instructions carefully before operating. VEVOR reserves a clear interpretation of our user manual. The appearance of the product shall be subject to the product you received. Please forgive us that we won't inform you again if there are any technology or software updates on our product.

## **SAFETY INSTRUCTIONS**

### **WARNING:**

**Read this material before using this product. Failure to do so can result in serious injury.**

### **Assembly precautions**

- 1 .Assemble only according to these instructions. Improper assembly can create hazards.
2. Wear ANSI-approved safety goggles and heavy-duty work gloves during assembly.
3. Keep assembly area clean and well lit.
4. Keep bystanders out of the area during assembly.
5. Do not assemble when tired or when under the influence of alcohol, drugs or medication.
6. Weight capacity and other product capabilities apply to properly and completely assembled product only.
7. Assemble on a flat, level, hard and smooth surface capable of safely supporting a fully loaded Television Stand.

### **Use precautions**

#### **TO PREVENT SERIOUS INJURY AND DEATH FROM TIPPING:**

- 1. DO NOT SIT, STAND OR CLIMB ON THIS ITEM.**
2. This product is not a toy. Do not allow children to play with or near this item.
3. Do not exceed rated listed weight.Serious injury or property damage may occur!.
4. Use only on a flat, level, hard and smooth surface capable of safely supporting a fully loaded Television Stand.
5. Do not lift while loaded.
6. Use as intended only.
7. Inspect before every use; do not use if parts are loose or damaged.

### **SAVE THIS MANUAL**

## PRODUCT PARAMETER

Model	FSH28
Bearing Weight	<b>Total :132lbs Max</b> TV Bracket: HOlbsMAX Tray: 22lbs MAX
Mounting Dimension	100x100,100x200,100x400 200x200,200x300,200x400 300x300,300x400 400x400,400x600 600x600,600x800
Screen Size	85' Max
Product Size	841*397*1400 mm
Net Weight	17.05 kg
Gross Weight	18.15 kg

# PARTS LIST

	① X2		⑥ X1		R		Steel Washer
	② X1		⑦ X1		R		L X1
	③ X1		X2		R		13
	④ X1		⑨ X2		R		M X1 M4
	⑤ X1		⑩ X1		1		N X2
	⑥ X1		X2		,		G X2
	⑦ X1		X2		,		F X2
	⑧ X1		X2		,		
	⑨ X1		X2		5		
	⑩ X1		X2		,		
	⑪ X1		X2		,		
	⑫ X1		X2		W		
	⑬ X1		X2		,		
	⑭ X1		X2		W		

**FOR TV INSTALLATION**

	QHMHB			

## ASSEMBLY STEP

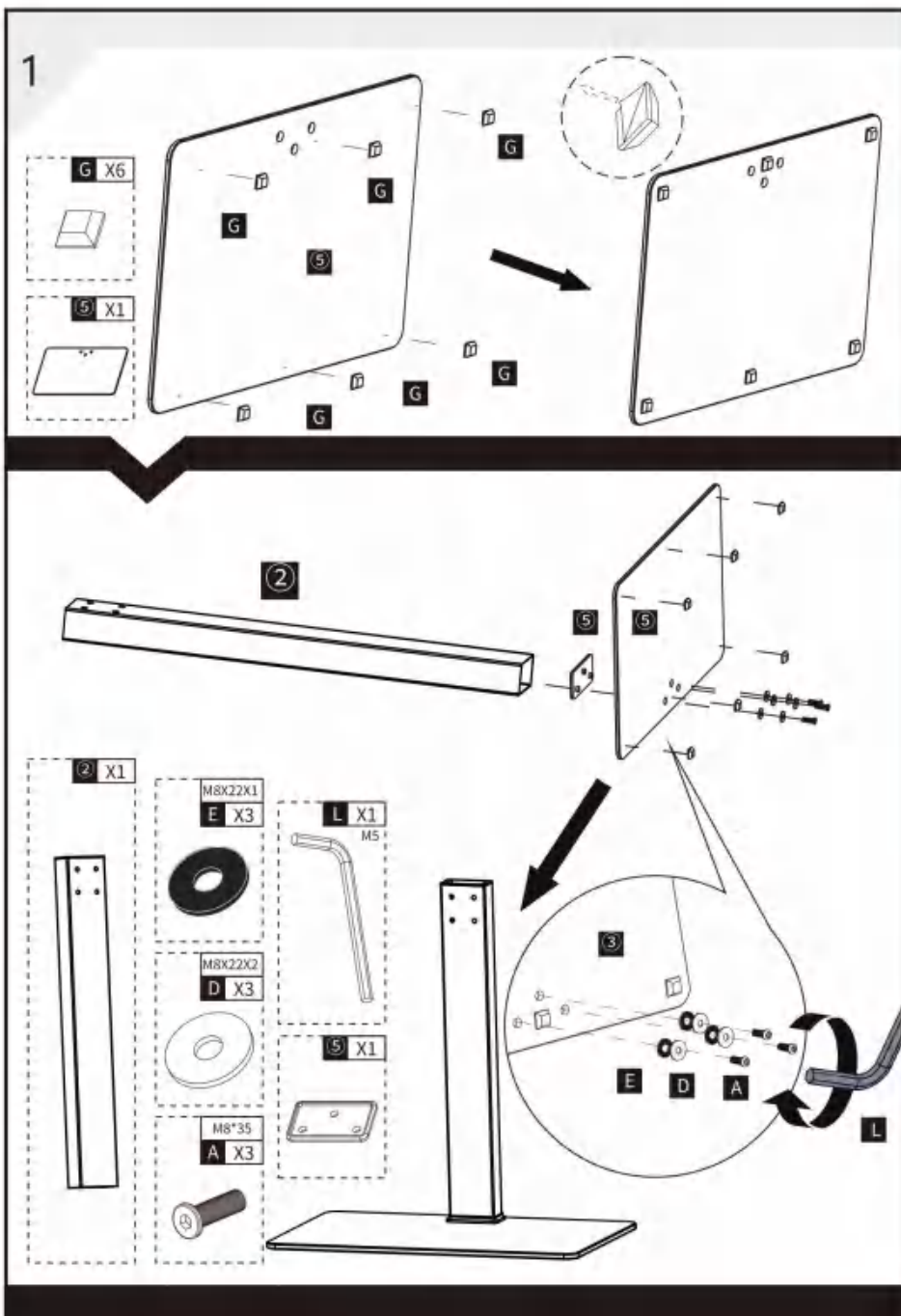

2

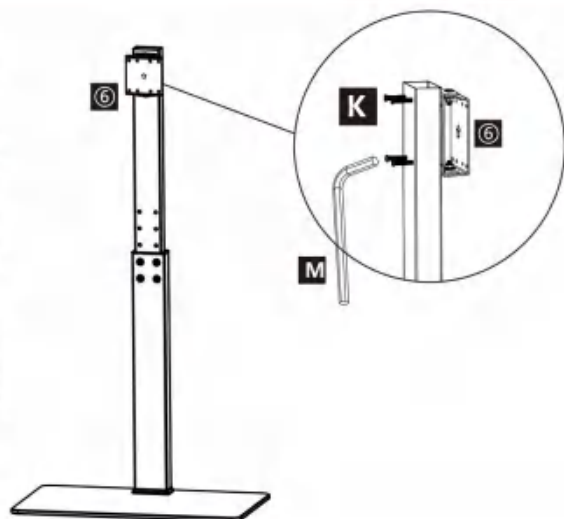
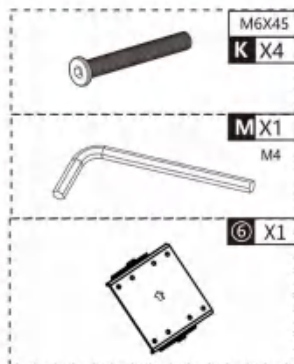
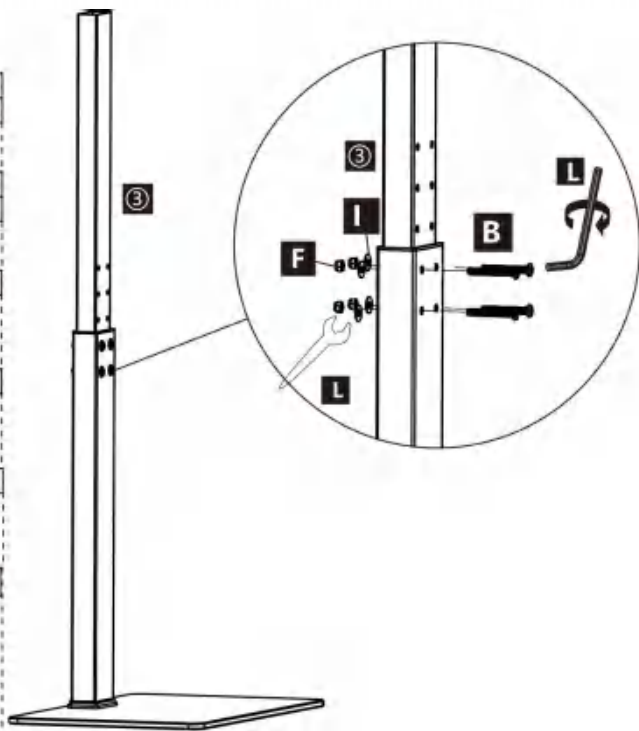
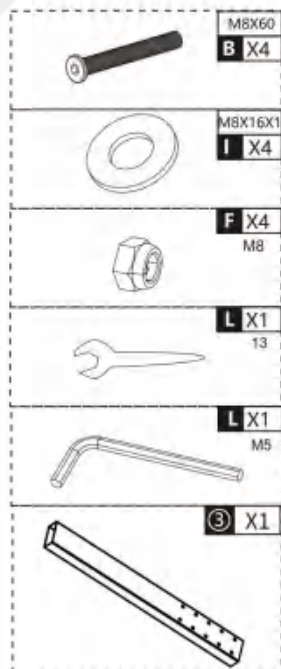



3

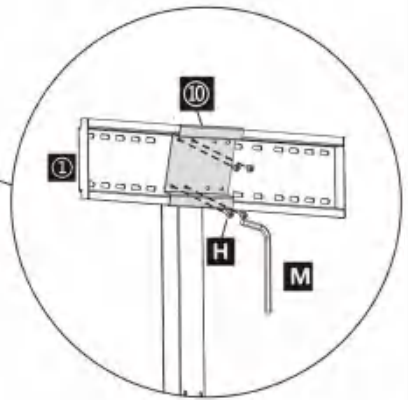
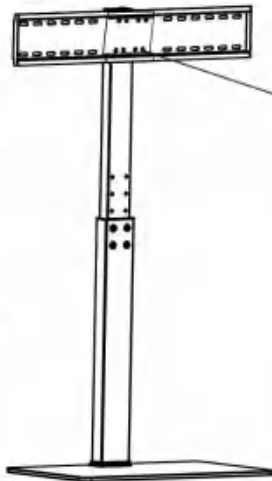
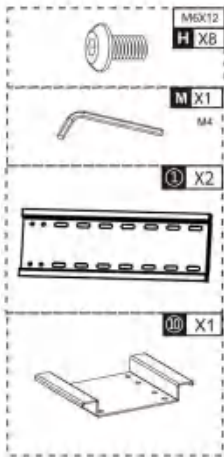

NOT INCLUDED

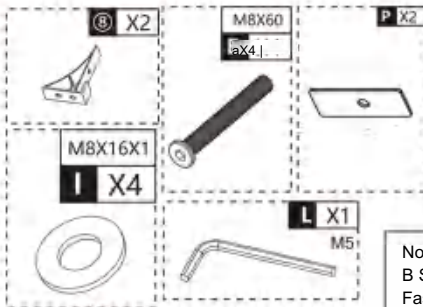

Note: During laminate installation,  
B Screw do not completely lock,  
Fasten screw B after installing screw C

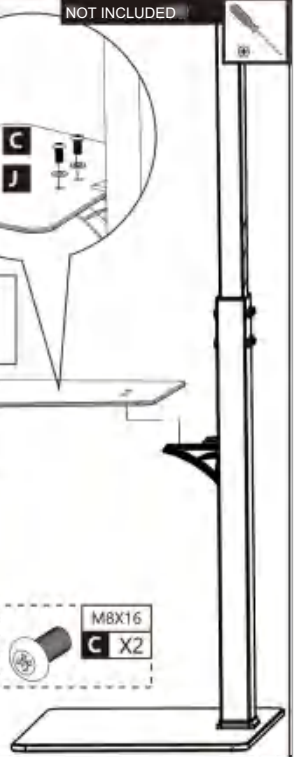
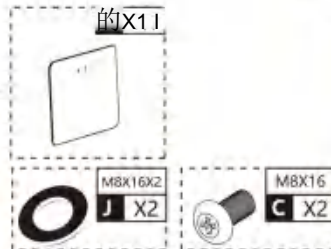
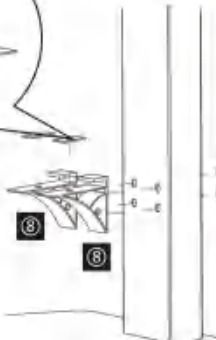
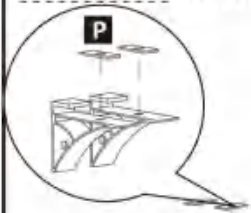

# 4

Measure the TV fixing holes Width and Height

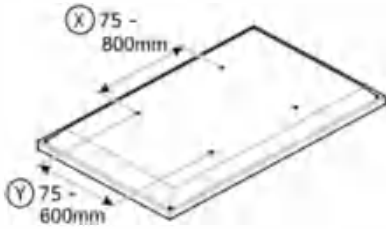

**A**

If width (X) is greater than 600mm or height® greater than 400mm STOP installation now and contact the customer help line

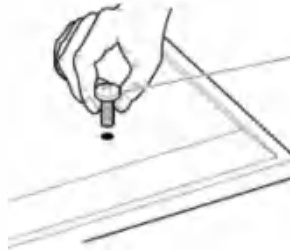

- TV1
- TV2
- TV3
- TV4

You are provided with 4 diameters of TV fixing screws, M6 and M8. Determine the screw diameter that fits.

Spacers

SP

For TVs with i regular/obstructed back



No Spacers

For TVs with flat/unobstructed back



**WARNING**

please keep for future reference.

**A**

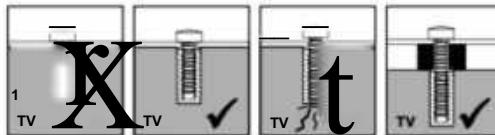

5

NOT INCLUDED

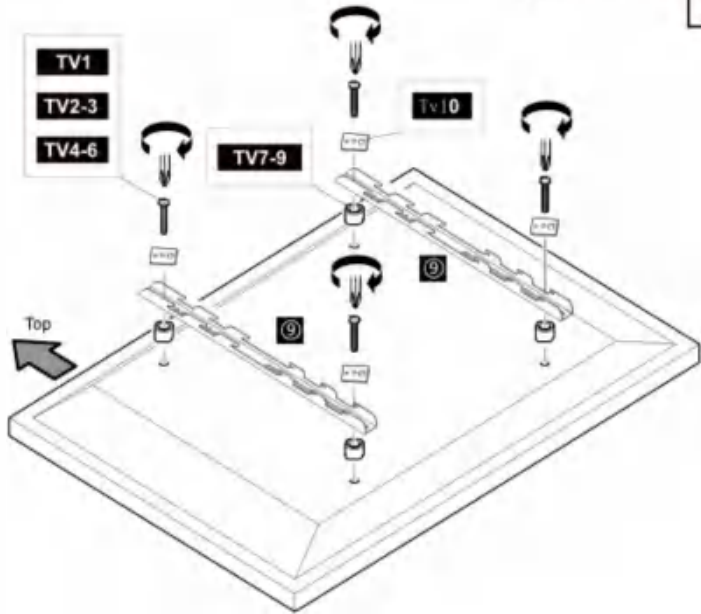

9 X2

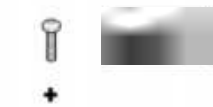

Washer with 3 holes  
TV10 X4

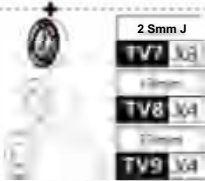

2.5mm J  
TV7 X4  
10mm  
TV8 X4  
TV9 X4



Washer with 3 holes  
TV7-9 X4

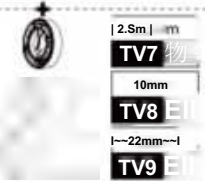

2.5mm J  
TV7 X4  
10mm  
TV8 X4  
TV9 X4



Washer with 3 holes  
TV9E X4

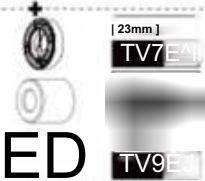

23mm J  
TV7E X4  
TV9E X4

Attach the bracket to the back of your TV using suitable screw, reducer and spacer combinations.

6

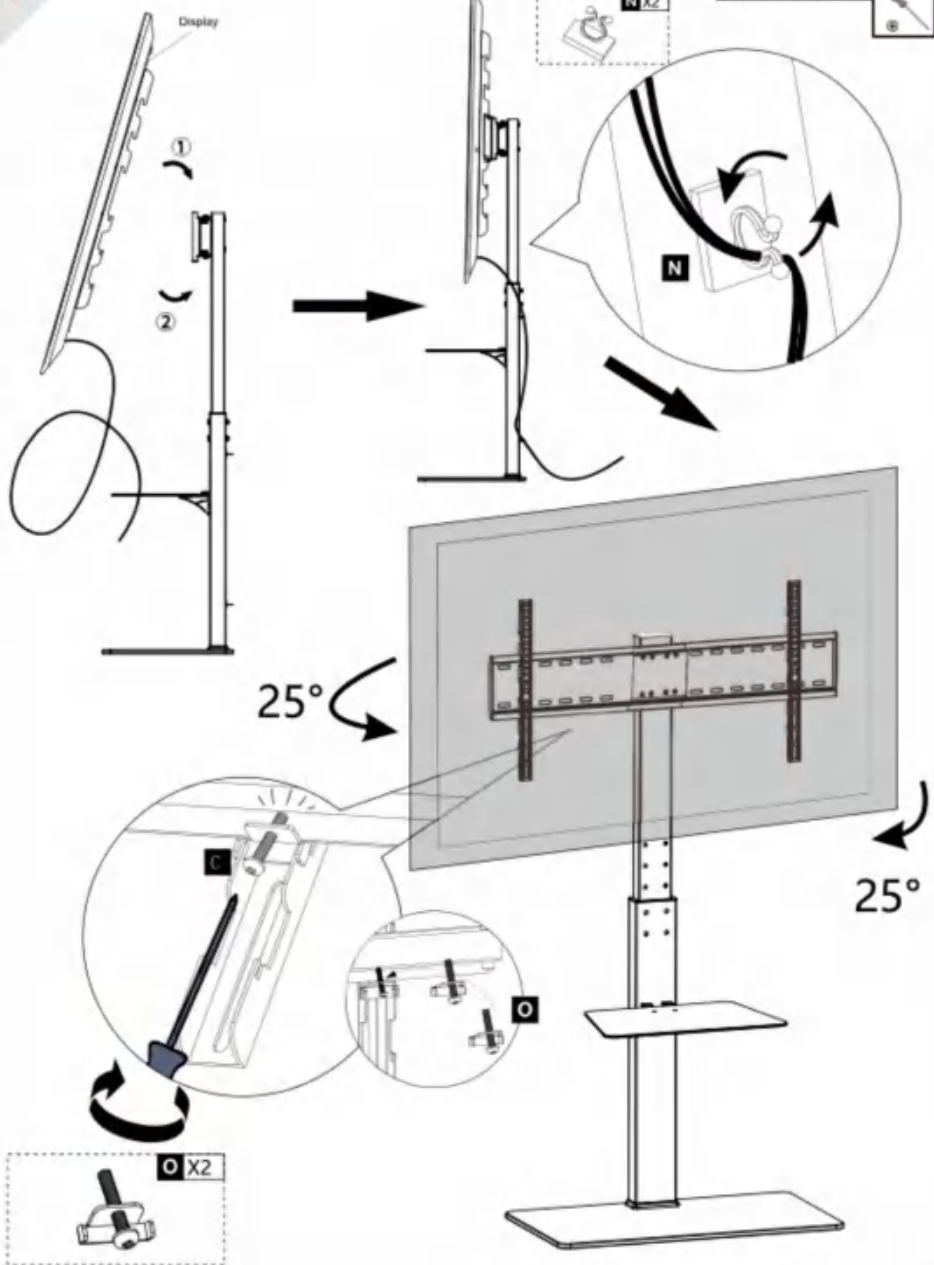

Manufacturer: Shanghaimuxinmuyeyouxiangongsi

Address: Shuangchenglu 803nong11 hao1602A-1609shi,  
baoshanqu, shanghai 200000 CN.

Imported to AUS: SIHAO PTY LTD. 1 ROKEVA STREETEAST-  
WOOD NSW2122 Australia

Imported to USA: Sanven Technology Ltd. Suite 250, 9166  
Anaheim Place, Rancho Cucamonga, CA91730



E-CrossStu GmbH

Mainzer Landstr.69, 60329 Frankfurt am Main.



YH CONSULTING LIMITED.

C/O YH Consulting Limited Office 147, Centurion House,  
London Road, Staines-upon-Thames, Surrey, TW18 4AX





# VEVOR<sup>®</sup>

TOUGH TOOLS, HALF PRICE

Technical Support and E-Warranty Certificate

[www.vevor.com/support](http://www.vevor.com/support)



# VEVOR

OUTILS ROBUSTES, MOITIÉ PRIX

Assistance technique et certificat de garantie électronique [www.vevor.com/support](http://www.vevor.com/support)

## SUPPORT DE TÉLÉVISION

## MANUEL D'UTILISATION

MODÈLE : FSH28

Nous continuons à nous engager à vous fournir des outils à des prix compétitifs.

« Économisez la moitié », « Moitié prix » ou toute autre expression similaire utilisée par nous ne représente qu'une estimation des économies que vous pourriez réaliser en achetant certains outils chez nous par rapport aux grandes marques et ne couvre pas nécessairement toutes les catégories d'outils que nous proposons. Nous vous rappelons de bien vouloir vérifier attentivement lorsque vous passez une commande chez nous si vous économisez réellement la moitié par rapport aux grandes marques.



# VEVOR®

SUPPORT DE TÉLÉVISION

OUTILS ROBUSTES, MOITIÉ PRIX

MODÈLE : FSH28

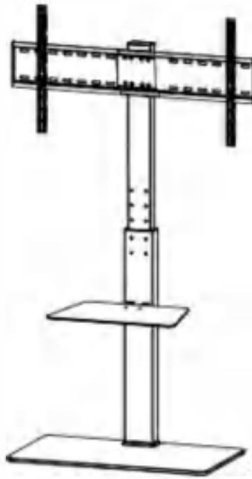

BESOIN D'AIDE? CONTACTEZ-NOUS!

Vous avez des questions sur les produits ? Besoin d'assistance technique ? N'hésitez pas à nous contacter.

Contactez-nous:



[ServiceClient@vevor.com](mailto:ServiceClient@vevor.com)

Il s'agit de la notice d'utilisation d'origine. Veuillez lire attentivement toutes les instructions du manuel avant de l'utiliser. VEVOR se réserve le droit d'interpréter clairement notre manuel d'utilisation. L'apparence du produit dépend du produit que vous avez reçu. Veuillez nous excuser, nous ne vous informerons plus en cas de mise à jour technologique ou logicielle de notre produit.

## CONSIGNES DE SÉCURITÉ

### AVERTISSEMENT:

Lisez ce document avant d'utiliser ce produit. Le non-respect de ces instructions peut entraîner des blessures graves.

### Précautions d'assemblage 1.

Assembler uniquement selon ces instructions. Un assemblage incorrect peut créer des dangers.

2. Portez des lunettes de sécurité approuvées ANSI et des gants de travail robustes pendant l'assemblage.
3. Gardez la zone de montage propre et bien éclairée.
4. Gardez les spectateurs hors de la zone pendant l'assemblage.
5. Ne montez pas lorsque vous êtes fatigué ou sous l'influence de l'alcool, de drogues ou de médicaments.
6. La capacité de poids et les autres capacités du produit s'appliquent uniquement au produit correctement et complètement assemblé.
7. Assemblez sur une surface plane, de niveau, dure et lisse capable de supporter en toute sécurité un support de télévision entièrement chargé.

### Précautions d'emploi

#### POUR ÉVITER LES BLESSURES GRAVES ET LA MORT EN RAISON DU BASCULEMENT :















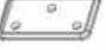

















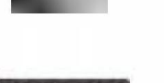



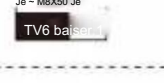
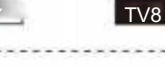







1. NE PAS S'ASSEOIR, SE TENIR DEBOUT OU MONTER SUR CET ARTICLE.
2. Ce produit n'est pas un jouet. Ne laissez pas les enfants jouer avec ou à proximité de cet article.
3. Ne dépassez pas le poids nominal indiqué. Des blessures graves ou des dommages matériels peuvent survenir.
4. Utiliser uniquement sur une surface plane, plane, dure et lisse capable de supporter en toute sécurité un support de télévision entièrement chargé.
5. Ne pas soulever pendant la charge.
6. Utiliser uniquement comme prévu.
7. Inspectez avant chaque utilisation ; ne pas utiliser si des pièces sont desserrées ou endommagées.

CONSERVER CE MANUEL

## PARAMÈTRE DU PRODUIT

Modèle	FSH28
Portant le poids	Total : 132 lb maximum Support TV : HOlbsMAX Plateau : 22 lb MAX
Dimensions de montage	100x100,100x200,100x400 200x200,200x300,200x400 300x300,300x400 400x400,400x600 600x600,600x800
Taille de l'écran	85' Max
Taille du produit	841*397*1400 mm
Poids net	17,05 kg
Poids brut	18,15 kg

LISTE DES PIÈCES

	<b>1</b> X2		<b>6</b> X1		R		Rondelle en plastique
	<b>2</b> X1		<b>7</b> X1		R		Rondelle en acier
	<b>3</b> X1		<b>8</b> X2		R		<b>L</b> X1 13
	<b>4</b> X1		<b>9</b> X2		R		<b>L</b> X1 M5
	<b>10</b> X1		<b>11</b> X1		1		<b>M</b> X1 M4
	<b>12</b> X1		<b>13</b> X1		,		<b>N</b> X2
	<b>14</b> X1		<b>15</b> X1		,		<b>O</b> X2
	<b>16</b> X1		<b>17</b> X1		,		<b>P</b> X2
	<b>18</b> X1		<b>19</b> X1		5		
	<b>20</b> X1		<b>21</b> X1		,		
	<b>22</b> X1		<b>23</b> X1		,		
	<b>24</b> X1		<b>25</b> X1		DANS		
	<b>26</b> X1		<b>27</b> X1		,		
	<b>28</b> X1		<b>29</b> X1		DANS		
	<b>30</b> X1		<b>31</b> X1		,		

POUR L'INSTALLATION DU TÉLÉVISEUR

Qhmb



Je - M6X16 Je  
TV2 et TV3



Je - M6X35 |  
TV3 la



Je - M8X15 |  
TV4



Je - M8X35 Je  
TV5 Baiser



Je - M8X50 Je  
TV6 Baiser



2.5 mm - Je  
Café TV7



10 mm  
TV8 Le



Je 22 mm  
TV9 II



(Rondelle à 3 trous)  
TV10

## ÉTAPE D'ASSEMBLAGE

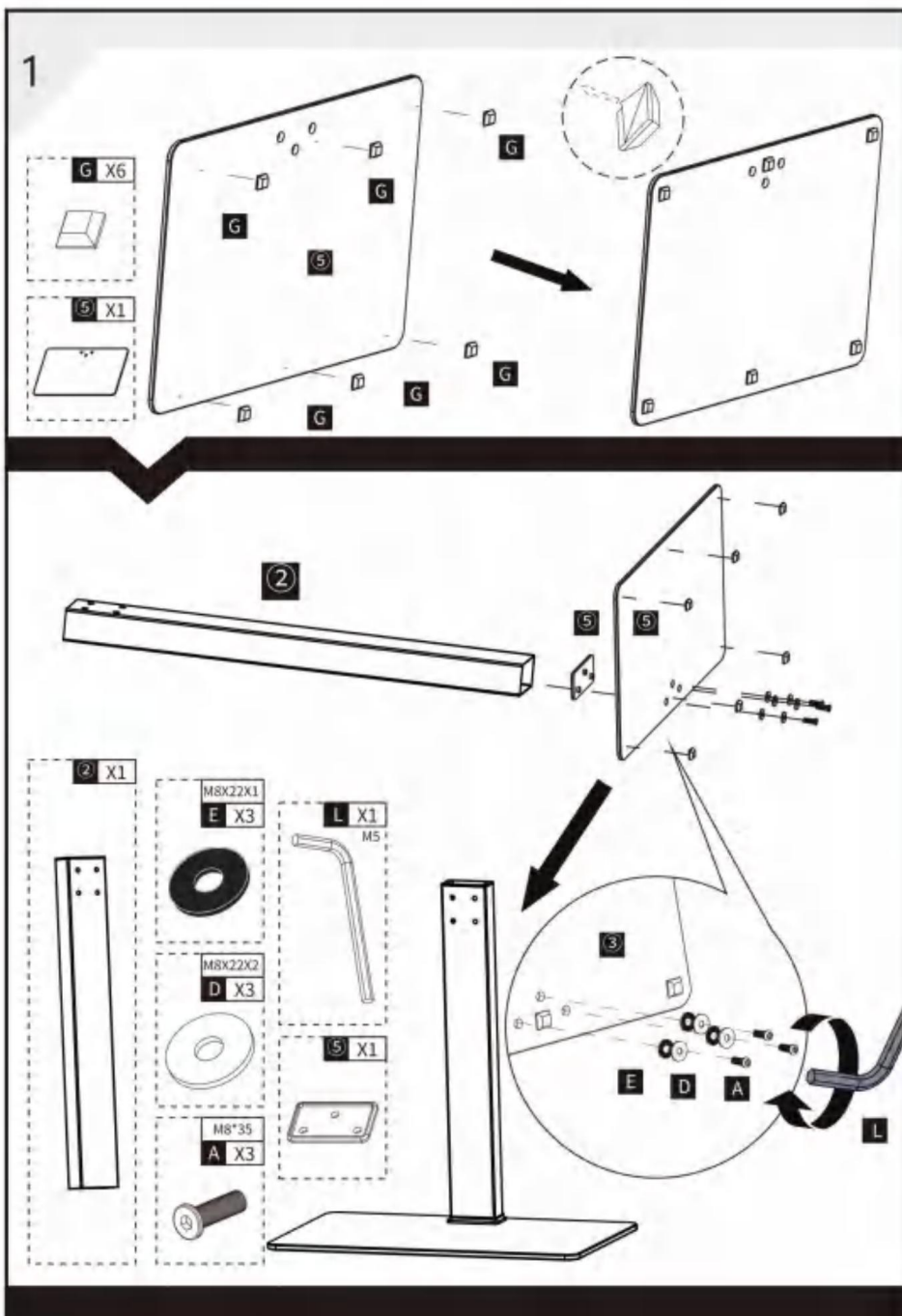

2

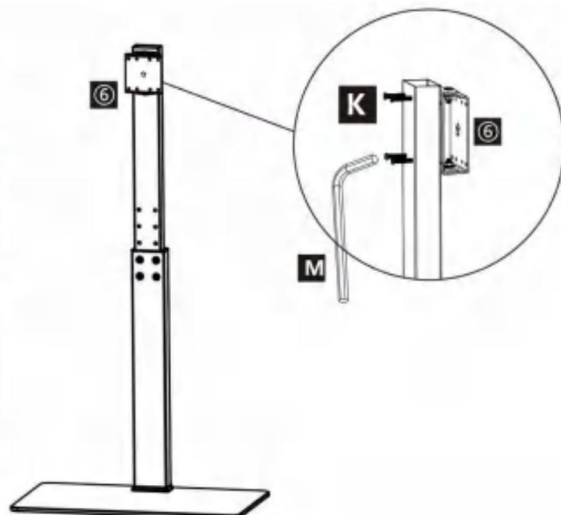
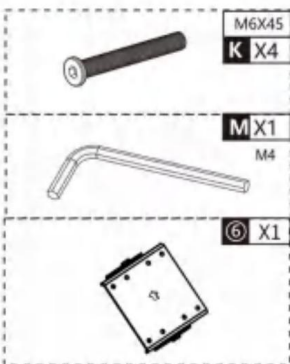
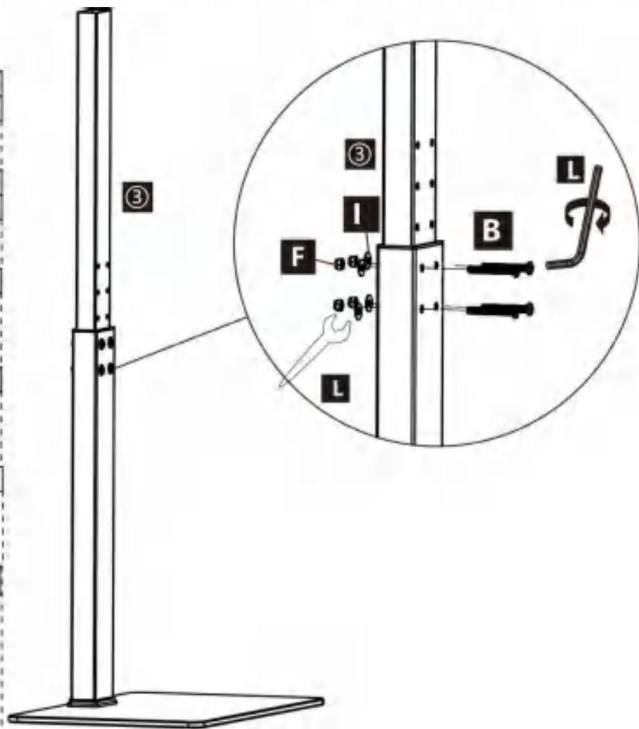
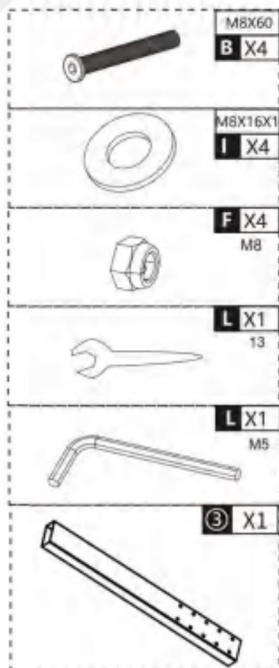



3

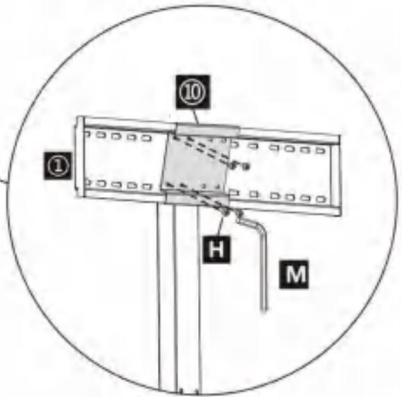
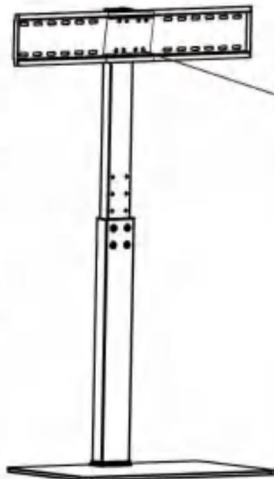
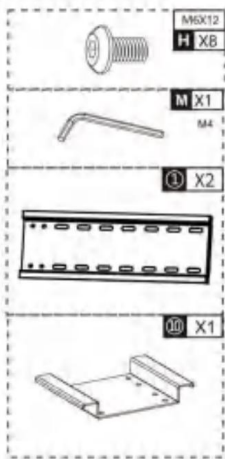

NON INCLUS

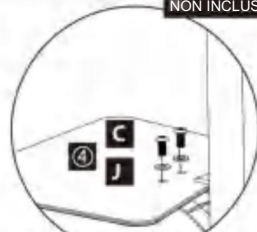
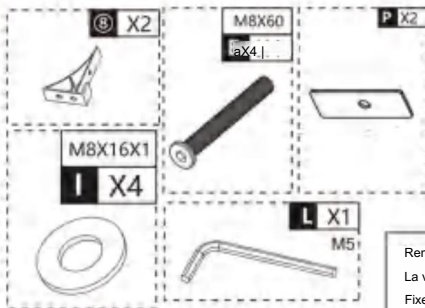

Remarque : Lors de l'installation du stratifié,  
La vis B ne se verrouille pas complètement.  
Fixez la vis B après avoir installé la vis C

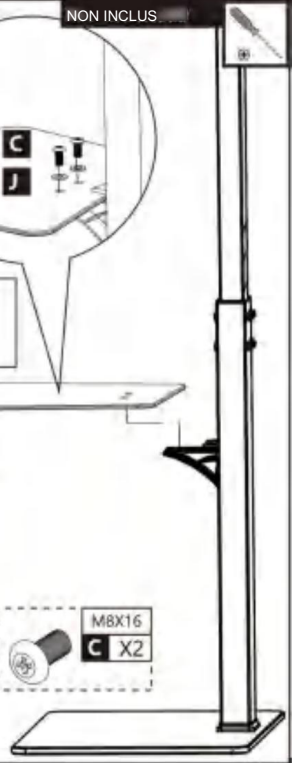
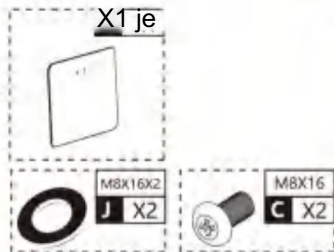
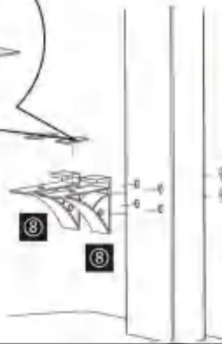
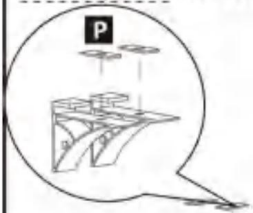

# 4

Mesurer la largeur et la hauteur des trous de fixation du téléviseur

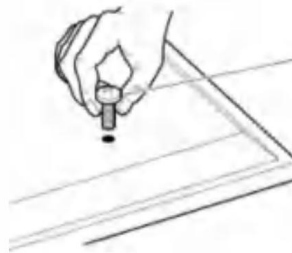
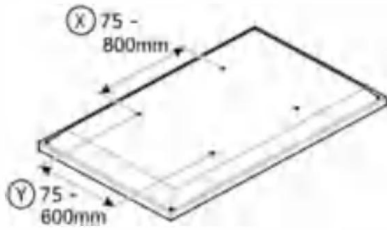

- TV1
- TV2
- TV3
- TV4

Si la largeur (X) est supérieure à 600mm ou hauteur (Y) supérieure à 400 mm ARRÊTEZ l'installation maintenant et contactez la ligne d'assistance client

Vous disposez de 4 diamètres de vis de fixation TV, M6 et M8. Déterminez le diamètre de vis qui convient.



Pour les téléviseurs avec un dos irrégulier/obstrué

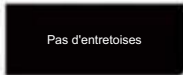

Pour les téléviseurs avec dos plat/sans obstruction

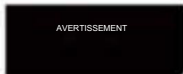

Veuillez conserver ce document pour référence ultérieure.

## UN

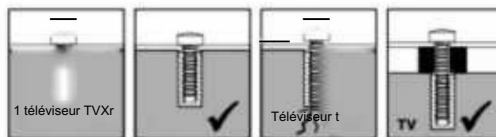

1 téléviseur TVXr

Téléviseur t

TV

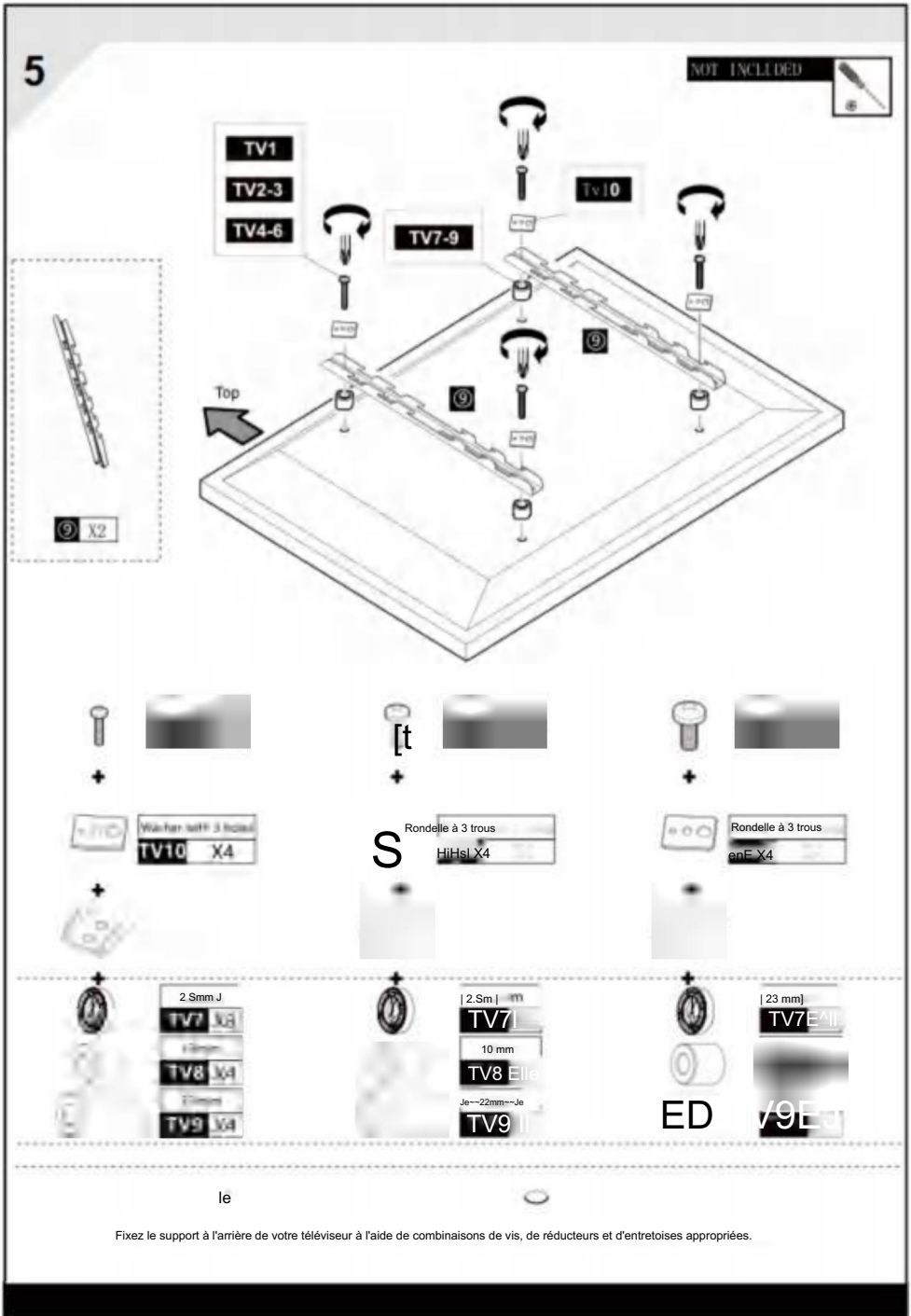

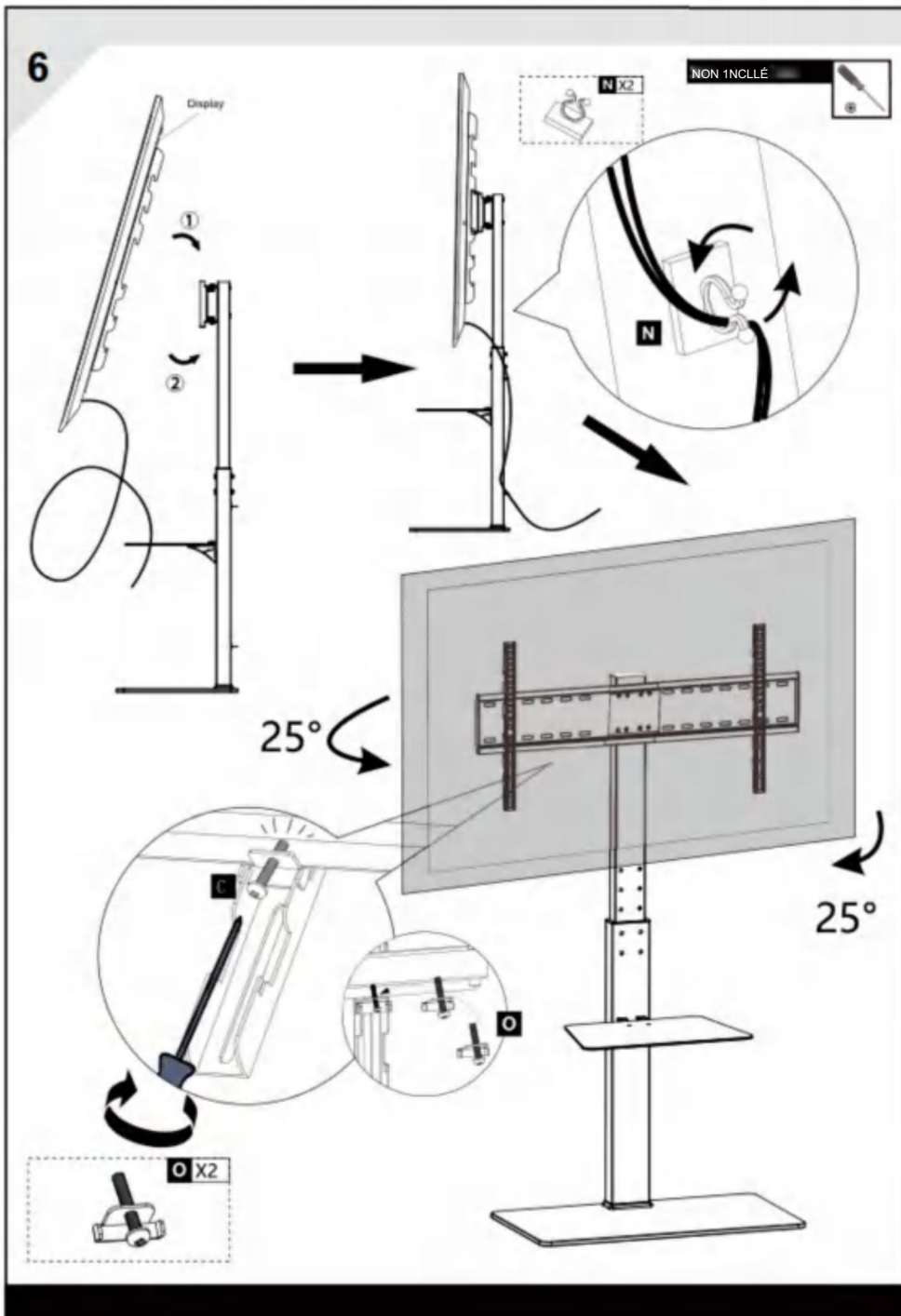

Fabricant : Shanghai muxinmuyeyouxiangongsi Adresse :  
Shuangchenglu 803nong11 hao1602A-1609shi, baoshanqu, shanghai  
200000 CN.

Importé en Australie : SIHAO PTY LTD. 1 ROKEVA STREETEAST-WOOD  
NSW2122 Australie

Importé aux États-Unis : Sanven Technology Ltd. Suite 250, 9166  
Anaheim Place, Rancho Cucamonga, CA91730



E-CrossStu GmbH  
Mainzer Landstr.69, 60329 Francfort-sur-le-Main.



YH CONSULTING LIMITÉE.  
A/S YH Consulting Limited Bureau 147, Centurion House, London  
Road, Staines-upon-Thames, Surrey, TW18 4AX





V ET LER<sup>®</sup>

DIFFICILE OUTILS V, DEMI PRIX

Assistance technique et certificat de garantie  
électronique [www.vevor.com/support](http://www.vevor.com/support)

---





**VEVOR**

**ROBUSTE WERKZEUGE ZUM HALBEN PREIS**

Technischer Support und E-Garantie-Zertifikat [www.vevor.com/support](http://www.vevor.com/support)

# **Fernsehständer**

## **BENUTZERHANDBUCH**

**MODELL: FSH28**

Wir sind weiterhin bestrebt, Ihnen Werkzeuge zu wettbewerbsfähigen Preisen anzubieten. „Sparen Sie die Hälfte“, „Halber Preis“ oder andere ähnliche Ausdrücke, die wir verwenden, stellen lediglich eine Schätzung der Ersparnis dar, die Sie beim Kauf bestimmter Werkzeuge bei uns im Vergleich zu den großen Topmarken erzielen können, und bedeuten nicht notwendigerweise, dass sie alle von uns angebotenen Werkzeugkategorien abdecken. Wir möchten Sie freundlich daran erinnern, bei Ihrer Bestellung bei uns sorgfältig zu prüfen, ob Sie im Vergleich zu den großen Topmarken tatsächlich die Hälfte sparen.



# VEVOR®

Fernsehständer

ROBUSTE WERKZEUGE ZUM HALBEN PREIS

MODELL: FSH28

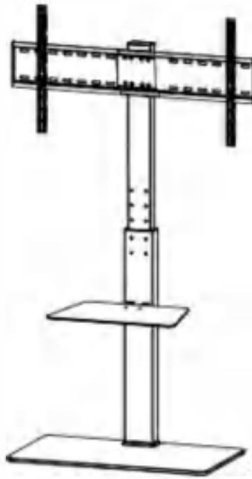

**Brauchen Sie Hilfe? Kontaktieren Sie uns!**

Haben Sie Fragen zu unseren Produkten? Benötigen Sie technische Unterstützung?

Kontakt:



[Kundenservice@vevor.com](mailto:Kundenservice@vevor.com)

Dies ist die Originalanleitung. Bitte lesen Sie alle Anweisungen sorgfältig durch, bevor Sie das Gerät in Betrieb nehmen. VEVOR behält sich eine klare Auslegung unserer Bedienungsanleitung vor. Das Erscheinungsbild des Produkts richtet sich nach dem Produkt, das Sie erhalten haben. Bitte verzeihen Sie uns, dass wir Sie nicht erneut informieren, wenn es Technologie- oder Software-Updates für unser Produkt gibt.

## SICHERHEITSHINWEISE

### **WARNUNG:**

**Lesen Sie dieses Material, bevor Sie dieses Produkt verwenden. Andernfalls kann es zu schweren Verletzungen kommen.**

### **Vorsichtsmaßnahmen bei der**

**Montage** 1. Führen Sie die Montage nur gemäß dieser Anleitung durch. Eine unsachgemäße Montage kann zu Gefahren führen.

2. Tragen Sie während der Montage eine ANSI-geprüfte Schutzbrille und strapazierfähige Arbeitshandschuhe.
3. Halten Sie den Versammlungsbereich sauber und gut beleuchtet.
4. Halten Sie während der Montage unbeteiligte Zuschauer vom Bereich fern.
5. Nicht montieren, wenn Sie müde sind oder unter dem Einfluss von Alkohol, Drogen oder Medikamenten stehen.
6. Gewichtskapazität und andere Produkteigenschaften gelten nur für ordnungsgemäß und vollständig montierte Produkte.
7. Auf einer flachen, ebenen, harten und glatten Oberfläche zusammenbauen, die einen voll beladenen Fernsehständer sicher tragen kann.

### **Vorsichtsmaßnahmen treffen**

#### **SO VERMEIDEN SIE SCHWERE VERLETZUNGEN UND TOD DURCH UNKIPPEN:**

**1. Setzen, stellen oder klettern Sie nicht auf diesen Gegenstand.**















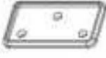

















































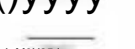











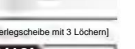

2. Dieses Produkt ist kein Spielzeug. Erlauben Sie Kindern nicht, mit diesem Produkt zu spielen oder sich in seiner Nähe aufzuhalten.
3. Das angegebene Nenngewicht darf nicht überschritten werden. Es kann zu schweren Verletzungen oder Sachschäden kommen!
4. Nur auf einer flachen, ebenen, harten und glatten Oberfläche verwenden, die einen voll beladenen Fernsehständer sicher tragen kann.
5. Nicht unter Last heben.
6. Nur bestimmungsgemäß verwenden.
7. Vor jedem Gebrauch prüfen; nicht verwenden, wenn Teile lose oder beschädigt sind.

**BEWAHREN SIE DIESES HANDBUCH AUF**











## PRODUKTPARAMETER

Modell	FSH28
Lagergewicht	<b>Gesamt: 132 Pfund max.</b> TV-Halterung: HOlbsMAX Tablett: 22 Pfund MAX
Montagemaße	100x100,100x200,100x400 200x200,200x300,200x400 300 x 300,300 x 400 400 x 400,400 x 600 600 x 600,600 x 800
Bildschirmgröße	85" Max
Produktgröße	841*397*1400 mm
Nettogewicht	17,05 kg
Bruttogewicht	18,15 kg

## TEILELISTE

 <p>① X2</p>		 <p>⑥ X1</p>		 <p>R</p>		 <p>L X1 13</p>	
 <p>② X1</p>		 <p>⑦ X1</p>		 <p>R</p>		 <p>L X1 M5</p>	
 <p>③ X1</p>		 <p>⑧ X2</p>		 <p>R</p>		 <p>M X1 M4</p>	
 <p>④ X1</p>		 <p>⑨ X2</p>		 <p>1</p>		 <p>N X2</p>	
 <p>⑤ X1</p>		 <p>⑩ X1</p>		 <p>,</p>		 <p>O X2</p>	
 <p>Frage X1</p>		 <p>⑪ X1</p>		 <p>,</p>		 <p>P X2</p>	
 <p>Frage X1</p>		 <p>⑫ X1</p>		 <p>,</p>		 <p>5</p>	
 <p>Frage X1</p>		 <p>⑬ X1</p>		 <p>,</p>		 <p>IN</p>	
 <p>Frage X1</p>		 <p>⑭ X1</p>		 <p>,</p>		 <p>IN</p>	
 <p>Frage X1</p>		 <p>⑮ X1</p>		 <p>,</p>		 <p>IN</p>	
 <p>Frage X1</p>		 <p>⑯ X1</p>		 <p>,</p>		 <p>IN</p>	
 <p>Frage X1</p>		 <p>⑰ X1</p>		 <p>,</p>		 <p>IN</p>	
 <p>Frage X1</p>		 <p>⑱ X1</p>		 <p>,</p>		 <p>IN</p>	
 <p>Frage X1</p>		 <p>⑲ X1</p>		 <p>,</p>		 <p>IN</p>	
 <p>Frage X1</p>		 <p>⑳ X1</p>		 <p>,</p>		 <p>IN</p>	
 <p>Frage X1</p>		 <p>㉑ X1</p>		 <p>,</p>		 <p>IN</p>	
 <p>Frage X1</p>		 <p>㉒ X1</p>		 <p>,</p>		 <p>IN</p>	
 <p>Frage X1</p>		 <p>㉓ X1</p>		 <p>,</p>		 <p>IN</p>	
 <p>Frage X1</p>		 <p>㉔ X1</p>		 <p>,</p>		 <p>IN</p>	
 <p>Frage X1</p>		 <p>㉕ X1</p>		 <p>,</p>		 <p>IN</p>	

  

<p>FÜR DIE TV-INSTALLATION</p>				
 <p>Qhmhb</p>	 <p>I-M6X16 I TV2yl</p>	 <p>I-M6X35 I TV3 la</p>	 <p>I-M8X15 I TV4_</p>	 <p>I-M8X35 I TV5 Kuss</p>
 <p>I-M8X50 I TV6 Kuss</p>	 <p>2,5 mm - I TV7-Kaffee</p>	 <p>10 mm TV8 Die</p>	 <p>Ich 22mm Ich TV9 Er</p>	 <p>Unterlegscheibe mit 3 Löchern TV10I</p>

## MONTAGESTRITT

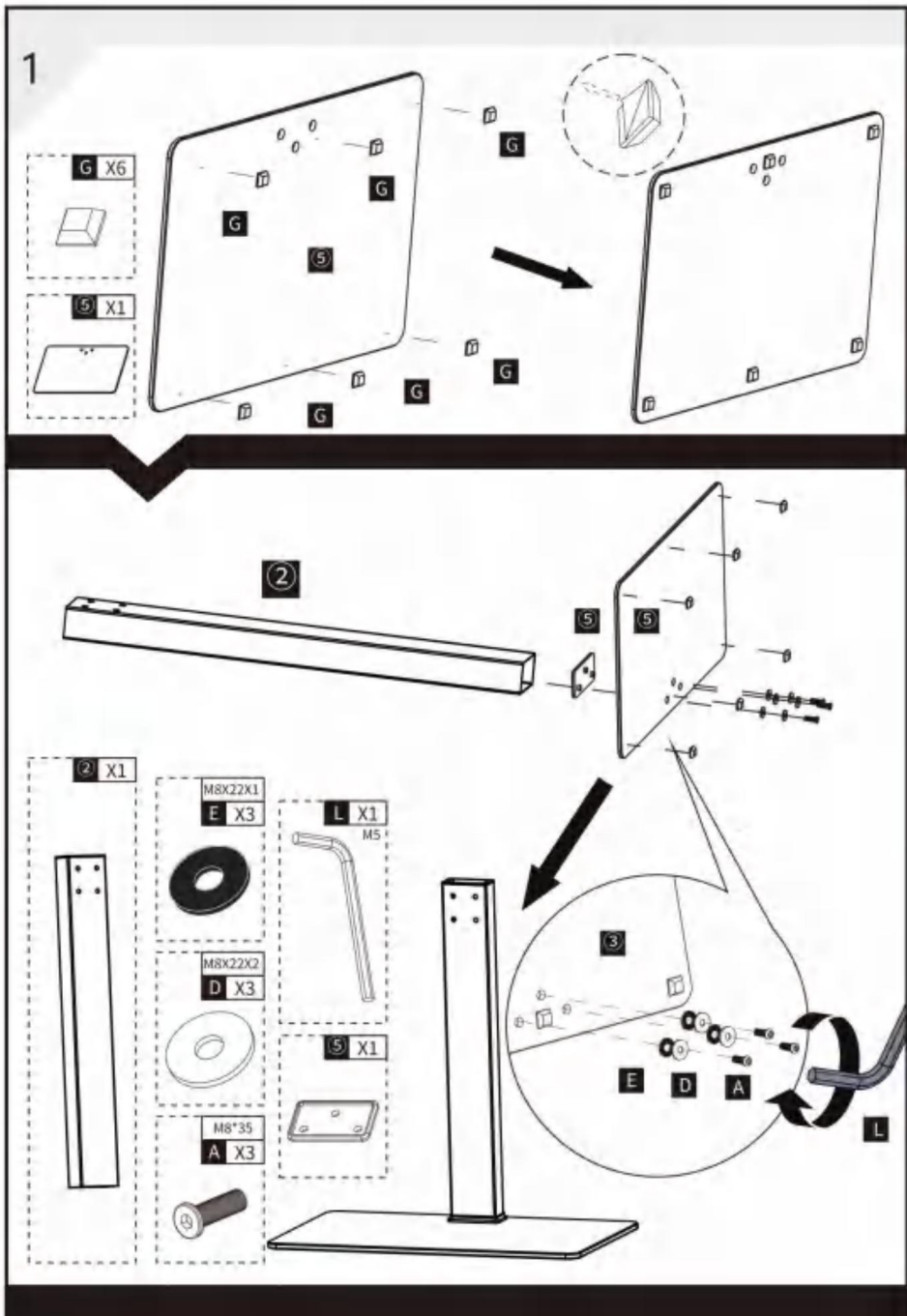

2

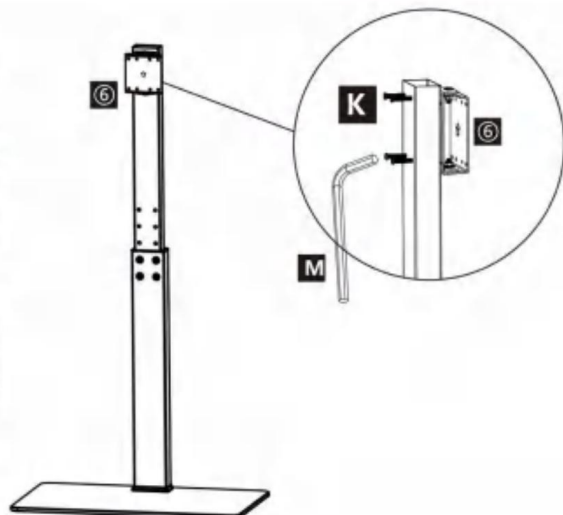
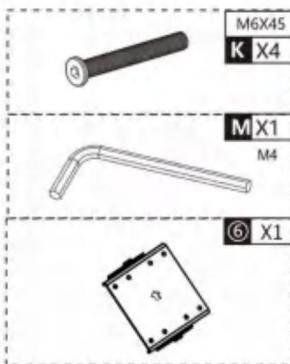
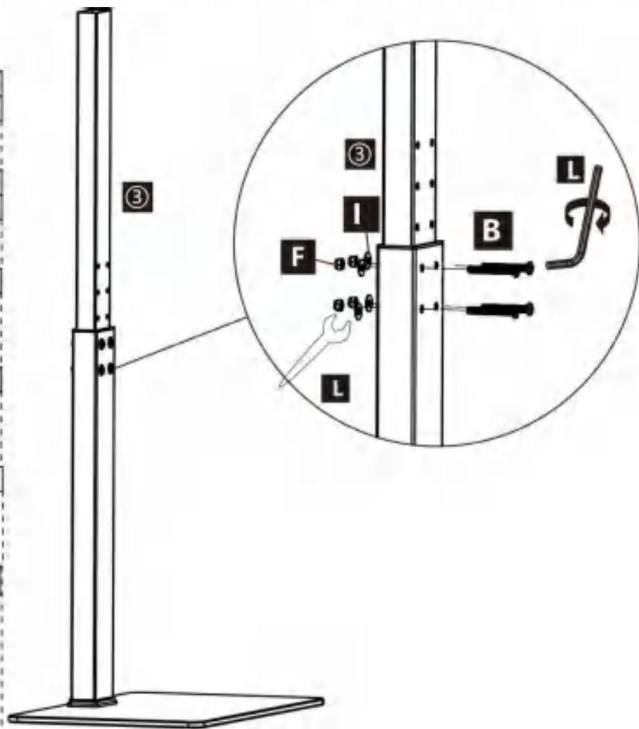
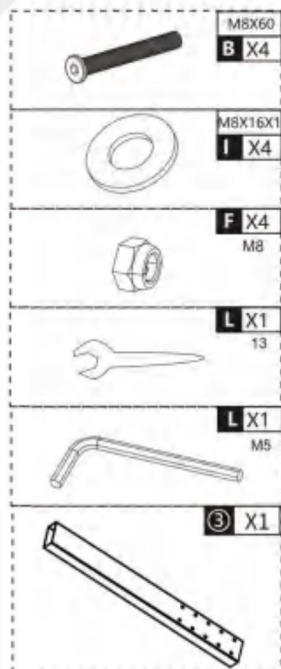



3

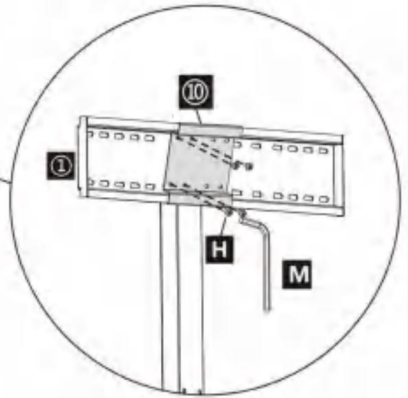
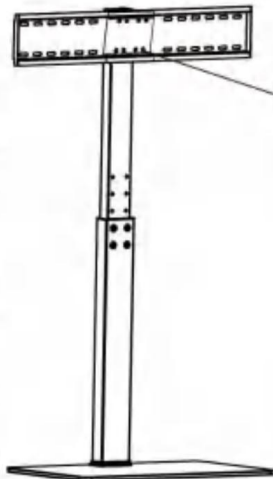
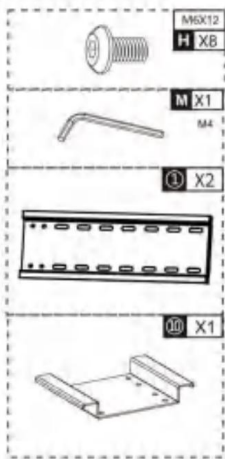

NICHT INBEGRIFFEN

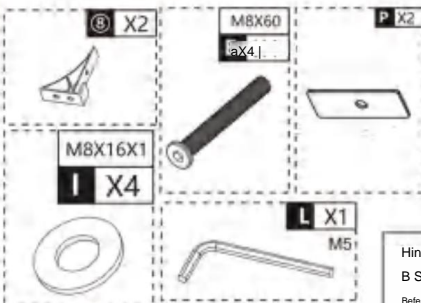

Hinweis: Bei der Laminatverlegung  
B Schraube nicht vollständig verriegeln,  
Befestigen Sie Schraube B, nachdem Sie Schraube C angebracht haben

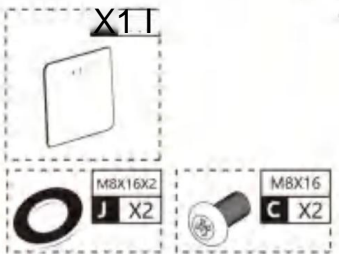
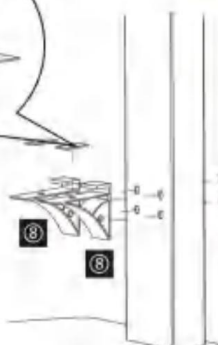
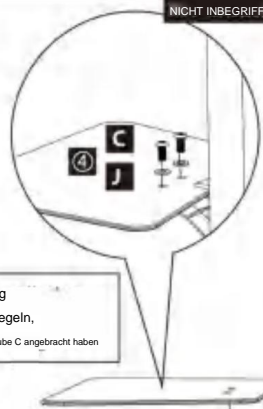

# 4

Messen Sie die Breite und Höhe der Befestigungslöcher des Fernsehers

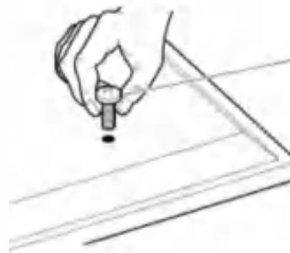
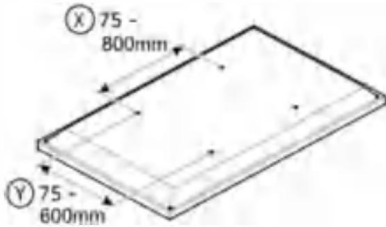

- TV1
- TV2
- TV3
- TV4

Wenn die Breite (X) größer ist als 600mm oder die Höhe (Y) größer als 400mm STOPPEN Sie die Installation sofort und kontaktieren Sie die Kunden-Hotline

Zur Verfügung stehen Ihnen 4 Durchmesser an TV-Befestigungsschrauben, M6 und M8. Bestimmen Sie den passenden Schraubendurchmesser.

Spacers

SP

Für Fernseher mit unregelmäßiger/verstopfter Rückseite



Keine Abstandshalter

Für Fernseher mit flacher/freier Rückseite



**WARNUNG**

Bitte bewahren Sie es zum späteren Nachschlagen auf.

# A

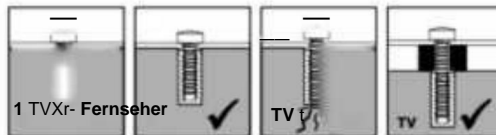

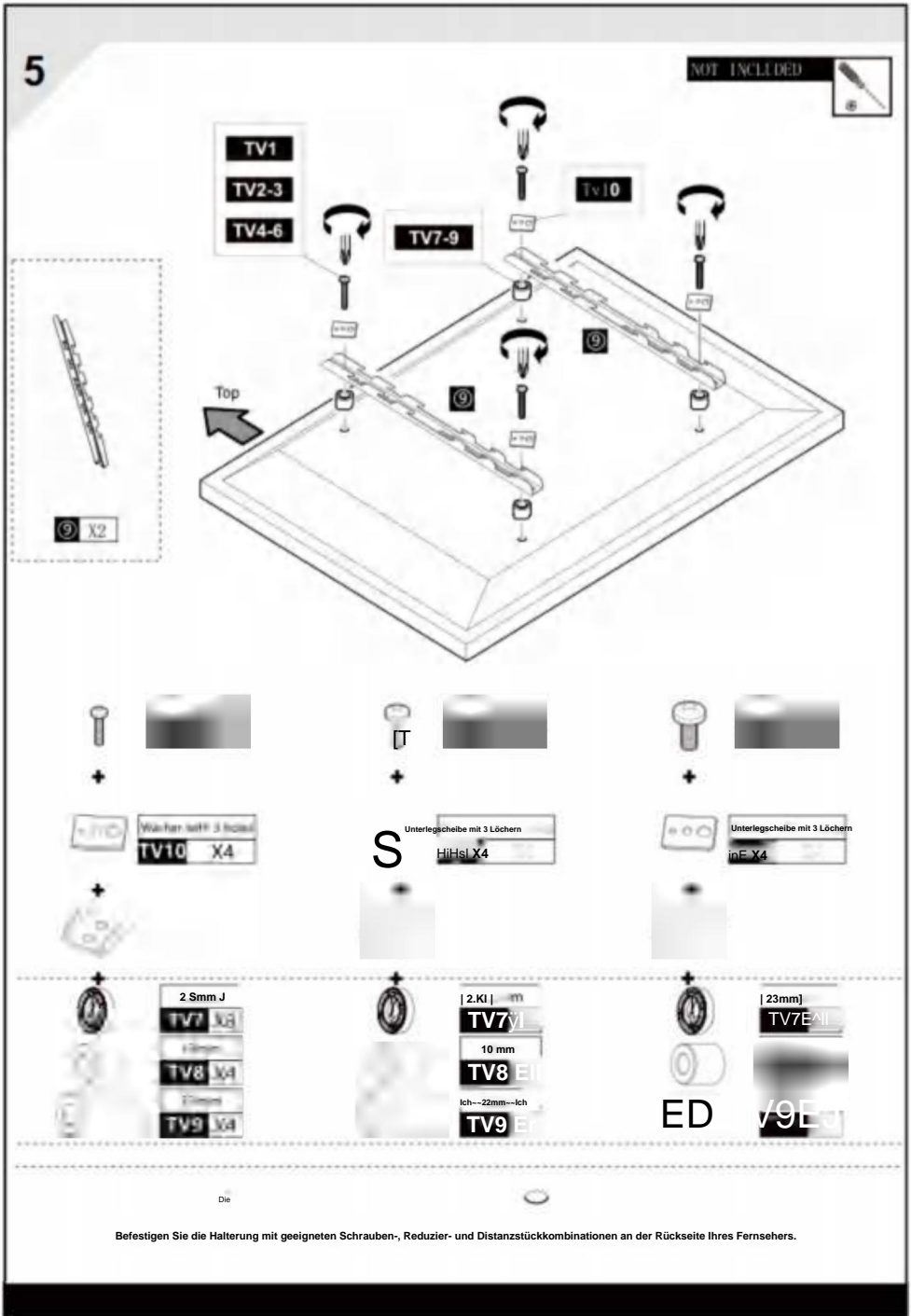

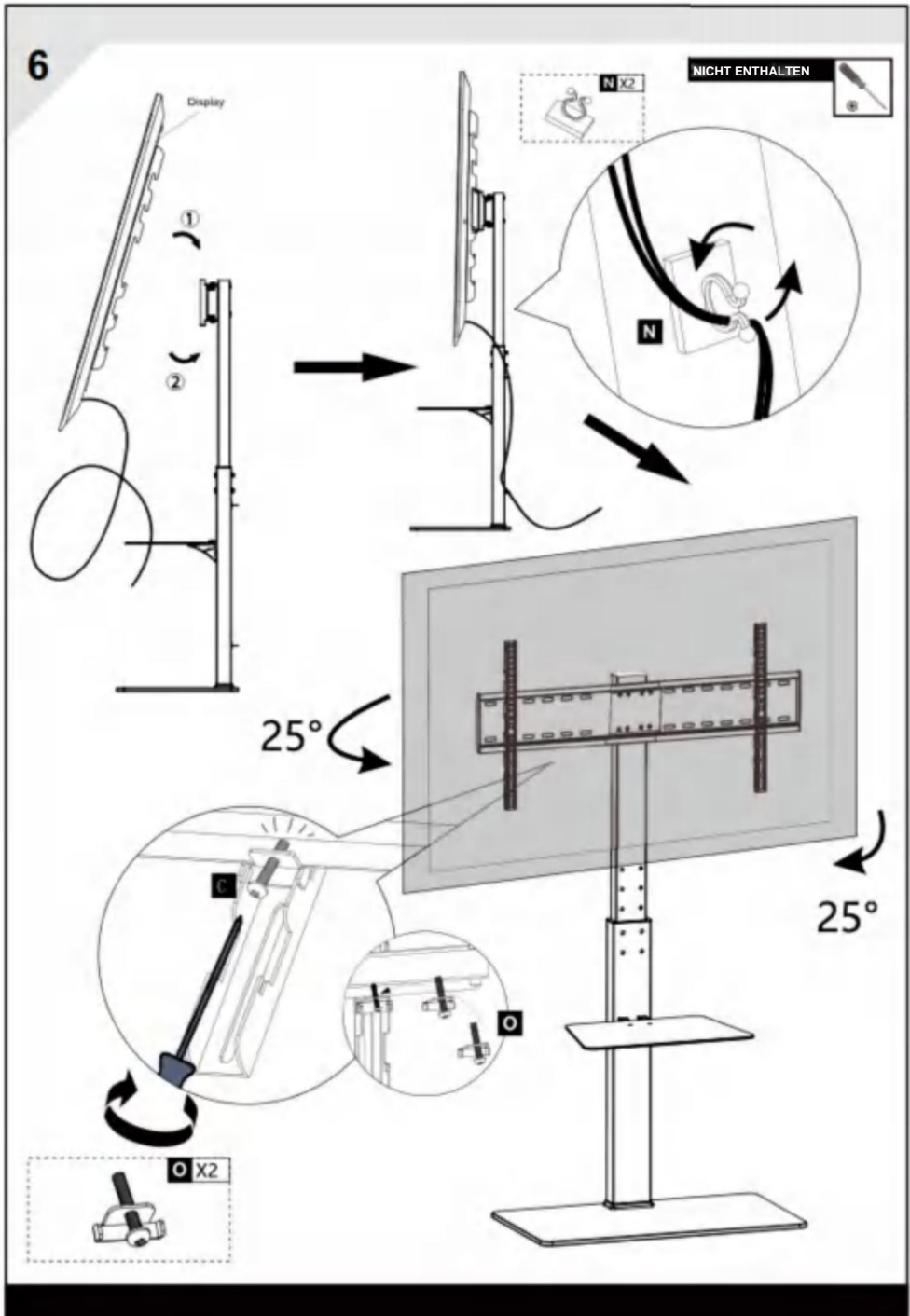

Hersteller: Shanghaimuxinmuyeyouxiangongsi Adresse:

Shuangchenglu 803nong11 hao1602A-1609shi, baoshanqu, Shanghai  
200000 CN.

Nach AUS importiert: SIHAO PTY LTD. 1 ROKEVA STREETEAST-WOOD  
NSW2122 Australien

Importiert in die USA: Sanven Technology Ltd. Suite 250, 9166 Anaheim  
Place, Rancho Cucamonga, CA91730



E-CrossStu GmbH  
Mainzer Landstr.69, 60329 Frankfurt am Main.



YH CONSULTING LIMITED.  
C/O YH Consulting Limited Office 147, Centurion House, London  
Road, Staines-upon-Thames, Surrey, TW18 4AX





**V** UND **DER R**®

**HART** WERKZEUGE V, HALB **PREIS**

**Technischer Support und E-Garantie-Zertifikat**

[www.vevor.com/support](http://www.vevor.com/support)

---





# VEVORE

**UTENSILI RESISTENTI, A METÀ PREZZO**

Supporto tecnico e certificato di garanzia elettronica [www.vevor.com/support](http://www.vevor.com/support)

**SUPPORTO PER TELEVISIONE**

**MANUALE D'USO**

MODELLO: FSH28

Continuiamo a impegnarci per fornirvi strumenti a prezzi competitivi.

"Risparmia la metà", "Metà prezzo" o qualsiasi altra espressione simile da noi utilizzata rappresenta solo una stima del risparmio che potresti ottenere acquistando determinati utensili con noi rispetto ai principali marchi principali e non necessariamente intende coprire tutte le categorie di utensili da noi offerti. Ti ricordiamo gentilmente di verificare attentamente quando effettui un ordine con noi se stai effettivamente risparmiando la metà rispetto ai principali marchi principali.



# VEVOR®

SUPPORTO PER TELEVISIONE

UTENSILI RESISTENTI, A METÀ PREZZO

MODELLO: FSH28

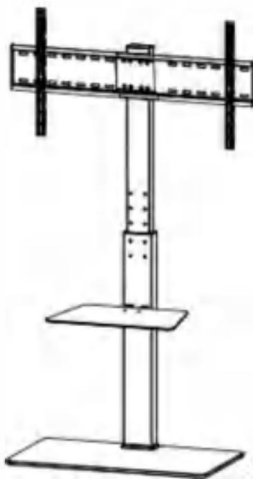

## HAI BISOGNO DI AIUTO? CONTATTACI!

Hai domande sul prodotto? Hai bisogno di supporto tecnico? Non esitare a contattarci contattaci:



[Servizio.Clienti@vevor.com](mailto:Servizio.Clienti@vevor.com)

Questa è l'istruzione originale, si prega di leggere attentamente tutte le istruzioni del manuale prima di utilizzare. VEVOR si riserva una chiara interpretazione del nostro manuale utente. L'aspetto del prodotto sarà soggetto al prodotto ricevuto. Vi preghiamo di perdonarci se non vi informeremo di nuovo se ci sono aggiornamenti tecnologici o software sul nostro prodotto.

## ISTRUZIONI DI SICUREZZA

### AVVERTIMENTO:

**Leggere questo materiale prima di utilizzare questo prodotto. La mancata osservanza di questa precauzione può causare gravi lesioni.**

### Precauzioni di montaggio 1.

Montare solo secondo queste istruzioni. Un montaggio improprio può creare pericoli.

2. Durante il montaggio, indossare occhiali di sicurezza omologati ANSI e guanti da lavoro resistenti.
3. Mantenere l'area di assemblaggio pulita e ben illuminata.
4. Tenere gli astanti fuori dall'area durante l'assemblaggio.
5. Non riunirsi quando si è stanchi o sotto l'effetto di alcol, droghe o farmaci.
6. La capacità di peso e le altre caratteristiche del prodotto si applicano solo al prodotto correttamente e completamente assemblato.
7. Montare su una superficie piana, livellata, dura e liscia, in grado di sostenere in modo sicuro un supporto per TV completamente carico.

### Usare precauzioni

#### PER PREVENIRE LESIONI GRAVI E MORTE DOVUTE AL RIBALTAMENTO:

##### 1. NON SEDERSI, STARE IN PIEDI O SALIRE SU QUESTO OGGETTO.















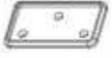











2. Questo prodotto non è un giocattolo. Non permettere ai bambini di giocare con o vicino a questo articolo.
3. Non superare il peso nominale indicato. Potrebbero verificarsi gravi lesioni o danni alla proprietà.
4. Utilizzare solo su una superficie piana, livellata, dura e liscia in grado di sostenere in modo sicuro un supporto per televisore completamente carico.
5. Non sollevare oggetti carichi.
6. Utilizzare solo come previsto.
7. Ispezionare prima di ogni utilizzo; non utilizzare se alcune parti sono allentate o danneggiate.

### SALVA QUESTO MANUALE







## PARAMETRO PRODOTTO

Modello	FSH28
Peso del cuscinetto	<b>Totale: 132 libbre massimo</b> Supporto TV: HOlbsMAX Vassoio: 22 libbre MAX
Dimensioni di montaggio	100x100,100x200,100x400 200x200,200x300,200x400 300x300,300x400 400x400,400x600 600x600,600x800
Dimensioni dello schermo	85" Massimo
Dimensioni del prodotto	841*397*1400 millimetri
Peso netto	17,05 kg
Peso lordo	18,15 kg

ELENCO DELLE PARTI

	<b>1</b> X2		<b>6</b> X1		<b>R</b>		<b>L</b> X1 13
	<b>2</b> X1		<b>7</b> X1		<b>R</b>		<b>L</b> X1 M5
	<b>3</b> X1		<b>8</b> X2 e		<b>L</b>		<b>M</b> X1 M4
	<b>4</b> X1		<b>9</b> X2		<b>1</b>		<b>N</b> X2
	<b>Domanda</b> X1		<b>10</b> X1		<b>,</b>		<b>O</b> X2
					<b>,</b>		<b>P</b> X2
					<b>,</b>		
					<b>5</b>		
					<b>,</b>		
					<b>,</b>		
					<b>IN</b>		
					<b>,</b>		
					<b>IN</b>		

PER L'INSTALLAZIONE DELLA TV

	<b>Qhmb</b>		<b>lo_M6X16 lo</b> <b>TV2yl</b>		<b>lo-M8X15  </b> <b>TV4</b>	<b>()yyyy</b>
	<b>lo-M8X50 lo</b> <b>TV8 I</b>		<b>2.5 mm-l</b> <b>Caffè TV7</b>		<b>10 millimetri</b> <b>TV8 III</b>	<b>,</b>
					<b>lo 22mm lo</b> <b>TV9 Lu</b>	<b>,</b>
					<b>Rondella con 3 fori</b> <b>TV10I</b>	<b>S</b>

## FASE DI MONTAGGIO

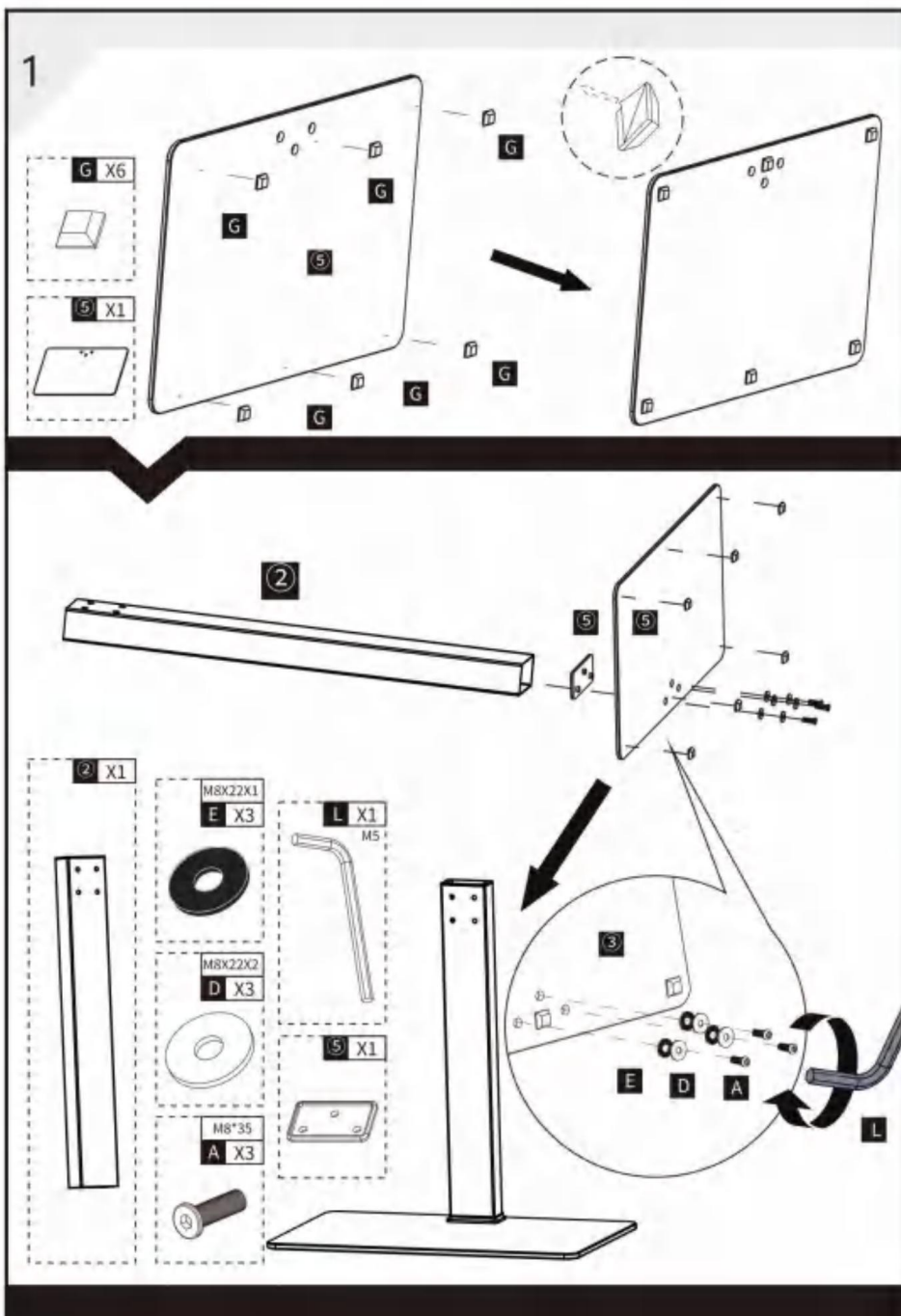

2

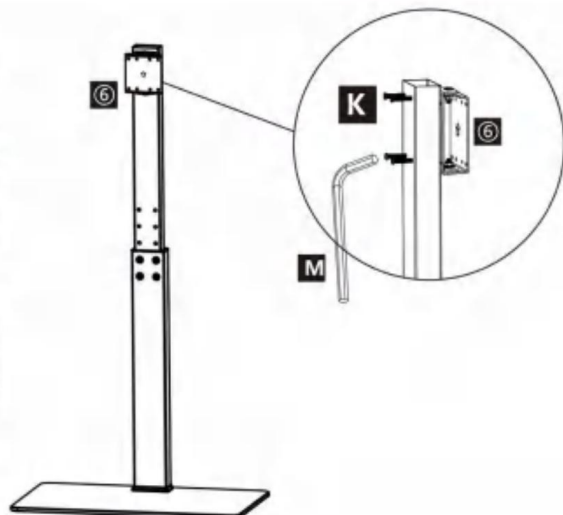
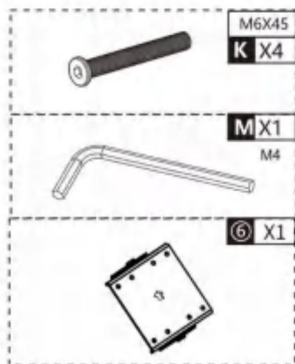
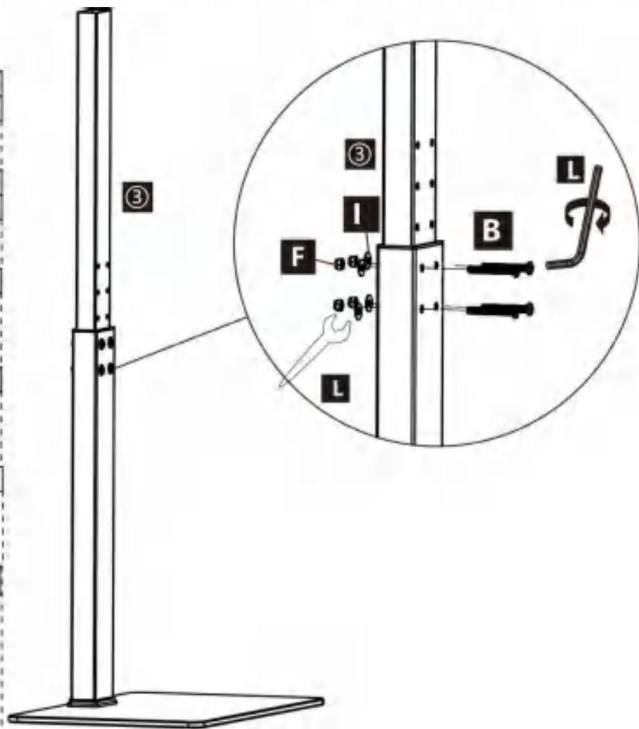
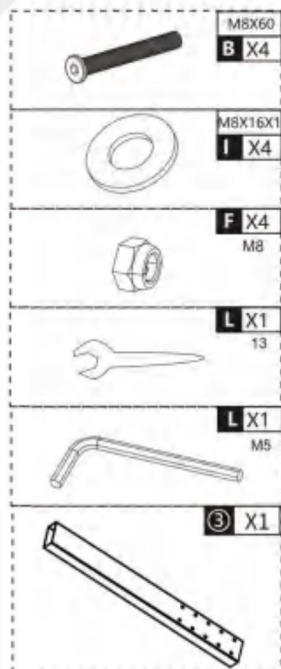



3

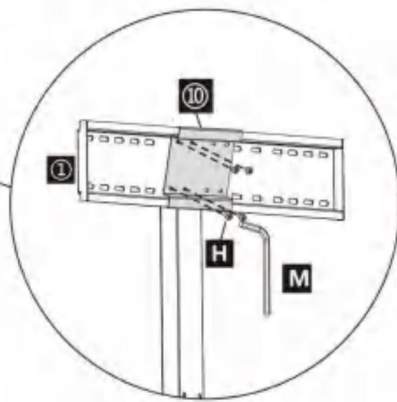
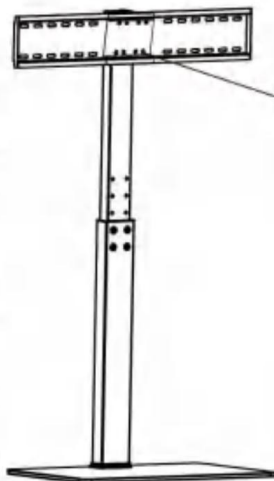
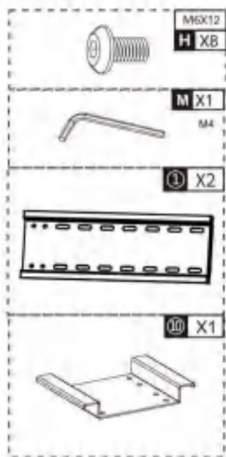

NON INCLUSO

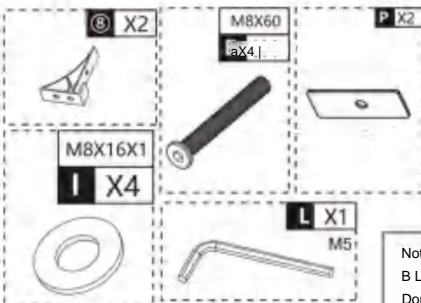

Nota: durante l'installazione del laminato,  
B La vite non si blocca completamente.  
Dopo aver installato la vite C, fissare la vite B

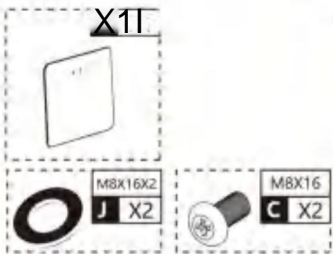
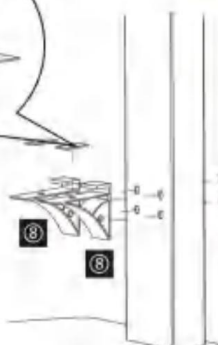
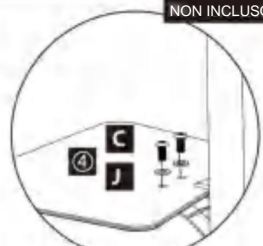

# 4

Misurare i fori di fissaggio della TV in larghezza e altezza

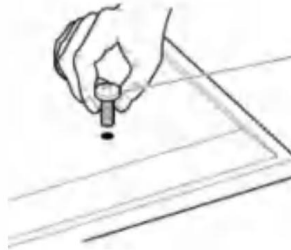
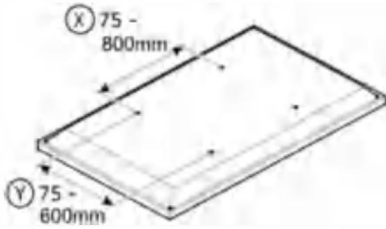

- TV1
- TV2
- TV3
- TV4

Se la larghezza (X) è maggiore di 600mm o altezza superiore a 400mm **INTERROMPI** subito l'installazione e contatta la linea di assistenza clienti

Sono fornite viti di fissaggio per TV di 4 diametri, M6 e M8. Determina il diametro della vite più adatto.



Per TV con retro irregolare/ostuito



Per TV con retro piatto/senza ostacoli

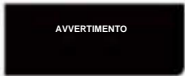

si prega di conservare per riferimento futuro.

## UN

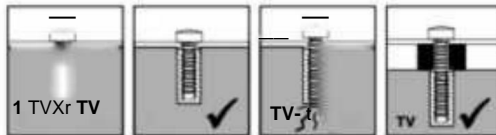

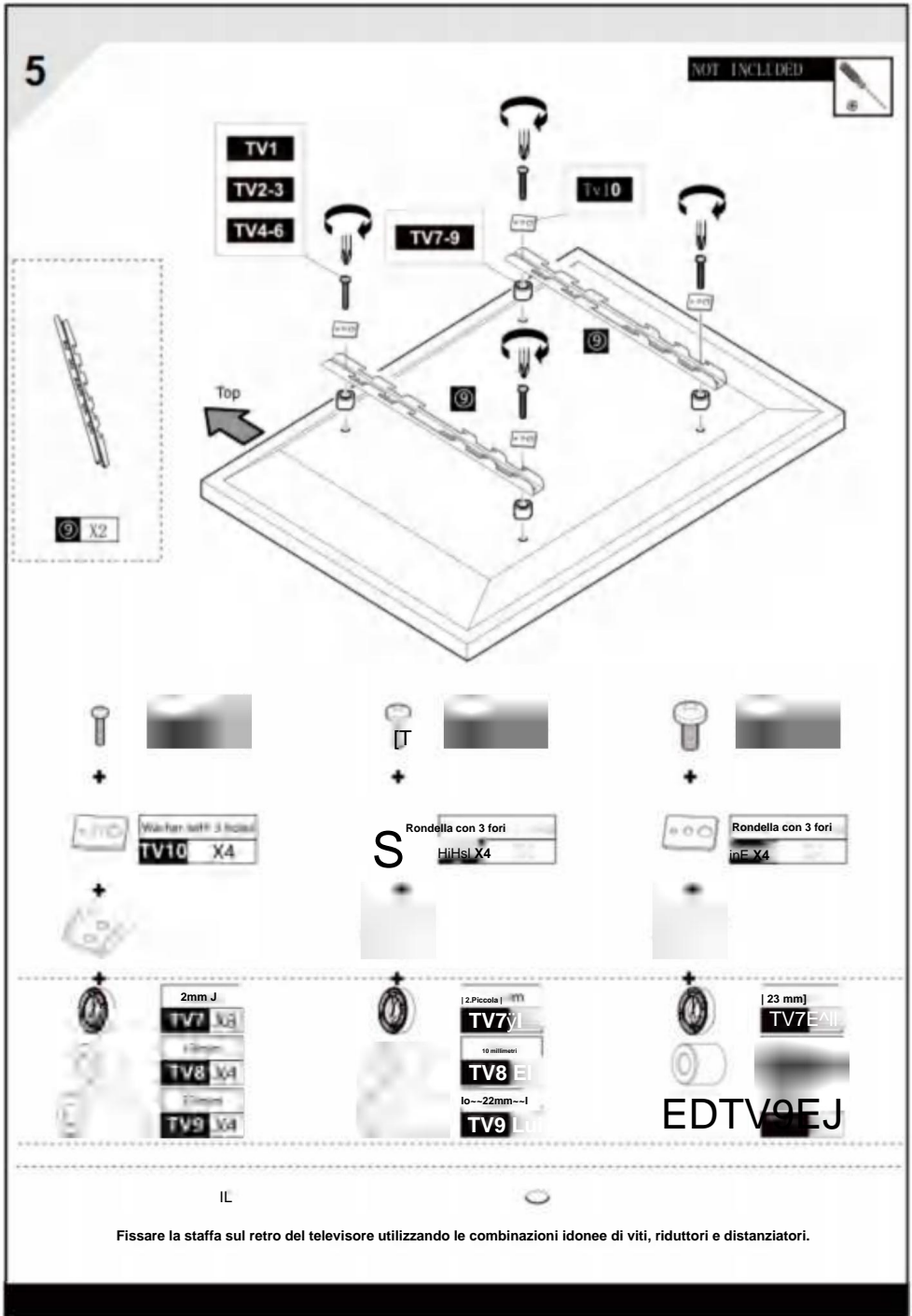

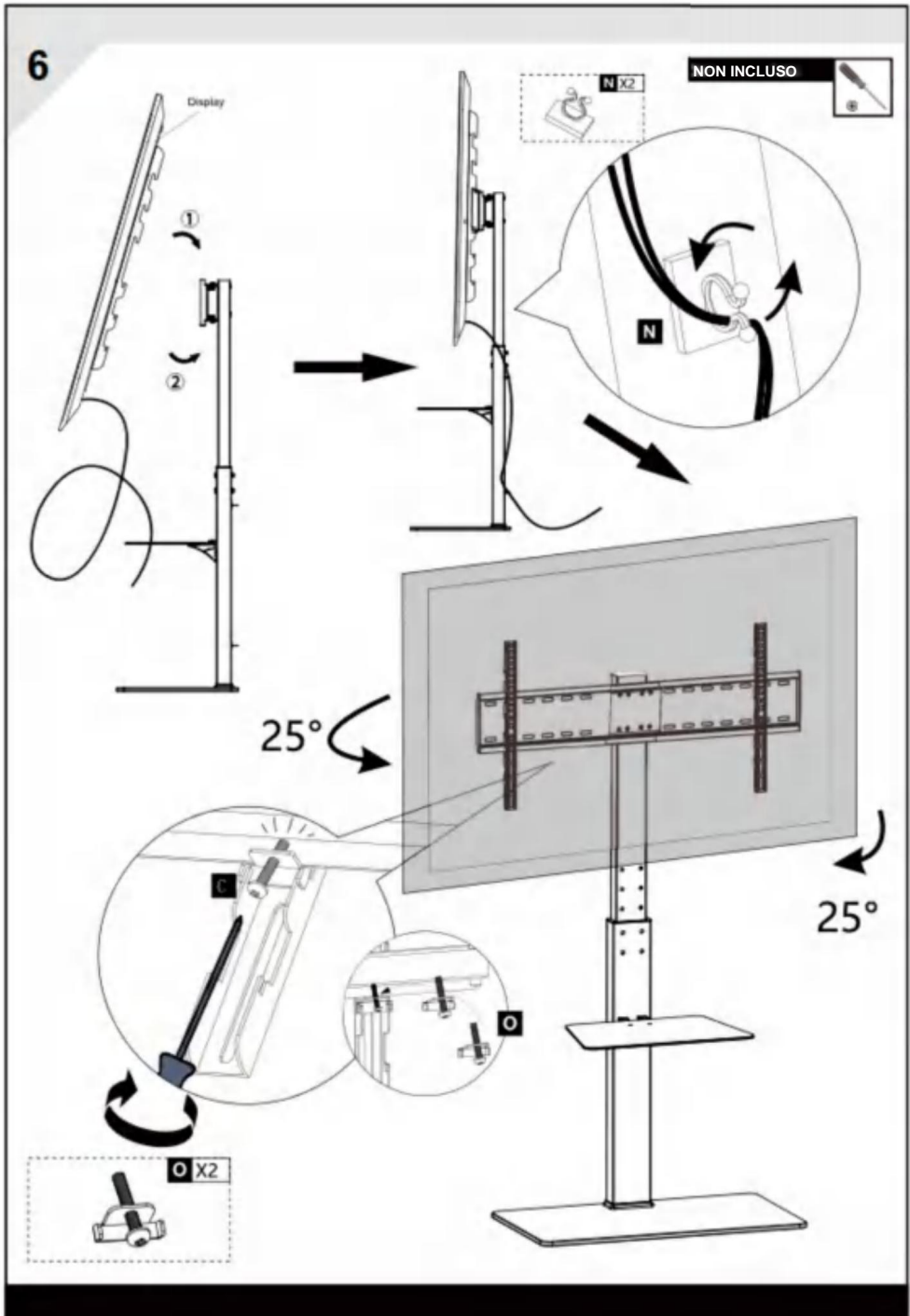

Produttore: Shanghai muxinmuyeyouxiangongsi Indirizzo:  
Shuangchenglu 803nong11 hao1602A-1609shi, baoshanqu, shanghai  
200000 CN.

Importato in AUS: SIHAO PTY LTD. 1 ROKEVA STREET EAST-WOOD  
NSW2122 Australia

Importato negli USA: Sanven Technology Ltd. Suite 250, 9166 Anaheim  
Place, Rancho Cucamonga, CA91730



E-CrossStu GmbH  
Mainzer Landstr.69, 60329 Francoforte sul Meno.



CONSULENZA YH LIMITATA.  
C/O YH Consulting Limited Ufficio 147, Centurion House, London  
Road, Staines-upon-Thames, Surrey, TW18 4AX





# VE ILR®

DIFFICILE STRUMENTI V, METÀ PREZZO

Supporto tecnico e certificato di garanzia  
elettronica [www.vevor.com/support](http://www.vevor.com/support)

---



The logo for VEVOR, consisting of the word "VEVOR" in a bold, black, sans-serif font.

HERRAMIENTAS RESISTENTES A MITAD DE PRECIO

Soporte técnico y certificado de garantía electrónica [www.vevor.com/support](http://www.vevor.com/support)

SOPORTE DE TELEVISIÓN

MANUAL DEL USUARIO

MODELO: FSH28

Seguimos comprometidos a brindarle herramientas a precios competitivos.

"Ahorre la mitad", "mitad de precio" o cualquier otra expresión similar que utilicemos solo representa una estimación del ahorro que podría obtener al comprar ciertas herramientas con nosotros en comparación con las principales marcas y no necesariamente significa que cubra todas las categorías de herramientas que ofrecemos. Le recordamos que, al realizar un pedido con nosotros, verifique cuidadosamente si realmente está ahorrando la mitad en comparación con las principales marcas.



# VEVOR®

HERRAMIENTAS RESISTENTES A MITAD DE PRECIO

SOPORTE DE TELEVISIÓN

MODELO: FSH28

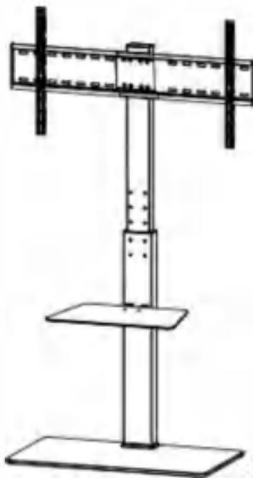

¿NECESITA AYUDA? ¡CONTÁCTENOS!

¿Tiene preguntas sobre el producto? ¿Necesita asistencia técnica? No dude en ponerse en contacto con nosotros.

Contáctenos:



[Servicio de atención al cliente@vevor.com](mailto:Servicio de atención al cliente@vevor.com)

Estas son las instrucciones originales, lea atentamente todas las instrucciones del manual antes de utilizar el producto. VEVOR se reserva una interpretación clara de nuestro manual de usuario. La apariencia del producto estará sujeta al producto que recibió. Perdónenos por no informarle nuevamente si hay actualizaciones de tecnología o software en nuestro producto.

## INSTRUCCIONES DE SEGURIDAD

### ADVERTENCIA:

Lea este material antes de utilizar este producto. No hacerlo puede provocar lesiones graves.

### Precauciones de montaje 1.

Realice el montaje únicamente de acuerdo con estas instrucciones. Un montaje inadecuado puede generar peligros.

2. Use gafas de seguridad aprobadas por ANSI y guantes de trabajo resistentes durante el montaje.
3. Mantenga el área de reunión limpia y bien iluminada.
4. Mantenga a los transeúntes fuera del área durante el montaje.
5. No se reúna cuando esté cansado o bajo la influencia del alcohol, drogas o medicamentos.
6. La capacidad de peso y otras capacidades del producto se aplican únicamente a productos ensamblados de forma correcta y completa.
7. Monte sobre una superficie plana, nivelada, dura y lisa capaz de soportar de forma segura un soporte de televisión completamente cargado.

Tome precauciones

### PARA EVITAR LESIONES GRAVES Y LA MUERTE POR VUELCO:

1. NO SE SIENTA, SE PARE NI SE SUBA SOBRE ESTE ARTÍCULO.
2. Este producto no es un juguete. No permita que los niños jueguen con este artículo ni cerca de él.
3. No exceda el peso nominal indicado. ¡Pueden producirse lesiones graves o daños a la propiedad!.
4. Úselo únicamente sobre una superficie plana, nivelada, dura y lisa capaz de soportar de forma segura un soporte de televisión completamente cargado.
5. No levante mientras esté cargado.
6. Utilícelo únicamente según lo previsto.
7. Inspeccione antes de cada uso; no utilice si las piezas están sueltas o dañadas.

GUARDE ESTE MANUAL

### PARÁMETRO DEL PRODUCTO

Modelo	FSH28
Soportando peso	Total: 132 libras máximo Soporte de TV: HOlbsMAX Bandeja: 22 libras MÁXIMO
Dimensión de montaje	100x100,100x200,100x400 200x200,200x300,200x400 300x300,300x400 400x400,400x600 600x600,600x800
Tamaño de pantalla	85' Máximo
Tamaño del producto	841*397*1400 milímetros
Peso neto	17,05 kilos
Peso bruto	18,15 kilos

LISTA DE PIEZAS

	<b>1</b> X2		<b>6</b> X1		R		Arandela de plástico
	<b>2</b> X1		<b>7</b> X1		R		Arandela de acero
	<b>3</b> X1		X2		R		<b>13</b> X1
	<b>4</b> X1		<b>9</b> X2		R1		<b>M4</b> X1
	Pregunta X1f		<b>10</b> X1		,		<b>M4</b> X2
					,		<b>M4</b> X2
					,		<b>M4</b> X2
					5		<b>M4</b> X2
					,		<b>M4</b> X2
					,		<b>M4</b> X2
					EN		<b>M4</b> X2
					,		<b>M4</b> X2
					EN		<b>M4</b> X2

**PARA INSTALACIÓN DE TV**

<b>TV6</b>	<b>TV2I</b>	<b>TV3 la</b>	<b>TV4</b>	<b>TV5  </b>
<b>TV6</b>	<b>café tv7</b>	<b>TV8 EII</b>	<b>TV9 ÉI</b>	<b>TV10I</b>

## PASO DE MONTAJE

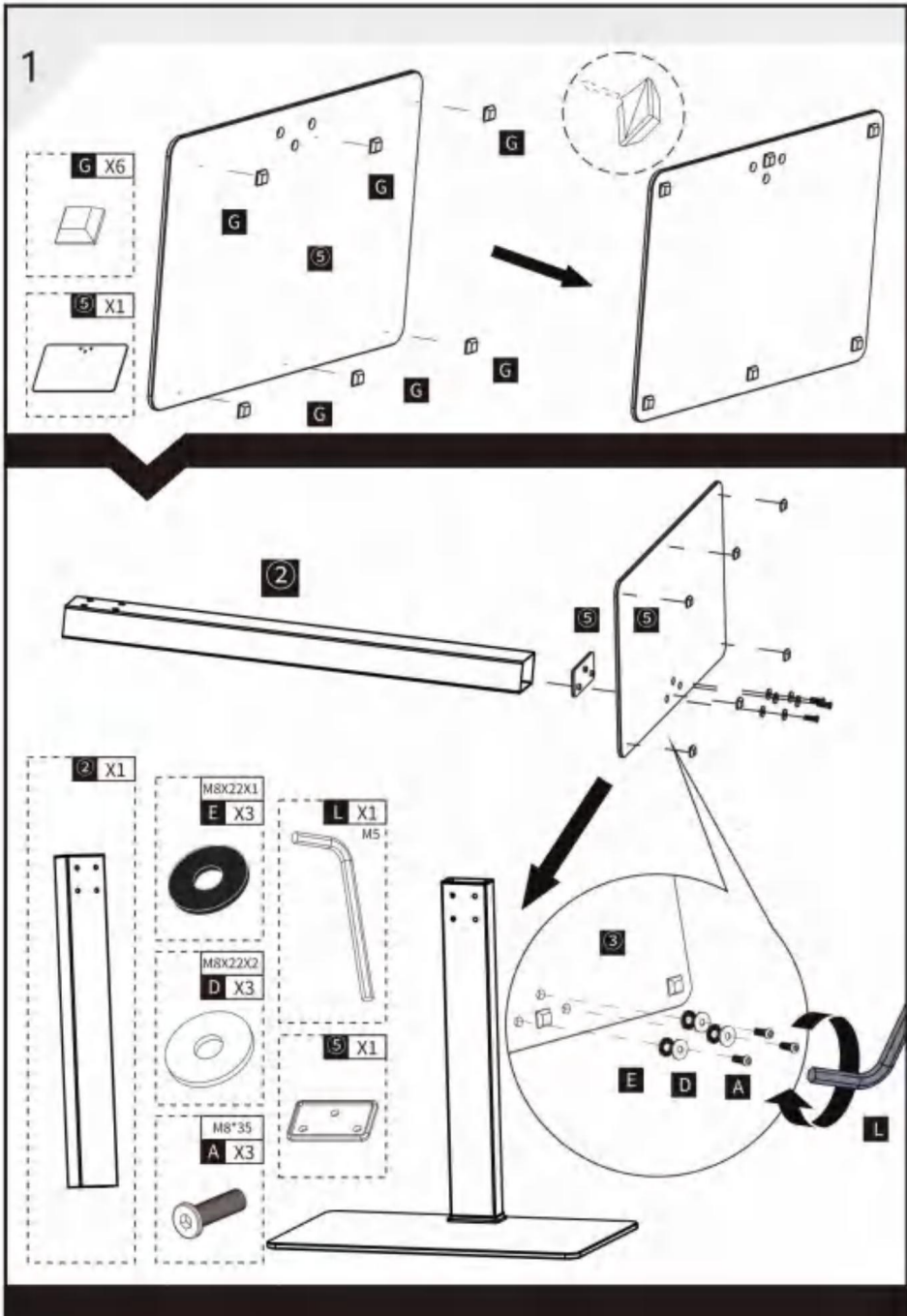

2

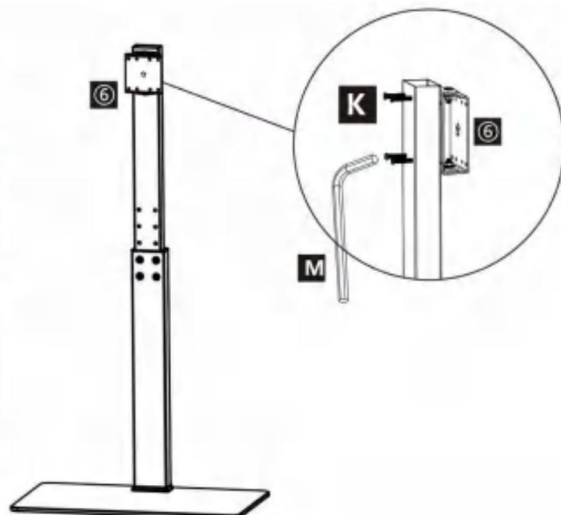
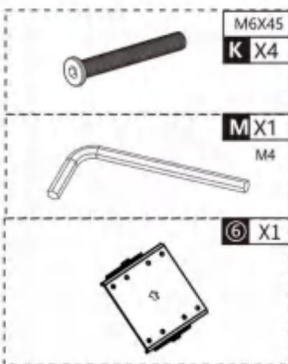
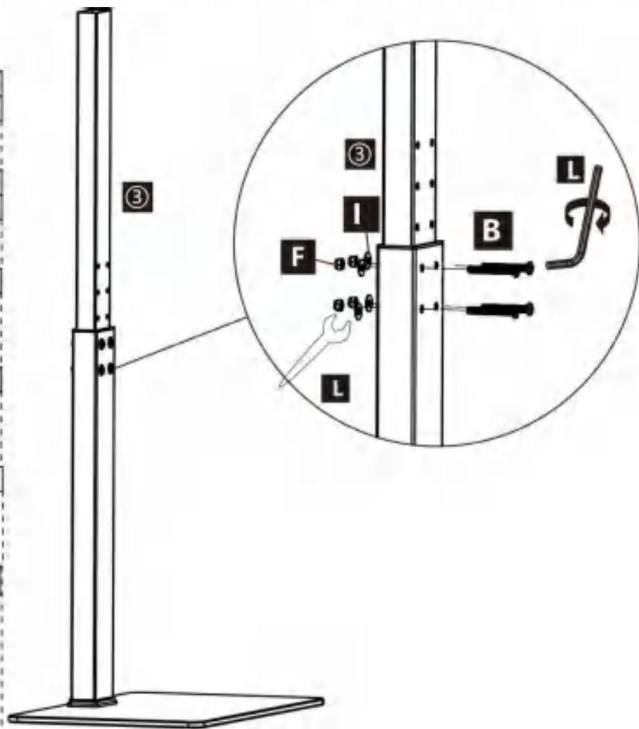
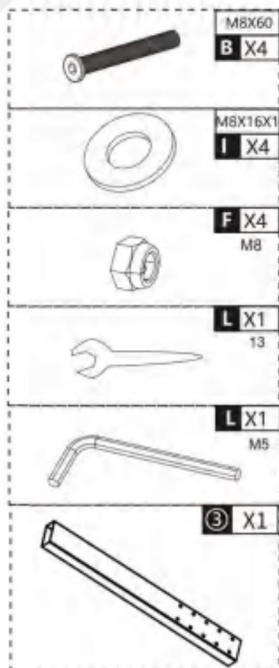



3

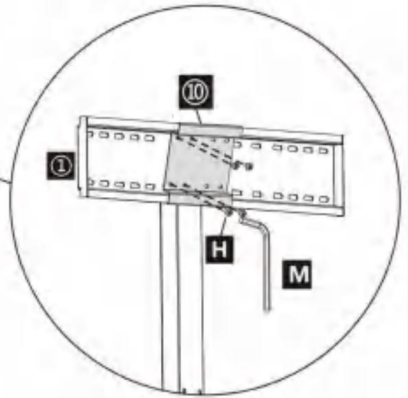
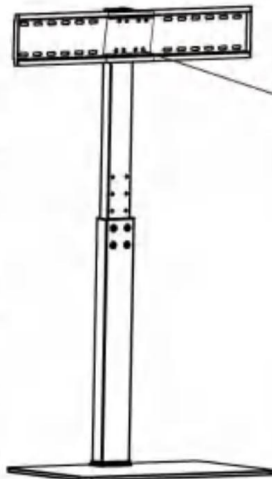
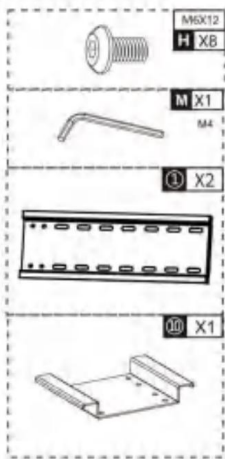

NO INCLUIDO

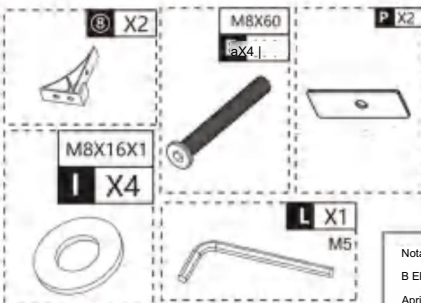

Nota: Durante la instalación del laminado,  
B El tornillo no queda completamente bloqueado.  
Apriete el tornillo B después de instalar el tornillo C

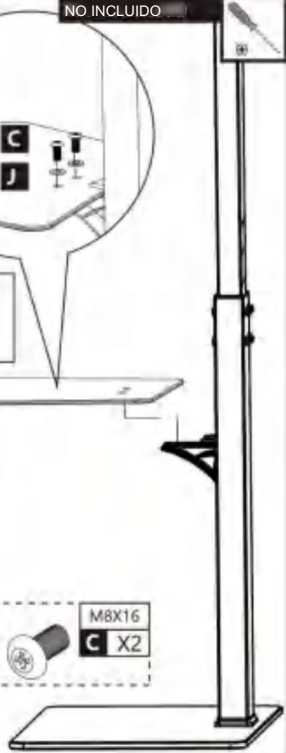
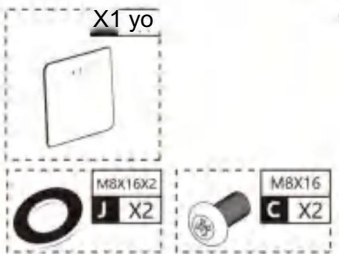
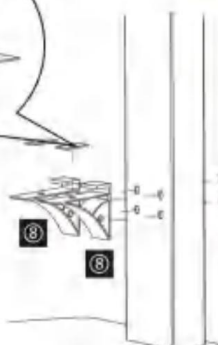

# 4

Mida el ancho y la altura de los orificios de fijación del televisor

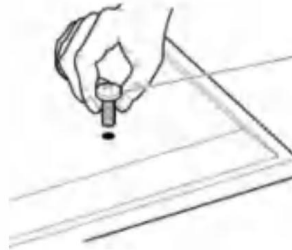
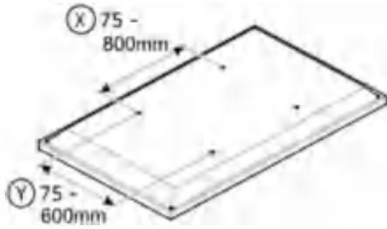

- TV1
- TV2
- TV3
- TV4

Si el ancho(X) es mayor tAhan 600 mm o altura@ mayor a 400 mm DETENGA la instalación ahora y comuníquese con la línea de ayuda al cliente

Se proporcionan 4 diámetros de tornillos para la fijación del televisor, M6 y M8. Determine el diámetro del tornillo que se adapta.



Para televisores con parte posterior irregular/obstruida

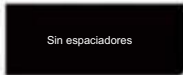
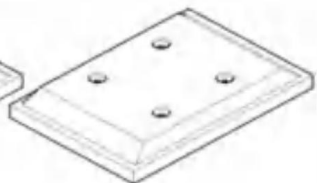
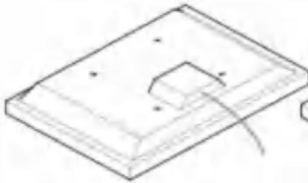

Para televisores con parte posterior plana/sin obstrucciones

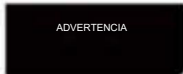

Por favor, consérvelo para futuras referencias.

# A



1 televisor TVXr



Televisión en

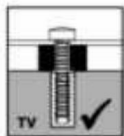

TV

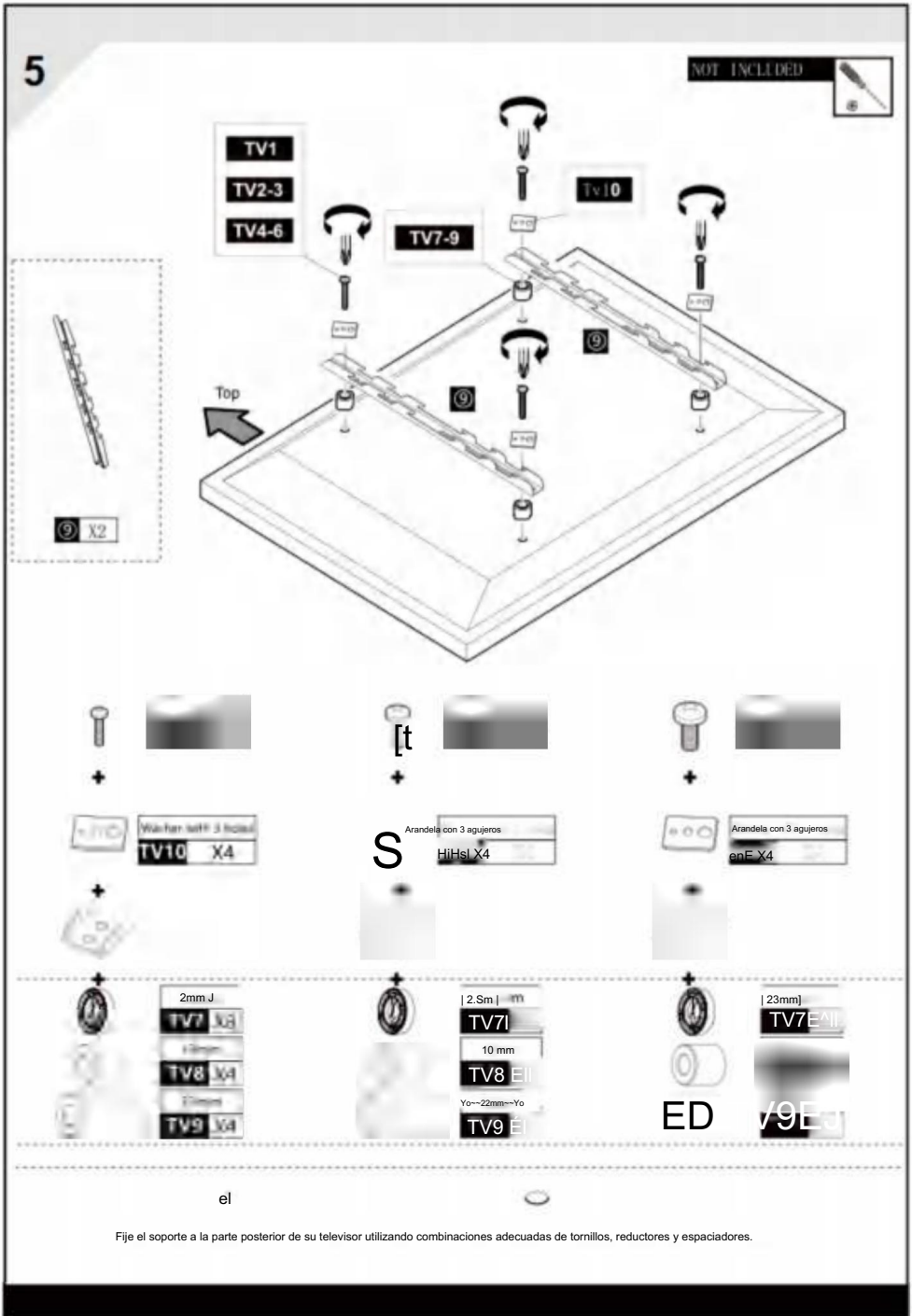

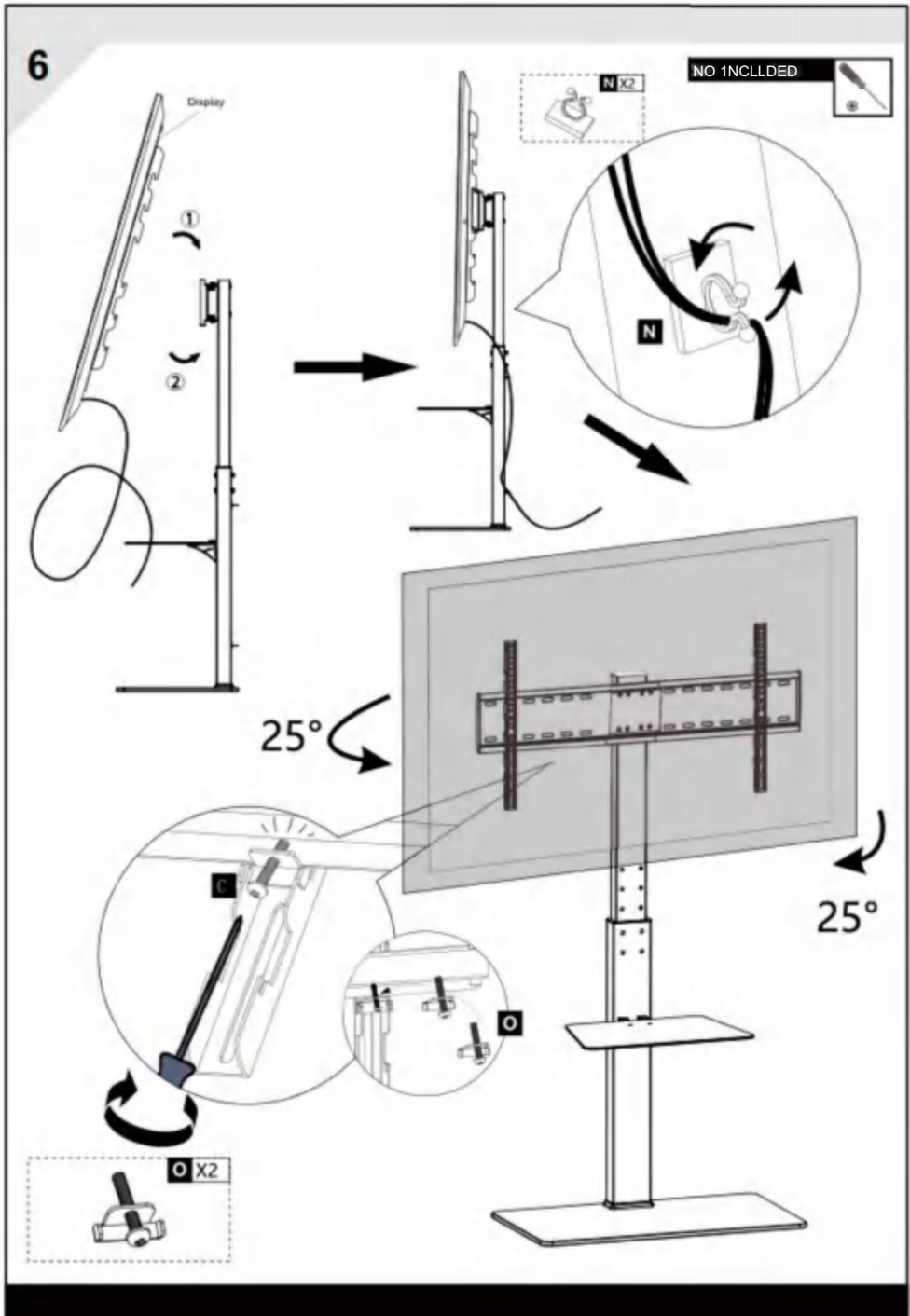

Fabricante: Shanghaimuxinmuyeyouxiangongsi Dirección:  
Shuangchenglu 803nong11 hao1602A-1609shi, baoshanqu, shanghai  
200000 CN.

Importado a AUS: SIHAO PTY LTD. 1 ROKEVA STREETEAST-WOOD  
NSW2122 Australia

Importado a EE. UU.: Sanven Technology Ltd. Suite 250, 9166 Anaheim  
Place, Rancho Cucamonga, CA 91730



E-CrossStu GmbH  
Mainzer Landstr.69, 60329 Fráncfort del Meno.



YH CONSULTING LIMITADA.  
C/O YH Consulting Limited Oficina 147, Centurion House, London  
Road, Staines-upon-Thames, Surrey, TW18 4AX





V Y ELR<sup>®</sup>  
DIFÍCIL HERRAMIENTAS V, MITAD PRECIO

Soporte técnico y certificado de garantía electrónica

[www.vevor.com/support](http://www.vevor.com/support)



# VEVOR

WYTRZYMAŁE NARZĘDZIA, POŁOWA CENY

Wsparcie techniczne i certyfikat gwarancji elektronicznej [www.vevor.com/support](http://www.vevor.com/support)

## PODSTAWKA POD TELEWIZOR

### INSTRUKCJA OBSŁUGI

#### MODELFSH28

Nadal staramy się oferować Państwu narzędzia w konkurencyjnych cenach. „Oszczędź połowę”, „Połowa ceny” lub inne podobne wyrażenia używane przez nas stanowią jedynie szacunkowe oszczędności, jakie możesz uzyskać kupując u nas określone narzędzia w porównaniu z głównymi markami i niekoniecznie oznaczają one objęcie wszystkich kategorii narzędzi oferowanych przez nas. Uprzejmie przypominamy, aby dokładnie sprawdzić, czy składając u nas zamówienie faktycznie oszczędzasz połowę w porównaniu z najlepszymi markami.



# VEVOR®

PODSTAWKA POD TELEWIZOR

WYTRZYMAŁE NARZĘDZIA, POŁOWA CENY

MODEL: FSH28

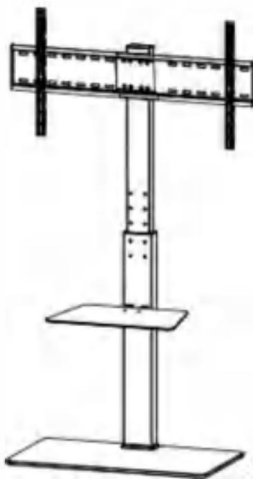

POTRZEBUJESZ POMOCY? SKONTAKTUJ SIĘ Z NAMI!

Masz pytania dotyczące produktu? Potrzebujesz wsparcia technicznego? Nie wahaj się

Skontaktuj się z nami:



[Obsługa Klienta@vevor.com](mailto:Obsługa.Klienta@vevor.com)

To jest oryginalna instrukcja, przed użyciem należy uważnie przeczytać wszystkie instrukcje. VEVOR zastrzega sobie jasną interpretację naszej instrukcji obsługi. Wygląd produktu będzie zależał od produktu, który otrzymałeś. Prosimy o wybaczenie, że nie poinformujemy Cię ponownie, jeśli w naszym produkcie pojawią się jakiegokolwiek aktualizacje technologiczne lub oprogramowania.

## INSTRUKCJE BEZPIECZEŃSTWA

### OSTRZEŻENIE:

Przeczytaj ten materiał przed użyciem tego produktu. Nieprzestrzeganie tego może spowodować poważne obrażenia.

#### Środki ostrożności podczas montażu

1. Montaż należy wykonywać wyłącznie zgodnie z niniejszą instrukcją. Nieprawidłowy montaż może stwarzać zagrożenia.
2. Podczas montażu należy nosić okulary ochronne z atestem ANSI oraz wytrzymałe rękawice robocze.
3. Utrzymuj miejsce zgromadzenia w czystości i zapewnij dobre oświetlenie.
4. Podczas montażu nie dopuszczaj osób postronnych na teren montażu.
5. Nie przychodź na spotkania, jeśli jesteś zmęczony lub pod wpływem alkoholu, narkotyków lub leków.
6. Podane parametry dotyczące nośności i innych parametrów produktu odnoszą się wyłącznie do produktu prawidłowo i kompletnie zmontowanego.
7. Zmontuj na płaskiej, równej, twardej i gładkiej powierzchni, która może bezpiecznie utrzymać w pełni załadowany stojak pod telewizor.

#### Stosuj środki ostrożności

#### ABY ZAPOBIEC POWAŻNYM OBRAŻENIOM I ŚMIERCI SPOWODOWANEJ PRZEWRÓCENIEM:

































































1. NIE SIADAJ, NIE STÓJ ANI NIE WSPINAJ SIĘ NA TYM PRZEDMIOCIE.
2. Ten produkt nie jest zabawką. Nie pozwalaj dzieciom bawić się tym przedmiotem ani przebywać w jego pobliżu.
3. Nie przekraczać dopuszczalnej masy całkowitej. Może to spowodować poważne obrażenia ciała lub uszkodzenie mienia!
4. Używać wyłącznie na płaskiej, równej, twardej i gładkiej powierzchni, która może bezpiecznie utrzymać w pełni załadowany stojak pod telewizor.
5. Nie podnoś, gdy jesteś obciążony.
6. Używać wyłącznie zgodnie z przeznaczeniem.
7. Przed każdym użyciem należy przeprowadzić kontrolę. Nie należy używać produktu, jeśli jakieś części są luźne lub uszkodzone.

#### ZAPISZ TĘ INSTRUKCJĘ

## PARAMETR PRODUKTU

Model	FSH28
Nośność	łącznie: 132 funty maks. Uchwyt TV: HOIbsMAX Taca: maks. 22 funty
Wymiary montażowe	100x100,100x200,100x400 200x200,200x300,200x400 300x300,300x400 400x400,400x600 600x600,600x800
Rozmiar ekranu	Maksymalnie 85"
Rozmiar produktu	841*397*1400 mm
Masa netto	17,05 kg
Masa brutto	18,15 kg









LISTA CZĘŚCI

 1 X2	 6 X1											
 2 X1	 7 X1											
 3 X1	 8 X2											
 4 X1	 9 X2											
 Pytanie X1 f	 10 X1											

Podkładka plastikowa  
Podkładka stalowa

R  
R  
R  
R  
R1  
,  
,  
,  
5  
,  
,  
W  
,  
W

**DO INSTALACJI TV**

 Ja - M6X16 Ja TV2 i 1	 Ja - M6X35 TV3 la	 Ja - M8X15 TV4	 Ja - M8X35 Ja TV5
 Ja - M8X50 Ja TV7	 2,5 mm-1 Kawa TV7	 10mm TV8 The	 Ja 22mm Ja TV9 On
 Podkładka z 3 otworami TV10I			

,  
(  
-  
,  
,  
S

## KROK MONTÁŽU

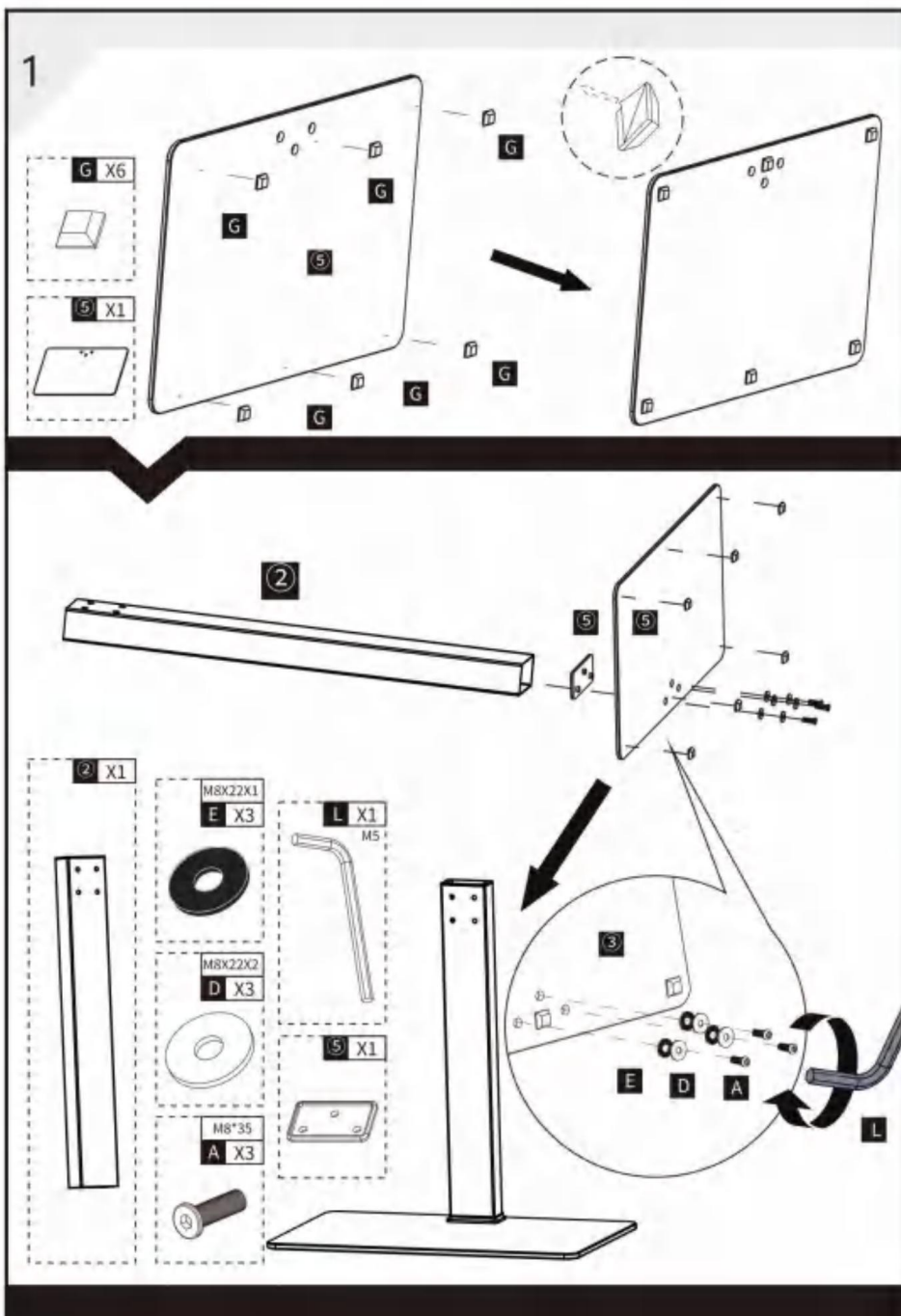

2

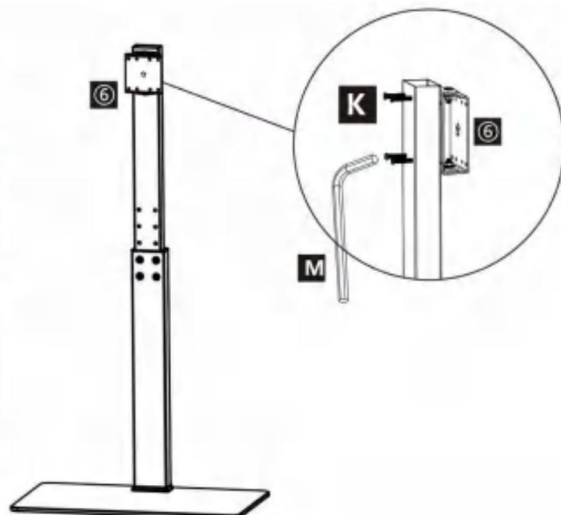
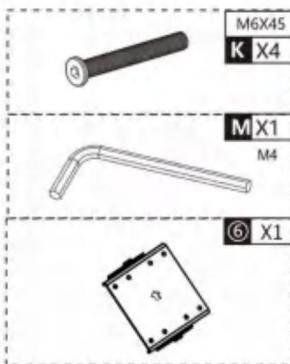
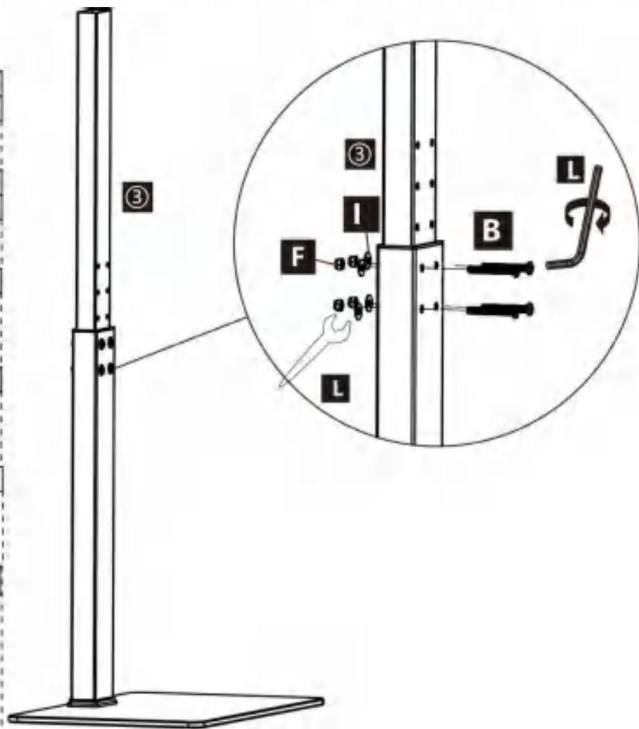
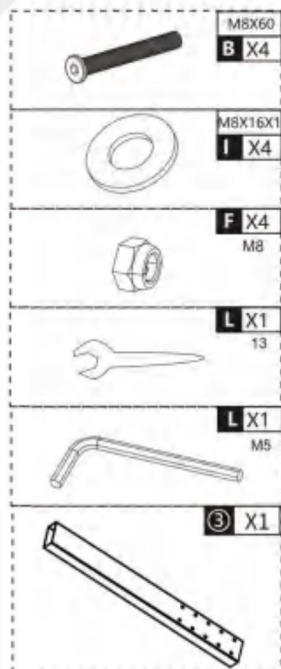



3

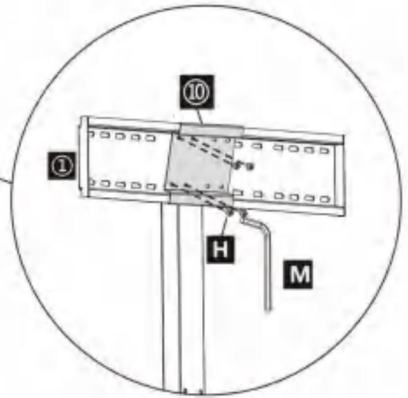
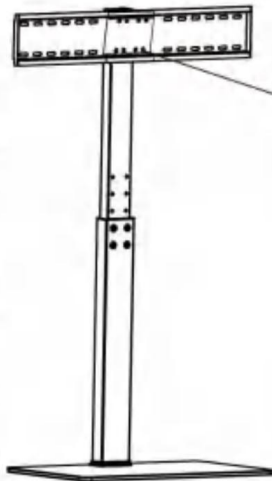
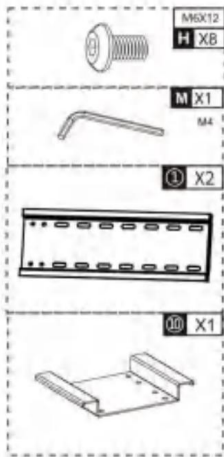

NIE ZAWIERA

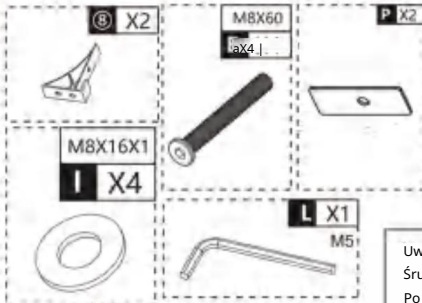

Uwaga: Podczas montażu laminatu,  
Śruba B nie blokuje się całkowicie,  
Po zamontowaniu śruby C przykręć śrubę B

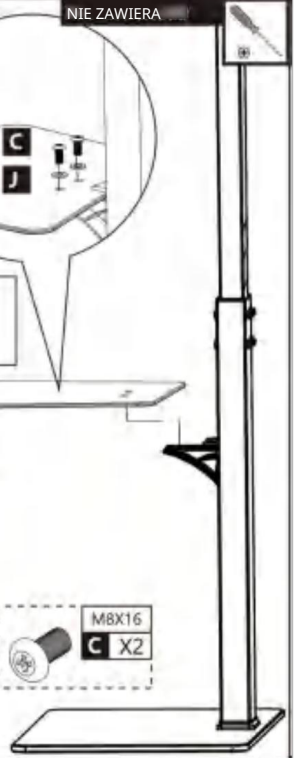
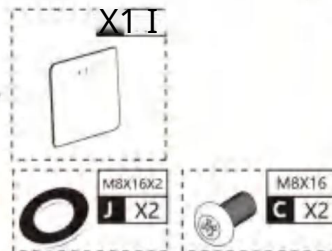
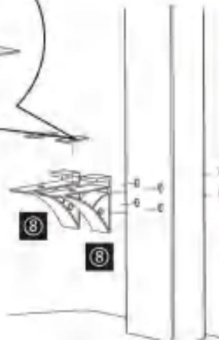
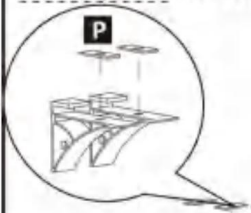

# 4

Zmierz szerokość i wysokość otworów mocujących telewizor

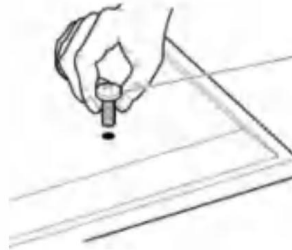
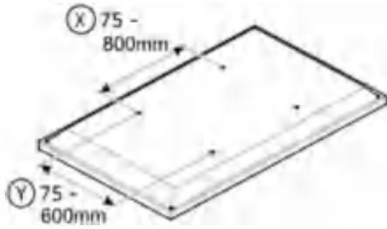

- TV1
- TV2
- TV3
- TV4

Jeśli szerokość (X) jest większa niż 600mm lub wysokość (Y) powyżej 400 mm ZATRZYMAJ instalację teraz i skontaktuj się z infolinią klienta

Dostarczono Ci 4 średnice śrub mocujących telewizor: M6 i M8. Określ średnicę śruby, która pasuje.



Do telewizorów z nieregularnym/przesłoniętym tyłem

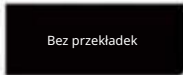
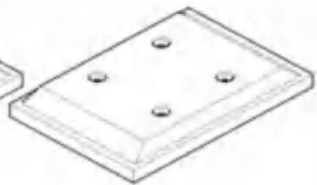
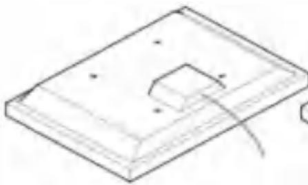

Do telewizorów z płaskim/niezasłoniętym tyłem

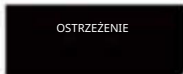

Proszę zachować do wykorzystania w przyszłości.

# A

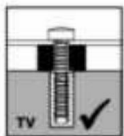

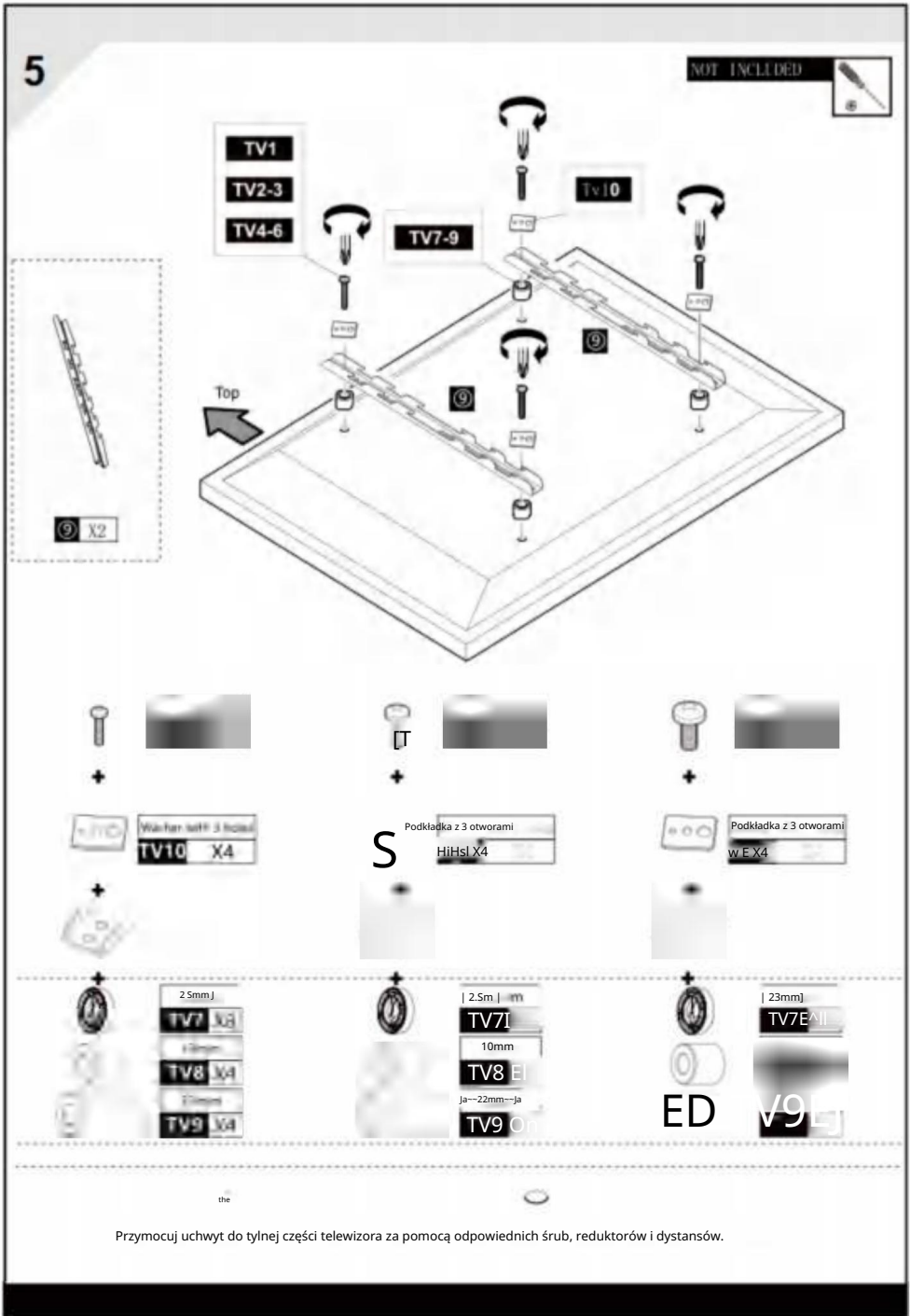

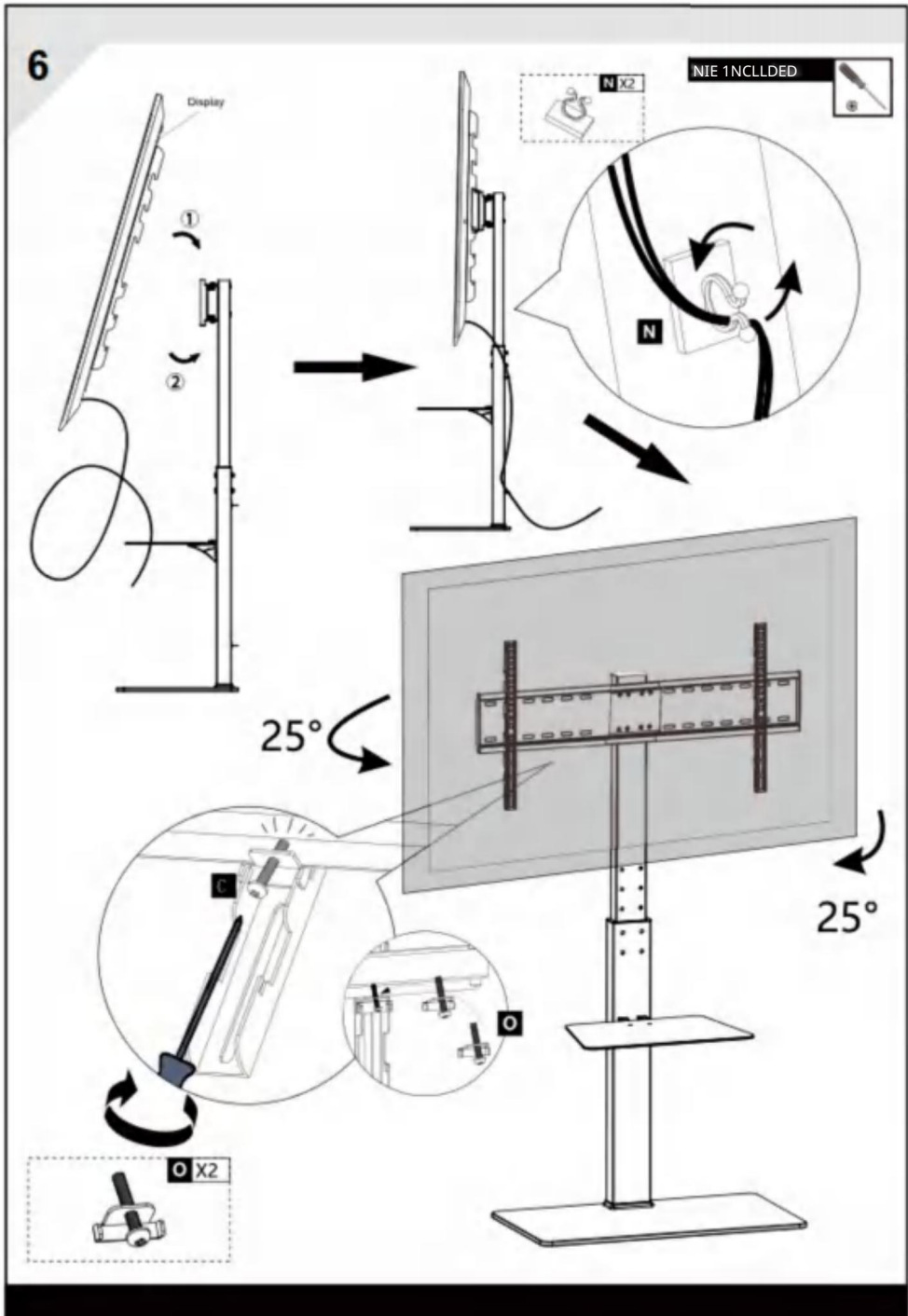

Producent: Shanghai muxinmuyeyouxiangongsi Adres:

Shuangchenglu 803nong11 hao1602A-1609shi, baoshanqu, szanghaj  
200000 CN.

Importowane do AUS: SIHAO PTY LTD. 1 ROKEVA STREETEAST-WOOD NSW2122  
Australia

Importowane do USA: Sanven Technology Ltd. Suite 250, 9166 Anaheim  
Place, Rancho Cucamonga, CA91730



E-CrossStu GmbH  
Mainzer Landstr.69, 60329 Frankfurt nad Menem.



YH CONSULTING LIMITED.  
C/O YH Consulting Limited Biuro 147, Centurion House, London  
Road, Staines-upon-Thames, Surrey, TW18 4AX





V I TO R<sup>®</sup>

TRUDNY NARZĘDZIA V, POŁOWA CENA

Wsparcie techniczne i certyfikat gwarancji  
elektronicznej [www.vevor.com/support](http://www.vevor.com/support)



# VEVOR



**ROBUUSTE GEREEDSCHAPPEN, HALVE PRIJS**

Technische ondersteuning en e-garantiecertificaat [www.vevor.com/support](http://www.vevor.com/support)

## **TELEVISIE STANDAARD**

### **GEBRUIKERSHANDLEIDING**

**MODEL: FSH28**

Wij streven er voortdurend naar om u gereedschappen tegen concurrerende prijzen te leveren. "Bespaar de helft", "halve prijs" of andere soortgelijke uitdrukkingen die wij gebruiken, geven slechts een schatting van de besparingen die u kunt behalen door bepaalde gereedschappen bij ons te kopen in vergelijking met de grote topmerken en doseringen betekenen niet noodzakelijkerwijs dat ze alle categorieën gereedschappen dekken die wij aanbieden. Wij herinneren u eraan om zorgvuldig te controleren of u daadwerkelijk de helft bespaart in vergelijking met de grote topmerken wanneer u een bestelling bij ons plaatst.



# VEVOR®

TELEVISIE STANDAARD

ROBUUSTE GEREEDSCHAPPEN, HALVE PRIJS

MODEL: FSH28

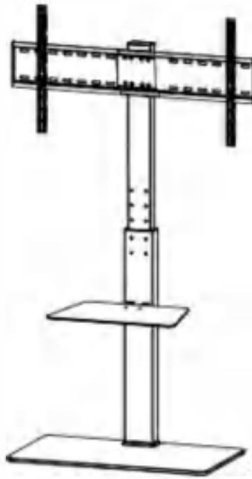

## HULP NODIG? NEEM CONTACT MET ONS OP!

Heeft u vragen over het product? Heeft u technische ondersteuning nodig? Neem dan gerust contact met ons op.

Neem contact met ons op:



[Klantenservice@vevor.com](mailto:Klantenservice@vevor.com)

Dit is de originele instructie, lees alle handleidingen zorgvuldig door voordat u het product gebruikt. VEVOR behoudt zich een duidelijke interpretatie van onze gebruikershandleiding voor. Het uiterlijk van het product is afhankelijk van het product dat u hebt ontvangen. Vergeef ons dat we u niet opnieuw zullen informeren als er technologie- of software-updates voor ons product zijn.

## VEILIGHEIDSINSTRUCTIES

### WAARSCHUWING:

**Lees dit materiaal voordat u dit product gebruikt. Als u dit niet doet, kan dit leiden tot ernstig letsel.**

### Voorzorgsmaatregelen bij

**montage** 1. Monteer alleen volgens deze instructies. Onjuiste montage kan gevaren opleveren.

2. Draag tijdens de montage een ANSI-goedgekeurde veiligheidsbril en stevige werkhandschoenen.

3. Zorg ervoor dat de montageplek schoon en goed verlicht is.

4. Houd omstanders uit de buurt tijdens de montage.

5. Kom niet bijeen als u moe bent of onder invloed van alcohol, drugs of medicijnen.

6. Het draagvermogen en andere producteigenschappen gelden alleen voor een correct en volledig gemonteerd product.

7. Monteer de set op een vlak, egaal, hard en glad oppervlak dat een volledig beladen tv-standaard veilig kan dragen.

### Neem voorzorgsmaatregelen

### OM ERNSTIG LETSEL EN DE DOOD DOOR KANTELEN TE VOORKOMEN:

**1. NIET OP DIT ITEM ZITTEN, STAAN OF KLIMMEN.**

2. Dit product is geen speelgoed. Laat kinderen niet met of in de buurt van dit item spelen.

3. Overschrijd het aangegeven gewicht niet. Dit kan ernstig letsel of materiële schade tot gevolg hebben!

4. Gebruik het apparaat alleen op een vlak, egaal, hard en glad oppervlak dat een volledig beladen tv-standaard veilig kan dragen.

5. Til niet terwijl het geladen is.

6. Gebruik het product alleen zoals bedoeld.

7. Controleer het apparaat voor elk gebruik. Gebruik het apparaat niet als er onderdelen loszitten of beschadigd zijn.

### BEWAAR DEZE HANDLEIDING

## PRODUCTPARAMETER

Model	FSH28
Draaggewicht	<b>Totaal: 132 lbs Max</b> TV-beugel: HOlbsMAX Schaal: 22 lbs MAX
Montage-afmeting	100x100,100x200,100x400 200x200,200x300,200x400 300x300,300x400 400x400,400x600 600x600,600x800
Schermgrootte	85" Maximaal
Productgrootte	841*397*1400mm
Netto gewicht	17,05kg
Brutogewicht	18,15 kg

ONDERDELENLIJST

	<b>1</b> X2		<b>6</b> X1		R		Kunststof ring
	<b>2</b> X1		<b>7</b> X1		R		Stalen ring
	<b>3</b> X1		<b>8</b> X2j		R		<b>L</b> X1 13
	<b>4</b> X1		<b>9</b> X2		R1		<b>M</b> X1 M4
	Vraag X1 f		<b>10</b> X1		,		<b>N</b> X2
					,		<b>O</b> X2
					,		<b>P</b> X2
					,		
					5		
					,		
					,		
					IN		
					,		
					IN		

**VOOR TV-INSTALLATIE**

					,		( )yyyy
					,		
					S		

## MONTAGESTAP

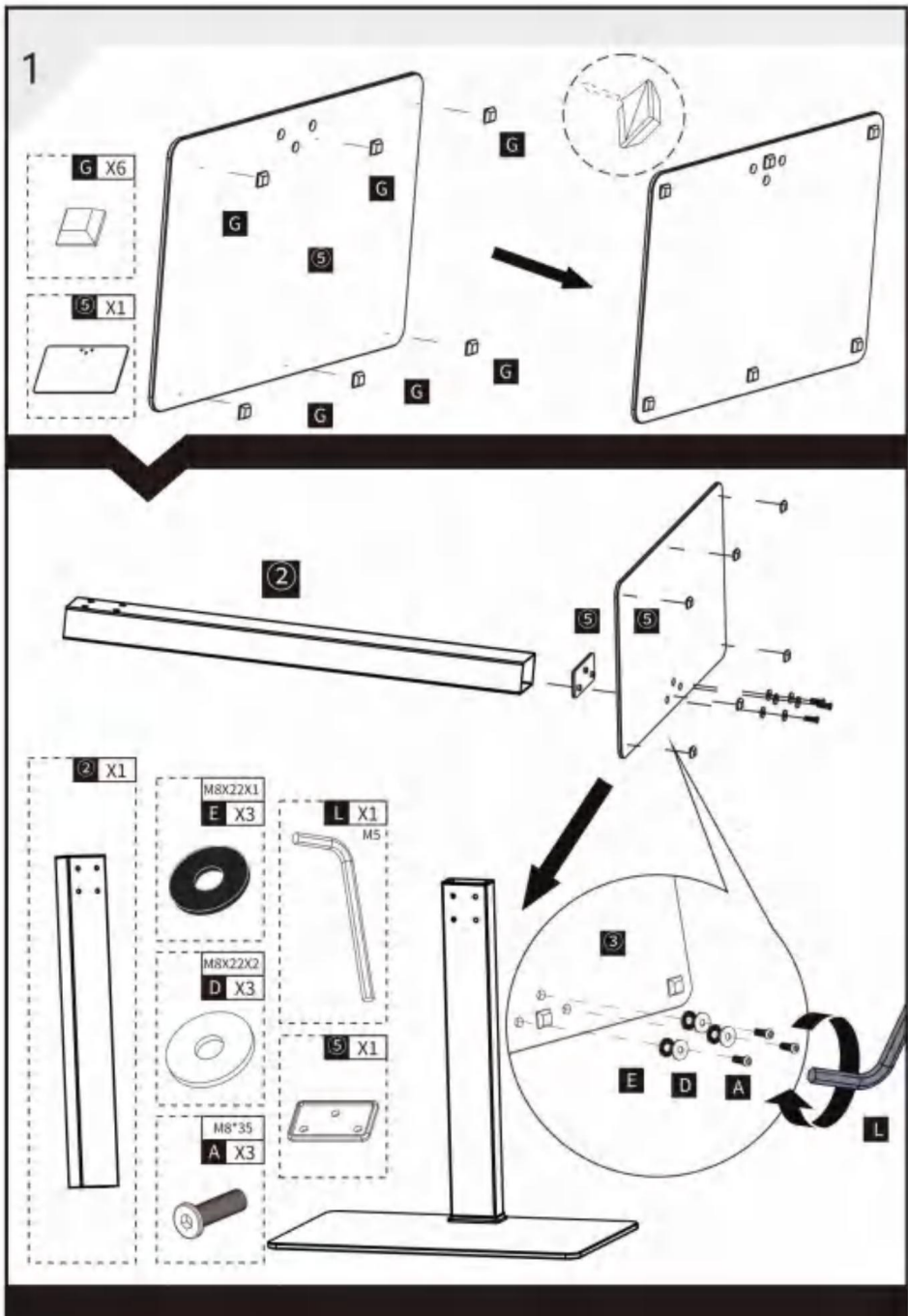

2

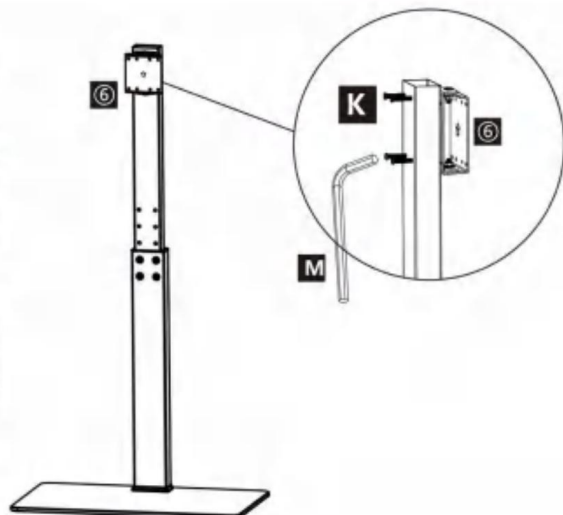
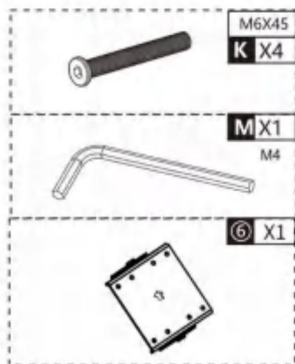
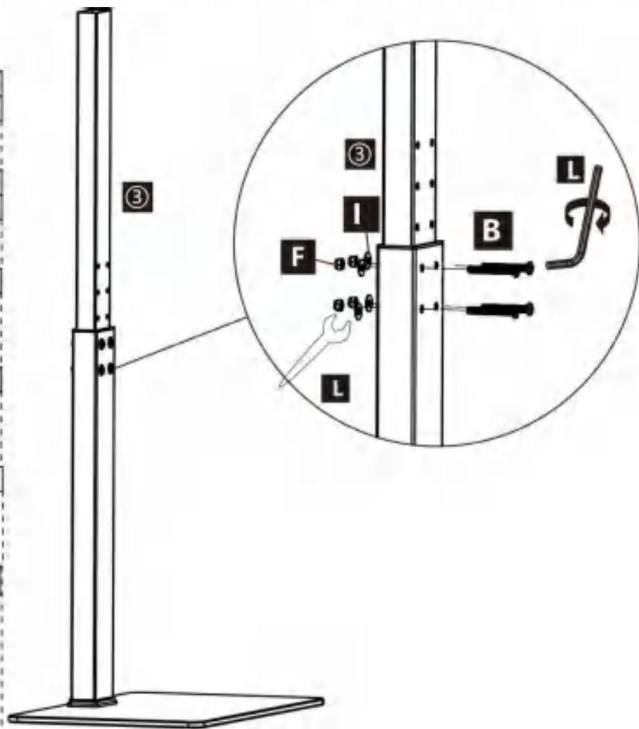
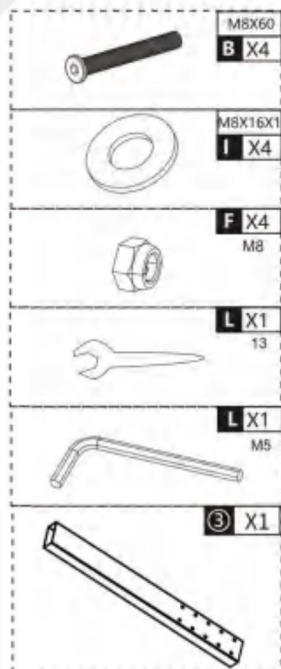



3

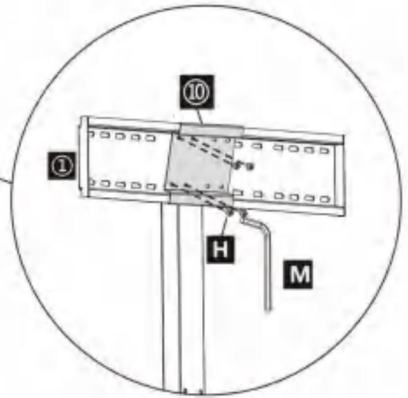
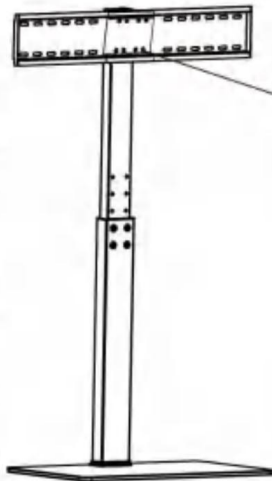
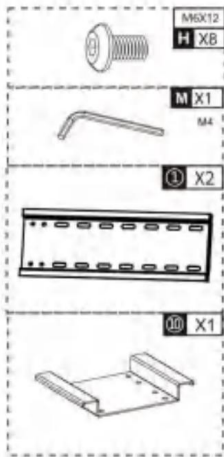

NIET INBEGREPEN

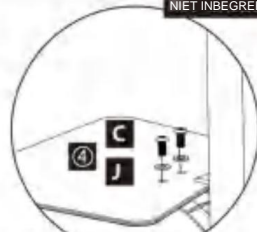
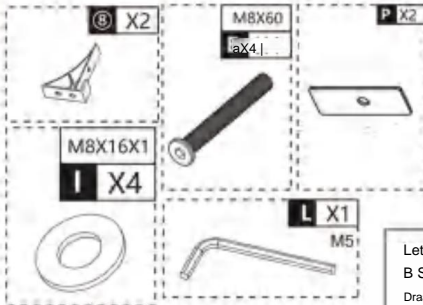

Let op: Tijdens het leggen van laminaat,  
B Schroef niet volledig vast,  
Draai schroef B vast nadat u schroef C hebt geïnstalleerd

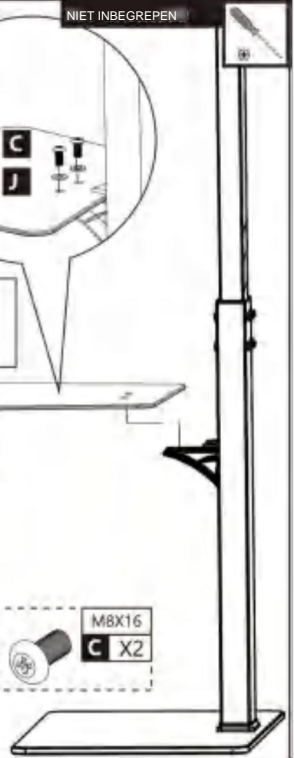
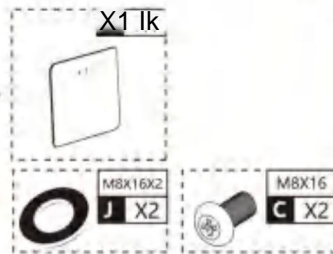
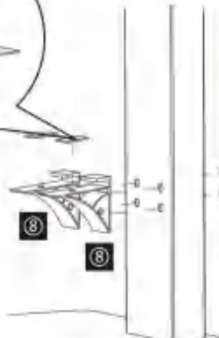
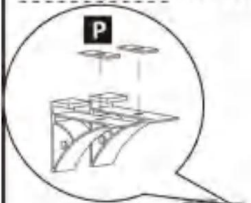

# 4

Meet de breedte en hoogte van de bevestigingsgaten van de tv

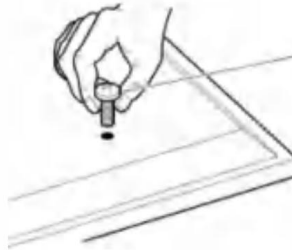
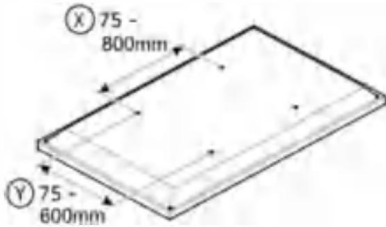

- TV1
- TV2
- TV3
- TV4

Als de breedte (X) groter is tot 600mm of hoogte® groter dan 400 mm STOP-installatie nu en neem contact op met de klantenservice

Er worden 4 diameters tv-bevestigingsschroeven meegeleverd, M6 en M8. Bepaal welke schroefdiameter past.



Voor tv's met een onregelmatige/belemmerde achterkant

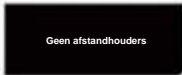

Voor tv's met een vlakke/vrije achterkant



Bewaar deze informatie voor toekomstig gebruik.

# A

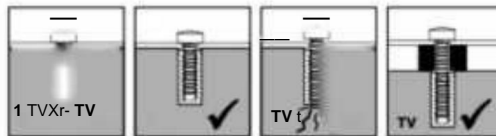

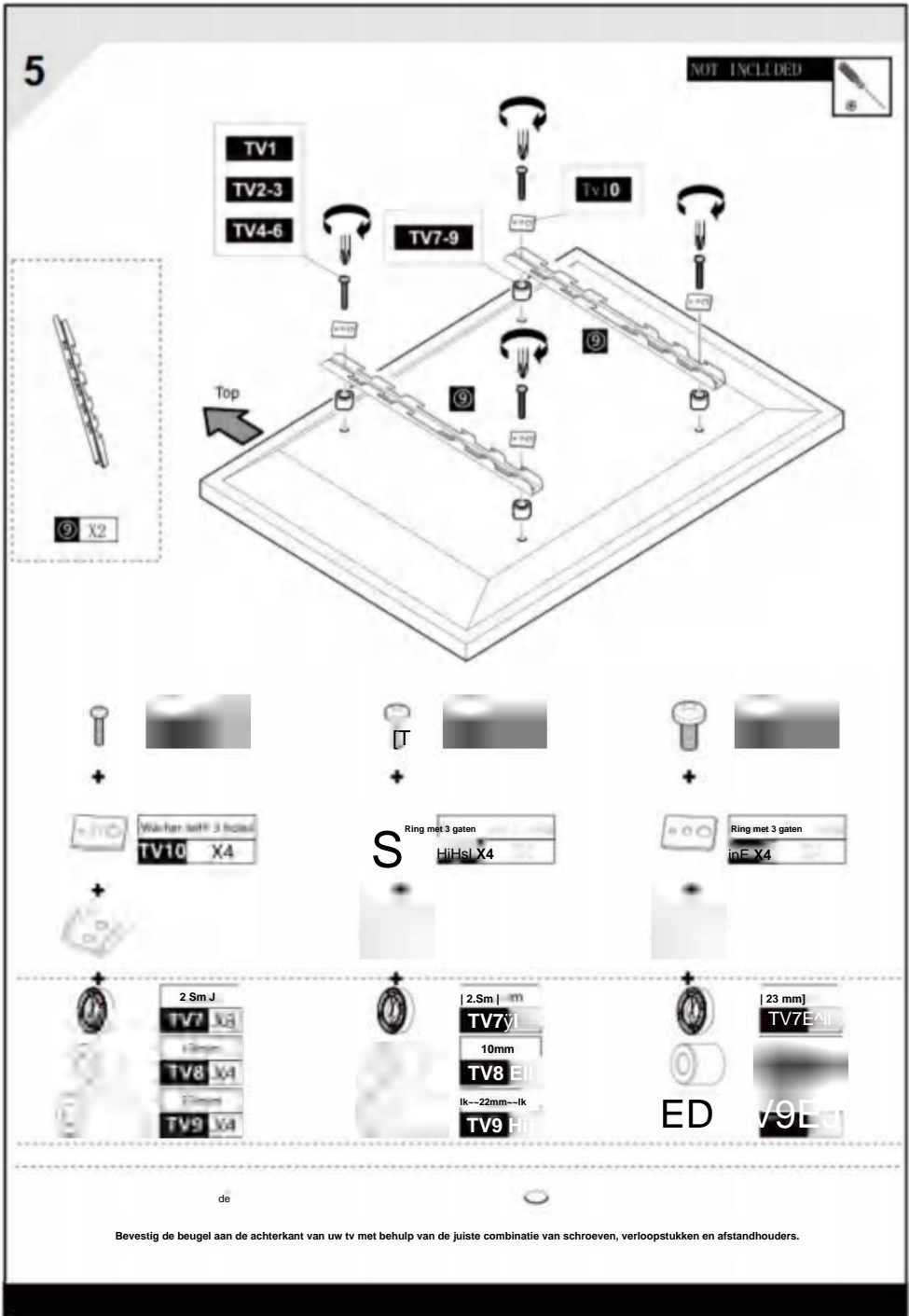

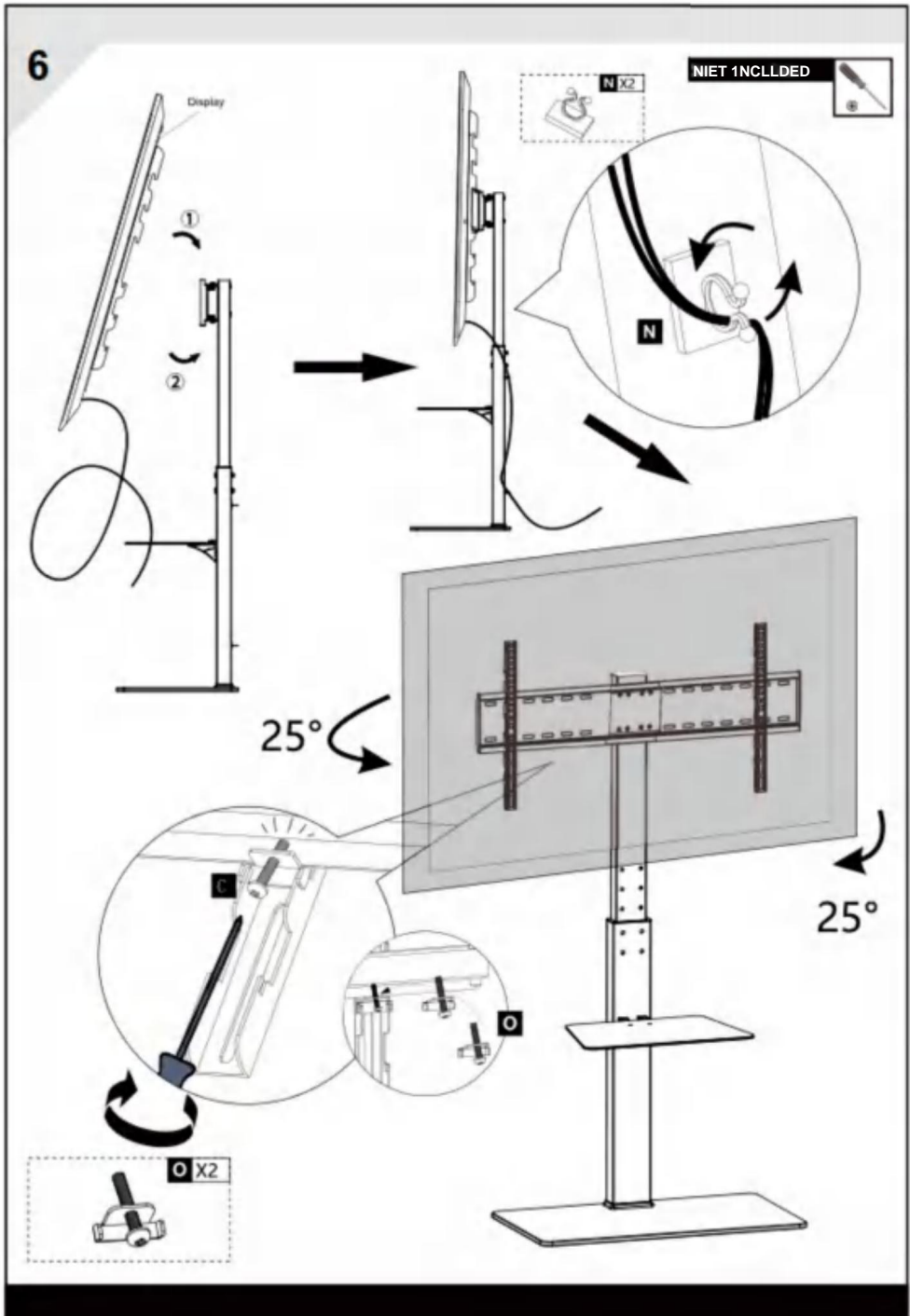

Fabrikant: Shanghaimuxinmuyeyouxiangongsi Adres:

Shuangchenglu 803nong11 hao1602A-1609shi, baoshanqu, shanghai  
200000 CN.

Geïmporteerd naar AUS: SIHAO PTY LTD. 1 ROKEVA STREETEAST-WOOD  
NSW2122 Australië

Geïmporteerd naar de VS: Sanven Technology Ltd. Suite 250, 9166  
Anaheim Place, Rancho Cucamonga, CA91730



E-CrossStu GmbH  
Mainzer Landstr.69, 60329 Frankfurt am Main.



YH CONSULTING LIMITED.  
C/O YH Consulting Limited Kantoor 147, Centurion House, London  
Road, Staines-upon-Thames, Surrey, TW18 4AX





**V EN DER** <sup>®</sup>  
MOEILIK GEREEDSCHAP V, HALF PRIJS

Technische ondersteuning en e-garantiecertificaat

[www.vevor.com/support](http://www.vevor.com/support)



# VEVOR

HÅRA VERKTYG, HALVA PRISET

Teknisk support och e-garanticertifikat [www.vevor.com/support](http://www.vevor.com/support)

## TV-STAT

## ANVÄNDARMANUAL

MODELL: FSH28

Vi fortsätter att vara engagerade i att ge dig verktyg till konkurrenskraftiga priser.

"Spara hälften, "halva priset" eller andra liknande uttryck som används av oss representerar endast en uppskattning av besparingar du kan dra nytta av att köpa vissa verktyg hos oss jämfört med de stora toppmärkena och doser behöver inte nödvändigtvis täcka alla kategorier av verktyg som erbjuds av oss . Du påminns om att noggrant kontrollera när du lägger en beställning hos oss om du faktiskt sparar hälften i jämförelse med de främsta varumärkena.



# VEVOR®

HÅRA VERKTYG, HALVA PRISET

TV-STAT

MODELL: FSH28

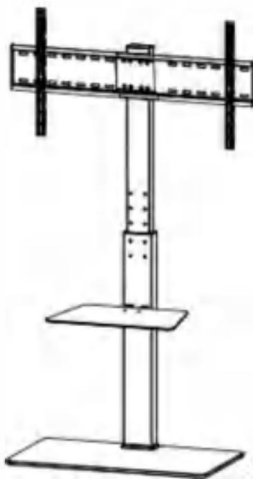

## BEHÖVER HJÄLP? KONTAKTA OSS!

Har du produktfrågor? Behöver du teknisk support? Du får gärna kontakta oss:



[CustomerService@vevor.com](mailto:CustomerService@vevor.com)

Detta är den ursprungliga instruktionen, läs alla instruktioner noggrant innan du använder den. VEVOR reserverar sig för en tydlig tolkning av vår användarmanual. Utseendet på produkten är beroende av den produkt du fått. Ursäkta oss att vi inte kommer att informera dig igen om det finns någon teknik eller mjukvaruuppdateringar på vår produkt.

## SÄKERHETSINSTRUKTIONER

### **VARNING:**

**Läs detta material innan du använder denna produkt. Underlåtenhet att göra det kan resultera i allvarliga skador.**

### **Försiktighetsåtgärder vid**

**montering** 1. Montera endast enligt dessa instruktioner. Felaktig montering kan skapa faror.

2. Bär ANSI-godkända skyddsglasögon och kraftiga arbetshandskar vid montering.
3. Håll monteringsområdet rent och väl upplyst.
4. Håll åskådare borta från området under monteringen.
5. Sätt dig inte ihop när du är trött eller påverkad av alkohol, droger eller mediciner.
6. Viktkapacitet och andra produkttegenskaper gäller endast för korrekt och färdigmonterad produkt.
7. Montera på en plan, jämn, hård och slät yta som säkert kan stödja ett fullt laddat TV-ställ.

Använd försiktighetsåtgärder

### **FÖR ATT FÖRHINDRA ALLVARLIGA SKADA OCH DÖDSFALL OM ATT VÄLTA:**

#### **1. SIT, STÅ ELLER KLÄTTRA INTE PÅ DETTA FÖREMÅL.**















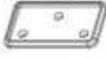

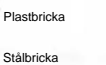









2. Denna produkt är inte en leksak. Låt inte barn leka med eller nära detta föremål.
3. Överskrid inte den angivna vikten. Allvarliga skador eller materiella skador kan uppstå!.
4. Använd endast på en plan, jämn, hård och slät yta som säkert kan stödja ett fullt laddat TV-ställ.
5. Lyft inte när den är lastad.
6. Använd endast på avsett sätt.
7. Inspektera före varje användning; Använd inte om delar är lösa eller skadade.

### **SPARA DENNA MANUAL**









## PRODUKTPARAMETER

Modell	FSH28
Bärande vikt	<b>Totalt: 132lbs Max</b> TV-fäste: HOlbsMAX Bricka: 22lbs MAX
Monteringsmått	100x100,100x200,100x400 200x200,200x300,200x400 300x300,300x400 400x400,400x600 600x600,600x800
Skärmstorlek	85" Max
Produktstorlek	841*397*1400 mm
Nettovikt	17,05 kg
Bruttovikt	18,15 kg

# DELLISTA

	<b>1</b> X2		<b>6</b> X1		R		Plastbricka
	<b>2</b> X1		<b>7</b> X1		R		Stålbricka
	<b>3</b> X1		<b>8</b> X2		R		<b>L</b> X1 M5
	<b>4</b> X1		<b>9</b> X2		1		<b>M</b> X1 M4
	Fråga X1		<b>11</b> X1		,		<b>N</b> X2
					,		<b>O</b> X2
					,		<b>P</b> X2
					5		
					,		
					,		
					,		

**FÖR TV-INSTALLATION**

	<b>I-M6X16 I</b> TV2yl		<b>I-M6X35 I</b> TV3 la		<b>I-M8X15 I</b> TV4		<b>I-M8X35 I</b> TV5 Kiss
	<b>I-M8X50 I</b> TV6 kyssa		<b>2,5 mm-I</b> TV7 kaffe		<b>10 mm</b> TV8 The		<b>I 22mm I</b> TV9 He
							<b>Ibricka med 3 hål</b> TV10I

## MONTERINGSTEG

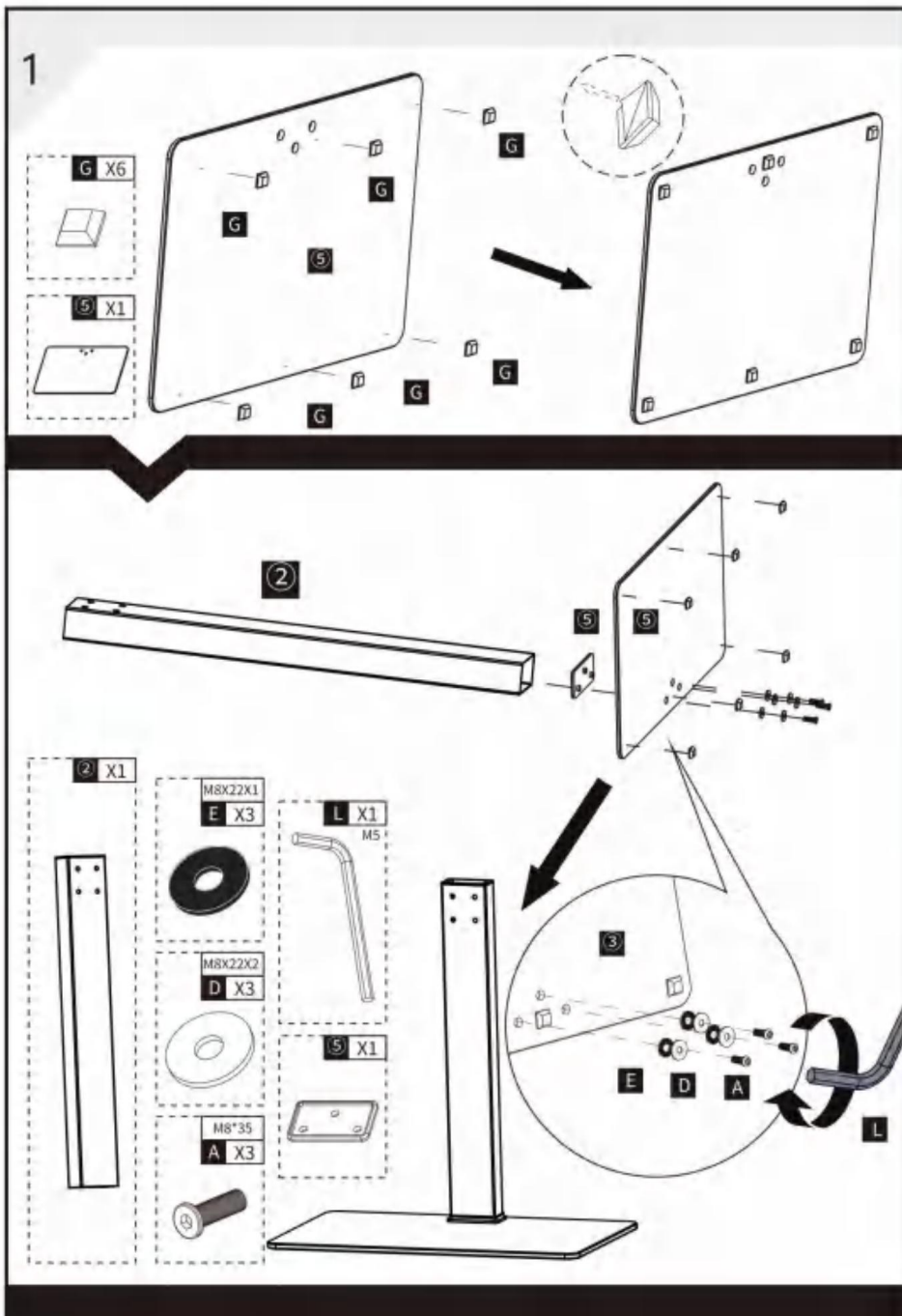

2

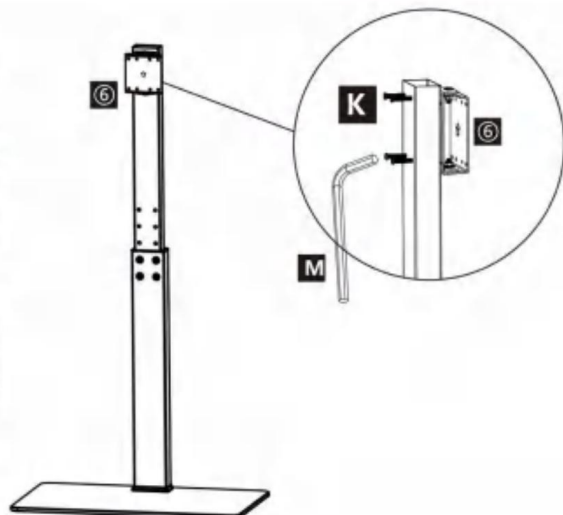
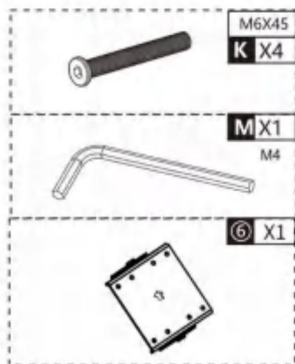
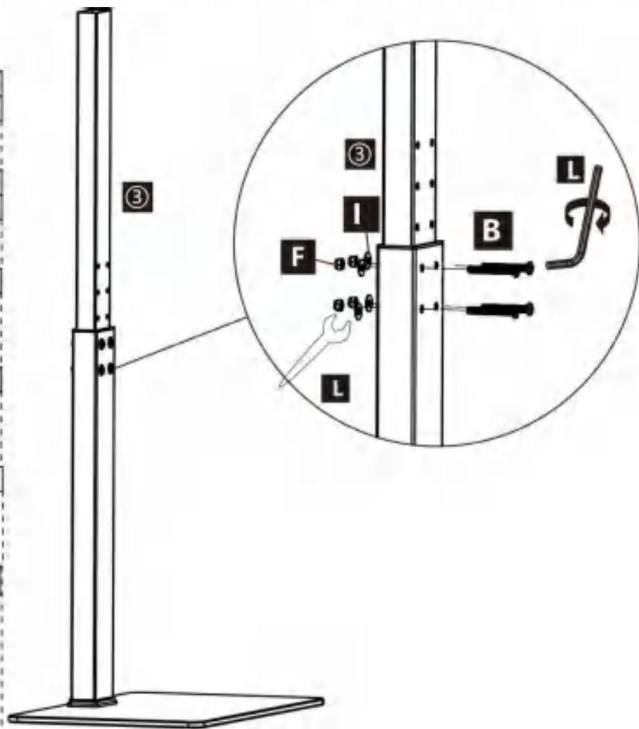
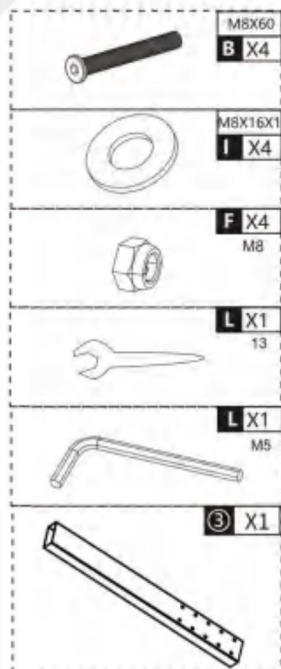



3

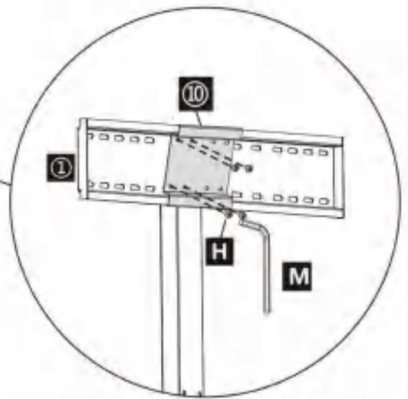
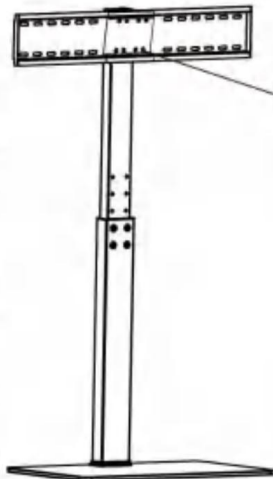
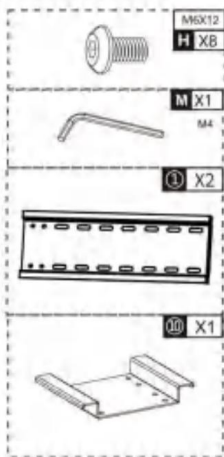

INGÅR INTE

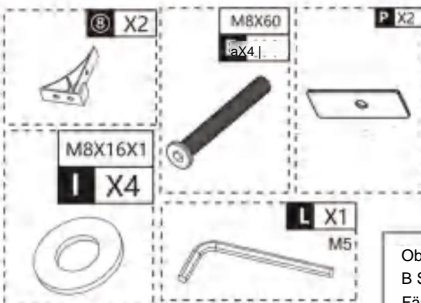

Obs: Under laminatinstallation,  
B Skruven låser inte helt,  
Fäst skruv B efter att ha monterat skruv C

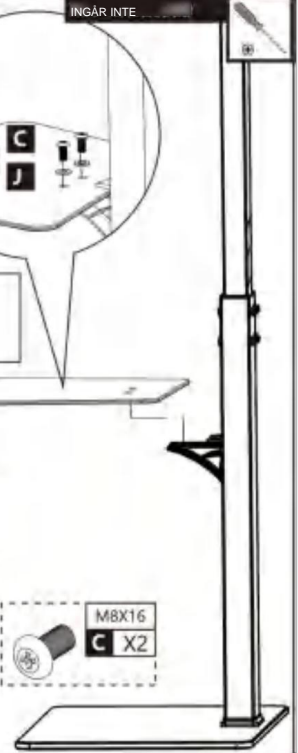
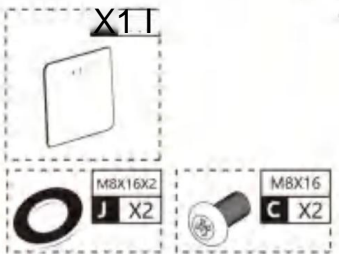
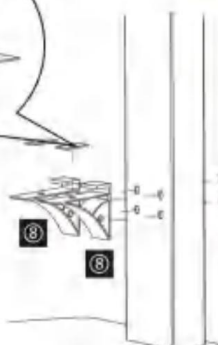

# 4

Mät TV:ns fästhål bredd och höjd

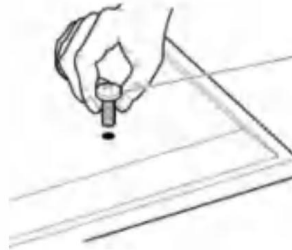
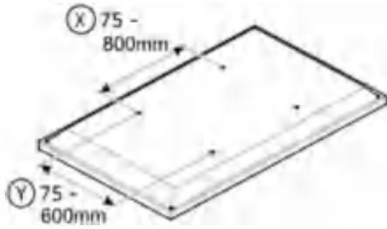

- TV1
- TV2
- TV3
- TV4

Om bredden (X) är större än 600mm eller höjden (Y) mer än 400 mm STOPPA installationen nu och kontakta kundtjänsten

Du är försedd med 4 diametrar av TV-fästskruvar, M6 och M8. Bestäm skruvdiametern som passar.



För TV-apparater med i rregular/blockerad rygg

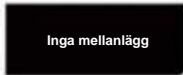

För TV-apparater med platt/fri rygg

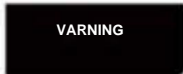

vänligen spara för framtida referens.

# A

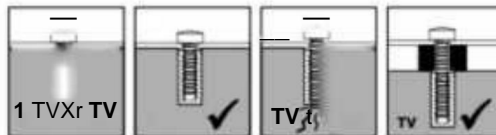

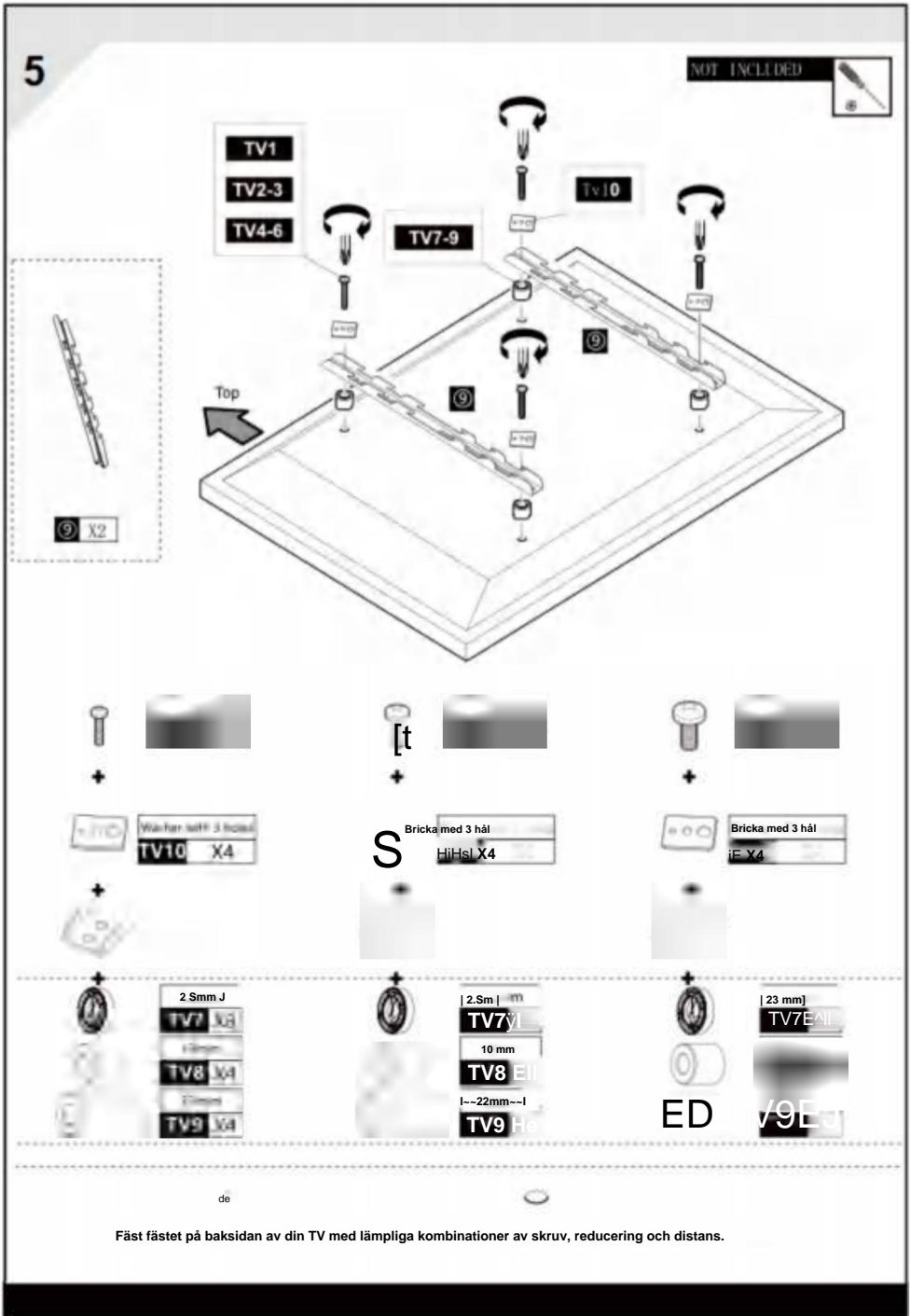

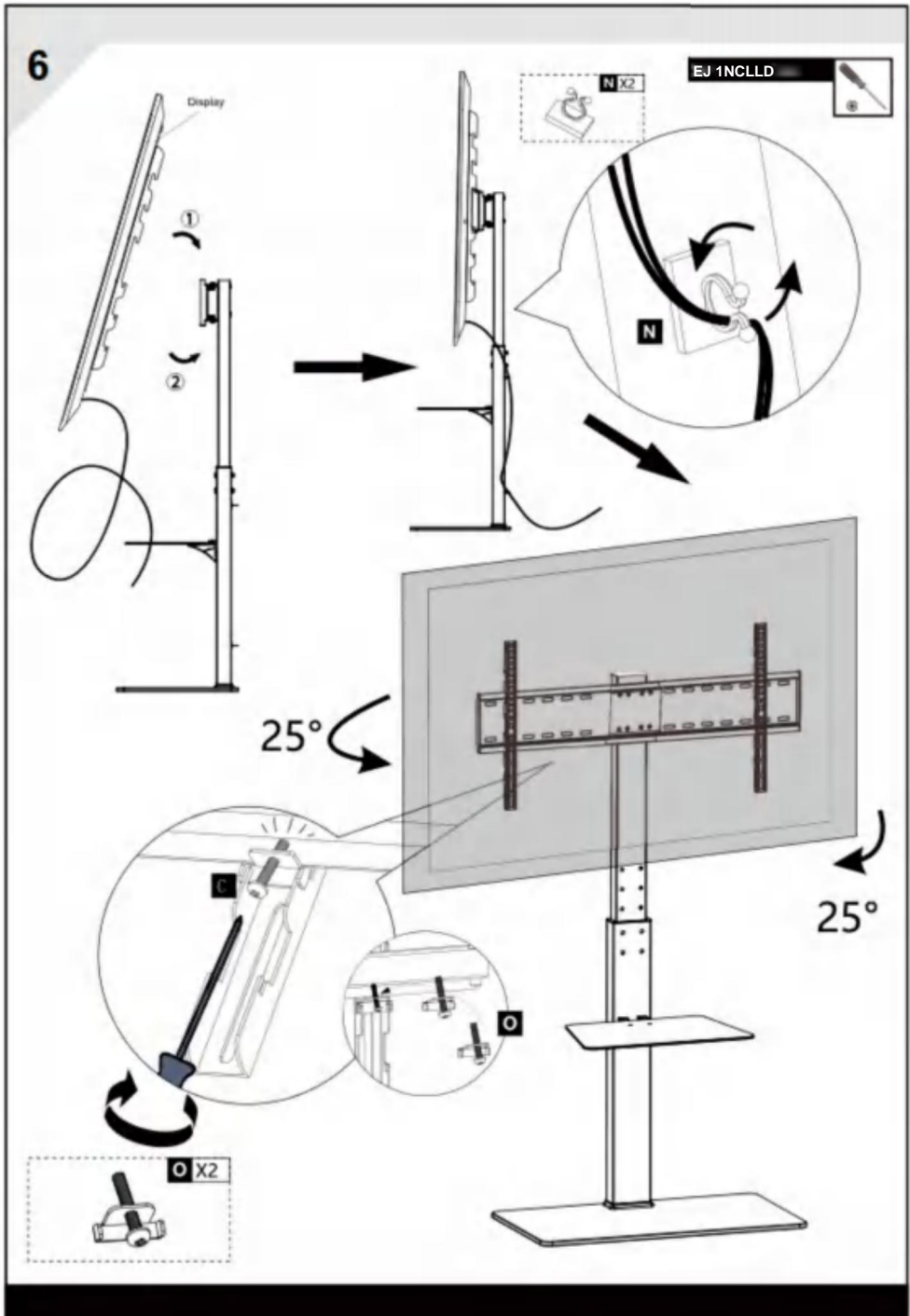

Tillverkare: Shanghaimuxinmuyeyouxiangongsi Adress:

Shuangchenglu 803nong11 hao1602A-1609shi, baoshanqu, shanghai  
200000 CN.

Importerad till AUS: SIHAO PTY LTD. 1 ROKEVA STREETEAST-WOOD  
NSW2122 Australien

Importerad till USA: Sanven Technology Ltd. Suite 250, 9166 Anaheim  
Place, Rancho Cucamonga, CA91730



E-CrossStu GmbH  
Mainzer Landstr.69, 60329 Frankfurt am Main.



YH CONSULTING LIMITED.  
C/O YH Consulting Limited Office 147, Centurion House, London  
Road, Staines-upon-Thames, Surrey, TW18 4AX





**V** OCH **DER**®  
TUFF VERKTYG V, HALV PRIS

Teknisk support och e-garanticertifikat

[www.vevor.com/support](http://www.vevor.com/support)