

VEVOR[®]

TOUGH TOOLS, HALF PRICE

Technical Support and E-Warranty Certificate www.vevor.com/support

FURNITURE DOLLIES

MODEL: SC01 / SC02

We continue to be committed to provide you tools with competitive price.

"Save Half", "Half Price" or any other similar expressions used by us only represents an estimate of savings you might benefit from buying certain tools with us compared to the major top brands and does not necessarily mean to cover all categories of tools offered by us. You are kindly reminded to verify carefully when you are placing an order with us if you are actually saving half in comparison with the top major brands.

VEVOR[®]

TOUGH TOOLS, HALF PRICE

FURNITURE DOLLIES

MODEL: SC01 / SC02



NEED HELP? CONTACT US!

Have product questions? Need technical support? Please feel free to contact us:

Technical Support and E-Warranty Certificate
www.vevor.com/support

This is the original instruction, please read all manual instructions carefully before operating. VEVOR reserves a clear interpretation of our user manual. The appearance of the product shall be subject to the product you received. Please forgive us that we won't inform you again if there are any technology or software updates on our product.



SAFETY INSTRUCTIONS

WARNING:

1. Please do not put it near flammable materials.
2. It is forbidden to carry people under any condition.
3. This product cannot be used to go up or down stairs.
4. Overload is strictly prohibited.
5. Don't move too fast when passing pothole areas.

SAVE THESE INSTRUCTIONS

MODEL AND PARAMETERS

Model	Photo	PARAMETERS
SC01	 1-pack	Material: Wood Size (single): 750x455x130 mm Load Capacity: 1. The normal load of each furniture dolly is 660 pounds, and the maximum load does not exceed 1,000 pounds.
SC02	 2-pack	2. It is impossible to use two furniture trolleys to carry the same piece of furniture at the same time.

ASSEMBLY & INSTALLATION

1. Unscrew all nuts.



2. Put together 4 pieces of wood.

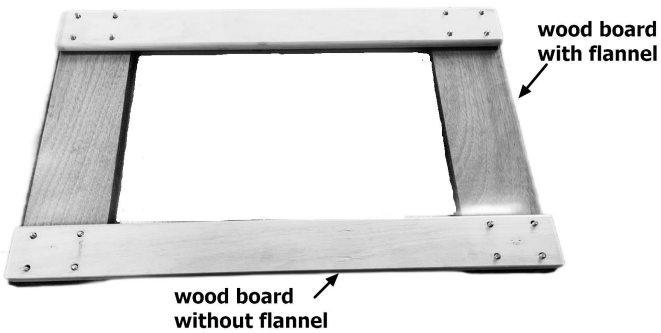

3. Install the wheels and tighten the nuts.

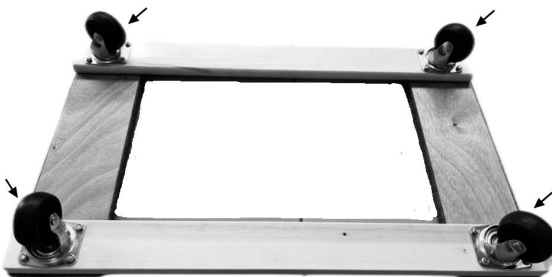

MAINTENANCE

1. Avoid prolonged exposure to the sun to avoid aging.
2. Inspect accessories for wear, cracks and other damage before use, and replace defective accessories immediately.

Manufacturer: Shanghaimuxinmuyeyouxiangongsi

Address: Shuangchenglu 803nong11hao1602A-1609shi, baoshanqu, shanghai 200000 CN.

Imported to AUS: SIHAO PTY LTD, 1 ROKEVA STREETEASTWOOD NSW 2122 Australia

Imported to USA: Sanven Technology Ltd., Suite 250, 9166 Anaheim Place, Rancho Cucamonga, CA 91730

EC	REP
-----------	------------

E-CrossStu GmbH
Mainzer Landstr.69, 60329 Frankfurt am Main.

UK	REP
-----------	------------

YH CONSULTING LIMITED.
C/O YH Consulting Limited Office 147, Centurion House,
London Road, Staines-upon-Thames, Surrey, TW18 4AX

VEVOR[®]
TOUGH TOOLS, HALF PRICE

Technical Support and E-Warranty Certificate
www.vevor.com/support

VEVOR[®]

TOUGH TOOLS, HALF PRICE

Techniczny Wsparcie i certyfikat gwarancji elektronicznej www.vevor.com/support

WÓZKI MEBLOWE

MODELE: SC01 / SC02

We continue to be committed to provide you tools with competitive price.

"Save Half", "Half Price" or any other similar expressions used by us only represents an estimate of savings you might benefit from buying certain tools with us compared to the major top brands and does not necessarily mean to cover all categories of tools offered by us. You are kindly reminded to verify carefully when you are placing an order with us if you are actually saving half in comparison with the top major brands.

VEVOR[®]

TOUGH TOOLS, HALF PRICE

FURNITURE DOLLIES

MODELE: SC01 / SC02



NEED HELP? CONTACT US!

Have product questions? Need technical support? Please feel free to contact us:

Technical Support and E-Warranty Certificate
www.vevor.com/support

This is the original instruction, please read all manual instructions carefully before operating. VEVOR reserves a clear interpretation of our user manual. The appearance of the product shall be subject to the product you received. Please forgive us that we won't inform you again if there are any technology or software updates on our product.



SAFETY INSTRUCTIONS

OSTRZEŻENIE:

1. Proszę nie umieszczać go w pobliżu materiałów łatwopalnych.
2. Przewożenie osób jest zabronione pod żadnym pozorem.
3. Produktu nie można używać do wchodzenia lub schodzenia po schodach.
4. Przeciążanie jest surowo zabronione.
5. Nie poruszaj się zbyt szybko przy pokonywaniu dziur w drodze.

ZAPISZ TE INSTRUKCJE

MODEL AND PARAMETERS

Model	Zdjęcie	PARAMETRY
SC01	 1 - opakowanie	Materiał : Drewno Rozmiar (pojedynczy) : Wymiary 750x455x130 mm Nośność : 1. Normalne obciążenie każdego wózka meblowego wynosi 660 funtów, a maksymalne obciążenie nie przekracza 1000 funtów.
SC02	 2- pak	2. Nie jest możliwe użycie dwóch wózków meblowych do przewozu tego samego mebla jednocześnie.

ASSEMBLY & INSTALLATION

1. Odkręć wszystkie nakrętki.



2. Złóż razem 4 kawałki drewna .

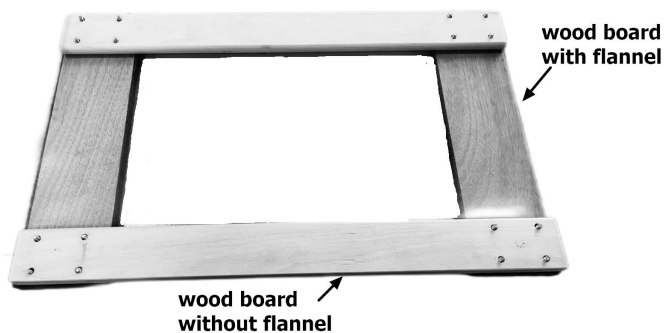

3. Zamontuj koła i dokręć nakrętki.

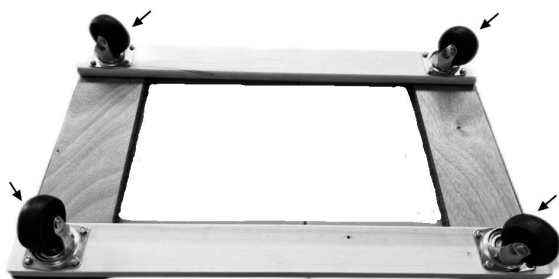

MAINTENANCE

1. Aby zapobiec starzeniu się skóry, należy unikać długotrwałego wystawiania się na działanie promieni słonecznych.
2. Przed użyciem należy sprawdzić, czy akcesoria nie są zużyte, popękane lub uszkodzone. Wadliwe akcesoria należy niezwłocznie wymienić.

Producent: Shanghai muxinmuyeyouxiangongsi

Adres: Shuangchenglu 803nong11hao1602A-1609shi, baoshanqu, szanghaj 200000 CN.

Importowane do AUS: SIHAO PTY LTD, 1 ROKEVA STREET EASTWOOD NSW 2122 Australia

Importowane do USA: Sanven Technology Ltd., Suite 250, 9166 Anaheim Place, Rancho Cucamonga, CA 91730

EC	REP
-----------	------------

E-CrossStu GmbH
Mainzer Landstr.69, 60329 Frankfurt am Main.

UK	REP
-----------	------------

YH CONSULTING LIMITED.
C/O YH Consulting Limited Office 147, Centurion House,
London Road, Staines-upon-Thames, Surrey, TW18 4AX

VEVOR[®]

TOUGH TOOLS, HALF PRICE

Techniczny Wsparcie i certyfikat e-gwarancji

www.vevor.com/support

VEVOR®

TOUGH TOOLS, HALF PRICE

Technisch Support und E-Garantie-Zertifikat www.vevor.com/support

MÖBELWAGEN

MODELL: SC01 / SC02

We continue to be committed to provide you tools with competitive price.

"Save Half", "Half Price" or any other similar expressions used by us only represents an estimate of savings you might benefit from buying certain tools with us compared to the major top brands and does not necessarily mean to cover all categories of tools offered by us. You are kindly reminded to verify carefully when you are placing an order with us if you are actually saving half in comparison with the top major brands.

VEVOR[®]

TOUGH TOOLS, HALF PRICE

FURNITURE DOLLIES

MODELL: SC01 / SC02



NEED HELP? CONTACT US!

Have product questions? Need technical support? Please feel free to contact us:

Technical Support and E-Warranty Certificate
www.vevor.com/support

This is the original instruction, please read all manual instructions carefully before operating. VEVOR reserves a clear interpretation of our user manual. The appearance of the product shall be subject to the product you received. Please forgive us that we won't inform you again if there are any technology or software updates on our product.



SAFETY INSTRUCTIONS

WARNUNG:

1. Bitte stellen Sie es nicht in die Nähe von brennbaren Materialien.
2. Die Beförderung von Personen ist unter allen Umständen verboten.
3. Dieses Produkt kann nicht zum Treppensteigen verwendet werden.
4. Eine Überlastung ist strengstens untersagt.
5. Fahren Sie nicht zu schnell durch Bereiche mit Schlaglöchern.

BEWAHREN SIE DIESE ANWEISUNGEN AUF

MODEL AND PARAMETERS

Modell	Foto	PARAMETER
SC01	 1 - Packung	Material : Holz Größe (einzeln) : 750 x 455 x 130 mm Tragfähigkeit : 1. Die normale Belastung jedes Möbelwagens beträgt 660 Pfund und die Maximalbelastung überschreitet nicht 1.000 Pfund.
SC02	 2er- Pack	2. Es ist nicht möglich, mit zwei Möbelwagen gleichzeitig das gleiche Möbelstück zu transportieren.

ASSEMBLY & INSTALLATION

1. Alle Muttern lösen.



2. Setzen Sie 4 Holzstücke zusammen .

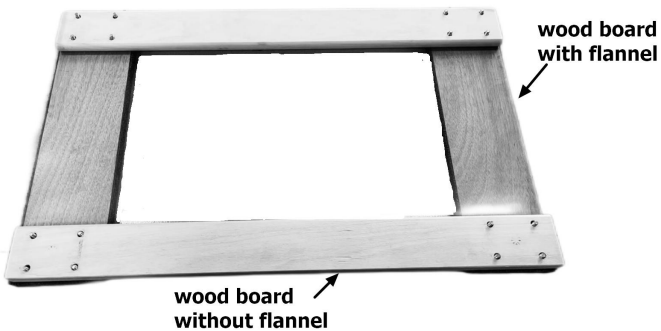

3. Montieren Sie die Räder und ziehen Sie die Muttern fest.

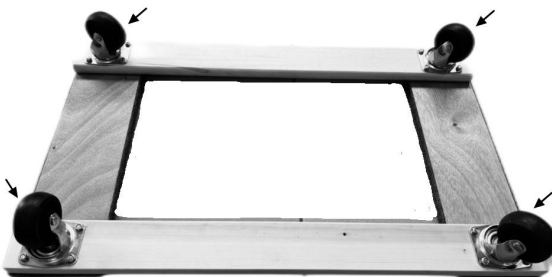

MAINTENANCE

1. Vermeiden Sie längere Sonneneinstrahlung, um der Hautalterung vorzubeugen.
2. Überprüfen Sie Zubehör vor dem Gebrauch auf Verschleiß, Risse und andere Schäden und ersetzen Sie defektes Zubehör sofort.

Hersteller: Shanghaimuxinmuyeyouxiangongsi

Adresse: Shuangchenglu 803nong11hao1602A-1609shi, baoshanqu, Shanghai 200000 CN.

Nach AUS importiert: SIHAO PTY LTD, 1 ROKEVA STREETEASTWOOD NSW 2122 Australien

Importiert in die USA: Sanven Technology Ltd., Suite 250, 9166 Anaheim Place, Rancho Cucamonga, CA 91730

EC	REP
----	-----

E-CrossStu GmbH
Mainzer Landstr.69, 60329 Frankfurt am Main.

UK	REP
----	-----

YH CONSULTING LIMITED.
C/O YH Consulting Limited Office 147, Centurion House,
London Road. Staines-upon-Thames. Surrey. TW18 4AX

VEVOR[®]

TOUGH TOOLS, HALF PRICE

Technisch Support und E-Garantie-Zertifikat

www.vevor.com/support

VEVOR[®]

TOUGH TOOLS, HALF PRICE

Technique Certificat d'assistance et de garantie électronique

www.vevor.com/support

CHARIOTS À MEUBLES

MODÈLE : SC01 / SC02

We continue to be committed to provide you tools with competitive price.

"Save Half", "Half Price" or any other similar expressions used by us only represents an estimate of savings you might benefit from buying certain tools with us compared to the major top brands and does not necessarily mean to cover all categories of tools offered by us. You are kindly reminded to verify carefully when you are placing an order with us if you are actually saving half in comparison with the top major brands.

VEVOR[®]

TOUGH TOOLS, HALF PRICE

FURNITURE DOLLIES

MODÈLE : SC01 / SC02



NEED HELP? CONTACT US!

Have product questions? Need technical support? Please feel free to contact us:

Technical Support and E-Warranty Certificate
www.vevor.com/support

This is the original instruction, please read all manual instructions carefully before operating. VEVOR reserves a clear interpretation of our user manual. The appearance of the product shall be subject to the product you received. Please forgive us that we won't inform you again if there are any technology or software updates on our product.



SAFETY INSTRUCTIONS

AVERTISSEMENT:

1. Veuillez ne pas le placer à proximité de matériaux inflammables.
2. Il est interdit de transporter des personnes sous quelque condition que ce soit.
3. Ce produit ne peut pas être utilisé pour monter ou descendre des escaliers.
4. La surcharge est strictement interdite.
5. Ne vous déplacez pas trop vite lorsque vous passez près de nids-de-poule.

CONSERVEZ CES INSTRUCTIONS

MODEL AND PARAMETERS

Modèle	Photo	PARAMÈTRES
SC01	 1 - paquet	Matériel : Bois Taille (simple) : 750 x 455 x 130 mm Capacité de charge : 1. La charge normale de chaque chariot de meubles est de 660 livres et la charge maximale ne dépasse pas 1 000 livres.
SC02	 Paquet de 2	2. Il est impossible d'utiliser deux chariots à meubles pour transporter le même meuble en même temps.

ASSEMBLY & INSTALLATION

1. Dévissez tous les écrous.



2. Assemblez 4 morceaux de bois .

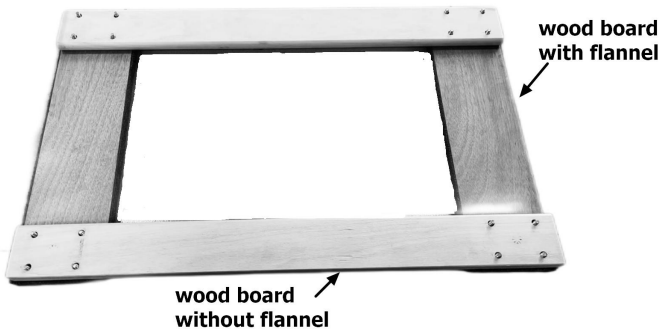

3. Installez les roues et serrez les écrous.

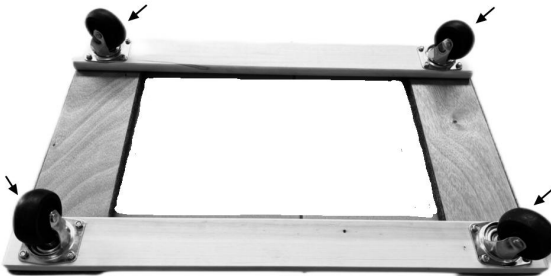

MAINTENANCE

1. Évitez l'exposition prolongée au soleil pour éviter le vieillissement.
2. Inspectez les accessoires pour détecter l'usure, les fissures et autres dommages avant utilisation et remplacez immédiatement les accessoires défectueux.

Fabricant : Shanghaimuxinmuyeyouxiangongsi

Adresse : Shuangchenglu 803nong11hao1602A-1609shi, baoshanqu, shanghai 200000 CN.

Importé en Australie : SIHAO PTY LTD, 1 ROKEVA STREET, ASTWOOD NSW 2122 Australie

Importé aux États-Unis : Sanven Technology Ltd., Suite 250, 9166 Anaheim Place, Rancho Cucamonga, CA 91730

EC	REP
----	-----

E-CrossStu GmbH
Mainzer Landstr.69, 60329 Frankfurt am Main.

UK	REP
----	-----

YH CONSULTING LIMITED.
C/O YH Consulting Limited Office 147, Centurion House,
London Road, Staines-upon-Thames, Surrey, TW18 4AX

VEVOR[®]

TOUGH TOOLS, HALF PRICE

Technique Certificat d'assistance et de garantie électronique

www.vevor.com/support

VEVOR[®]

TOUGH TOOLS, HALF PRICE

Technisch Ondersteuning en E-garantiecertificaat www.vevor.com/support

MEUBELKARREN

MODEL: SC01 / SC02

We continue to be committed to provide you tools with competitive price.

"Save Half", "Half Price" or any other similar expressions used by us only represents an estimate of savings you might benefit from buying certain tools with us compared to the major top brands and does not necessarily mean to cover all categories of tools offered by us. You are kindly reminded to verify carefully when you are placing an order with us if you are actually saving half in comparison with the top major brands.

VEVOR[®]

TOUGH TOOLS, HALF PRICE

FURNITURE DOLLIES

MODEL: SC01 / SC02



NEED HELP? CONTACT US!

Have product questions? Need technical support? Please feel free to contact us:

Technical Support and E-Warranty Certificate
www.vevor.com/support

This is the original instruction, please read all manual instructions carefully before operating. VEVOR reserves a clear interpretation of our user manual. The appearance of the product shall be subject to the product you received. Please forgive us that we won't inform you again if there are any technology or software updates on our product.



SAFETY INSTRUCTIONS

WAARSCHUWING:

1. Plaats het niet in de buurt van brandbare materialen.
2. Het is onder geen enkele voorwaarde toegestaan om personen te vervoeren.
3. Dit product kan niet gebruikt worden om trappen op of af te gaan.
4. Overbelasting is ten strengste verboden.
5. Rijd niet te snel als u een kuil in de weg passeert.

BEWAAR DEZE INSTRUCTIES

MODEL AND PARAMETERS

Model	Foto	PARAMETERS
SC01	 1 - pak	Materiaal : Hout Maat (enkel) : 750x455x130mm Laadvermogen : 1. De normale belasting van elke meubelkar bedraagt 660 pond (293 kilo), en de maximale belasting bedraagt niet meer dan 1.000 pond (454 kilo).
SC02	 2- pack	2. Het is niet mogelijk om twee meubelwagens te gebruiken om hetzelfde meubelstuk tegelijkertijd te vervoeren.

ASSEMBLY & INSTALLATION

1. Draai alle moeren los.



2. Zet 4 stukken hout op elkaar .

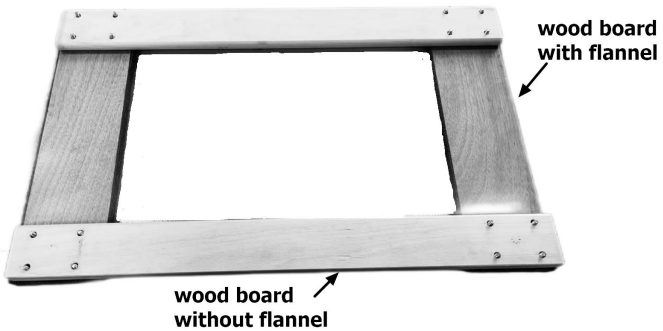

3. Monteer de wielen en draai de moeren vast.

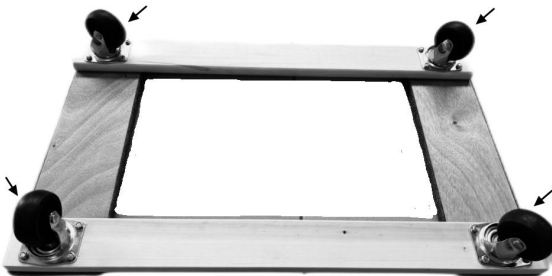

MAINTENANCE

1. Vermijd langdurige blootstelling aan de zon om veroudering te voorkomen.
2. Controleer accessoires vóór gebruik op slijtage, scheuren en andere schade en vervang defecte accessoires onmiddellijk.

Fabrikant: Shanghaimuxinmuyeyouxiangongsi

Adres: Shuangchenglu 803nong11hao1602A-1609shi, baoshanqu, shanghai 200000 CN.

Geïmporteerd naar AUS: SIHAO PTY LTD, 1 ROKEVA STREETEASTWOOD NSW 2122 Australië

Geïmporteerd naar de VS: Sanven Technology Ltd., Suite 250, 9166 Anaheim Place, Rancho Cucamonga, CA 91730

EC	REP
-----------	------------

E-CrossStu GmbH
Mainzer Landstr.69, 60329 Frankfurt am Main.

UK	REP
-----------	------------

YH CONSULTING LIMITED.
C/O YH Consulting Limited Office 147, Centurion House,
London Road. Staines-upon-Thames. Surrey. TW18 4AX

VEVOR[®]

TOUGH TOOLS, HALF PRICE

Technisch Ondersteuning en E-garantiecertificaat

www.vevor.com/support

VEVOR®

TOUGH TOOLS, HALF PRICE

Teknisk Support och e-garanticertifikat www.vevor.com/support

MÖBELDOCKOR

MODELL: SC01 / SC02

We continue to be committed to provide you tools with competitive price.

"Save Half", "Half Price" or any other similar expressions used by us only represents an estimate of savings you might benefit from buying certain tools with us compared to the major top brands and does not necessarily mean to cover all categories of tools offered by us. You are kindly reminded to verify carefully when you are placing an order with us if you are actually saving half in comparison with the top major brands.

VEVOR®

TOUGH TOOLS, HALF PRICE

FURNITURE DOLLIES

MODELL: SC01 / SC02



NEED HELP? CONTACT US!

Have product questions? Need technical support? Please feel free to contact us:

Technical Support and E-Warranty Certificate
www.vevor.com/support

This is the original instruction, please read all manual instructions carefully before operating. VEVOR reserves a clear interpretation of our user manual. The appearance of the product shall be subject to the product you received. Please forgive us that we won't inform you again if there are any technology or software updates on our product.



SAFETY INSTRUCTIONS

WARNING:

1. Placera den inte nära brandfarliga material.
2. Det är förbjudet att transportera människor under alla förhållanden.
3. Denna produkt kan inte användas för att gå upp eller ner för trappor.
4. Överbelastning är strängt förbjuden.
5. Rör dig inte för snabbt när du passerar gropar.

SPARA DESSA INSTRUKTIONER

MODEL AND PARAMETERS

Modell	P hoto	PARAMETRAR
SC01	 1 - förpackning	Material : Trä Storlek (enkel) : 750 x 455 x 130 mm Lastkapacitet : 1. Den normala belastningen för varje möbeldocka är 660 pund, och den maximala belastningen överstiger inte 1 000 pund.
SC02	 2- pack	2. Det är möjligt att använda två möbelvagnar för att bära samma möbel samtidigt.

ASSEMBLY & INSTALLATION

1. Skruva loss alla muttrar.



2. Sätt ihop 4 stycken trä .

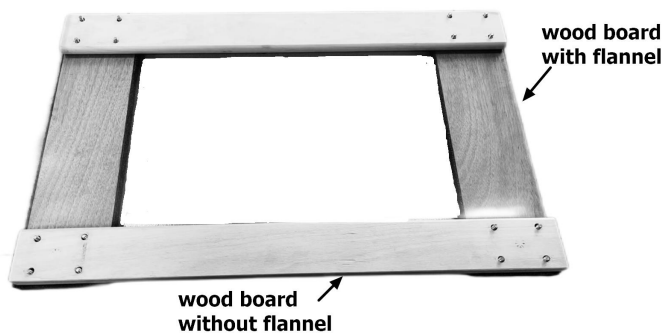

3. Montera hjulen och dra åt muttrarna.

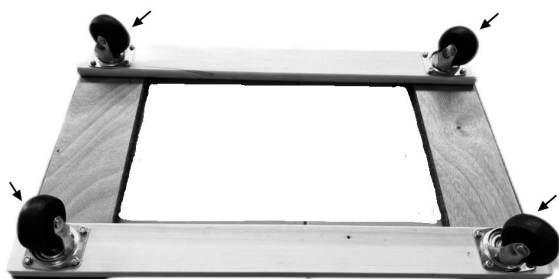

MAINTENANCE

1. Undvik långvarig exponering för solen för att undvika åldrande.
2. Inspektera tillbehören för slitage, sprickor och andra skador före användning och byt ut defekta tillbehör omedelbart.

Tillverkare: Shanghaimuxinmuyeyouxiangongsi

Adress: Shuangchenglu 803nong11hao1602A-1609shi, baoshanqu, shanghai 200000 CN.

Importerad till AUS: SIHAO PTY LTD, 1 ROKEVA STREETEASTWOOD NSW 2122 Australien

Importerad till USA: Sanven Technology Ltd., Suite 250, 9166 Anaheim Place, Rancho Cucamonga, CA 91730

EC	REP
-----------	------------

E-CrossStu GmbH
Mainzer Landstr.69, 60329 Frankfurt am Main.

UK	REP
-----------	------------

YH CONSULTING LIMITED.
C/O YH Consulting Limited Office 147, Centurion House,
London Road, Staines-upon-Thames, Surrey, TW18 4AX

VEVOR[®]

TOUGH TOOLS, HALF PRICE

Teknisk Support och e-garanticertifikat

www.vevor.com/support

VEVOR[®]

TOUGH TOOLS, HALF PRICE

Técnico Soporte y certificado de garantía electrónica www.vevor.com/support

PLATAFORMAS RODANTES PARA MUEBLES

MODELO: SC01 / SC02

We continue to be committed to provide you tools with competitive price.

"Save Half", "Half Price" or any other similar expressions used by us only represents an estimate of savings you might benefit from buying certain tools with us compared to the major top brands and does not necessarily mean to cover all categories of tools offered by us. You are kindly reminded to verify carefully when you are placing an order with us if you are actually saving half in comparison with the top major brands.

VEVOR[®]

TOUGH TOOLS, HALF PRICE

FURNITURE DOLLIES

MODELO: SC01 / SC02



NEED HELP? CONTACT US!

Have product questions? Need technical support? Please feel free to contact us:

Technical Support and E-Warranty Certificate
www.vevor.com/support

This is the original instruction, please read all manual instructions carefully before operating. VEVOR reserves a clear interpretation of our user manual. The appearance of the product shall be subject to the product you received. Please forgive us that we won't inform you again if there are any technology or software updates on our product.



SAFETY INSTRUCTIONS

ADVERTENCIA:

1. No lo coloque cerca de materiales inflamables.
2. Está prohibido transportar personas bajo cualquier condición.
3. Este producto no se puede utilizar para subir o bajar escaleras.
4. La sobrecarga está estrictamente prohibida.
5. No te muevas demasiado rápido al pasar por zonas con baches.

GUARDE ESTAS INSTRUCCIONES

MODEL AND PARAMETERS

Modelo	Foto	PARÁMETROS
SC01	 1 paquete	Material : Madera Tamaño (individual) : 750 x 455 x 130 mm Capacidad de carga : 1. La carga normal de cada plataforma rodante para muebles es de 660 libras y la carga máxima no excede las 1,000 libras.
SC02	 Paquete de 2	2. Es imposible utilizar dos carros para muebles para transportar el mismo mueble al mismo tiempo.

ASSEMBLY & INSTALLATION

1. Desatornille todas las tuercas.



2. Junta 4 piezas de madera .

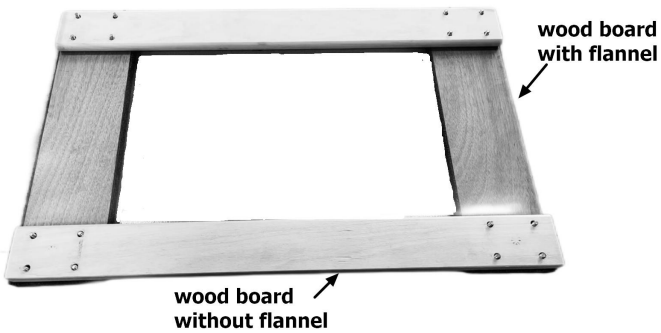

3. Instale las ruedas y apriete las tuercas.

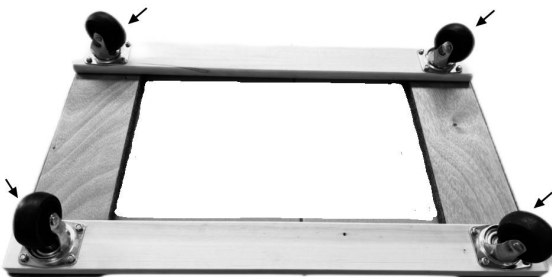

MAINTENANCE

1. Evite la exposición prolongada al sol para evitar el envejecimiento.
2. Inspeccione los accesorios para detectar desgaste, grietas y otros daños antes de usarlos y reemplace los accesorios defectuosos inmediatamente.

Fabricante: Shanghaimuxinmuyeyouxiangongsi

Dirección: Shuangchenglu 803nong11hao1602A-1609shi, baoshanqu, shanghai 200000 CN.

Importado a AUS: SIHAO PTY LTD, 1 ROKEVA STREET EASTWOOD NSW 2122 Australia

Importado a EE. UU.: Sanven Technology Ltd., Suite 250, 9166 Anaheim Place, Rancho Cucamonga, CA 91730

EC	REP
-----------	------------

E-CrossStu GmbH
Mainzer Landstr.69, 60329 Frankfurt am Main.

UK	REP
-----------	------------

YH CONSULTING LIMITED.
C/O YH Consulting Limited Office 147, Centurion House,
London Road. Staines-upon-Thames. Surrey. TW18 4AX

VEVOR[®]
TOUGH TOOLS, HALF PRICE

Técnico Certificado de soporte y garantía electrónica
www.vevor.com/support

VEVOR[®]

TOUGH TOOLS, HALF PRICE

Tecnico Supporto e certificato di garanzia elettronica www.vevor.com/support

CARRELLI PER MOBILI

MODELLO: SC01 / SC02

We continue to be committed to provide you tools with competitive price.

"Save Half", "Half Price" or any other similar expressions used by us only represents an estimate of savings you might benefit from buying certain tools with us compared to the major top brands and does not necessarily mean to cover all categories of tools offered by us. You are kindly reminded to verify carefully when you are placing an order with us if you are actually saving half in comparison with the top major brands.

VEVOR®

TOUGH TOOLS, HALF PRICE

FURNITURE DOLLIES

MODELLO: SC01 / SC02



NEED HELP? CONTACT US!

Have product questions? Need technical support? Please feel free to contact us:

Technical Support and E-Warranty Certificate
www.vevor.com/support

This is the original instruction, please read all manual instructions carefully before operating. VEVOR reserves a clear interpretation of our user manual. The appearance of the product shall be subject to the product you received. Please forgive us that we won't inform you again if there are any technology or software updates on our product.



SAFETY INSTRUCTIONS

AVVERTIMENTO:

1. Si prega di non posizionarlo vicino a materiali infiammabili.
2. È vietato trasportare persone in qualsiasi condizione.
3. Questo prodotto non può essere utilizzato per salire o scendere le scale.
4. Il sovraccarico è severamente vietato.
5. Non muoversi troppo velocemente quando si passa in zone con buche.

SALVA QUESTE ISTRUZIONI

MODEL AND PARAMETERS

Modello	Fotografia	PARAMETRI
SC01	 1 - pacco	Materiale : Legna Taglia (singolo) : Dimensioni: 750 x 455 x 130 mm Capacità di carico : 1. Il carico normale di ogni carrello per mobili è di 660 libbre, mentre il carico massimo non supera le 1.000 libbre. 2. Non è possibile utilizzare due carrelli per trasportare contemporaneamente lo stesso mobile.
SC02	 Confezione da 2	

ASSEMBLY & INSTALLATION

1. Svitare tutti i dadi.



2. Metti insieme 4 pezzi di legno .

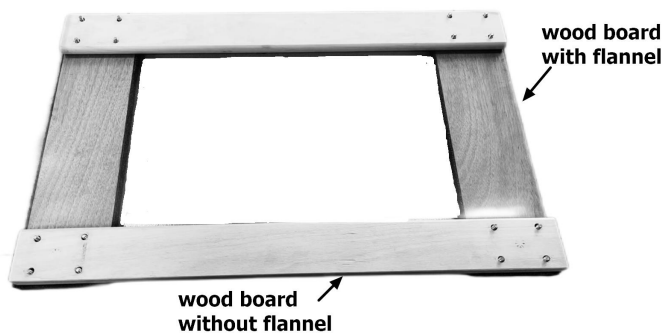

3. Installare le ruote e stringere i dadi.



MAINTENANCE

1. Evitare l'esposizione prolungata al sole per prevenire l'invecchiamento.
2. Prima dell'uso, ispezionare gli accessori per verificare che non presentino usura, crepe o altri danni e sostituire immediatamente quelli difettosi.

Produttore: Shanghaimuxinmuyeyouxiangongsi

Indirizzo: Shuangchenglu 803nong11hao1602A-1609shi, baoshanqu, shanghai 200000 CN.

Importato in AUS: SIHAO PTY LTD, 1 ROKEVA STREETEASTWOOD NSW 2122 Australia

Importato negli USA: Sanven Technology Ltd., Suite 250, 9166 Anaheim Place, Rancho Cucamonga, CA 91730

EC	REP
-----------	------------

E-CrossStu GmbH
Mainzer Landstr.69, 60329 Frankfurt am Main.

UK	REP
-----------	------------

YH CONSULTING LIMITED.
C/O YH Consulting Limited Office 147, Centurion House,
London Road. Staines-upon-Thames. Surrey. TW18 4AX

VEVOR[®]

TOUGH TOOLS, HALF PRICE

Tecnico Supporto e certificato di garanzia elettronica

www.vevor.com/support