

# **VEVOR<sup>®</sup>**

## **TOUGH TOOLS, HALF PRICE**

Technical Support and E-Warranty Certificate [www.vevor.com/support](http://www.vevor.com/support)

### **HIGH POWER SIREN**

**MODEL: KX-6001/KX-6004/KX-6503**

We continue to be committed to provide you tools with competitive price.

"Save Half", "Half Price" or any other similar expressions used by us only represents an estimate of savings you might benefit from buying certain tools with us compared to the major top brands and does not necessarily mean to cover all categories of tools offered by us. You are kindly reminded to verify carefully when you are placing an order with us if you are actually saving half in comparison with the top major brands.

# VEVOR<sup>®</sup>

TOUGH TOOLS, HALF PRICE

## HIGH POWER SIREN

MODEL: KX-6001/KX-6004/KX-6503



### NEED HELP? CONTACT US!

Have product questions? Need technical support? Please feel free to contact us:

**Technical Support and E-Warranty Certificate**  
[www.vevor.com/support](http://www.vevor.com/support)

This is the original instruction, please read all manual instructions carefully before operating. VEVOR reserves a clear interpretation of our user manual. The appearance of the product shall be subject to the product you received. Please forgive us that we won't inform you again if there are any technology or software updates on our product.

# IMPORTANT SAFEGUARDS

**WARNING:** Read this instruction before using this product. Failure to do so can result in serious injury. Always observe the rules of safe operation.

1. The temperature of the compressor may be very high during operation or after it has stopped, so do not touch it with bare skin.
2. Install the system in a level, cool, dry place. Avoid hot and humid areas and do not wet the compressor motor.
3. The speaker is very loud, so keep your ears away from the speaker to prevent damage to your ears.
4. This product is not a toy. Do not allow children to play with or near this item.
5. Before connecting, please confirm the voltage of the battery and alarm host to avoid burning. At the same time, try not to connect other lines on the vehicle to avoid unstable voltage or low current affecting the use of the product.
6. First, connect the horn and the flash lamp, then wrap the wiring with insulating tape, and finally connect the power line.
7. It is recommended that the host be installed in the driver's cab without grounding. It should be turned off when the car stalls. It will affect the start-up of the vehicle and the service life of the host if the host has a long time standby.
8. The horn shall be installed in a position where water is not easy to enter to avoid the shortage of the horn circuit caused by serious wading.
9. Usually, the voltage of cars, vans, and motorcycles is 12V, and the trucks and engineering vehicles are 24V. Please refer to the battery identification for details.

# SAVE THESE INSTRUCTIONS





## PARAMETER LIST

<b>Model</b>	KX-6001				KX-6004	KX-6503
<b>Type</b>	CJB Siren				wireless siren A	wireless siren D
<b>Voltage</b>	DC 12V	DC 12V	DC 12V	DC 12V	DC 12V	DC 12V
<b>Rated Power</b>	200W	200W	100W	200W	200W	400W
<b>Number of channels</b>	7	9	8	8	18	8
<b>Sound Level</b>	125dB	125dB	125dB	125dB	125dB	135dB



## PART LIST

### KX-6001

Name	Picture	QTY
Controller		1
microphone		1
Speaker		1
4-Pin Wiring Harness		1
Lamp control line		1
Host bracket		1
Microphone stand		1
Screw		4
Nut		2
Self-tapping screws		3
Fuse		1
instructions		1

## KX-6004/KX-6503

Name	Picture	QTY
Controller		1
Speaker		KX-6004, 1pcs KX-6503, 2pcs
Remote Control		1
Wiring Harness		1
5-Pin Wiring Harness		1
Charging Cable		1
Cigarette Lighter Plug		1
Screw		4
Fuse		1
instructions		1

# OPERATION

## 1. CJB SIREN

### 1.1 Function introduction

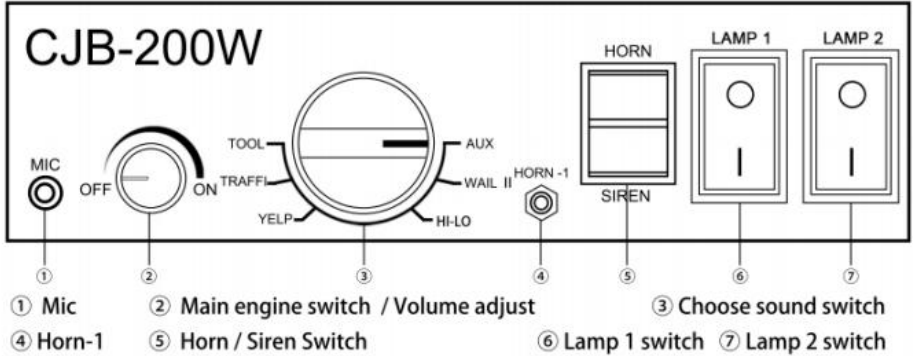

### 1.2 Installation introduction

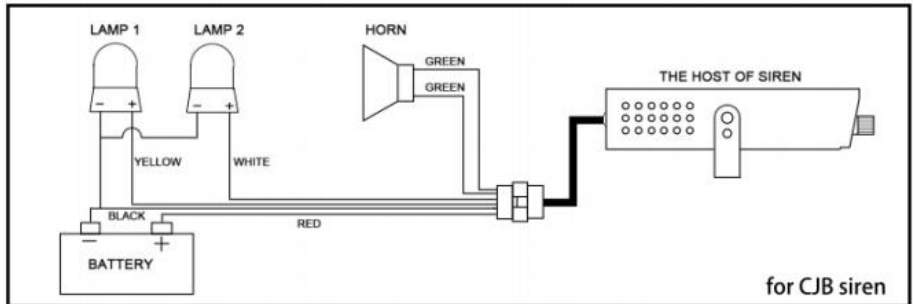

### 1.3 Technology data

Item NO.	Voltage	Sound level	Electrical resistance	Current
CJB 100W	12/24V	≥120dB	8Ω	≤10A
CJB 200W	12/24V	≥125dB	8Ω	≤15A
CJB 400W	12/24V	≥130dB	4Ω	≤20A

## 1.4 Packing list

NO.	NAME	QTY	UNIT	
1	The host of siren	1	PCS	
2	Speaker	100W 8Q	1	PCS
		200W 8Ω	1	PCS
		400W 4Ω	1	PCS
3	Connect line groupware	1	PCS	
4	Bolt, screw cap,f use, etc	1	PCS	
5	Instructions	1	Sheet	





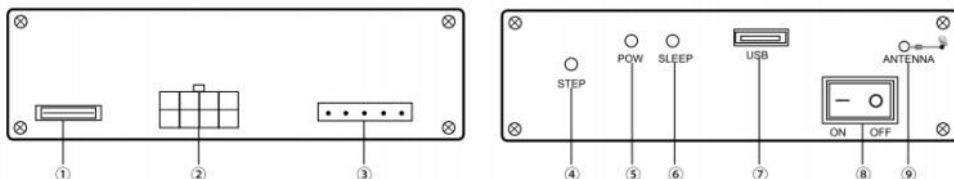

## 2.WIRELESS SIREN

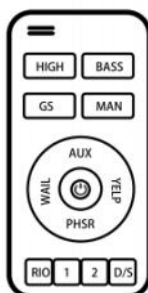
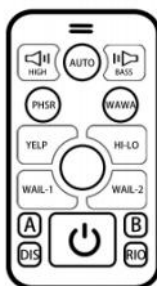
### 2.1 Function introduction



- ① Fuse      ② Socket for the wire harness of horn      ③ Socket for alarm lamp      ④ Step  
 ⑤ Pow (red light)      ⑥ Sleep (green light)      ⑦ USB      ⑧ ON/OFF switch      ⑨ Antenna



- 1). Press the ON/OFF switch on the host, then  (green light) light.
- 2). Press the  key on the remote control to turn on the remote control, the backlight is always on, when you press any other key,  (red light) on the host will flicker. and then press  and hold to turn off.
- 3). Press the whistle key (SIREN HORN / HIGH BASS) to make the whistle sound, release then stop. After  reverberation, the whistle will become bass.
- 4). Press the alarm key, it will alarm continuously and press the  key to stop.
- 5). Press the  key to turn the alarm tone into bass.
- 6). Lamp control 1 (or A) and lamp control 2 (or B) control two ways of lamp. Press once to turn on and then press once to turn off.
- 7). Press the button on the left side of the remote control, and you can speak.

## 2.2 Installation introduction

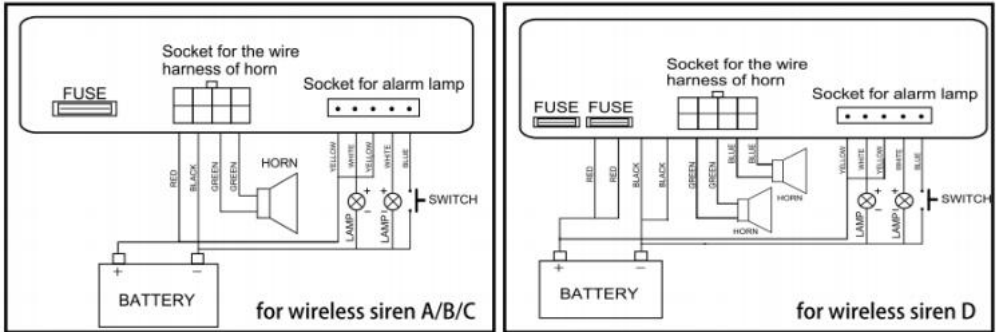

## 2.3 Technology data

Item NO	Package	Power	Voltage	Sound level	Resistance	Current
Wireless siren A	1siren+ 1horn	200W	12V	125dB	8 Ω	≤ 15A
Wireless siren B	1siren+ 1horn	200W	12V	128dB	80	≤ 20A
Wireless siren C	1siren+ 1horn	400W	12V	130dB	40	≤ 25A
Wireless siren D	1siren+ 2horn	400W	12V	135dB	4 Ω	≤ 25A

# CORRECT DISPOSAL



This product is subject to the provisions of European Directive 2012/19/EU. The symbol showing a wheeled bin crossed through indicates that the product requires separate refuse collection in the European Union. This applies to the product and all accessories marked with this symbol. Products marked as such may not be discarded with normal domestic waste, but must be taken to a collection point for recycling electrical and electronic devices.

**Manufacturer:** Shanghai muxin muyeyouxiangongsi

**Address:** Shuangchenglu 803nong11hao1602A-1609shi, baoshanqu, shanghai 200000 CN.

**Imported to AUS:** SIHAO PTY LTD. 1 ROKEVA STREET EASTWOOD NSW 2122 Australia

**Imported to USA:** Sanven Technology Ltd. Suite 250, 9166 Anaheim Place, Rancho Cucamonga, CA 91730

<b>UK</b>	<b>REP</b>
-----------	------------

YH CONSULTING LIMITED.  
C/O YH Consulting Limited Office 147,  
Centurion House, London Road,  
Staines-upon-Thames, Surrey, TW18 4AX

<b>EC</b>	<b>REP</b>
-----------	------------

E-CrossStu GmbH  
Mainzer Landstr.69,  
60329 Frankfurt am Main.

**Made in china**



**VEVOR<sup>®</sup>**

**TOUGH TOOLS, HALF PRICE**

**Technical Support and E-Warranty Certificate**

**[www.vevor.com/support](http://www.vevor.com/support)**



# VEVOR<sup>®</sup>

## TOUGH TOOLS, HALF PRICE

Assistance technique et certificat de garantie électronique [www.vevor.com/support](http://www.vevor.com/support)

### SIRÈNE HAUTE PUISSANCE

MODÈLE : KX-6001/KX-6004/KX-6503

Nous continuons à nous engager à vous fournir des outils à des prix compétitifs.

« Économisez la moitié », « Moitié prix » ou toute autre expression similaire utilisée par nous ne représente qu'une estimation des économies que vous pourriez réaliser en achetant certains outils chez nous par rapport aux grandes marques et ne couvre pas nécessairement toutes les catégories d'outils que nous proposons. Nous vous rappelons de bien vouloir vérifier soigneusement lorsque vous passez une commande chez nous si vous économisez réellement la moitié par rapport aux grandes marques.

# VEVOR<sup>®</sup>

TOUGH TOOLS, HALF PRICE

## SIRÈNE HAUTE PUISSANCE

MODÈLE : KX-6001/KX-6004/KX-6503



**BESOIN D'AIDE? CONTACTEZ-NOUS!**

Vous avez des questions sur nos produits ? Vous avez besoin d'assistance technique ?  
N'hésitez pas

à nous contacter : Assistance technique et certificat de garantie  
électronique [www.vevor.com/support](http://www.vevor.com/support)

Il s'agit de la notice d'utilisation d'origine. Veuillez lire attentivement toutes les instructions du manuel avant de l'utiliser. VEVOR se réserve le droit d'interpréter clairement notre manuel d'utilisation. L'apparence du produit dépend du produit que vous avez reçu. Veuillez nous excuser, nous ne vous informerons plus en cas de mise à jour technologique ou logicielle de notre produit.

## MESURES DE SÉCURITÉ IMPORTANTES

**AVERTISSEMENT** : Lisez ces instructions avant d'utiliser ce produit. Le non-respect de ces instructions peut entraîner des blessures graves. Respectez toujours les règles de sécurité.

1. La température du compresseur peut être très élevée pendant le fonctionnement ou après son arrêt. s'est arrêté, ne le touchez donc pas avec la peau nue.
2. Installez le système dans un endroit plat, frais et sec. Évitez les zones chaudes et humides et ne ne pas mouiller le moteur du compresseur.
3. Le haut-parleur est très fort, alors gardez vos oreilles loin du haut-parleur pour éviter dommages à vos oreilles.
4. Ce produit n'est pas un jouet. Ne laissez pas les enfants jouer avec ou à proximité de cet article.
5. Avant de connecter, veuillez confirmer la tension de la batterie et de l'hôte d'alarme pour éviter de brûler. En même temps, essayez de ne pas connecter d'autres lignes du véhicule à éviter une tension instable ou un courant faible affectant l'utilisation du produit.
6. Connectez d'abord le klaxon et la lampe flash, puis enveloppez le câblage avec de l'isolant. ruban adhésif et enfin connecter la ligne électrique.
7. Il est recommandé que l'hôte soit installé dans la cabine du conducteur sans mise à la terre. Il doit être éteint lorsque la voiture cale. Cela affectera le démarrage de le véhicule et la durée de vie de l'hôte si ce dernier dispose d'une longue période de veille.
8. Le klaxon doit être installé dans un endroit où l'eau ne peut pas facilement pénétrer. éviter la panne du circuit du klaxon provoquée par un passage à gué important.
9. Habituellement, la tension des voitures, des camionnettes et des motos est de 12 V, et celle des camions et Les véhicules d'ingénierie sont de 24 V. Veuillez vous référer à l'identification de la batterie pour plus de détails.

## CONSERVEZ CES INSTRUCTIONS

## LISTE DES PARAMÈTRES



Modèle	KX-6001				KX-6004	KX-6503
Taper	Sirène CJB				sans fil sirène A	sirène sans fil D
Tension CC	12 V CC	12 V CC	12 V CC	12 V CC		12 V CC
Noté Pouvoir	200 W	200 W	100 W	200 W	200 W	400W
Nombre de chaînes	7	9	8	8	18	8
Son Niveau	125 dB	125 dB	125 dB	125 dB	125 dB	135 dB

## LISTE DES PIÈCES

## KX-6001

Nom	Image	Qté
Contrôleur		1
microphone		1
Conférencier	 ou	1
Faisceau de câbles à 4 broches		1
Ligne de contrôle de la lampe		1
Support d'accueil		1
Pied de micro		1
Vis		4
Noix		2
Vis autotaraudeuses		3
Fusible		1
instructions		1

## KX-6004/KX-6503

Nom	Image	Qté
Contrôleur		1
Conférencier		KX-6004, 1 pièce KX-6503, 2 pièces
Télécommande Contrôle		1
Câblage Harnais		1
Câblage à 5 broches Harnais		1
Chargement Câble		1
Cigarette Prise allume-cigare		1
Vis		4
Fusible		1
instructions		1

## OPÉRATION

## 1. CJB SIREN

## 1.1 Function introduction

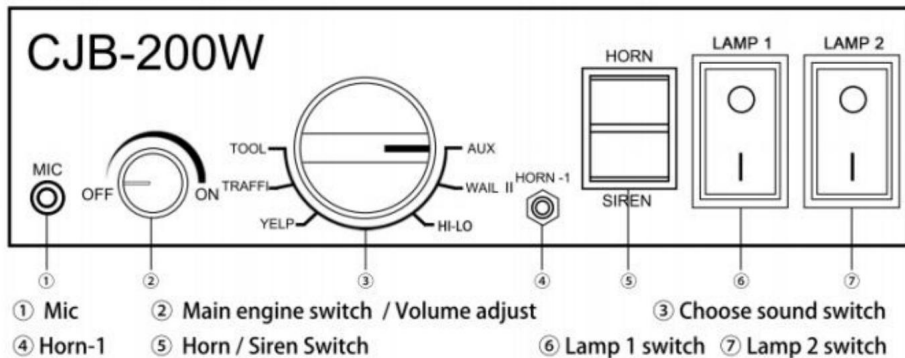

## 1.2 Installation introduction

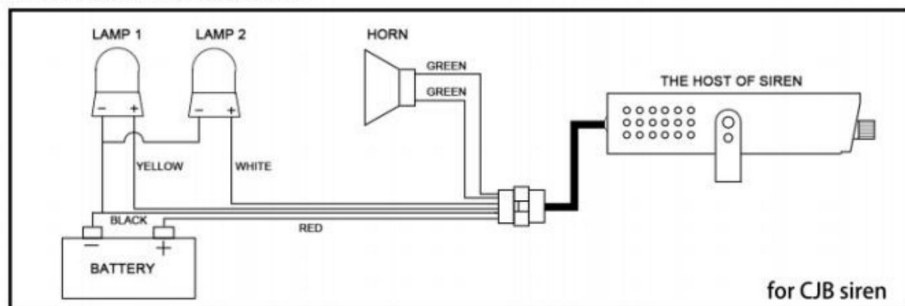

## 1.3 Données technologiques

Article n°	Tension	Niveau sonore	Résistance électrique	Courant
CJB 100 W	12/24 V	$\geq 120$ dB	8 heures	$\leq 10$ A
CJB 200 W	12/24 V	$\geq 125$ dB	8 heures	$\leq 15$ A
CJB 400W	12/24V	$\geq 130$ dB	4 $\Omega$	$\leq 20$ A

## 1.4 Liste de colisage

NON.	NOM	Qté	UNITÉ	
1	L'hôte des sirènes	1	PC	
2	Conférencier	100 W 8 Q	1	PC
		200W 8Ω	1	PC
		400W 4Ω	1	PC
3	Connecter le groupware en ligne	1	PC	
4	Boulon, bouchon à vis, utilisation f, etc.	1	PC	
5	Instructions	1	Feuille	

## 2.WIRELESS SIREN



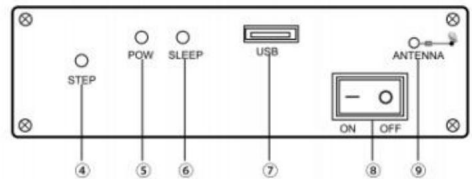
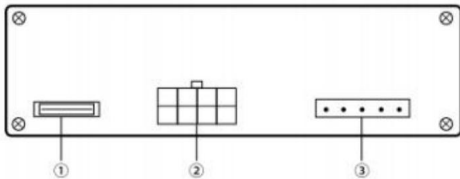

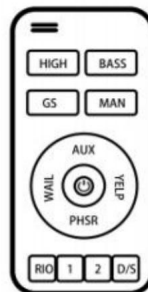
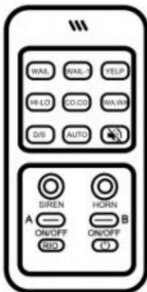

## 2.1 Function introduction



- ① Fuse    ② Socket for the wire harness of horn    ③ Socket for alarm lamp    ④ Step  
 ⑤ Pow (red light)    ⑥ Sleep (green light)    ⑦ USB    ⑧ ON/OFF switch    ⑨ Antenna





- 1). Press the ON/OFF switch on the host, then  (green light) light.
- 2). Press the  key on the remote control to turn on the remote control, the backlight is always on, when you press any other key,  (red light) on the host will flicker. and then press  and hold to turn off.
- 3). Press the whistle key (SIREN HORN / HIGH BASS) to make the whistle sound, release then stop. After  reverberation, the whistle will become bass.
- 4). Press the alarm key, it will alarm continuously and press the  key to stop.
- 5). Press the  key to turn the alarm tone into bass.
- 6). Lamp control 1 (or A) and lamp control 2 (or B) control two ways of lamp. Press once to turn on and then press once to turn off.
- 7). Press the button on the left side of the remote control, and you can speak.

## 2.2 Installation introduction

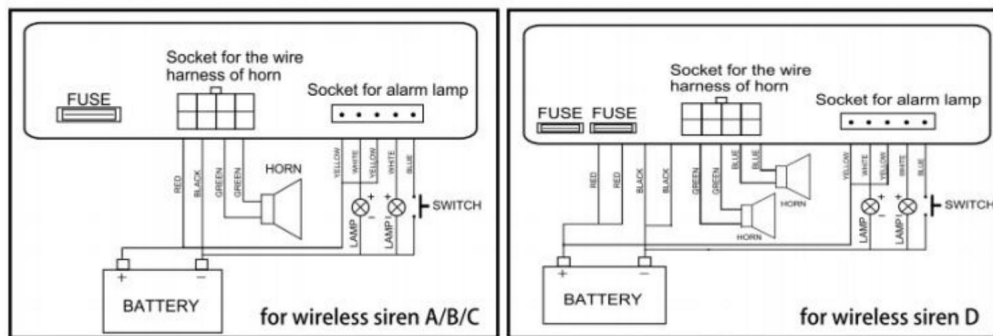

## 2.3 Données technologiques

Article N°	Paquet	Tension d'alimentation		Son niveau	Courant de résistance	
Sans fil sirène A	1 sirène+ 1 corne	200 W	12V	125 dB	8 heures	≤15A
Sans fil Sirène B	1 sirène+ 1 corne	200 W	12V	128d8	80	≤20A
Sans fil sirène C	1 sirène+ 1 corne	400W	12V	130 dB	40	≤25A
Sans fil Monsieur D.	1 sirène+ 2 cornes	400W	12V	135d8	4 Ω	≤25A

## ÉLIMINATION CORRECTE



Ce produit est soumis aux dispositions de la directive européenne 2012/19/UE. Le symbole représentant une poubelle à roulettes barrée indique que le produit nécessite une collecte séparée des déchets dans le Union européenne. Ceci s'applique au produit et à tous les accessoires marqués de ce symbole. Les produits marqués comme tels ne peuvent pas être jeté avec les ordures ménagères normales, mais doit être apporté dans un point de collecte pour le recyclage des appareils électriques et électroniques.

Fabricant : Shanghaimuxinmuyeyouxiangongsi

Adresse : Shuangchenglu 803nong11hao1602A-1609shi, baoshanqu, shanghai 200000 CN.

Importé en Australie : SIHAO PTY LTD. 1 ROKEVA STREETEASTWOOD NSW 2122 Australie

Importé aux États-Unis : Sanven Technology Ltd. Suite 250, 9166 Anaheim Lieu, Rancho Cucamonga, CA 91730



YH CONSULTING LIMITÉE.

A/S YH Consulting Limited Bureau 147,  
Centurion House, London Road, Staines-  
upon-Thames, Surrey, TW18 4AX



E-CrossStu GmbH

Mainzer Landstr.69,  
60329 Francfort-sur-le-Main.

Fabriqué en Chine



**VEVOR<sup>®</sup>**

**TOUGH TOOLS, HALF PRICE**

Assistance technique et certificat de garantie  
électronique [www.vevor.com/support](http://www.vevor.com/support)

# **VEVOR<sup>®</sup>**

## **TOUGH TOOLS, HALF PRICE**

Supporto tecnico e certificato di garanzia elettronica [www.vevor.com/support](http://www.vevor.com/support)

### **SIRENA AD ALTA POTENZA**

**MODELLO: KX-6001/KX-6004/KX-6503**

Continuiamo a impegnarci per fornirvi strumenti a prezzi competitivi.

"Risparmia la metà", "Metà prezzo" o qualsiasi altra espressione simile da noi utilizzata rappresenta solo una stima del risparmio che potresti ottenere acquistando determinati utensili con noi rispetto ai principali marchi principali e non significa necessariamente coprire tutte le categorie di utensili da noi offerti. Ti ricordiamo gentilmente di verificare attentamente quando effettui un ordine con noi se stai effettivamente risparmiando la metà rispetto ai principali marchi principali.

# VEVOR<sup>®</sup>

TOUGH TOOLS, HALF PRICE

## SIRENA AD ALTA POTENZA

MODELLO: KX-6001/KX-6004/KX-6503



### HAI BISOGNO DI AIUTO? CONTATTACI!

Hai domande sul prodotto? Hai bisogno di supporto tecnico? Non esitare a contattarci:

**Supporto**

**tecnico e certificato di garanzia elettronica [www.vevor.com/  
support](http://www.vevor.com/support)**

Questa è l'istruzione originale, si prega di leggere attentamente tutte le istruzioni del manuale prima di utilizzare. VEVOR si riserva una chiara interpretazione del nostro manuale utente. L'aspetto del prodotto sarà soggetto al prodotto ricevuto. Vi preghiamo di perdonarci se non vi informeremo di nuovo se ci sono aggiornamenti tecnologici o software sul nostro prodotto.

## **IMPORTANTI MISURE DI SICUREZZA**

**ATTENZIONE:** leggere queste istruzioni prima di utilizzare il prodotto. La mancata osservanza di queste istruzioni può causare gravi lesioni. Osservare sempre le regole di funzionamento sicuro.

1. La temperatura del compressore può essere molto elevata durante il funzionamento o dopo si è fermato, quindi non toccarlo con la pelle nuda.
2. Installare il sistema in un luogo piano, fresco e asciutto. Evitare aree calde e umide e non bagnare il motore del compressore.
3. L'altoparlante è molto rumoroso, quindi tieni le orecchie lontane dall'altoparlante per evitare danni alle orecchie.
4. Questo prodotto non è un giocattolo. Non permettere ai bambini di giocare con o vicino a questo articolo.
5. Prima di effettuare il collegamento, confermare la tensione della batteria e dell'host di allarme evitare di bruciare. Allo stesso tempo, cercare di non collegare altre linee sul veicolo a evitare che tensioni instabili o correnti basse possano compromettere l'uso del prodotto.
6. Per prima cosa, collega il clacson e la lampada flash, quindi avvolgi il cablaggio con materiale isolante nastro adesivo e infine collegare la linea elettrica.
7. Si consiglia di installare l'host nella cabina di guida senza messa a terra. Dovrebbe essere spento quando l'auto si spegne. Influirà sull'avvio di il veicolo e la durata utile dell'host se l'host ha una modalità standby di lunga durata.
8. Il corno deve essere installato in una posizione in cui l'acqua non possa entrare facilmente. evitare la mancanza del circuito del clacson causata da guadi intensi.
9. Di solito, la tensione delle auto, dei furgoni e delle motociclette è di 12 V, mentre quella dei camion e i veicoli di ingegneria sono a 24 V. Per i dettagli, fare riferimento all'identificazione della batteria.

## **SALVA QUESTE ISTRUZIONI**

## ELENCO PARAMETRI

<b>Modello</b>	Modello KX-6001				Modello KX-6004	Modello KX-6503
<b>Tipo</b>	Sirena CJB				senza fili sirena A	sirena senza fili D
<b>Tensione</b>	DC 12V	DC 12V	DC 12V	DC 12V		Corrente continua 12V
<b>Valutata Energia</b>	200W	200W	100W	200W	200W	400W
<b>Numero di canali</b>	7	9	8	8	18	8
<b>Suono Livello</b>	125 dB	125 dB	125 dB	125 dB	125 dB	135 dB



## ELENCO DEI PEZZI

Modello KX-6001

Nome	Immagine	Quantità
Controllore		1
microfono		1
Oratore		1
Cablaggio a 4 pin		1
Linea di controllo della lampada		1
Staffa host		1
Supporto per microfono		1
Vite		4
Noce		2
Viti autofilettanti		3
Fusibile		1
istruzioni		1

**KX-6004/KX-6503**

Nome	Immagine	Quantità
Controllore		1
Oratore		KX-6004, 1 pz. KX-6503, 2 pezzi
Remoto Controllare		1
Cablaggio Imbracatura		1
Cablaggio a 5 pin Imbracatura		1
Ricarica Cavo		1
Sigaretta Presa accendisigari		1
Vite		4
Fusibile		1
istruzioni		1

## OPERAZIONE

# 1. CJB SIREN

## 1.1 Function introduction

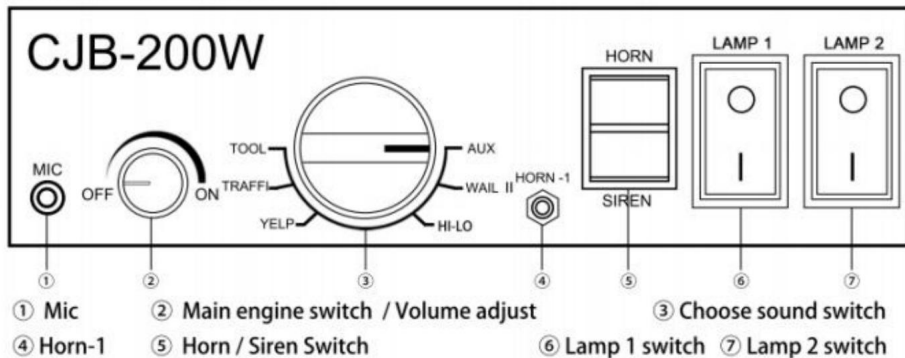

## 1.2 Installation introduction

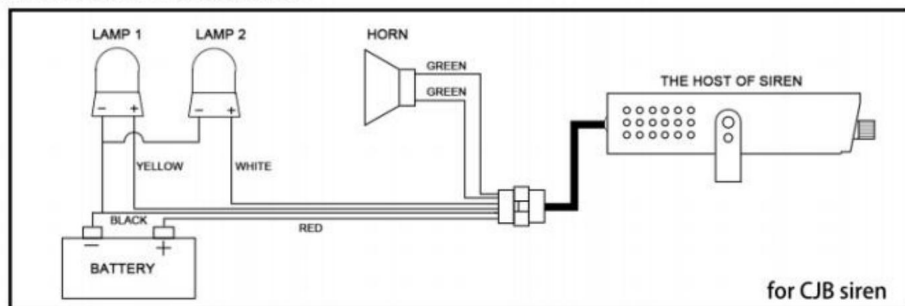

## 1.3 Dati tecnologici

Item N.	Tensione	Livello sonoro	Resistenza elettrica	Corrente
Alimentatore CJB	100W 12/24V	120dB	8 in punto	10A
CJB 200W	12/24V	125dB	8 in punto	15A
CJB 400W	12/24V	130dB	4 ÷	20A





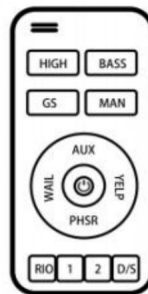
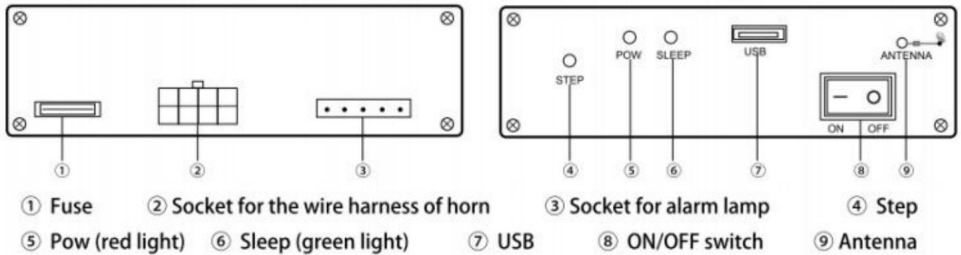

## 1.4 Elenco di imballaggio

NO.	NOME	Quantità	UNITÀ
1	L'ospite della sirena	1	PZ
2	Oratore	100W 8Q	PZ
		200W 8ÿ	PZ
		400W 4ÿ	PZ
3	Connetti la linea groupware	1	PZ
4	Bullone, tappo a vite, uso, ecc.	1	PZ
5	Istruzioni	1	Foglio

## 2.WIRELESS SIREN

## 2.1 Function introduction



- 1). Press the ON/OFF switch on the host, then  (green light) light.
- 2). Press the  key on the remote control to turn on the remote control, the backlight is always on, when you press any other key,  (red light) on the host will flicker. and then press  and hold to turn off.
- 3). Press the whistle key (SIREN HORN / HIGH BASS) to make the whistle sound, release then stop. After  reverberation, the whistle will become bass.
- 4). Press the alarm key, it will alarm continuously and press the  key to stop.
- 5). Press the  key to turn the alarm tone into bass.
- 6). Lamp control 1 (or A) and lamp control 2 (or B) control two ways of lamp. Press once to turn on and then press once to turn off.
- 7). Press the button on the left side of the remote control, and you can speak.

## 2.2 Installation introduction

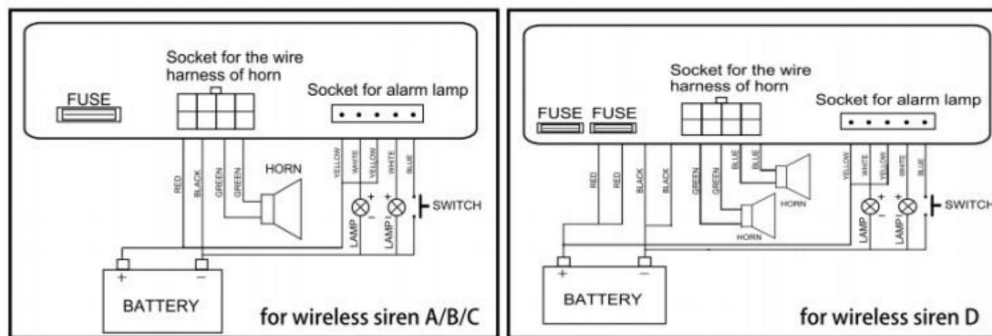

## 2.3 Dati tecnologici

Articolo N.	Confezione	Potenza	Tensione	Suono livello	Resistenza Corrente	
Senza fili sirena A	1 sirena+ 1 corno	200W	12V	125 dB	8 in punto	ÿ15A
Senza fili Sirena B	1 sirena+ 1 corno	200W	12V	128d8	80	ÿ20A
Senza fili sirena C	1 sirena+ 1 corno	400W	12V	130 dB	40	ÿ25A
Senza fili Signore D	1 sirena+ 2 corna	400W	12V	135d8	4 ÿ	ÿ25A

## SMALTIMENTO CORRETTO



Questo prodotto è soggetto alle disposizioni della Direttiva Europea 2012/19/UE. Il simbolo raffigurante un bidone della spazzatura barrato indica che il prodotto richiede una raccolta differenziata dei rifiuti Unione Europea. Ciò si applica al prodotto e a tutti gli accessori contrassegnati con questo simbolo. I prodotti contrassegnati come tali non possono essere smaltiti insieme ai normali rifiuti domestici, ma deve essere portato in un punto di raccolta per il riciclaggio di apparecchiature elettriche ed elettroniche.

**Produttore:** Shanghai muxinmuyeyouxiangongsi

**Indirizzo:** Shuangchenglu 803nong11hao1602A-1609shi, baoshanqu, shanghai 200000 CN.

**Importato in AUS:** SIHAO PTY LTD. 1 ROKEVA STREET EASTWOOD

Nuovo Galles del Sud 2122 Australia

**Importato negli USA:** Sanven Technology Ltd. Suite 250, 9166 Anaheim Luogo, Rancho Cucamonga, CA 91730



CONSULENZA YH LIMITATA.

C/O YH Consulting Limited Ufficio 147,  
Centurion House, London Road,  
Staines-upon-Thames, Surrey, TW18 4AX

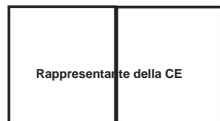

E-CrossStu GmbH

Mainzer Landstr.69,  
60329 Francoforte sul Meno.

**Made in China**



**VEVOR<sup>®</sup>**

**TOUGH TOOLS, HALF PRICE**

**Supporto tecnico e certificato di garanzia  
elettronica [www.vevor.com/support](http://www.vevor.com/support)**



# **VEVOR<sup>®</sup>**

## **TOUGH TOOLS, HALF PRICE**

Supporto tecnico e certificato di garanzia elettronica [www.vevor.com/support](http://www.vevor.com/support)

### **SIRENA AD ALTA POTENZA**

**MODELLO: KX-6001/KX-6004/KX-6503**

Continuiamo a impegnarci per fornirvi strumenti a prezzi competitivi.

"Risparmia la metà", "Metà prezzo" o qualsiasi altra espressione simile da noi utilizzata rappresenta solo una stima del risparmio che potresti ottenere acquistando determinati utensili con noi rispetto ai principali marchi principali e non significa necessariamente coprire tutte le categorie di utensili da noi offerti. Ti ricordiamo gentilmente di verificare attentamente quando effettui un ordine con noi se stai effettivamente risparmiando la metà rispetto ai principali marchi principali.

**VEVOR**<sup>®</sup>  
TOUGH TOOLS, HALF PRICE

**SIRENA AD ALTA POTENZA**

**MODELLO: KX-6001/KX-6004/KX-6503**



**HAI BISOGNO DI AIUTO? CONTATTACI!**

Hai domande sul prodotto? Hai bisogno di supporto tecnico? Non esitare a contattarci:

**Supporto**

**tecnico e certificato di garanzia elettronica [www.vevor.com/  
support](http://www.vevor.com/support)**

Questa è l'istruzione originale, si prega di leggere attentamente tutte le istruzioni del manuale prima di utilizzare. VEVOR si riserva una chiara interpretazione del nostro manuale utente. L'aspetto del prodotto sarà soggetto al prodotto ricevuto. Vi preghiamo di perdonarci se non vi informeremo di nuovo se ci sono aggiornamenti tecnologici o software sul nostro prodotto.

## IMPORTANTI MISURE DI SICUREZZA

**ATTENZIONE:** leggere queste istruzioni prima di utilizzare il prodotto. La mancata osservanza di queste istruzioni può causare gravi lesioni. Osservare sempre le regole di funzionamento sicuro.

1. La temperatura del compressore può essere molto elevata durante il funzionamento o dopo si è fermato, quindi non toccarlo con la pelle nuda.
2. Installare il sistema in un luogo piano, fresco e asciutto. Evitare aree calde e umide e non bagnare il motore del compressore.
3. L'altoparlante è molto rumoroso, quindi tieni le orecchie lontane dall'altoparlante per evitare danni alle orecchie.
4. Questo prodotto non è un giocattolo. Non permettere ai bambini di giocare con o vicino a questo articolo.
5. Prima di effettuare il collegamento, confermare la tensione della batteria e dell'host di allarme evitare di bruciare. Allo stesso tempo, cercare di non collegare altre linee sul veicolo a evitare che tensioni instabili o correnti basse possano compromettere l'uso del prodotto.
6. Per prima cosa, collega il clacson e la lampada flash, quindi avvolgi il cablaggio con materiale isolante nastro adesivo e infine collegare la linea elettrica.
7. Si consiglia di installare l'host nella cabina di guida senza messa a terra. Dovrebbe essere spento quando l'auto si spegne. Influirà sull'avvio di il veicolo e la durata utile dell'host se l'host ha una modalità standby di lunga durata.
8. Il corno deve essere installato in una posizione in cui l'acqua non possa entrare facilmente. evitare la mancanza del circuito del clacson causata da guadi intensi.
9. Di solito, la tensione delle auto, dei furgoni e delle motociclette è di 12 V, mentre quella dei camion e i veicoli di ingegneria sono a 24 V. Per i dettagli, fare riferimento all'identificazione della batteria.

## SALVA QUESTE ISTRUZIONI

## ELENCO PARAMETRI

<b>Modello</b>	Modello KX-6001				Modello KX-6004	Modello KX-6503
<b>Tipo</b>	Sirena CJB				senza fili sirena A	sirena senza fili D
<b>Tensione</b>	DC 12V	DC 12V	DC 12V	DC 12V		Corrente continua 12V
<b>Valutata Energia</b>	200W	200W	100W	200W	200W	400W
<b>Numero di canali</b>	7	9	8	8	18	8
<b>Suono Livello</b>	125 dB	125 dB	125 dB	125 dB	125 dB	135 dB

## ELENCO DEI PEZZI

Modello KX-6001

Nome	Immagine	Quantità
Controllore		1
microfono		1
Oratore		1
Cablaggio a 4 pin		1
Linea di controllo della lampada		1
Staffa host		1
Supporto per microfono		1
Vite		4
Noce		2
Viti autofilettanti		3
Fusibile		1
istruzioni		1

**KX-6004/KX-6503**

Nome	Immagine	Quantità
Controllore		1
Oratore		KX-6004, 1 pz. KX-6503, 2 pezzi
Remoto Controllare		1
Cablaggio Imbracatura		1
Cablaggio a 5 pin Imbracatura		1
Ricarica Cavo		1
Sigaretta Presa accendisigari		1
Vite		4
Fusibile		1
Istruzioni		1

## OPERAZIONE

# 1. CJB SIREN

## 1.1 Function introduction

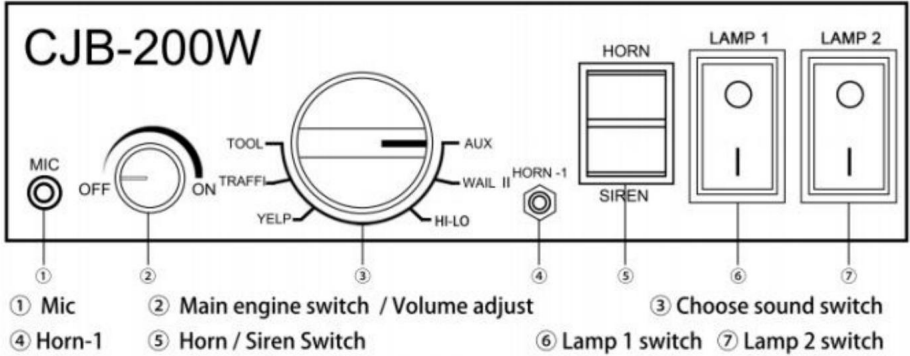

## 1.2 Installation introduction

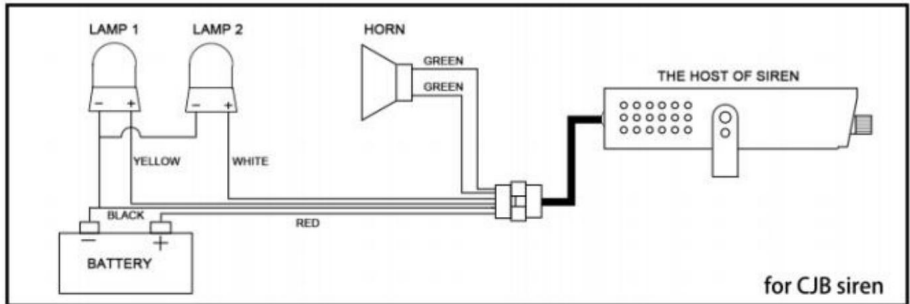

## 1.3 Dati tecnologici

Item N.	Tensione	Livello sonoro	Resistenza elettrica	Corrente
Alimentatore CJB	100W 12/24V	120dB	8 in punto	10A
CJB 200W	12/24V	125dB	8 in punto	15A
CJB 400W	12/24V	130dB	4 ÷	20A

## 1.4 Elenco di imballaggio





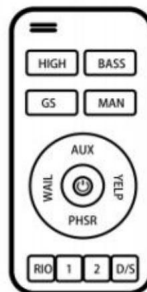
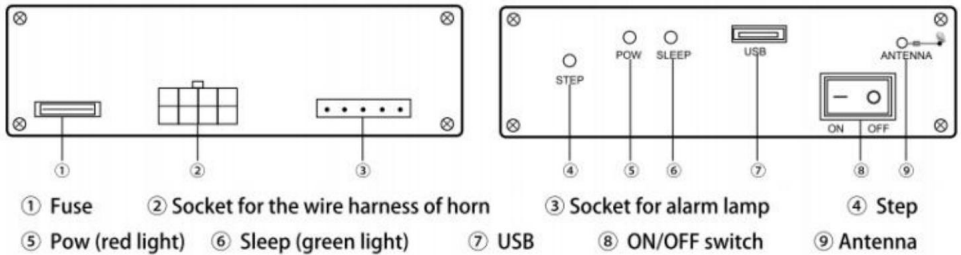

NO.	NOME	Quantità	UNITÀ
1	L'ospite della sirena	1	PZ
2	Oratore	100W 8Q	PZ
		200W 8ÿ	PZ
		400W 4ÿ	PZ
3	Connetti la linea groupware	1	PZ
4	Bullone, tappo a vite, uso, ecc.	1	PZ
5	Istruzioni	1	Foglio

## 2.WIRELESS SIREN

## 2.1 Function introduction





- 1). Press the ON/OFF switch on the host, then  (green light) light.
- 2). Press the  key on the remote control to turn on the remote control, the back-light is always on, when you press any other key,  (red light) on the host will flicker. and then press  and hold to turn off.
- 3). Press the whistle key (SIREN HORN / HIGH BASS) to make the whistle sound, release then stop. After  reverberation, the whistle will become bass.
- 4). Press the alarm key, it will alarm continuously and press the  key to stop.
- 5). Press the  key to turn the alarm tone into bass.
- 6). Lamp control 1 (or A) and lamp control 2 (or B) control two ways of lamp. Press once to turn on and then press once to turn off.
- 7). Press the button on the left side of the remote control, and you can speak.

## 2.2 Installation introduction

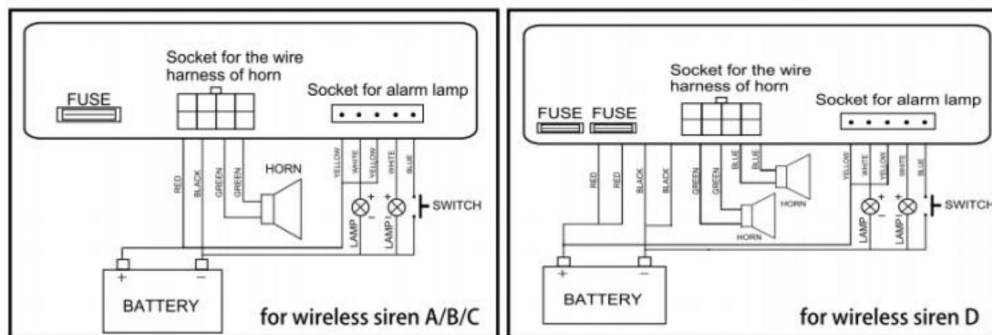

## 2.3 Dati tecnologici

Articolo N.	Confezione	Potenza	Tensione	Suono livello	Resistenza Corrente	
Senza fili sirena A	1 sirena+ 1 corno	200W	12V	125 dB	8 in punto	ÿ15A
Senza fili Sirena B	1 sirena+ 1 corno	200W	12V	128d8	80	ÿ20A
Senza fili sirena C	1 sirena+ 1 corno	400W	12V	130 dB	40	ÿ25A
Senza fili Signore D	1 sirena+ 2 corna	400W	12V	135d8	4 ÿ	ÿ25A

## SMALTIMENTO CORRETTO



Questo prodotto è soggetto alle disposizioni della Direttiva Europea 2012/19/UE. Il simbolo raffigurante un bidone della spazzatura barrato indica che il prodotto richiede una raccolta differenziata dei rifiuti Unione Europea. Ciò si applica al prodotto e a tutti gli accessori contrassegnati con questo simbolo. I prodotti contrassegnati come tali non possono essere smaltiti insieme ai normali rifiuti domestici, ma deve essere portato in un punto di raccolta per il riciclaggio di apparecchiature elettriche ed elettroniche.

**Produttore:** Shanghai muxinmuyeyouxiangongsi

**Indirizzo:** Shuangchenglu 803nong11hao1602A-1609shi, baoshanqu, shanghai 200000 CN.

**Importato in AUS:** SIHAO PTY LTD. 1 ROKEVA STREET EASTWOOD

Nuovo Galles del Sud 2122 Australia

**Importato negli USA:** Sanven Technology Ltd. Suite 250, 9166 Anaheim Luogo, Rancho Cucamonga, CA 91730



CONSULENZA YH LIMITATA.

C/O YH Consulting Limited Ufficio 147,  
Centurion House, London Road,  
Staines-upon-Thames, Surrey, TW18 4AX

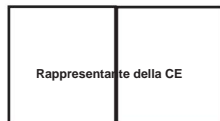

E-CrossStu GmbH

Mainzer Landstr.69,  
60329 Francoforte sul Meno.

**Made in China**



**VEVOR<sup>®</sup>**

**TOUGH TOOLS, HALF PRICE**

**Supporto tecnico e certificato di garanzia  
elettronica [www.vevor.com/support](http://www.vevor.com/support)**

# **VEVOR<sup>®</sup>**

## **TOUGH TOOLS, HALF PRICE**

Soporte técnico y certificado de garantía electrónica [www.vevor.com/support](http://www.vevor.com/support)

### **SIRENA DE ALTA POTENCIA**

**MODELO: KX-6001/KX-6004/KX-6503**

Seguimos comprometidos a brindarle herramientas a precios competitivos.

"Ahorre la mitad", "mitad de precio" o cualquier otra expresión similar que utilicemos solo representa una estimación del ahorro que podría obtener al comprar ciertas herramientas con nosotros en comparación con las principales marcas y no necesariamente significa que cubra todas las categorías de herramientas que ofrecemos. Le recordamos que, al realizar un pedido con nosotros, verifique cuidadosamente si realmente está ahorrando la mitad en comparación con las principales marcas.

# VEVOR<sup>®</sup>

TOUGH TOOLS, HALF PRICE

## SIRENA DE ALTA POTENCIA

MODELO: KX-6001/KX-6004/KX-6503



¿NECESITA AYUDA? ¡CONTÁCTENOS!

¿Tiene preguntas sobre el producto? ¿Necesita asistencia técnica? No dude en ponerse en contacto con

nosotros: Asistencia técnica y certificado de garantía electrónica  
[www.vevor.com/support](http://www.vevor.com/support)

Estas son las instrucciones originales, lea atentamente todas las instrucciones del manual antes de utilizar el producto. VEVOR se reserva una interpretación clara de nuestro manual de usuario. La apariencia del producto estará sujeta al producto que recibió. Perdónenos por no informarle nuevamente si hay actualizaciones de tecnología o software en nuestro producto.

## PRECAUCIONES IMPORTANTES

ADVERTENCIA: Lea estas instrucciones antes de utilizar este producto. El incumplimiento de estas instrucciones puede provocar daños.

Puede provocar lesiones graves. Respete siempre las normas de seguridad.

1. La temperatura del compresor puede ser muy alta durante el funcionamiento o después de él. se ha detenido, así que no lo toques con la piel desnuda.
2. Instale el sistema en un lugar nivelado, fresco y seco. Evite las zonas cálidas y húmedas y no No moje el motor del compresor.
3. El altavoz es muy ruidoso, por lo que debe mantener los oídos alejados del altavoz para evitar Daño a los oídos.
4. Este producto no es un juguete. No permita que los niños jueguen con este artículo ni cerca de él.
5. Antes de conectar, confirme el voltaje de la batería y el host de alarma. Evite quemarse. Al mismo tiempo, trate de no conectar otras líneas del vehículo a Evite voltaje inestable o baja corriente que afecte el uso del producto.
6. Primero, conecte la bocina y la lámpara de destello, luego envuelva el cableado con material aislante. cinta y finalmente conectar la línea eléctrica.
7. Se recomienda que el host se instale en la cabina del conductor sin puesta a tierra. Debe apagarse cuando el automóvil se detiene. Afecta el arranque del motor. el vehículo y la vida útil del host si este está en espera durante un largo tiempo.
8. La bocina se debe instalar en una posición donde no sea fácil que entre agua. evitar la escasez del circuito de bocina causada por vadeo severo.
9. Por lo general, el voltaje de los automóviles, furgonetas y motocicletas es de 12 V, y el de los camiones y Los vehículos de ingeniería funcionan con 24 V. Consulte la identificación de la batería para obtener más detalles.

## GUARDE ESTAS INSTRUCCIONES

## LISTA DE PARÁMETROS

Modelo	KX-6001				KX-6004	KX-6503
Tipo	Sirena CJB				inalámbrico sirena A	sirena inalámbrica D
Voltaje CC	12 V CC	12 V CC	12 V CC	12 V CC		12 V CC
Calificado Fuerza	200 W	200 W	100 W	200 W	200 W	400W
Número de canales	7	9	8	8	18	8
Sonido Nivel	125dB	125dB	125dB	125dB	125 dB	135 dB



## LISTA DE PIEZAS

## KX-6001

Nombre	Imagen	CANTIDAD
Controlador		1
micrófono		1
Vocero		1
Arnés de cableado de 4 pines		1
Línea de control de lámparas		1
Soporte de anfitrión		1
Soporte de micrófono		1
Tornillo		4
Tuerca		2
Tornillos autorroscantes		3
Fusible		1
instrucciones		1

## KX-6004/KX-6503

Nombre	Imagen	CANTIDAD
Controlador		1
Vocero		KX-6004, 1 pieza KX-6503, 2 piezas
Remoto Control		1
Alambrado Aprovechar		1
Cableado de 5 pines Aprovechar		1
Cargando Cable		1
Cigarrillo Enchufe del encendedor		1
Tornillo		4
Fusible		1
instrucciones		1

## OPERACIÓN

## 1. CJB SIREN

## 1.1 Function introduction

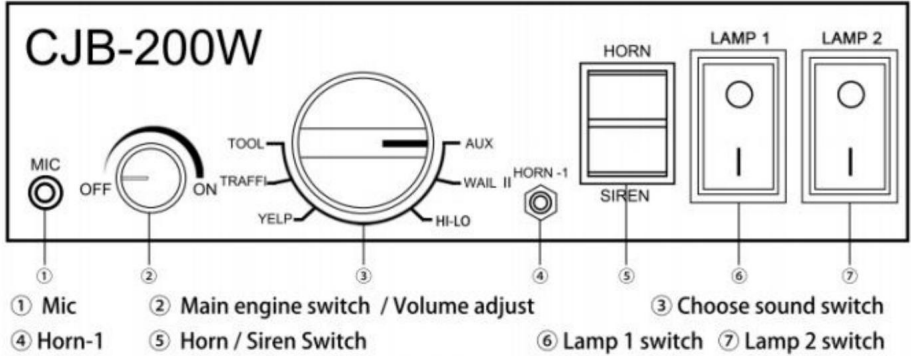

## 1.2 Installation introduction

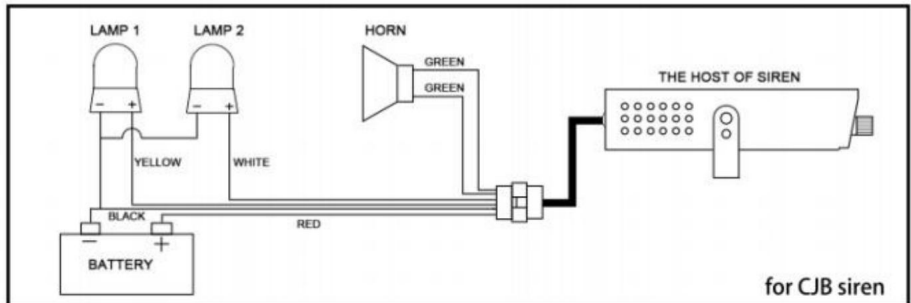

## 1.3 Datos tecnológicos

N.º de artículo	Voltaje Nivel	de sonido	Resistencia eléctrica	Corriente
CJB 100W 12/24V	$\geq 120$ dB		8 en punto	$\leq 10$ A
CJB200W 12/24V	$\geq 125$ dB		8 en punto	$\leq 15$ A
CJB 400W 12/24V	$\geq 130$ dB		4 $\Omega$	$\leq 20$ A





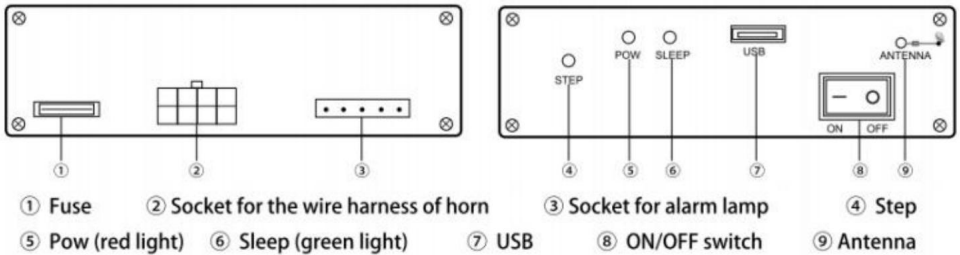

### 1.4 Lista de embalaje

NO.	NOMBRE	CANTIDAD	UNIDAD	
1	El anfitrión de la sirena	1	Piezas	
2	Vocero	100 W 8 Q	1	Piezas
		200W 8Ω	1	Piezas
		400W 4Ω	1	Piezas
3	Línea de conexión de groupware	1	Piezas	
4	Perno, tapón de rosca, f uso, etc.	1	Piezas	
5	Instrucciones	1	Hoja	

## 2.WIRELESS SIREN

### 2.1 Function introduction



- 1). Press the ON/OFF switch on the host, then  (green light) light.
- 2). Press the  key on the remote control to turn on the remote control, the backlight is always on, when you press any other key,  (red light) on the host will flicker. and then press  and hold to turn off.
- 3). Press the whistle key (SIREN HORN / HIGH BASS) to make the whistle sound, release then stop. After  reverberation, the whistle will become bass.
- 4). Press the alarm key, it will alarm continuously and press the  key to stop.
- 5). Press the  key to turn the alarm tone into bass.
- 6). Lamp control 1 (or A) and lamp control 2 (or B) control two ways of lamp. Press once to turn on and then press once to turn off.
- 7). Press the button on the left side of the remote control, and you can speak.

## 2.2 Installation introduction

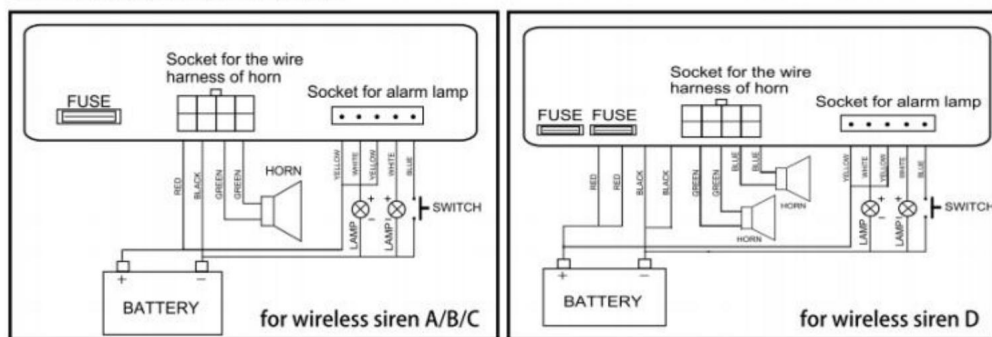

## 2.3 Datos tecnológicos

Artículo N.º Paquete	Voltaje de alimentación			Sonido nivel	Corriente de resistencia	
Inalámbrico sirena A	1 sirena+ 1 cuerno	200 W	12 V	125 dB	8 en punto	≤15 A
Inalámbrico sirena b	1 sirena+ 1 cuerno	200 W	12 V	128d8	80	≤20 A
Inalámbrico sirena C	1 sirena+ 1 cuerno	400W	12 V	130 dB	40	≤25 A
Inalámbrico Señor D.	1 sirena+ 2 cuernos	400W	12 V	135d8	4 Ω	≤25 A

## ELIMINACIÓN CORRECTA



Este producto está sujeto a las disposiciones de la Directiva europea 2012/19/UE. El símbolo que muestra un contenedor de basura tachado indica que el producto requiere recogida selectiva de residuos en el Unión Europea. Esto se aplica al producto y a todos los accesorios. marcados con este símbolo. Los productos marcados como tal no pueden desecharse con la basura doméstica normal, sino que deben llevarse a un

Punto de recogida para el reciclaje de aparatos eléctricos y electrónicos.

Fabricante: Shanghaimuxinmuyeyouxiangongsi

Dirección: Shuangchenglu 803nong11hao1602A-1609shi, baoshanqu, shanghai 200000 CN.

Importado a Australia: SIHAO PTY LTD. 1 ROKEVA STREETEASTWOOD

Nueva Gales del Sur 2122 Australia

Importado a EE. UU.: Sanven Technology Ltd. Suite 250, 9166 Anaheim

Lugar, Rancho Cucamonga, CA 91730

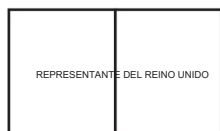

YH CONSULTING LIMITADA.

C/O YH Consulting Limited Oficina 147,  
Centurion House, London Road,  
Staines-upon-Thames, Surrey, TW18 4AX

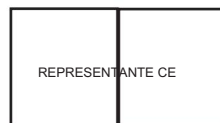

E-CrossStu GmbH

Mainzer Landstr.69,  
60329 Fráncfort del Meno.

Hecho en china



**VEVOR<sup>®</sup>**

**TOUGH TOOLS, HALF PRICE**

Soporte técnico y certificado de garantía  
electrónica [www.vevor.com/support](http://www.vevor.com/support)



# **VEVOR<sup>®</sup>**

## **TOUGH TOOLS, HALF PRICE**

Technische ondersteuning en e-garantiecertificaat [www.vevor.com/support](http://www.vevor.com/support)

### **SIRENE MET HOOG VERMOGEN**

**MODEL: KX-6001/KX-6004/KX-6503**

Wij streven er voortdurend naar om u gereedschappen tegen concurrerende prijzen te leveren.

"Save Half", "Half Price" of andere soortgelijke uitdrukkingen die wij gebruiken, geven alleen een schatting van de besparingen die u kunt behalen door bepaalde gereedschappen bij ons te kopen in vergelijking met de grote topmerken en betekent niet noodzakelijkerwijs dat alle categorieën gereedschappen die wij aanbieden, worden gedekt. Wij herinneren u eraan om zorgvuldig te controleren of u daadwerkelijk de helft bespaart in vergelijking met de grote topmerken wanneer u een bestelling bij ons plaatst.

# VEVOR<sup>®</sup>

TOUGH TOOLS, HALF PRICE

## SIRENE MET HOOG VERMOGEN

MODEL: KX-6001/KX-6004/KX-6503



**HULP NODIG? NEEM CONTACT MET ONS OP!**

Heeft u vragen over het product? Heeft u technische ondersteuning nodig? Neem dan gerust contact met

ons op: **Technische ondersteuning en E-garantiecertificaat**  
[www.vevor.com/support](http://www.vevor.com/support)

Dit is de originele instructie, lees alle handleidingen zorgvuldig door voordat u het product gebruikt. VEVOR behoudt zich een duidelijke interpretatie van onze gebruikershandleiding voor. Het uiterlijk van het product is afhankelijk van het product dat u hebt ontvangen. Vergeef ons dat we u niet opnieuw zullen informeren als er technologie- of software-updates voor ons product zijn.

## **BELANGRIJKE VEILIGHEIDSMATREGELEN**

**WAARSCHUWING:** Lees deze instructies voordat u dit product gebruikt. Als u dit niet doet, kan dit leiden tot: resulteren in ernstig letsel. Neem altijd de regels voor veilig gebruik in acht.

1. De temperatuur van de compressor kan tijdens of na de werking ervan zeer hoog zijn.  
is gestopt, raak het dus niet met blote huid aan.
2. Installeer het systeem op een vlakke, koele, droge plek. Vermijd warme en vochtige plekken en doe  
Maak de compressormotor niet nat.
3. De luidspreker is erg luid, dus houd uw oren uit de buurt van de luidspreker om te voorkomen  
schade aan uw oren.
4. Dit product is geen speelgoed. Laat kinderen niet met of in de buurt van dit item spelen.
5. Controleer voor het aansluiten de spanning van de batterij en de alarmhost  
vermijd verbranding. Probeer tegelijkertijd geen andere leidingen op het voertuig aan te sluiten op  
Voorkom dat onstabiele spanning of lage stroomsterkte het gebruik van het product beïnvloeden.
6. Sluit eerst de claxon en de flitslamp aan en wikkel de bedrading vervolgens in met isolatiemateriaal.  
plakband en sluit ten slotte de stroomkabel aan.
7. Het wordt aanbevolen om de host in de bestuurderscabine te installeren zonder  
aarding. Deze moet worden uitgeschakeld wanneer de auto stilvalt. Dit heeft invloed op het starten van  
het voertuig en de levensduur van de host als de host een lange tijd stand-by heeft.
8. De hoorn moet op een plaats worden geïnstalleerd waar het water niet gemakkelijk kan binnendringen.  
vermijd het tekort aan het hoorncircuit dat wordt veroorzaakt door ernstig waden.
9. Meestal is de spanning van auto's, busjes en motorfietsen 12V, en die van vrachtwagens en  
technische voertuigen zijn 24V. Raadpleeg de accu-identificatie voor meer informatie.

## **BEWAAR DEZE INSTRUCTIES**

## PARAMETERLIJST



<b>Model</b>	KX-6001				KX-6004	KX-6503
<b>Type</b>	CJB-sirene				draadloze sirene A	draadloze sirene D
<b>Spanning</b>	DC 12V	DC 12V	DC 12V	DC 12V		DC 12V
<b>Beoordeeld Stroom</b>	200W	200W	100W	200W	200W	400W
<b>Aantal kanalen</b>	7	9	8	8	18	8
<b>Geluid Niveau</b>	125dB	125dB	125dB	125dB	125dB	135dB

**ONDERDELENLIJST**

## KX-6001

Naam	Afbeelding	Hoeveelheid
Beheerder		1
microfoon		1
Spreker	 <p style="text-align: center;">of</p>	1
4-pins kabelboom		1
Lampbesturingslijn		1
Gastheerbeugel		1
Microfoonstandaard		1
Schroef		4
Moer		2
Zelftappende schroeven		3
<small>Samensmelten</small>		1
instructies		1

**KX-6004/KX-6503**

Naam	Afbeelding	Hoeveelheid
Beheerder		1
Spreker		KX-6004, 1 stuks KX-6503, 2 stuks
Op afstand Controle		1
Bedrading Harnas		1
5-pins bedrading Harnas		1
Opladen Kabel		1
Sigaret Aanstekerplug		1
Schroef		4
Samensmelten		1
instructies		1

## WERKING

# 1. CJB SIREN

## 1.1 Function introduction

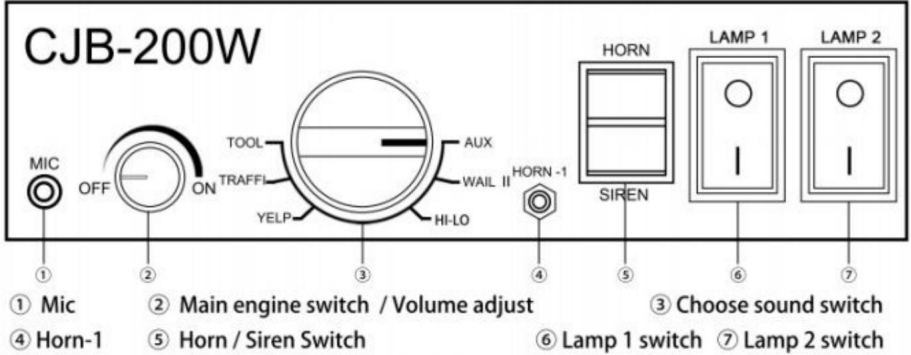

## 1.2 Installation introduction

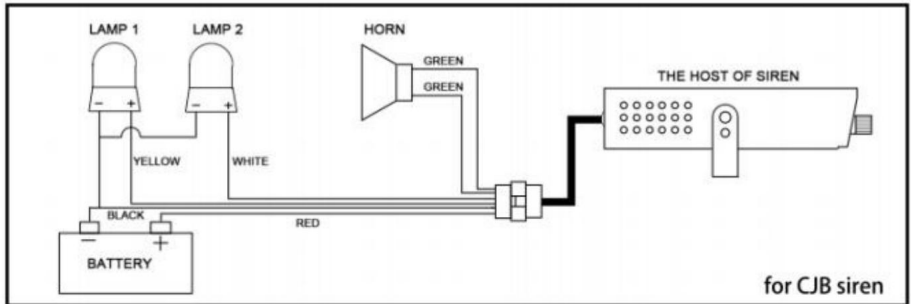

## 1.3 Technologiegegevens

Onderdeelnr.	Spanning	Geluidsniveau	Elektrische weerstand	Stroom
CJB 100W 12/24V	12/24V	120dB	8 uur	10A
CJB 200W 12/24V	12/24V	125dB	8 uur	15A
CJB 400W 12/24V	12/24V	130dB	4	20A

## 1.4 Paklijst

NEE.	NAAM	Hoeveelheid	EENHEID	
1	De gastheer van de sirene	1	STUKS	
2	Spreker	100W 8Q	1	STUKS
		200W 8ÿ	1	STUKS
		400W 4ÿ	1	STUKS
3	Groepsware voor verbindinglijnen	1	STUKS	
4	Bout, schroefdop, voor gebruik, enz.	1	STUKS	
5	Instructies	1	Laken	

## 2.WIRELESS SIREN



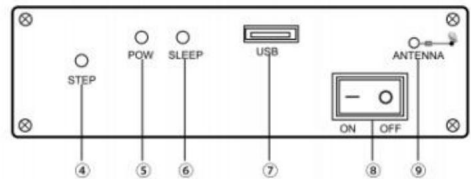
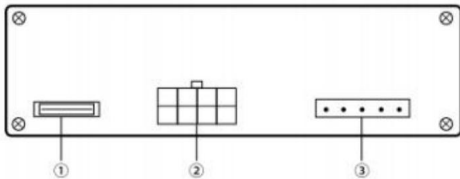

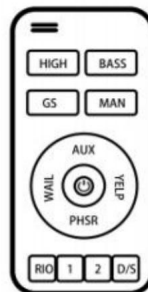
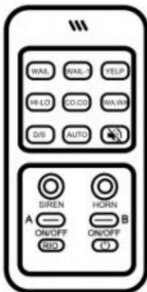

### 2.1 Function introduction



- ① Fuse      ② Socket for the wire harness of horn      ③ Socket for alarm lamp      ④ Step  
 ⑤ Pow (red light)      ⑥ Sleep (green light)      ⑦ USB      ⑧ ON/OFF switch      ⑨ Antenna





- 1). Press the ON/OFF switch on the host, then  (green light) light.
- 2). Press the  key on the remote control to turn on the remote control, the back-light is always on, when you press any other key,  (red light) on the host will flicker. and then press  and hold to turn off.
- 3). Press the whistle key (SIREN HORN / HIGH BASS) to make the whistle sound, release then stop. After  reverberation, the whistle will become bass.
- 4). Press the alarm key, it will alarm Continuously. and press the  key to stop.
- 5). Press the  key to turn the alarm tone into bass.
- 6). Lamp control 1(or A) and lamp control 2(or B) control two ways of lamp. Press once to turn on and then press once to turn off.
- 7). Press the button on the left side of the remote control, and you can speak.

## 2.2 Installation introduction

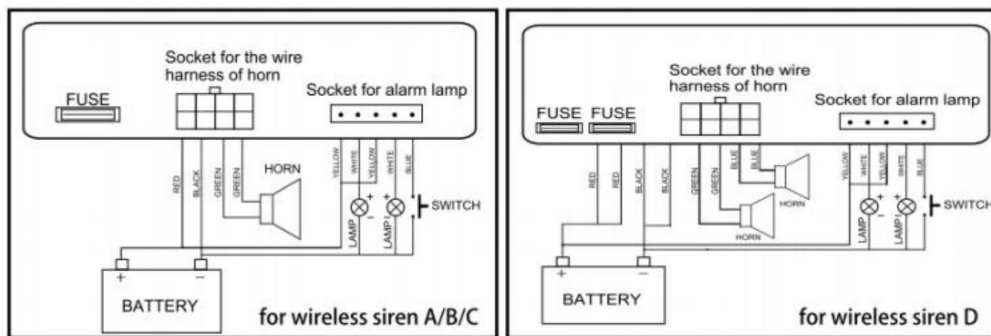

## 2.3 Technologiegegevens

Artikelnr.	Pakket	Vermogen	Voltage	Geluid niveau	Weerstands	stroom
Draadloze sirene A	1 sirene+	200W	12V	125dB	8 uur	ÿ15A
Draadloze Sirene B	1 sirene+	200W	12V	128d8	80	ÿ20A
Draadloze sirene C	1 sirene+	400W	12V	130dB	40	ÿ25A
Draadloze Mijnheer D	1 sirene+	400W	12V	135d8	4ÿ	ÿ25A

## CORRECTE VERWIJDERING



Dit product is onderworpen aan de bepalingen van de Europese richtlijn 2012/19/EU. Het symbool met een gekloofde afvalbak doorgekruist geeft aan dat het product gescheiden afvalinzameling vereist in de Europese Unie. Dit geldt voor het product en alle accessoires gemarkeerd met dit symbool. Producten die als zodanig gemarkeerd zijn, mogen niet weggegooid met het normale huisvuil, maar moet naar een afvalverwerkingsbedrijf worden gebracht.

inzamelpunt voor het recyclen van elektrische en elektronische apparaten.

**Fabrikant:** Shanghaimuxinmuyeyouxiangongsi

**Adres:** Shuangchenglu 803nong11hao1602A-1609shi, baoshanqu, shanghai 200000 CN.

**Geïmporteerd naar AUS:** SIHAO PTY LTD. 1 ROKEVA STREETEASTWOOD NSW 2122 Australië

**Geïmporteerd naar de VS:** Sanven Technology Ltd. Suite 250, 9166 Anaheim Plaats, Rancho Cucamonga, CA 91730



YH CONSULTING LIMITED.  
C/O YH Consulting Limited Kantoor 147,  
Centurion House, London Road,  
Staines-upon-Thames, Surrey, TW18 4AX



E-CrossStu GmbH  
Mainzer Landstr.69,  
60329 Frankfurt am Main.

**Gemaakt in China**



**VEVOR**<sup>®</sup>

**TOUGH TOOLS, HALF PRICE**

Technische ondersteuning en e-  
garantiecertificaat [www.vevor.com/support](http://www.vevor.com/support)

# **VEVOR<sup>®</sup>**

## **TOUGH TOOLS, HALF PRICE**

Technische ondersteuning en e-garantiecertificaat [www.vevor.com/support](http://www.vevor.com/support)

### **SIRENE MET HOOG VERMOGEN**

**MODEL: KX-6001/KX-6004/KX-6503**

Wij streven er voortdurend naar om u gereedschappen tegen concurrerende prijzen te leveren.

"Save Half", "Half Price" of andere soortgelijke uitdrukkingen die wij gebruiken, geven alleen een schatting van de besparingen die u kunt behalen door bepaalde gereedschappen bij ons te kopen in vergelijking met de grote topmerken en betekent niet noodzakelijkerwijs dat alle categorieën gereedschappen die wij aanbieden, worden gedekt. Wij herinneren u eraan om zorgvuldig te controleren of u daadwerkelijk de helft bespaart in vergelijking met de grote topmerken wanneer u een bestelling bij ons plaatst.

# VEVOR<sup>®</sup>

TOUGH TOOLS, HALF PRICE

## SIRENE MET HOOG VERMOGEN

MODEL: KX-6001/KX-6004/KX-6503



**HULP NODIG? NEEM CONTACT MET ONS OP!**

Heeft u vragen over het product? Heeft u technische ondersteuning nodig? Neem dan gerust contact met

ons op: **Technische ondersteuning en E-garantiecertificaat**  
[www.vevor.com/support](http://www.vevor.com/support)

Dit is de originele instructie, lees alle handleidingen zorgvuldig door voordat u het product gebruikt. VEVOR behoudt zich een duidelijke interpretatie van onze gebruikershandleiding voor. Het uiterlijk van het product is afhankelijk van het product dat u hebt ontvangen. Vergeef ons dat we u niet opnieuw zullen informeren als er technologie- of software-updates voor ons product zijn.

## **BELANGRIJKE VEILIGHEIDSMATREGELEN**

**WAARSCHUWING:** Lees deze instructies voordat u dit product gebruikt. Als u dit niet doet, kan dit leiden tot: resulteren in ernstig letsel. Neem altijd de regels voor veilig gebruik in acht.

1. De temperatuur van de compressor kan tijdens of na de werking ervan zeer hoog zijn.  
is gestopt, raak het dus niet met blote huid aan.
2. Installeer het systeem op een vlakke, koele, droge plek. Vermijd warme en vochtige plekken en doe  
Maak de compressormotor niet nat.
3. De luidspreker is erg luid, dus houd uw oren uit de buurt van de luidspreker om te voorkomen  
schade aan uw oren.
4. Dit product is geen speelgoed. Laat kinderen niet met of in de buurt van dit item spelen.
5. Controleer voor het aansluiten de spanning van de batterij en de alarmhost  
vermijd verbranding. Probeer tegelijkertijd geen andere leidingen op het voertuig aan te sluiten op  
Voorkom dat onstabiele spanning of lage stroomsterkte het gebruik van het product beïnvloeden.
6. Sluit eerst de claxon en de flitslamp aan en wikkel de bedrading vervolgens in met isolatiemateriaal.  
plakband en sluit ten slotte de stroomkabel aan.
7. Het wordt aanbevolen om de host in de bestuurderscabine te installeren zonder  
aarding. Deze moet worden uitgeschakeld wanneer de auto stilvalt. Dit heeft invloed op het starten van  
het voertuig en de levensduur van de host als de host een lange tijd stand-by heeft.
8. De hoorn moet op een plaats worden geïnstalleerd waar het water niet gemakkelijk kan binnendringen.  
vermijd het tekort aan het hoorncircuit dat wordt veroorzaakt door ernstig waden.
9. Meestal is de spanning van auto's, busjes en motorfietsen 12V, en die van vrachtwagens en  
technische voertuigen zijn 24V. Raadpleeg de accu-identificatie voor meer informatie.

## **BEWAAR DEZE INSTRUCTIES**

## PARAMETERLIJST

<b>Model</b>	KX-6001				KX-6004	KX-6503
<b>Type</b>	CJB-sirene				draadloze sirene A	draadloze sirene D
<b>Spanning</b>	DC 12V	DC 12V	DC 12V	DC 12V		DC 12V
<b>Beoordeeld Stroom</b>	200W	200W	100W	200W	200W	400W
<b>Aantal kanalen</b>	7	9	8	8	18	8
<b>Geluid Niveau</b>	125dB	125dB	125dB	125dB	125dB	135dB



**ONDERDELENLIJST**

## KX-6001

Naam	Afbeelding	Hoeveelheid
Beheerder		1
microfoon		1
Spreker		1
4-pins kabelboom		1
Lampbesturingslijn		1
Gastheerbeugel		1
Microfoonstandaard		1
Schroef		4
Moer		2
Zelftappende schroeven		3
<small>Samensmelten</small>		1
instructies		1

**KX-6004/KX-6503**

Naam	Afbeelding	Hoeveelheid
Beheerder		1
Spreker		KX-6004, 1 stuks KX-6503, 2 stuks
Op afstand Controle		1
Bedrading Harnas		1
5-pins bedrading Harnas		1
Opladen Kabel		1
Sigaret Aanstekerplug		1
Schroef		4
Samensmelten		1
instructies		1

## WERKING

# 1. CJB SIREN

## 1.1 Function introduction

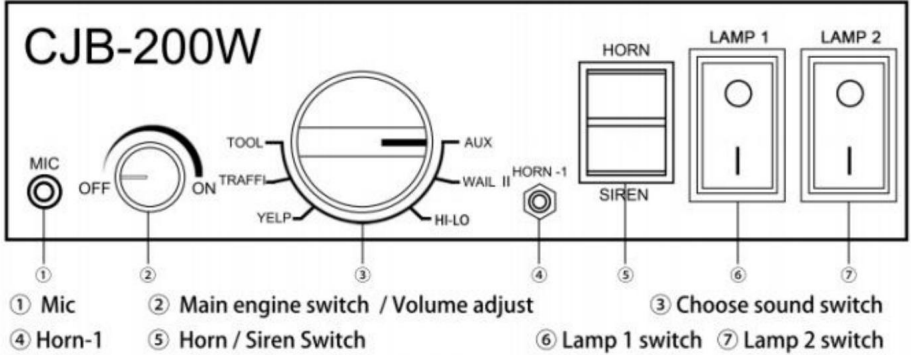

## 1.2 Installation introduction

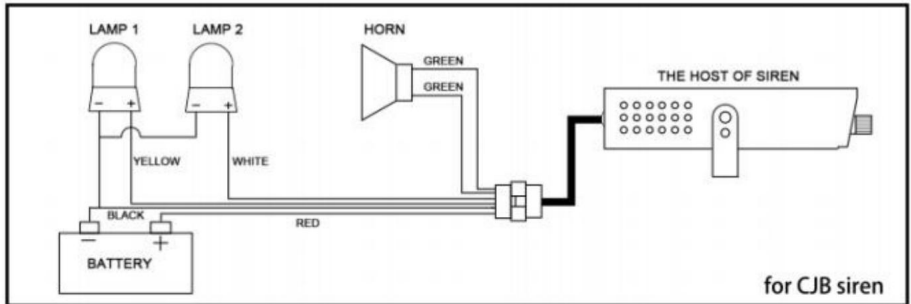

## 1.3 Technologiegegevens

Onderdeelnr.	Spanning	Geluidsniveau	Elektrische weerstand	Stroom
CJB 100W	12/24V	~120dB	8 uur	~10A
CJB 200W	12/24V	~125dB	8 uur	~15A
CJB 400W	12/24V	~130dB	4~	~20A

## 1.4 Paklijst

NEE.	NAAM	Hoeveelheid	EENHEID	
1	De gastheer van de sirene	1	STUKS	
2	Spreker	100W 8Q	1	STUKS
		200W 8ÿ	1	STUKS
		400W 4ÿ	1	STUKS
3	Groepsware voor verbindinglijnen	1	STUKS	
4	Bout, schroefdop, voor gebruik, enz.	1	STUKS	
5	Instructies	1	Laken	

## 2.WIRELESS SIREN

### 2.1 Function introduction

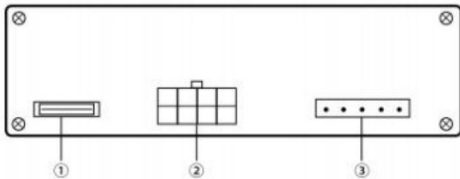



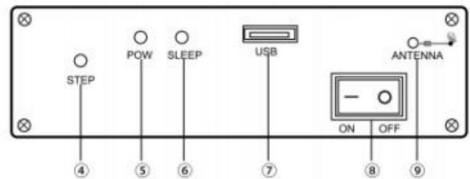

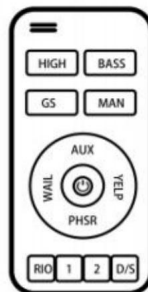

① Fuse      ② Socket for the wire harness of horn



③ Socket for alarm lamp      ④ Step  
 ⑤ Pow (red light)      ⑥ Sleep (green light)      ⑦ USB      ⑧ ON/OFF switch      ⑨ Antenna



- 1). Press the ON/OFF switch on the host, then  (green light) light.
- 2). Press the  key on the remote control to turn on the remote control, the backlight is always on, when you press any other key,  (red light) on the host will flicker. and then press  and hold to turn off.
- 3). Press the whistle key (SIREN HORN / HIGH BASS) to make the whistle sound, release then stop. After  reverberation, the whistle will become bass.
- 4). Press the alarm key, it will alarm continuously and press the  key to stop.
- 5). Press the  key to turn the alarm tone into bass.
- 6). Lamp control 1 (or A) and lamp control 2 (or B) control two ways of lamp. Press once to turn on and then press once to turn off.
- 7). Press the button on the left side of the remote control, and you can speak.

## 2.2 Installation introduction

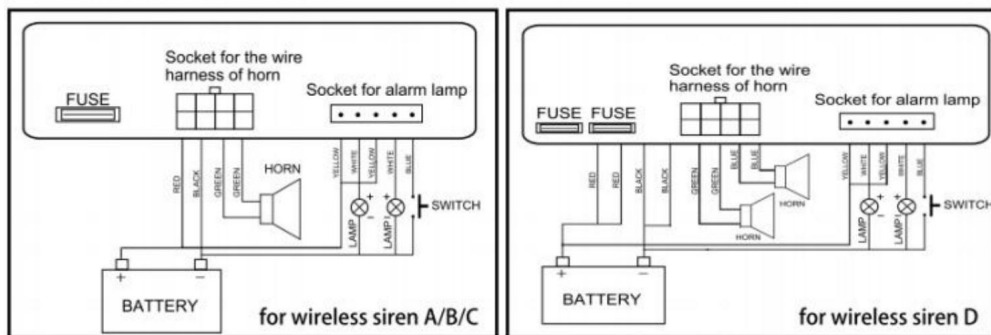

## 2.3 Technologiegegevens

Artikelnr.	Pakket	Vermogen	Voltage		Geluid niveau	Weerstandsstroom	
Draadloze sirene A	1 sirene+	1hoorn	200W	12V	125dB	8 uur	ÿ15A
Draadloze Sirene B	1 sirene+	1hoorn	200W	12V	128d8	80	ÿ20A
Draadloze sirene C	1 sirene+	1hoorn	400W	12V	130dB	40	ÿ25A
Draadloze Mijnheer D	1 sirene+	2 hoorns	400W	12V	135d8	4ÿ	ÿ25A

## CORRECTE VERWIJDERING



Dit product is onderworpen aan de bepalingen van de Europese richtlijn 2012/19/EU. Het symbool met een gekloofde afvalbak doorgekruist geeft aan dat het product gescheiden afvalinzameling vereist in de Europese Unie. Dit geldt voor het product en alle accessoires gemarkeerd met dit symbool. Producten die als zodanig gemarkeerd zijn, mogen niet weggegooid met het normale huisvuil, maar moet naar een afvalverwerkingsbedrijf worden gebracht.

inzamelpunt voor het recyclen van elektrische en elektronische apparaten.

**Fabrikant:** Shanghaimuxinmuyeyouxiangongsi

**Adres:** Shuangchenglu 803nong11hao1602A-1609shi, baoshanqu, shanghai 200000 CN.

**Geïmporteerd naar AUS:** SIHAO PTY LTD. 1 ROKEVA STREETEASTWOOD NSW 2122 Australië

**Geïmporteerd naar de VS:** Sanven Technology Ltd. Suite 250, 9166 Anaheim Plaats, Rancho Cucamonga, CA 91730



YH CONSULTING LIMITED.

C/O YH Consulting Limited Kantoor 147,  
Centurion House, London Road,  
Staines-upon-Thames, Surrey, TW18 4AX



E-CrossStu GmbH

Mainzer Landstr.69,  
60329 Frankfurt am Main.

**Gemaakt in China**



**VEVOR**<sup>®</sup>

**TOUGH TOOLS, HALF PRICE**

Technische ondersteuning en e-  
garantiecertificaat [www.vevor.com/support](http://www.vevor.com/support)



# **VEVOR<sup>®</sup>**

## **TOUGH TOOLS, HALF PRICE**

Teknisk support och e-garanticertifikat [www.vevor.com/support](http://www.vevor.com/support)

### **HÖG EFFEKT SIREN**

**MODELL: KX-6001/KX-6004/KX-6503**

Vi fortsätter att vara engagerade i att ge dig verktyg till konkurrenskraftiga priser.

"Spara hälften", "halva priset" eller andra liknande uttryck som används av oss representerar bara en uppskattning av besparingar du kan dra nytta av att köpa vissa verktyg hos oss jämfört med de stora toppmärkena och betyder inte nödvändigtvis att täcka alla kategorier av verktyg som erbjuds av oss. Du påminns vänligen om att noggrant kontrollera när du gör en beställning hos oss om du faktiskt sparar hälften i jämförelse med de främsta stora varumärkena.

# VEVOR<sup>®</sup>

TOUGH TOOLS, HALF PRICE

## HÖG EFFEKT SIREN

MODELL: KX-6001/KX-6004/KX-6503



### BEHÖVER HJÄLP? KONTAKTA OSS!

Har du produktfrågor? Behöver du teknisk support? Kontakta oss gärna: **Teknisk support och e-garanticertifikat** [www.vevor.com/support](http://www.vevor.com/support)

Detta är den ursprungliga instruktionen, läs alla instruktioner noggrant innan du använder den. VEVOR reserverar sig för en tydlig tolkning av vår användarmanual. Utseendet på produkten är beroende av den produkt du fått. Ursäkta oss att vi inte kommer att informera dig igen om det finns någon teknik eller mjukvaruuppdateringar på vår produkt.

## VIKTIGA SÄKERHETSÅTGÄRDER

**VARNING:** Läs denna instruktion innan du använder denna produkt. Underlåtenhet att göra det kan resultera i allvarlig skada. Följ alltid reglerna för säker drift.

1. Temperaturen på kompressorn kan vara mycket hög under drift eller efter den har slutat, så rör den inte med bar hud.
2. Installera systemet på en jämn, sval och torr plats. Undvik varma och fuktiga områden och gör det inte blöta kompressormotorn.
3. Högtalaren är väldigt hög, så håll öronen borta från högtalaren för att förhindra skada på dina öron.
4. Denna produkt är inte en leksak. Låt inte barn leka med eller nära detta föremål.
5. Innan du ansluter, vänligen bekräfta spänningen på batteriet och larmvärden till undvika att bränna. Försök samtidigt att inte ansluta andra ledningar på fordonet till undvika instabil spänning eller låg ström som påverkar användningen av produkten.
6. Anslut först signalhornet och blixlampan, linda sedan in kablarna med isolering tejp och anslut slutligen kraftledningen.
7. Det rekommenderas att värden installeras i förarhytten utan grundstötning. Den ska stängas av när bilen stannar. Det kommer att påverka uppstarten av fordonet och värdens livslängd om värden har lång tids standby.
8. Hornet ska installeras i ett läge där det inte är lätt att komma in i vatten undvika bristen på hornkretsen orsakad av allvarlig vadning.
9. Vanligtvis är spänningen på bilar, skåpbilar och motorcyklar 12V, och lastbilarna och tekniska fordon är 24V. Se batteriidentifieringen för detaljer.

## SPARA DESSA INSTRUKTIONER

## PARAMETERLISTA

<b>Modell</b>	KX-6001				KX-6004	KX-6503
<b>Typ</b>	CJB Siren				trådlös siren A	trådlös siren D
<b>Spänning</b>	DC 12V	DC 12V	DC 12V	DC 12V		DC 12V
<b>Betygsatt Driva</b>	200W	200W	100W	200W	200W	400W
<b>Antal kanaler</b>	7	9	8	8	18	8
<b>Ljud Nivå</b>	125dB	125dB	125dB	125dB	125dB	135dB

## DELLISTA

### KX-6001

Namn	Bild	ANTAL
Kontroller		1
mikrofon		1
Högtalare		1
4-stifts ledningsnät		1
Lampkontrollledning		1
Värdfäste		1
Mikrofonstativ		1
Skruva		4
Mutter		2
Självgängande skruvar		3
Säkring		1
instruktioner		1

**KX-6004/KX-6503**

Namn	Bild	ANTAL
Kontroller	 <p>eller</p>	1
Högtalare		KX-6004, 1 st KX-6503, 2 st
Avlägsen Kontrollera		1
Kabeldragning Sele		1
5-stifts kabeldragning Sele		1
Laddar Kabel		1
Cigarett Lättare plugg		1
Skruva		4
Säkring		1
instruktioner		1

## DRIFT

### 1.CJB SIREN

#### 1.1 Function introduction

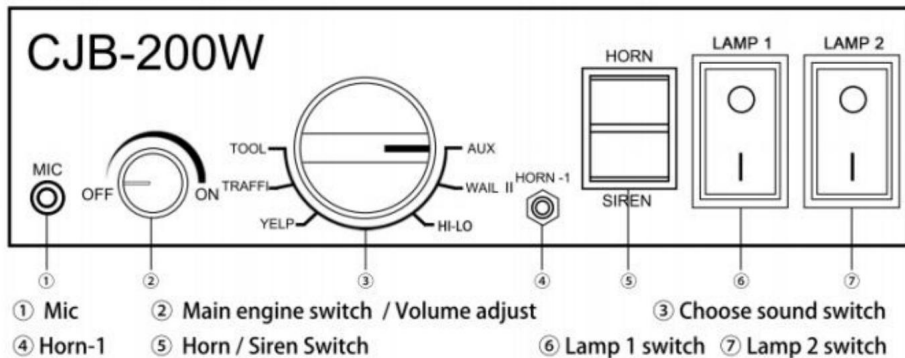

#### 1.2 Installation introduction

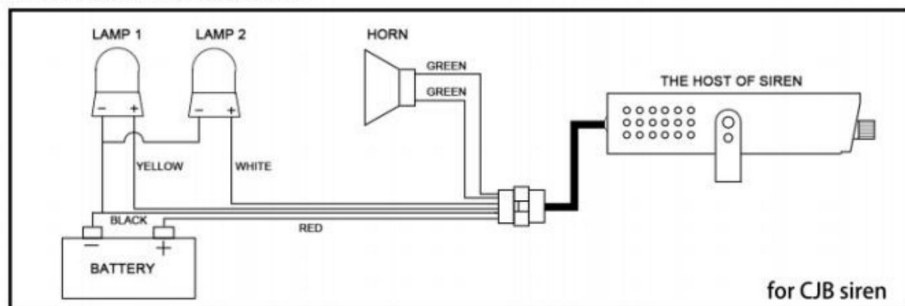

#### 1.3 Teknikdata

Item NO.	Spänning	Ljudnivå	Elektriskt motstånd	Ström	
CJB 100W	12/24V	~120dB		klockan 8	~10A
CJB 200W	12/24V	~125dB		klockan 8	~15A
CJB 400W	12/24V	~130dB		4 ~	~20A

## 1.4 Packlista

INGA.	NAMN	ANTAL	ENHET	
1	Värden för siren	1	PCS	
2	Högtalare	100W 8Q	1	PCS
		200W 8ÿ	1	PCS
		400W 4ÿ	1	PCS
3	Connect line groupware	1	PCS	
4	Bult, skruvlock, f användning, etc	1	PCS	
5	Instruktioner	1	Ark	

## 2.WIRELESS SIREN



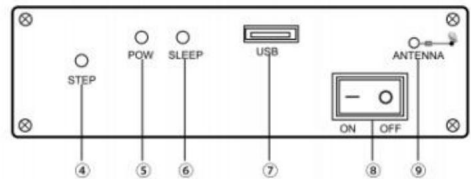
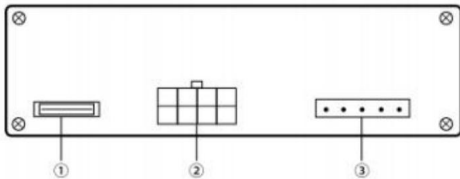

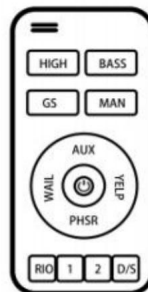

### 2.1 Function introduction



- ① Fuse    ② Socket for the wire harness of horn    ③ Socket for alarm lamp    ④ Step  
 ⑤ Pow (red light)    ⑥ Sleep (green light)    ⑦ USB    ⑧ ON/OFF switch    ⑨ Antenna





- 1). Press the ON/OFF switch on the host, then  (green light) light.
- 2). Press the  key on the remote control to turn on the remote control, the back-light is always on, when you press any other key,  (red light) on the host will flicker. and then press  and hold to turn off.
- 3). Press the whistle key (SIREN HORN / HIGH BASS) to make the whistle sound, release then stop. After  reverberation, the whistle will become bass.
- 4). Press the alarm key, it will alarm continuously and press the  key to stop.
- 5). Press the  key to turn the alarm tone into bass.
- 6). Lamp control 1 (or A) and lamp control 2 (or B) control two ways of lamp. Press once to turn on and then press once to turn off.
- 7). Press the button on the left side of the remote control, and you can speak.

## 2.2 Installation introduction

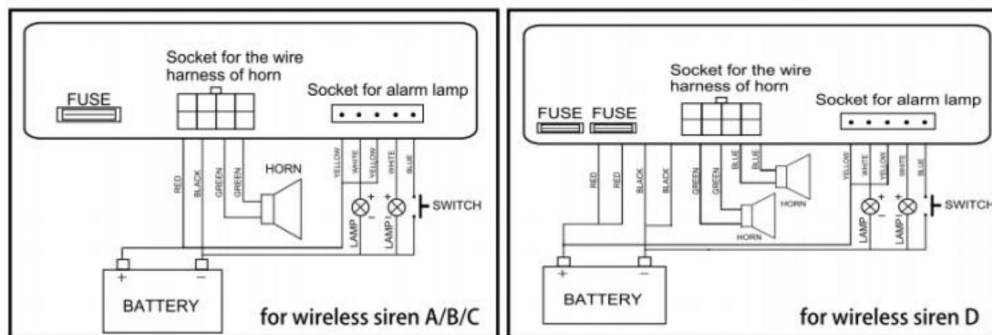

## 2.3 Teknikdata

Artikel NR	Paket	Strömspanning		Ljud nivå	Motståndsström	
Trådlös siren A	1 siren+ 1 horn	200W	12V	125dB	<small>klockan 8</small>	ÿ15A
Trådlös Siren B	1 siren+ 1 horn	200W	12V	128dB	80	ÿ20A
Trådlös siren C	1 siren+ 1 horn	400W	12V	130dB	40	ÿ25A
Trådlös Sir D	1 siren+ 2horn	400W	12V	135dB	4 ÿ	ÿ25A

## KORREKT AVFALLSHANTERING



Denna produkt omfattas av bestämmelserna i det europeiska direktivet

2012/19/EU. Symbolen som visar en soptunna på hjul korsad

indikerar att produkten kräver separat sophämtning i

Europeiska unionen. Detta gäller produkten och alla tillbehör

märkt med denna symbol. Produkter märkta som sådana kanske inte är det kasseras med vanligt hushållsavfall, men måste tas till en

insamlingsställe för återvinning av elektriska och elektroniska apparater.

**Tillverkare:** Shanghaimuxinmuyeyouxiangongsi

**Adress:** Shuangchenglu 803nong11hao1602A-1609shi, baoshanqu, shanghai 200000 CN.

**Importerad till AUS:** SIHAO PTY LTD. 1 ROKEVA STREETEASTWOOD NSW 2122 Australien

**Importerad till USA:** Sanven Technology Ltd. Suite 250, 9166 Anaheim Place, Rancho Cucamonga, CA 91730



YH CONSULTING LIMITED.

C/O YH Consulting Limited Office 147,

Centurion House, London Road,

Staines-upon-Thames, Surrey, TW18 4AX



E-CrossStu GmbH

Mainzer Landstr.69,

60329 Frankfurt am Main.

**Tillverkad i Kina**



**VEVOR**®

**TOUGH TOOLS, HALF PRICE**

**Teknisk support och e-garanticertifikat**

**[www.vevor.com/support](http://www.vevor.com/support)**