

# **VEVOR<sup>®</sup>**

## **TOUGH TOOLS, HALF PRICE**

Technical Support and E-Warranty Certificate [www.vevor.com/support](http://www.vevor.com/support)

### **HITCH STEP**

We continue to be committed to provide you tools with competitive price.

"Save Half", "Half Price" or any other similar expressions used by us only represents an estimate of savings you might benefit from buying certain tools with us compared to the major top brands and does not necessarily mean to cover all categories of tools offered by us. You are kindly reminded to verify carefully when you are placing an order with us if you are actually saving half in comparison with the top major brands.

# VEVOR<sup>®</sup>

TOUGH TOOLS, HALF PRICE

## HITCH STEP



### NEED HELP? CONTACT US!

Have product questions? Need technical support? Please feel free to contact us:

**Technical Support and E-Warranty Certificate**  
**[www.vevor.com/support](http://www.vevor.com/support)**

This is the original instruction, please read all manual instructions carefully before operating. VEVOR reserves a clear interpretation of our user manual. The appearance of the product shall be subject to the product you received. Please forgive us that we won't inform you again if there are any technology or software updates on our product.



**Warning-**To reduce the risk of injury, the user must read the instructions manual carefully.









## WARNING

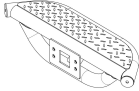

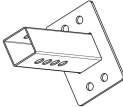

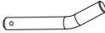

- This product is only applicable to 2 "receiver mounting devices.
- Hitch Step may interfere with the operation of the O.E. back-up sensor on several late model vehicles. If your vehicle comes equipped with an O.E. back-up sensor, it is advised that you check before purchased.
- It is strictly prohibited to use the product beyond its maximum load.

## PRODUCTION CONFIGURATION

Model	GJ0066
Maximum load (lbs)	350
Length (in)	25.7

## PARTS LIST

ITEM	Name	PICTURE	Q'TY	ITEM	Name	PICTURE	Q'TY
1	Main step		1PC	8	U-shaped screw		1PC
2	Connecting square tubes		1PC	9	Stable iron plate		1PC
3	Locking rod		1PC	10	Hexagonal nut(M10)		6PC
4	Pinzi		1PC	11	Flat washer		6PC

5	Lock (with 2 keys)		1set	12	Elastic washer		6PC
6	Locking pin		1PC	13	Hexagonal bolt M10 * 30		4PC
7	Sealing ring		8PC	14	manual		1PC

## INSTALLATION INSTRUCTIONS

1. Assemble the Main step and Connecting Square tubes (Use 4 Hexagon bolts M10 \* 30, 4 Flat washers, and 4 Elastic washers), as shown in the following figure:

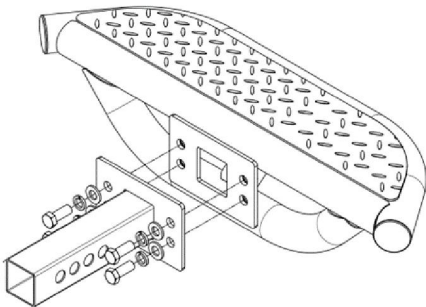

2. Insert the hitch step into the hitch receiver. Adjust and select the appropriate hole position for alignment.

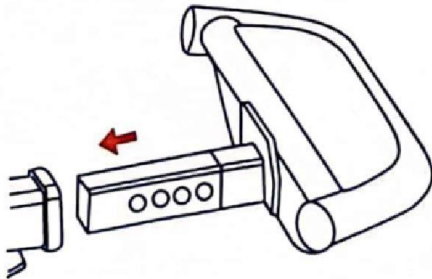

3. Insert the Locking rod into the hole and the pinzi (Product Configuration Lock Kit, and this step allows you to choose to install the Lock kit as needed.).

Locking rod

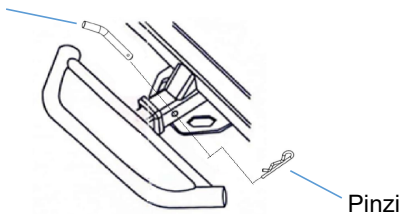

4. Stabilizer installation (Use 1 U-shaped screw, 2 Flat washers, and 2 Elastic washers, 2 hexagonal nuts).

U-shaped screw

Stable iron plate

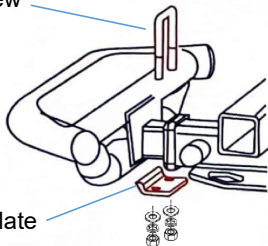

**Manufacturer:** Shanghaimuxinmuyeyouxiangongsi

**Address:** Shuangchenglu 803nong11hao1602A-1609shi, baoshanqu, shanghai 200000 CN.

**Imported to AUS:** SIHAO PTY LTD.

1 ROKEVA STREETEASTWOOD NSW 2122 Australia

**Imported to USA:** Sanven Technology Ltd.

Suite 250, 9166 Anaheim Place, Rancho Cucamonga, CA 91730

<b>UK</b>	<b>REP</b>
-----------	------------

YH CONSULTING LIMITED.

C/O YH Consulting Limited Office 147,  
Centurion House, London Road,  
Staines-upon-Thames, Surrey, TW18 4AX

<b>EC</b>	<b>REP</b>
-----------	------------

E-CrossStu GmbH  
Mainzer Landstr.69,  
60329 Frankfurt am Main.



**VEVOR<sup>®</sup>**

**TOUGH TOOLS, HALF PRICE**

**Technical Support and E-Warranty Certificate**

**[www.vevor.com/support](http://www.vevor.com/support)**



# **VEVOR<sup>®</sup>**

## **TOUGH TOOLS, HALF PRICE**

Assistance technique et certificat de garantie électronique [www.vevor.com/support](http://www.vevor.com/support)

### **MARCHE D'ATTELAGE**

Nous continuons à nous engager à vous fournir des outils à des prix compétitifs.

"Économisez la moitié", "Moitié prix" ou toute autre expression similaire que nous utilisons ne représente qu'une estimation des économies dont vous pourriez bénéficier en achetant certains outils chez nous par rapport aux grandes marques et ne signifie pas nécessairement couvrir toutes les catégories d'outils proposés par nous. Nous vous rappelons de vérifier attentivement lorsque vous passez une commande chez nous si vous économisez réellement la moitié par rapport aux grandes marques.

**VEVOR**<sup>®</sup>  
TOUGH TOOLS, HALF PRICE

MARCHE D'ATTELAGE



**BESOIN D'AIDE? CONTACTEZ-NOUS!**

Vous avez des questions sur les produits ? Besoin d'une assistance technique ? N'hésitez pas à nous

contacter : Support technique et certificat de garantie électronique  
[www.vevor.com/support](http://www.vevor.com/support)

Il s'agit des instructions originales, veuillez lire attentivement toutes les instructions du manuel avant de l'utiliser. VEVOR se réserve une interprétation claire de notre manuel d'utilisation. L'apparence du produit dépend du produit que vous avez reçu. Veuillez nous pardonner que nous ne vous informerons plus s'il y a des mises à jour technologiques ou logicielles sur notre produit.



Avertissement-Pour réduire le risque de blessure, l'utilisateur doit lire le attentivement le manuel d'instructions.

#### AVERTISSEMENT









Ce produit s'applique uniquement aux dispositifs de montage de récepteur 2".

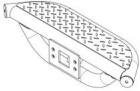

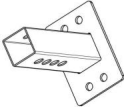



La marche d'attelage peut interférer avec le fonctionnement du capteur de secours OE sur plusieurs véhicules de modèles récents. Si votre véhicule est équipé d'un capteur de secours OE, il est conseillé de vérifier avant l'achat. Il est strictement interdit d'utiliser le produit au-delà de sa charge maximale.

#### CONFIGURATION DE PRODUCTION

Modèle	GJ0066
Charge maximale (lbs)	350
Longueur (po)	25,7

#### LISTE DES PIECES

ARTICLE	Nom	IMAGE	Q'TÉ	Nom de l'ARTICLE	IMAGE	Q'TÉ
1	Étape principale		1 pièce	8	en forme de U vis	 1 PC
2	De liaison tubes carrés		1 pièce	9	Fer stable plaque	 1 PC
3	Tige de verrouillage		1 pièce	10	Hexagonal écrou (M10)	 6 pièces
4	Pinces		1 pièce	11	Rondelle plate	 6 pièces

5	Serrure (avec 2 clés)		1 jeu	12	Élastique machine à laver		6 pièces
6	Broche de verrouillage		1 pièce	13	Hexagonal boulon M10 * 30		4 pièces
7	Bague d'étanchéité		8 pièces	14	manuel		1 PC

## INSTRUCTIONS D'INSTALLATION

1. Assemblez la marche principale et les tubes carrés de connexion (utilisez 4 hexagones boulons M10 \* 30, 4 rondelles plates et 4 rondelles élastiques), comme indiqué dans le figure suivante :

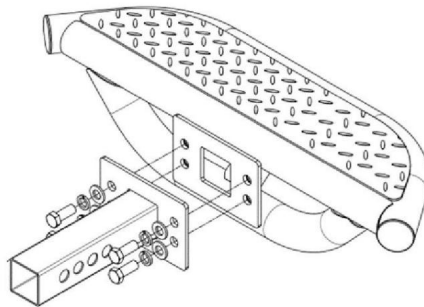

2. Insérez la marche d'attelage dans le récepteur d'attelage. Ajustez et sélectionnez le position du trou appropriée pour l'alignement.

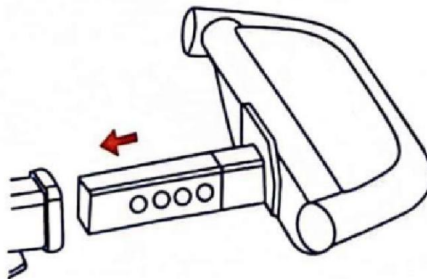

3. Insérez la tige de verrouillage dans le trou et le pinzi (kit de verrouillage de configuration du produit, et cette étape vous permet de choisir d'installer le kit de verrouillage comme tige de verrouillage nécessaire.).

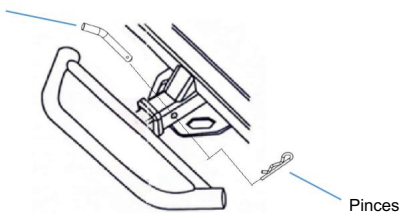

4. Installation du stabilisateur (utilisez 1 vis en forme de U, 2 rondelles plates et 2 rondelles élastiques, 2 écrous hexagonaux).

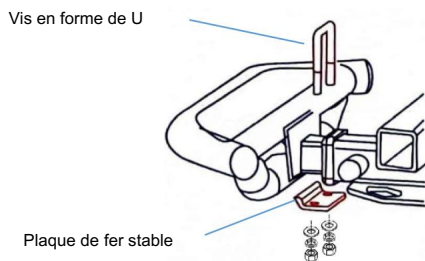

Fabricant : Shanghaimuxinmuyeyouxiangongsi

Adresse : Shuangchenglu 803nong11hao1602A-1609shi, baoshanqu, Shanghai  
200000 CN.

Importé en Australie : SIHAO PTY LTD.

1 ROKEVA STREETASTWOOD NSW 2122 Australie

Importé aux États-Unis : Sanven Technology Ltd.

Bureau 250, 9166 Anaheim Place, Rancho Cucamonga, CA 91730



YH CONSULTING LIMITÉE.

C/O YH Consulting Limited Bureau 147,  
Centurion House, London Road,  
Staines-upon-Thames, Surrey, TW18 4AX

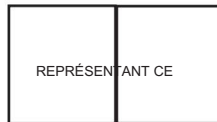

E-CrossStu GmbH

Mainzer Landstr.69,  
60329 Francfort-sur-le-Main.



**VEVOR<sup>®</sup>**

**TOUGH TOOLS, HALF PRICE**

Assistance technique et certificat de garantie  
électronique [www.vevor.com/support](http://www.vevor.com/support)



# **VEVOR<sup>®</sup>**

## **TOUGH TOOLS, HALF PRICE**

Technischer Support und E-Garantie-Zertifikat [www.vevor.com/support](http://www.vevor.com/support)

### **KUPPLUNGSSTUFE**

Wir sind weiterhin bestrebt, Ihnen Werkzeuge zu wettbewerbsfähigen Preisen anzubieten.

„Sparen Sie die Hälfte“, „Halber Preis“ oder andere ähnliche Ausdrücke, die wir verwenden, stellen nur eine Schätzung der Ersparnis dar, die Sie beim Kauf bestimmter Werkzeuge bei uns im Vergleich zu den großen Topmarken erzielen können, und decken nicht unbedingt alle von uns angebotenen Werkzeugkategorien ab. Wir möchten Sie freundlich daran erinnern, bei Ihrer Bestellung bei uns sorgfältig zu prüfen, ob Sie im Vergleich zu den großen Topmarken tatsächlich die Hälfte sparen.

# VEVOR<sup>®</sup>

TOUGH TOOLS, HALF PRICE

KUPPLUNGSSTUFE



### Brauchen Sie Hilfe? Kontaktieren Sie uns!

Haben Sie Fragen zum Produkt? Benötigen Sie technischen Support? Bitte kontaktieren Sie uns:

**Technischer Support und E-Garantie-Zertifikat [www.vevor.com/support](http://www.vevor.com/support)**

Dies ist die Originalanleitung. Bitte lesen Sie alle Anweisungen sorgfältig durch, bevor Sie das Gerät in Betrieb nehmen. VEVOR behält sich eine klare Auslegung unserer Bedienungsanleitung vor. Das Erscheinungsbild des Produkts richtet sich nach dem Produkt, das Sie erhalten haben. Bitte verzeihen Sie uns, dass wir Sie nicht erneut informieren, wenn es Technologie- oder Software-Updates für unser Produkt gibt.



Warnung-Um das Verletzungsrisiko zu verringern, muss der Benutzer die

Lesen Sie die Bedienungsanleitung sorgfältig durch.









## WARNUNG

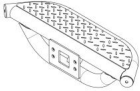

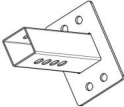



ÿ Dieses Produkt ist nur für 2<sup>n</sup>-Empfängermontagevorrichtungen geeignet. ÿ Hitch Step kann den Betrieb des OE-Rückfahr sensors beeinträchtigen mehrere neuere Fahrzeuge. Wenn Ihr Fahrzeug mit einem OE-Rückfahr sensor ausgestattet ist, sollten Sie dies vor dem Kauf überprüfen. ÿ Es ist strengstens verboten, das Produkt über seine maximale Belastung hinaus zu verwenden.

## PRODUKTIONSKONFIGURATION

Modell	GJ0066
Maximale Belastung (lbs)	350
Länge (in)	25,7

## LISTE DER EINZELTEILE

ARTIKEL	Name	BILD	MENGE	ARTIKEL	Name	BILD	MENGE
1	Hauptschritt		1PC	8	U-förmig schrauben		1 Stück
2	Verbinden Vierkantrohre		1. Korinther	9	Stabiles Eisen Platte		1 Stück
3	Verriegelungsstange		1 STK	10	Sechseckig Mutter (M10)		6 Stück
4	Zange		1. Petrus	11	Unterlegscheibe		6 Stück

5	Schloss (mit 2 Schlüsseln)		1 Satz	12	Elastisch Waschmaschine		6 Stück
6	Sicherungsstift		1. Korinther 13		Sechseckig Bolzen M10 * 30		4-teilig
7	Siegelring		8PC 14		Handbuch		1 Stück

## INSTALLATIONSANLEITUNG

1. Montieren Sie die Hauptstufe und die Verbindungsrohre (verwenden Sie 4 Sechskantrohre). Schrauben M10 \* 30, 4 Unterlegscheiben und 4 elastische Unterlegscheiben), wie in der folgende Abbildung:

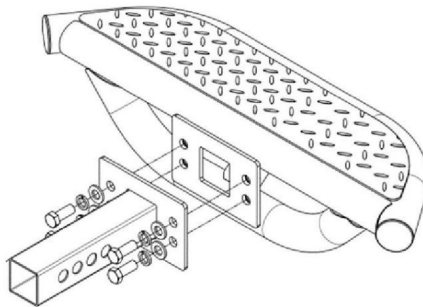

2. Setzen Sie die Kupplungsstufe in die Kupplungsaufnahme ein. Stellen Sie die entsprechende Lochposition zur Ausrichtung.

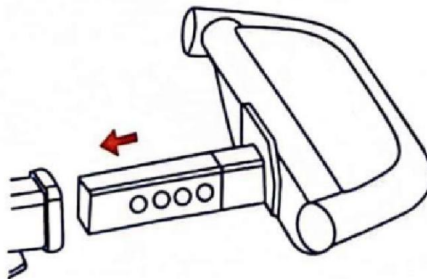

3. Stecken Sie die Verriegelungsstange in das Loch und den Pinzi (Produktkonfigurations-Schlosssatz. In diesem Schritt können Sie auswählen, ob Sie den Schlosssatz nach Bedarf installieren möchten . ).

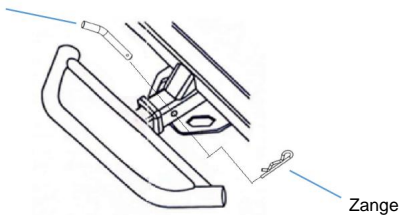

4. Stabilisatorinstallation (Verwenden Sie 1 U-förmige Schraube, 2 flache Unterlegscheiben, 2 elastische Unterlegscheiben und 2 Sechskanmütern).

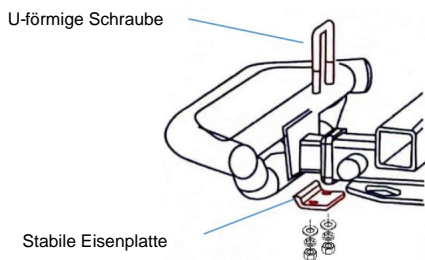

**Hersteller:** Shanghaimuxinmuyeyouxiangongsi

**Adresse:** Shuangchenglu 803nong11hao1602A-1609shi, baoshanqu, Shanghai  
200000 CN.

**Nach AUS importiert:** SIHAO PTY LTD.

1 ROKEVA STREETEASTWOOD NSW 2122 Australien

**In die USA importiert:** Sanven Technology Ltd.

Suite 250, 9166 Anaheim Place, Rancho Cucamonga, CA 91730



YH CONSULTING LIMITED.

C/O YH Consulting Limited Office 147,  
Centurion House, London Road,  
Staines-upon-Thames, Surrey, TW18 4AX



E-CrossStu GmbH

Mainzer Landstr.69,  
60329 Frankfurt am Main.



**VEVOR<sup>®</sup>**

**TOUGH TOOLS, HALF PRICE**

**Technischer Support und E-Garantie-Zertifikat**

**[www.vevor.com/support](http://www.vevor.com/support)**



# **VEVOR<sup>®</sup>**

## **TOUGH TOOLS, HALF PRICE**

Supporto tecnico e certificato di garanzia elettronica [www.vevor.com/support](http://www.vevor.com/support)

### **PASSO DI ATTACCO**

Continuiamo a impegnarci per fornirvi strumenti a prezzi competitivi.

"Risparmia la metà", "Metà prezzo" o qualsiasi altra espressione simile da noi utilizzata rappresenta solo una stima del risparmio che potresti trarre dall'acquistare determinati strumenti con noi rispetto ai principali marchi più importanti e non significa necessariamente coprire tutte le categorie di strumenti offerti da noi. Ti ricordiamo di verificare attentamente quando effettui un ordine con noi se stai effettivamente risparmiando la metà rispetto ai migliori marchi principali.

# VEVOR®

TOUGH TOOLS, HALF PRICE

PASSO DI ATTACCO



## HO BISOGNO DI AIUTO? CONTATTACI!

Hai domande sul prodotto? Hai bisogno di supporto tecnico? Non esitate a contattarci:

### **Supporto**

**tecnico e certificato di garanzia elettronica [www.vevor.com/  
support](http://www.vevor.com/support)**

Queste sono le istruzioni originali, leggere attentamente tutte le istruzioni del manuale prima dell'uso. VEVOR si riserva una chiara interpretazione del nostro manuale d'uso. L'aspetto del prodotto sarà soggetto al prodotto ricevuto. Ti preghiamo di perdonarci se non ti informeremo più se sono presenti aggiornamenti tecnologici o software sul nostro prodotto.



Avvertenza-Per ridurre il rischio di lesioni, l'utente deve leggere il attentamente il manuale di istruzioni.









### AVVERTIMENTO

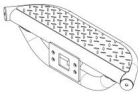

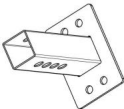



ÿ Questo prodotto è applicabile solo ai dispositivi di montaggio del ricevitore da 2 ".  
 ÿ Hitch Step potrebbe interferire con il funzionamento del sensore di backup OE su diversi veicoli degli ultimi modelli. Se il tuo veicolo è dotato di un sensore di riserva OE, ti consigliamo di controllarlo prima dell'acquisto. ÿ È severamente vietato utilizzare il prodotto oltre il suo carico massimo.

### CONFIGURAZIONE DELLA PRODUZIONE

Modello	GJ0066
Carico massimo (libbre)	350
Lunghezza (pollici)	25.7

### ELENCO DELLE PARTI

ARTICOLO	Nome	IMMAGINE	Q.TÀ	Nome ARTICOLO	IMMAGINE	Q.TÀ	
1	Passaggio principale		1 pezzo	8	A forma di U vite		1 PC
2	Connessione tubi quadrati		1 pezzo	9	Ferro stabile piatto		1 PC
3	Asta di bloccaggio		1 pezzo	10	Esagonale dado (M10)		6PC
4	Pinze		1 pezzo	11	Rondella piatta		6PC

5	Serratura (con 2 chiavi)		1 set	12	Elastico rondella		6PC
6	Pin di blocco		1 pezzo	13	Esagonale bullone M10 * 30		4 pezzi
7	Anello di tenuta		8PC	14	Manuale		1 PC

## ISTRUZIONI PER L'INSTALLAZIONE

1. Assemblare il gradino principale e i tubi quadrati di collegamento (utilizzare 4 tubi esagonali bulloni M10 \* 30, 4 Rondelle Piane e 4 Rondelle Elastiche), come mostrato nella figura figura seguente:

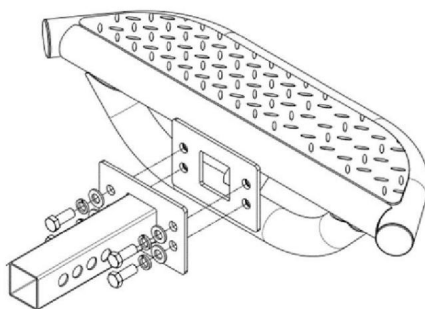

2. Inserire il gradino dell'attacco nel ricevitore dell'attacco. Regola e seleziona il posizione appropriata del foro per l'allineamento.

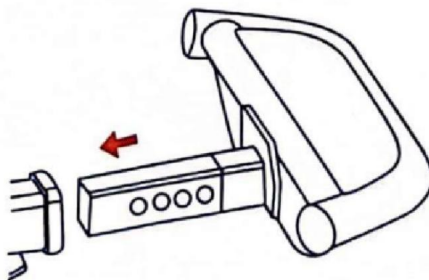

3. Inserire l'asta di bloccaggio nel foro e nei pinzi (kit di blocco configurazione prodotto e questo passaggio consente di scegliere di installare il kit di blocco come necessario per l'asta di bloccaggio ).

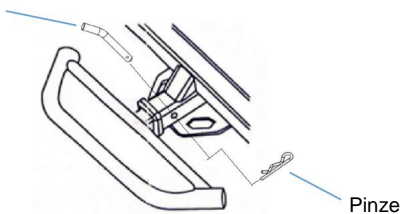

4. Installazione dello stabilizzatore (utilizzare 1 vite a forma di U, 2 rondelle piatte e 2 rondelle elastiche, 2 dadi esagonali).

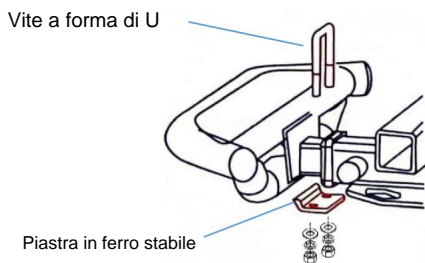

**Produttore:** Shanghaimuxinmuyeyouxiangongsi

**Indirizzo:** Shuangchenglu 803nong11hao1602A-1609shi, baoshanqu, shanghai  
200000 CN.

**Importato in AUS:** SIHAO PTY LTD.

1 ROKEVA STREETEASTWOOD NSW 2122 Australia

**Importato negli Stati Uniti:** Sanven Technology Ltd.

Suite 250, 9166 Anaheim Place, Rancho Cucamonga, CA 91730

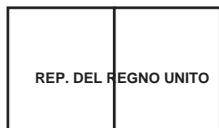

YH CONSULENZA LIMITATA.

C/O YH Consulting Limited Office 147,  
Centurion House, London Road,  
Staines-upon-Thames, Surrey, TW18 4AX



E-CrossStu GmbH

Mainzer Landstr.69,  
60329 Francoforte sul Meno.



**VEVOR<sup>®</sup>**

**TOUGH TOOLS, HALF PRICE**

**Supporto tecnico e certificato di garanzia  
elettronica [www.vevor.com/support](http://www.vevor.com/support)**



# **VEVOR<sup>®</sup>**

## **TOUGH TOOLS, HALF PRICE**

Soporte técnico y certificado de garantía electrónica [www.vevor.com/support](http://www.vevor.com/support)

### **PASO DE ENGANCHE**

Seguimos comprometidos a proporcionarle herramientas a precios competitivos.

"Ahorre a mitad de precio", "A mitad de precio" o cualquier otra expresión similar utilizada por nosotros solo representa una estimación de los ahorros que podría beneficiarse al comprar ciertas herramientas con nosotros en comparación con las principales marcas y no significa necesariamente cubrir todas las categorías de herramientas ofrecidas por nosotros. Le recordamos que, cuando realice un pedido con nosotros, verifique cuidadosamente si realmente está ahorrando la mitad en comparación con las principales marcas.

**VEVOR**<sup>®</sup>  
TOUGH TOOLS, HALF PRICE

PASO DE ENGANCHE



¿NECESITAS AYUDA? ¡CONTÁCTENOS!

¿Tiene preguntas sobre el producto? ¿Necesita soporte técnico? No dude en contactarnos:  
Soporte

técnico y certificado de garantía electrónica [www.vevor.com/support](http://www.vevor.com/support)

Estas son las instrucciones originales; lea atentamente todas las instrucciones del manual antes de operar. VEVOR se reserva una interpretación clara de nuestro manual de usuario. La apariencia del producto estará sujeta al producto que recibió. Perdona que no le informaremos nuevamente si hay actualizaciones de tecnología o software en nuestro producto.



Advertencia: para reducir el riesgo de lesiones, el usuario debe leer el manual de instrucciones con atención.

### ADVERTENCIA









Este producto solo es aplicable a dispositivos de montaje de receptor de 2 ".

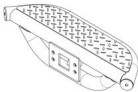

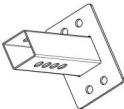



El paso de enganche puede interferir con el funcionamiento del sensor de respaldo OE en Varios vehículos de último modelo. Si su vehículo viene equipado con un sensor de retroceso OE, se recomienda que lo verifique antes de comprarlo. Está estrictamente prohibido utilizar el producto más allá de su carga máxima.

### CONFIGURACIÓN DE PRODUCCIÓN

Modelo	GJ0066
Carga máxima (libras)	350
Longitud (pulg.)	25,7

### LISTA DE PARTES

ARTÍCULO	Nombre	IMAGEN	CANTIDAD	ARTÍCULO	Nombre	IMAGEN	CANTIDAD
1	Paso principal		1 pieza 8		en forma de U tornillo		1 PC
2	Conectando tubos cuadrados		1 pieza 9		hierro estable lámina		1 PC
3	varilla de bloqueo		1 unidad 10		Hexagonal tuerca (M10)		6 piezas
4	Alicates		1 unidad 11		Arandela plana		6 piezas

5	Cerradura (con 2 llaves)		1 juego	12	Elástico lavadora		6 piezas
6	Pin de seguridad		1 unidad	13	Hexagonal perno M10 * 30		4 piezas
7	anillo de sellado		8 piezas	14	manual		1 PC

## INSTRUCCIONES DE INSTALACIÓN

1. Ensamble el escalón principal y los tubos cuadrados de conexión (use 4 hexágonos). pernos M10 \* 30, 4 arandelas planas y 4 arandelas elásticas), como se muestra en la siguiente figura:

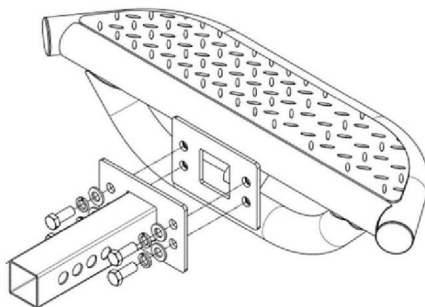

2. Inserte el paso del enganche en el receptor del enganche. Ajusta y selecciona el posición adecuada del orificio para la alineación.

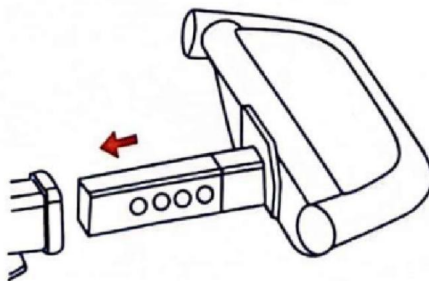

3. Inserte la varilla de bloqueo en el orificio y el pinzi (kit de bloqueo de configuración del producto, y este paso le permite elegir instalar el kit de bloqueo según sea necesario).

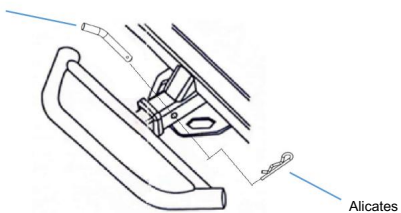

4. Instalación del estabilizador (Use 1 tornillo en forma de U, 2 arandelas planas y 2 arandelas elásticas, 2 tuercas hexagonales).

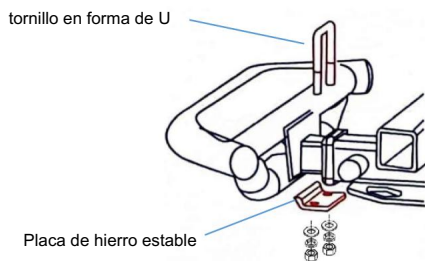

Fabricante: Shanghaimuxinmuyeyouxiangongsi

Dirección: Shuangchenglu 803nong11hao1602A-1609shi, baoshanqu, shanghai  
200000 CN.

Importado a AUS: SIHAO PTY LTD.

1 ROKEVA STREET ASTWOOD NSW 2122 Australia

Importado a EE. UU.: Sanven Technology Ltd.

Suite 250, 9166 Anaheim Place, Rancho Cucamonga, CA 91730

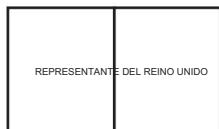

YH CONSULTING LIMITADO.

C/O YH Consulting Limited Oficina 147,  
Centurion House, London Road,  
Staines-upon-Thames, Surrey, TW18 4AX



E-CrossStu GmbH

Mainzer Landstr.69,  
60329 Fráncfort del Meno.



**VEVOR<sup>®</sup>**

**TOUGH TOOLS, HALF PRICE**

Soporte técnico y certificado de garantía  
electrónica [www.vevor.com/support](http://www.vevor.com/support)



# VEVOR<sup>®</sup>

## TOUGH TOOLS, HALF PRICE

Wsparcie techniczne i certyfikat e-gwarancji [www.vevor.com/support](http://www.vevor.com/support)

### KROK ZACZEPU

Nadal dokładamy wszelkich starań, aby zapewnić Państwu narzędzia w konkurencyjnej cenie.

„Zaoszczędź o połowę”, „o połowę ceny” lub inne podobne wyrażenia używane przez nas przedstawiają jedynie szacunkową oszczędność, jaką możesz zyskać kupując u nas określone narzędzia w porównaniu z głównymi najlepszymi markami i niekoniecznie oznaczają uwzględnienie wszystkich kategorii oferowanych narzędzi przez nas. Przypominamy, aby podczas składania zamówienia u nas dokładnie sprawdzić, czy faktycznie oszczędzasz połowę w porównaniu z czołowymi markami.

**VEVOR**<sup>®</sup>  
TOUGH TOOLS, HALF PRICE

KROK ZACZEPU



POTRZEBUJĘ POMOCY? SKONTAKTUJ SIĘ Z NAMI!

Masz pytania dotyczące produktu? Potrzebujesz wsparcia technicznego? Prosimy o kontakt:  
Wsparcie

techniczne i certyfikat e-gwarancji [www.vevor.com/support](http://www.vevor.com/support)

To jest oryginalna instrukcja. Przed przystąpieniem do obsługi prosimy o dokładne zapoznanie się ze wszystkimi instrukcjami. VEVOR zastrzega sobie jasną interpretację naszej instrukcji obsługi. Wygląd produktu zależy od produktu, który otrzymałeś. Proszę wybaczyć nam, że nie będziemy ponownie informować Państwa, jeśli pojawią się jakieś aktualizacje technologii lub oprogramowania naszego produktu.



Ostrzeżenie — aby zmniejszyć ryzyko obrażeń, użytkownik musi przeczytać instrukcję obsługi.









### OSTRZEŻENIE

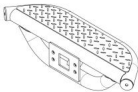

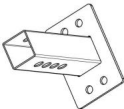



Ten produkt ma zastosowanie wyłącznie do urządzeń do montażu odbiornika 2". Hitch Step może zakłócać działanie czujnika cofania OE w kilka późnych modeli pojazdów. Jeśli Twój pojazd jest wyposażony w czujnik cofania OE, zaleca się sprawdzenie przed zakupem. Surowo zabrania się używania produktu powyżej jego maksymalnego obciążenia.

### KONFIGURACJA PRODUKCYJNA

Model	GJ0066
Maksymalne obciążenie (funty)	350
Długość (cale)	25,7

### LISTA CZĘŚCI

PRZEDMIOT	Nazwa	ZDJĘCIE	ILOŚĆ ELEMENT	Nazwa OBRAZ	ILOŚĆ	
1	Główny krok		1 szt . 8	W kształcie litery U śruba		1 szt
2	Złączony rurki kwadratowe		1 szt . 9	Stabilne żelazo płyta		1 szt
3	Pręt blokujący		1 szt . 10	Sześciokątny nakrętka (M10)		6 szt
4	Szczypce		1 szt . 11	Podkładka płaska		6 szt

5	Zamek (z 2 Klucze)		1 zestaw	12	Elastyczny pralka		6 szt
6	Trzpień blokujący		1 szt. 13		Sześciokątny śruba M10 * 30		4 szt
7	Uszczelka		8 szt. 14		podręcznik		1 szt

## INSTRUKCJE INSTALACJI

1. Zamontuj stopień główny i rurki łączące (użyj 4 sześciokątnych rurek) śruby M10 \* 30, 4 podkładki płaskie i 4 podkładki elastyczne), jak pokazano na rysunku następujący rysunek:

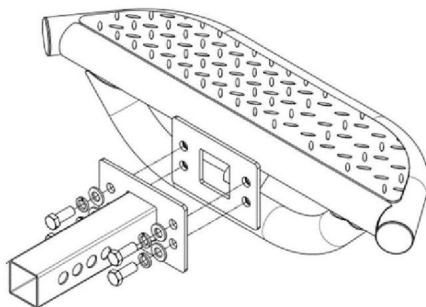

2. Włóż stopień zaczepu do gniazda zaczepu. Dostosuj i wybierz odpowiednie położenie otworu w celu wyrównania.

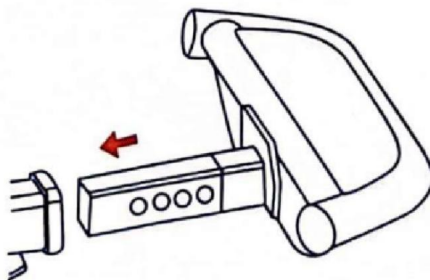

3. Włóż pręt blokujący do otworu i pinzi (zestaw blokady konfiguracji produktu; ten krok pozwala wybrać instalację zestawu blokującego w zależności od potrzeb ).

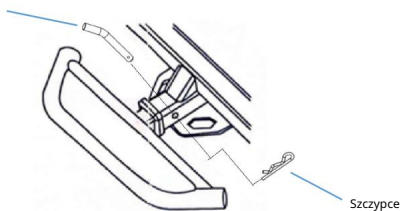

4. Montaż stabilizatora (użyj 1 śruby w kształcie litery U, 2 podkładek płaskich i 2 podkładek elastycznych, 2 nakrętek sześciokątnych).

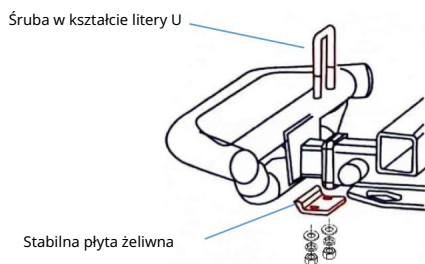

Producent: Shanghaimuxinmuyeyouxiangongsi

Adres: Shuangchenglu 803nong11hao1602A-1609shi, baoshanqu, szanghaj 200000  
CN.

Import do AUS: SIHAO PTY LTD.

1 ROKEVA STRETEASTWOOD NSW 2122 Australia

Import do USA: Sanven Technology Ltd.

Apartament 250, 9166 Anaheim Place, Rancho Cucamonga, Kalifornia 91730



YH CONSULTING SPÓŁKA Z OGRANICZONĄ ODPOWIEDZIALNOŚCIĄ.

C/O YH Consulting Limited Office 147,  
Centurion House, London Road,  
Staines-upon-Thames, Surrey, TW18 4AX



E-CrossStu GmbH  
Mainzer Landstr.69,  
60329 Frankfurt nad Menem.



**VEVOR<sup>®</sup>**

**TOUGH TOOLS, HALF PRICE**

Wsparcie techniczne i certyfikat e-gwarancji

[www.vevor.com/support](http://www.vevor.com/support)



# VEVOR<sup>®</sup>

## TOUGH TOOLS, HALF PRICE

Technische ondersteuning en e-garantiecertificaat [www.vevor.com/support](http://www.vevor.com/support)

### HITCH-STAP

We blijven ons inzetten om u gereedschap tegen een concurrerende prijs te bieden.

'Bespaar de helft', 'Halve prijs' of andere soortgelijke uitdrukkingen die door ons worden gebruikt vertegenwoordigen slechts een schatting van de besparingen die u zou kunnen profiteren als u bepaalde gereedschappen bij ons koopt in vergelijking met de grote topmerken en betekenen niet noodzakelijkerwijs dat ze alle categorieën van aangeboden gereedschappen dekken. door ons. Wij verzoeken u vriendelijk om bij het plaatsen van een bestelling bij ons goed na te gaan of u daadwerkelijk de helft bespaart in vergelijking met de grote topmerken.

# VEVOR<sup>®</sup>

TOUGH TOOLS, HALF PRICE

## HITCH-STAP



**HULP NODIG? NEEM CONTACT MET ONS OP!**

Heeft u productvragen? Technische ondersteuning nodig? Neem gerust contact met ons op:

**Technische**

**ondersteuning en e-garantiecertificaat [www.vevor.com/  
support](http://www.vevor.com/support)**

Dit is de originele instructie. Lees alle instructies in de handleiding zorgvuldig door voordat u ermee aan de slag gaat. VEVOR behoudt zich een duidelijke interpretatie van onze gebruikershandleiding voor. Het uiterlijk van het product is afhankelijk van het product dat u heeft ontvangen. Vergeef ons alstublieft dat we u niet opnieuw zullen informeren als er technologie- of software-updates zijn voor ons product.



Waarschuwing-Om het risico op letsel te verminderen, moet de gebruiker de volgende instructies lezen  
gebruiksaanwijzing zorgvuldig.









### WAARSCHUWING

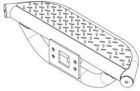

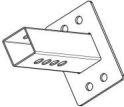



ÿ Dit product is alleen van toepassing op 2"-ontvangermontageapparaten. ÿ Hitch Step kan de werking van de OE-back-upsensor op verschillende late modelvoertuigen. Als uw voertuig is uitgerust met een originele achteruitsensor, raden wij u aan dit vóór aankoop te controleren. ÿ Het is ten strengste verboden om het product boven de maximale belasting te gebruiken.

### PRODUCTIECONFIGURATIE

Model	GJ0066
Maximale belasting (lbs)	350
Lengte (inch)	25.7

### ONDERDELEN LIJST

ITEM	Naam	AFBEELDING	AANTAL	ITEM	Naam FOTO	AANTAL	
1	Belangrijkste stap		1 ST	8	U-vormig schroef		1 ST
2	Verbinden vierkante buizen		1 ST	9	Stabiel ijzer bord		1 ST
3	Vergrendelingsstang		1 ST	10	Zeshoekig moer(M10)		6 st
4	Tang		1 ST	11	Platte sluitring		6 st

5	Slot (met 2 sleutels)		1 set	12	Elastisch wasmachine		6 st
6	Borgpen		1 ST 13		Zeshoekig bout M10 * 30		4 st
7	Afsluitring		8PC 14		handmatig		1 ST

## INSTALLATIE INSTRUCTIES

1. Monteer de hoofdtrede en de verbindingsvierkante buizen (gebruik 4 zeshoeken).  
bouts M10 \* 30, 4 platte ringen en 4 elastische ringen), zoals weergegeven in de volgende figuur:

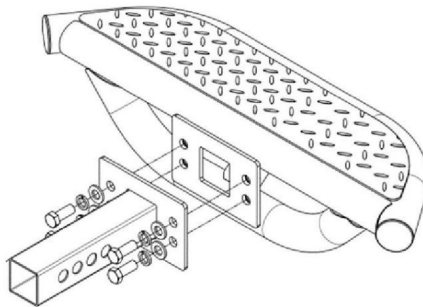

2. Steek de trekhaak in de trekhaakontvanger. Pas aan en selecteer de juiste gatpositie voor uitlijning.

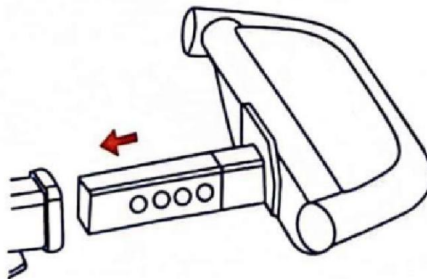

3. Steek de vergrendelingsstang in het gat en de pinzi (productconfiguratie-slotset, en met deze stap kunt u ervoor kiezen om de vergrendelingsset te installeren als de vergrendelingsstang nodig is).

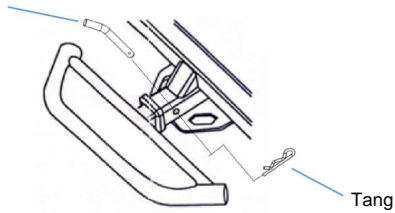

4. Installatie van de stabilisator (gebruik 1 U-vormige schroef, 2 platte ringen en 2 elastische ringen, 2 zeshoekige moeren).

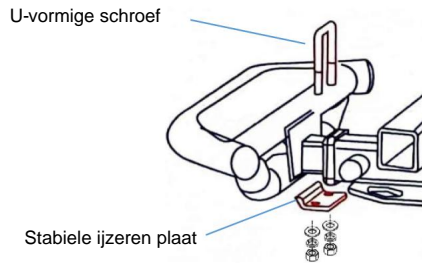

**Fabrikant:** Shanghaimuxinmuyeyouxiangongsi

**Adres:** Shuangchenglu 803nong11hao1602A-1609shi, baoshanqu, shanghai  
200000 CN.

**Geïmporteerd naar AUS:** SIHAO PTY LTD.

1 ROKEVA STREETEASTWOOD NSW 2122 Australië

**Geïmporteerd naar de VS:** Sanven Technology Ltd.

Suite 250, 9166 Anaheim Place, Rancho Cucamonga, CA 91730



YH CONSULTING LIMITED.

C/O YH Consulting Limited Office 147,

Centurion House, London Road,

Staines-upon-Thames, Surrey, TW18 4AX



E-CrossStu GmbH

Mainzer Landstr.69,

60329 Frankfurt am Main.



**VEVOR**<sup>®</sup>

**TOUGH TOOLS, HALF PRICE**

Technische ondersteuning en e-  
garantiecertificaat [www.vevor.com/support](http://www.vevor.com/support)



# **VEVOR<sup>®</sup>**

## **TOUGH TOOLS, HALF PRICE**

Teknisk support och e-garanticertifikat [www.vevor.com/support](http://www.vevor.com/support)

### **HÄCKSTEG**

Vi fortsätter att vara engagerade i att ge dig verktyg till konkurrenskraftiga priser.

"Spara hälften", "halva priset" eller andra liknande uttryck som används av oss representerar bara en uppskattning av besparingar du kan dra nytta av att köpa vissa verktyg hos oss jämfört med de stora toppmärkena och betyder inte nödvändigtvis att täcka alla kategorier av verktyg som erbjuds av oss. Du påminns vänligen om att noggrant kontrollera när du gör en beställning hos oss om du faktiskt sparar hälften i jämförelse med de främsta stora varumärkena.

**VEVOR**<sup>®</sup>  
TOUGH TOOLS, HALF PRICE

**HÄCKSTEG**



**BEHÖVS HJÄLP? KONTAKTA OSS!**

Har du produktfrågor? Behöver du teknisk support? Kontakta oss gärna: **Teknisk support och e-garanticertifikat [www.vevor.com/support](http://www.vevor.com/support)**

Detta är den ursprungliga instruktionen, läs alla instruktioner noggrant innan du använder den. VEVOR reserverar sig för en tydlig tolkning av vår användarmanual. Utseendet på produkten är beroende av den produkt du fått. Ursäkta oss att vi inte kommer att informera dig igen om det finns någon teknik eller mjukvaruuppdateringar på vår produkt.



Varning - För att minska risken för skador måste användaren läsa igenom bruksanvisningen noggrant.

## VARNING

Den här produkten är endast tillämpbar på 2 "mottagarmonteringsenheter.

Hitch Step kan störa driften av OE-backupsensorn på

flera sena modellfordon. Om ditt fordon är utrustat med en OE reservsensor,









rekommenderas det att du kontrollerar det innan du köper det. Den

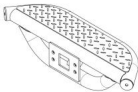

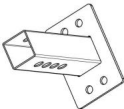



Det är strängt förbjudet att använda produkten utöver dess maximala belastning.

## PRODUKTIONSKONFIGURATION

Modell	GJ0066
Maximal belastning (lbs)	350
Längd (tum)	25.7

## DELLISTA

ARTIKEL	namn	BILD	ANTAL	ARTIKEL	Namn	BILD	ANTAL
1	Huvudsteg		1 st 8		U-formad skruva		1 ST
2	Ansluter fyrkantiga rör		1st 9		Stabilt järn tallrik		1 ST
3	Låsstång		1 st 10		Hexagonal mutter (M10)		6 st
4	Tång		1 st 11		Platt bricka		6 st

5	Lås (med 2 nycklar)		1 set	12	Elastisk tvättmaskin		6 st
6	Låsstift		1 st 13		Hexagonal bult M10 * 30		4 st
7	Tätningring		8 st 14		manuell		1 ST

## INSTALLATIONS INSTRUKTIONER

1. Montera huvudsteget och anslutning av fyrkantströr (Använd 4 Hexagon bultar M10 \* 30, 4 platta brickor och 4 elastiska brickor), som visas i följande figur:

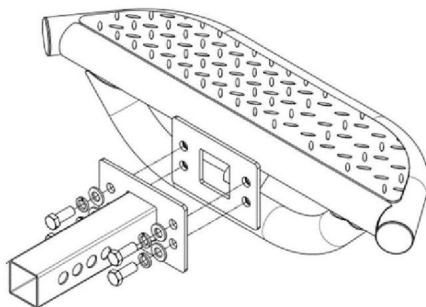

2. Sätt in kopplingssteget i kopplingsmottagaren. Justera och välj lämplig hålposition för inriktning.

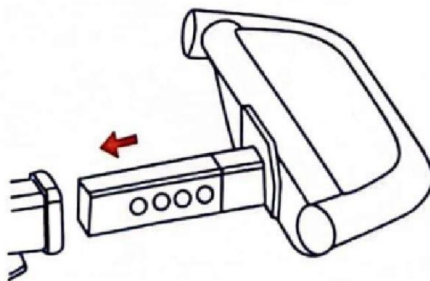

3. Sätt in låsstången i hålet och stiftet (Produktkonfigurationslåssats, och detta steg låter dig välja att installera låssatsen efter behov av låsstång ).

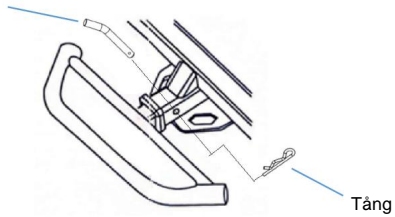

4. Installation av stabilisator (Använd 1 U-formad skruv, 2 platta brickor och 2 elastiska brickor, 2 sexkantiga muttrar).

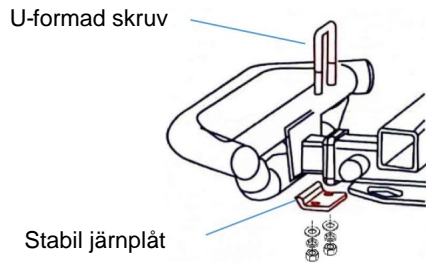

**Tillverkare:** Shanghaimuxinmuyeyouxiangongsi

**Adress:** Shuangchenglu 803nong11hao1602A-1609shi, baoshanqu, shanghai  
200000 CN.

**Importerad till AUS:** SIHAO PTY LTD.

1 ROKEVA STREETEASTWOOD NSW 2122 Australien

**Importerad till USA:** Sanven Technology Ltd.

Suite 250, 9166 Anaheim Place, Rancho Cucamonga, CA 91730



YH CONSULTING LIMITED.

C/O YH Consulting Limited Office 147,  
Centurion House, London Road,  
Staines-upon-Thames, Surrey, TW18 4AX



E-CrossStu GmbH

Mainzer Landstr.69,  
60329 Frankfurt am Main.



**VEVOR**<sup>®</sup>

**TOUGH TOOLS, HALF PRICE**

**Teknisk support och e-garanticertifikat**

**[www.vevor.com/support](http://www.vevor.com/support)**