

VEVOR[®]

TOUGH TOOLS, HALF PRICE

Technical Support and E-Warranty Certificate

<https://www.vevor.com/support>

SAWMILL GUIDE RAIL

USER MANUAL

We continue to be committed to offering tools at competitive prices. "Save Half", "Half Price", or any other similar expressions used by us only represent an estimate of savings you might benefit from buying certain tools with us compared to the major top brands and do not necessarily mean to cover all categories of tools offered by us. You are kindly reminded to verify carefully when placing an order with us if you are saving half in comparison with the top major brands.

VEVOR[®]

SAWMILL GUIDE RAIL (9FT)



NEED HELP? CONTACT US!









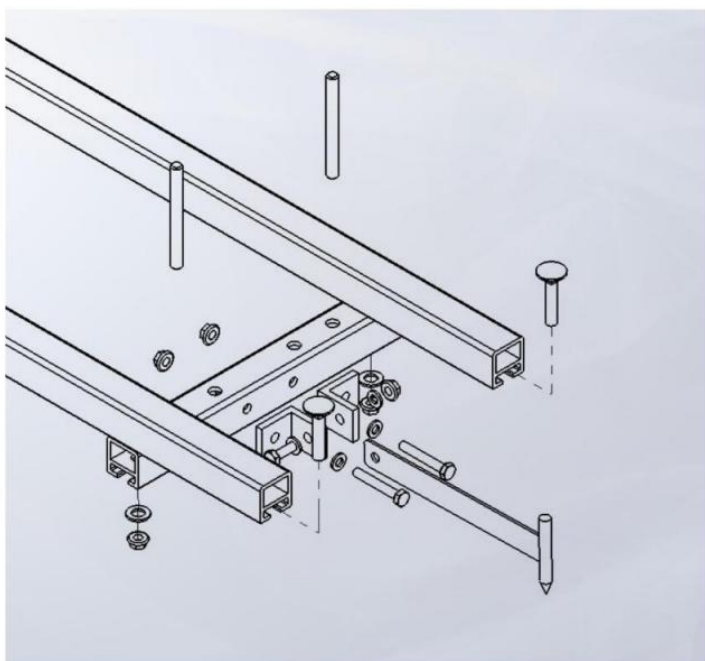
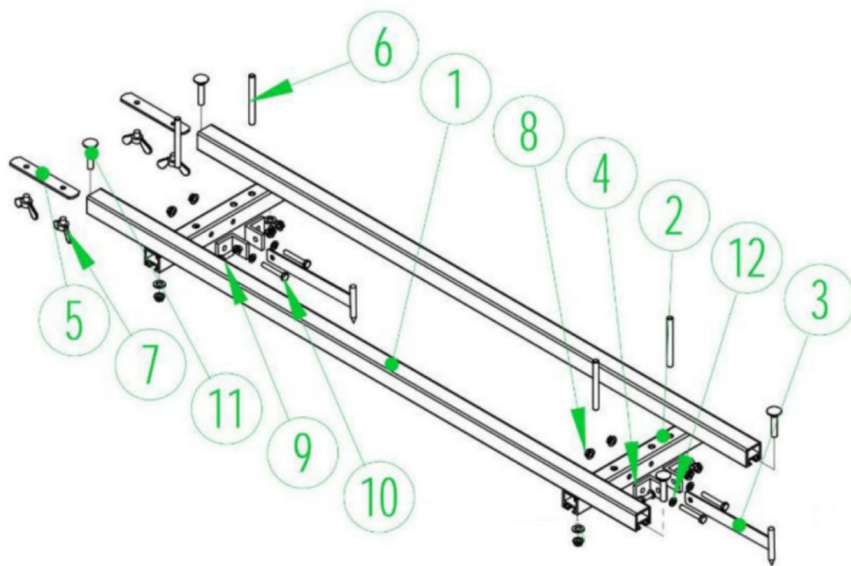







Have product questions? Need technical support? Please feel free to contact us:

 CustomerService@vevor.com

This is the original instruction, please read all manual instructions carefully before operating. VEVOR reserves a clear interpretation of our user manual. The appearance of the product shall be subject to the product you received. Please forgive us that we won't inform you again if there are any technology or software updates on our product.

Drawing and parts list



NO	QTY	PIC	DISCRIPTION
1	6		Side rail
2	4		Cross bar
3	4		Dog
4	8		Dog hinge plate
5	4		Connect bar
6	8		Leveling screw
7	4		Butterfly screw
8	12		Small nut
9	4		Cross blot
10	8		Long blot
11	8		Carriage blot
12	24		Small washer
13	1		Allen wrench
14	2		Wrench
15	1		Toolkit
16	1		User manual

Assembling Instruction

1. Unpack the rail-kit and lay out all parts, put the same parts together for selecting.
2. Attach both dog hinges plates (No.4) to cross bar (No.2), with bolts washers and nuts (No.10,12 and 8). Do not tighten until dog is attached.



3. Attach dog (No.3) to hinge plates (No.4) with bolt, washers and nut (No.9,12 and 8). Tighten all bolts.



4. Assemble carriage bolts (No.11), nuts and washer (No.12) through cross bar (No.2) leave loose. Head of carriage bolt must be as shown.



5. Install leveling screws (No.6) into cross bar (No.2) slotted end of screw is in the same direction as the head of the carriage bolts.

6. Repeat for all cross bar kits.

7. Slid carriage bolts in cross bar into rails. Do not tighten until you set up the EZ-RAILS on the log. Dog orientation can be in either direction.

8. Once cross bars are located on log, tighten carriage bolts.

9. To extend the rail to longer version, please use 2 of the connect bar (No.5) and each end fastened with a butterfly screw (No.7).



Manufacturer: Yongkang jinjian hardware factory

Address: 11 Huabao Road, Zhiying Industrial Zone II, Yongkang City,
Zhejiang Province, China

VEVOR[®]

TOUGH TOOLS, HALF PRICE

Technical Support and E-Warranty Certificate

<https://www.vevor.com/support>

VEVOR®

TOUGH TOOLS, HALF PRICE

Wsparcie techniczne i certyfikat e-gwarancji

<https://www.vevor.com/support>

SZYNA PROWADZĄCA TARTAK

INSTRUKCJA OBSŁUGI

Nadal staramy się oferować narzędzia w konkurencyjnych cenach. „Oszczędź połowę”, „Połowa ceny” lub inne podobne wyrażenia używane przez nas stanowią jedynie szacunkowe oszczędności, jakie możesz uzyskać.

Korzyści z zakupu niektórych narzędzi u nas w porównaniu do głównych marek i niekoniecznie oznacza to objęcie wszystkich kategorii narzędzi oferowanych przez nas. Uprzejmie przypominamy, aby sprawdzić dokładnie, czy składając u nas zamówienie zaoszczędzisz połowę ceny w porównaniu z produktami najlepszych marek.

VEVOR[®]

SZYNA PROWADZĄCA TARTAK

9 stóp



POTRZEBUJESZ POMOCY? SKONTAKTUJ SIĘ Z NAMI!









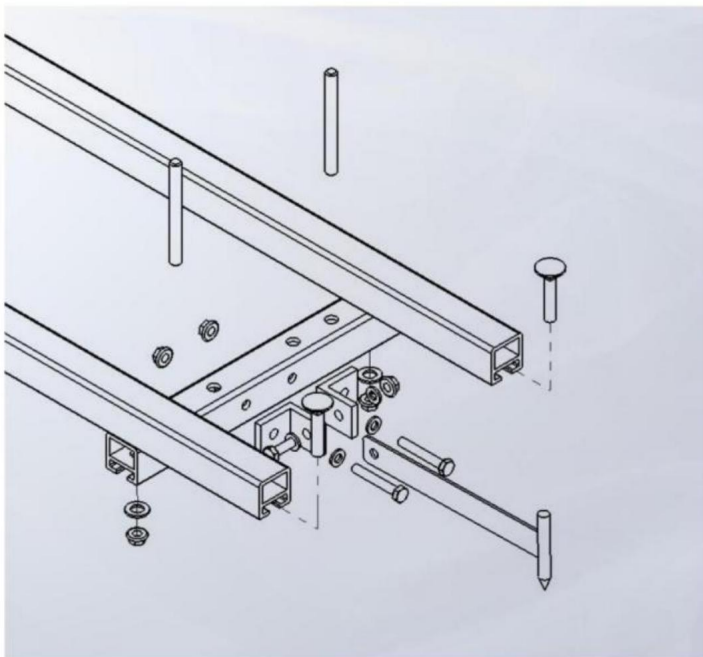
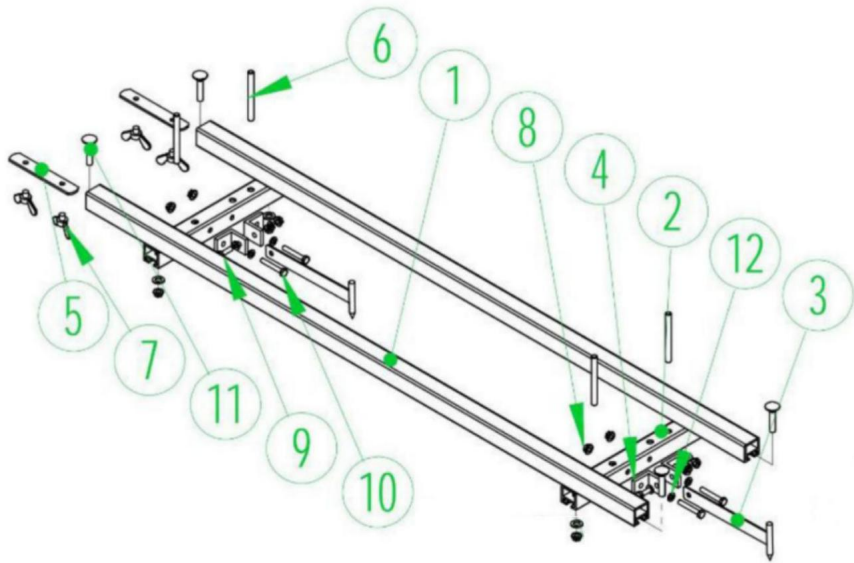







Masz pytania dotyczące produktu? Potrzebujesz wsparcia technicznego? Skontaktuj się z nami:

 Obsługa Klienta@vevor.com

To jest oryginalna instrukcja, przed użyciem należy uważnie przeczytać wszystkie instrukcje. VEVOR zastrzega sobie jasną interpretację naszej instrukcji obsługi. Wygląd produktu będzie zależał od produktu, który otrzymałeś. Prosimy o wybaczenie, że nie poinformujemy Cię ponownie, jeśli w naszym produkcie pojawią się jakiegokolwiek aktualizacje technologiczne lub oprogramowania.

Rysunek i lista części



BRAK	ILOŚCI	ZDJĘCIE	OPIS
1	6		Szyna boczna
2	4		Poprzeczka
3	4		Pies
4	8		Zawias dla psa płyta
5	4		Podłącz pasek
6	8		Śruba poziomująca
7	4		Śruba motylkowa
8	12		Mały orzech
9	4		Krzyżowe płamienie
10	8		Długi płam
11	8		Płama porodowa
12	24		Mała pralka
13	1		Klucz imbusowy
14	2		Klucz
15	1		Zestaw narzędzi
16	1		Instrukcja obsługi

Instrukcja montażu

1. Rozpakuj zestaw szyn i rozłóż wszystkie części, a następnie złóż je razem w celu wybrania.
2. Przymocuj obie płytki zawiasów typu „dog” (nr 4) do poprzeczki (nr 2) za pomocą śrub, podkładek i nakrętek (nr 10, 12 i 8). Nie dokręcaj, dopóki nie przymocujesz zawiasu typu „dog”.



3. Przymocuj zaczep (nr 3) do płytek zawiasowych (nr 4) za pomocą śruby, podkładek i nakrętki (nr 9, 12 i 8). Dokręć wszystkie śruby.



4. Zamontuj śruby jezdne (nr 11), nakrętki i podkładkę (nr 12) przez poprzeczkę (Nr 2) pozostaw luźny. Głowa śruby jezdnej musi być taka, jak pokazano.



5. Zamontuj śruby poziomujące (nr 6) w poprzeczce (nr 2). Nacięty koniec śruby powinien znajdować się w tym samym kierunku co głowica śrub ślizgowych.

6. Powtórz te same czynności dla wszystkich zestawów poprzeczek.

7. Wsuń śruby wózka w poprzeczkę do szyn. Nie dokręcaj, dopóki nie ustawisz EZ-RAILS na kłódzie. Orientacja psa może być w obu kierunkach.

8. Po umieszczeniu poprzeczek na kłódzie dokręć śruby podwoziowe.

9. Aby przedłużyć szynę do dłuższej wersji, należy użyć 2 z prętów łączących (nr 5) i każdy koniec przymocowany śrubą motylkową (nr 7).



Producent: fabryka sprzętu Yongkang jinjian

Adres: 11 Huabao Road, Zhiying Industrial Zone II, Yongkang City,
Prowincja Zhejiang, Chiny

VEVOR[®]

TOUGH TOOLS, HALF PRICE

Wsparcie techniczne i certyfikat gwarancji
elektronicznej <https://www.vevor.com/support>

VEVOR®

TOUGH TOOLS, HALF PRICE

Supporto tecnico e certificato di garanzia elettronica

<https://www.vevor.com/support>

GUIDA PER SEGHERIA

MANUALE D'USO

Continuiamo a impegnarci a offrire strumenti a prezzi competitivi. "Risparmia la metà", "Metà prezzo" o qualsiasi altra espressione simile da noi utilizzata rappresenta solo una stima dei risparmi che potresti trarre vantaggio dall'acquisto di determinati utensili da noi rispetto ai principali marchi di punta e non significa necessariamente coprire tutte le categorie di utensili da noi offerti. Ti ricordiamo cortesemente di verificare attentamente quando effettui un ordine con noi se stai risparmiando la metà rispetto ai marchi più importanti.

VEVOR[®]

GUIDA PER SEGHERIA

(9 piedi)



HAI BISOGNO DI AIUTO? CONTATTACI!









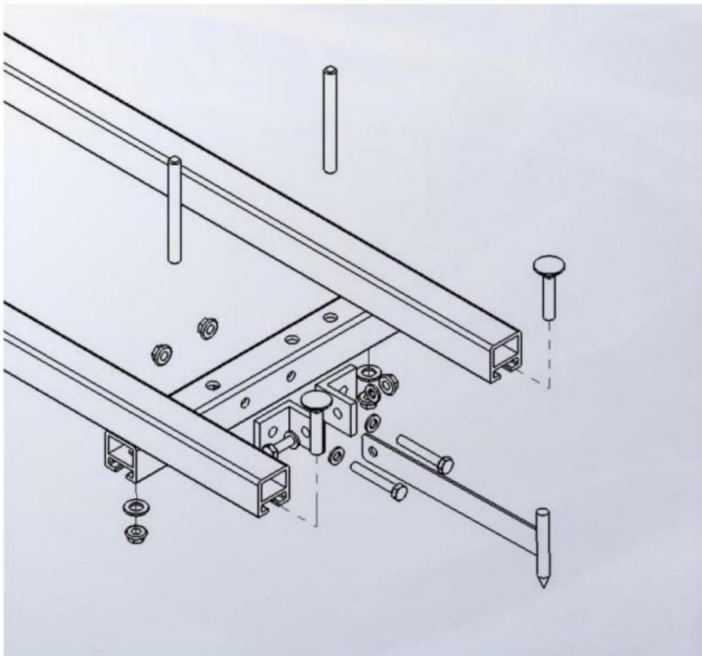
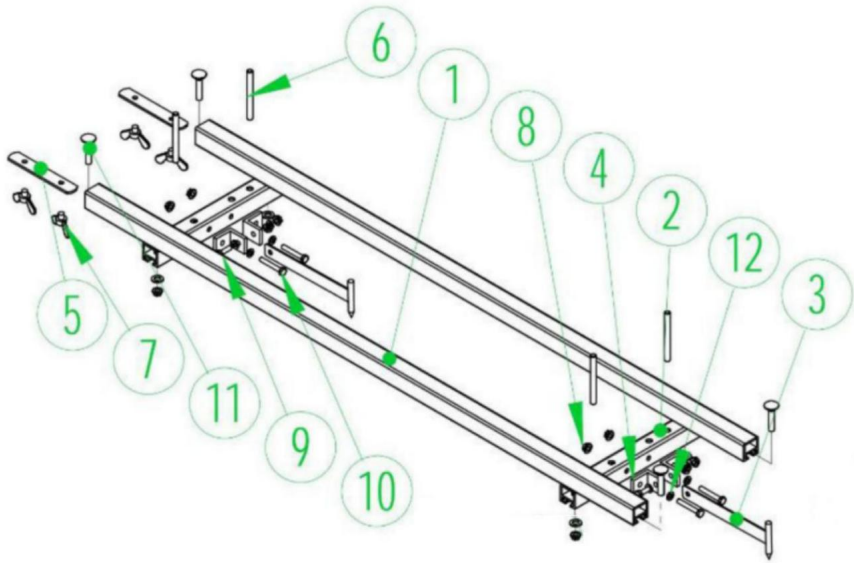







Hai domande sui prodotti? Hai bisogno di supporto tecnico? Non esitare a contattarci:

 Servizio Clienti@vevor.com

Questa è l'istruzione originale, si prega di leggere attentamente tutte le istruzioni del manuale prima di utilizzare. VEVOR si riserva una chiara interpretazione del nostro manuale utente. L'aspetto del prodotto sarà soggetto al prodotto ricevuto. Vi preghiamo di perdonarci se non vi informeremo di nuovo se ci sono aggiornamenti tecnologici o software sul nostro prodotto.

Disegno e lista delle parti



NESSUNA QTY	FOTO	DESCRIZIONE
1	6	 sponda laterale
2	4	 Barra trasversale
3	4	 Cane
4	8	 Cerniera per cani piatto
5	4	 Barra di collegamento
6	8	 Vite di livellamento
7	4	 Vite a farfalla
8	12	 Piccola noce
9	4	 Macchia incrociata
10	8	 Macchia lunga
11	8	 Macchia di carrozza
12	24	 Piccola rondella
13	1	 Chiave a brugola
14	2	 Chiave
15	1	 Kit di strumenti
16	1	 Manuale d'uso

Istruzioni di montaggio

1. Disimballare il kit ferroviario e disporre tutti i componenti, quindi unire gli stessi componenti per la selezione.

2. Fissare entrambe le piastre delle cerniere del cane (n. 4) alla barra trasversale (n. 2), con bulloni, rondelle e dadi (n. 10, 12 e 8). Non stringere finché il cane non è fissato.



3. Fissare il cane (n. 3) alle piastre della cerniera (n. 4) con bullone, rondelle e dado (n. 9, 12 e 8). Serrare tutti i bulloni.



4. Assemblare i bulloni della carrozza (n. 11), i dadi e la rondella (n. 12) attraverso la barra trasversale (No.2) lasciare allentato. La testa del bullone del carrello deve essere come mostrato.



5. Installare le viti di livellamento (n. 6) nella barra trasversale (n. 2); l'estremità scanalata della vite è nella stessa direzione della testa dei bulloni della carrozza.

6. Ripetere la stessa operazione per tutti i kit di barre trasversali.

7. Fai scorrere i bulloni della traversa nelle rotaie. Non stringere finché non hai impostato il EZ-RAILS sul registro. L'orientamento del cane può essere in entrambe le direzioni.

8. Una volta posizionate le barre trasversali sul tronco, serrare i bulloni della carrucola.

9. Per estendere la rotaia a una versione più lunga, utilizzare 2 barre di collegamento (n. 5) e ciascuna estremità fissata con una vite a farfalla (n. 7).



Produttore: fabbrica di hardware Yongkang jinjian

Indirizzo: 11 Huabao Road, Zhiying Industrial Zone II, Yongkang City,
Provincia di Zhejiang, Cina

VEVOR[®]

TOUGH TOOLS, HALF PRICE

Supporto tecnico e certificato di garanzia
elettronica <https://www.vevor.com/support>

VEVOR[®]

TOUGH TOOLS, HALF PRICE

Soporte técnico y certificado de garantía electrónica

<https://www.vevor.com/support>

RIEL GUÍA PARA ASERRADERO

MANUAL DEL USUARIO

Seguimos comprometidos a ofrecer herramientas a precios competitivos. "Ahorre la mitad", "Mitad de precio" o cualquier otra expresión similar utilizada por nosotros solo representa una estimación de los ahorros que podría

Se benefician de comprar ciertas herramientas con nosotros en comparación con las principales marcas y no necesariamente cubren todas las categorías de herramientas que ofrecemos. Se le recuerda amablemente Verifique cuidadosamente al realizar un pedido con nosotros si está ahorrando la mitad en comparación con las principales marcas.

VEVOR[®]

RIEL GUÍA PARA ASERRADERO

(9 pies)



¿NECESITA AYUDA? ¡CONTÁCTENOS!

¿Tiene preguntas sobre el producto? ¿Necesita asistencia técnica? No dude en ponerse en contacto con nosotros:









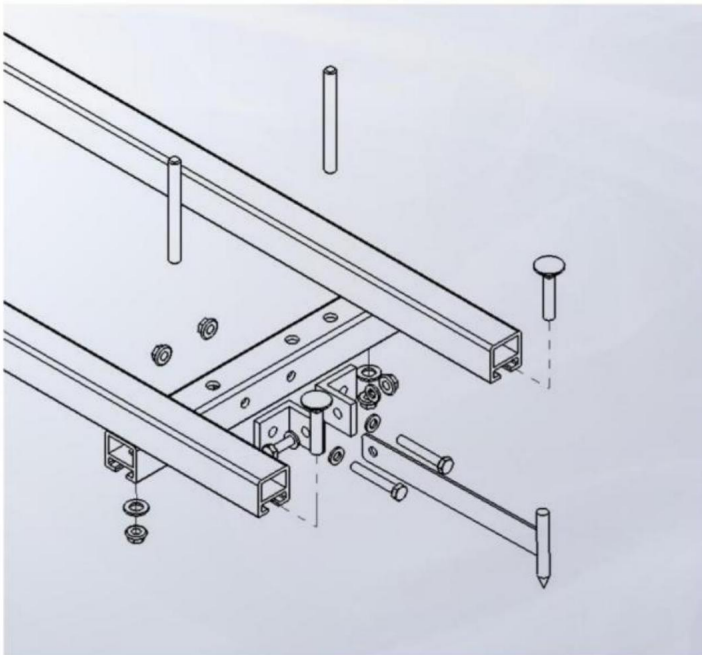
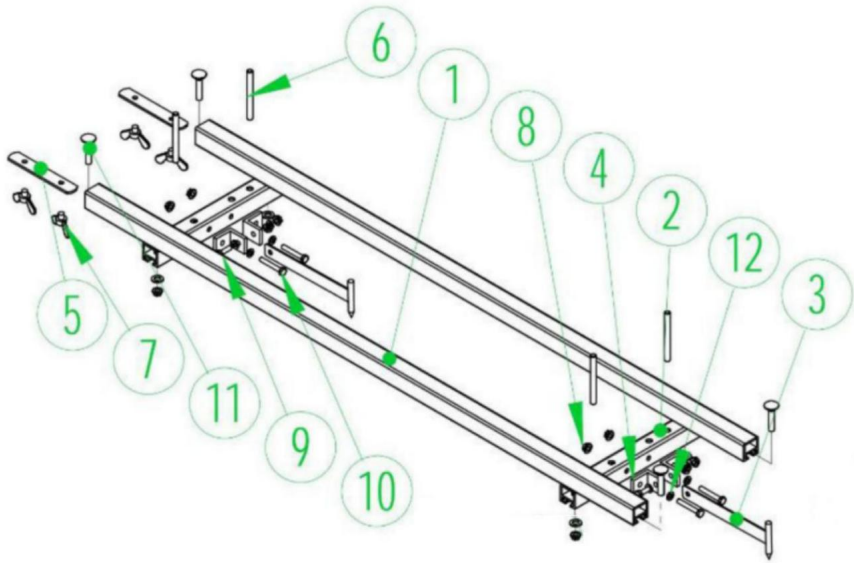









Servicio de atención al cliente@vevor.com

Estas son las instrucciones originales, lea atentamente todas las instrucciones del manual antes de utilizar el producto. VEVOR se reserva una interpretación clara de nuestro manual de usuario. La apariencia del producto estará sujeta al producto que recibió. Perdónenos por no informarle nuevamente si hay actualizaciones de tecnología o software en nuestro producto.

Dibujo y lista de piezas



SIN CANTIDAD	CANTIDAD	FOTO	DESCRIPCIÓN
1	6		Riel lateral
2	4		Barra transversal
3	4		Perro
4	8		Bisagra para perros lámina
5	4		Barra de conexión
6	8		Tornillo nivelador
7	4		Tornillo de mariposa
8	12		Tuerca pequeña
9	4		Transferencia cruzada
10	8		Mancha larga
11	8		Mancha de transporte
12	24		Lavadora pequeña
13	1		Llave Allen
14	2		Llave inglesa
15	1		Kit de herramientas
16	1		Manual de usuario

Instrucciones de montaje

1. Desempaquete el kit de riel y coloque todas las piezas, junte las mismas piezas para seleccionarlás.
2. Fije las dos placas de bisagras de la garra (n.º 4) a la barra transversal (n.º 2) con pernos, arandelas y tuercas (n.º 10, 12 y 8). No ajuste hasta que la garra esté fijada.



3. Fije el perno (n.º 3) a las placas de bisagra (n.º 4) con perno, arandelas y tuercas (n.º 9, 12 y 8). Apriete todos los pernos.



4. Ensamble los pernos del carro (n.º 11), las tuercas y las arandelas (n.º 12) a través de la barra transversal.

(No. 2) Déjelo suelto. La cabeza del perno de carruaje debe quedar como se muestra.



5. Instale los tornillos niveladores (n.º 6) en la barra transversal (n.º 2). El extremo ranurado del tornillo está en la misma dirección que la cabeza de los pernos del carro.

6. Repita el procedimiento para todos los kits de barras transversales.

7. Deslice los pernos de carruaje en la barra transversal dentro de los rieles. No ajuste hasta que haya configurado el EZ-RAILS en el tronco. La orientación del perro puede ser en cualquier dirección.

8. Una vez que las barras transversales estén ubicadas en el tronco, apriete los pernos del carro.

9. Para extender el riel a una versión más larga, utilice 2 de las barras de conexión (n.º 5) y

Cada extremo está fijado con un tornillo de mariposa (n.º 7).



Fabricante: fábrica de hardware Yongkang jinjian

Dirección: 11 Huabao Road, Zhiying Industrial Zone II, ciudad de Yongkang,
Provincia de Zhejiang, China

VEVOR[®]

TOUGH TOOLS, HALF PRICE

Soporte técnico y certificado de garantía
electrónica <https://www.vevor.com/support>

VEVOR®

TOUGH TOOLS, HALF PRICE

Teknisk support och e-garanticertifikat

<https://www.vevor.com/support>

SÅGBRUK GUIDE RAIL

ANVÄNDARMANUAL

Vi fortsätter att vara engagerade i att erbjuda verktyg till konkurrenskraftiga priser. "Spara halva", "halva priset" eller andra liknande uttryck som används av oss representerar endast en uppskattning av besparingar du kan dra nytta av att köpa vissa verktyg hos oss jämfört med de stora toppmärkena och betyder inte nödvändigtvis att täcka alla kategorier av verktyg som erbjuds av oss. Du påminns vänligt om att verifiera noggrant när du gör en beställning hos oss om du sparar hälften i jämförelse med de främsta stora varumärkena.

VEVOR[®]

SÅGBRUK GUIDE RAIL

9FT



BEHÖVER HJÄLP? KONTAKTA OSS!

Har du produktfrågor? Behöver du teknisk support? Kontakta oss gärna:









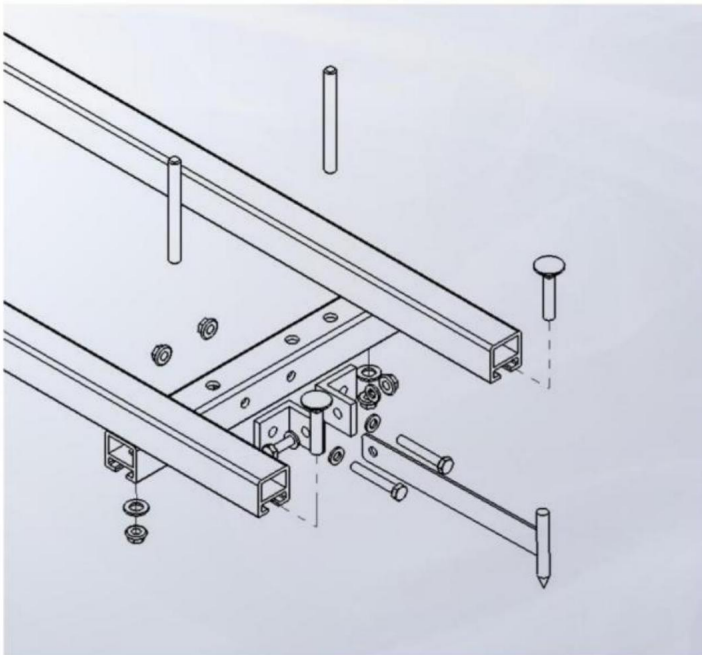
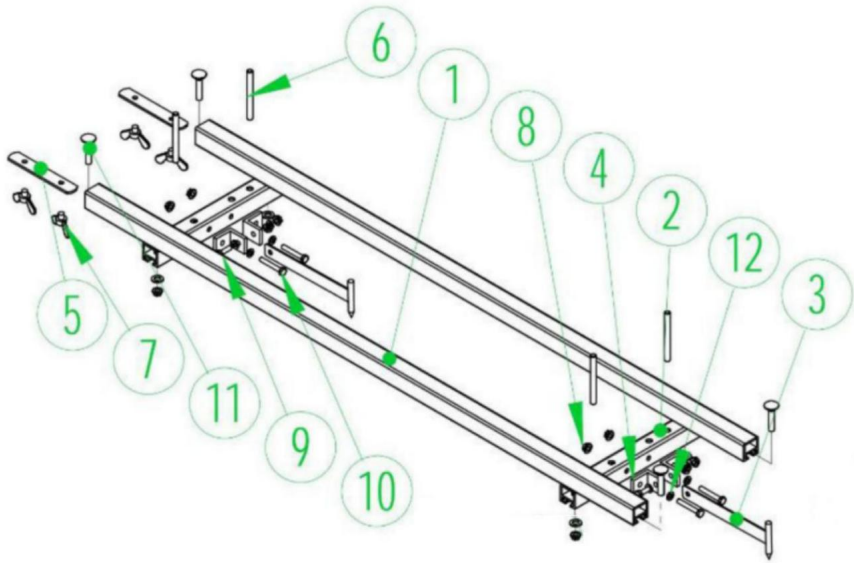









CustomerService@vevor.com

Detta är den ursprungliga instruktionen, läs alla instruktioner noggrant innan du använder den. VEVOR reserverar sig för en tydlig tolkning av vår användarmanual. Utseendet på produkten är beroende av den produkt du fått. Ursäkta oss att vi inte kommer att informera dig igen om det finns någon teknik eller mjukvaruuppdateringar på vår produkt.

Ritning och dellista



INGEN	ANTAL	BILD	BESKRIVNING
1	6		Sidoskena
2	4		Tvärstång
3	4		Hund
4	8		Hundgångjärn tallrik
5	4		Anslut bar
6	8		Utjämningskruv
7	4		Fjärilsskruv
8	12		Liten mutter
9	4		Cross blot
10	8		Lång fläck
11	8		Vagn blot
12	24		Liten tvättmaskin
13	1		Insexnyckel
14	2		Rycka
15	1		Verktygslåda
16	1		Användarmanual

Monteringsinstruktion

1. Packa upp skensatsen och lägg ut alla delar, sätt ihop samma delar för val.
2. Fäst bägge gångjärnsplattorna (nr 4) på tvärstången (nr 2) med bultar, brickor och muttrar (nr 10, 12 och 8). Dra inte åt förrän hunden är fäst.



3. Fäst medbringaren (nr 3) på gångjärnsplattorna (nr 4) med bult, brickor och mutter (nr 9, 12 och 8). Dra åt alla bultar.



4. Montera vagnbultar (nr 11), muttrar och bricka (nr 12) genom tvärbalken (Nr.2) lämna löst. Bulthuvudet på vagnen måste vara som visas.



5. Montera utjämningskruvarna (nr 6) i tvärstången (nr 2) den slitsade änden av skruven är i samma riktning som huvudet på vagnbultarna.
6. Upprepa för alla tvärstångssatser.
7. Skjut in vagnbultarna i tvärstången i skenorna. Dra inte åt förrän du har satt upp EZ-RAILS på stocken. Hundens orientering kan vara åt båda hållen.
8. När tvärbalkarna är placerade på stocken, dra åt vagnens bultar.
9. För att förlänga skenan till en längre version, använd 2 av kopplingsstången (nr. 5) och varje ände fästs med en fjärlilsskruv (nr 7).



Tillverkare: Yongkang jinjian hårdvarufabrik

Adress: 11 Huabao Road, Zhiying Industrial Zone II, Yongkang City,
Zhejiang-provinsen, Kina

VEVOR[®]

TOUGH TOOLS, HALF PRICE

Teknisk support och e-garanticertifikat <https://>

www.vevor.com/support

VEVOR[®]

TOUGH TOOLS, HALF PRICE

Technische ondersteuning en e-garantiecertificaat

<https://www.vevor.com/support>

ZAAGMOLEN GELEIDRAIL

GEBRUIKERSHANDLEIDING

Wij blijven ons inzetten om gereedschappen tegen concurrerende prijzen aan te bieden. "Save Half", "Half Price" of andere soortgelijke uitdrukkingen die wij gebruiken, vertegenwoordigen slechts een schatting van de besparingen die u mogelijk kunt behalen. profiteren van het kopen van bepaalde gereedschappen bij ons in vergelijking met de grote topmerken en betekenen niet noodzakelijkerwijs dat alle categorieën gereedschappen die wij aanbieden, worden gedekt. U wordt vriendelijk herinnerd aan Controleer zorgvuldig wanneer u een bestelling bij ons plaatst of u de helft bespaart ten opzichte van de grote topmerken.

VEVOR[®]

ZAAGMOLEN GELEIDERAIL
(9 voet)



HULP NODIG? NEEM CONTACT MET ONS OP!









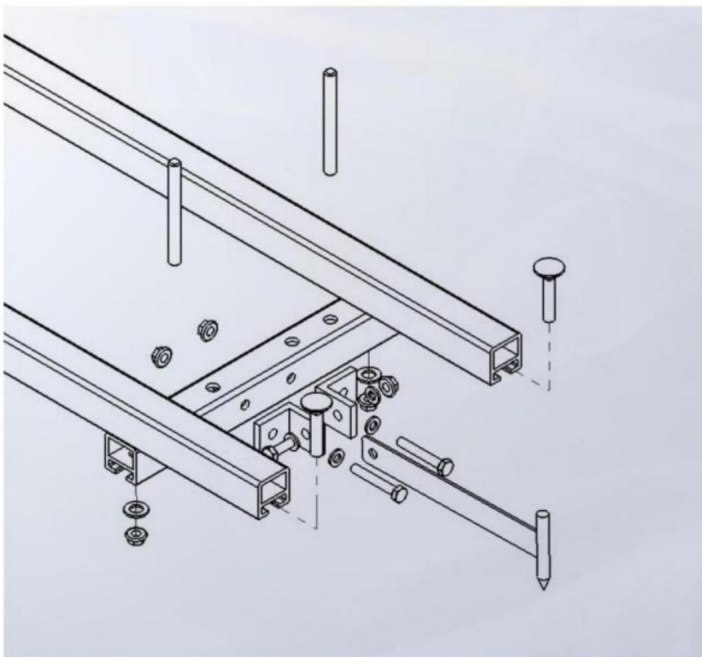
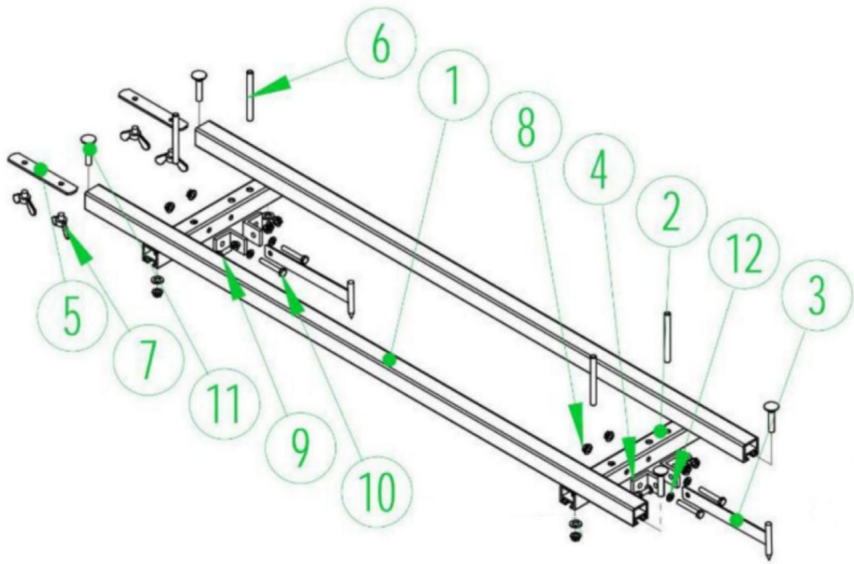







Heeft u vragen over het product? Heeft u technische ondersteuning nodig? Neem dan gerust contact met ons op:

 **Klantenservice@vevor.com**

Dit is de originele instructie, lees alle handleidingen zorgvuldig door voordat u het product gebruikt. VEVOR behoudt zich een duidelijke interpretatie van onze gebruikershandleiding voor. Het uiterlijk van het product is afhankelijk van het product dat u hebt ontvangen. Vergeef ons dat we u niet opnieuw zullen informeren als er technologie- of software-updates voor ons product zijn.

Tekening en onderdelenlijst



GEEN HOEVEELHEID		FOTO	OMSCHRIJVING
1	6		Zijrail
2	4		Dwarsbalk
3	4		Hond
4	8		Honden scharnier bord
5	4		Verbindingsbalk
6	8		Stelschroef
7	4		Vlinderschroef
8	12		Kleine noot
9	4		Kruisvlek
10	8		Lange vlek
11	8		Wagenvlek
12	24		Kleine ring
13	1		Inbussleutel
14	2		Moersleutel
15	1		Gereedschapskist
16	1		Gebruiksaanwijzing

Montage-instructies

1. Pak de railkit uit en leg alle onderdelen klaar. Zet dezelfde onderdelen bij elkaar om ze te selecteren.

2. Bevestig beide scharnierplaten (nr. 4) aan de dwarsbalk (nr. 2), met bouten, ringen en moeren (nr. 10, 12 en 8). Draai niet vast totdat de scharnierplaat is bevestigd.



3. Bevestig de nok (nr. 3) aan de scharnierplaten (nr. 4) met bout, ringen en moer (nr. 9, 12 en 8). Draai alle bouten vast.



4. Monteer de rijtuigbouten (nr. 11), moeren en ring (nr. 12) door de dwarsbalk (Nr. 2) laat los. Kop van wagenbout moet zijn zoals afgebeeld.



5. Plaats de nivelleringschroeven (nr. 6) in de dwarsbalk (nr. 2). Het gleufvormige uiteinde van de schroef bevindt zich in de dezelfde richting als de kop van de slotbouten.
6. Herhaal dit voor alle dwarsbalksets.
7. Schuif de wagenbouten in de dwarsbalk in de rails. Draai ze pas vast als u de EZ-RAILS op de log. De hond kan in beide richtingen worden gericht.
8. Zodra de dwarsbalken op de stam zijn geplaatst, draait u de slotbouten vast.
9. Om de rail te verlengen naar een langere versie, gebruikt u 2 verbindingstaven (nr. 5) en elk uiteinde vastgezet met een vleugelschroef (nr. 7).



Fabrikant: Yongkang Jinjian hardwarefabriek

Adres: 11 Huabao Road, Zhiying Industrial Zone II, Yongkang City,
Provincie Zhejiang, China

VEVOR[®]

TOUGH TOOLS, HALF PRICE

Technische ondersteuning en e-garantiecertificaat

<https://www.vevor.com/support>

VEVOR[®]

TOUGH TOOLS, HALF PRICE

Technischer Support und E-Garantie-Zertifikat

<https://www.vevor.com/support>

FÜHRUNGSSCHIENE FÜR SÄGEWERK

BENUTZERHANDBUCH

Wir sind weiterhin bestrebt, Werkzeuge zu wettbewerbsfähigen Preisen anzubieten. "Sparen Sie die Hälfte", "Halber Preis" oder andere ähnliche Ausdrücke, die wir verwenden, stellen nur eine Schätzung der Einsparungen dar, die Sie möglicherweise erzielen.

Vorteile beim Kauf bestimmter Werkzeuge bei uns im Vergleich zu den großen Top-Marken und bedeuten nicht unbedingt, dass alle von uns angebotenen Werkzeugkategorien abgedeckt sind. Wir erinnern Sie freundlich daran, Überprüfen Sie bei Ihrer Bestellung bei uns sorgfältig, ob Sie im Vergleich zu den großen Topmarken die Hälfte sparen.

VEVOR®

FÜHRUNGSSCHIENE FÜR SÄGEWERK
(9 Fuß)



Brauchen Sie Hilfe? Kontaktieren Sie uns!









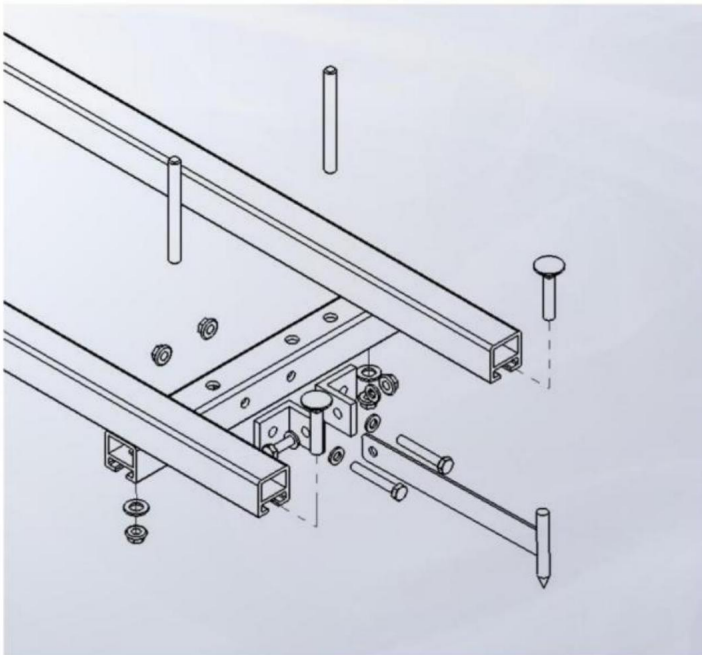
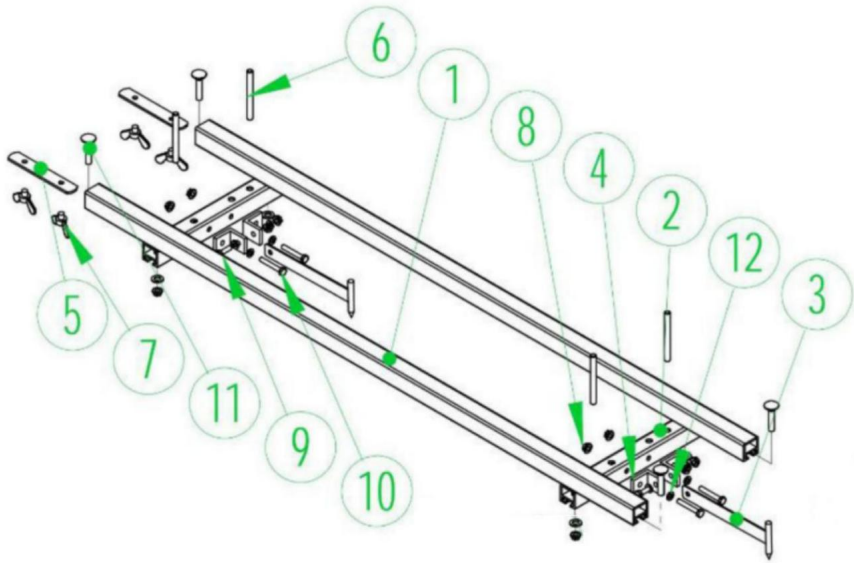







Sie haben Fragen zu unseren Produkten? Sie benötigen technischen Support? Dann kontaktieren Sie uns gerne:

 Kundenservice@vevor.com

Dies ist die Originalanleitung. Bitte lesen Sie alle Anweisungen sorgfältig durch, bevor Sie das Gerät in Betrieb nehmen. VEVOR behält sich eine klare Auslegung unserer Bedienungsanleitung vor. Das Erscheinungsbild des Produkts richtet sich nach dem Produkt, das Sie erhalten haben. Bitte verzeihen Sie uns, dass wir Sie nicht erneut informieren, wenn es Technologie- oder Software-Updates für unser Produkt gibt.

Zeichnung und Stückliste



KEINE	MENGE	Bild	BESCHREIBUNG
1	6		Seitengitter
2	4		Querstrebe
3	4		Hund
4	8		Hundescharnier Platte
5	4		Verbindungsleiste
6	8		Nivellierschraube
7	4		Schmetterlingsschraube
8	12		Kleine Nuss
9	4		Kreuzblot
10	8		Langer Blot
11	8		Wagenfleck
12	24		Kleine Waschmaschine
13	1		Inbusschlüssel
14	2		Schlüssel
15	1		Werkzeugkasten
16	1		Benutzerhandbuch

Montageanleitung

1. Schienenbausatz auspacken und alle Teile bereitlegen, gleiche Teile zur Auswahl zusammenlegen.

2. Befestigen Sie beide Scharnierplatten (Nr. 4) mit Schrauben, Unterlegscheiben und Muttern (Nr. 10, 12 und 8) an der Querstange (Nr. 2). Ziehen Sie die Schrauben erst fest, wenn die Scharnierplatte befestigt ist.



3. Befestigen Sie den Mitnehmer (Nr. 3) mit Bolzen, Unterlegscheiben und Muttern (Nr. 9, 12 und 8) an den Scharnierplatten (Nr. 4). Ziehen Sie alle Bolzen fest.



4. Führen Sie die Schloßschrauben (Nr. 11), Muttern und Unterlegscheiben (Nr. 12) durch die Querstrebe. (Nr. 2) locker lassen. Der Kopf der Schloßschraube muss wie gezeigt sein.



5. Installieren Sie die Nivellierschrauben (Nr. 6) in der Querstrebe (Nr. 2). Das Schlitzende der Schraube befindet sich in der dieselbe Richtung wie der Kopf der Schloßschrauben.

6. Wiederholen Sie dies für alle Querstangensätze.

7. Schieben Sie die Schloßschrauben in der Querstrebe in die Schienen. Ziehen Sie sie erst fest, wenn Sie die EZ-RAILS auf dem Stamm. Die Ausrichtung des Hundes kann in beide Richtungen erfolgen.

8. Sobald die Querstangen auf dem Baumstamm platziert sind, ziehen Sie die Schloßschrauben fest.

9. Um die Schiene auf eine längere Version zu verlängern, verwenden Sie bitte 2 der Verbindungsstangen (Nr. 5) und jedes Ende mit einer Flügelschraube (Nr. 7) befestigt.



Hersteller: Yongkang Jinjian Hardware Factory

Adresse: 11 Huabao Road, Zhiying Industriegebiet II, Stadt Yongkang,
Provinz Zhejiang, China

VEVOR[®]

TOUGH TOOLS, HALF PRICE

Technischer Support und E-Garantie-Zertifikat

<https://www.vevor.com/support>

VEVOR®

TOUGH TOOLS, HALF PRICE

Assistance technique et certificat de garantie électronique

<https://www.vevor.com/support>

RAIL DE GUIDAGE POUR SCIERIE

MANUEL D'UTILISATION

Nous continuons à nous engager à offrir des outils à des prix compétitifs. « Économisez la moitié », « Moitié prix » ou toute autre expression similaire utilisée par nous ne représente qu'une estimation des économies que vous pourriez réaliser.

Les avantages de l'achat de certains outils chez nous par rapport aux grandes marques haut de gamme ne sont pas nécessairement destinés à couvrir toutes les catégories d'outils que nous proposons. Nous vous rappelons avec plaisir Vérifiez soigneusement lorsque vous passez une commande chez nous si vous économisez la moitié par rapport aux grandes marques.

VEVOR[®]

RAIL DE GUIDAGE POUR SCIERIE

(9 pieds)



BESOIN D'AIDE? CONTACTEZ-NOUS!









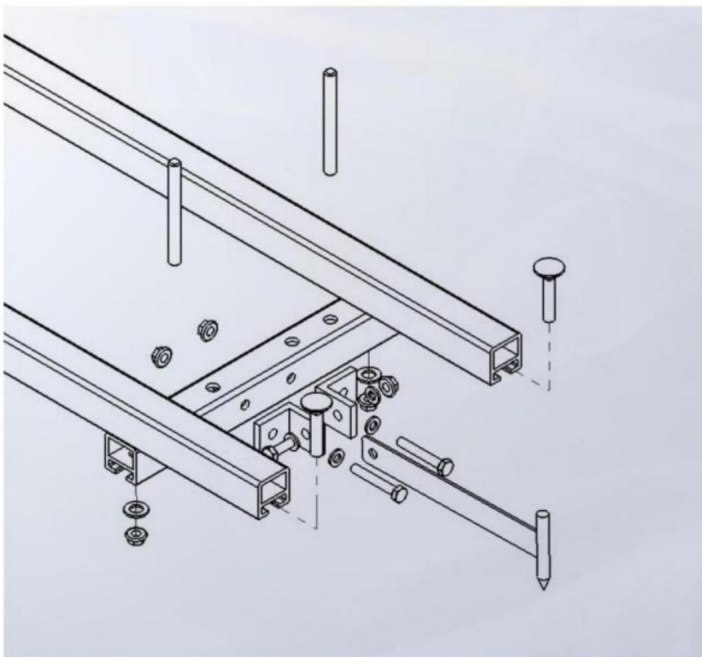
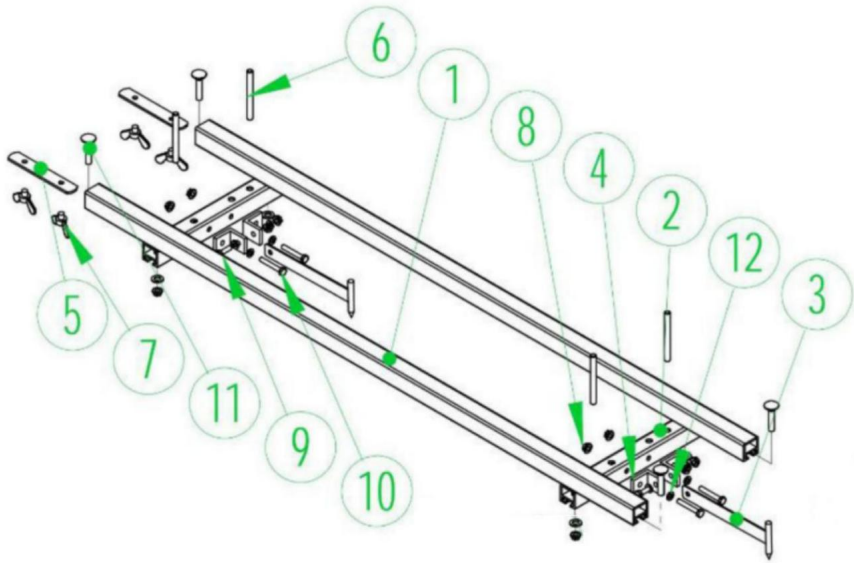







Vous avez des questions sur nos produits ? Vous avez besoin d'assistance technique ? N'hésitez pas à nous contacter :

 ServiceClient@vevor.com

Il s'agit de la notice d'utilisation d'origine. Veuillez lire attentivement toutes les instructions du manuel avant de l'utiliser. VEVOR se réserve le droit d'interpréter clairement notre manuel d'utilisation. L'apparence du produit dépend du produit que vous avez reçu. Veuillez nous excuser, nous ne vous informerons plus en cas de mise à jour technologique ou logicielle de notre produit.

Dessin et liste des pièces



PAS	DE QTÉ	PHOTO	DESCRIPTION
1	6		Rail latéral
2	4		Barre transversale
3	4		Chien
4	8		Charnière pour chien plaque
5	4		Barre de connexion
6	8		Vis de mise à niveau
7	4		Vis papillon
8	12		Petite noix
9	4		Tache croisée
10	8		Longue tache
11	8		Tache de transport
12	24		Petite rondelle
13	1		Clé Allen
14	2		Clé
15	1		Boîte à outils
16	1		Manuel d'utilisation

Instructions d'assemblage

1. Déballez le kit de rails et disposez toutes les pièces, assemblez les mêmes pièces pour les sélectionner.
2. Fixez les deux plaques de charnières pour chien (n° 4) à la barre transversale (n° 2) à l'aide de boulons, de rondelles et d'écrous (n° 10, 12 et 8). Ne serrez pas tant que le chien n'est pas fixé.



3. Fixez le chien (n° 3) aux plaques de charnière (n° 4) avec un boulon, des rondelles et un écrou (n° 9, 12 et 8). Serrez tous les boulons.



4. Assemblez les boulons de carrosserie (n° 11), les écrous et la rondelle (n° 12) à travers la barre transversale (N° 2) laissez libre. La tête du boulon de carrosserie doit être comme indiqué.



5. Installez les vis de nivellement (n° 6) dans la barre transversale (n° 2), l'extrémité fendue de la vis se trouve dans la même direction que la tête des boulons de carrosserie.

6. Répétez l'opération pour tous les kits de barres transversales.

7. Faites glisser les boulons de carrosserie de la barre transversale dans les rails. Ne serrez pas avant d'avoir installé le EZ-RAILS sur le rondin. L'orientation du chien peut se faire dans les deux sens.

8. Une fois les barres transversales placées sur la bûche, serrez les boulons de carrosserie.

9. Pour étendre le rail vers une version plus longue, veuillez utiliser 2 barres de connexion (n° 5) et chaque extrémité est fixée avec une vis papillon (n°7).



Fabricant: usine de matériel Yongkang jinjian

Adresse : 11 Huabao Road, Zhiying Industrial Zone II, Yongkang City,
Province du Zhejiang, Chine

VEVOR[®]

TOUGH TOOLS, HALF PRICE

Assistance technique et certificat de garantie

électronique <https://www.vevor.com/support>