

VEVOR[®]

TOUGH TOOLS, HALF PRICE

Technical Support and E-Warranty Certificate www.vevor.com/support

INSTRUCTION FOR CAT CAGE

MODEL:CH470

We continue to be committed to provide you tools with competitive price. "Save Half", "Half Price" or any other similar expressions used by us only represents an estimate of savings you might benefit from buying certain tools with us compared to the major top brands and does not necessarily mean to cover all categories of tools offered by us. You are kindly reminded to verify carefully when you are placing an order with us if you are actually saving half in comparison with the top major brands.

VEVOR[®]

TOUGH TOOLS, HALF PRICE

CAT CAGE

CH470



NEED HELP? CONTACT US!

Have product questions? Need technical support? Please feel free to contact us:

Technical Support and E-Warranty Certificate www.vevor.com/support

This is the original instruction, please read all manual instructions carefully before operating. VEVOR reserves a clear interpretation of our user manual. The appearance of the product shall be subject to the product you received. Please forgive us that we won't inform you again if there are any technology or software updates on our product.

WARNING:

Read this material before using this product. Failure to do so can result in serious injury.

Assembly precautions

1. Assemble only according to these instructions. Improper assembly can create hazards.
2. In order to ensure your own safety, please make sure to ANSI-approved safety goggles and heavy-duty work gloves when installing this product.
3. Keep the assembly area clean and well lit.
4. Keep bystanders out of the area during assembly.
5. Do not assemble when tired or when under the influence of alcohol, drugs or medication.
6. Product capabilities apply to properly and completely assembled product only.
7. Assemble on a flat, level, hard and smooth surface capable of safely supporting a fully loaded cat cage.

Use precautions

TO PREVENT SERIOUS INJURY AND DEATH FROM TIPPING:

1. DO NOT SIT OR STAND ON THIS ITEM.
2. This product is not a toy. Do not allow children to play with or near this item. Please keep small spare parts out of children's reach.
3. Use only on a flat, level, hard and smooth surface capable of safely supporting a fully loaded cat cage.
4. Use as intended only.
5. Inspect before every use; do not use if parts are loose or damaged.

SAVE THESE INSTRUCTIONS

SPECIFICATIONS

Model	CH470
Product Size	760×865×1630mm
Color	Gray

COMPONENTS

Notice:

1. Various specifications of screws are used in the installation of this product. Pay attention to the correct use of screw specifications according to the instruction manual.
2. Please wear gloves when installing.

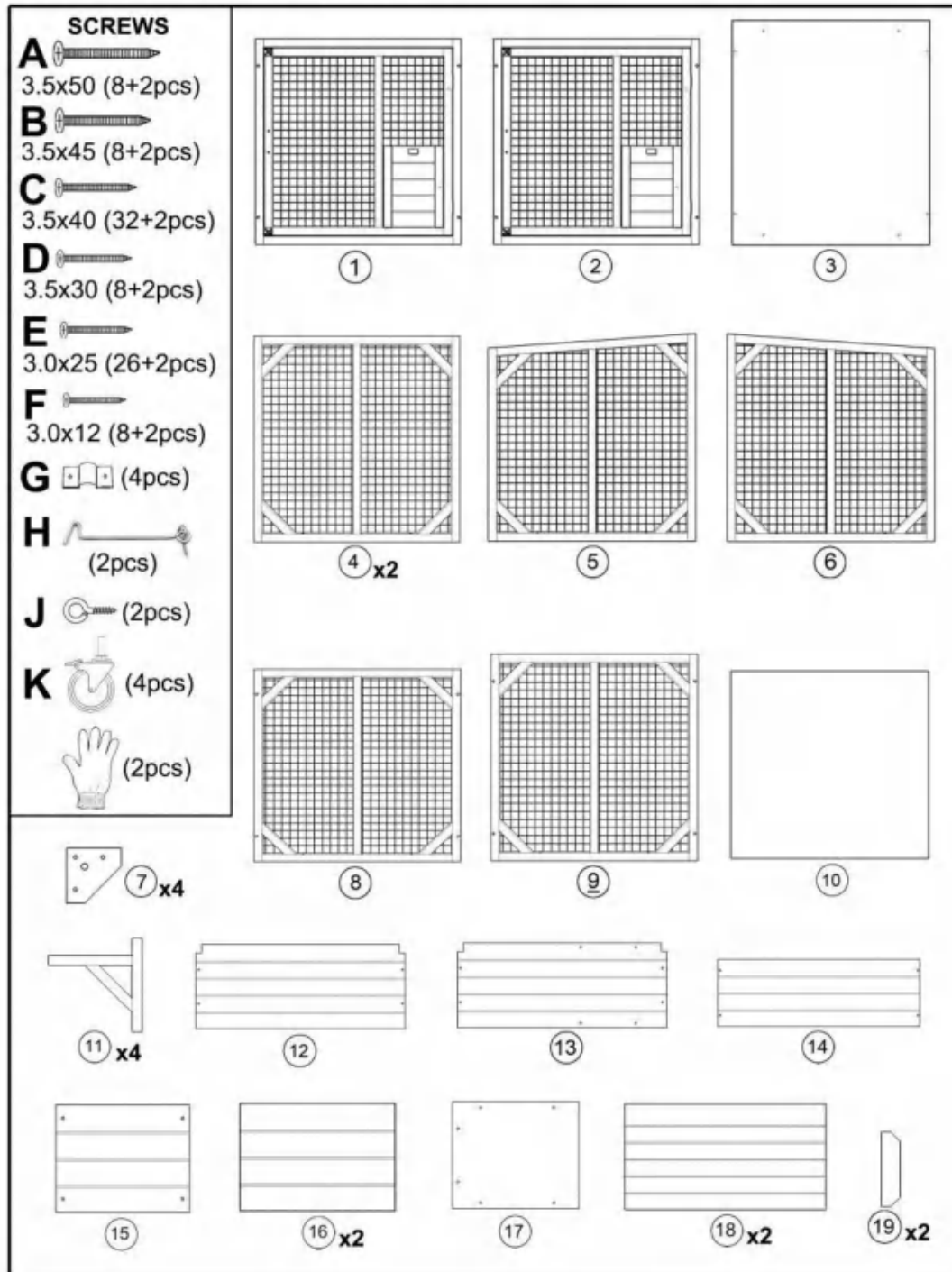

Assembly Instructions

Please be noted that the side with wire nailed on is back side, should be inward when installation

This end with a long piece of wood is placed at bottom

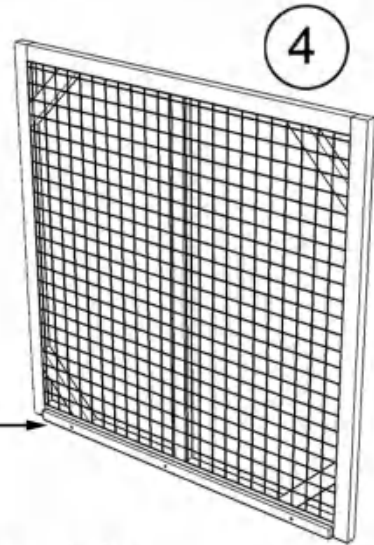

Assembling part #4x2 and part #1 with screws (C)x4 as shown below

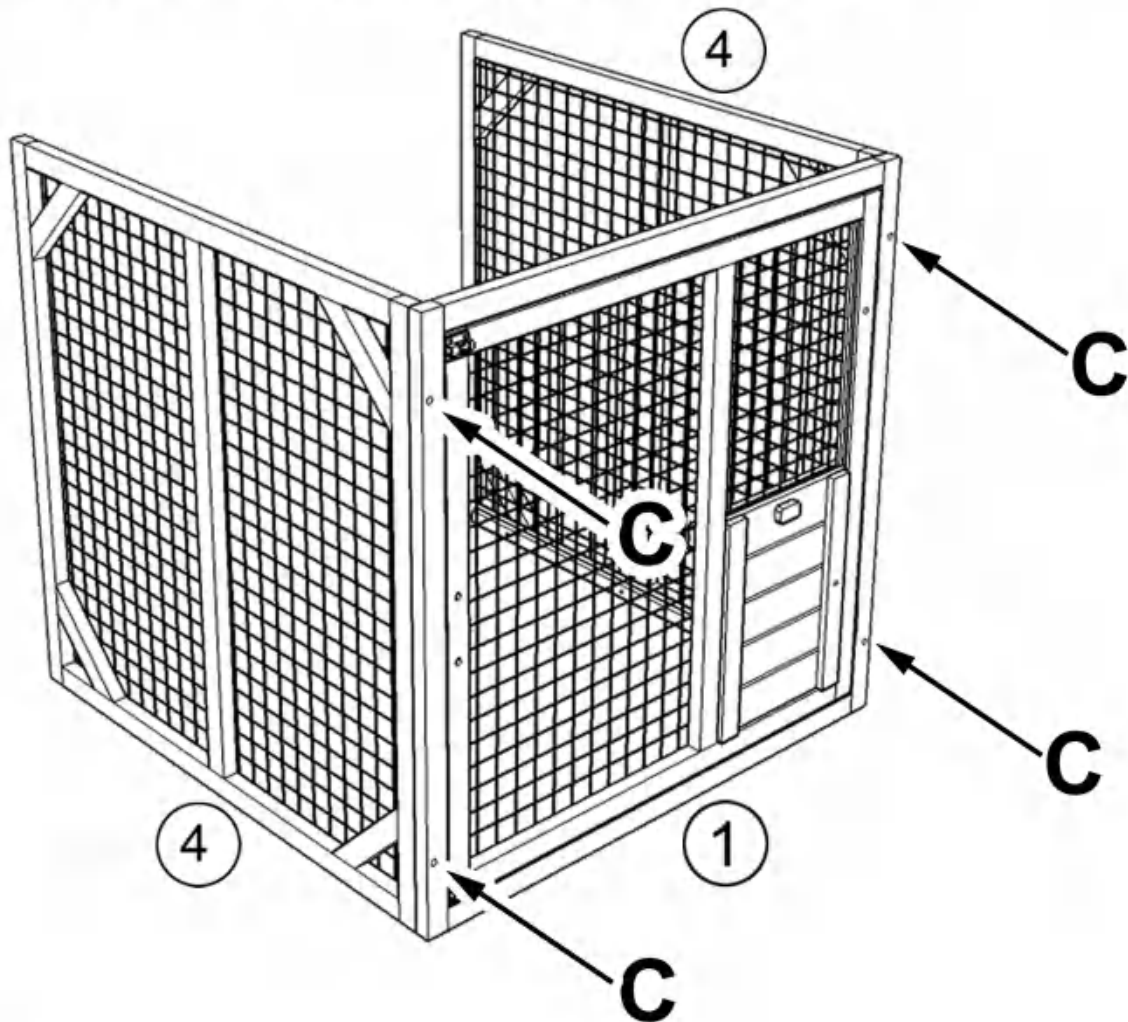

STEP:1

The part #2 (open the door) and part #5 has pre-drilled holes at bottom as shown, assemble part #2 and part #5 with screws (C)x2, then place them on the parts finished in last step and secure them with screws (A)x4 downwards

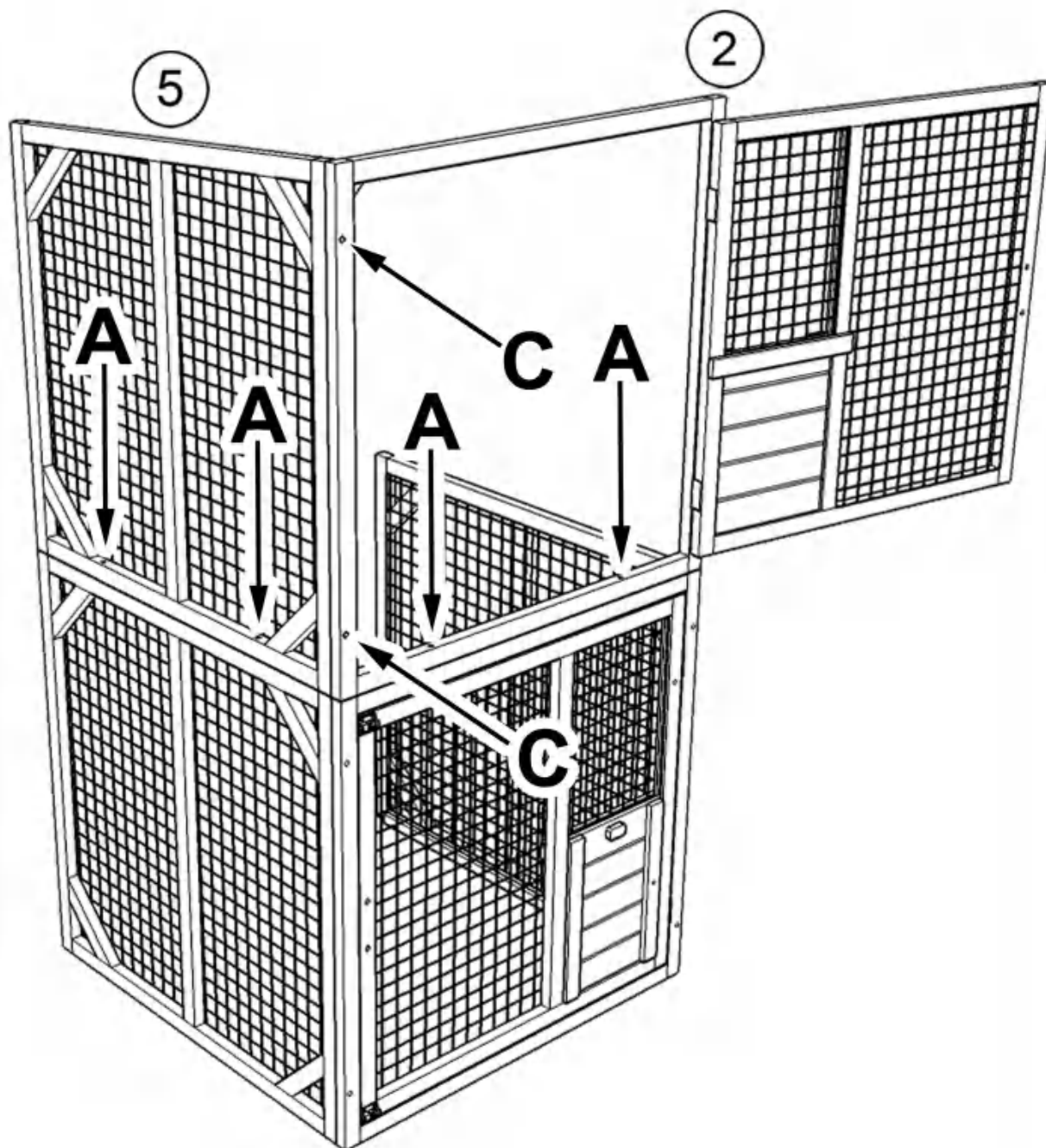

STEP:2

The part #6 has 2 pre-drilled holes at bottom, assembling part #6 with screws (C)x2 as shown and secure it to lower part with screws (A)x2 downwards

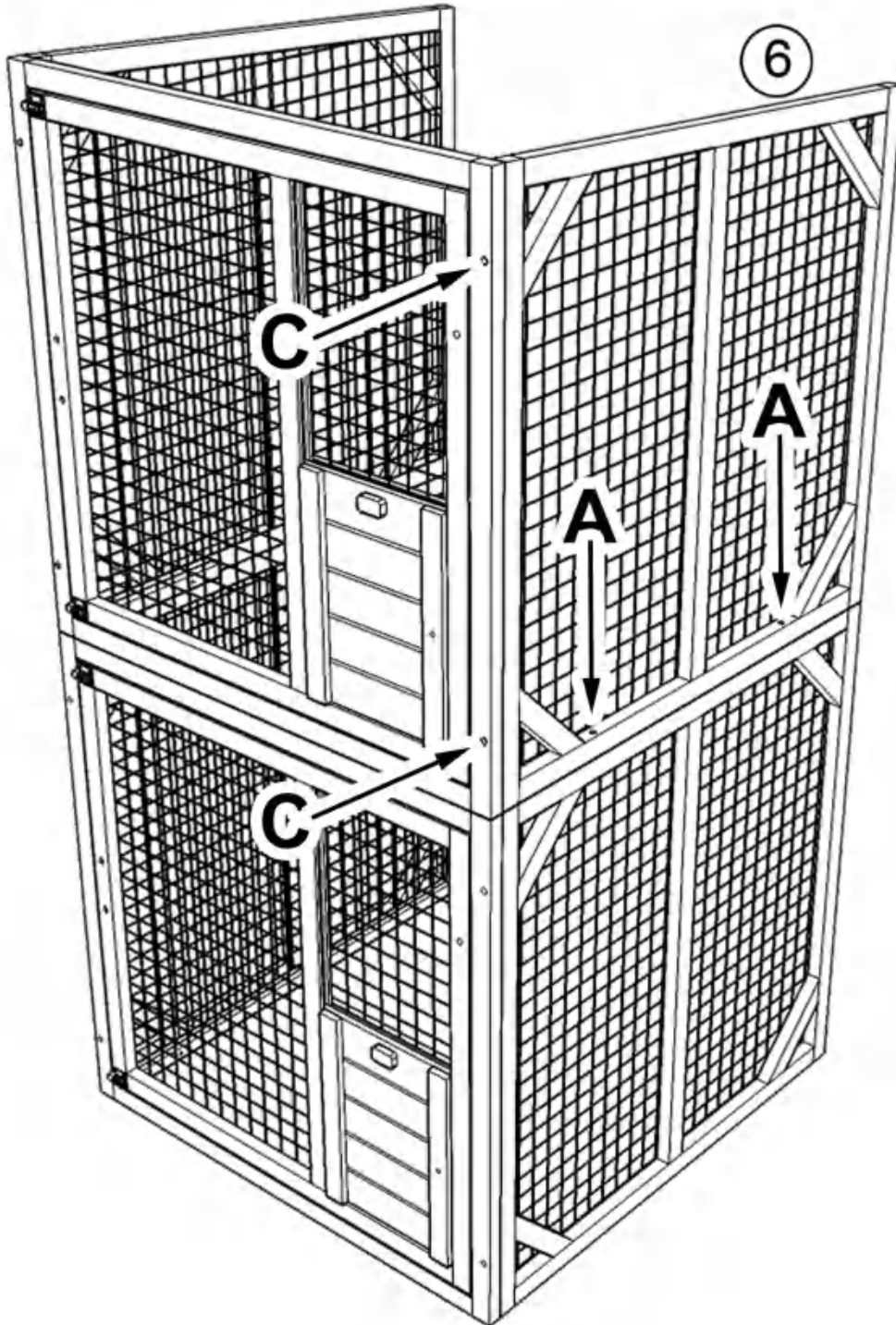

STEP:3

Assembling shelf with part #12 and part #11x2 by screws (E)x4 as shown

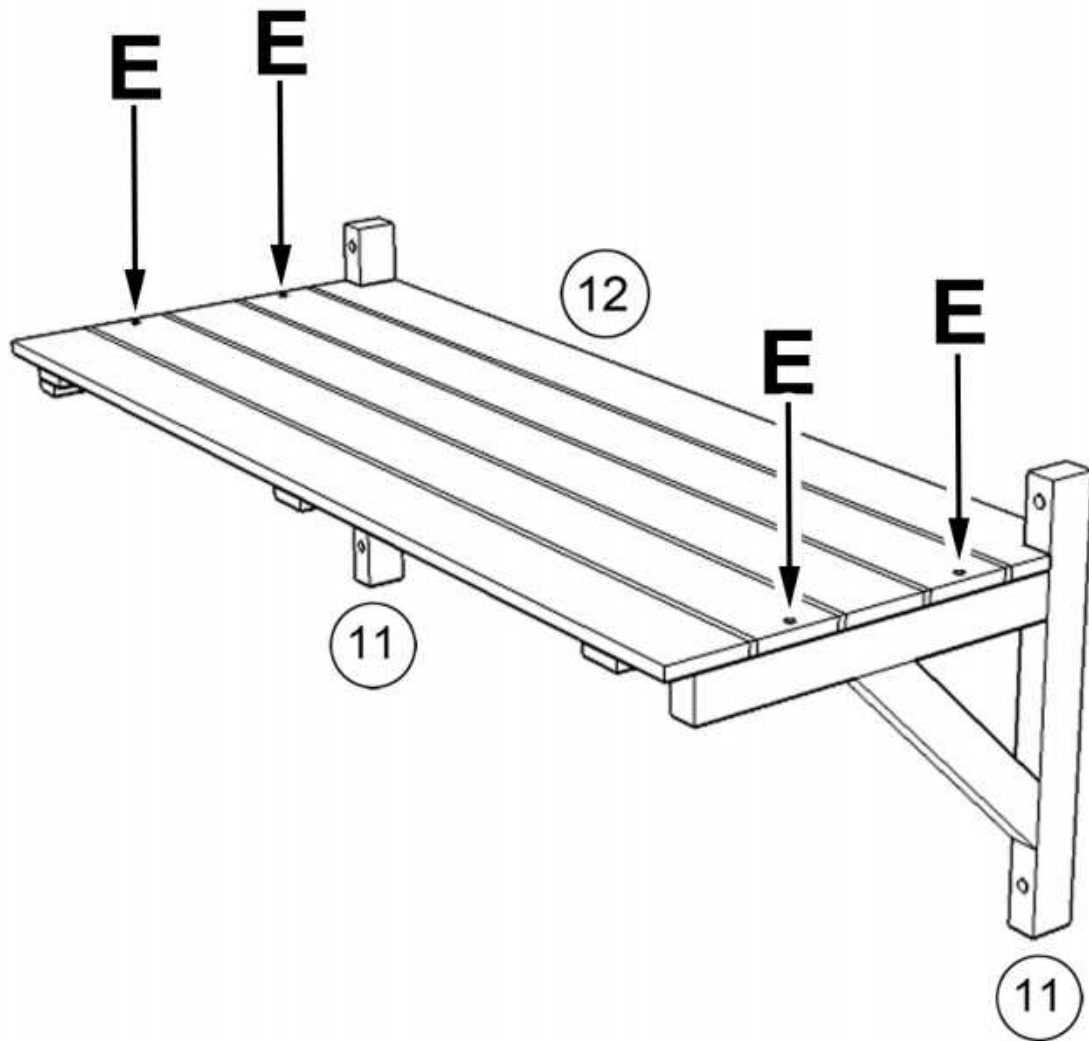

STEP:4

Mounting the shelf on right side as shown by screws (B)x4 at your preferred height

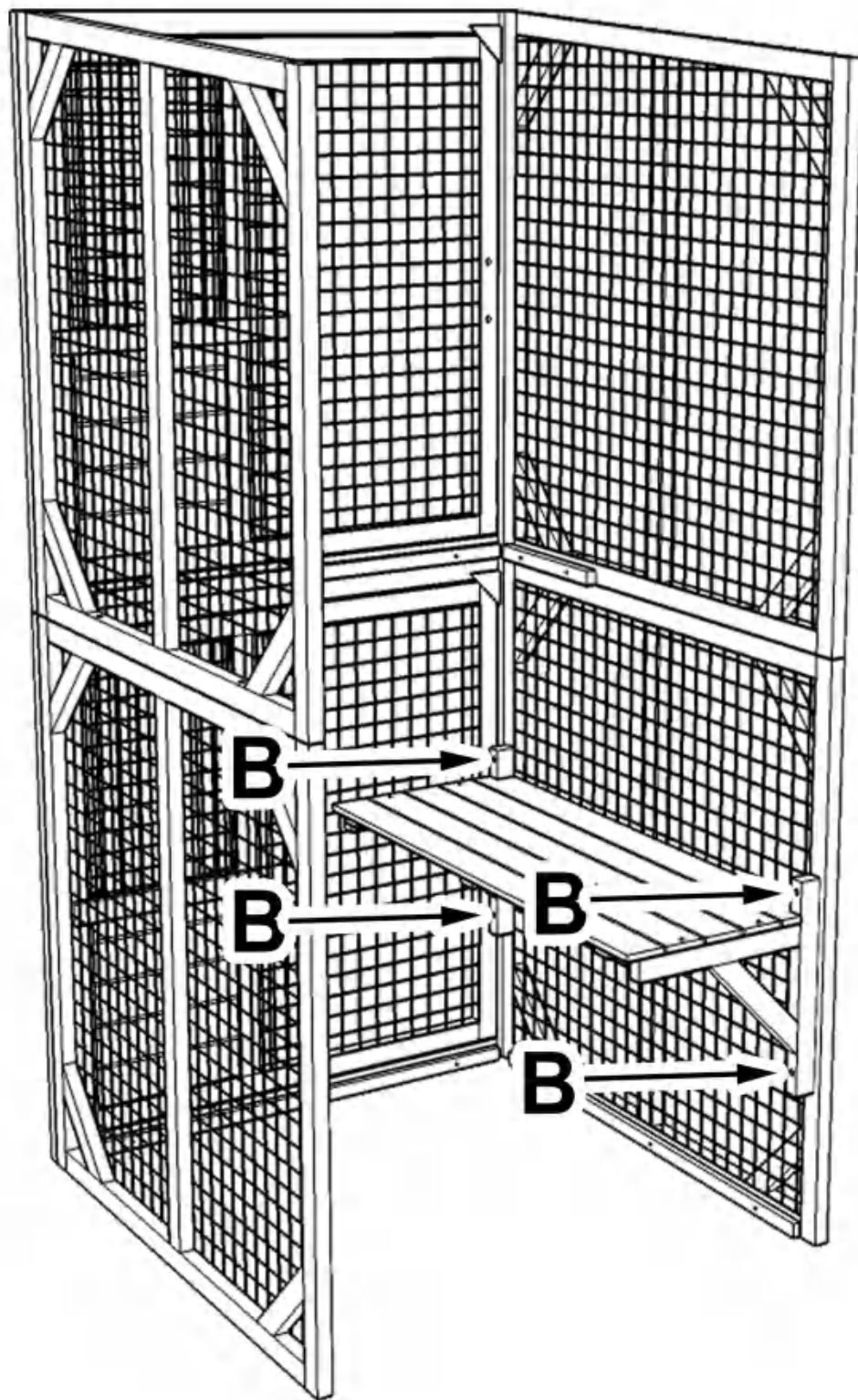

STEP:5

Placing part #14 on the short wood pieces on left and right side and secure it with screw (E)x4

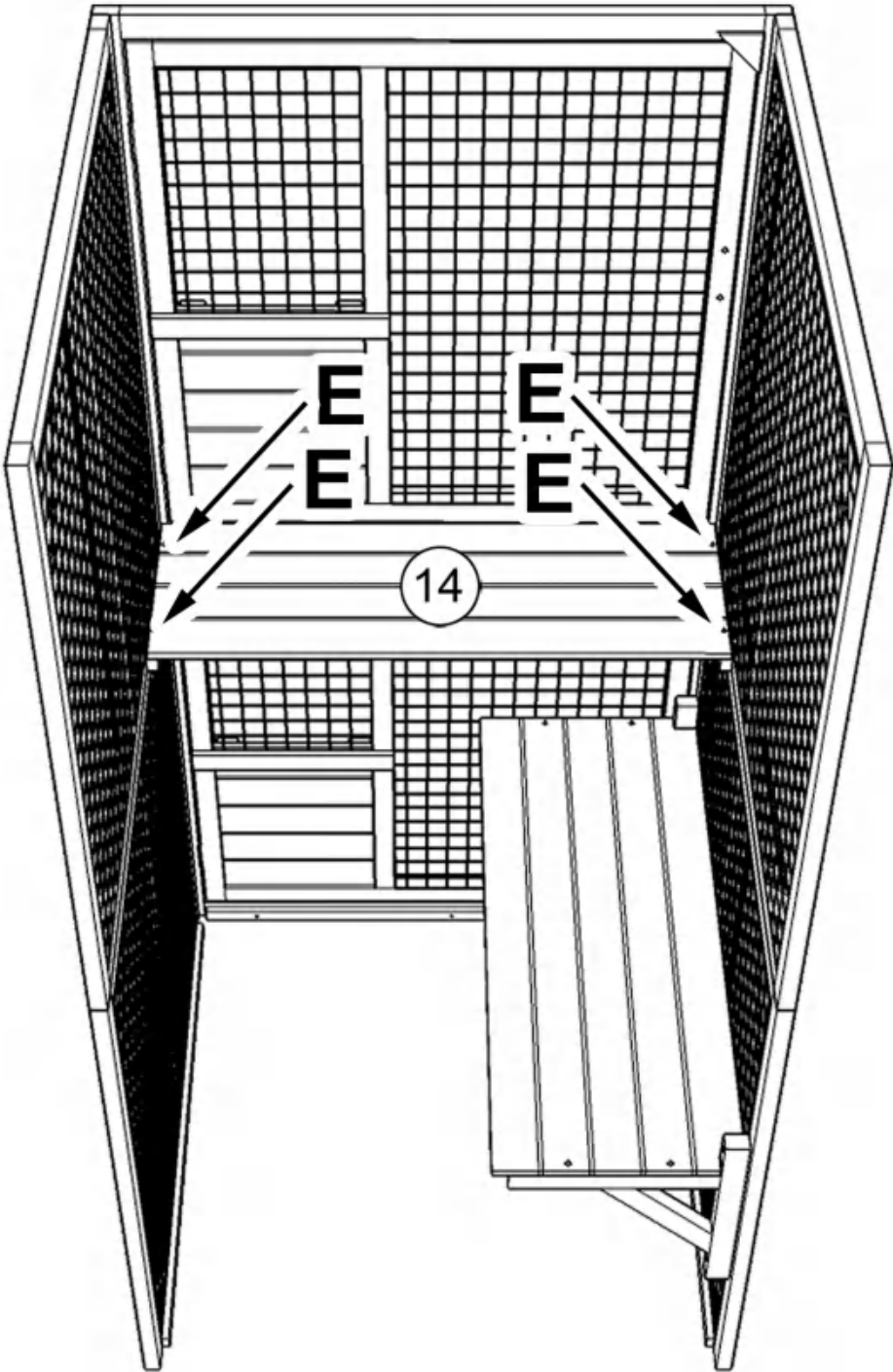

STEP:6

Assembling shelf with part #13 and part #11x2 by screws (E)x4 as shown

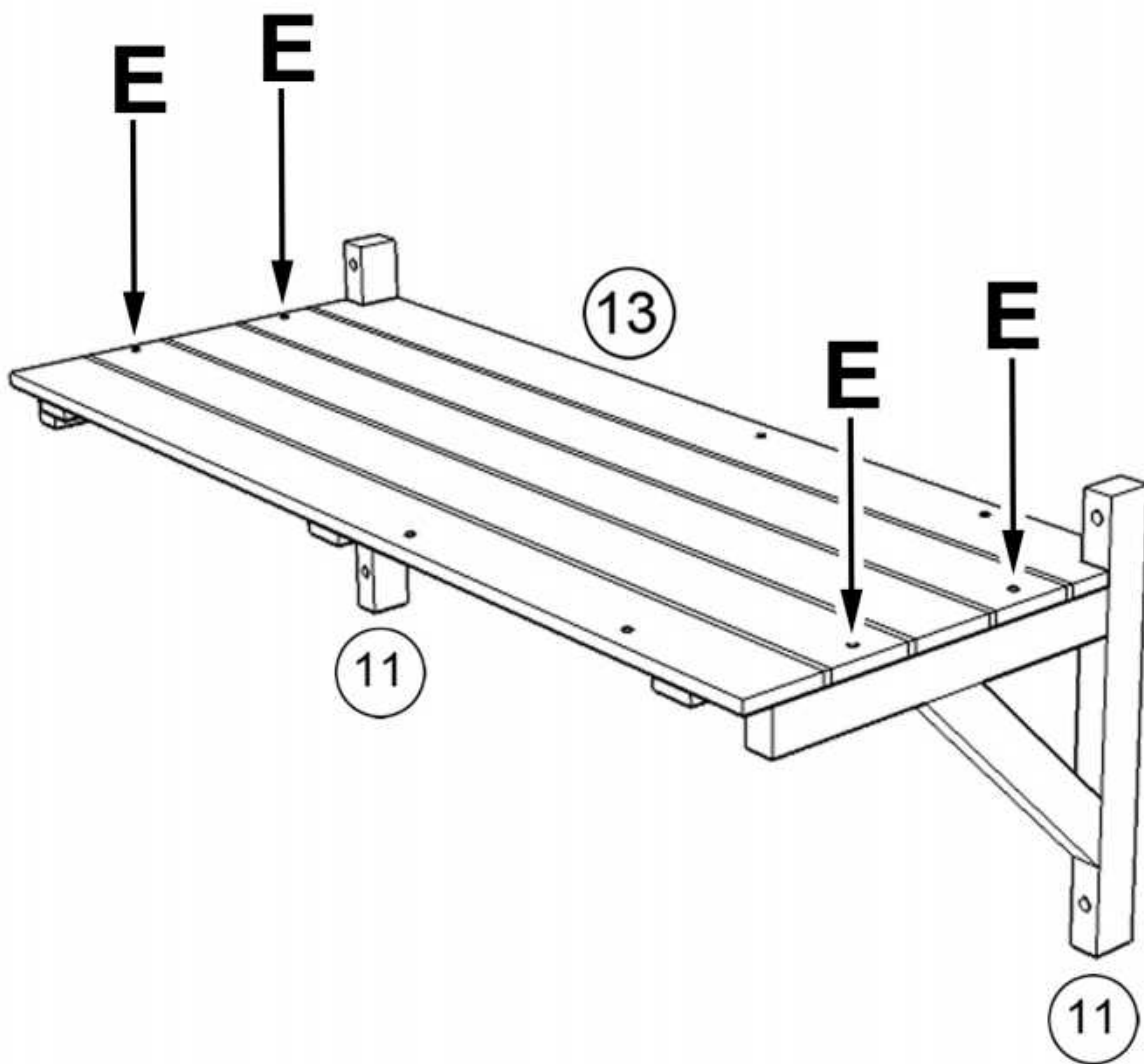

STEP:7

Mounting the shelf to the right side of board as shown with screws (B)x4 at your preferred height

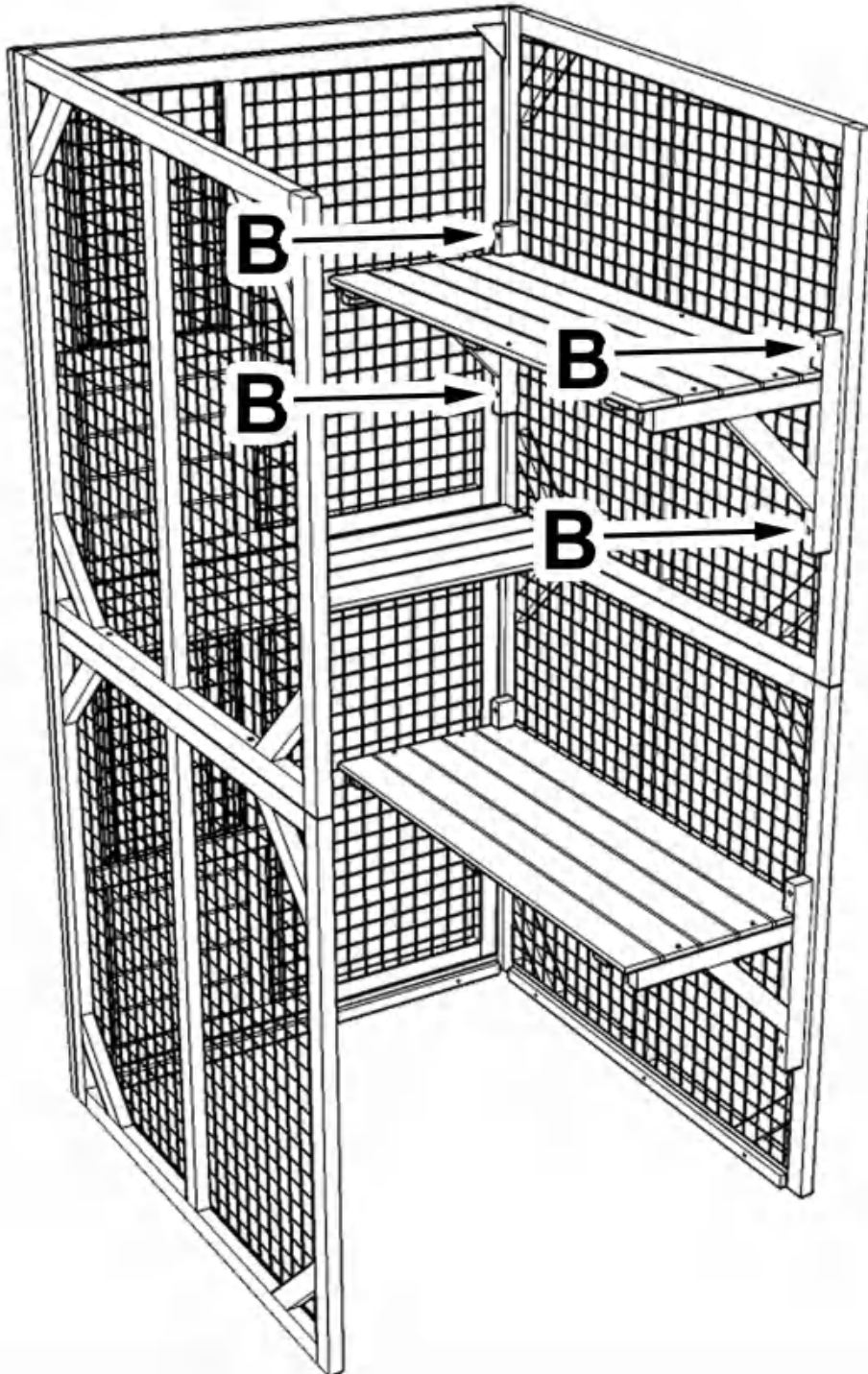

STEP:8

Assembling sleeping box with part #16x2, #17, #15 using screws (E)x10

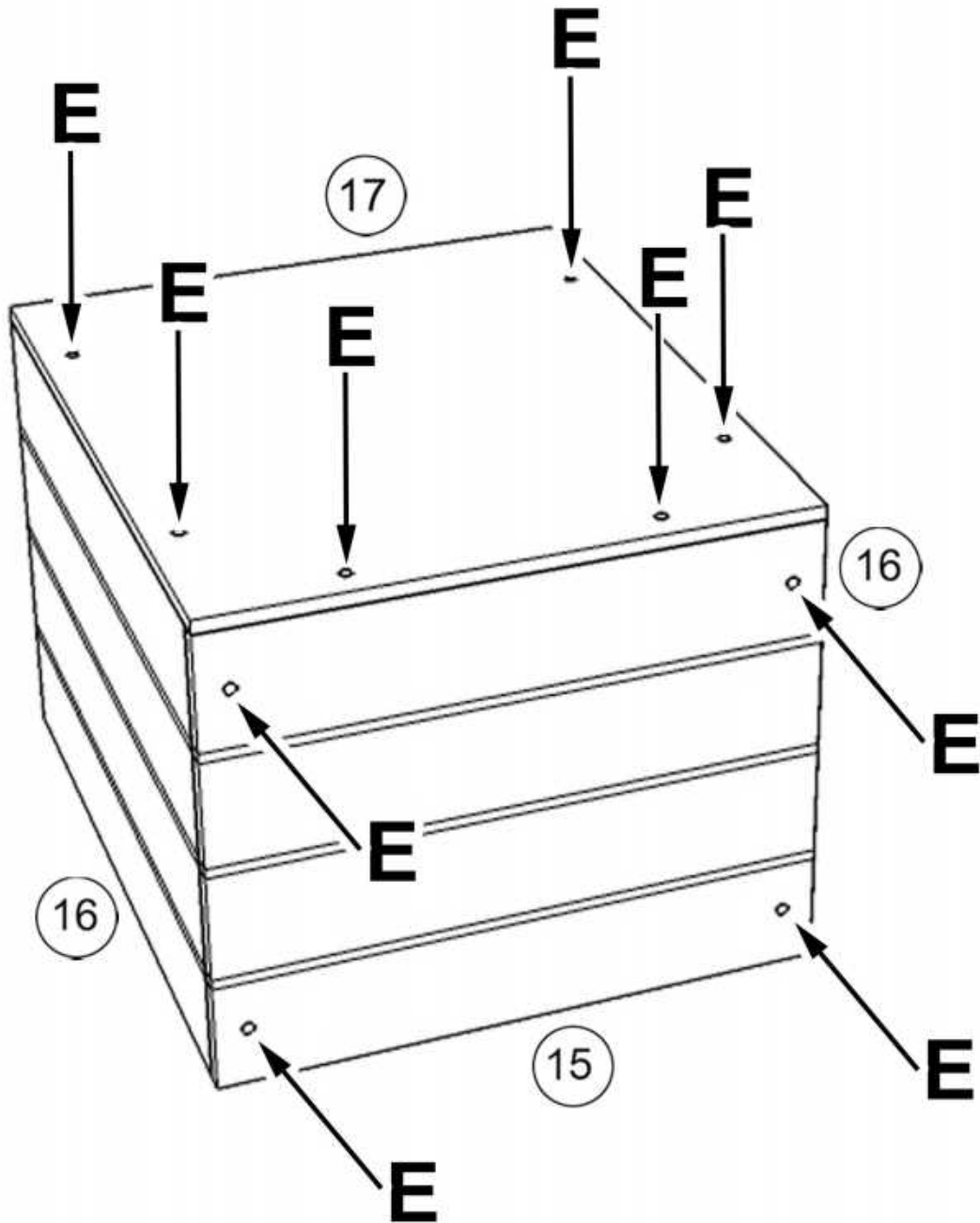

STEP:9

Placing sleeping box on the top of shelf as shown and secure it with screws (E)x4 from the bottom of shelf

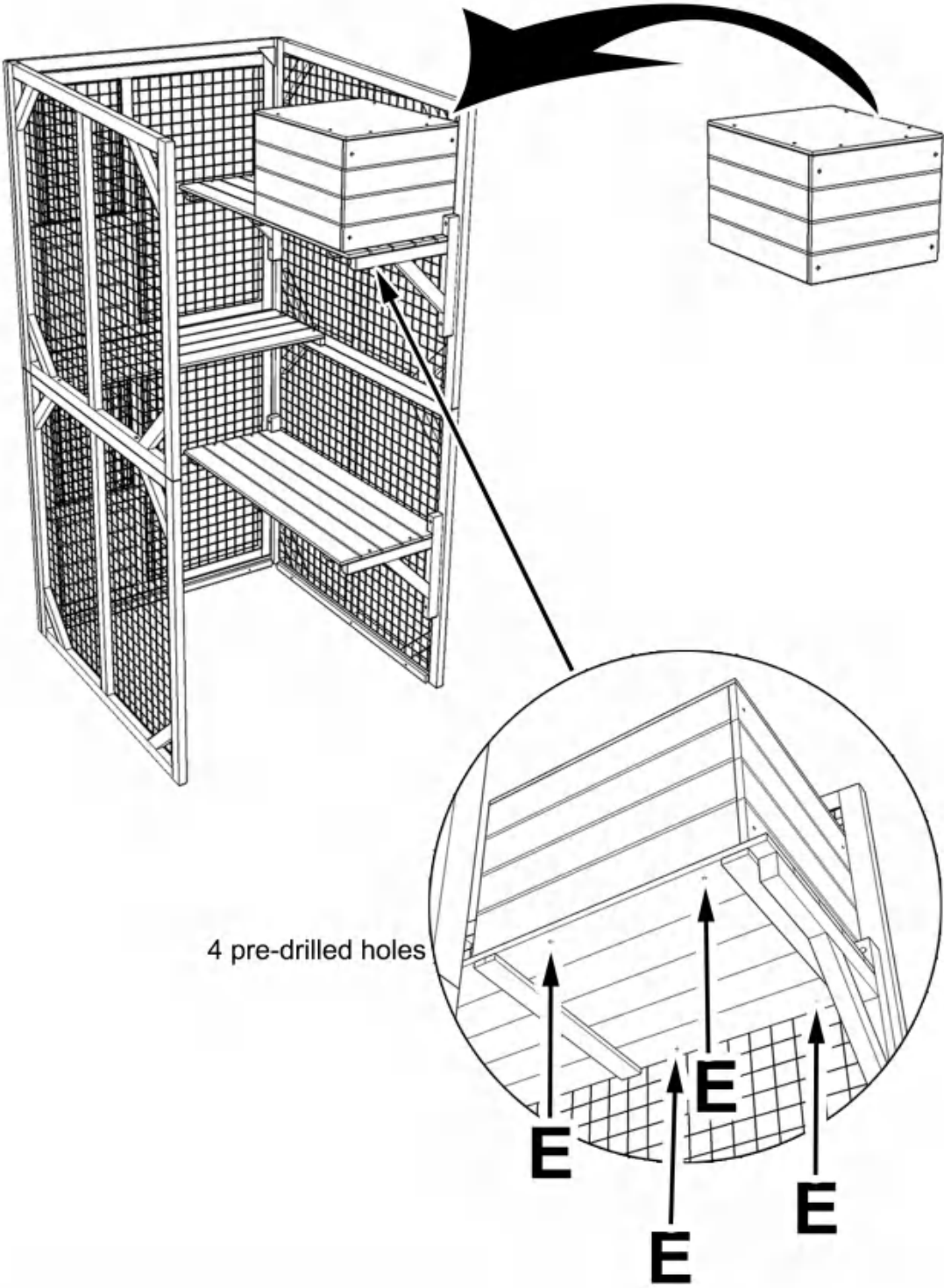

STEP:10

Assembling firstly part #9 (bottom) and then part #8 (2 holes at bottom) with screws (C)x8, then secure the 2 parts by screwing (A)x2 downwards as shown

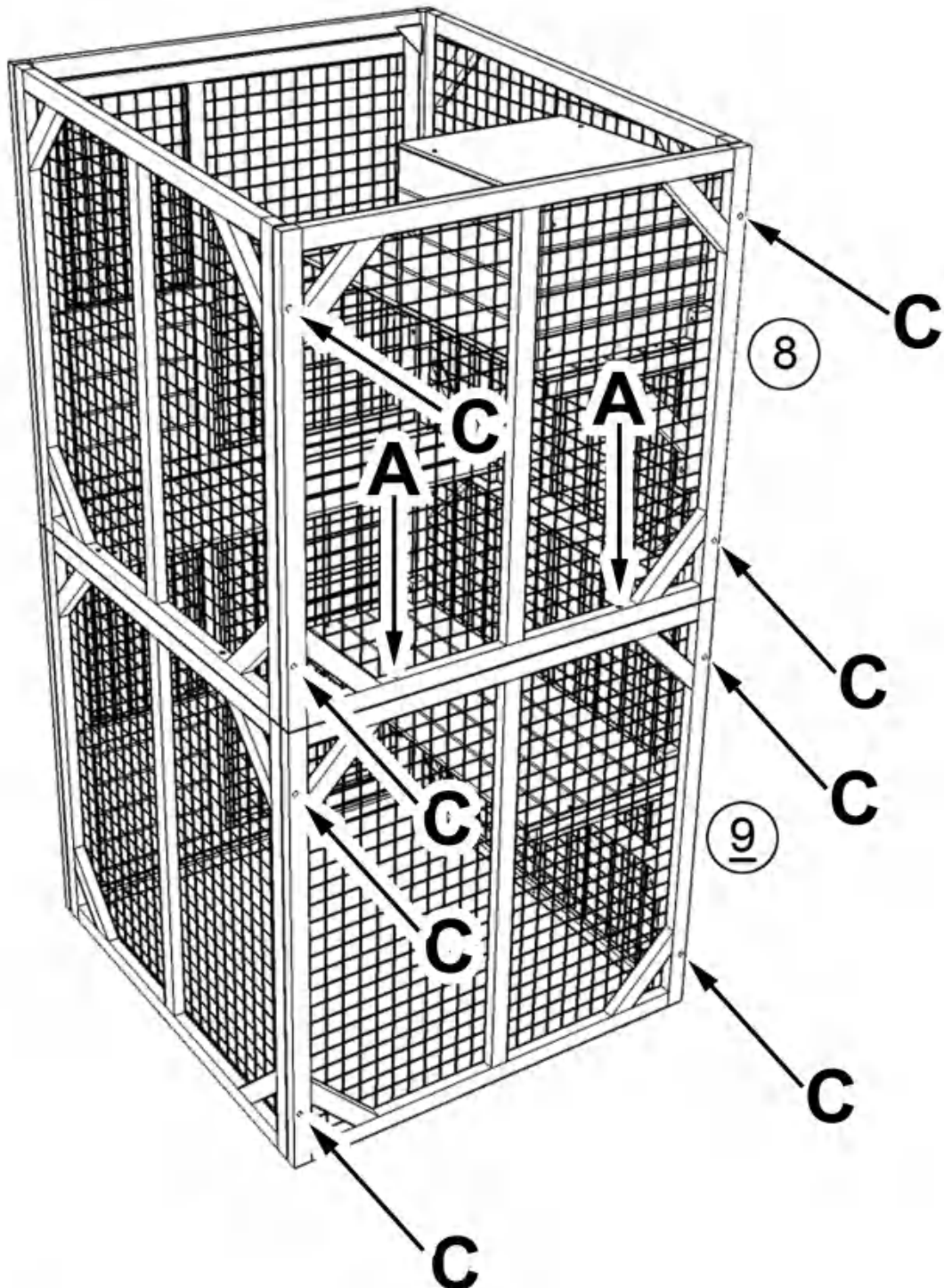

STEP:11

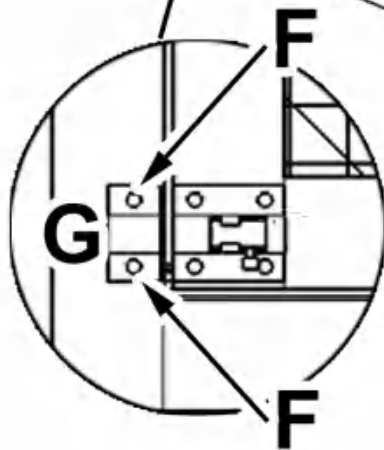
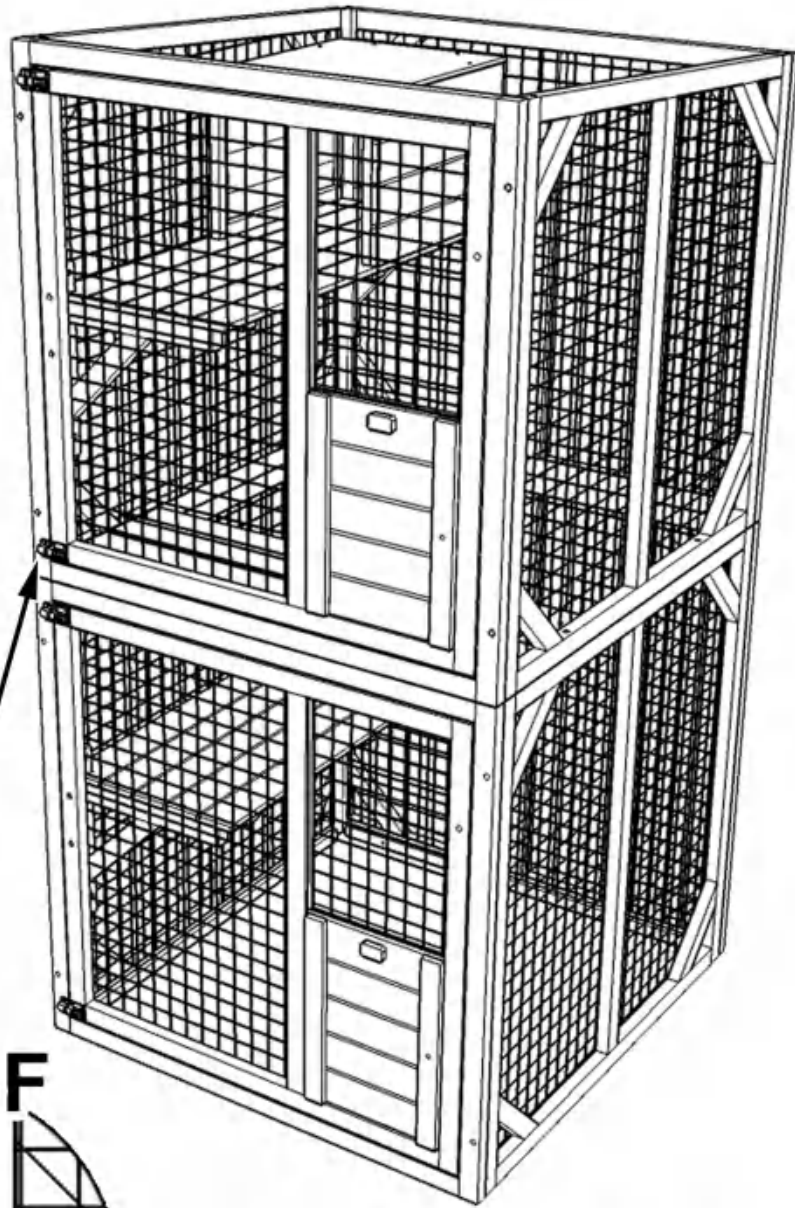

Align the short end of lock part #G with its other part already on door then secure it with screws (F)x2

STEP:12

Install handles parts #19x2 on doors with screws (C)x4 as shown

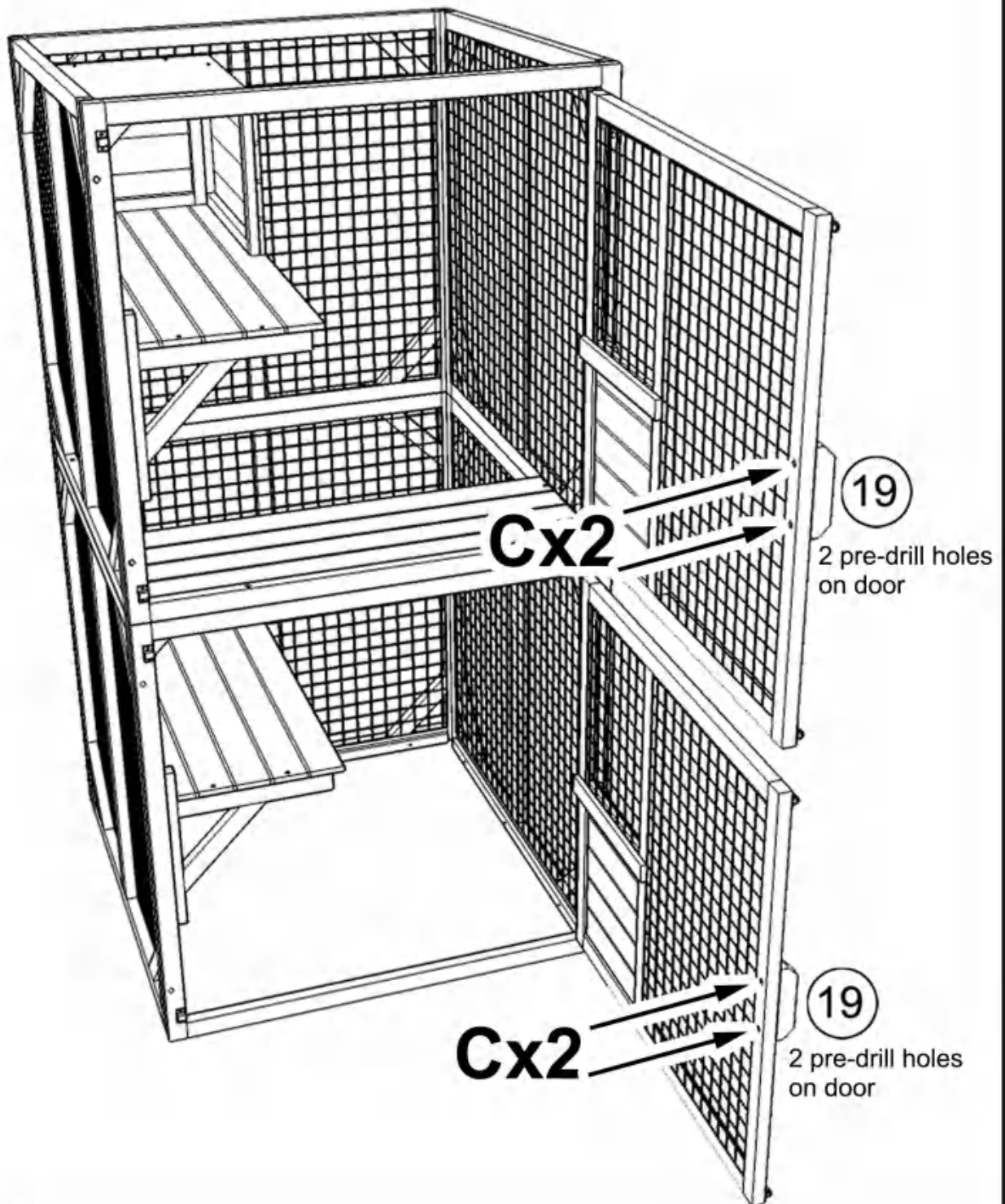

STEP:13

Install hooks as shown, long part is on the sliding door, short part is on the frame wood

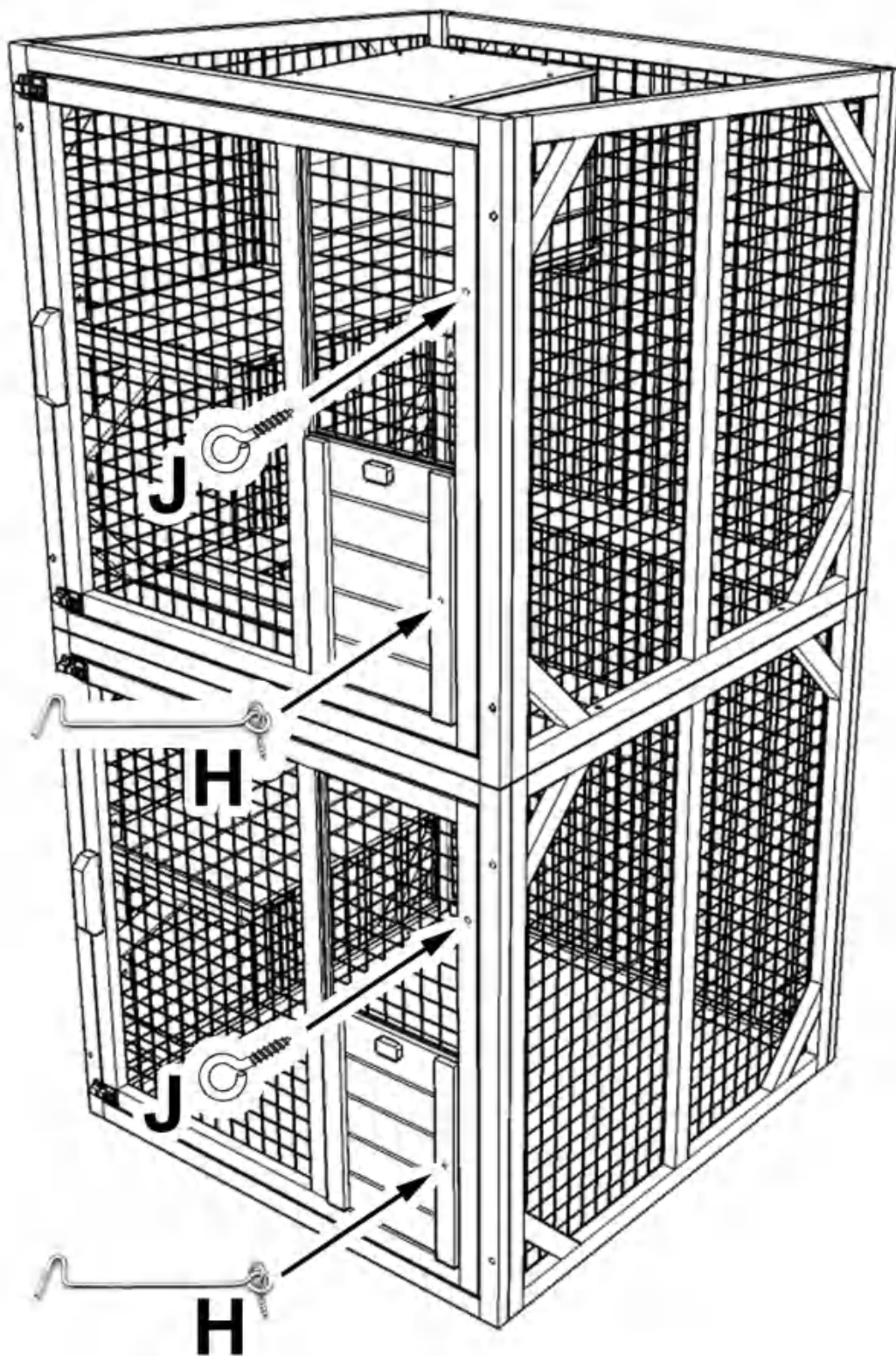

STEP:14

Gently let down the product, install part #7x4 as shown by screws (C)x12

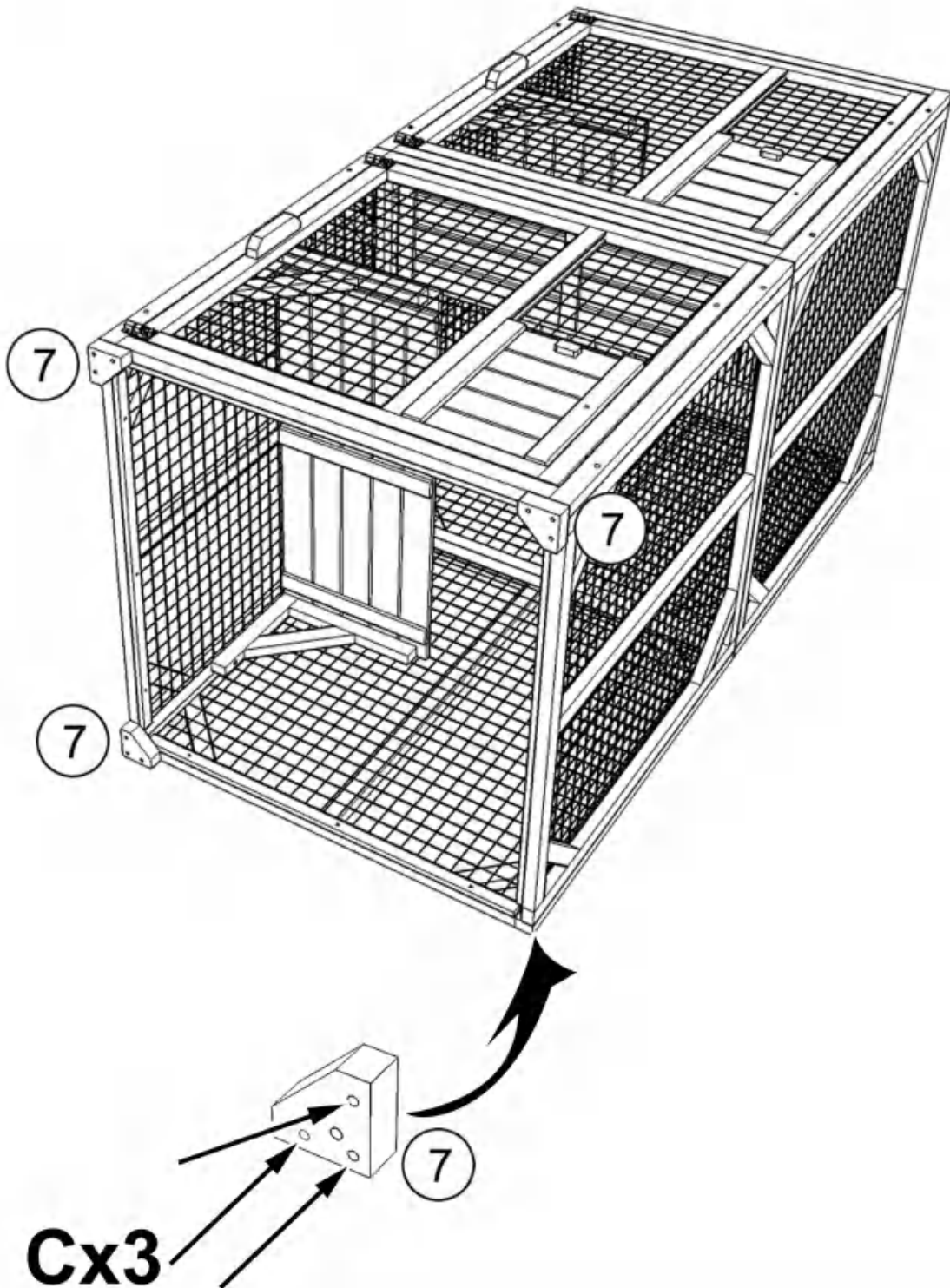

STEP:15

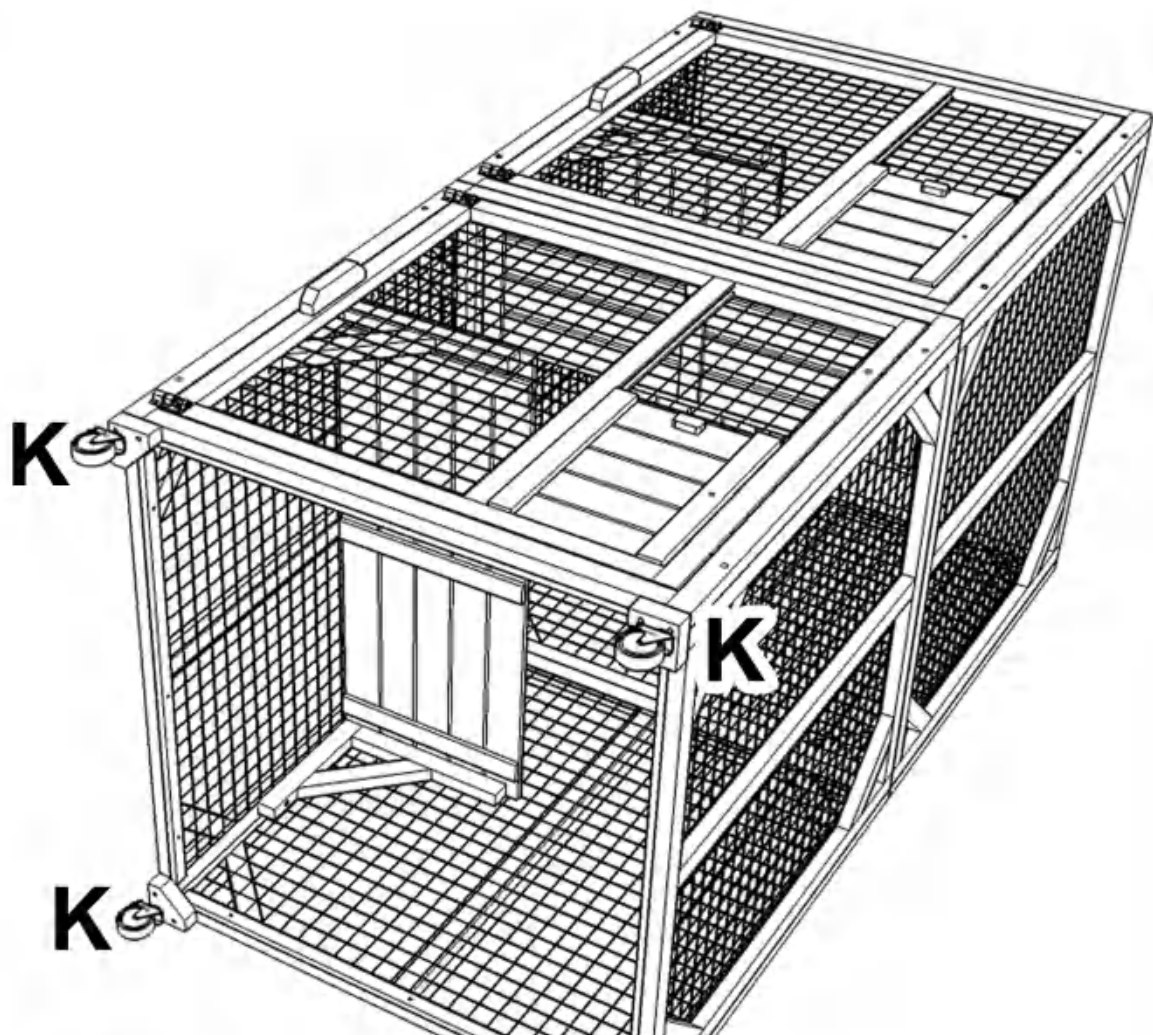

PRESS

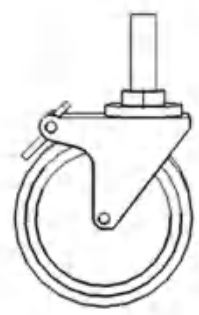

K

Install the wheels and tighten them clockwise

STEP:16

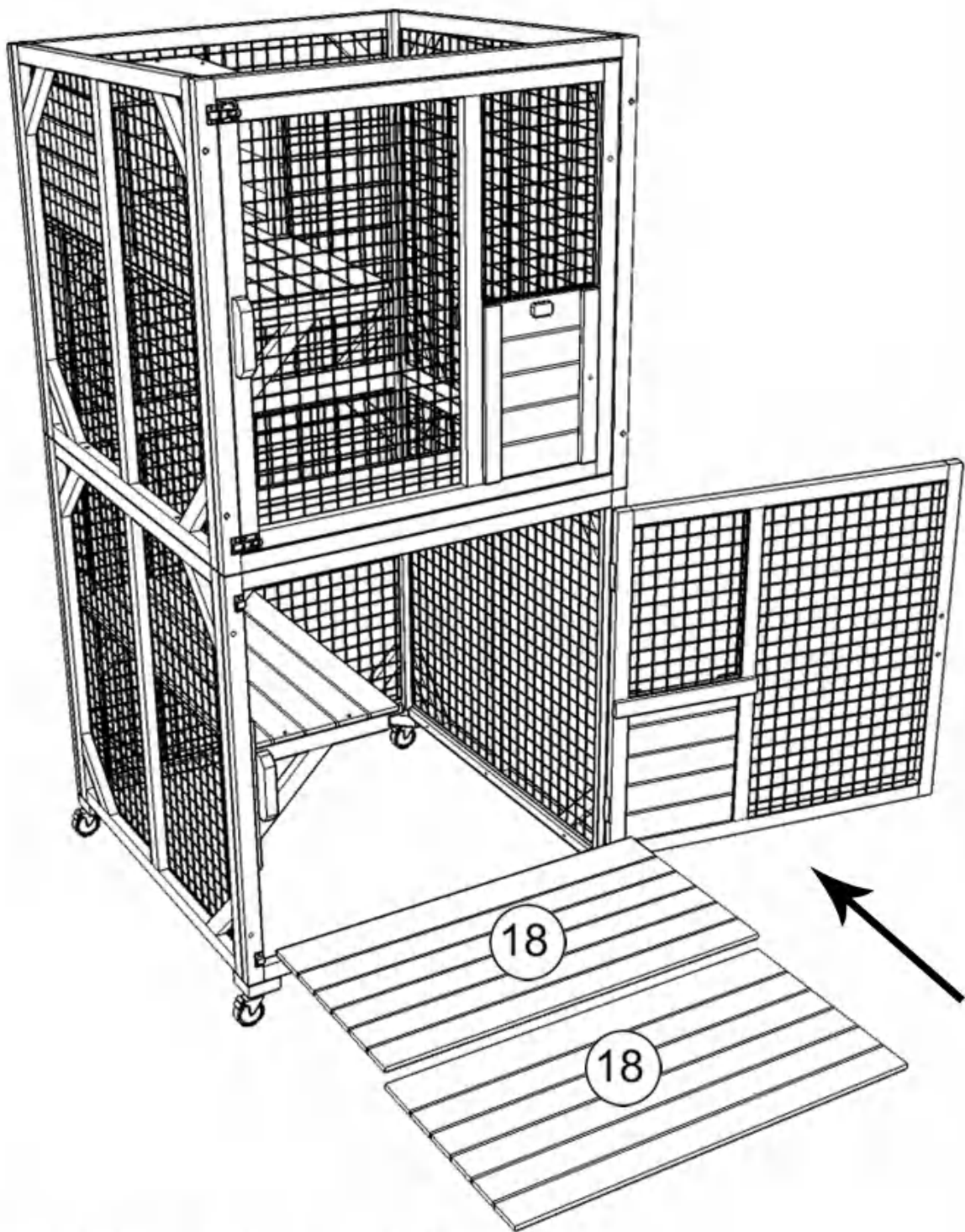

Put in the bottom floors part #18x2 as shown

STEP:17

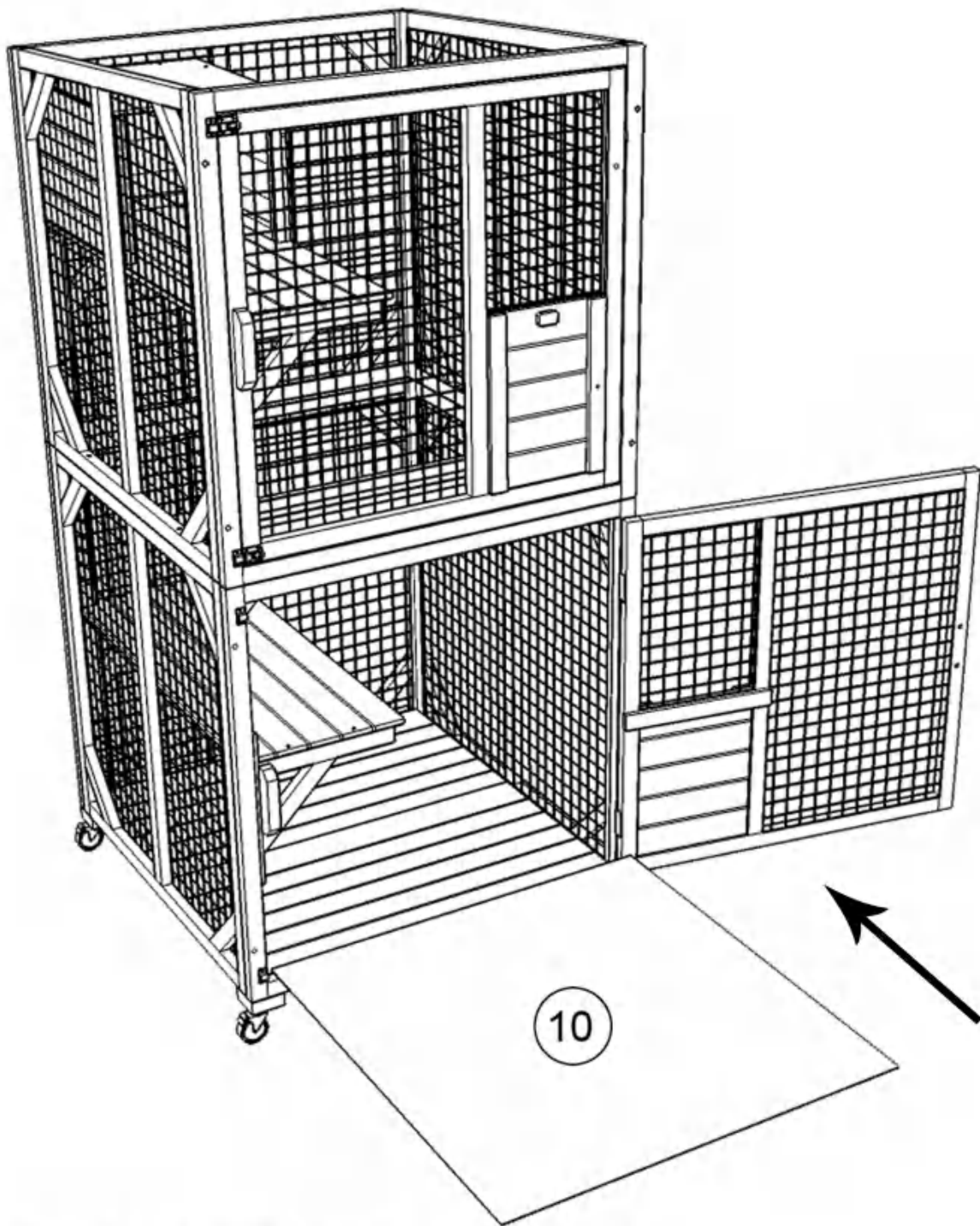

Put in the plastic liner on the bottom floor as shown

STEP:18

Install the felted roof part #3 with screws (D)x8

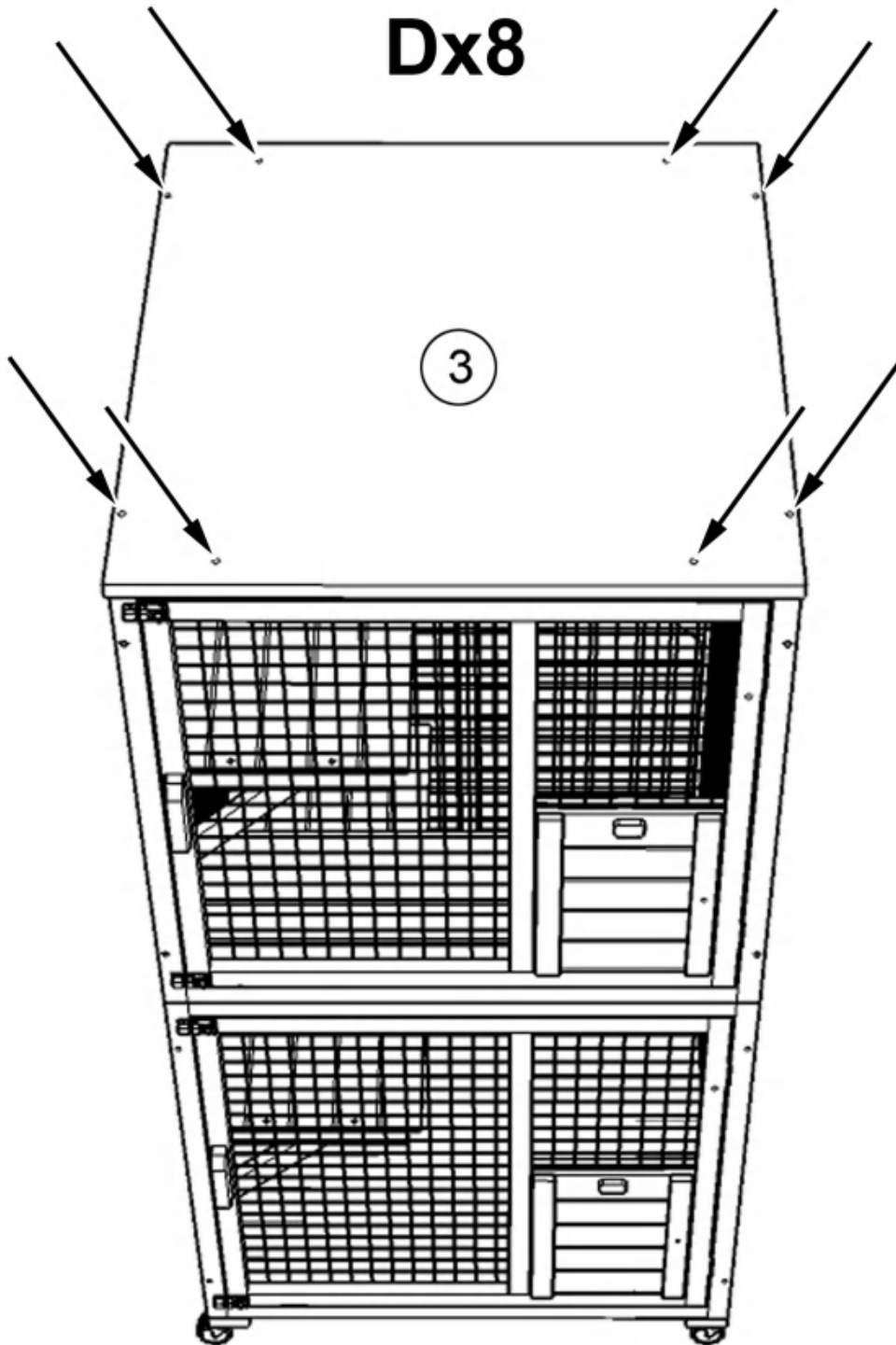

STEP:19

Shuangchenglu 803nong11hao1602A-1609shi, baoshanqu,
shanghai 200000 CN.



E-CrossStu GmbH.
Mainzer Landstr.69, 60329
Frankfurt am Main.



YH CONSULTING LIMITED.
C/O YH Consulting Limited Office
147, Centurion House, London Road,
Staines-upon-Thames, Surrey, TW18 4AX

Imported to USA: Sanven Technology Ltd., Suite 250, 9166
Anaheim Place, Rancho Cucamonga, CA 91730

VEVOR[®]

TOUGH TOOLS, HALF PRICE

Technical Support and E-Warranty Certificate

www.vevor.com/support

VEVOR[®]

TOUGH TOOLS, HALF PRICE

Technical Support and E-Warranty Certificate www.vevor.com/support

INSTRUCTION FOR CAT CAGE

MODEL:CH470

Seguimos comprometidos a brindarle herramientas a precios competitivos.

"Ahorre la mitad", "mitad de precio" o cualquier otra expresión similar que utilicemos solo representa una estimación del ahorro que podría obtener al comprar ciertas herramientas con nosotros en comparación con las principales marcas y no necesariamente significa que cubra todas las categorías de herramientas que ofrecemos. Le recordamos que, al realizar un pedido con nosotros, verifique cuidadosamente si realmente está ahorrando la mitad en comparación con las principales marcas.

VEVOR[®]
TOUGH TOOLS, HALF PRICE

CAT CAGE

CH470



NEED HELP? CONTACT US!

Have product questions? Need technical support? Please feel free to contact us:

Soporte técnico y certificado de garantía electrónica www.vevor.com/support

This is the original instruction, please read all manual instructions carefully before operating. VEVOR reserves a clear interpretation of our user manual. The appearance of the product shall be subject to the product you received. Please forgive us that we won't inform you again if there are any technology or software updates on our product.

WARNING:

Read this material before using this product. Failure to do so can result in serious injury.

Assembly precautions

1. Assemble only according to these instructions. Improper assembly can create hazards.
2. In order to ensure your own safety, please make sure to ANSI-approved safety goggles and heavy-duty work gloves when installing this product.
3. Keep the assembly area clean and well lit.
4. Keep bystanders out of the area during assembly.
5. Do not assemble when tired or when under the influence of alcohol, drugs or medication.
6. Product capabilities apply to properly and completely assembled product only.
7. Assemble on a flat, level, hard and smooth surface capable of safely supporting a fully loaded cat cage.

Use precautions

TO PREVENT SERIOUS INJURY AND DEATH FROM TIPPING:

1. DO NOT SIT OR STAND ON THIS ITEM.
2. This product is not a toy. Do not allow children to play with or near this item. Please keep small spare parts out of children's reach.
3. Use only on a flat, level, hard and smooth surface capable of safely supporting a fully loaded cat cage.
4. Use as intended only.
5. Inspect before every use; do not use if parts are loose or damaged.

SAVE THESE INSTRUCTIONS

SPECIFICATIONS

Model	CH470
Product Size	760×865×1630mm
Color	Gray

COMPONENTS

Notice:

1. Various specifications of screws are used in the installation of this product. Pay attention to the correct use of screw specifications according to the instruction manual.
2. Please wear gloves when installing.

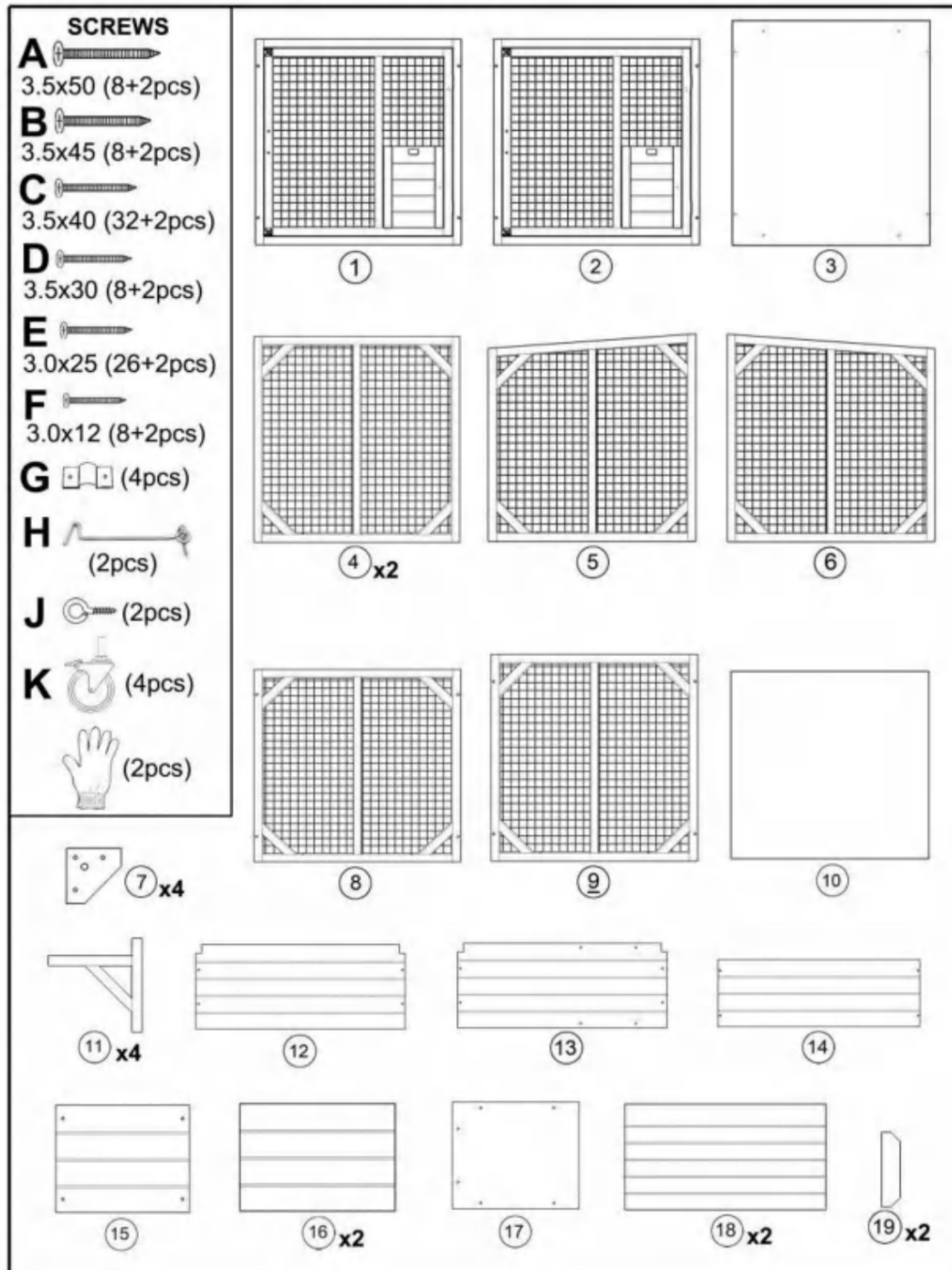

Assembly Instructions

Please be noted that the side with wire nailed on is back side, should be inward when installation

This end with a long piece of wood is placed at bottom

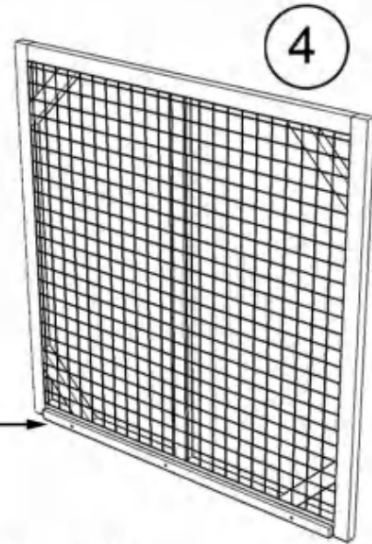

Assembling part #4x2 and part #1 with screws (C)x4 as shown below

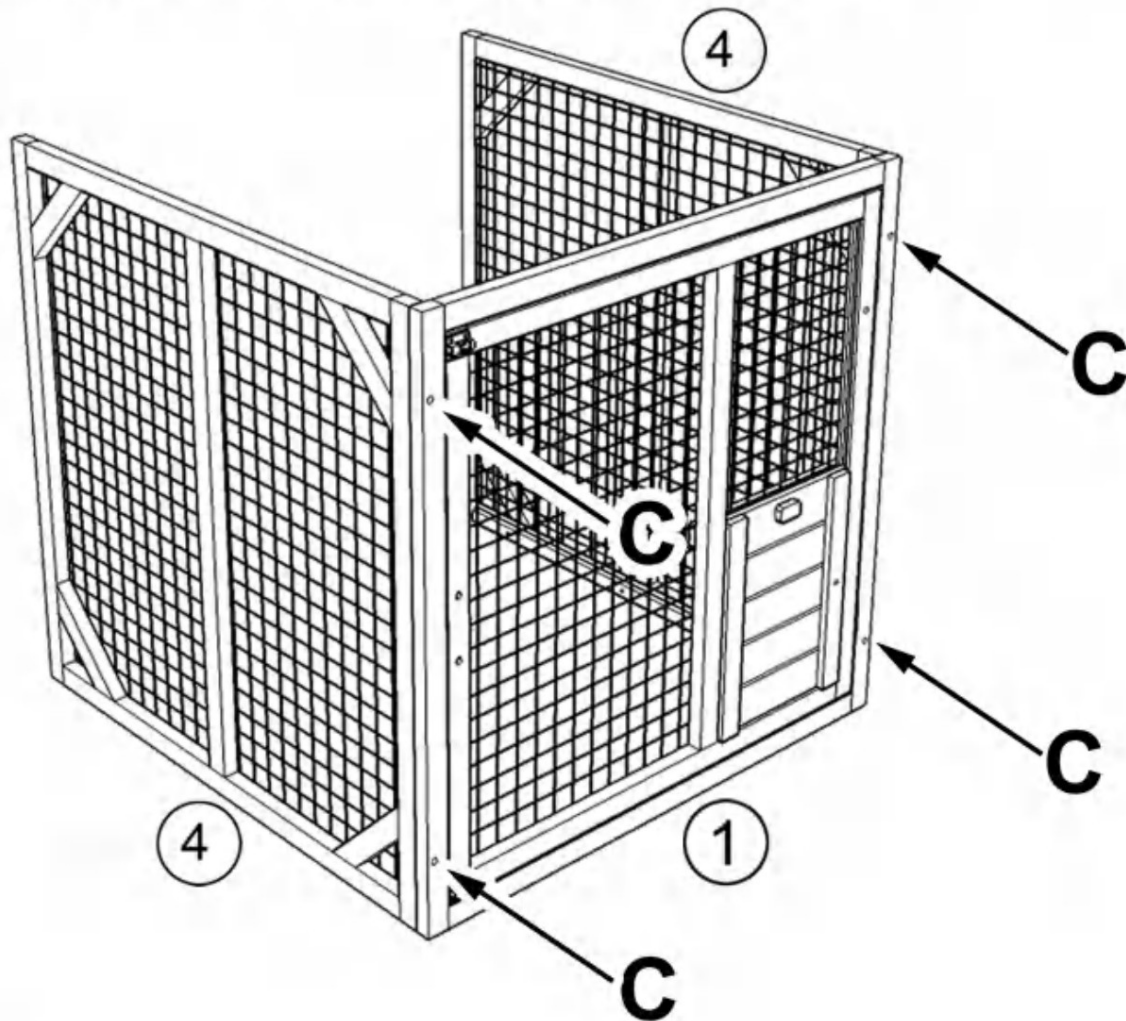

STEP:1

The part #2 (open the door) and part #5 has pre-drilled holes at bottom as shown, assemble part #2 and part #5 with screws (C)x2, then place them on the parts finished in last step and secure them with screws (A)x4 downwards

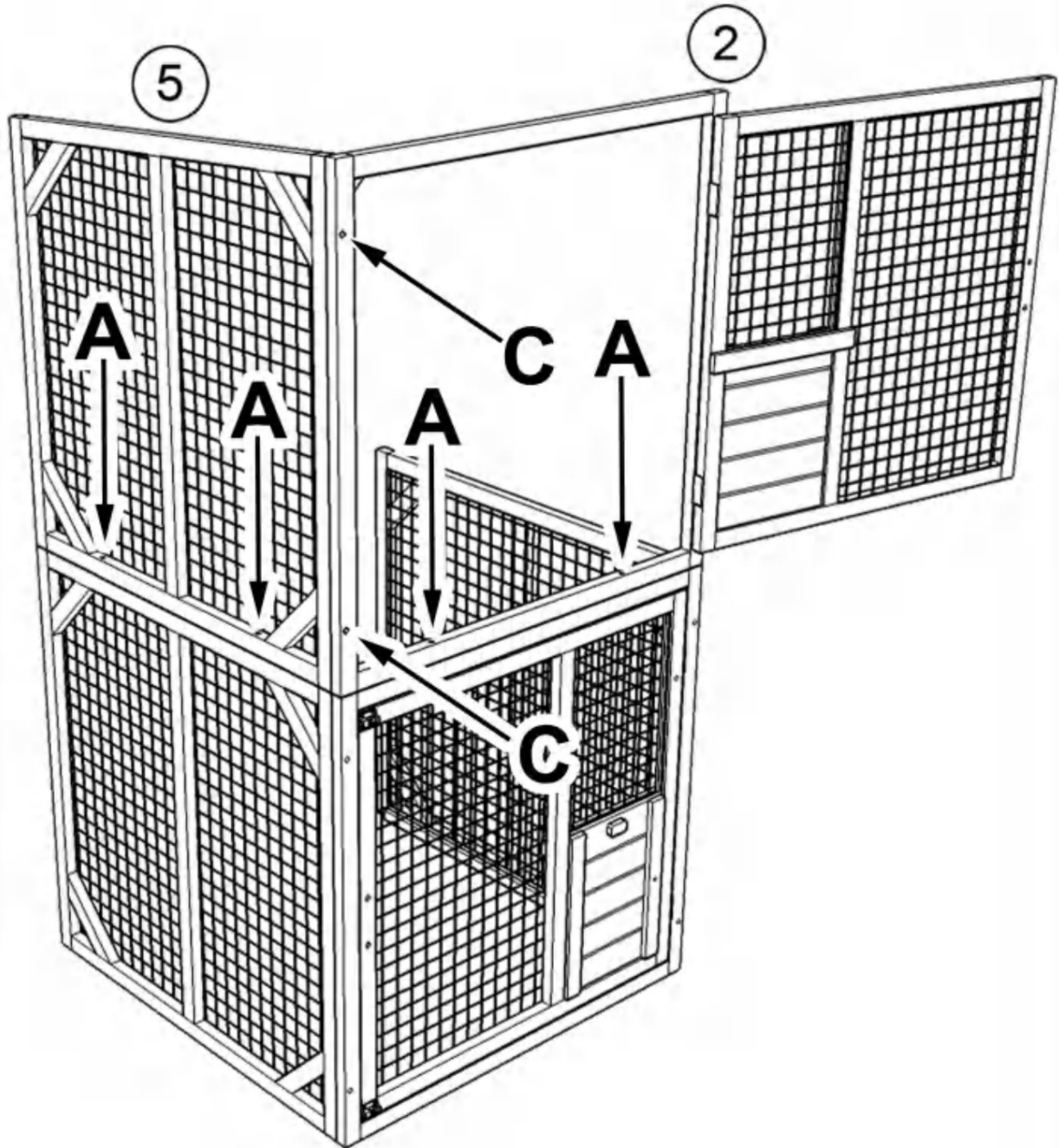

STEP:2

The part #6 has 2 pre-drilled holes at bottom, assembling part #6 with screws (C)x2 as shown and secure it to lower part with screws (A)x2 downwards

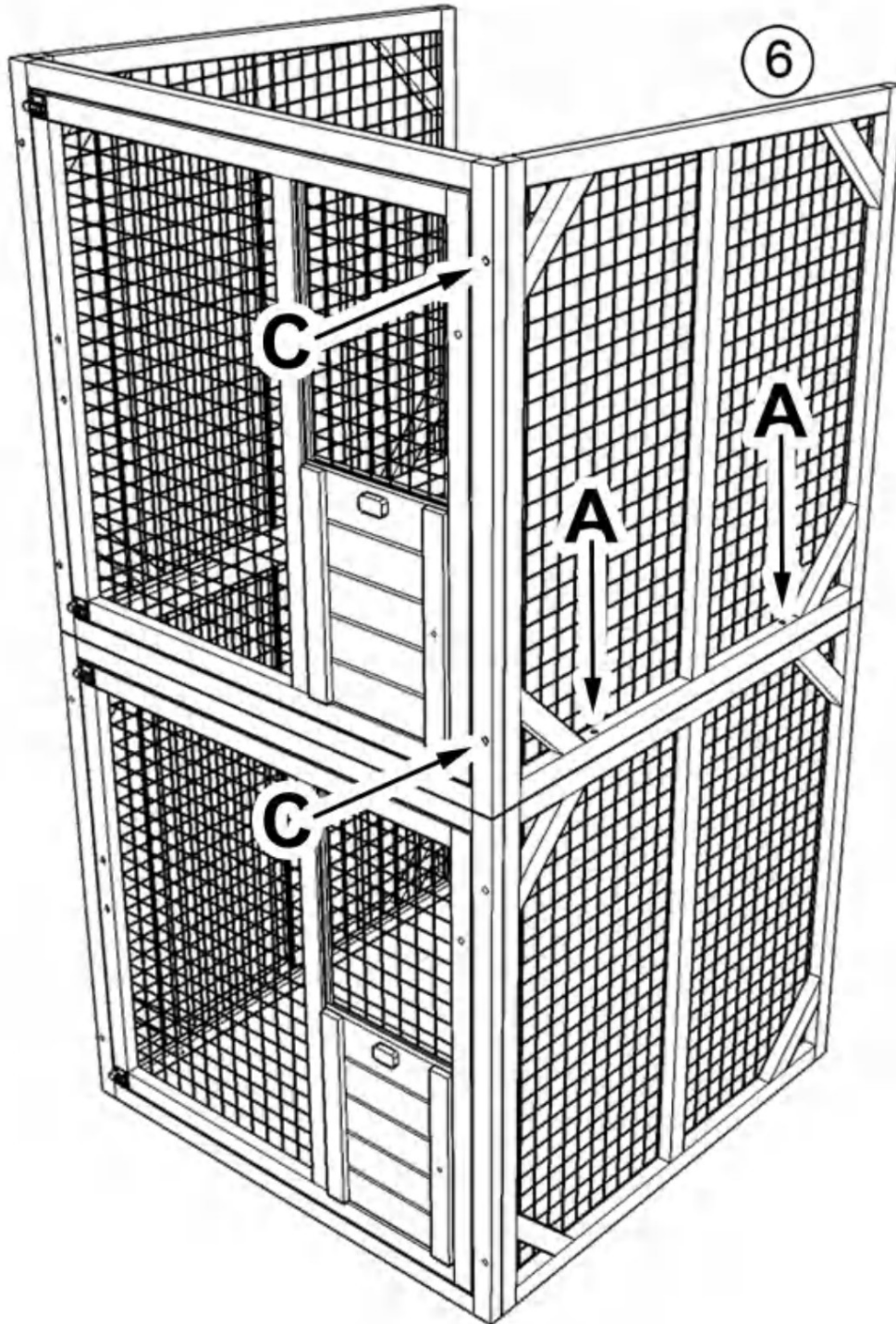

STEP:3

Assembling shelf with part #12 and part #11x2 by screws (E)x4 as shown

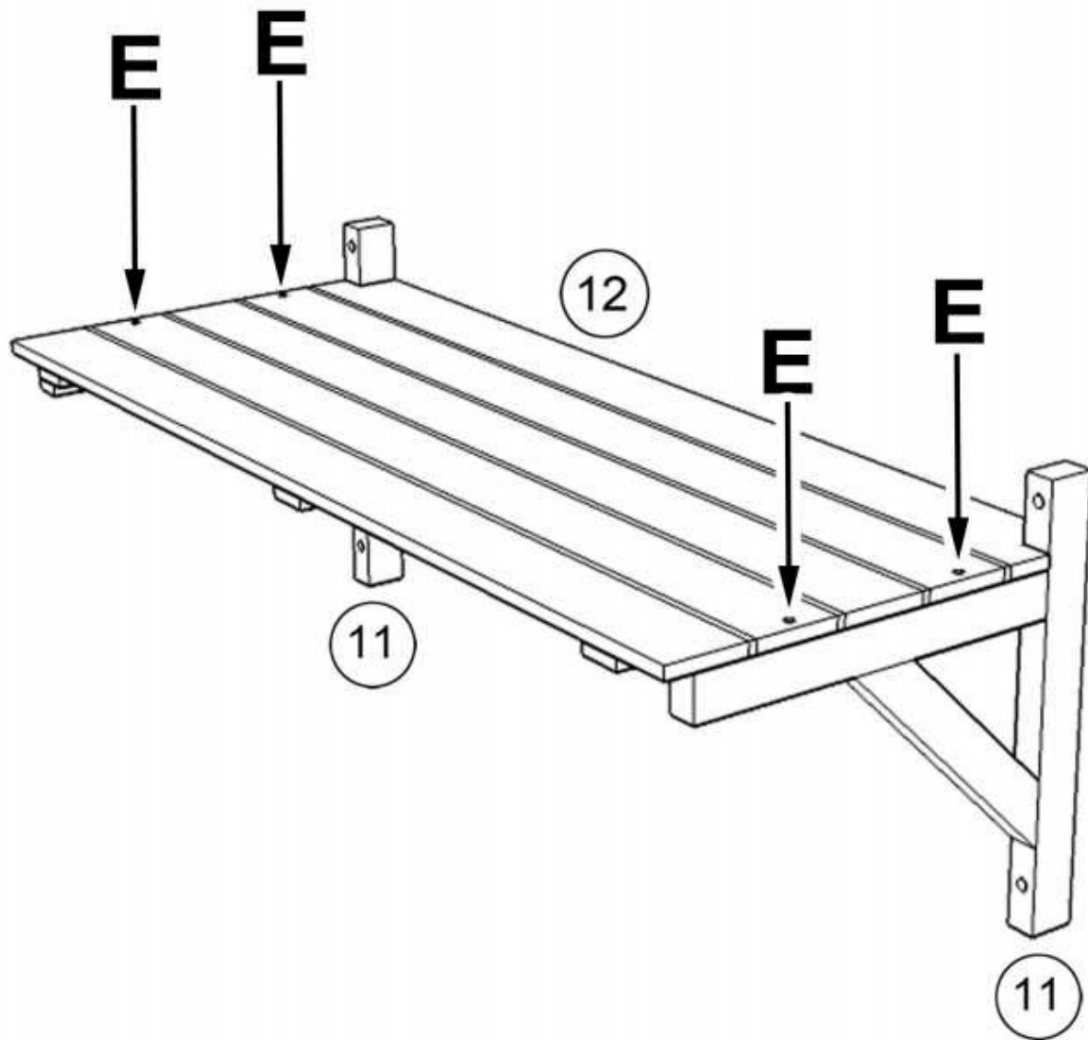

STEP:4

Mounting the shelf on right side as shown by screws (B)x4 at your preferred height

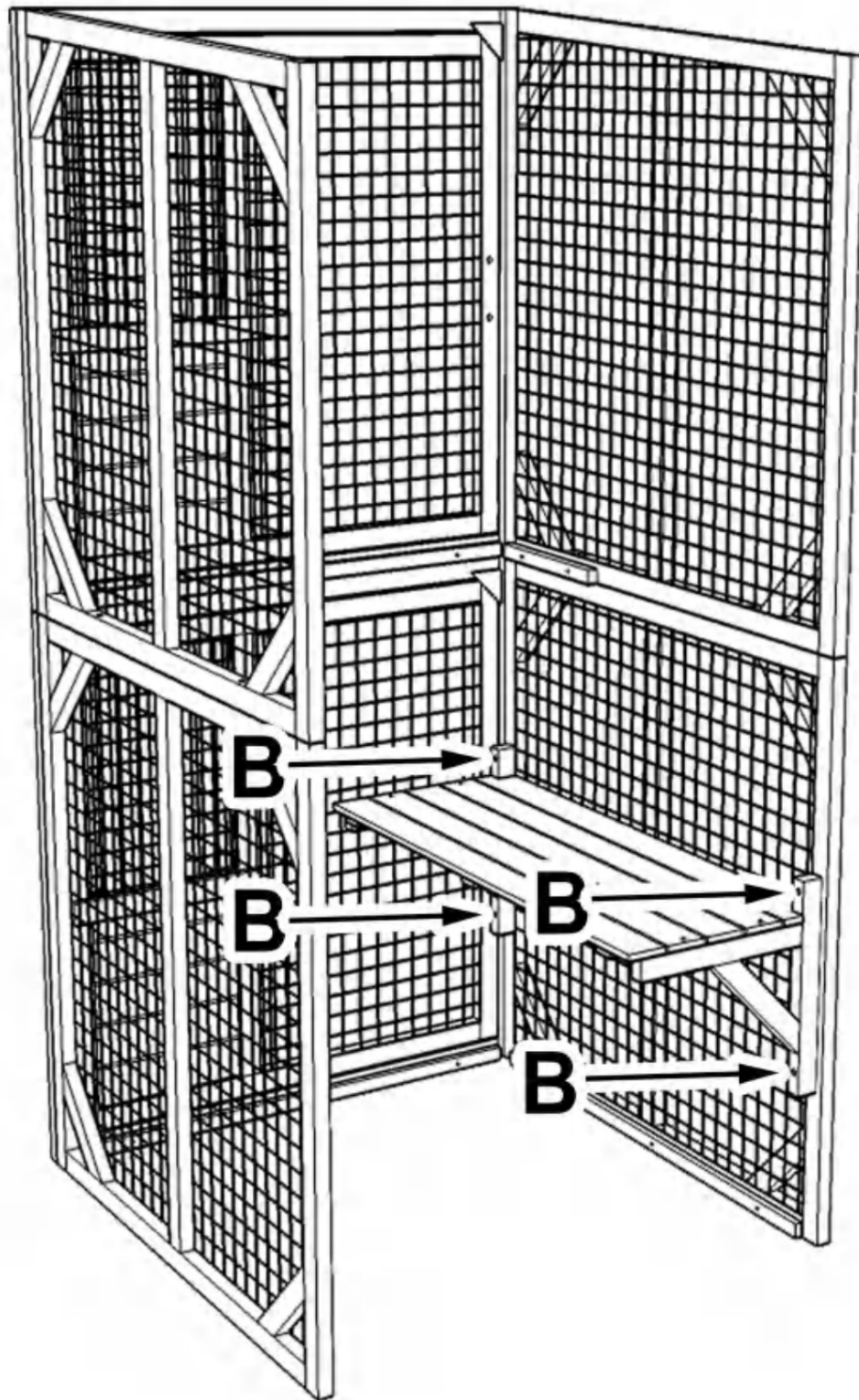

STEP:5

Placing part #14 on the short wood pieces on left and right side and secure it with screw (E)x4

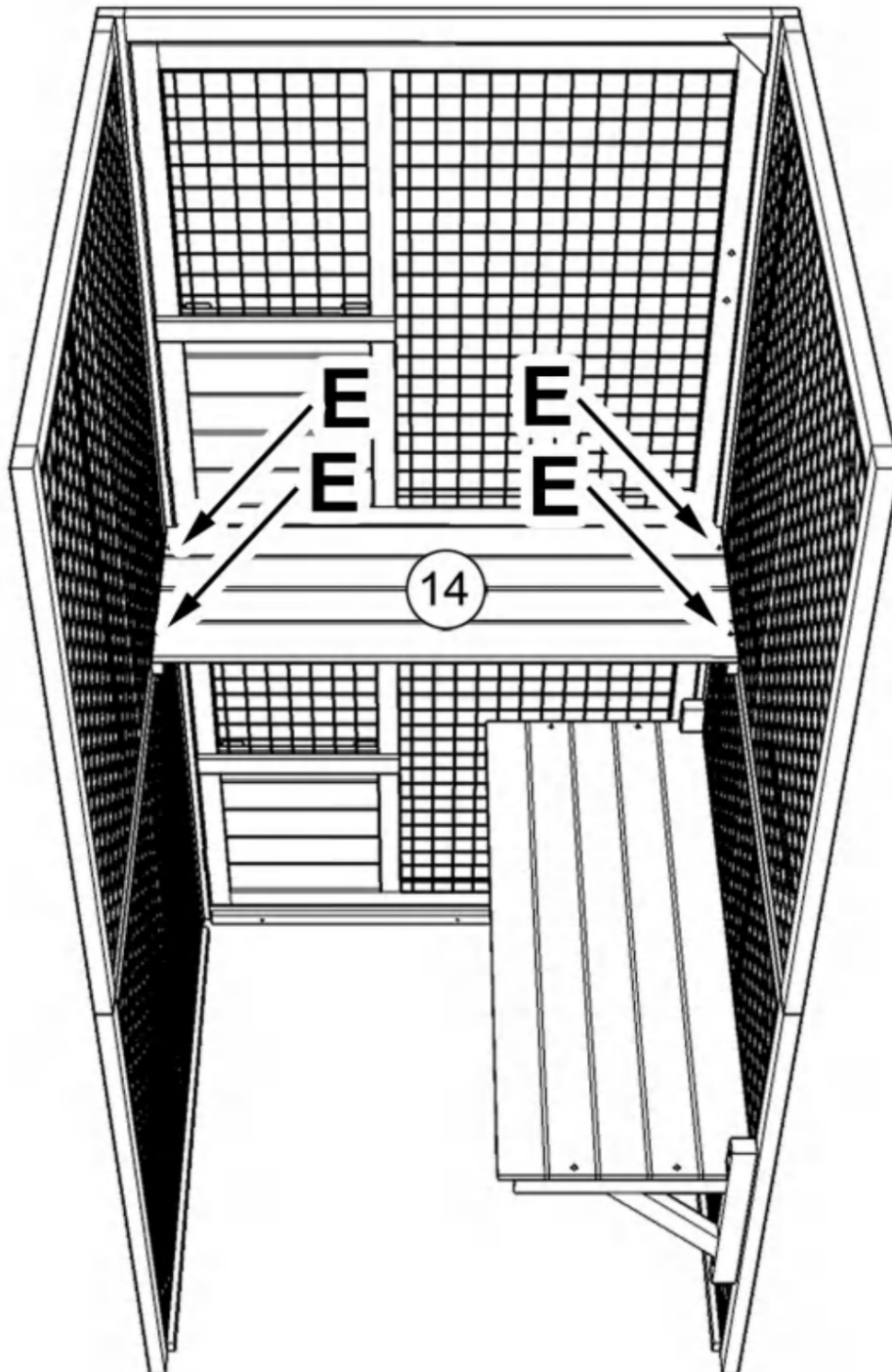

STEP:6

Assembling shelf with part #13 and part #11x2 by screws (E)x4 as shown

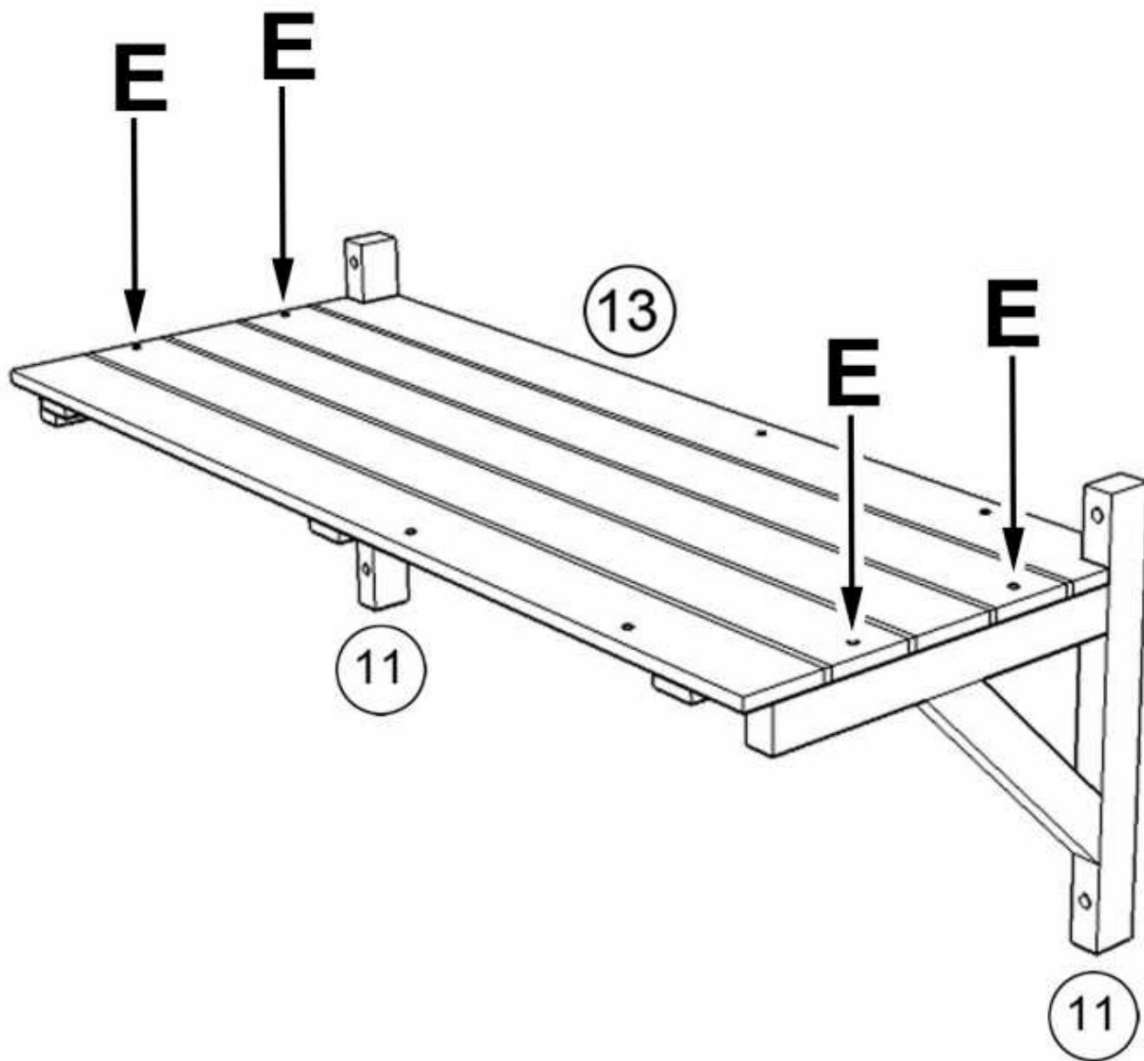

STEP:7

Mounting the shelf to the right side of board as shown with screws (B)x4 at your preferred height

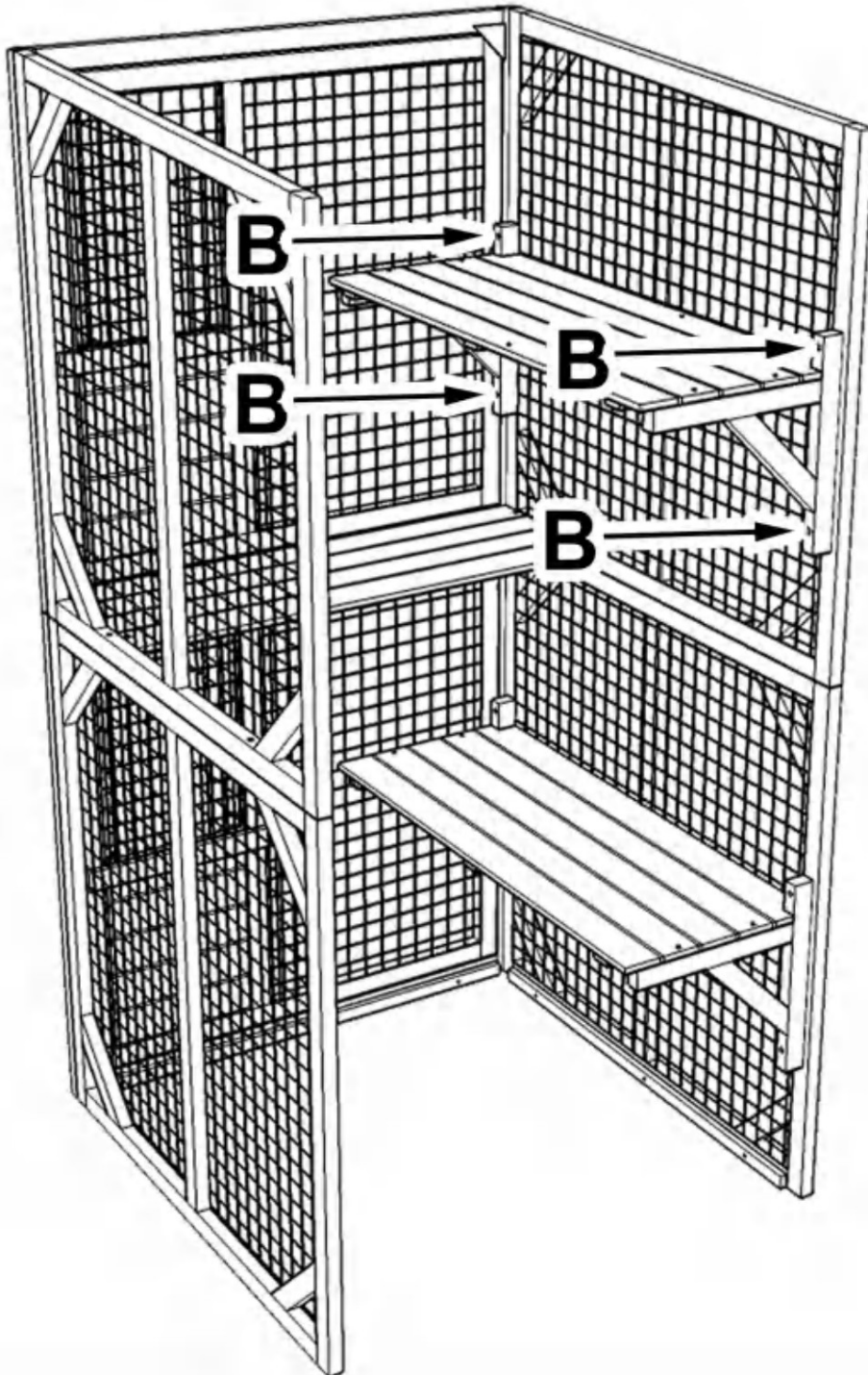

STEP:8

Assembling sleeping box with part #16x2, #17, #15 using screws (E)x10

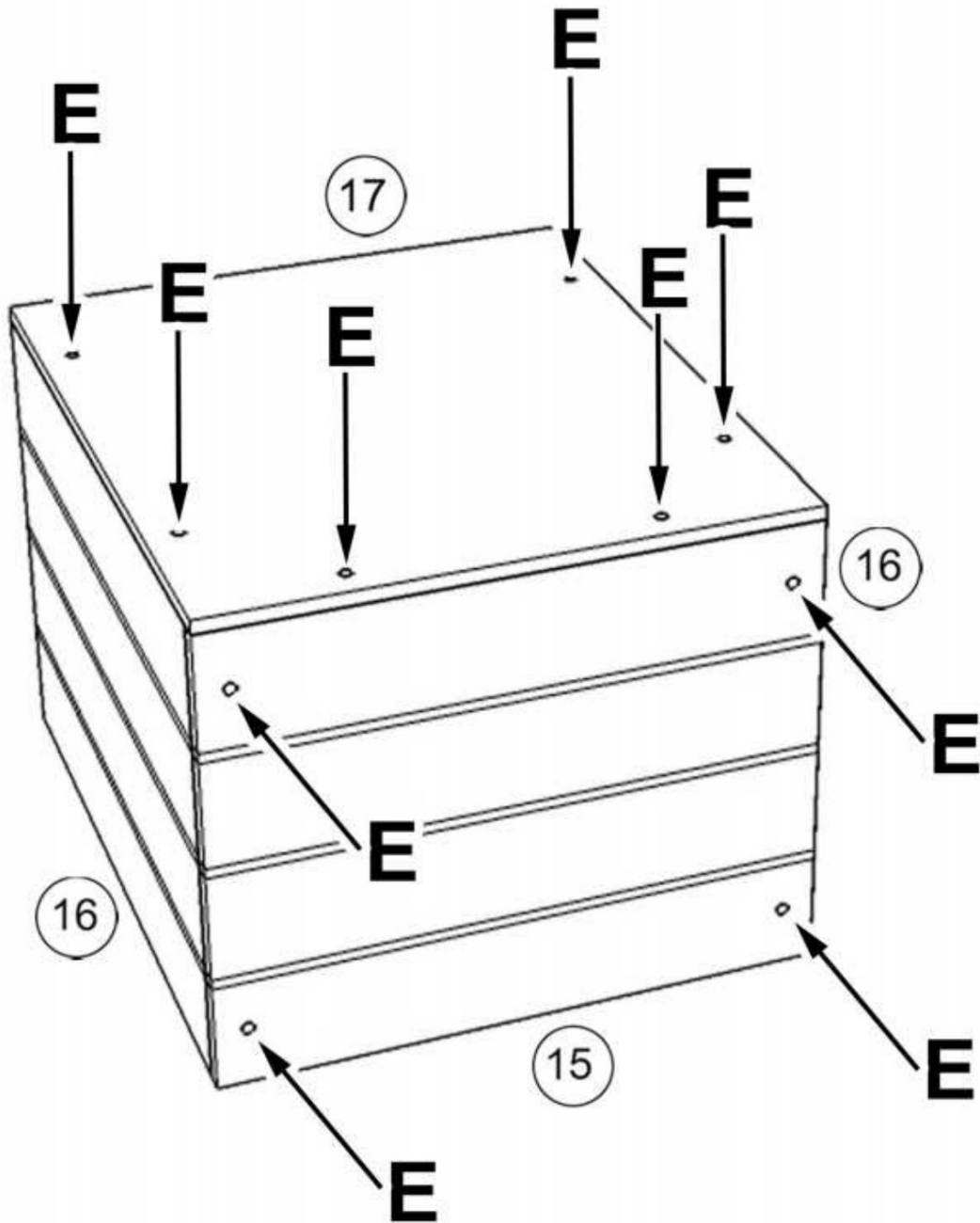

STEP:9

Placing sleeping box on the top of shelf as shown and secure it with screws (E)x4 from the bottom of shelf

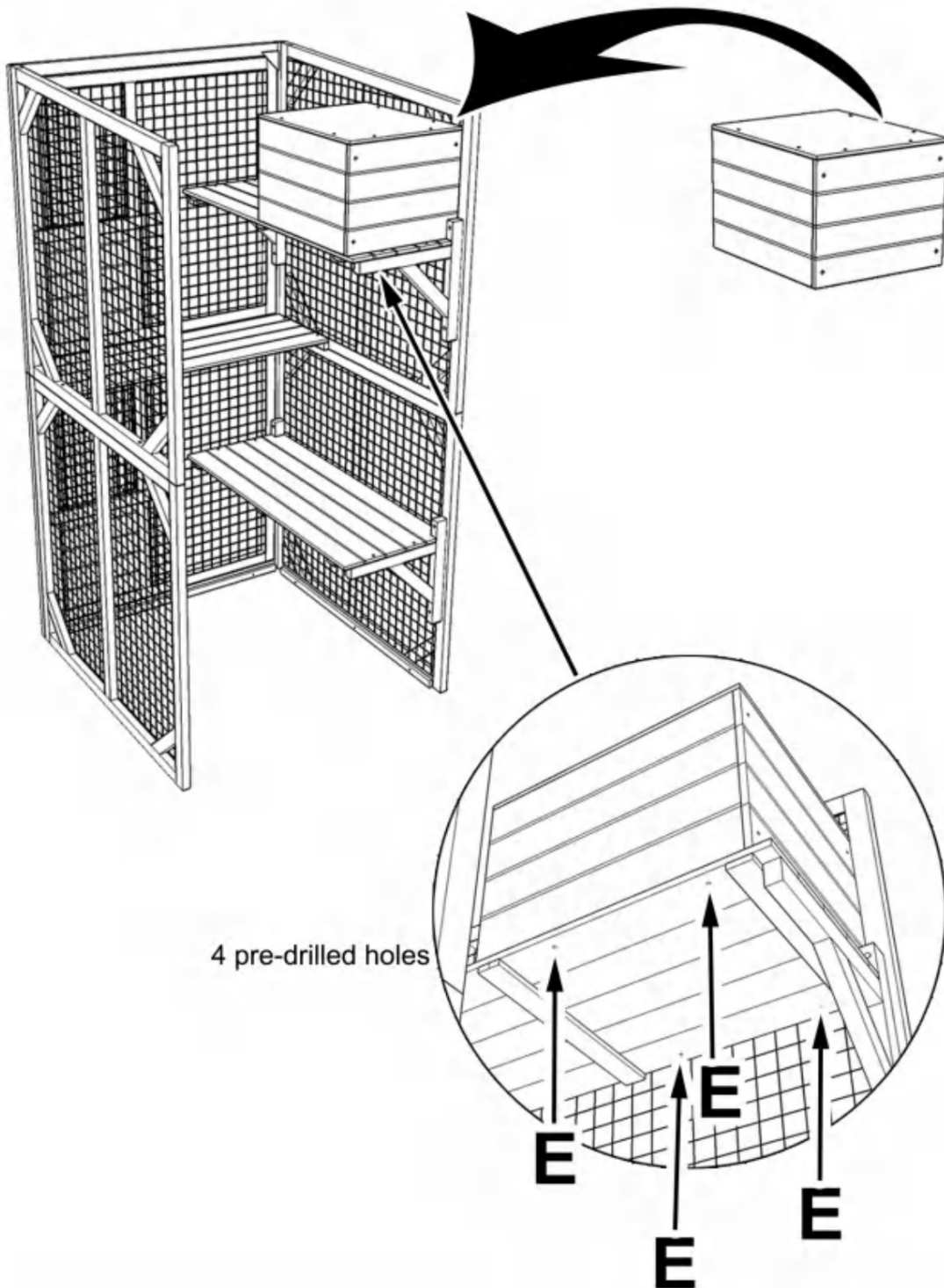

STEP:10

Assembling firstly part #9 (bottom) and then part #8 (2 holes at bottom) with screws (C)x8, then secure the 2 parts by screwing (A)x2 downwards as shown

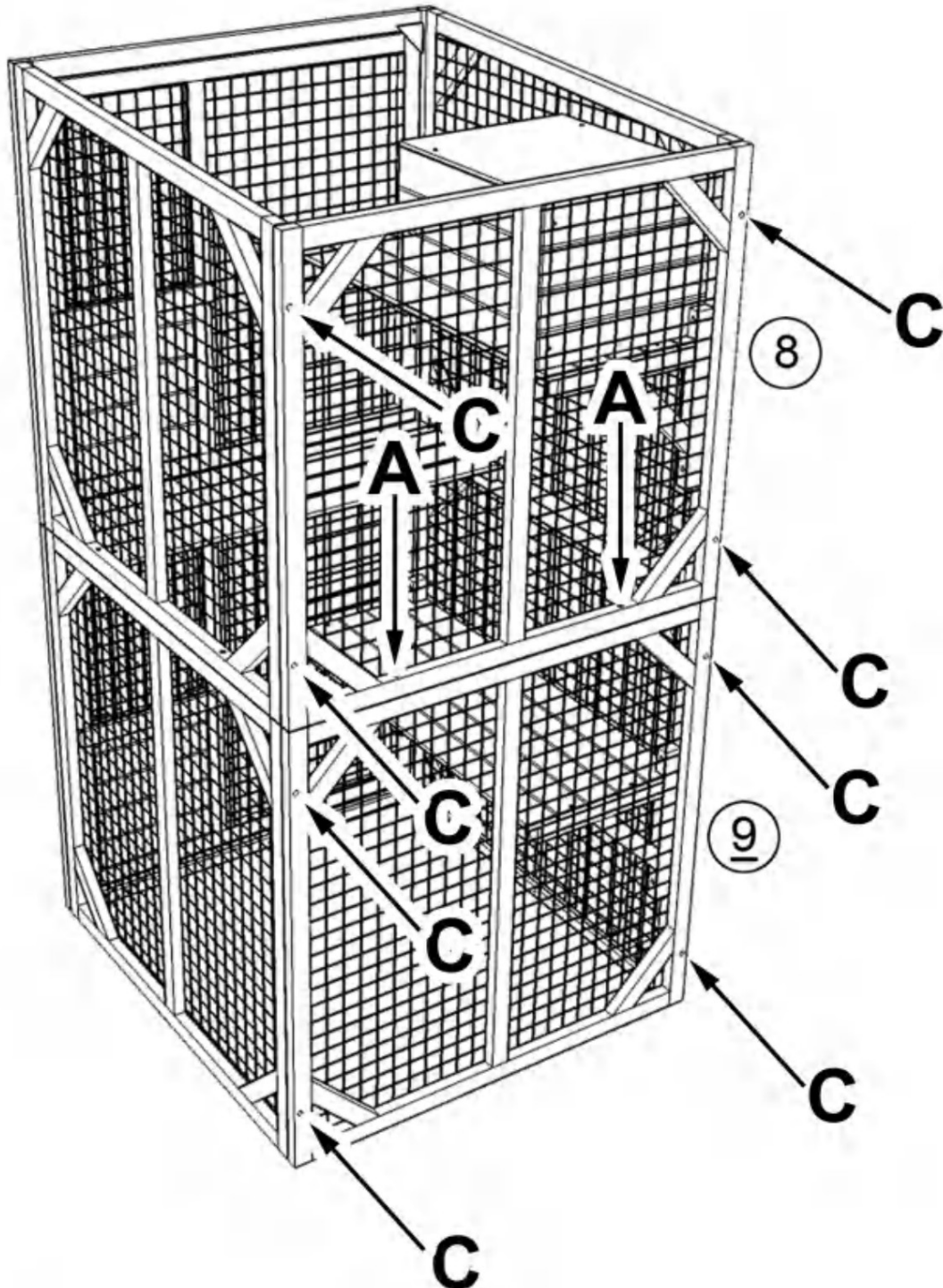

STEP:11

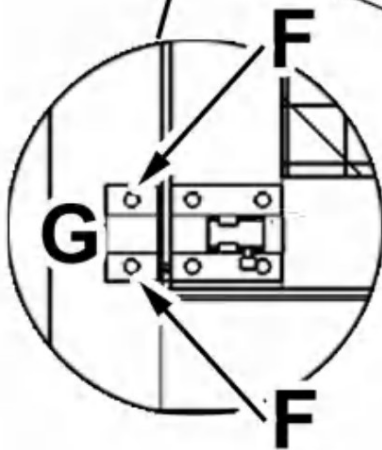
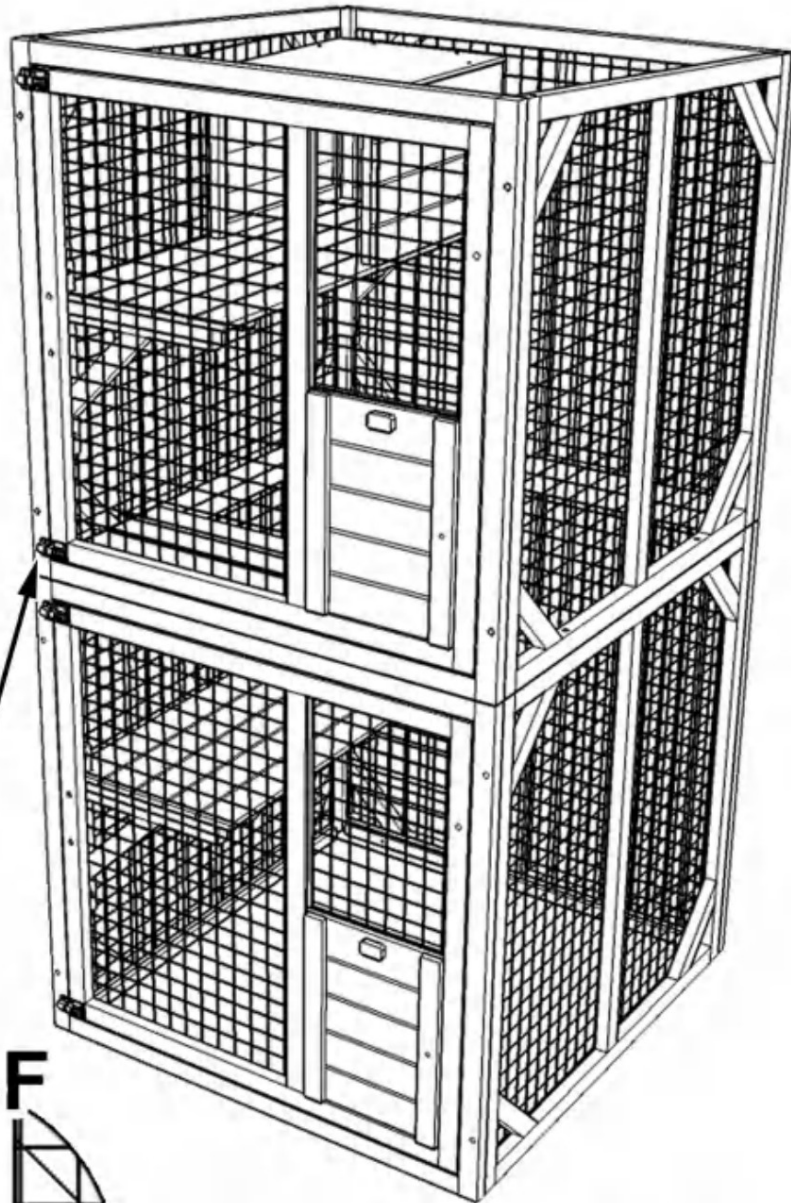

Align the short end of lock part #G with its other part already on door then secure it with screws (F)x2

STEP:12

Install handles parts #19x2 on doors with screws (C)x4 as shown

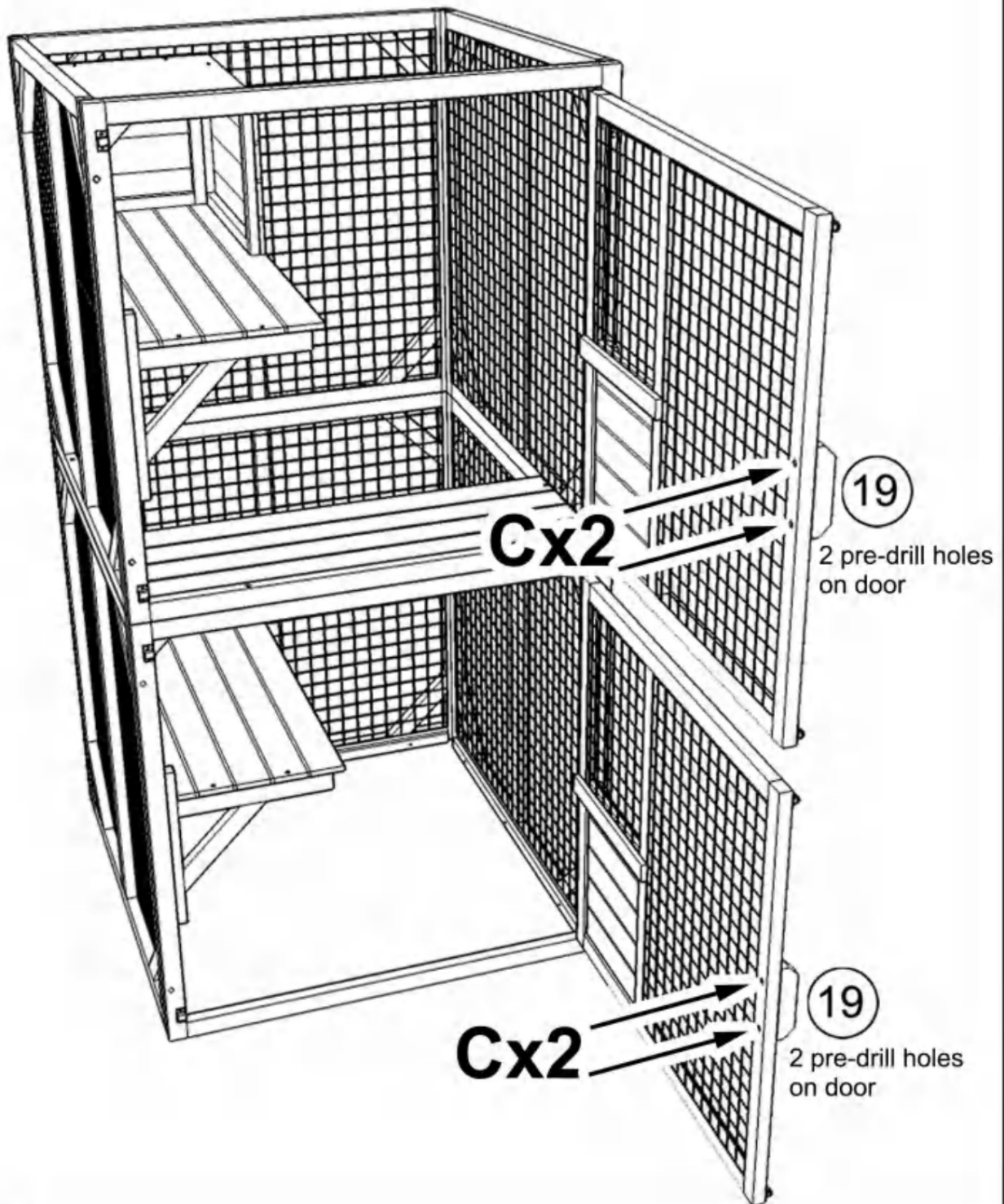

STEP:13

Install hooks as shown, long part is on the sliding door, short part is on the frame wood

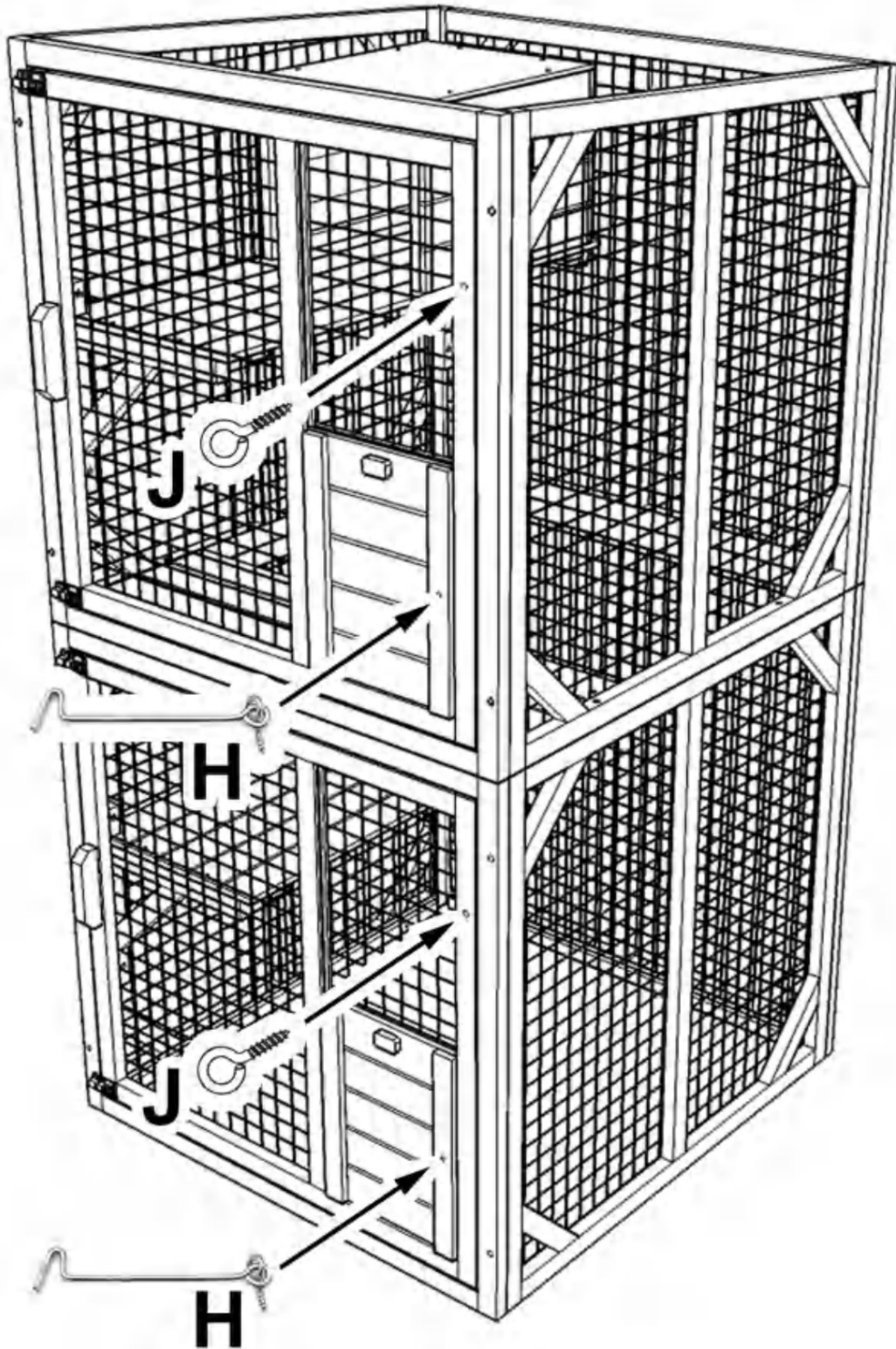

STEP:14

Gently let down the product, install part #7x4 as shown by screws (C)x12

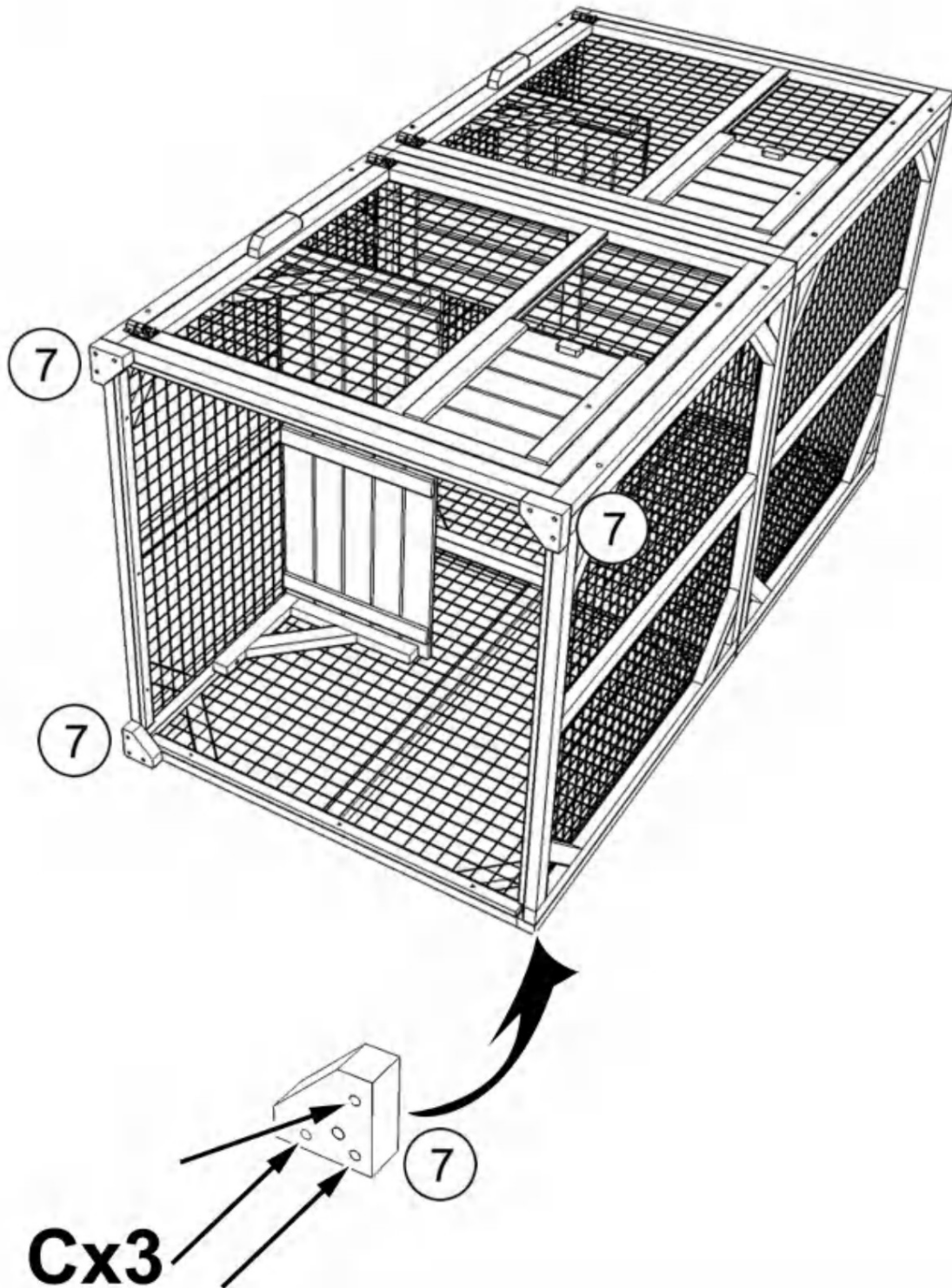

STEP:15

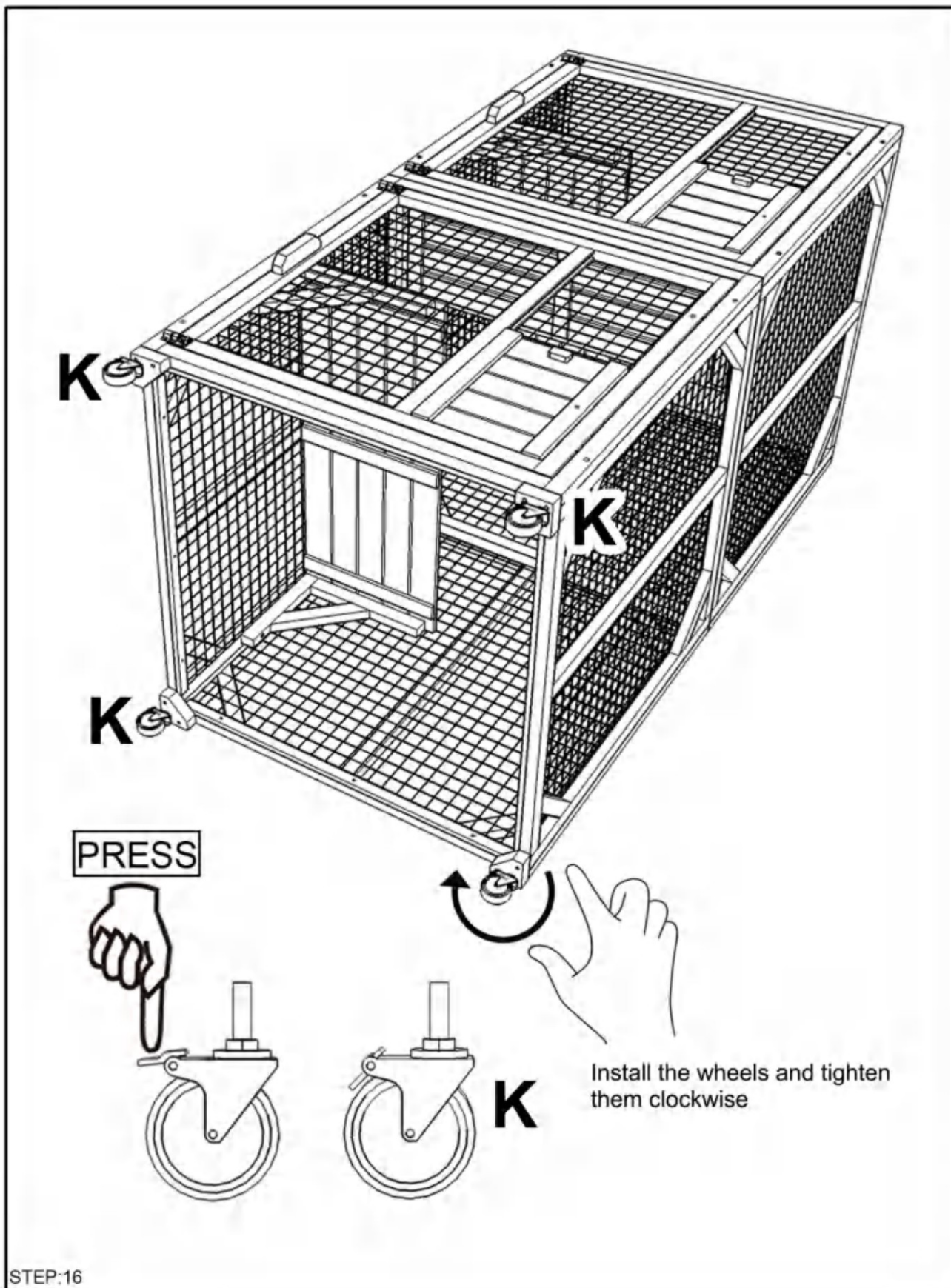

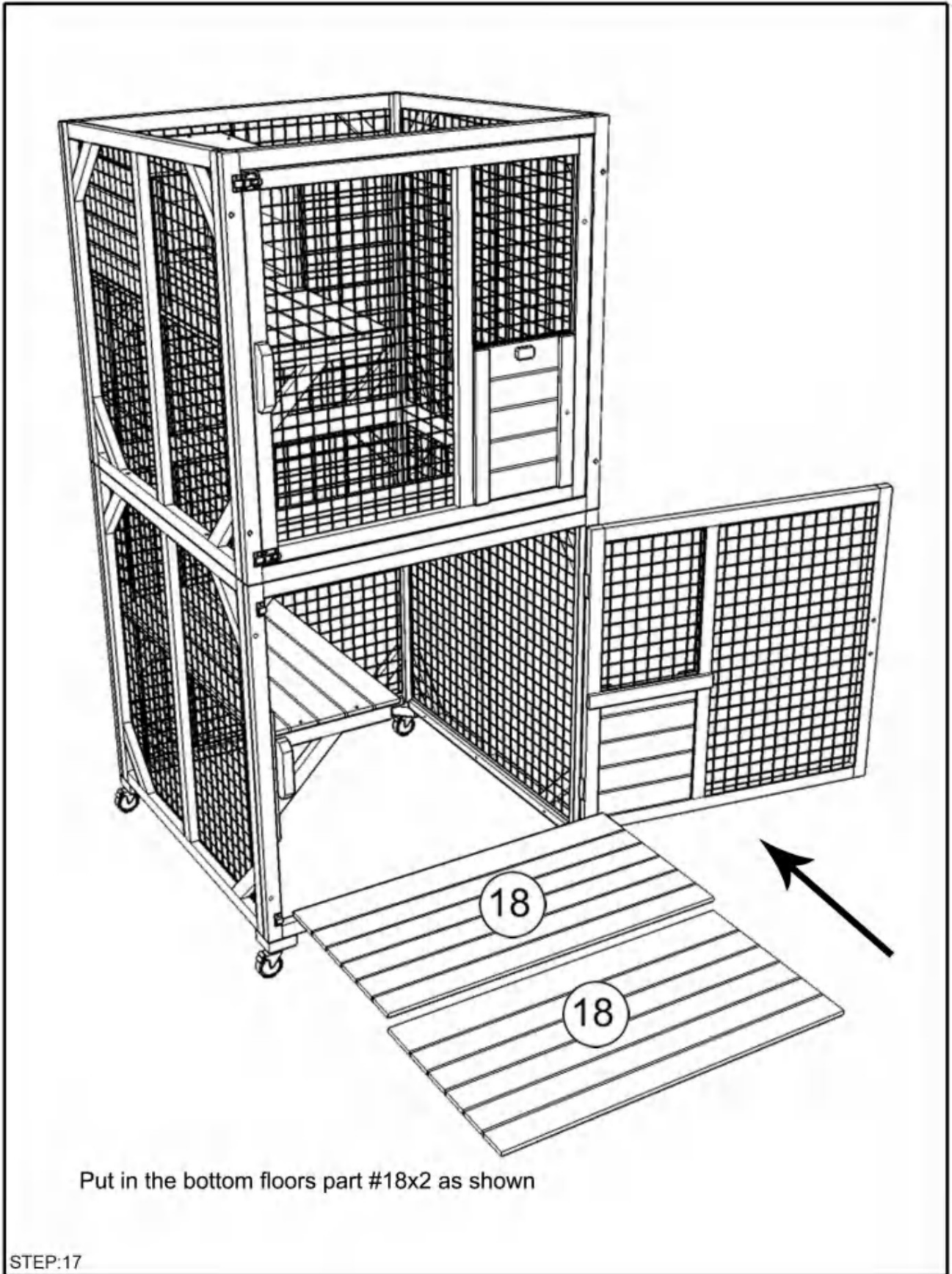

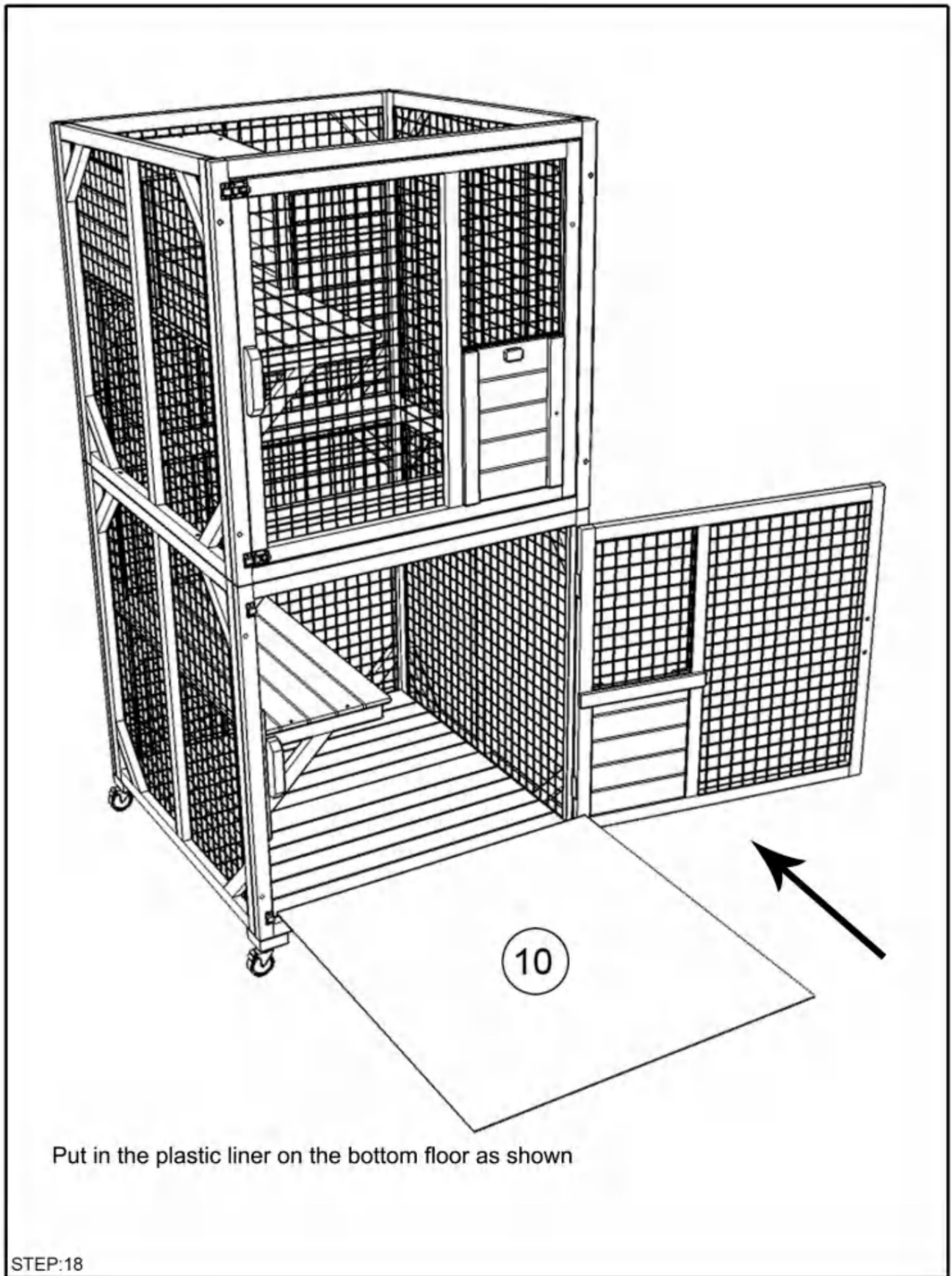

Install the felted roof part #3 with screws (D)x8

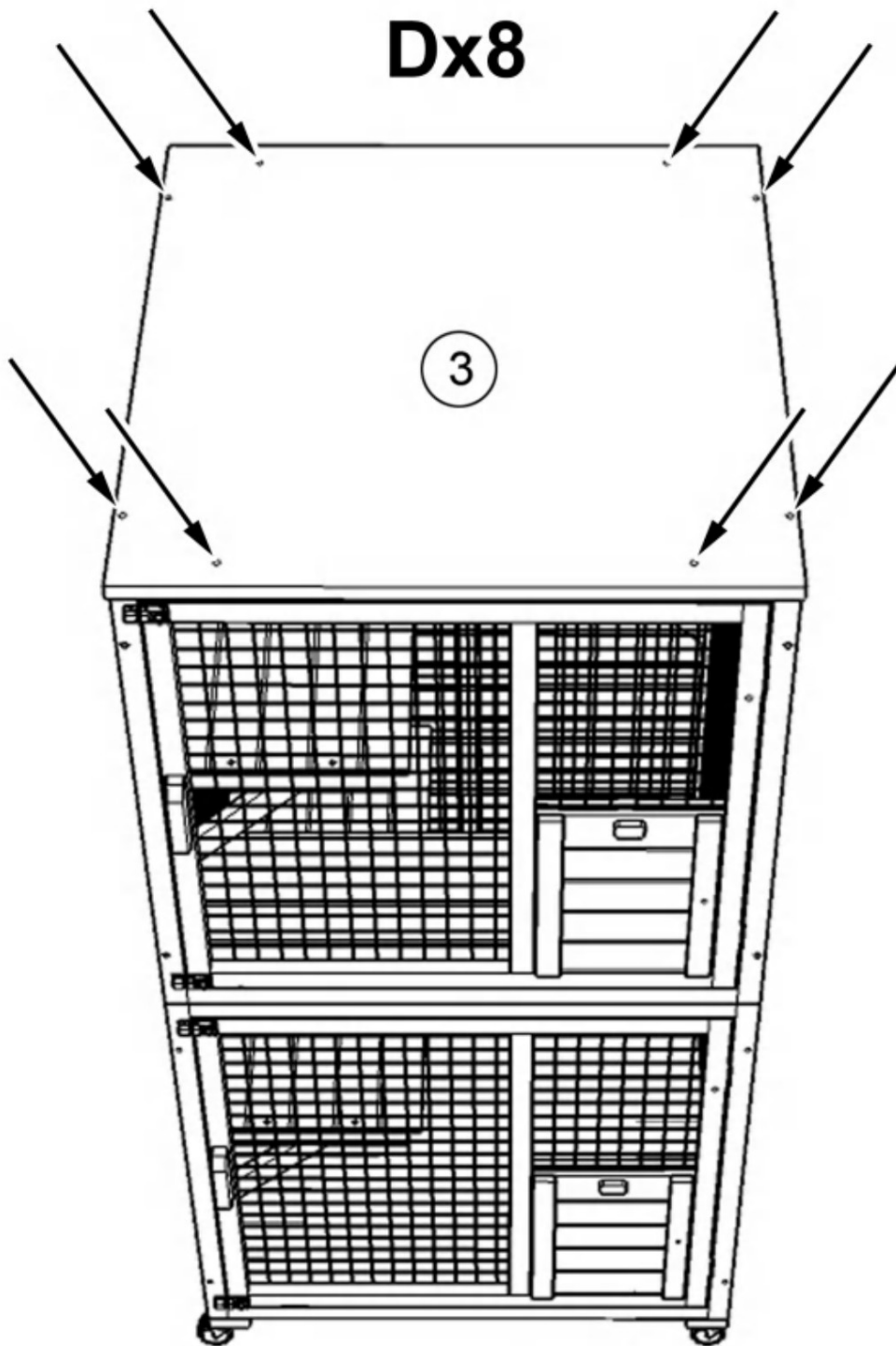

STEP:19

Shuangchenglu 803nong11hao1602A-1609shi, baoshanqu,
shanghai 200000 CN.



Empresa E-CrossStu GmbH.

Mainzer Landstr.69, 60329
Fráncfort del Meno.



YH CONSULTING LIMITADA.

C/O YH Consulting Limited Oficina 147,
Centurion House, London Road, Staines-
upon-Thames, Surrey, TW18 4AX

Importado a EE. UU.: Sanven Technology Ltd., Suite 250, 9166
Anaheim Place, Rancho Cucamonga, CA 91730

VEVOR[®]

TOUGH TOOLS, HALF PRICE

Technical Support and E-Warranty Certificate

www.vevor.com/support

VEVOR[®]

TOUGH TOOLS, HALF PRICE

Technical Support and E-Warranty Certificate www.vevor.com/support

INSTRUCTION FOR CAT CAGE

MODEL:CH470

Vi fortsätter att vara engagerade i att ge dig verktyg till konkurrenskraftiga priser. "Spara hälften", "halva priset" eller andra liknande uttryck som används av oss representerar bara en uppskattning av besparingar du kan dra nytta av att köpa vissa verktyg hos oss jämfört med de stora toppmärkena och betyder inte nödvändigtvis att täcka alla kategorier av verktyg som erbjuds av oss. Du påminns vänligen om att noggrant kontrollera när du gör en beställning hos oss om du faktiskt sparar hälften i jämförelse med de främsta stora varumärkena.

VEVOR[®]
TOUGH TOOLS, HALF PRICE

CAT CAGE

CH470

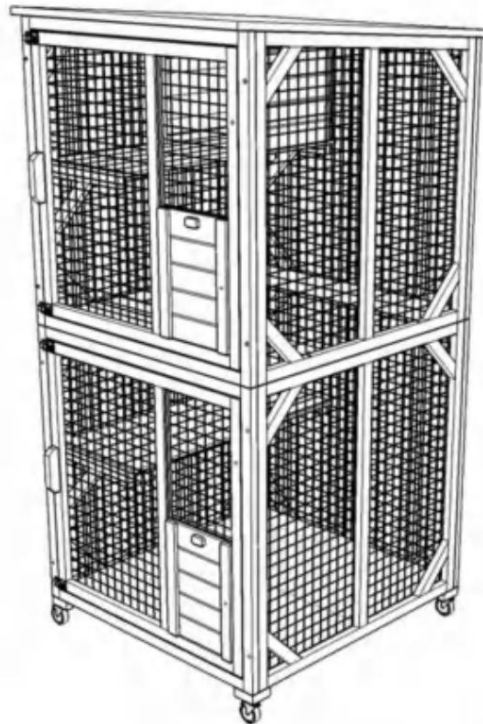

NEED HELP? CONTACT US!

Have product questions? Need technical support? Please feel free to contact us:

Teknisk support och e-garanticertifikat www.vevor.com/support

This is the original instruction, please read all manual instructions carefully before operating. VEVOR reserves a clear interpretation of our user manual. The appearance of the product shall be subject to the product you received. Please forgive us that we won't inform you again if there are any technology or software updates on our product.

WARNING:

Read this material before using this product. Failure to do so can result in serious injury.

Assembly precautions

1. Assemble only according to these instructions. Improper assembly can create hazards.
2. In order to ensure your own safety, please make sure to ANSI-approved safety goggles and heavy-duty work gloves when installing this product.
3. Keep the assembly area clean and well lit.
4. Keep bystanders out of the area during assembly.
5. Do not assemble when tired or when under the influence of alcohol, drugs or medication.
6. Product capabilities apply to properly and completely assembled product only.
7. Assemble on a flat, level, hard and smooth surface capable of safely supporting a fully loaded cat cage.

Use precautions

TO PREVENT SERIOUS INJURY AND DEATH FROM TIPPING:

1. DO NOT SIT OR STAND ON THIS ITEM.
2. This product is not a toy. Do not allow children to play with or near this item. Please keep small spare parts out of children's reach.
3. Use only on a flat, level, hard and smooth surface capable of safely supporting a fully loaded cat cage.
4. Use as intended only.
5. Inspect before every use; do not use if parts are loose or damaged.

SAVE THESE INSTRUCTIONS

SPECIFICATIONS

Model	CH470
Product Size	760×865×1630mm
Color	Gray

COMPONENTS

Notice:

1. Various specifications of screws are used in the installation of this product. Pay attention to the correct use of screw specifications according to the instruction manual.
2. Please wear gloves when installing.

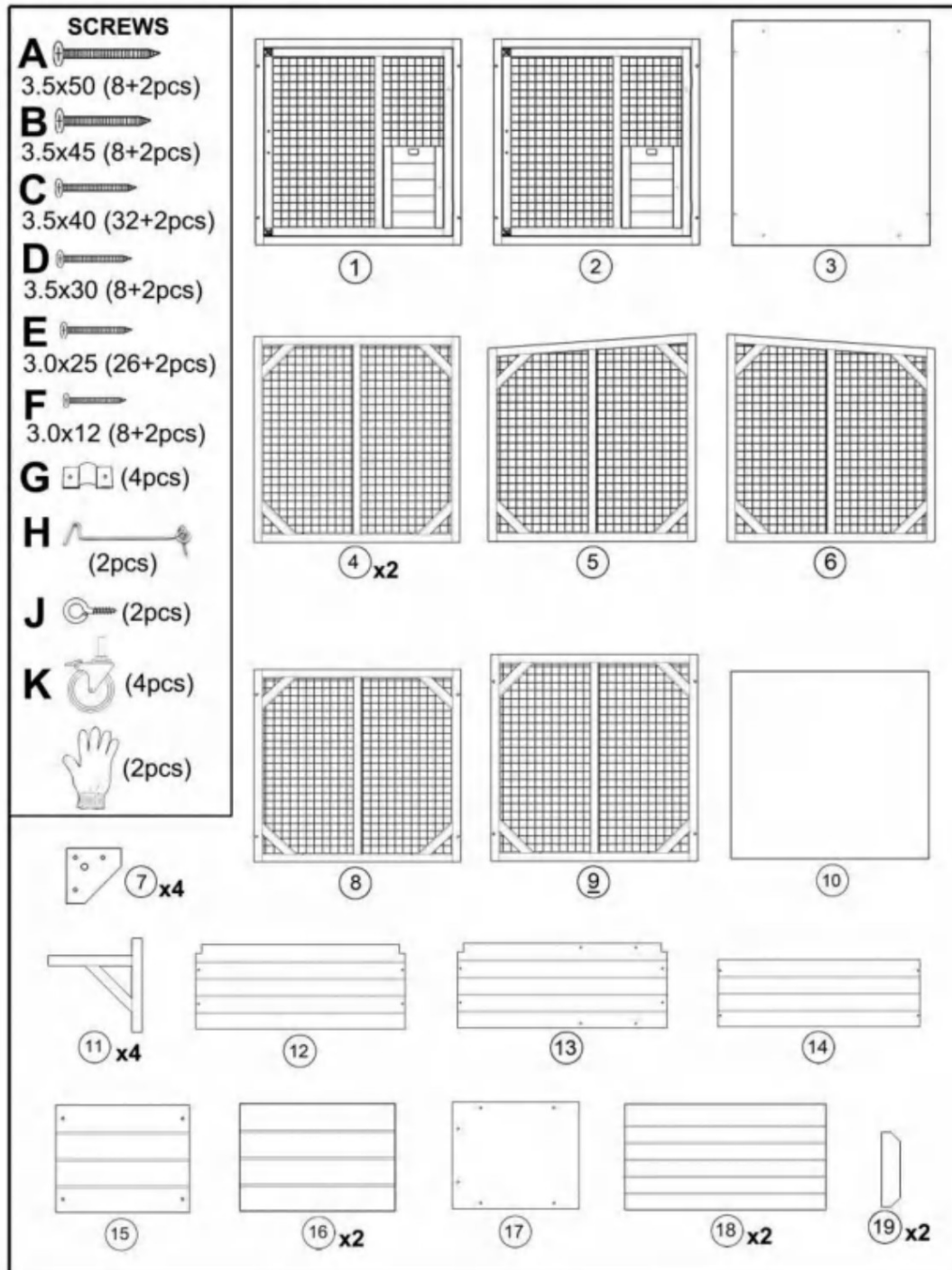

Assembly Instructions

Please be noted that the side with wire nailed on is back side, should be inward when installation

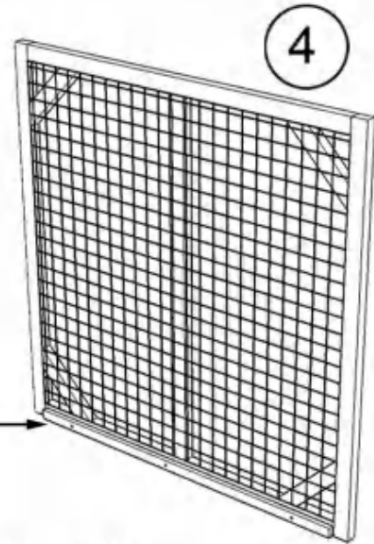

This end with a long piece of wood is placed at bottom

Assembling part #4x2 and part #1 with screws (C)x4 as shown below

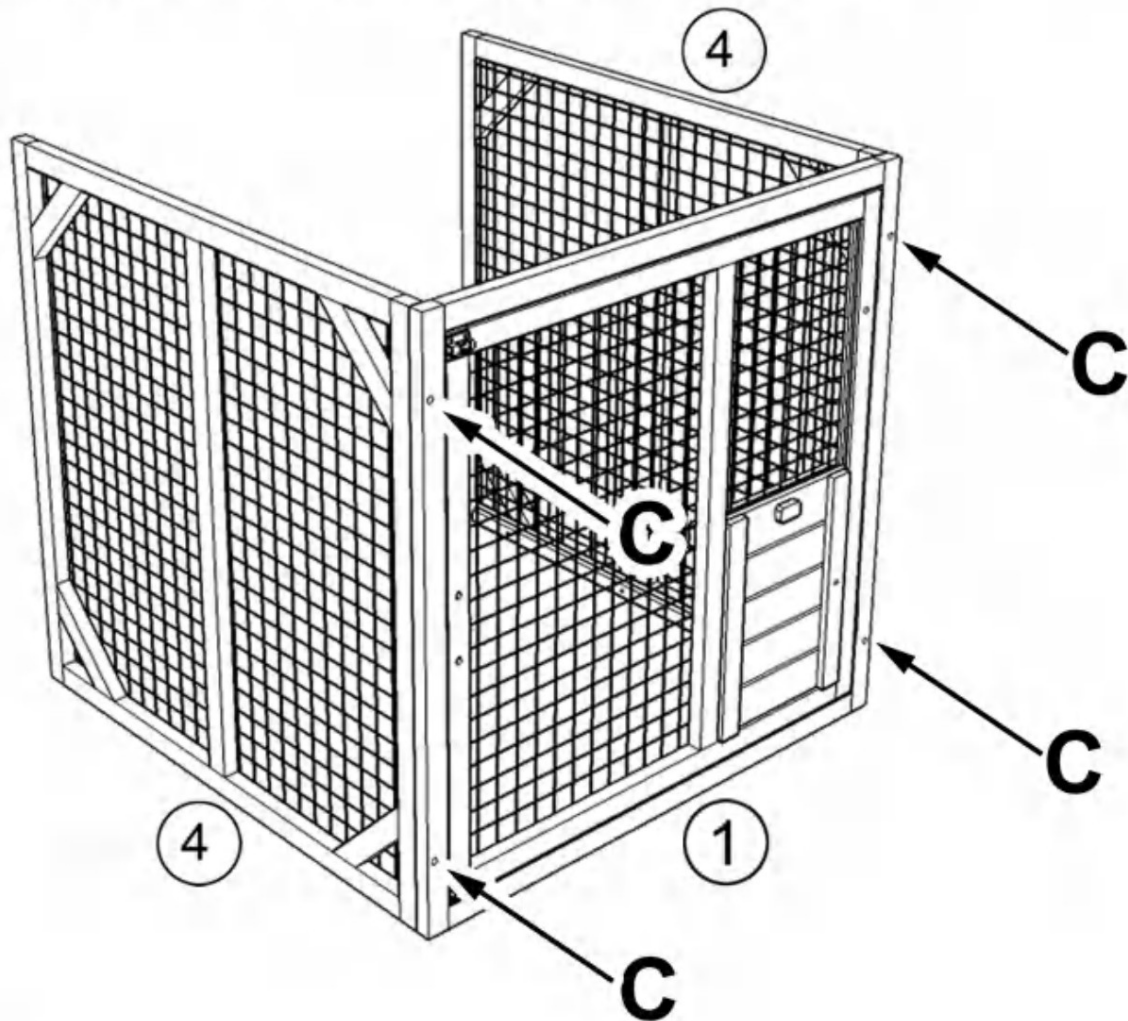

STEP:1

The part #2 (open the door) and part #5 has pre-drilled holes at bottom as shown, assemble part #2 and part #5 with screws (C)x2, then place them on the parts finished in last step and secure them with screws (A)x4 downwards

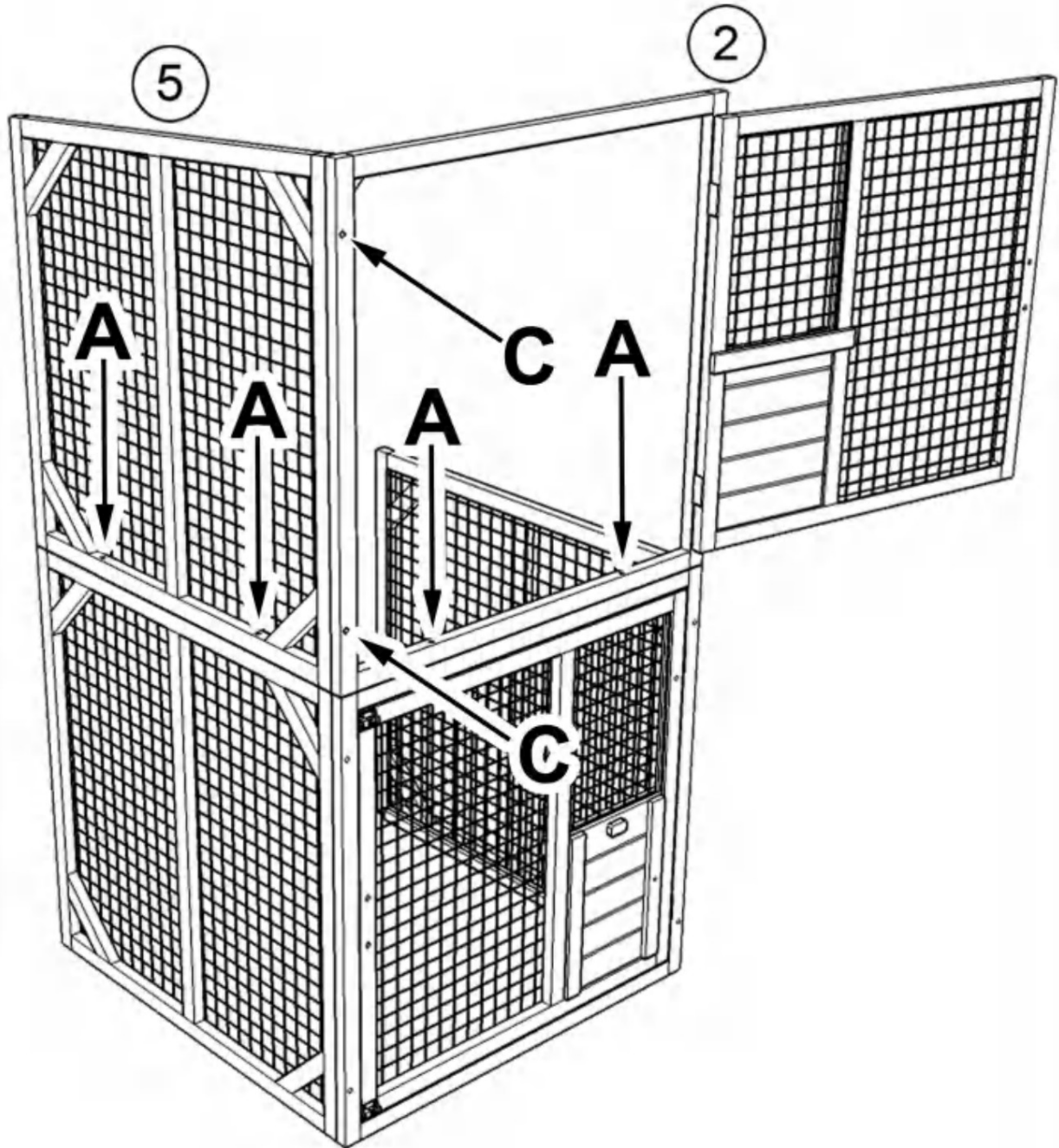

STEP:2

The part #6 has 2 pre-drilled holes at bottom, assembling part #6 with screws (C)x2 as shown and secure it to lower part with screws (A)x2 downwards

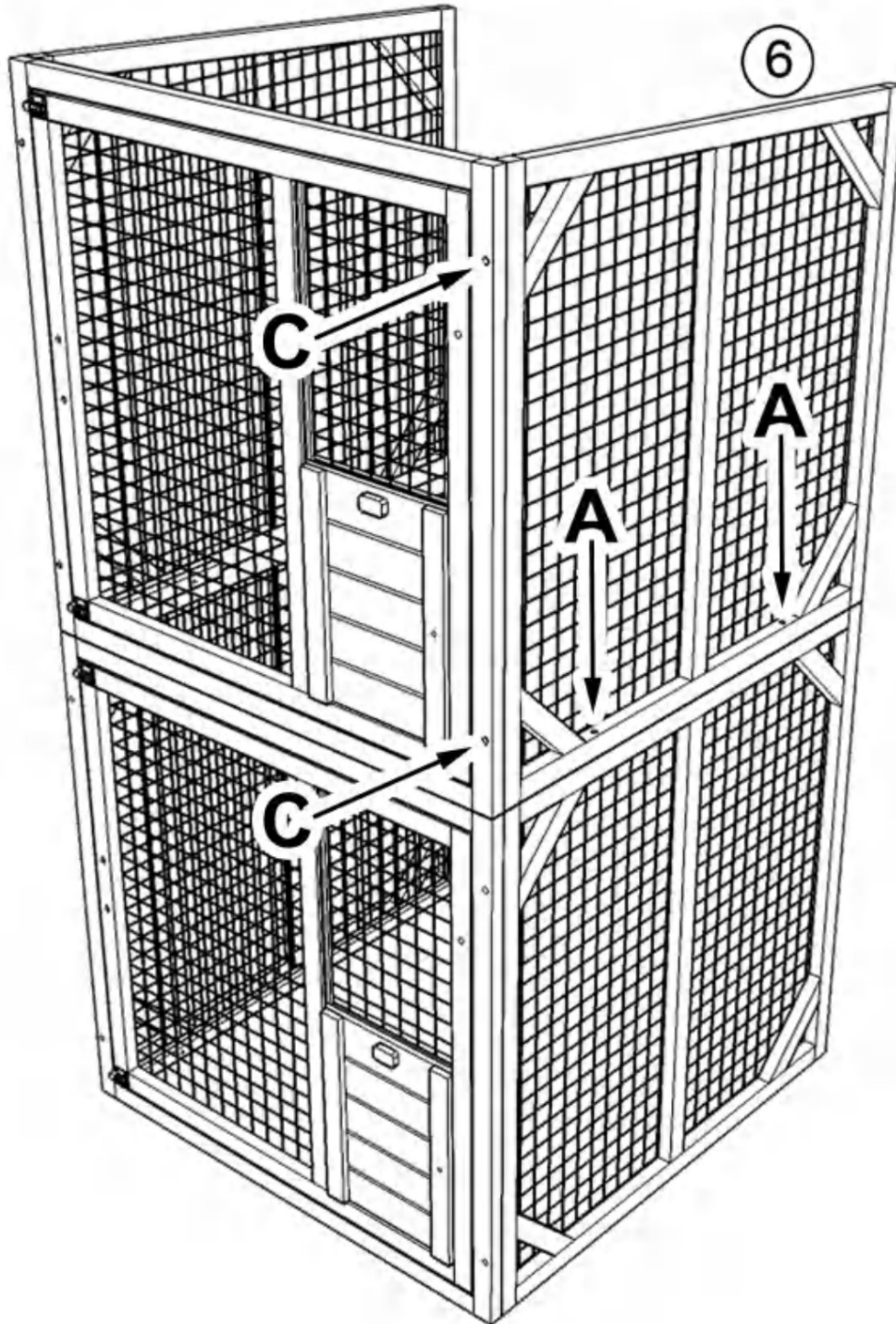

STEP:3

Assembling shelf with part #12 and part #11x2 by screws (E)x4 as shown

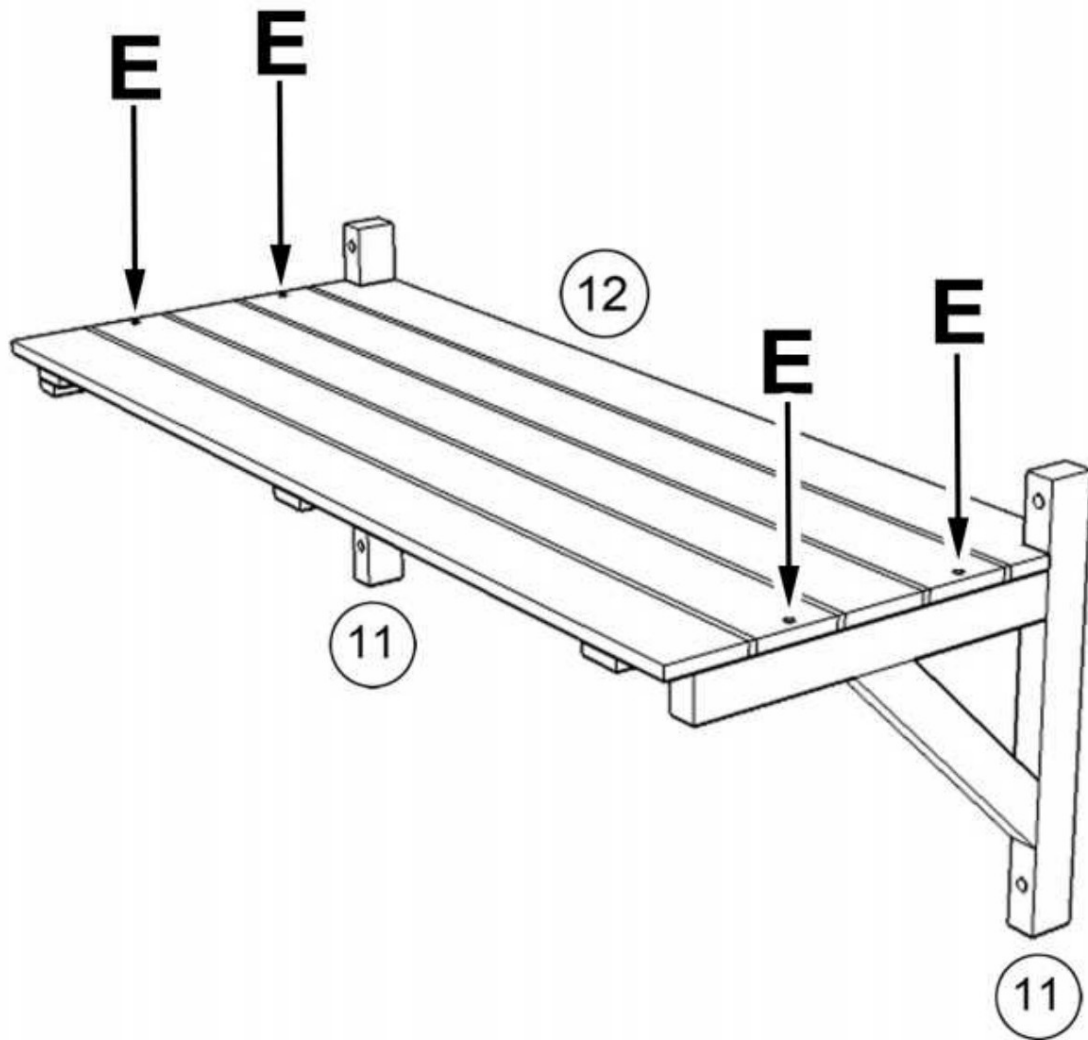

STEP:4

Mounting the shelf on right side as shown by screws (B)x4 at your preferred height

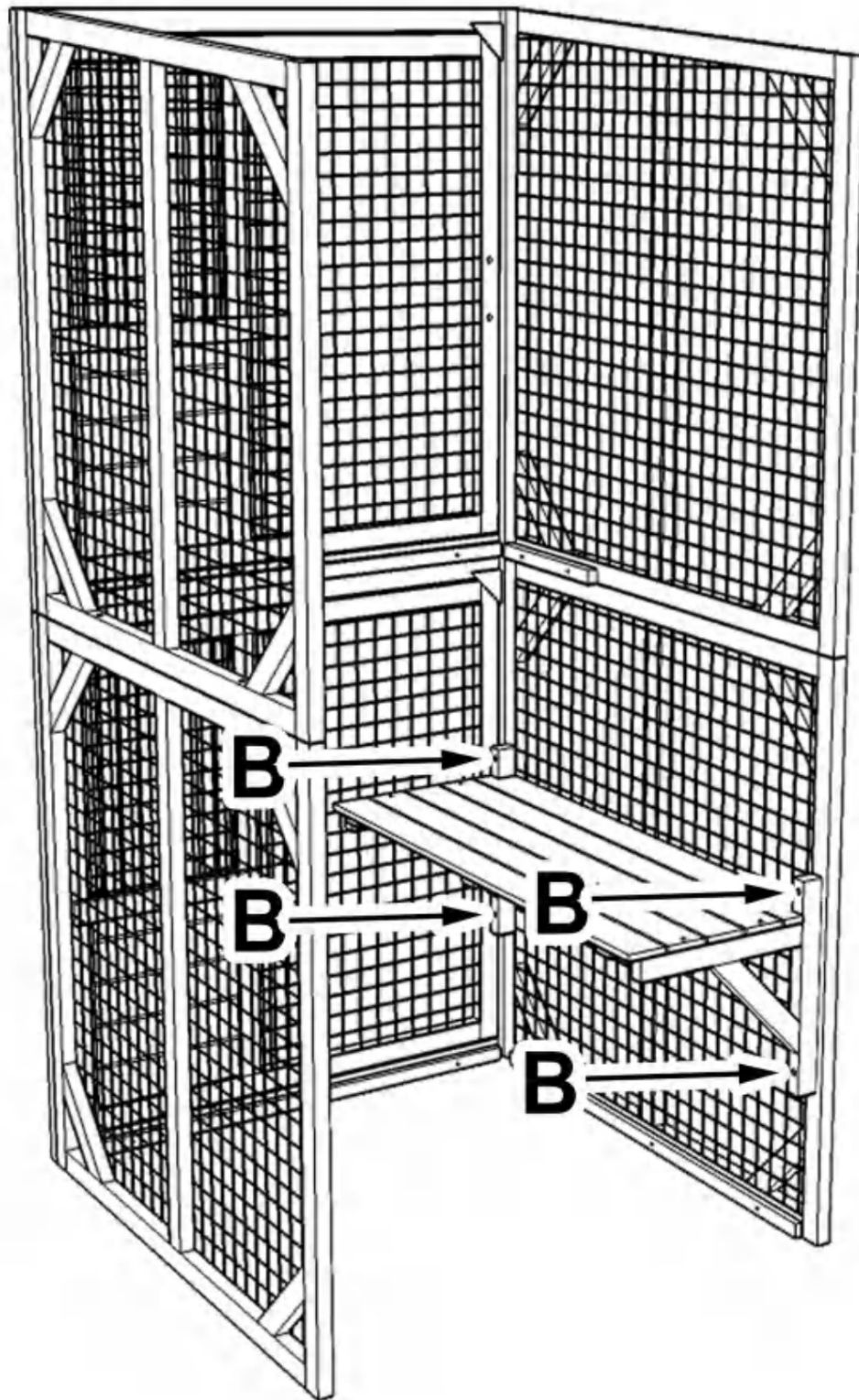

STEP:5

Placing part #14 on the short wood pieces on left and right side and secure it with screw (E)x4

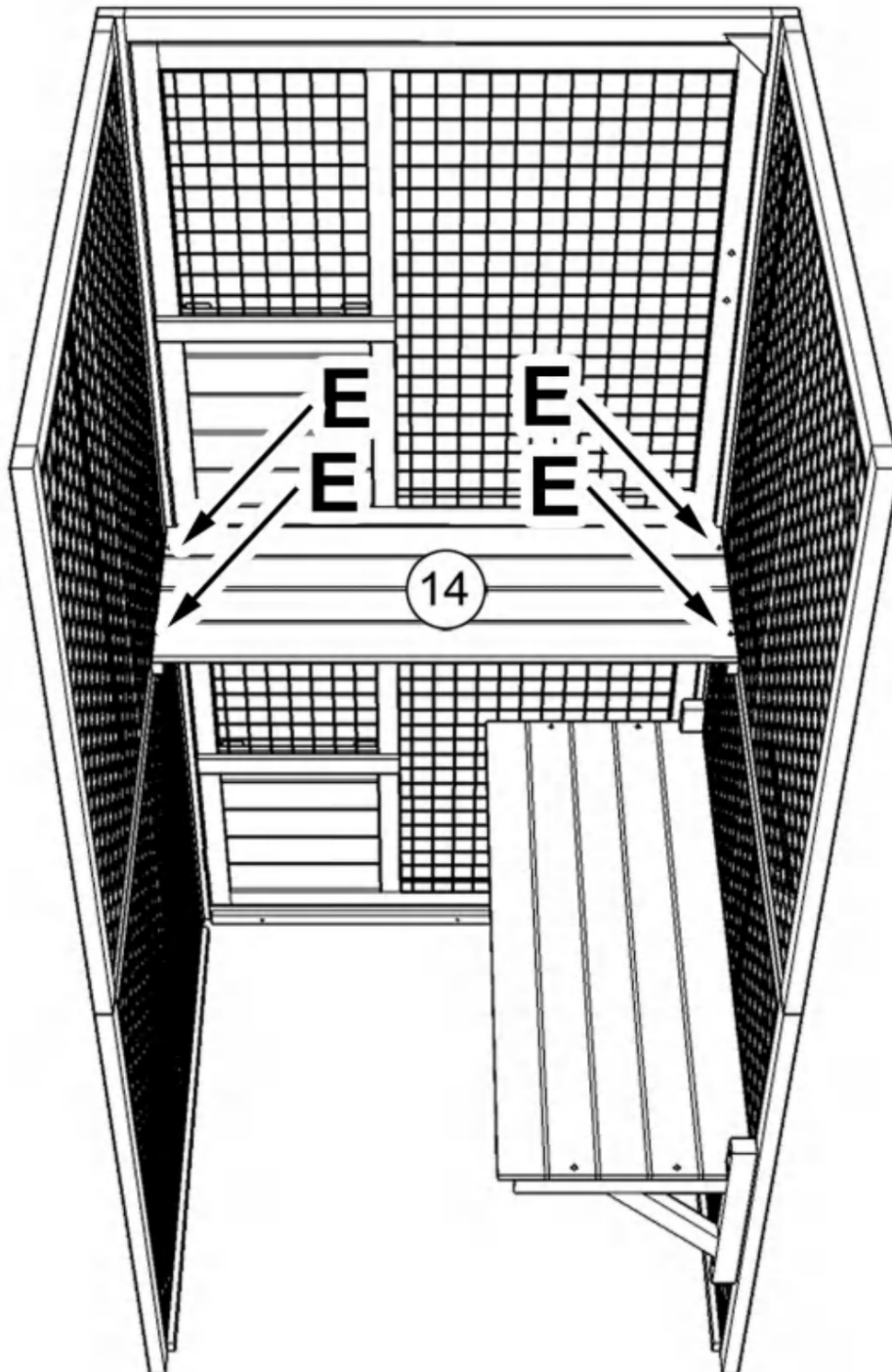

STEP:6

Assembling shelf with part #13 and part #11x2 by screws (E)x4 as shown

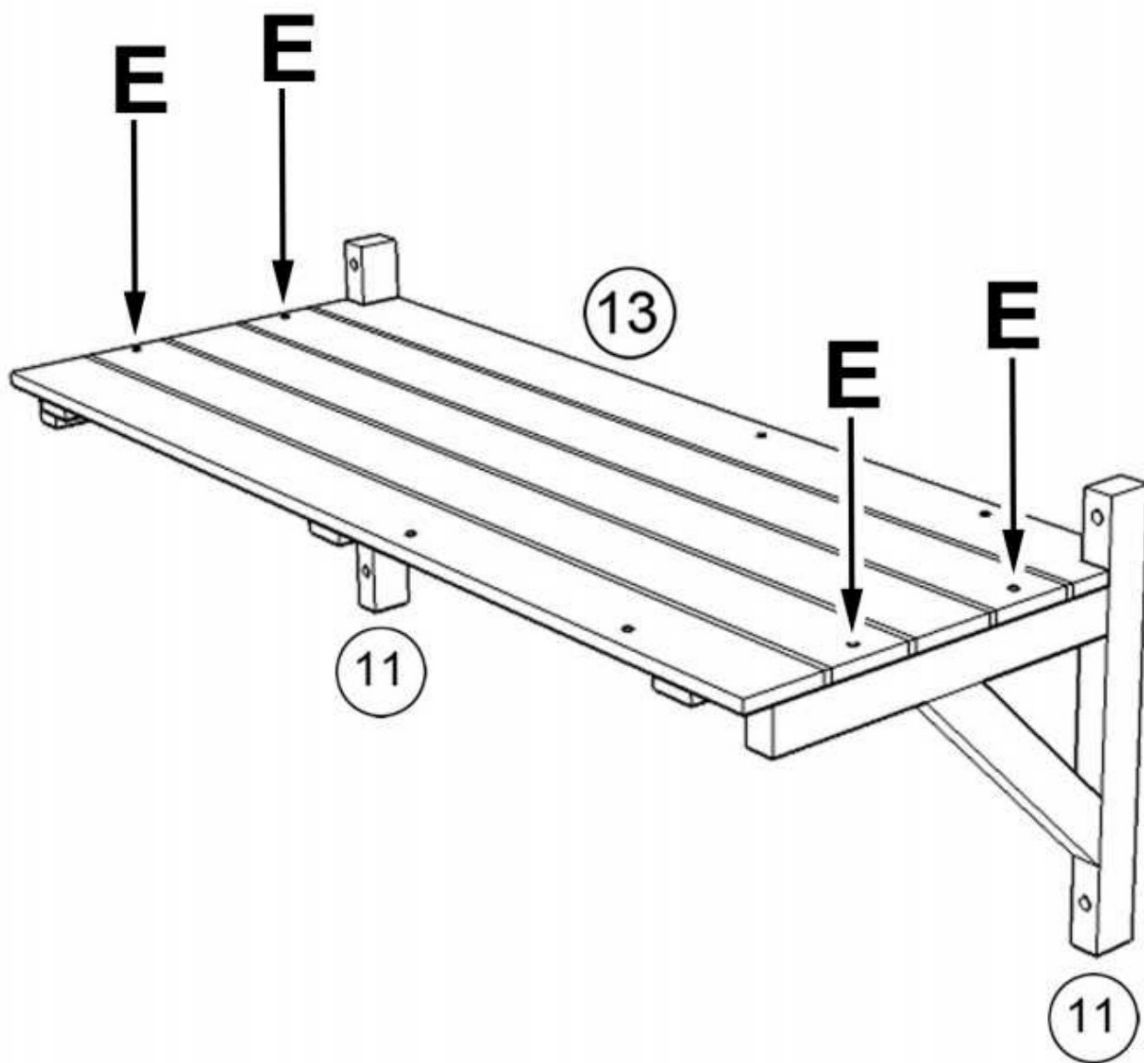

STEP:7

Mounting the shelf to the right side of board as shown with screws (B)x4 at your preferred height

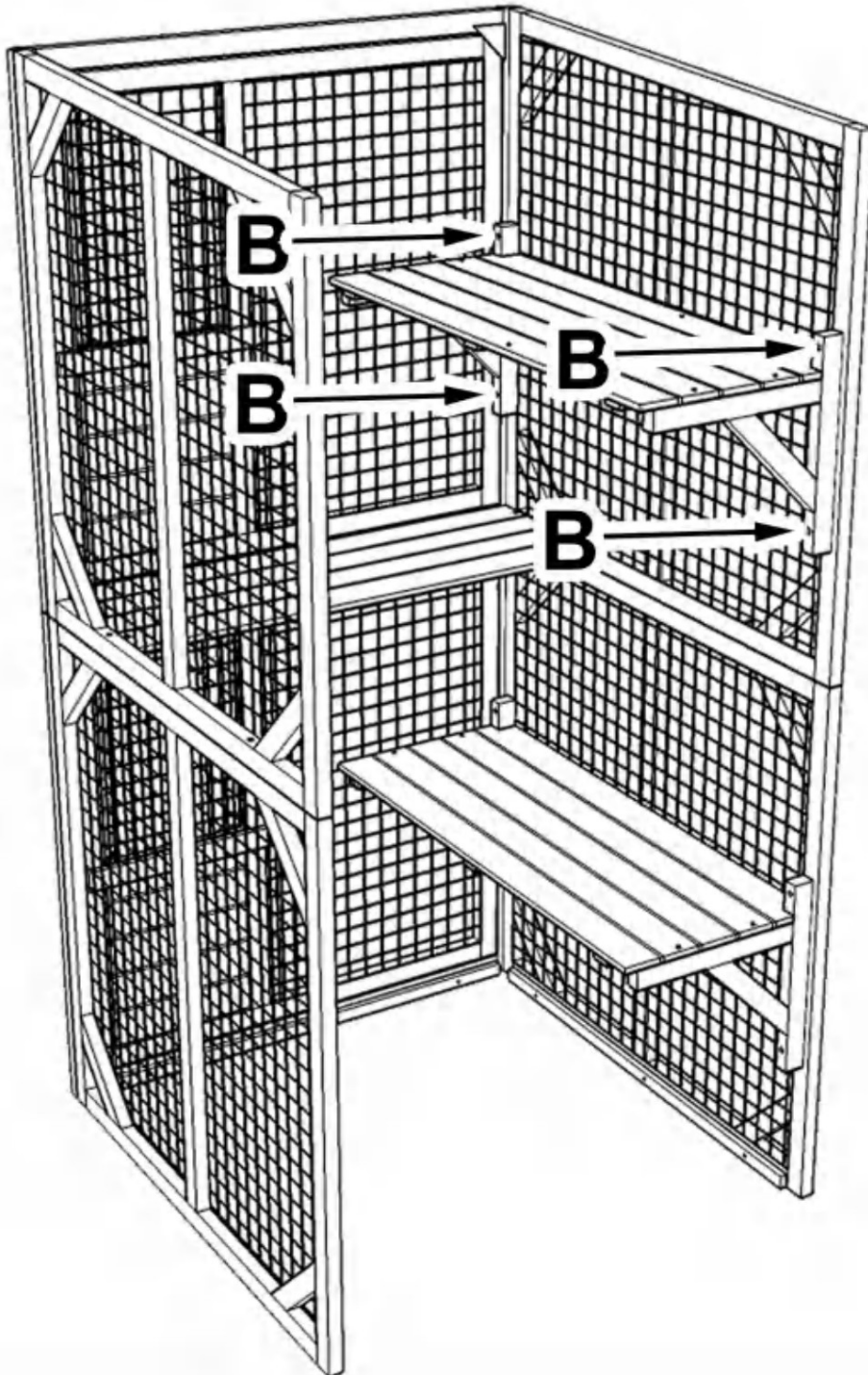

STEP:8

Assembling sleeping box with part #16x2, #17, #15 using screws (E)x10

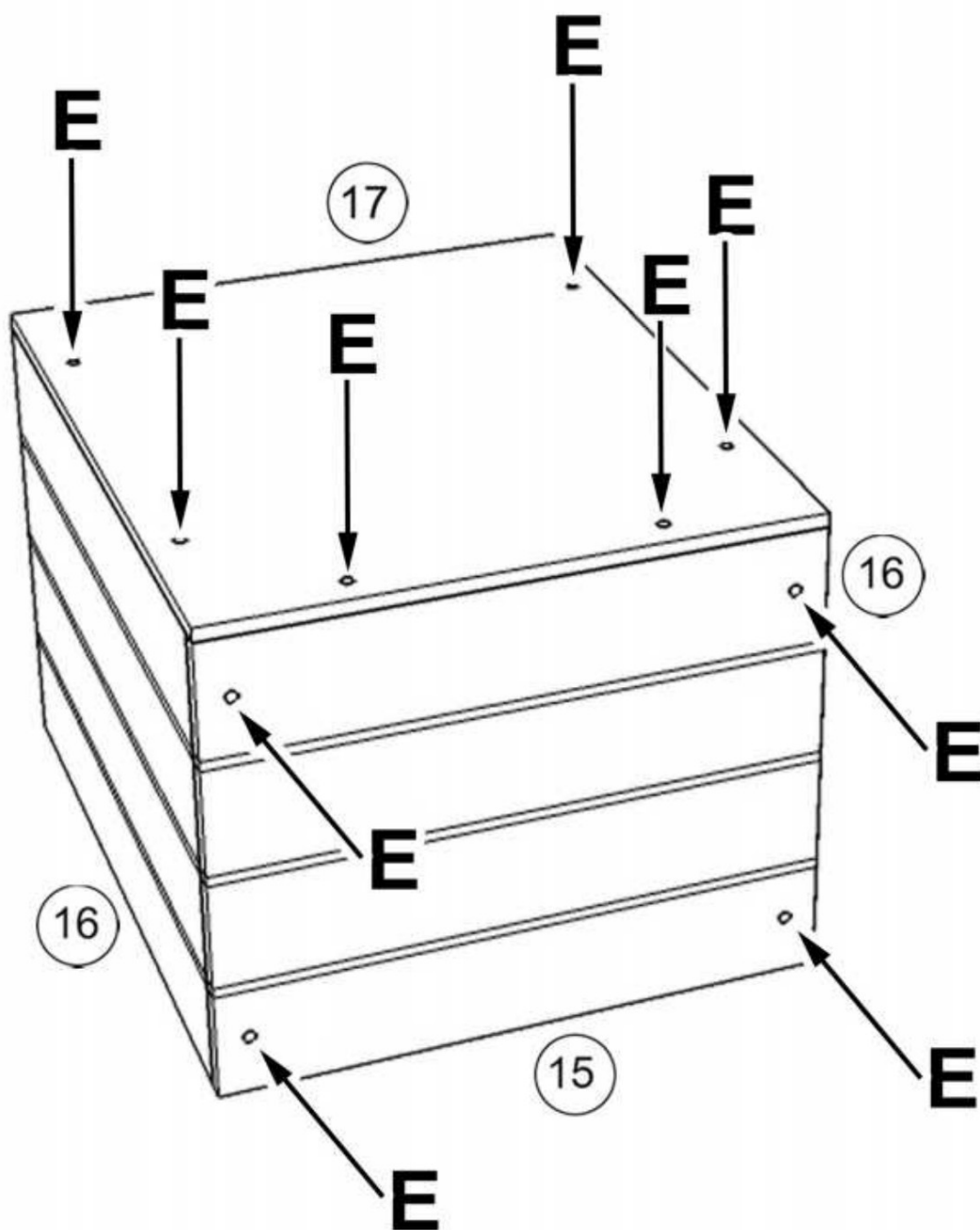

STEP:9

Placing sleeping box on the top of shelf as shown and secure it with screws (E)x4 from the bottom of shelf

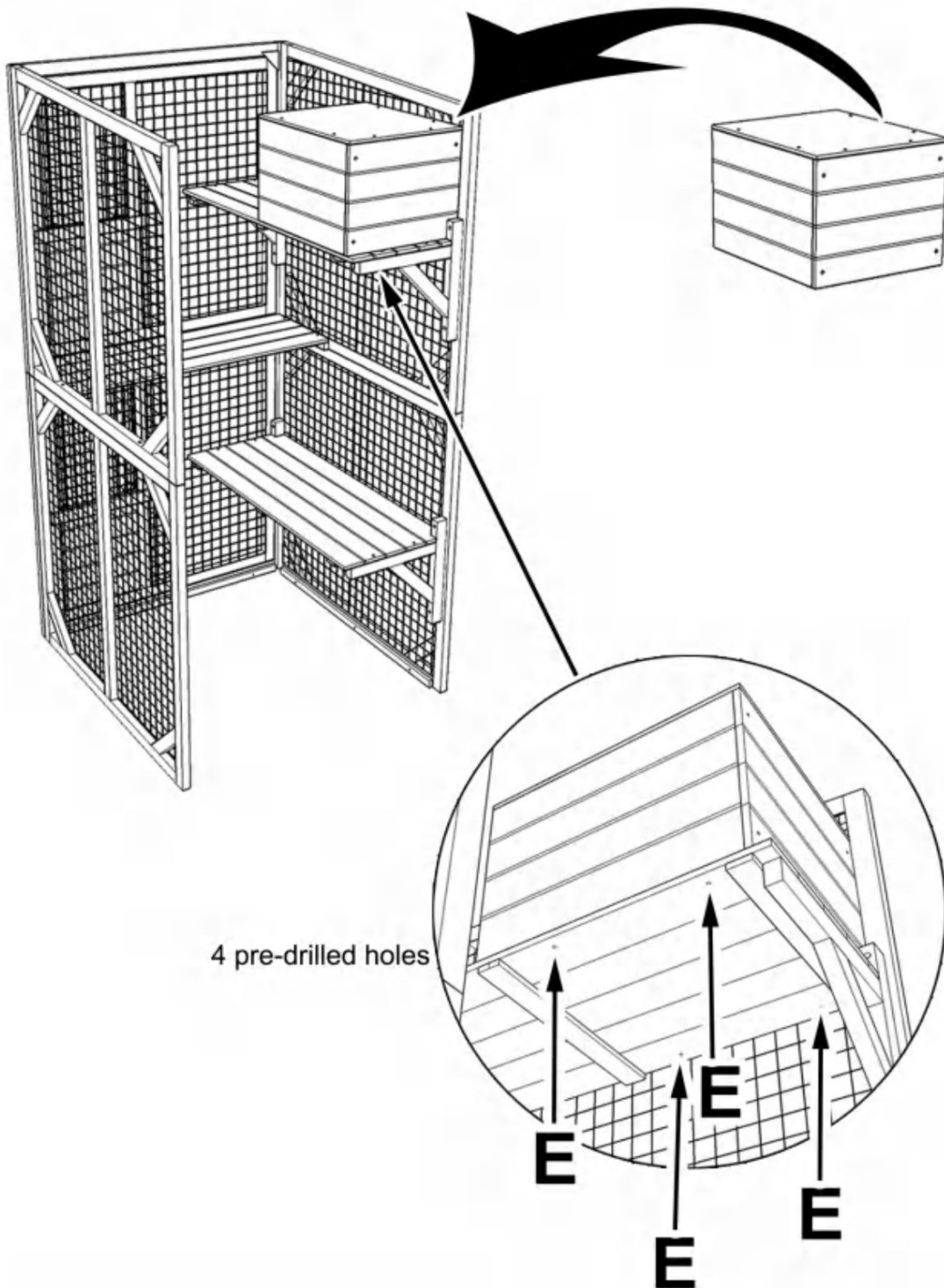

STEP:10

Assembling firstly part #9 (bottom) and then part #8 (2 holes at bottom) with screws (C)x8, then secure the 2 parts by screwing (A)x2 downwards as shown

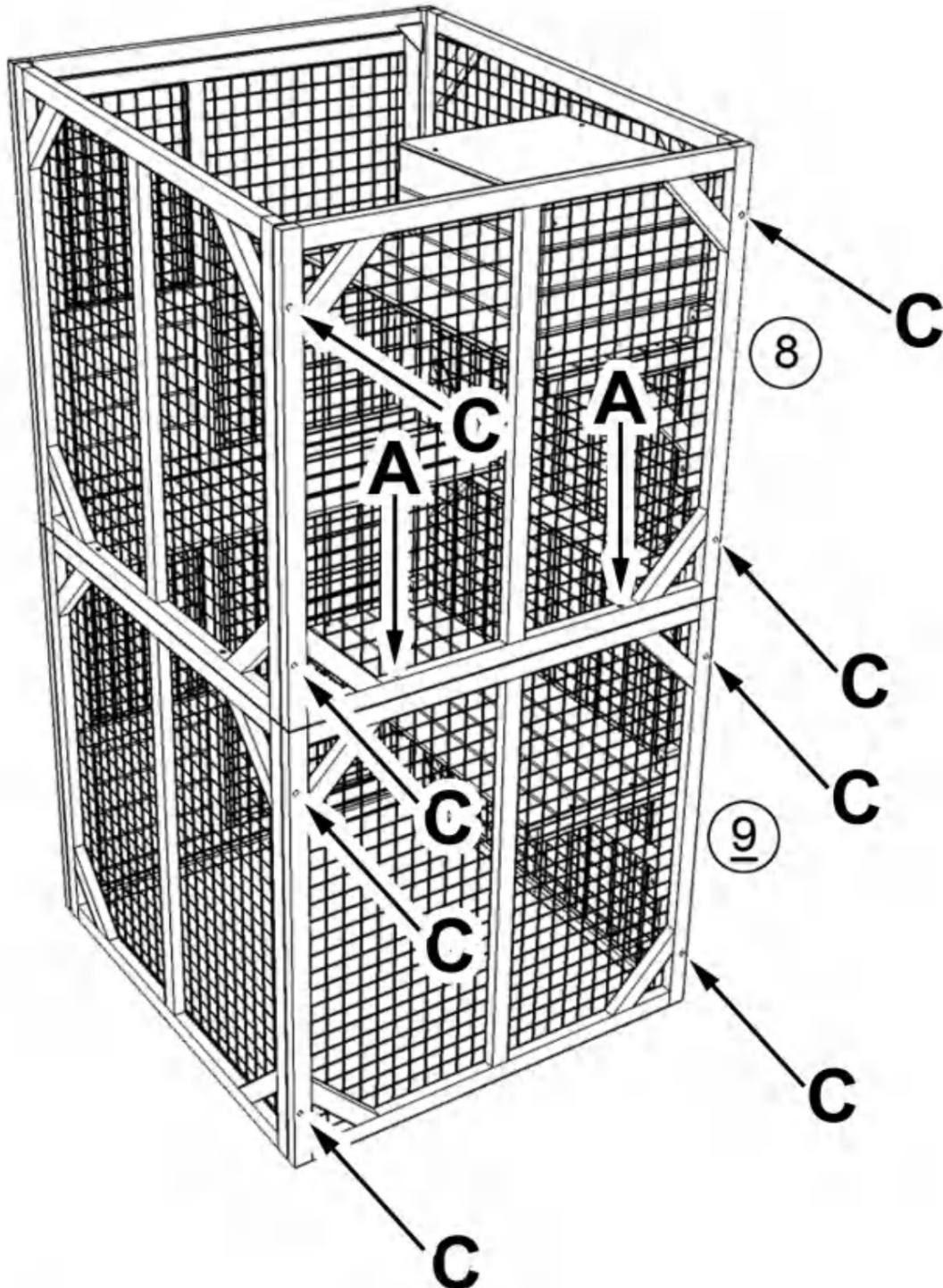

STEP:11

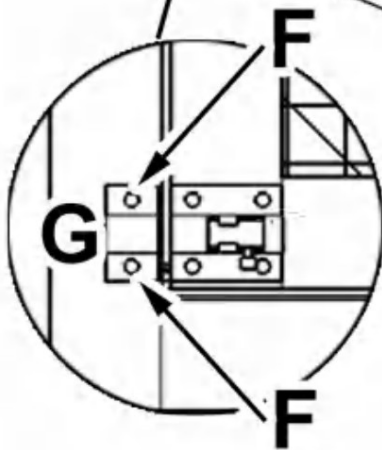
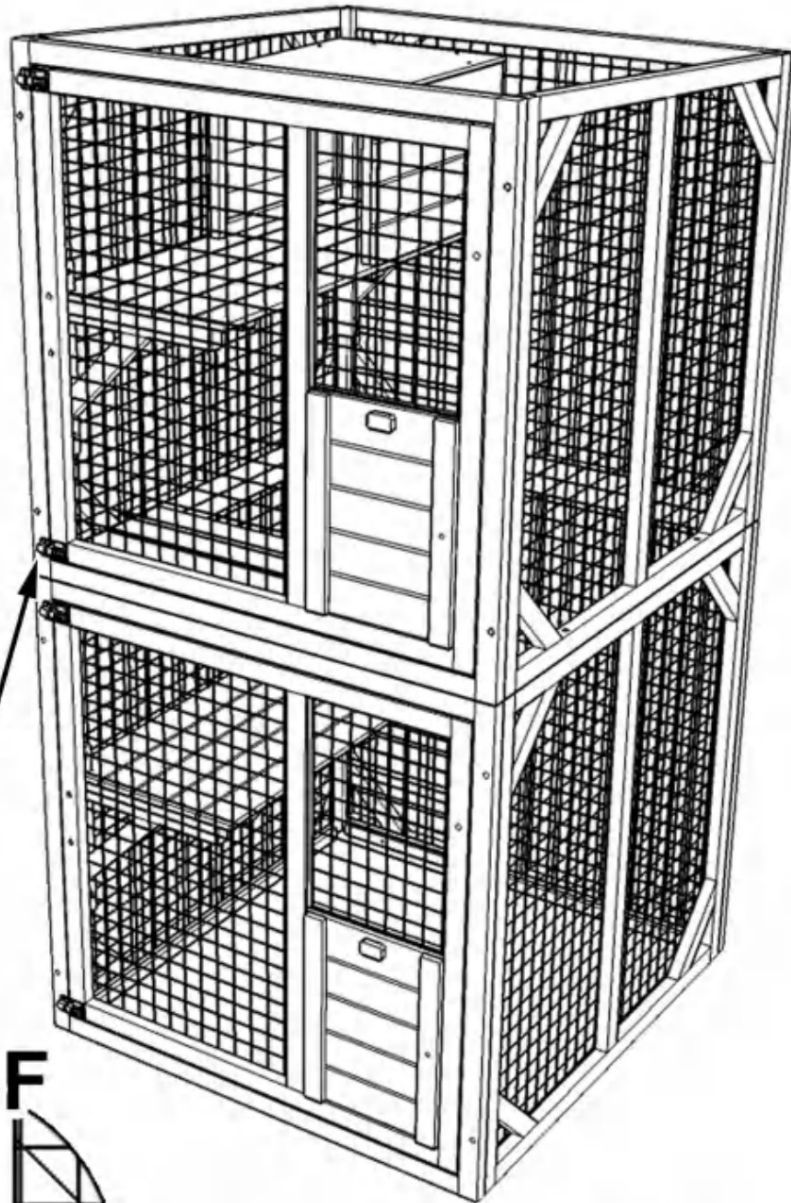

Align the short end of lock part #G with its other part already on door then secure it with screws (F)x2

STEP:12

Install handles parts #19x2 on doors with screws (C)x4 as shown

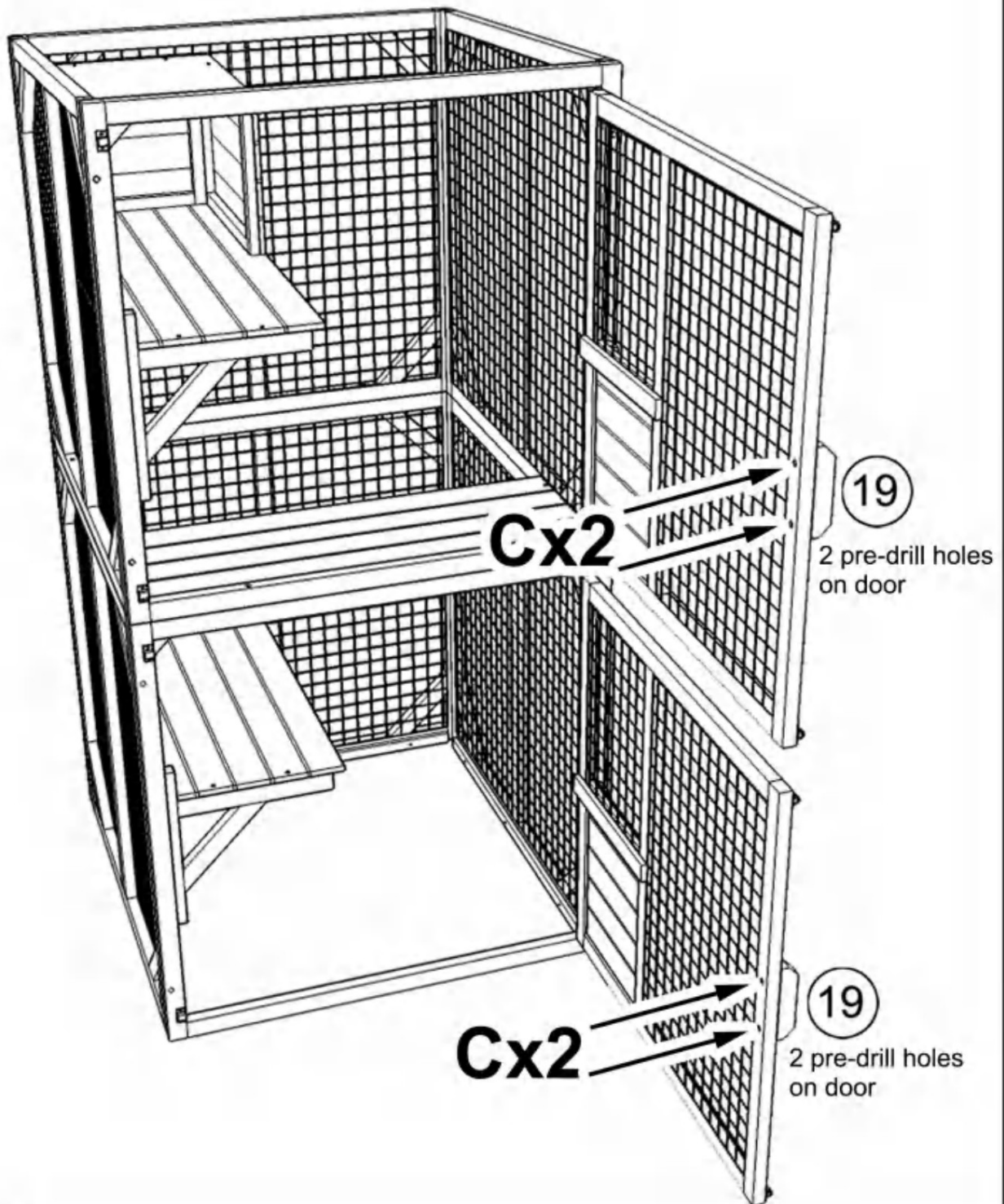

STEP:13

Install hooks as shown, long part is on the sliding door, short part is on the frame wood

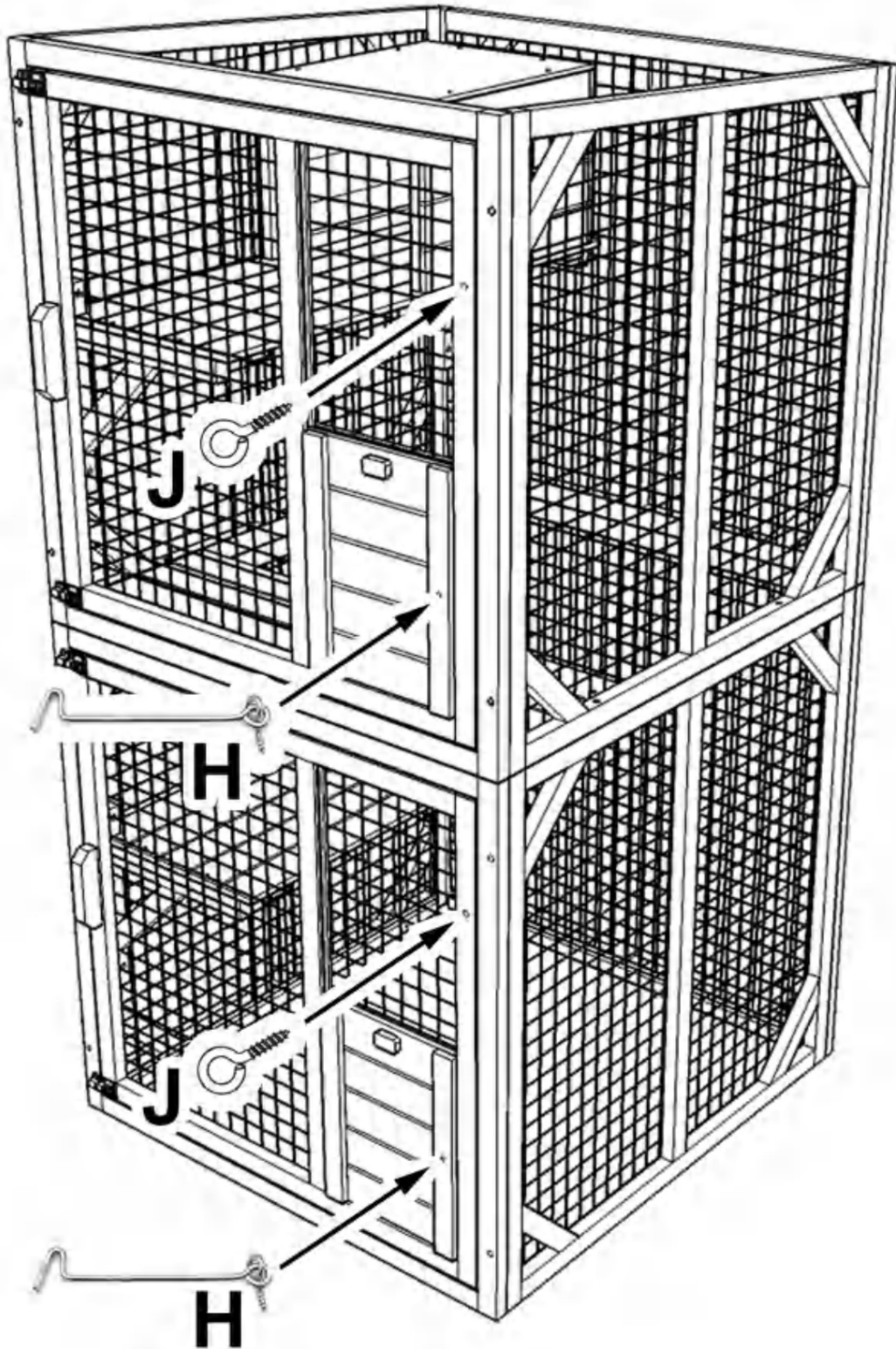

STEP:14

Gently let down the product, install part #7x4 as shown by screws (C)x12

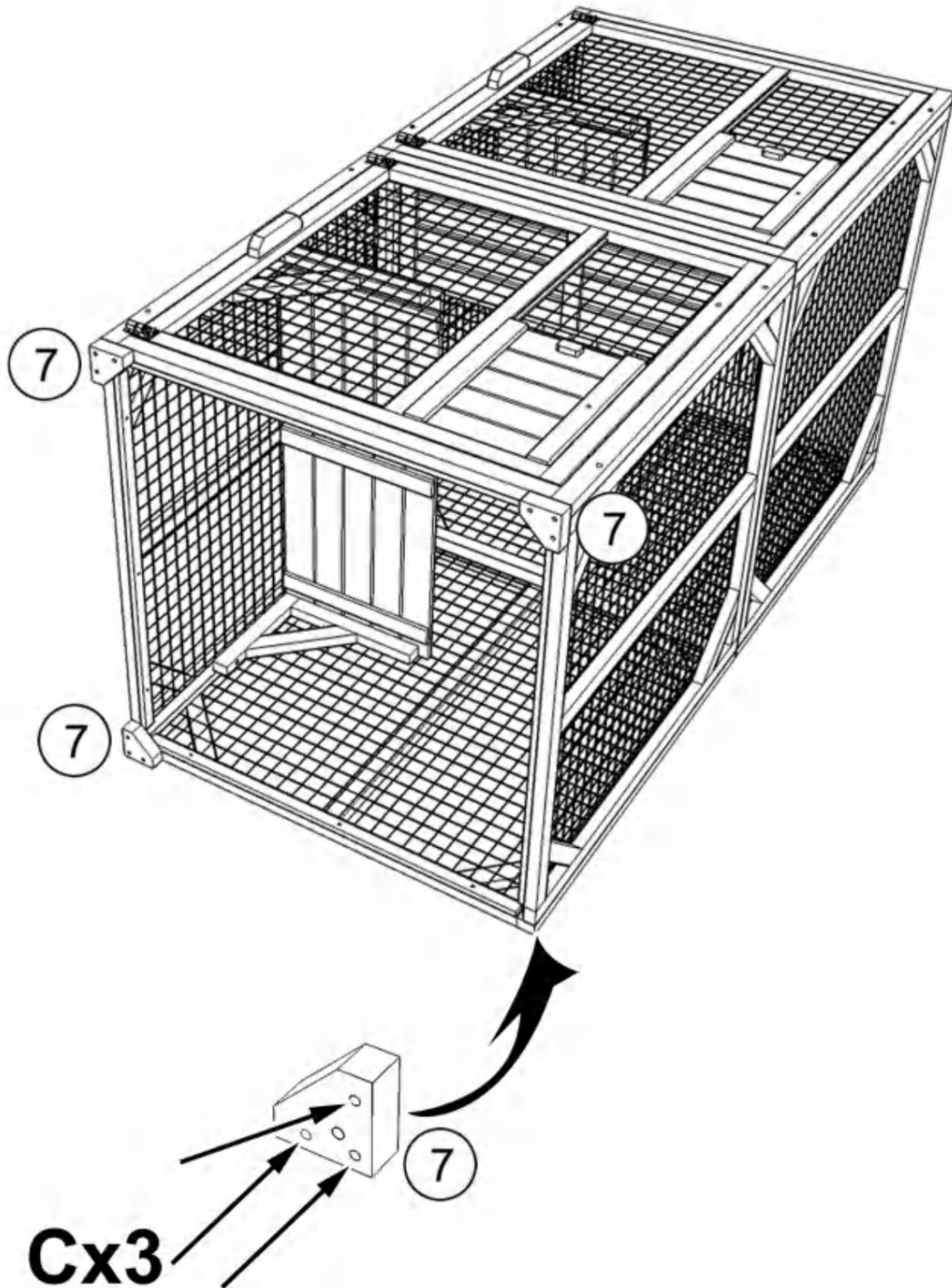

STEP:15

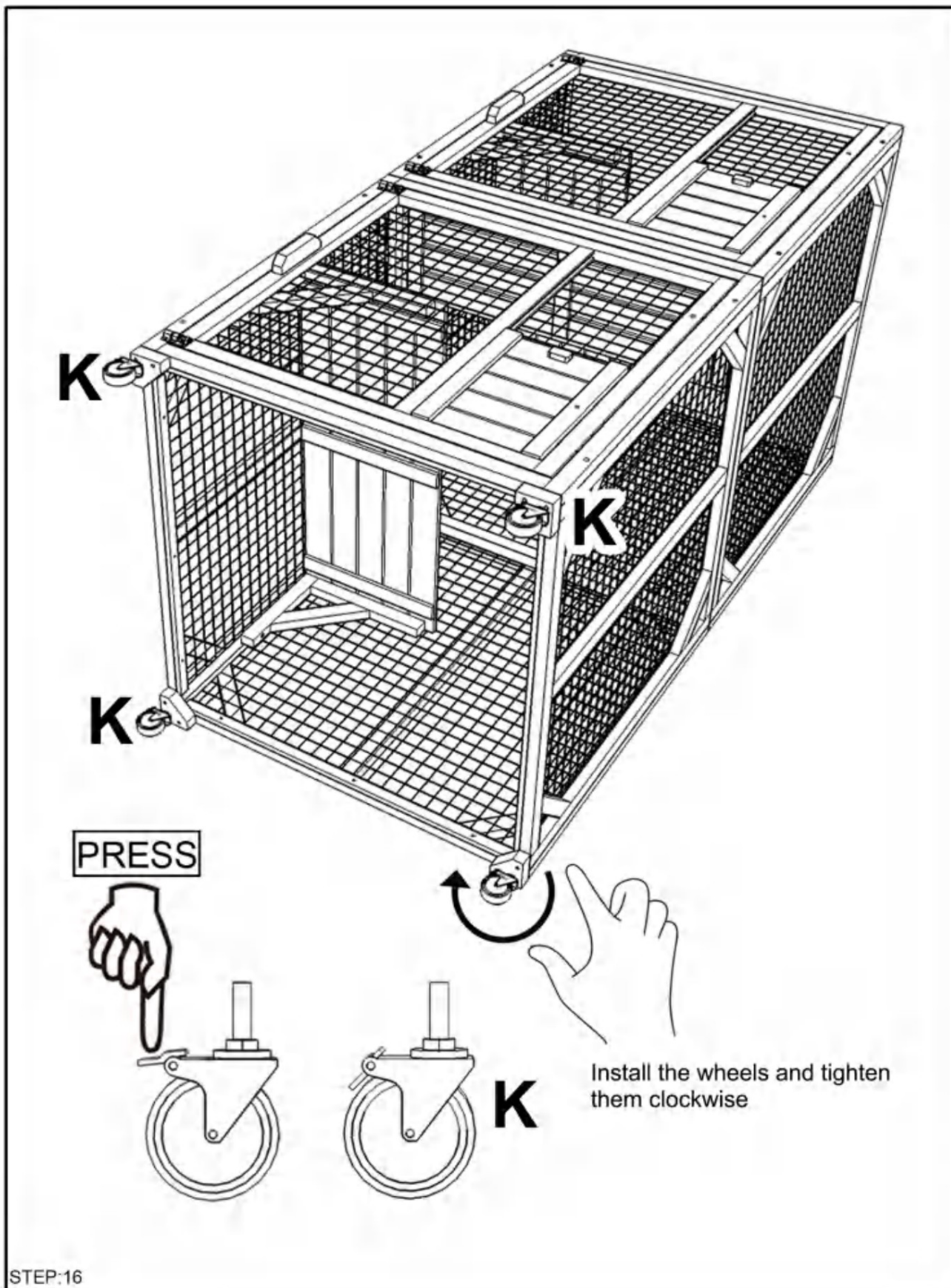

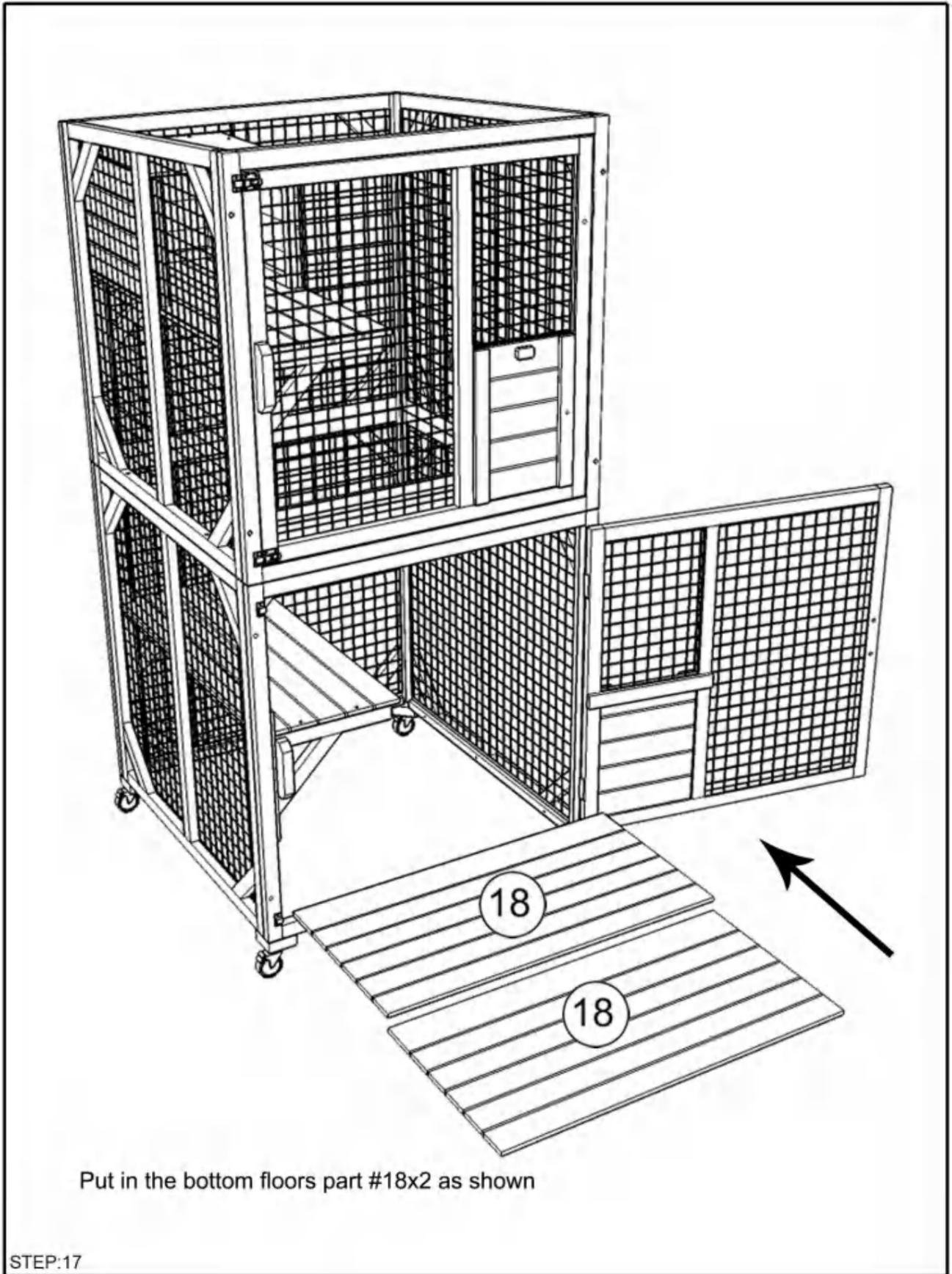

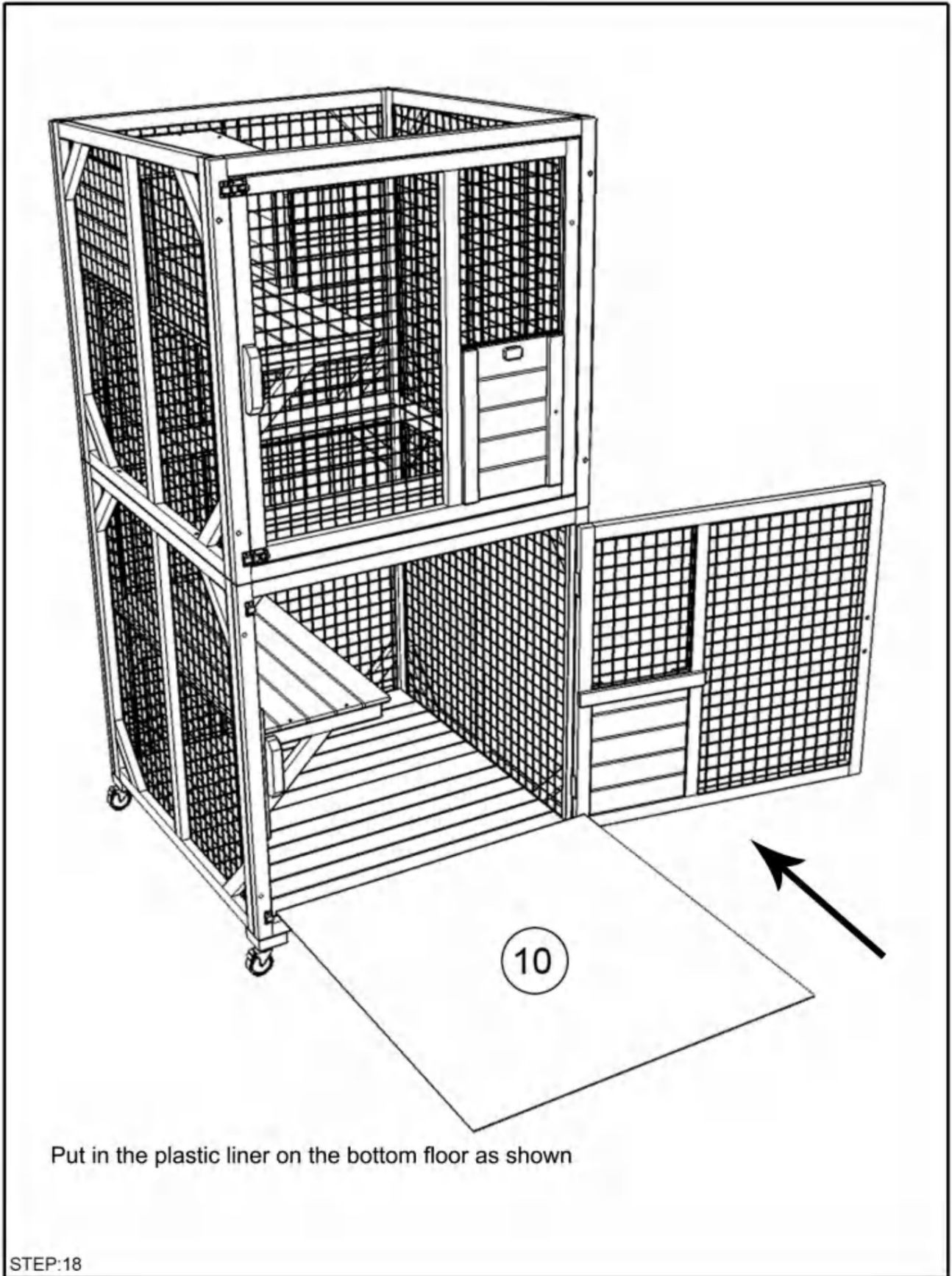

Install the felted roof part #3 with screws (D)x8

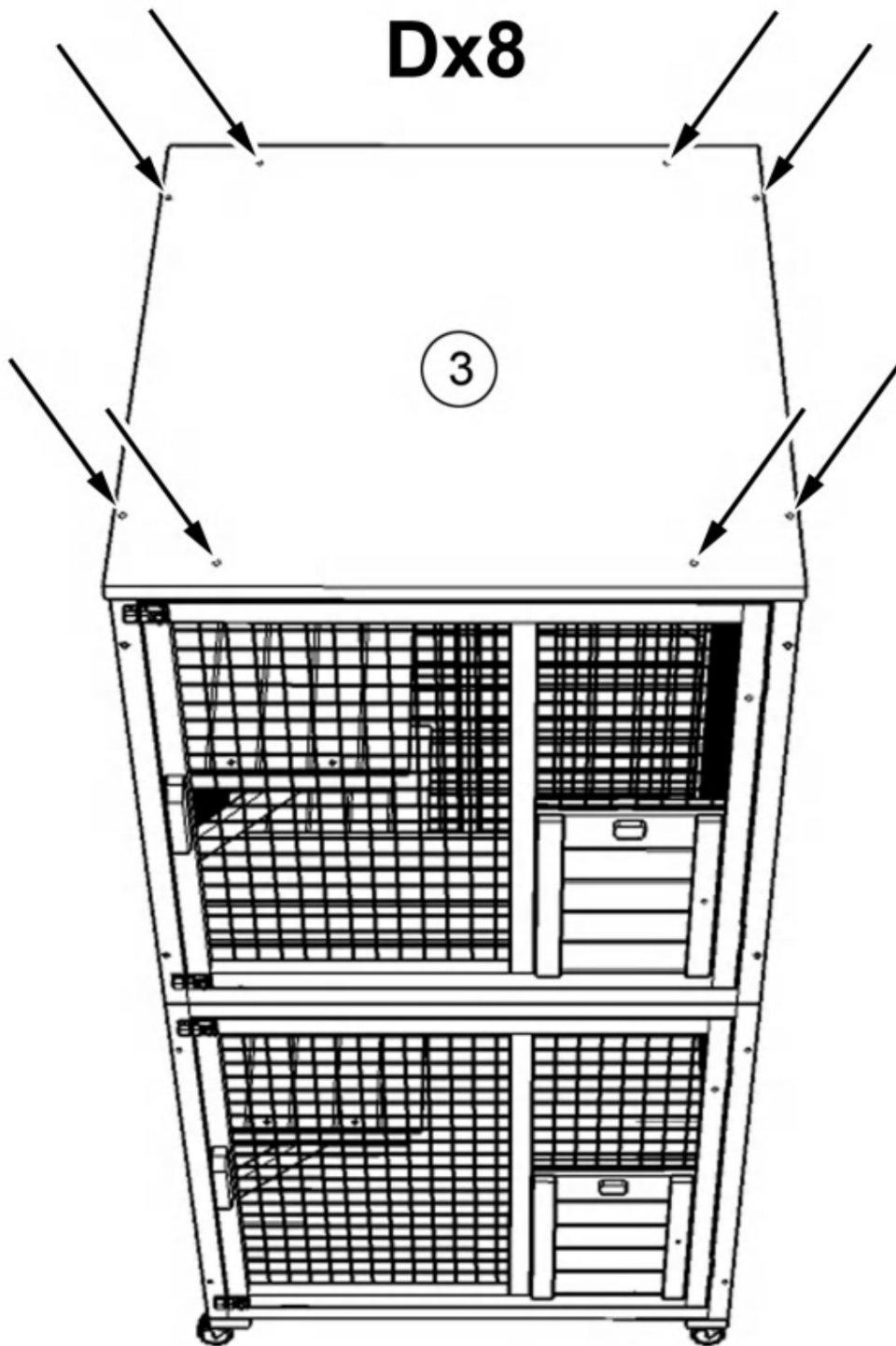

STEP:19

Shuangchenglu 803nong11hao1602A-1609shi, baoshanqu,
shanghai 200000 CN.



E-CrossStu GmbH.
Mainzer Landstr.69, 60329
Frankfurt am Main.



YH CONSULTING LIMITED.
C/O YH Consulting Limited Office
147, Centurion House, London Road,
Staines-upon-Thames, Surrey, TW18 4AX

Importerad till USA: Sanven Technology Ltd., Suite 250, 9166
Anaheim Place, Rancho Cucamonga, CA 91730

VEVOR[®]

TOUGH TOOLS, HALF PRICE

Technical Support and E-Warranty Certificate

www.vevor.com/support

VEVOR[®]

TOUGH TOOLS, HALF PRICE

Technical Support and E-Warranty Certificate www.vevor.com/support

INSTRUCTION FOR CAT CAGE

MODEL:CH470

Wij streven er voortdurend naar om u gereedschappen tegen concurrerende prijzen te leveren. "Save Half", "Half Price" of andere soortgelijke uitdrukkingen die wij gebruiken, geven alleen een schatting van de besparingen die u kunt behalen door bepaalde gereedschappen bij ons te kopen in vergelijking met de grote topmerken en betekent niet noodzakelijkerwijs dat alle categorieën gereedschappen die wij aanbieden, worden gedekt. Wij herinneren u eraan om zorgvuldig te controleren of u daadwerkelijk de helft bespaart in vergelijking met de grote topmerken wanneer u een bestelling bij ons plaatst.

VEVOR[®]
TOUGH TOOLS, HALF PRICE

CAT CAGE

CH470



NEED HELP? CONTACT US!

Have product questions? Need technical support? Please feel free to contact us:

Technische ondersteuning en e-garantiecertificaat www.vevor.com/support

This is the original instruction, please read all manual instructions carefully before operating. VEVOR reserves a clear interpretation of our user manual. The appearance of the product shall be subject to the product you received. Please forgive us that we won't inform you again if there are any technology or software updates on our product.

WARNING:

Read this material before using this product. Failure to do so can result in serious injury.

Assembly precautions

1. Assemble only according to these instructions. Improper assembly can create hazards.
2. In order to ensure your own safety, please make sure to ANSI-approved safety goggles and heavy-duty work gloves when installing this product.
3. Keep the assembly area clean and well lit.
4. Keep bystanders out of the area during assembly.
5. Do not assemble when tired or when under the influence of alcohol, drugs or medication.
6. Product capabilities apply to properly and completely assembled product only.
7. Assemble on a flat, level, hard and smooth surface capable of safely supporting a fully loaded cat cage.

Use precautions

TO PREVENT SERIOUS INJURY AND DEATH FROM TIPPING:

1. DO NOT SIT OR STAND ON THIS ITEM.
2. This product is not a toy. Do not allow children to play with or near this item. Please keep small spare parts out of children's reach.
3. Use only on a flat, level, hard and smooth surface capable of safely supporting a fully loaded cat cage.
4. Use as intended only.
5. Inspect before every use; do not use if parts are loose or damaged.

SAVE THESE INSTRUCTIONS

SPECIFICATIONS

Model	CH470
Product Size	760×865×1630mm
Color	Gray

COMPONENTS

Notice:

1. Various specifications of screws are used in the installation of this product. Pay attention to the correct use of screw specifications according to the instruction manual.
2. Please wear gloves when installing.

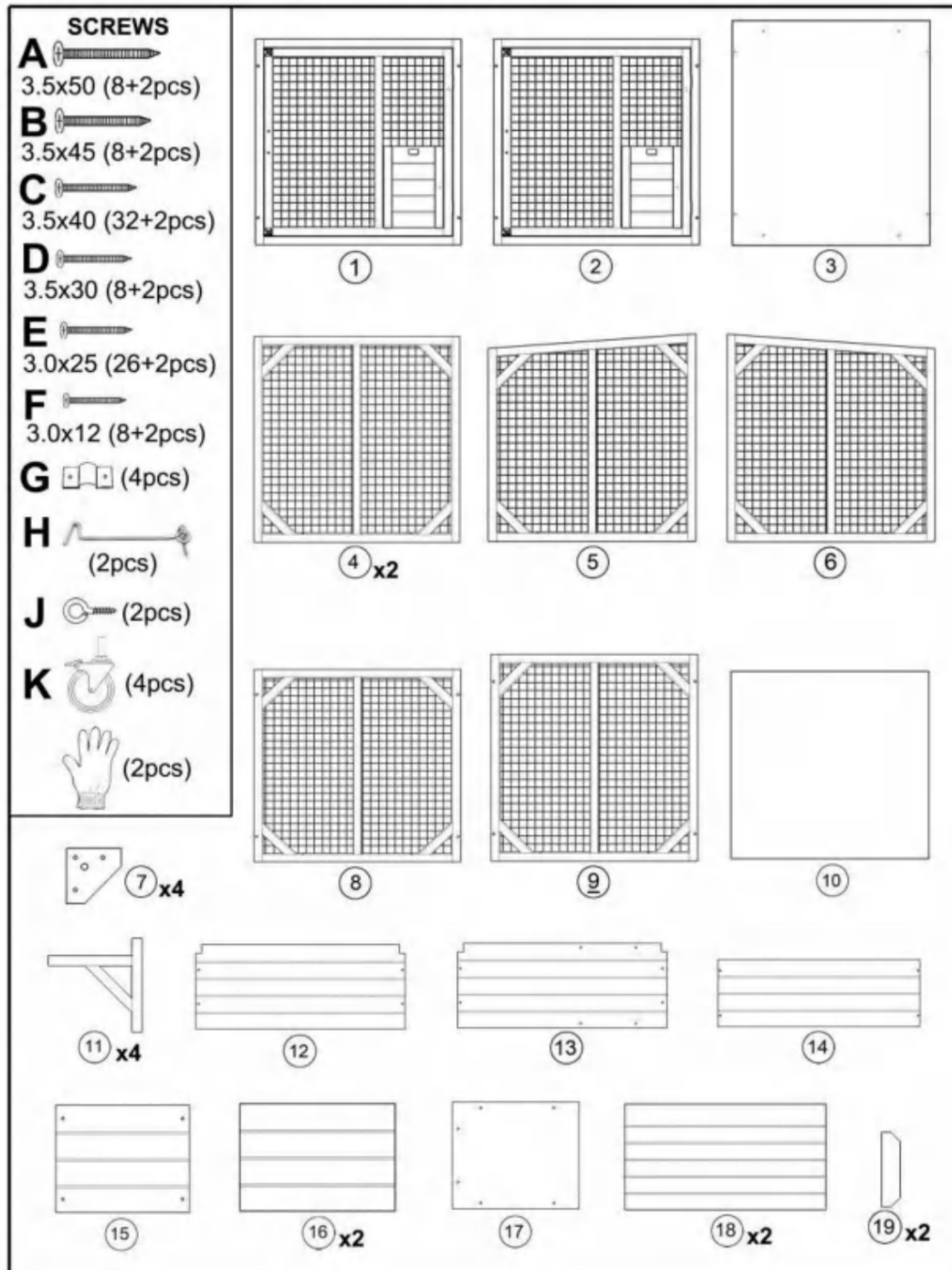

Assembly Instructions

Please be noted that the side with wire nailed on is back side, should be inward when installation

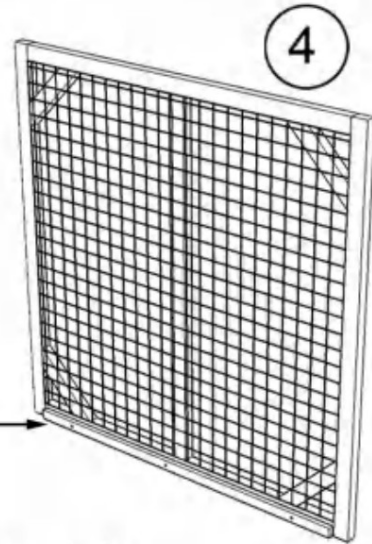

This end with a long piece of wood is placed at bottom

Assembling part #4x2 and part #1 with screws (C)x4 as shown below

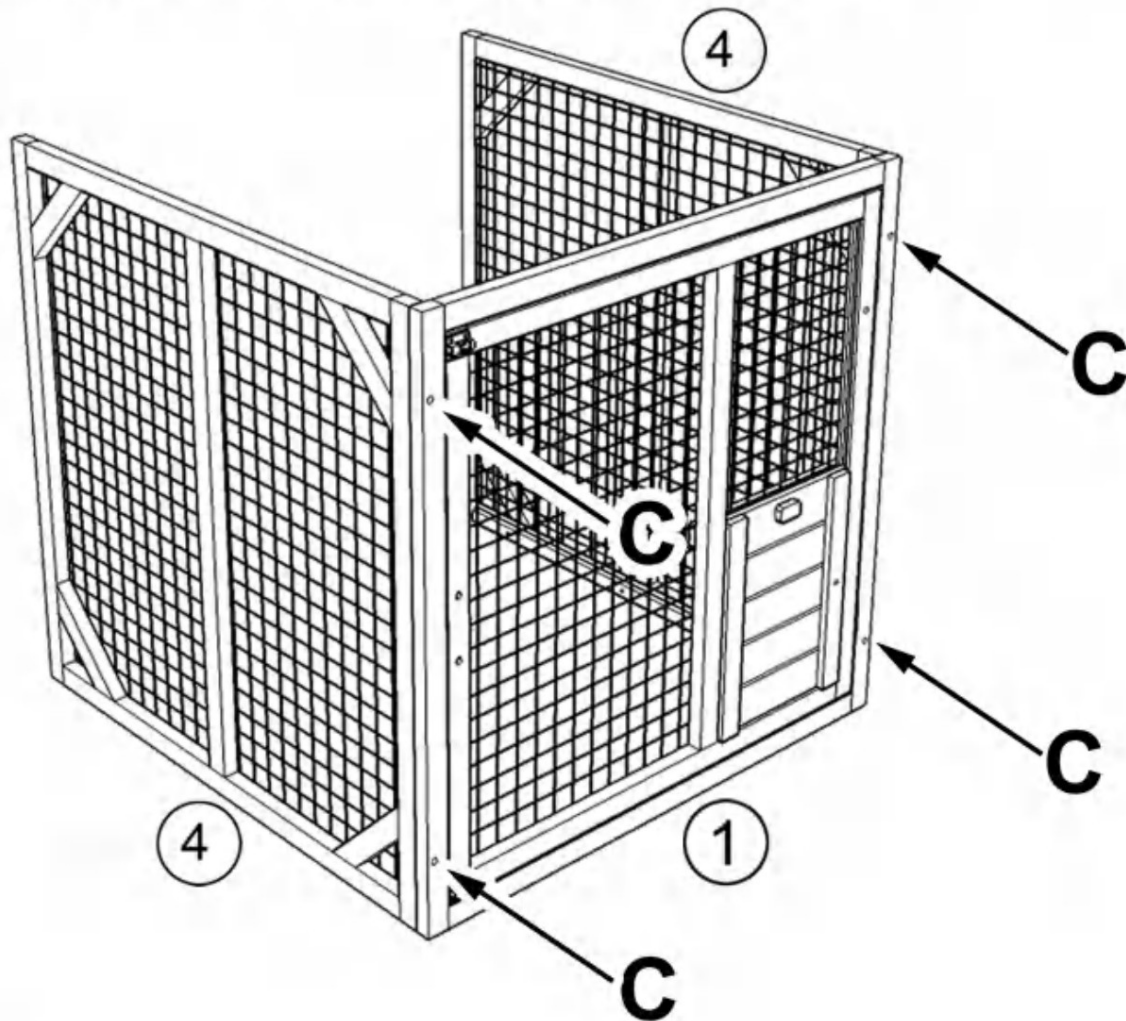

STEP:1

The part #2 (open the door) and part #5 has pre-drilled holes at bottom as shown, assemble part #2 and part #5 with screws (C)x2, then place them on the parts finished in last step and secure them with screws (A)x4 downwards

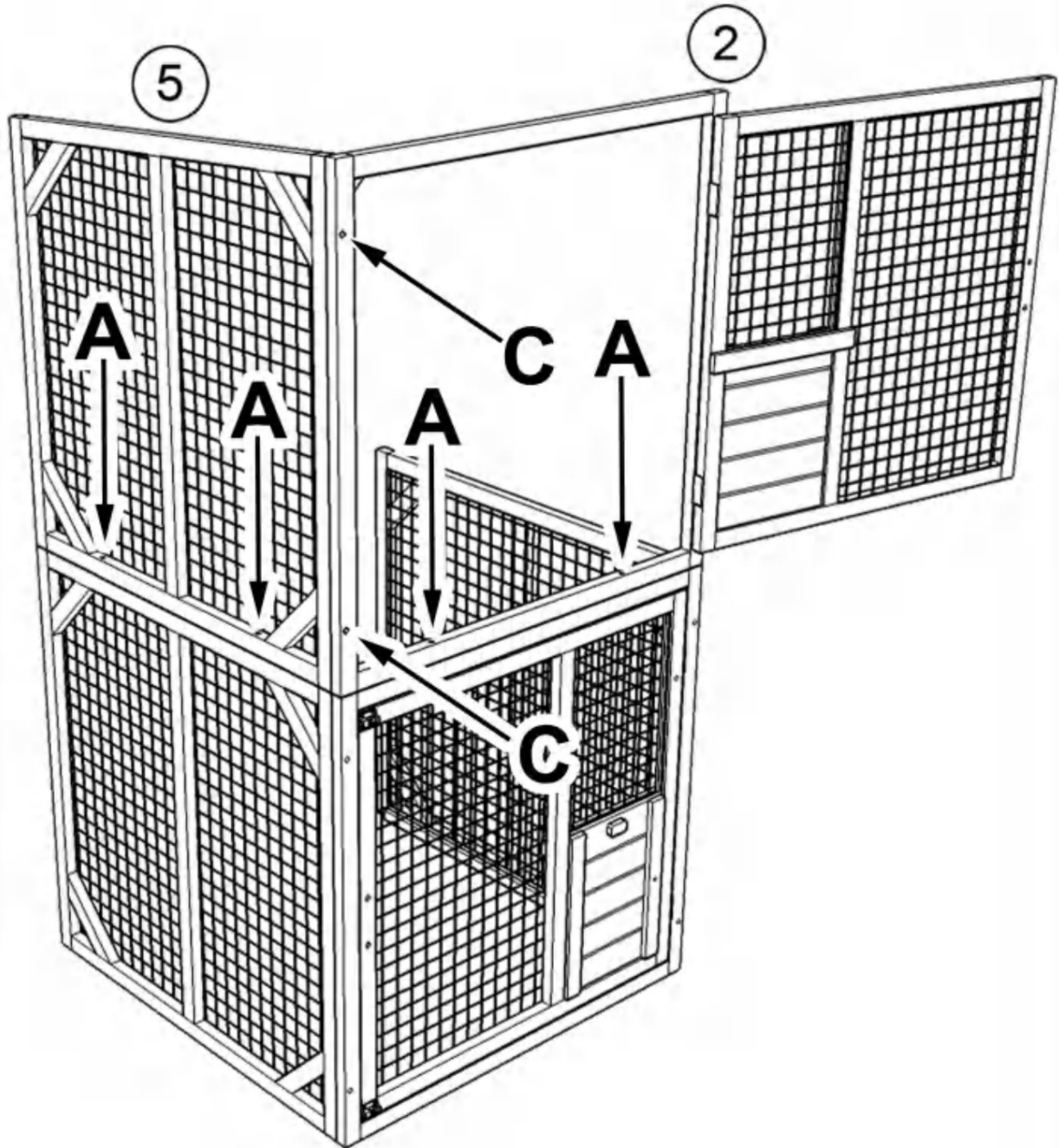

STEP:2

The part #6 has 2 pre-drilled holes at bottom, assembling part #6 with screws (C)x2 as shown and secure it to lower part with screws (A)x2 downwards

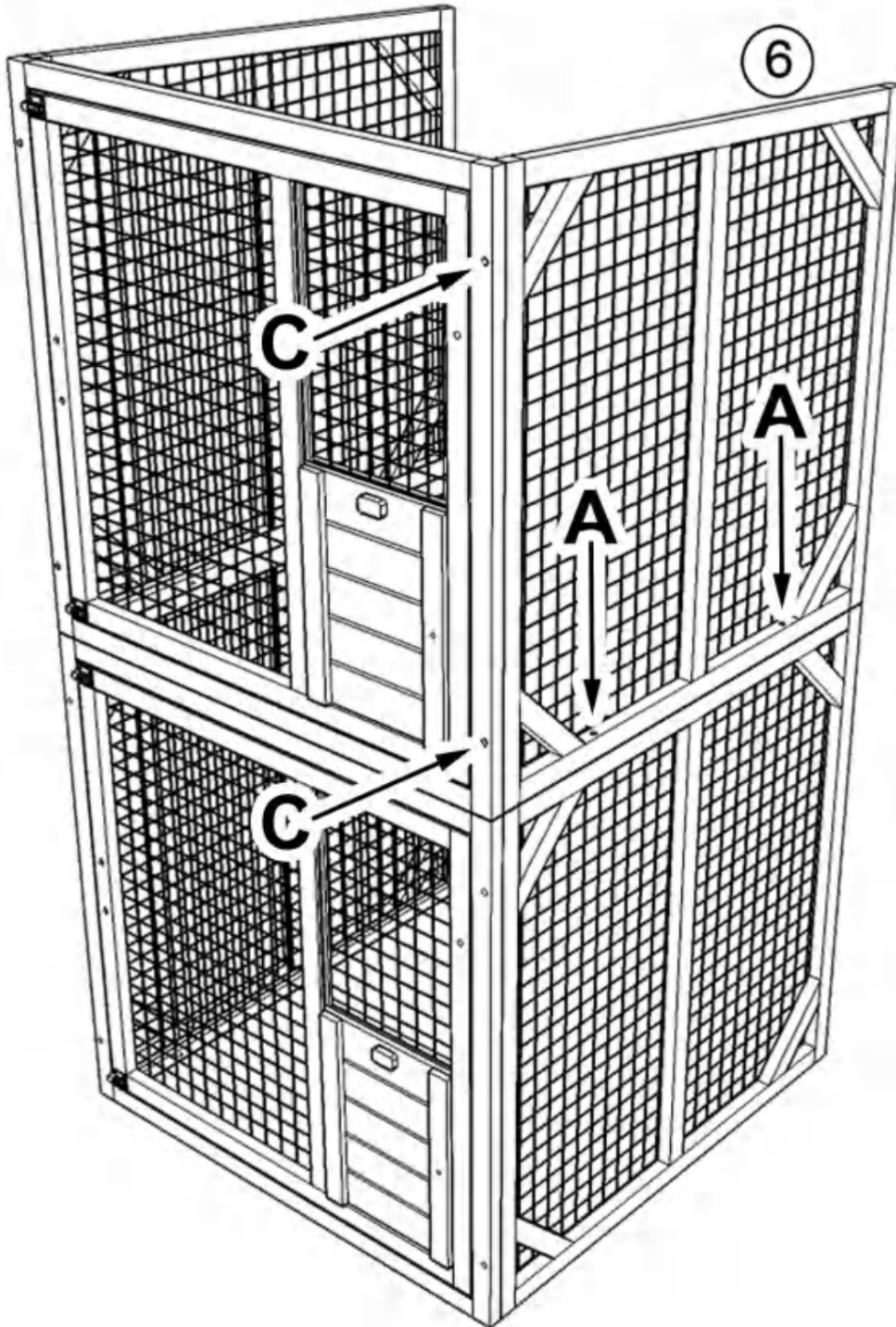

STEP:3

Assembling shelf with part #12 and part #11x2 by screws (E)x4 as shown

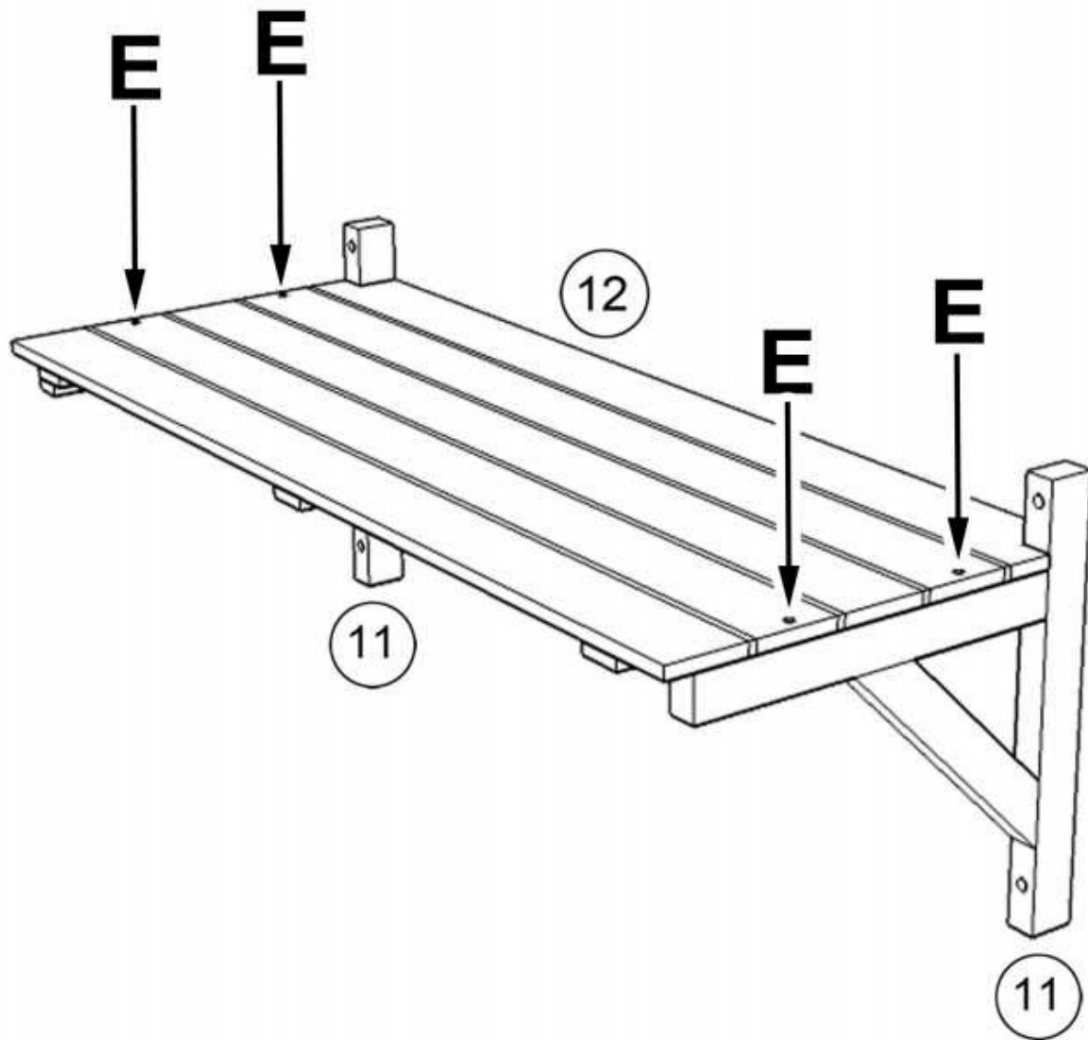

STEP:4

Mounting the shelf on right side as shown by screws (B)x4 at your preferred height

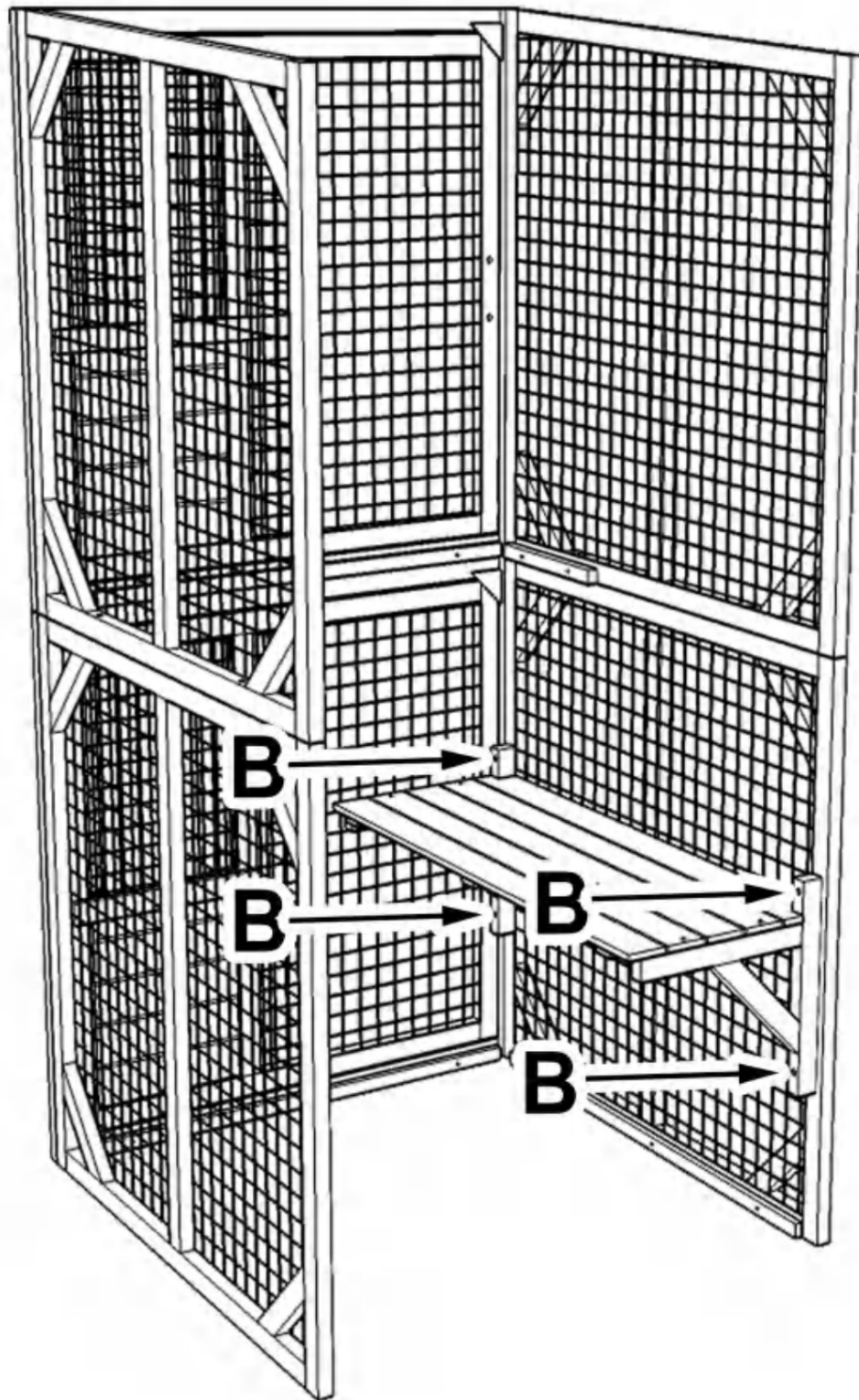

STEP:5

Placing part #14 on the short wood pieces on left and right side and secure it with screw (E)x4

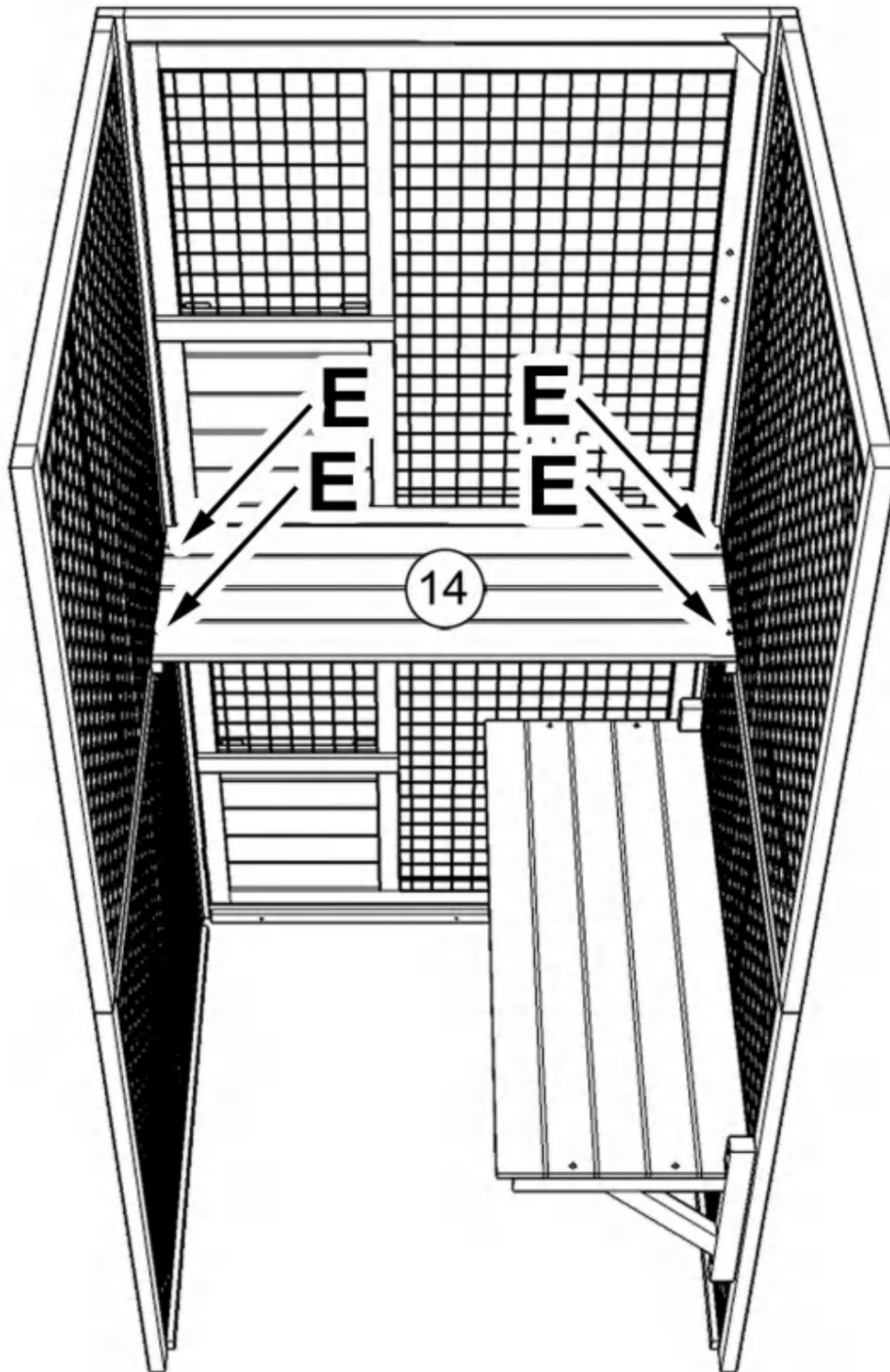

STEP:6

Assembling shelf with part #13 and part #11x2 by screws (E)x4 as shown

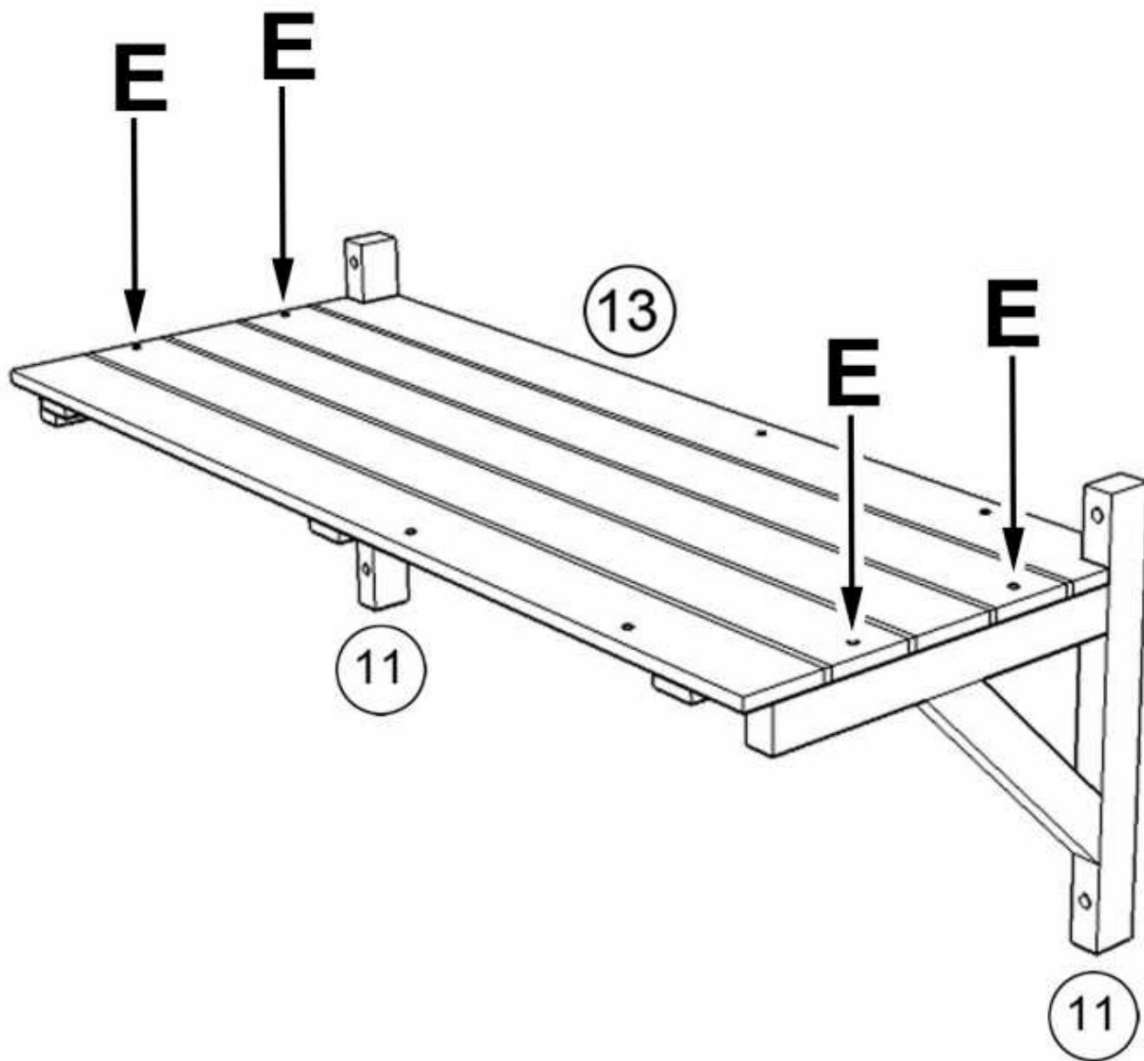

STEP:7

Mounting the shelf to the right side of board as shown with screws (B)x4 at your preferred height

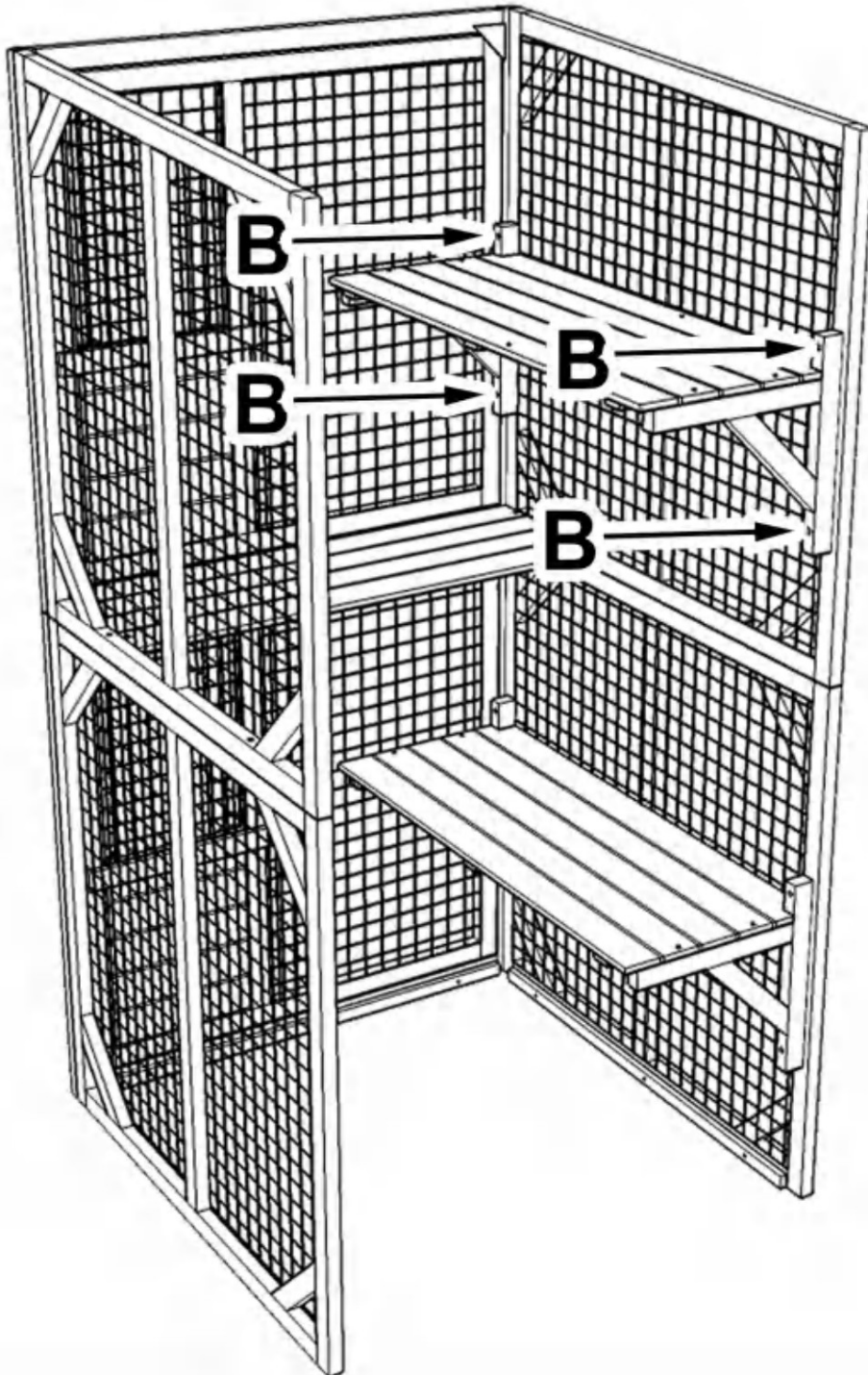

STEP:8

Assembling sleeping box with part #16x2, #17, #15 using screws (E)x10

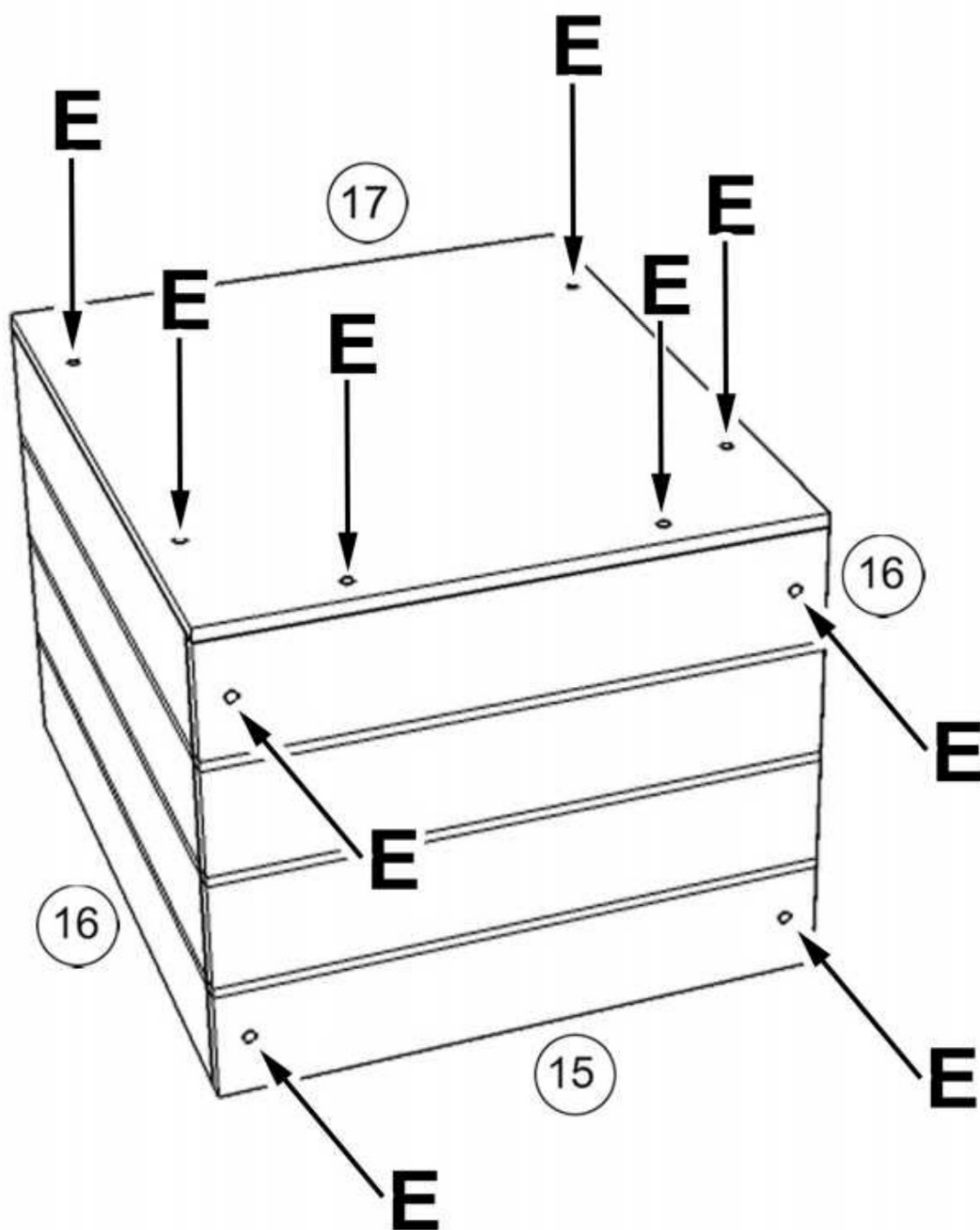

STEP:9

Placing sleeping box on the top of shelf as shown and secure it with screws (E)x4 from the bottom of shelf

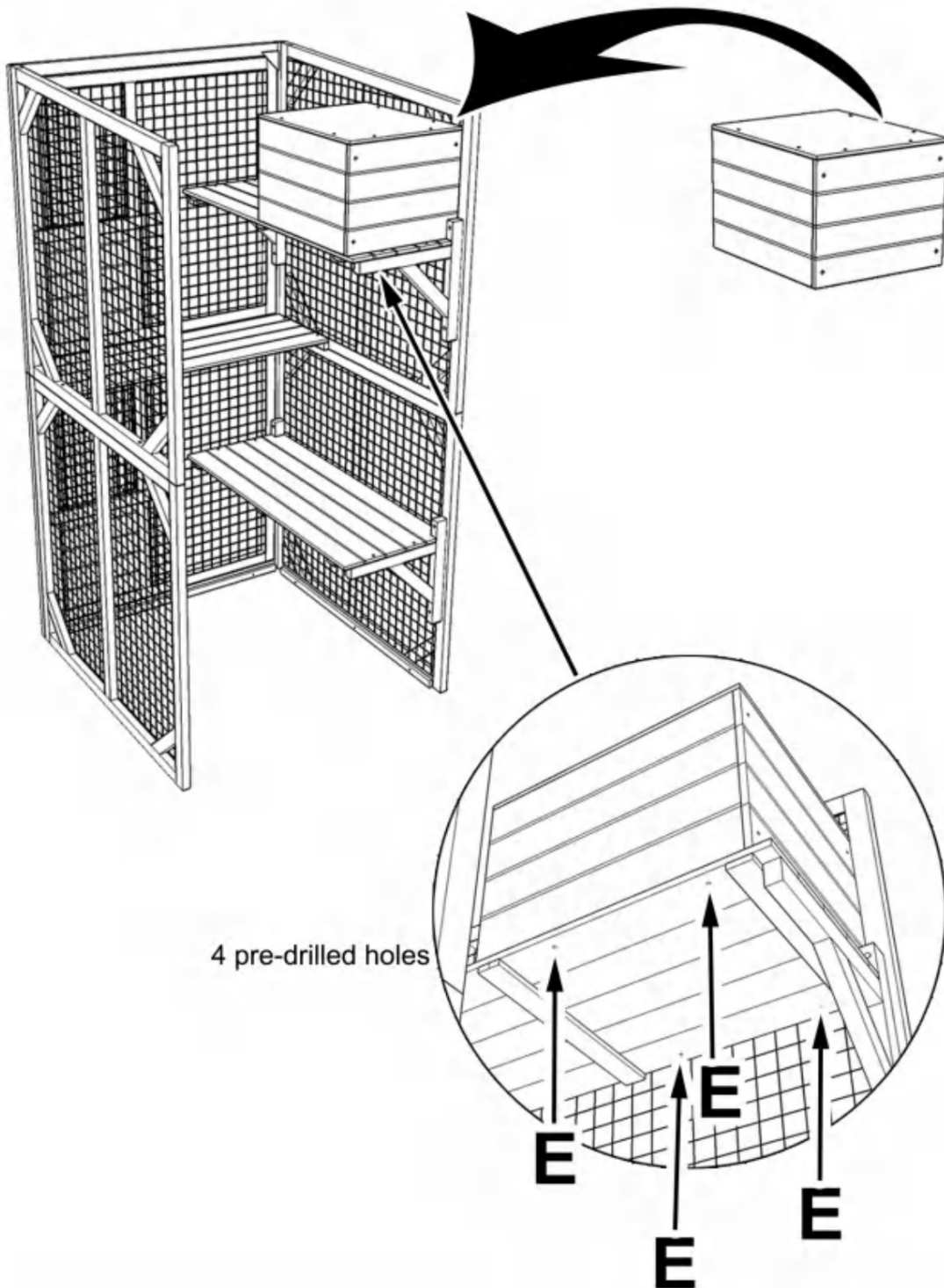

STEP:10

Assembling firstly part #9 (bottom) and then part #8 (2 holes at bottom) with screws (C)x8, then secure the 2 parts by screwing (A)x2 downwards as shown

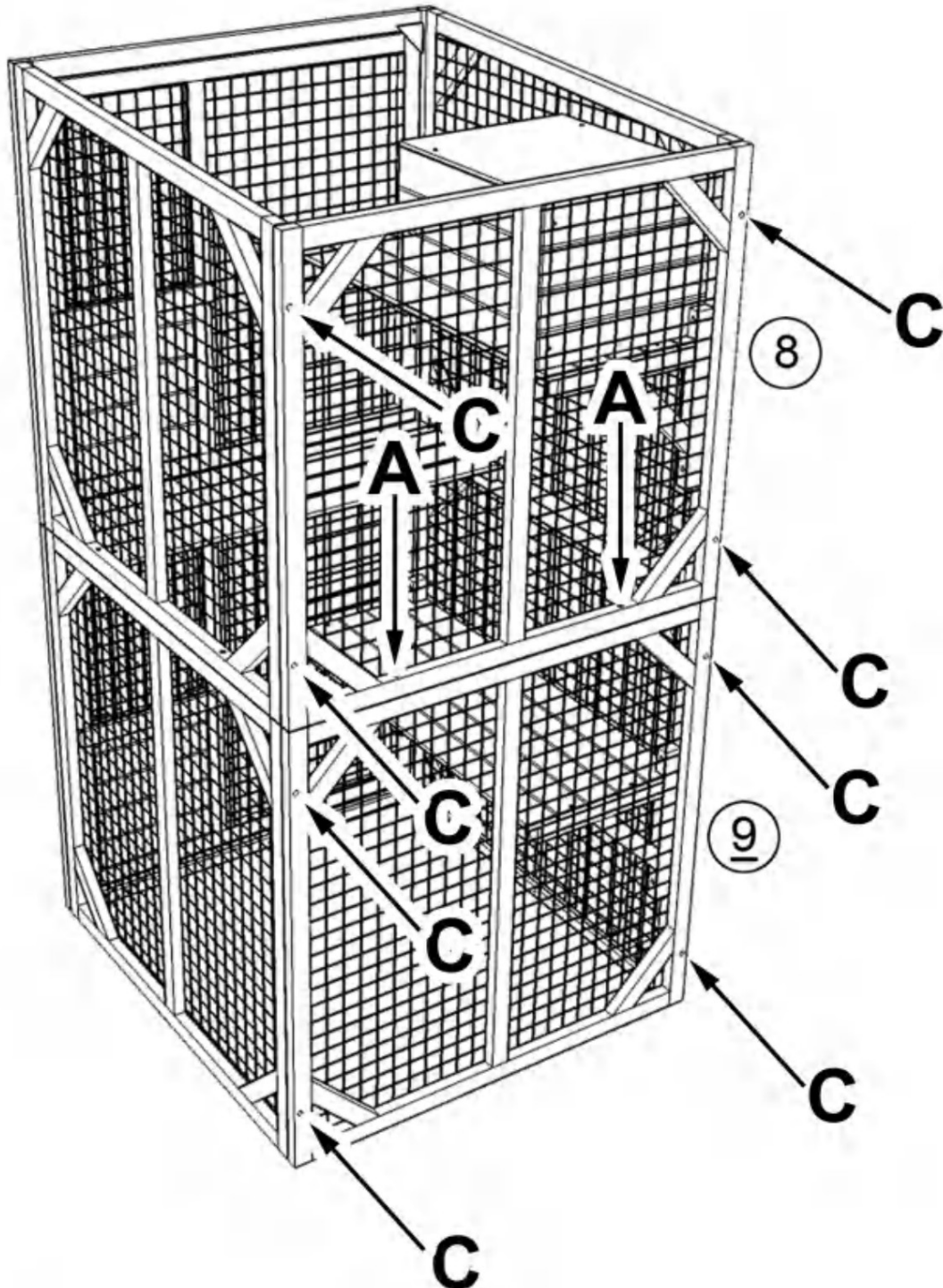

STEP:11

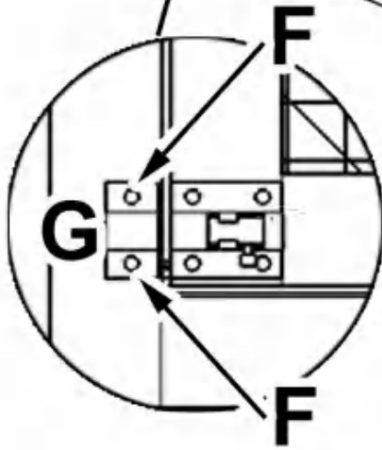
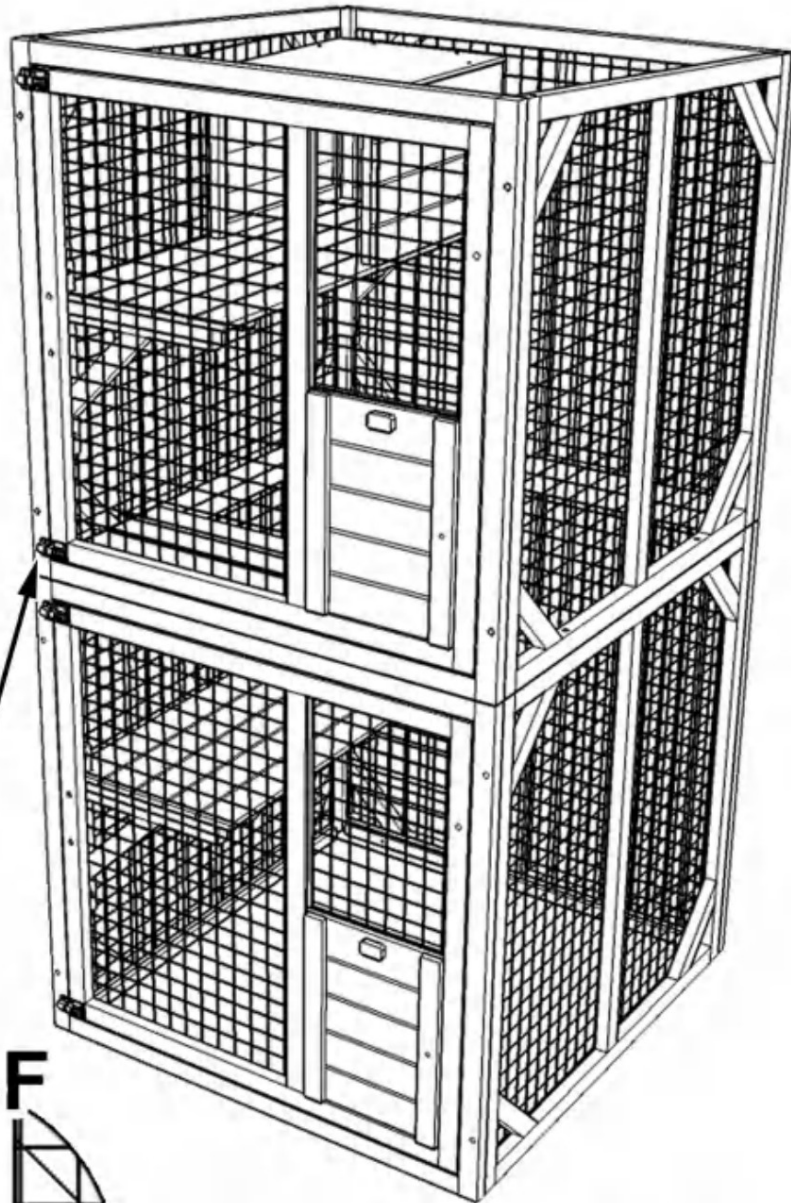

Align the short end of lock part #G with its other part already on door then secure it with screws (F)x2

STEP:12

Install handles parts #19x2 on doors with screws (C)x4 as shown

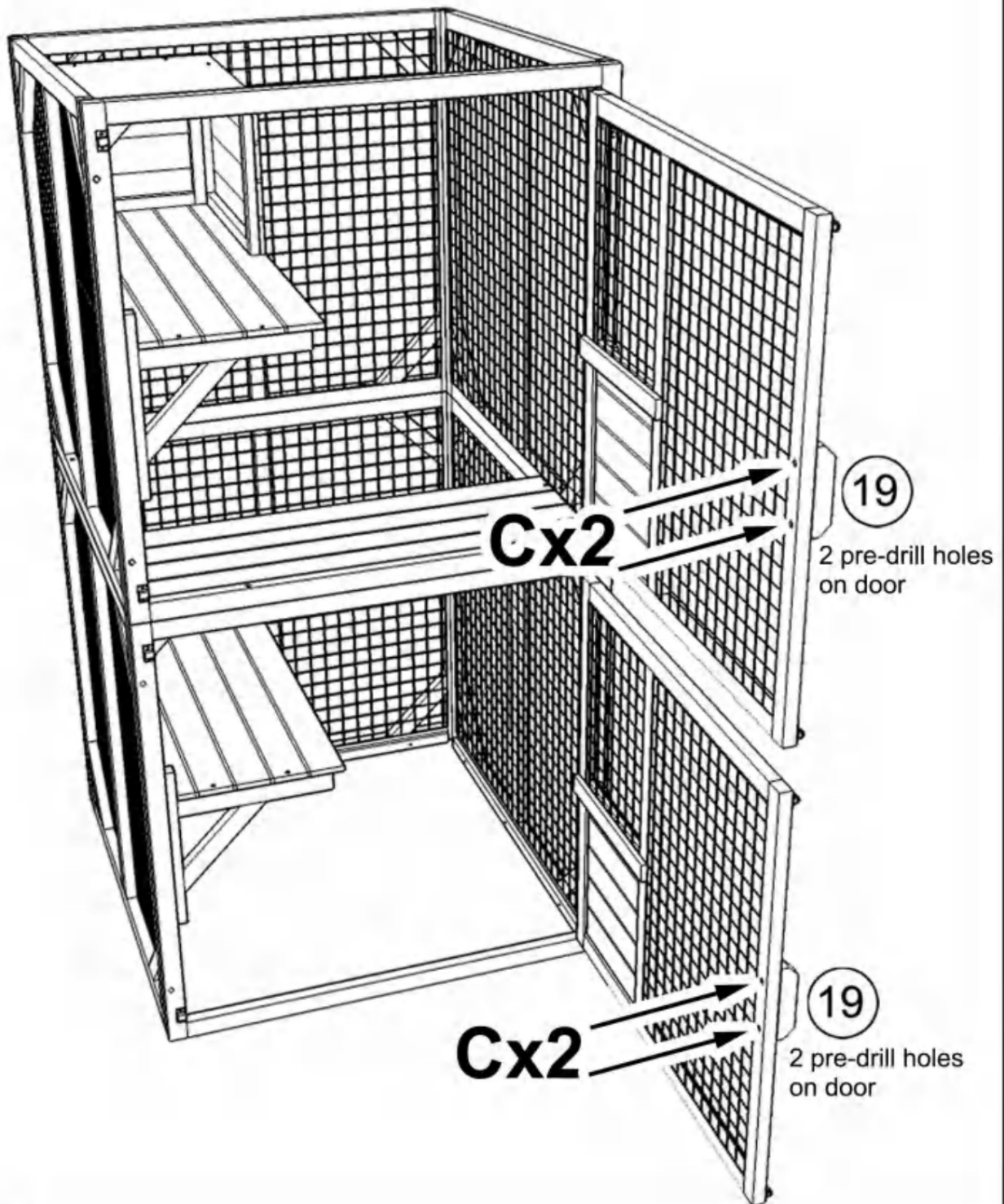

STEP:13

Install hooks as shown, long part is on the sliding door, short part is on the frame wood

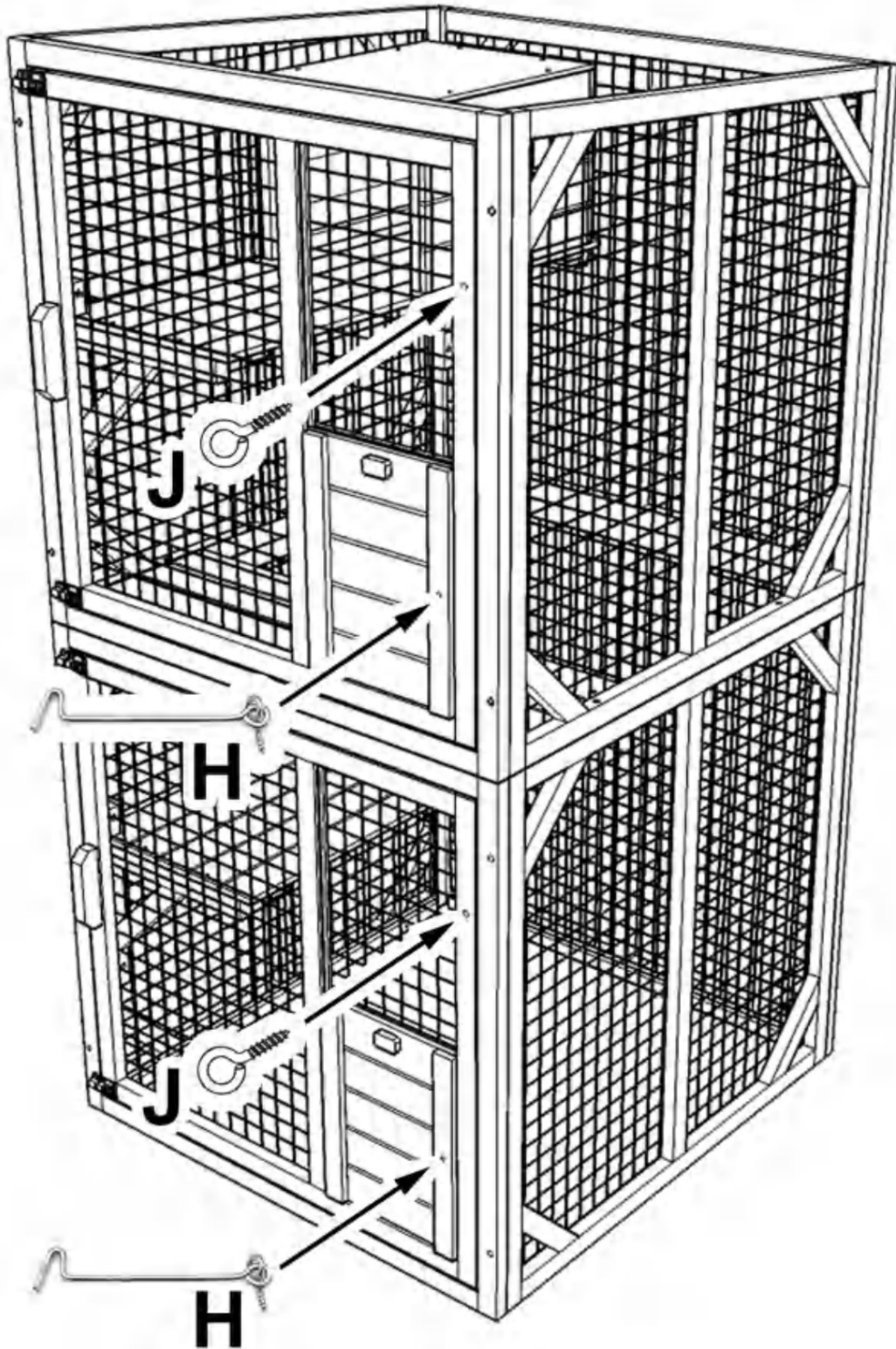

STEP:14

Gently let down the product, install part #7x4 as shown by screws (C)x12

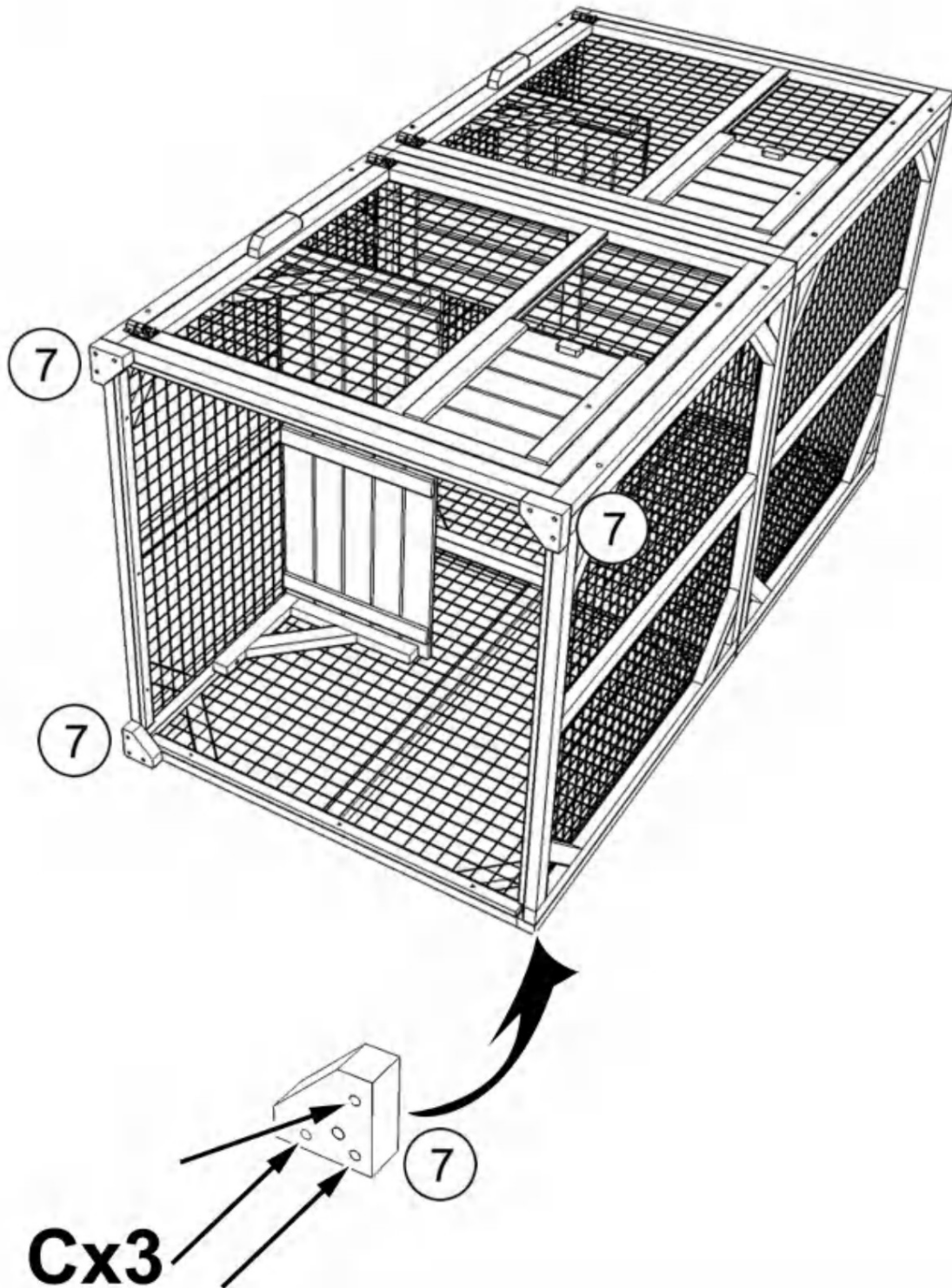

STEP:15

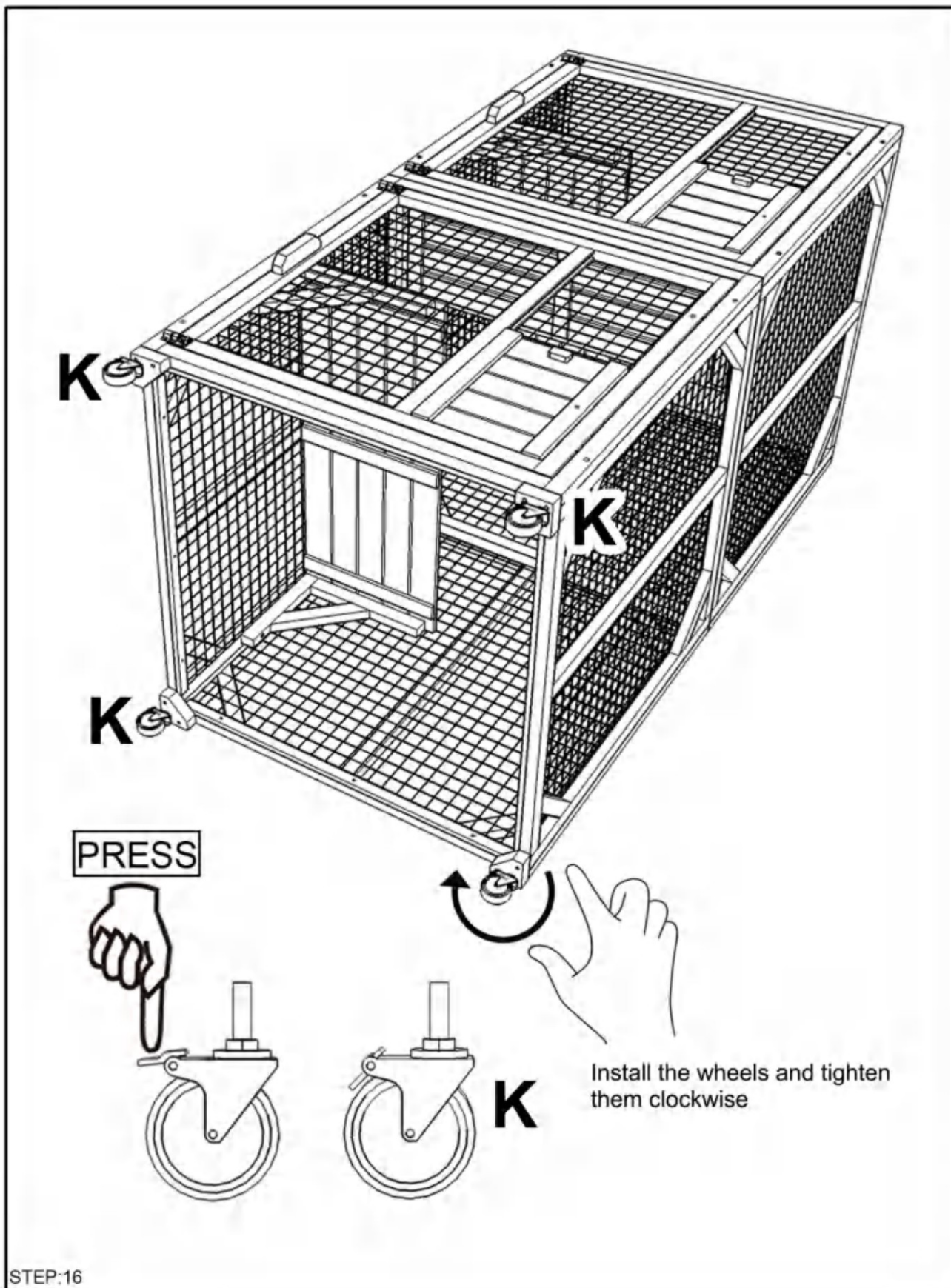

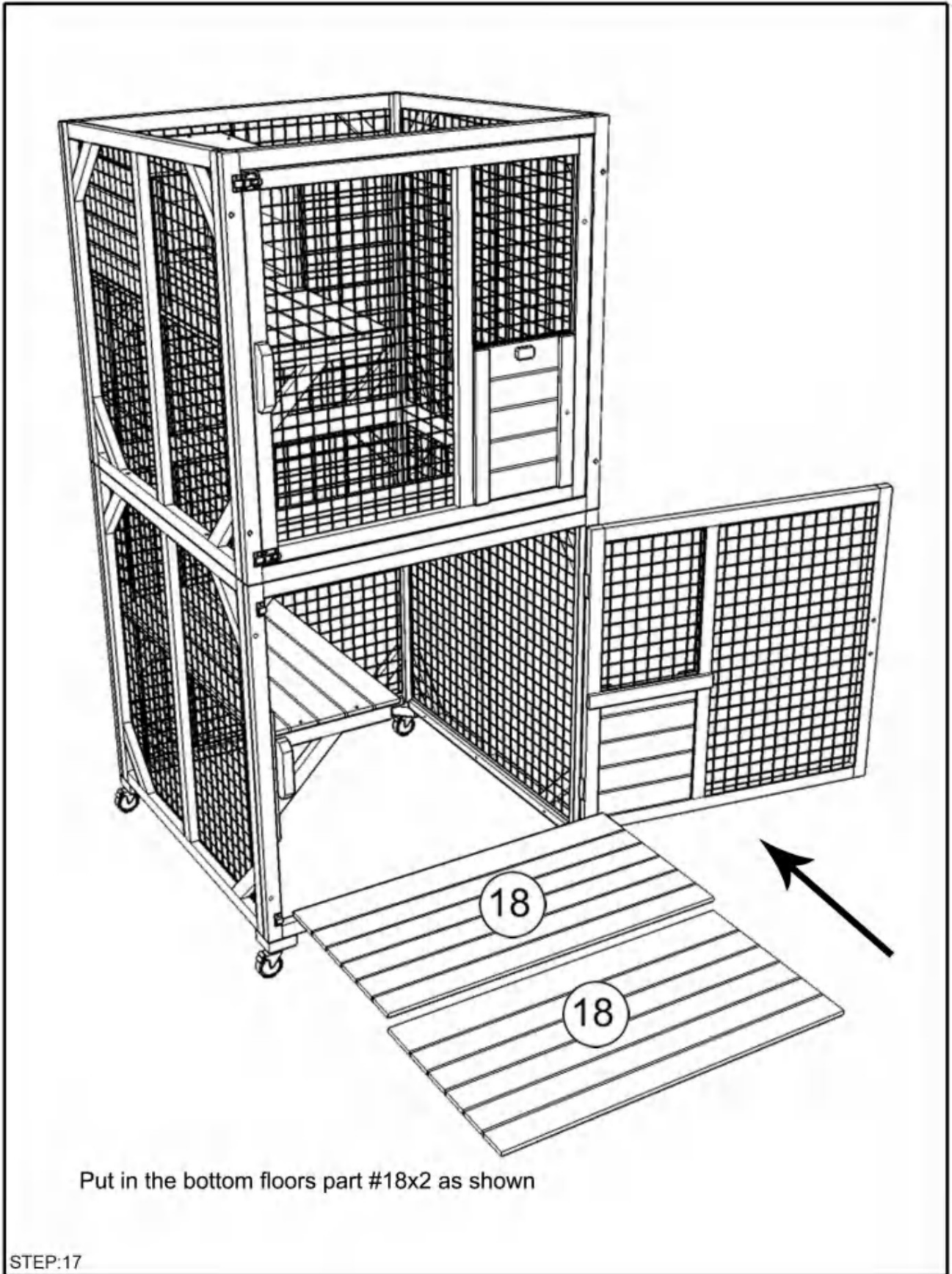

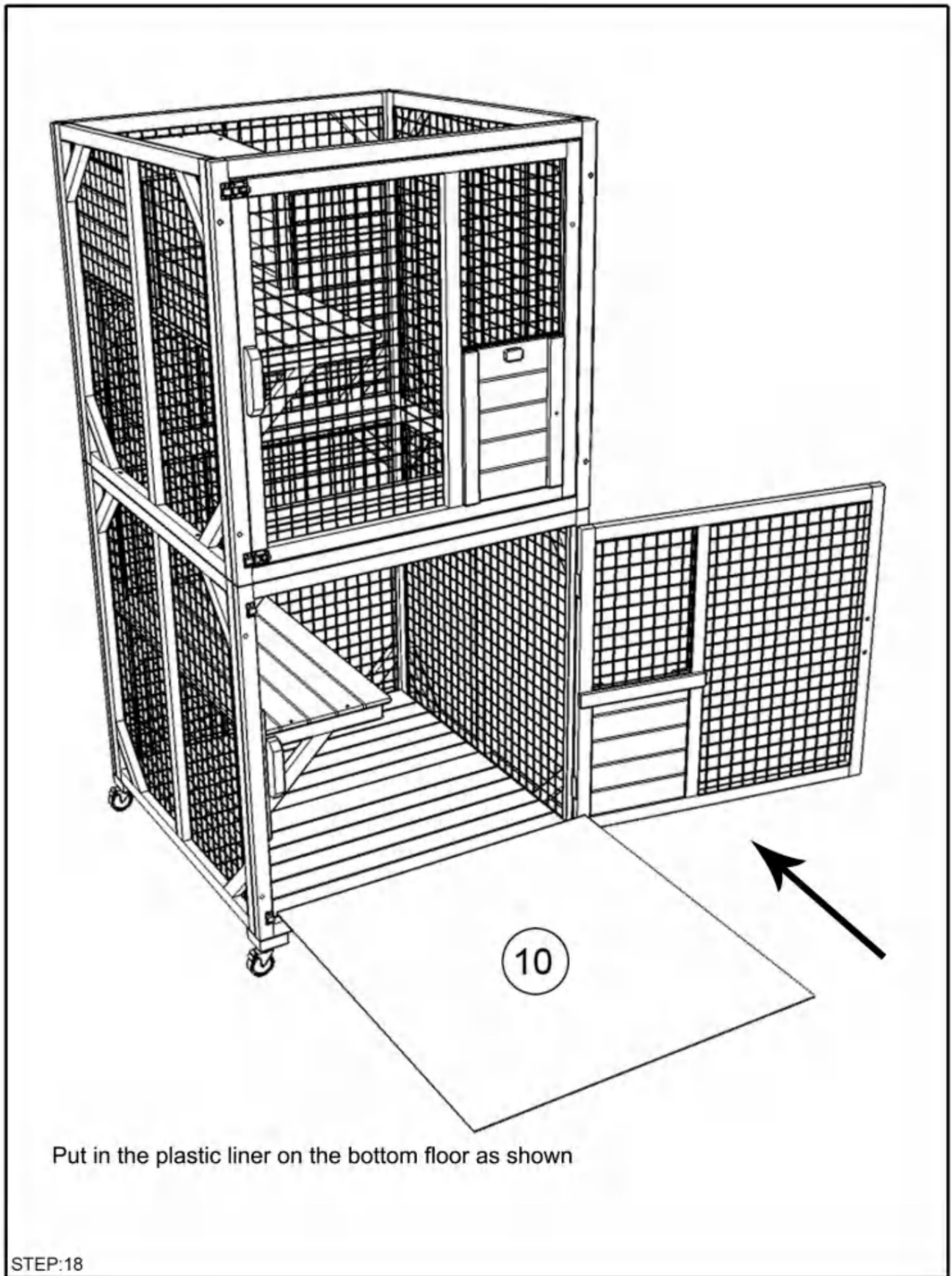

Install the felted roof part #3 with screws (D)x8

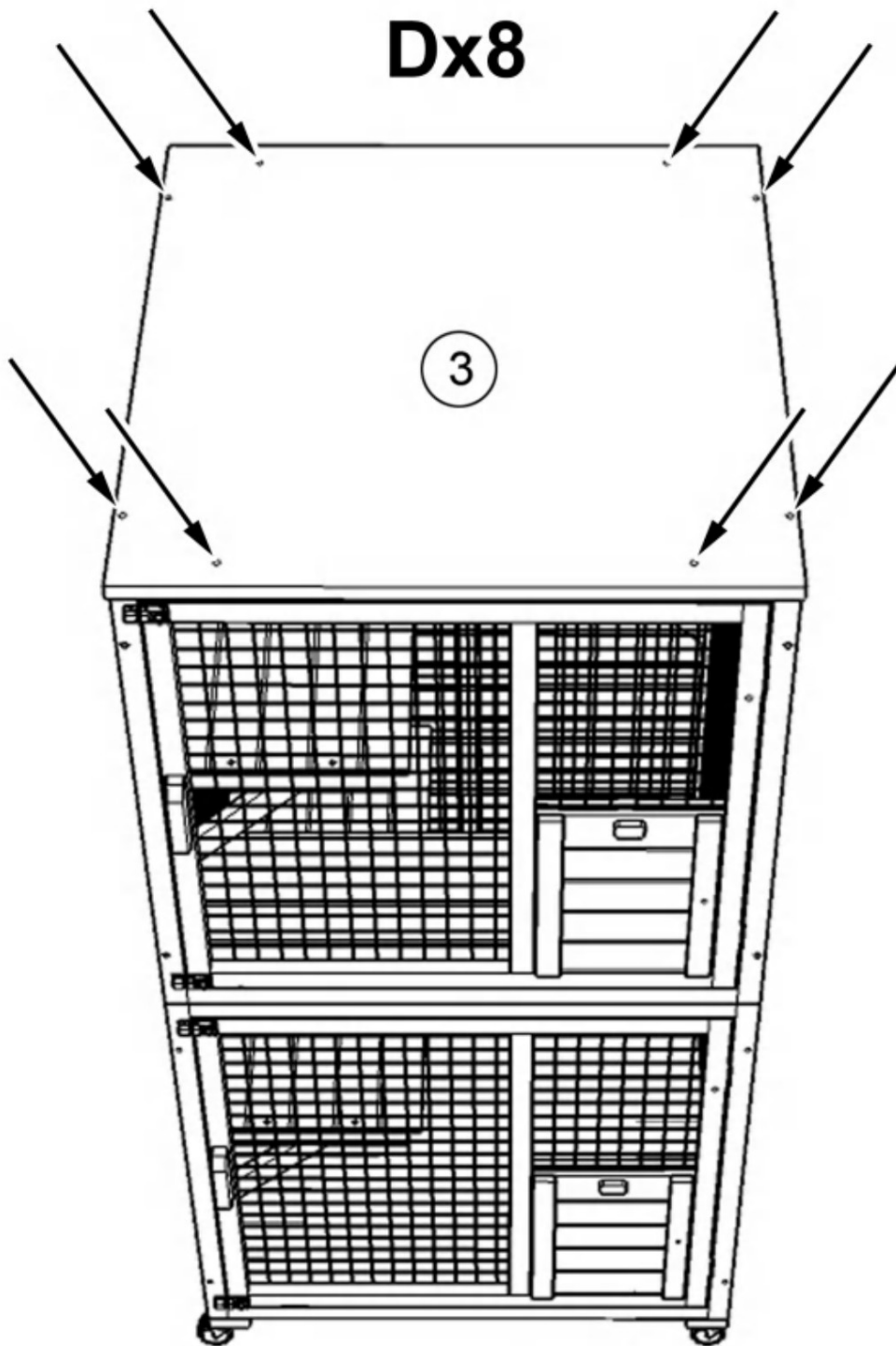

STEP:19

Shuangchenglu 803nong11hao1602A-1609shi, baoshanqu,
shanghai 200000 CN.



E-CrossStu GmbH.
Mainzer Landstr.69, 60329
Frankfurt am Main.



YH CONSULTING LIMITED.
C/O YH Consulting Limited Kantoor
147, Centurion House, London Road,
Staines-upon-Thames, Surrey, TW18 4AX

Geïmporteerd naar de VS: Sanven Technology Ltd., Suite 250, 9166
Anaheim Place, Rancho Cucamonga, CA 91730

VEVOR[®]

TOUGH TOOLS, HALF PRICE

Technical Support and E-Warranty Certificate

www.vevor.com/support

VEVOR[®]

TOUGH TOOLS, HALF PRICE

Technical Support and E-Warranty Certificate www.vevor.com/support

INSTRUCTION FOR CAT CAGE

MODEL:CH470

Nous continuons à nous engager à vous fournir des outils à des prix compétitifs.
« Économisez la moitié », « Moitié prix » ou toute autre expression similaire utilisée par nous ne représente qu'une estimation des économies que vous pourriez réaliser en achetant certains outils chez nous par rapport aux grandes marques et ne couvre pas nécessairement toutes les catégories d'outils que nous proposons. Nous vous rappelons de bien vouloir vérifier soigneusement lorsque vous passez une commande chez nous si vous économisez réellement la moitié par rapport aux grandes marques.

VEVOR[®]
TOUGH TOOLS, HALF PRICE

CAT CAGE

CH470



NEED HELP? CONTACT US!

Have product questions? Need technical support? Please feel free to contact us:

Assistance technique et certificat de garantie électronique www.vevor.com/support

This is the original instruction, please read all manual instructions carefully before operating. VEVOR reserves a clear interpretation of our user manual. The appearance of the product shall be subject to the product you received. Please forgive us that we won't inform you again if there are any technology or software updates on our product.

WARNING:

Read this material before using this product. Failure to do so can result in serious injury.

Assembly precautions

1. Assemble only according to these instructions. Improper assembly can create hazards.
2. In order to ensure your own safety, please make sure to ANSI-approved safety goggles and heavy-duty work gloves when installing this product.
3. Keep the assembly area clean and well lit.
4. Keep bystanders out of the area during assembly.
5. Do not assemble when tired or when under the influence of alcohol, drugs or medication.
6. Product capabilities apply to properly and completely assembled product only.
7. Assemble on a flat, level, hard and smooth surface capable of safely supporting a fully loaded cat cage.

Use precautions

TO PREVENT SERIOUS INJURY AND DEATH FROM TIPPING:

1. DO NOT SIT OR STAND ON THIS ITEM.
2. This product is not a toy. Do not allow children to play with or near this item. Please keep small spare parts out of children's reach.
3. Use only on a flat, level, hard and smooth surface capable of safely supporting a fully loaded cat cage.
4. Use as intended only.
5. Inspect before every use; do not use if parts are loose or damaged.

SAVE THESE INSTRUCTIONS

SPECIFICATIONS

Model	CH470
Product Size	760×865×1630mm
Color	Gray

COMPONENTS

Notice:

1. Various specifications of screws are used in the installation of this product. Pay attention to the correct use of screw specifications according to the instruction manual.
2. Please wear gloves when installing.

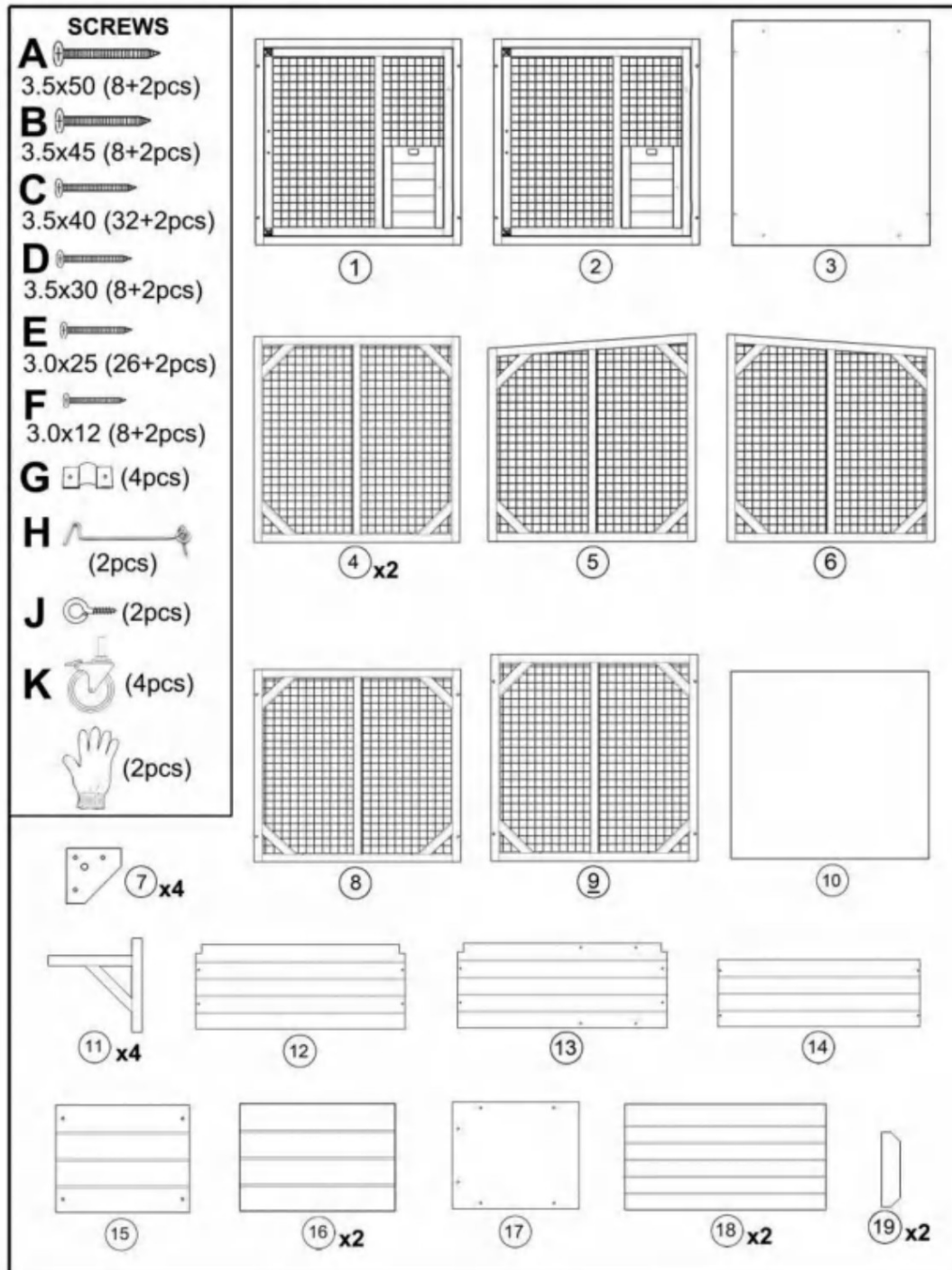

Assembly Instructions

Please be noted that the side with wire nailed on is back side, should be inward when installation

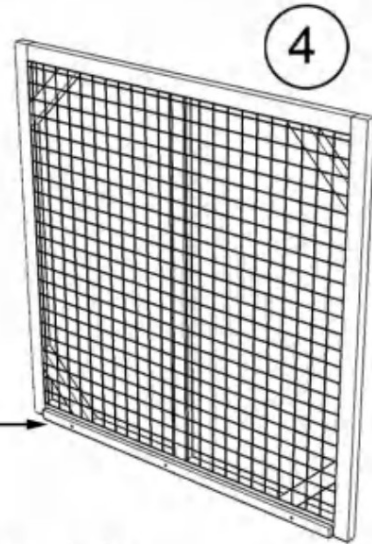

This end with a long piece of wood is placed at bottom

Assembling part #4x2 and part #1 with screws (C)x4 as shown below

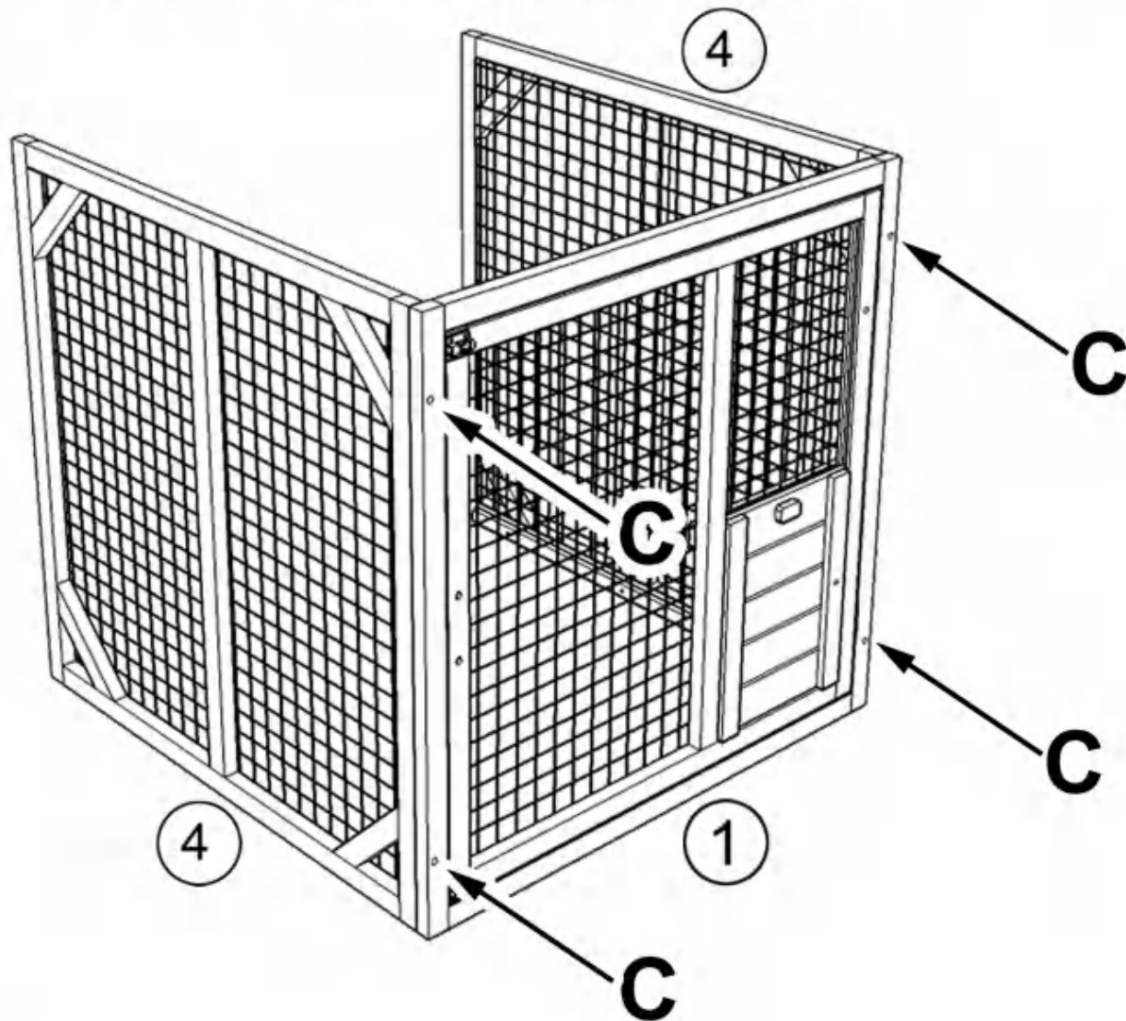

STEP:1

The part #2 (open the door) and part #5 has pre-drilled holes at bottom as shown, assemble part #2 and part #5 with screws (C)x2, then place them on the parts finished in last step and secure them with screws (A)x4 downwards

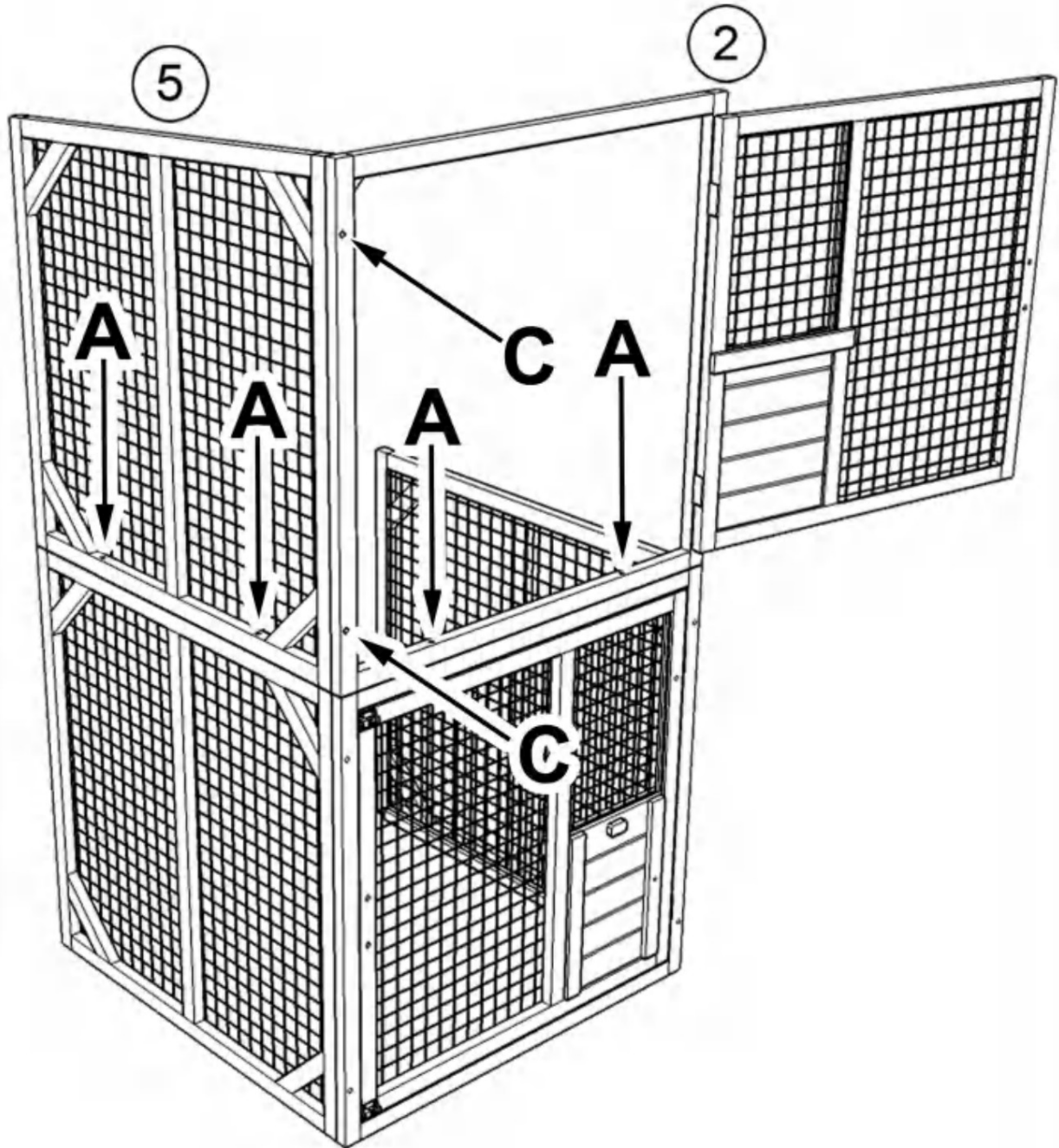

STEP:2

The part #6 has 2 pre-drilled holes at bottom, assembling part #6 with screws (C)x2 as shown and secure it to lower part with screws (A)x2 downwards

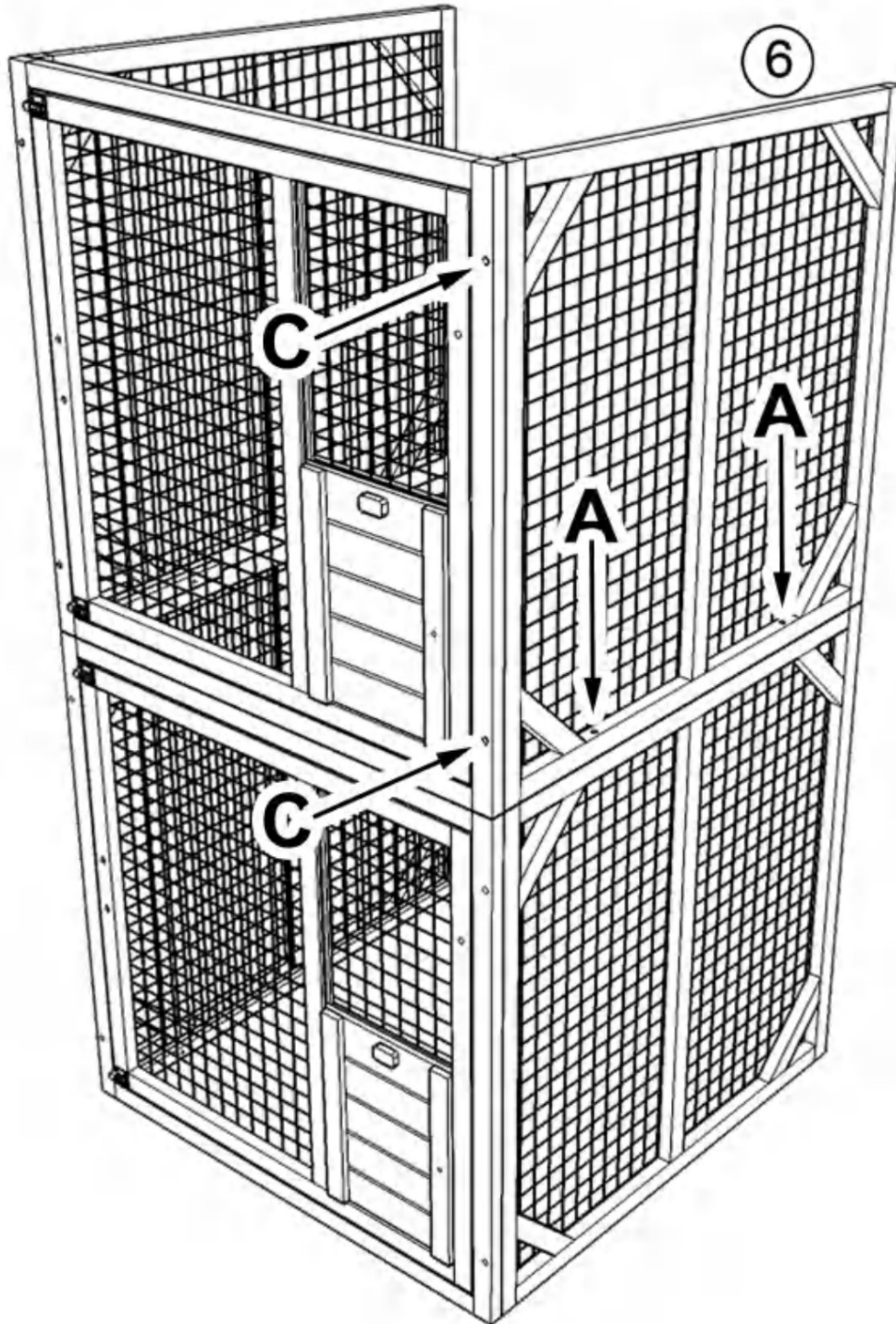

STEP:3

Assembling shelf with part #12 and part #11x2 by screws (E)x4 as shown

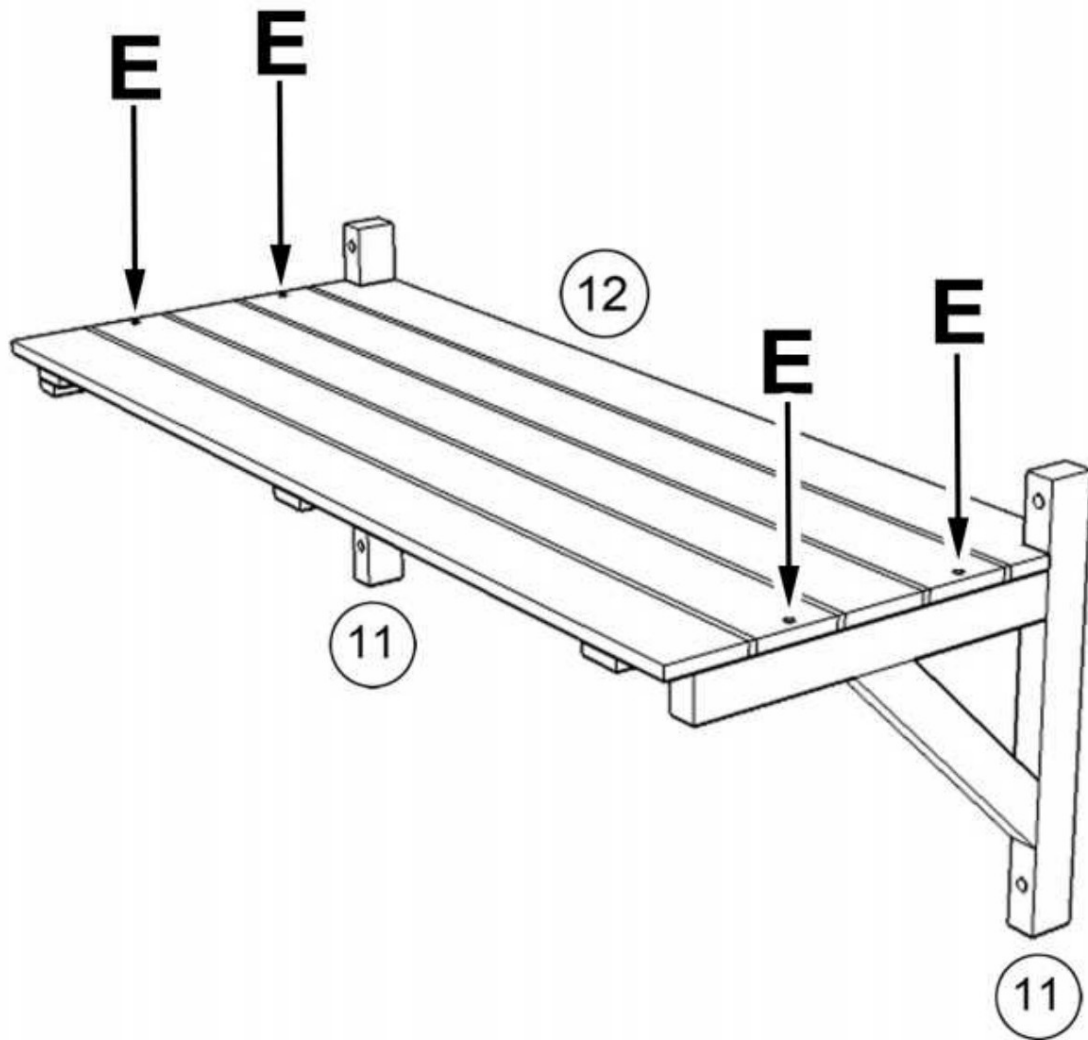

STEP:4

Mounting the shelf on right side as shown by screws (B)x4 at your preferred height

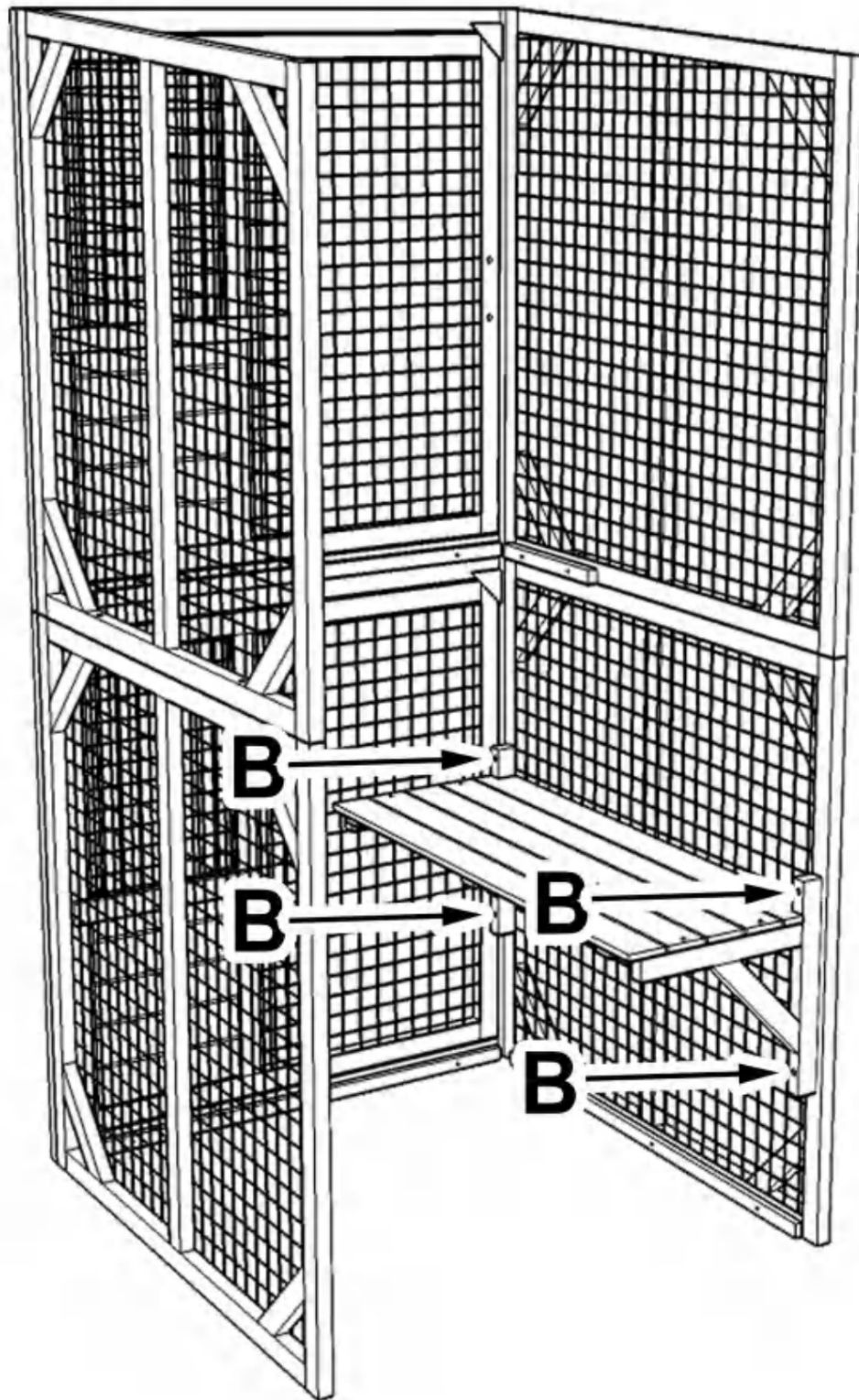

STEP:5

Placing part #14 on the short wood pieces on left and right side and secure it with screw (E)x4

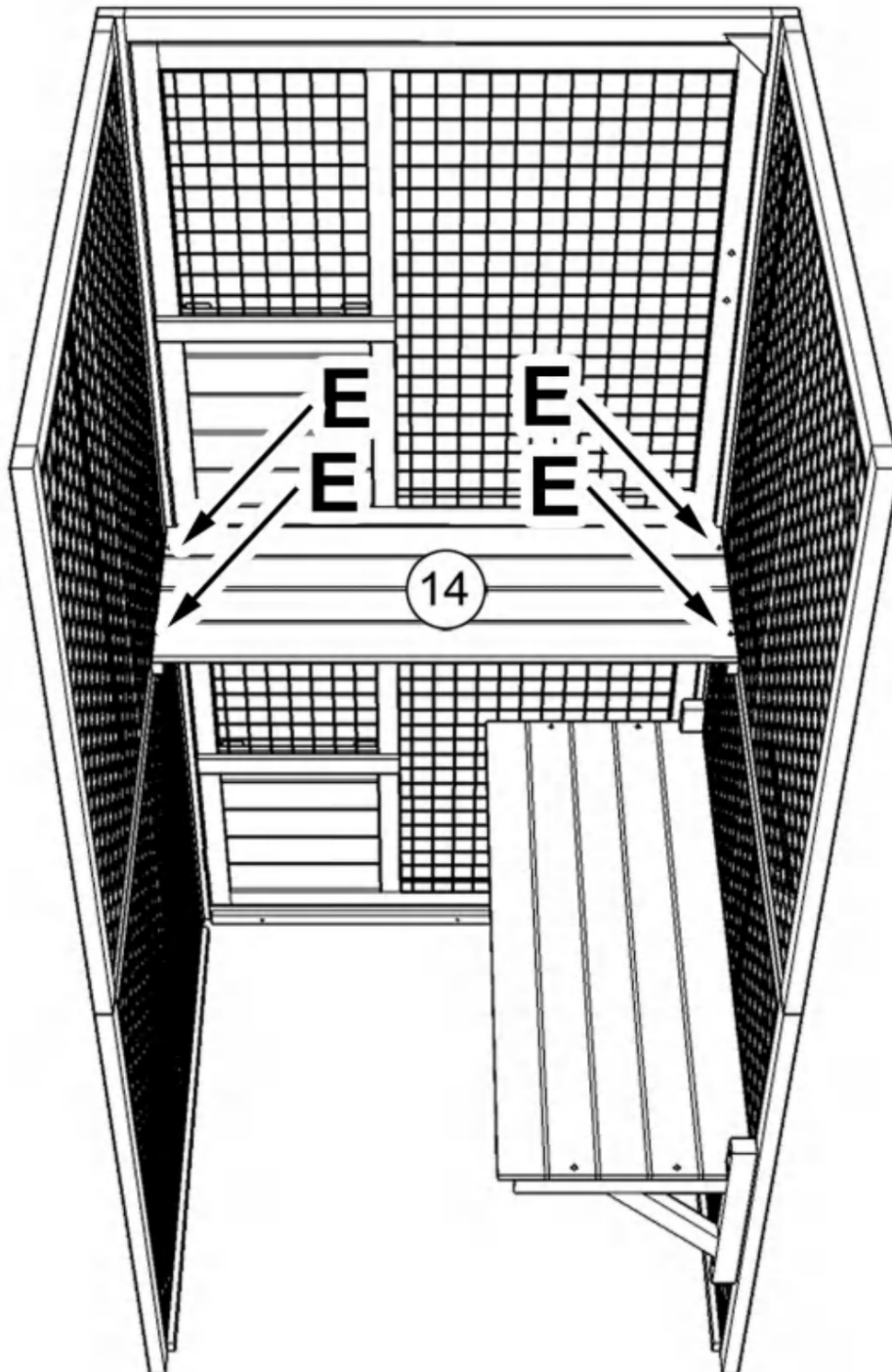

STEP:6

Assembling shelf with part #13 and part #11x2 by screws (E)x4 as shown

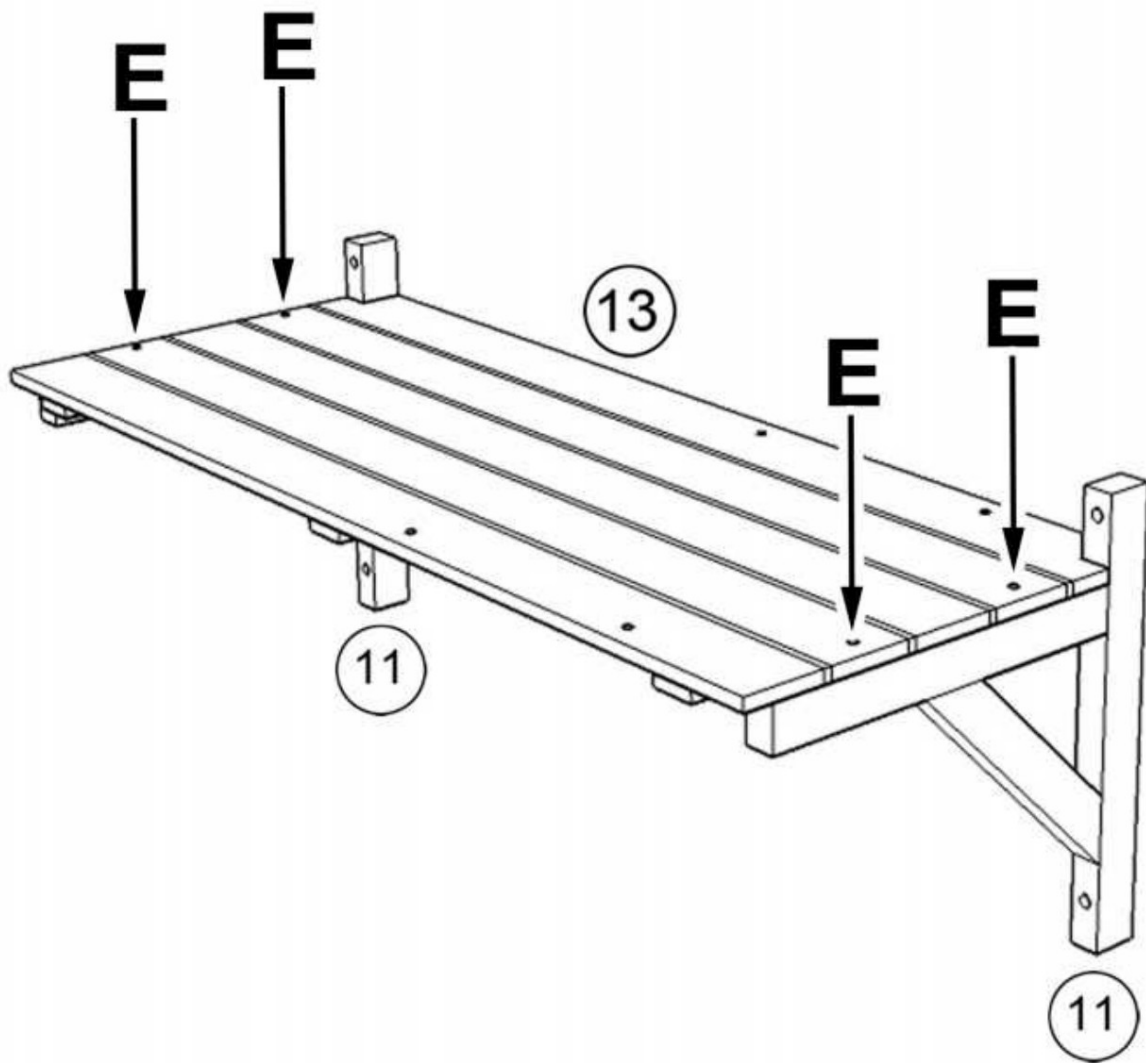

STEP:7

Mounting the shelf to the right side of board as shown with screws (B)x4 at your preferred height

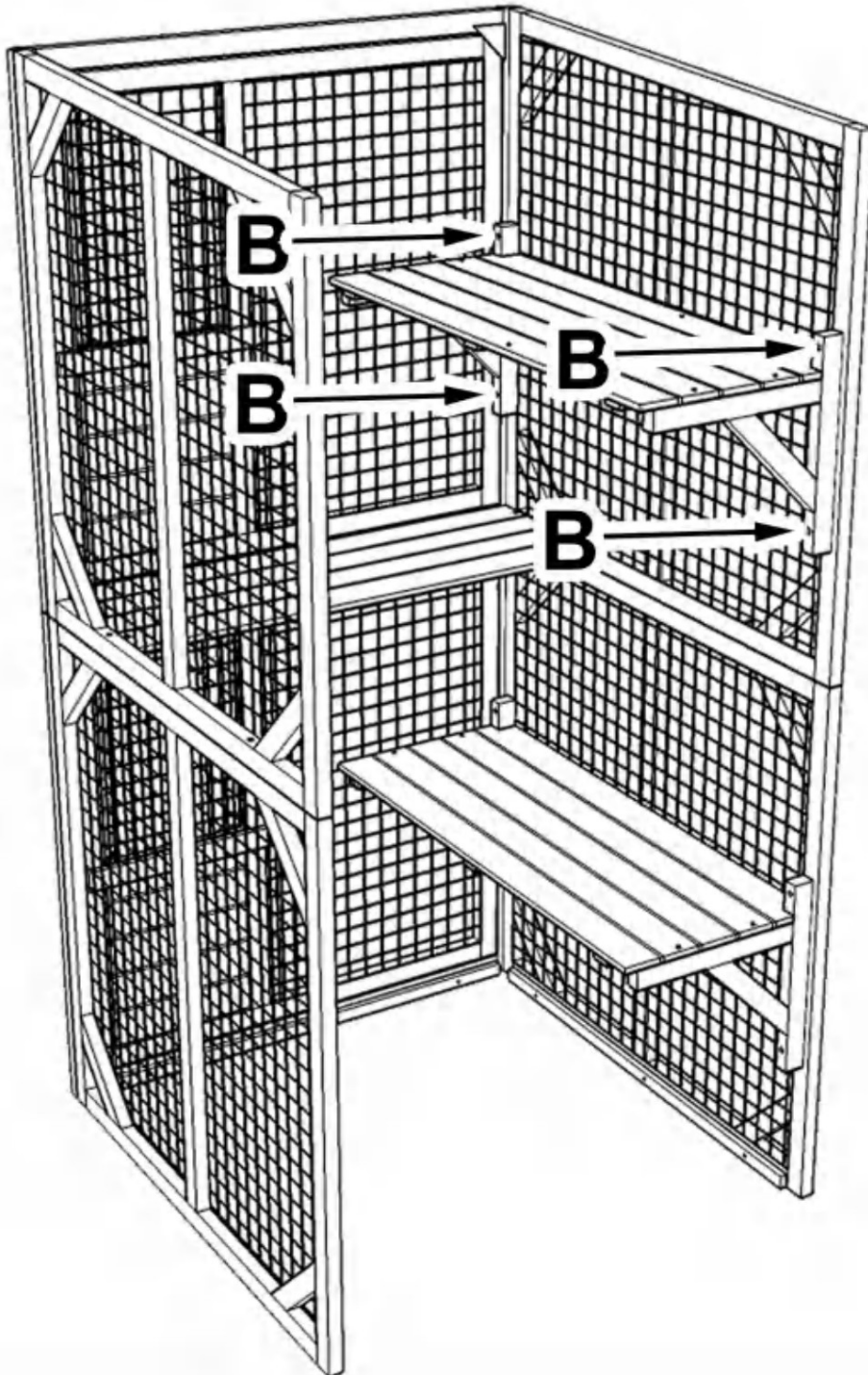

STEP:8

Assembling sleeping box with part #16x2, #17, #15 using screws (E)x10

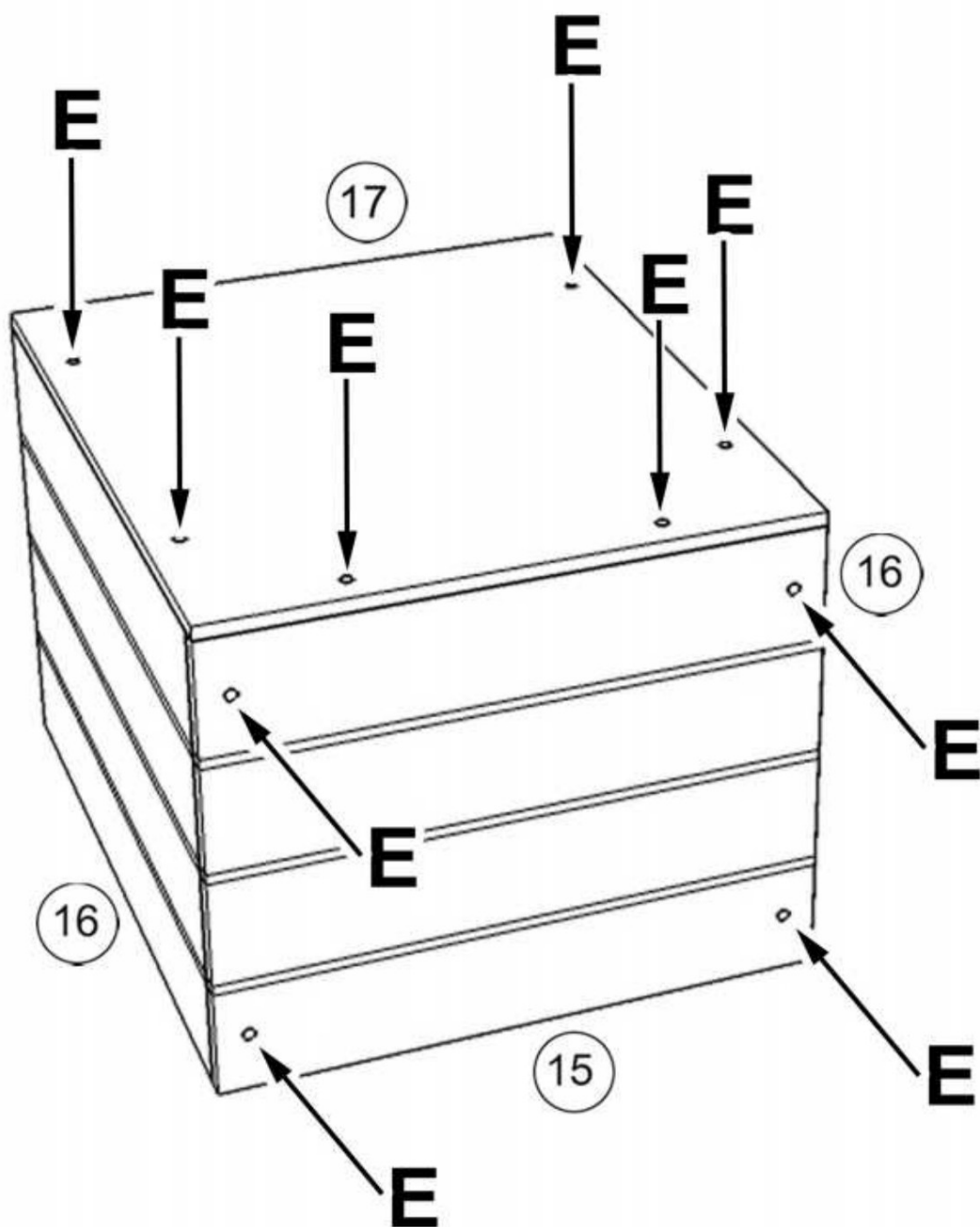

STEP:9

Placing sleeping box on the top of shelf as shown and secure it with screws (E)x4 from the bottom of shelf

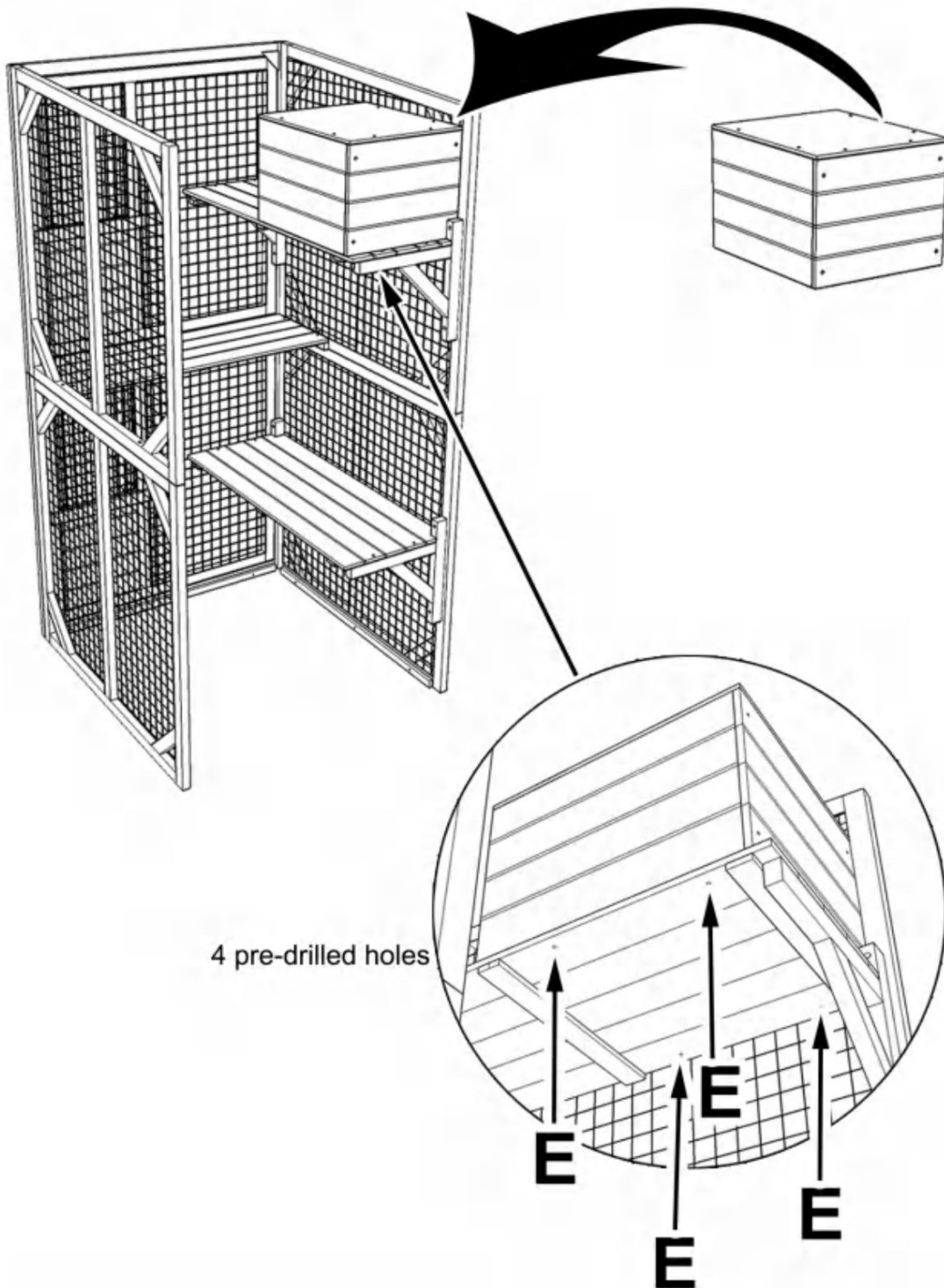

STEP:10

Assembling firstly part #9 (bottom) and then part #8 (2 holes at bottom) with screws (C)x8, then secure the 2 parts by screwing (A)x2 downwards as shown

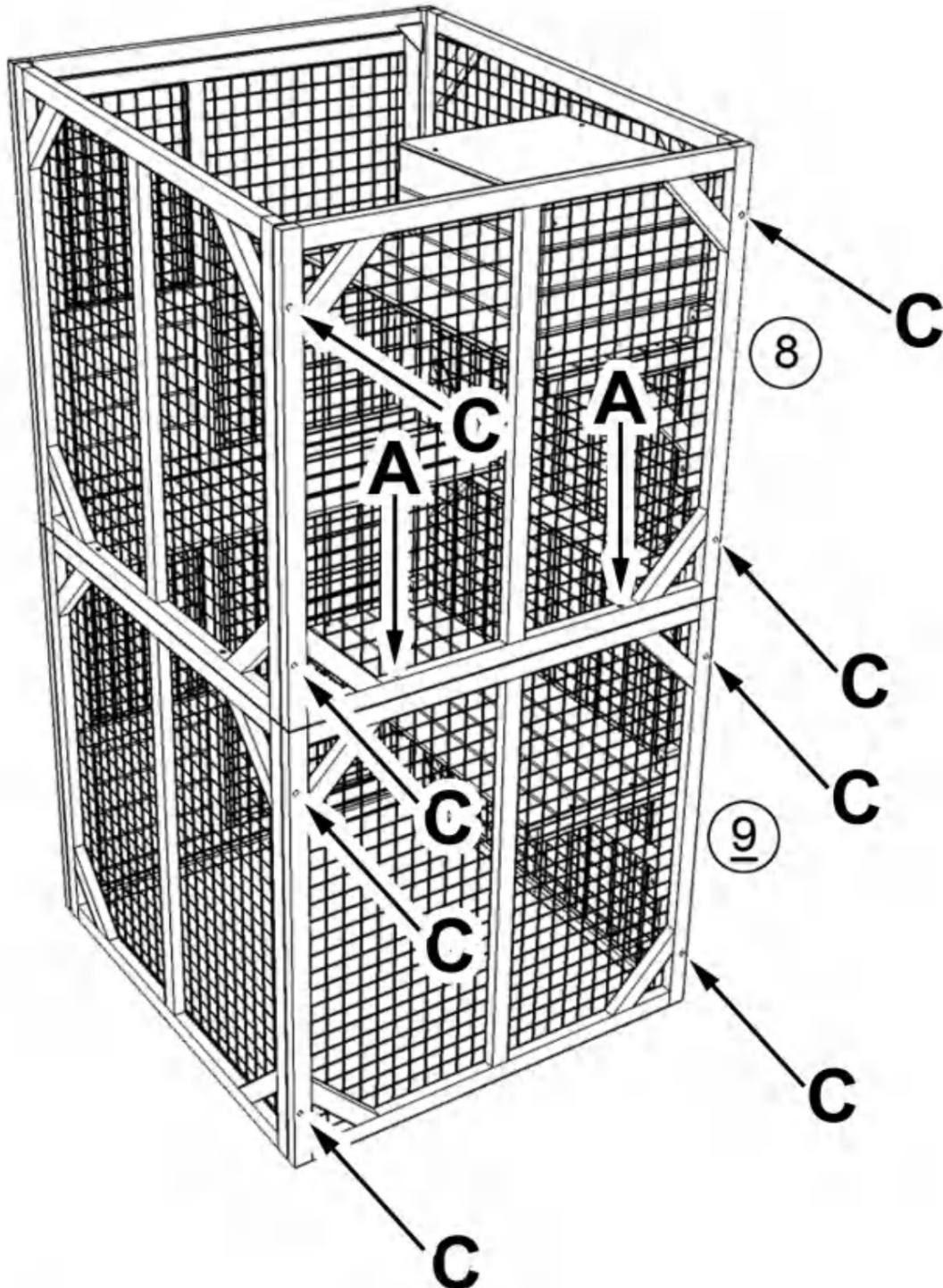

STEP:11

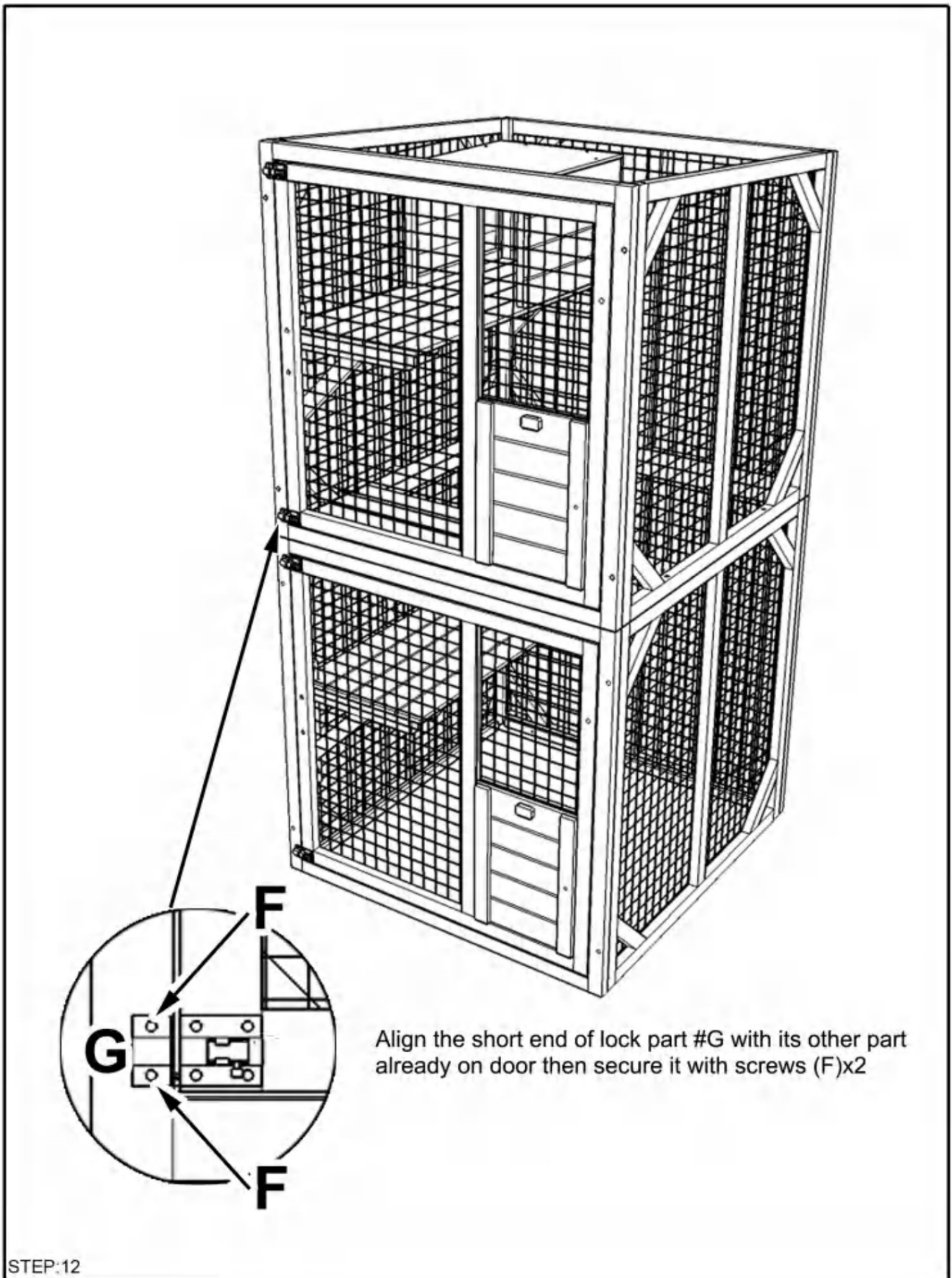

Align the short end of lock part #G with its other part already on door then secure it with screws (F)x2

STEP:12

Install handles parts #19x2 on doors with screws (C)x4 as shown

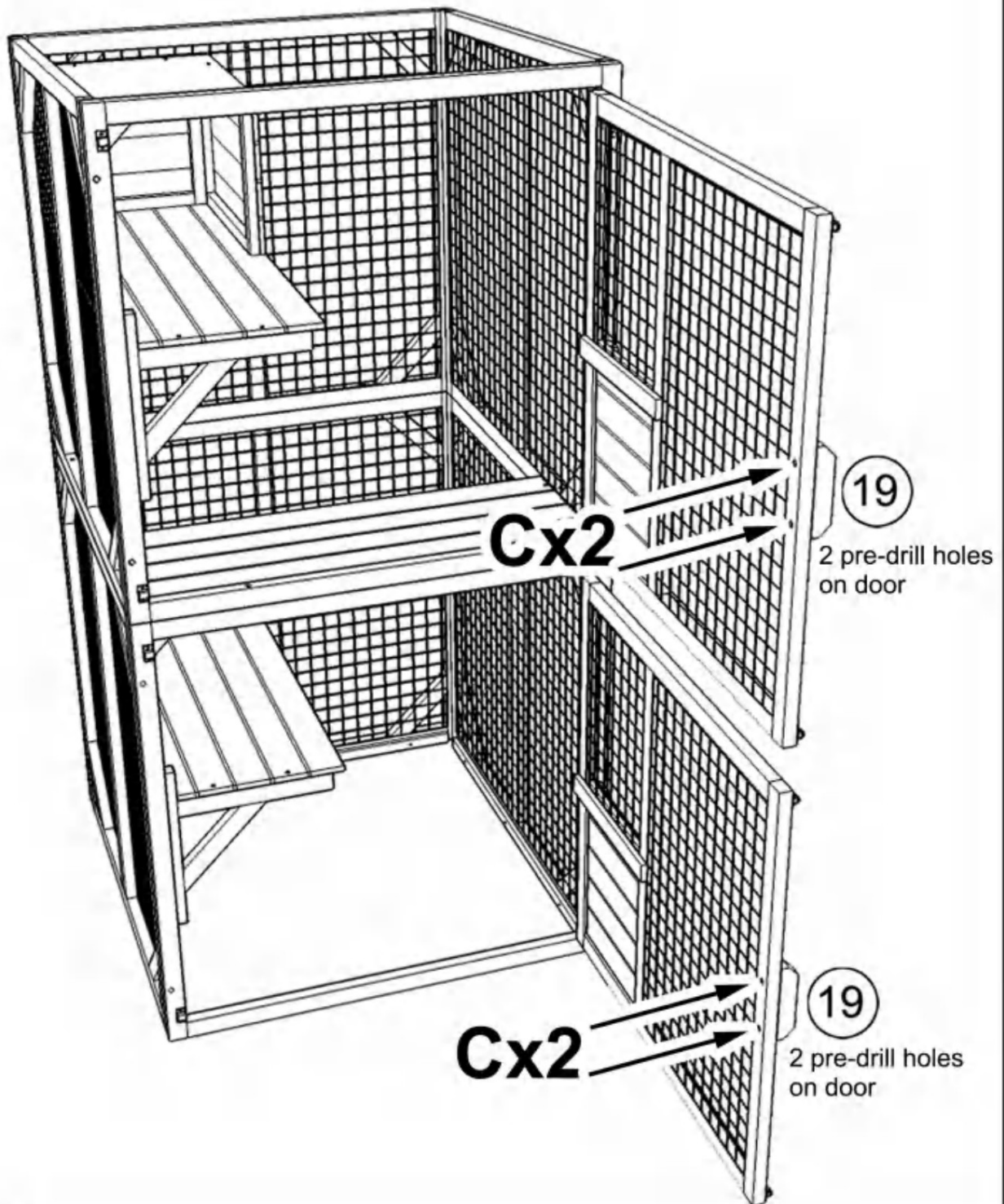

STEP:13

Install hooks as shown, long part is on the sliding door, short part is on the frame wood

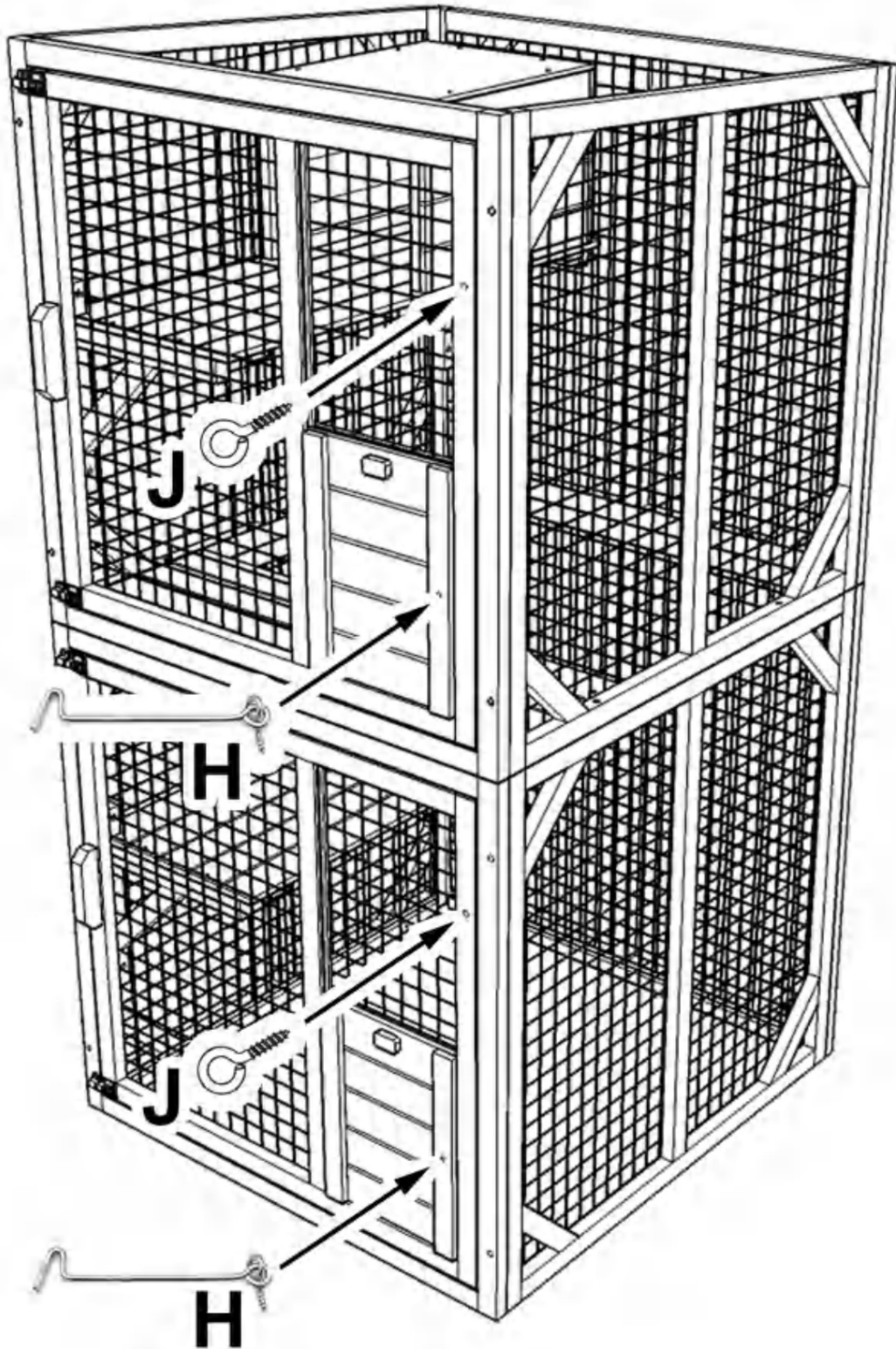

STEP:14

Gently let down the product, install part #7x4 as shown by screws (C)x12

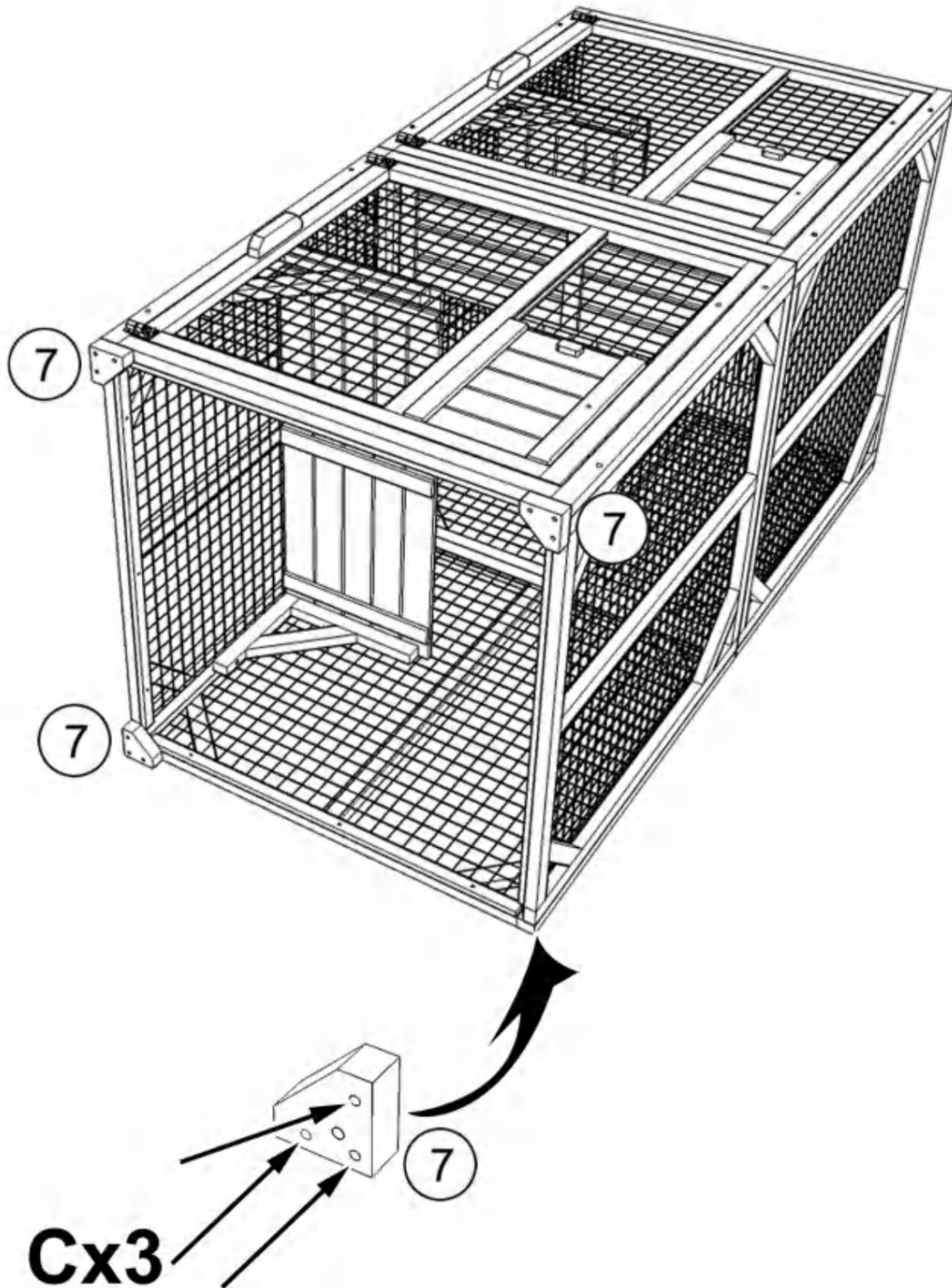

STEP:15

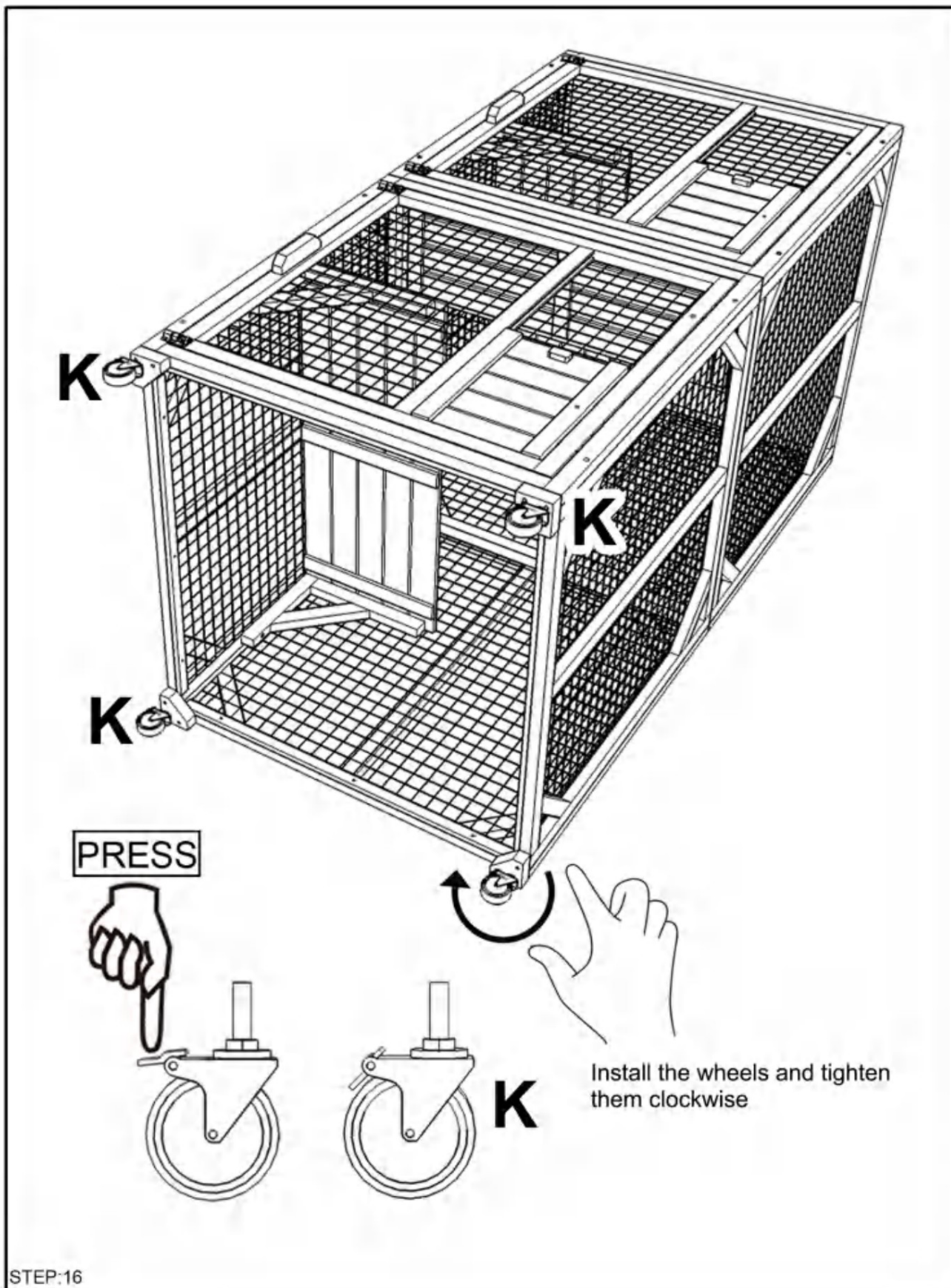

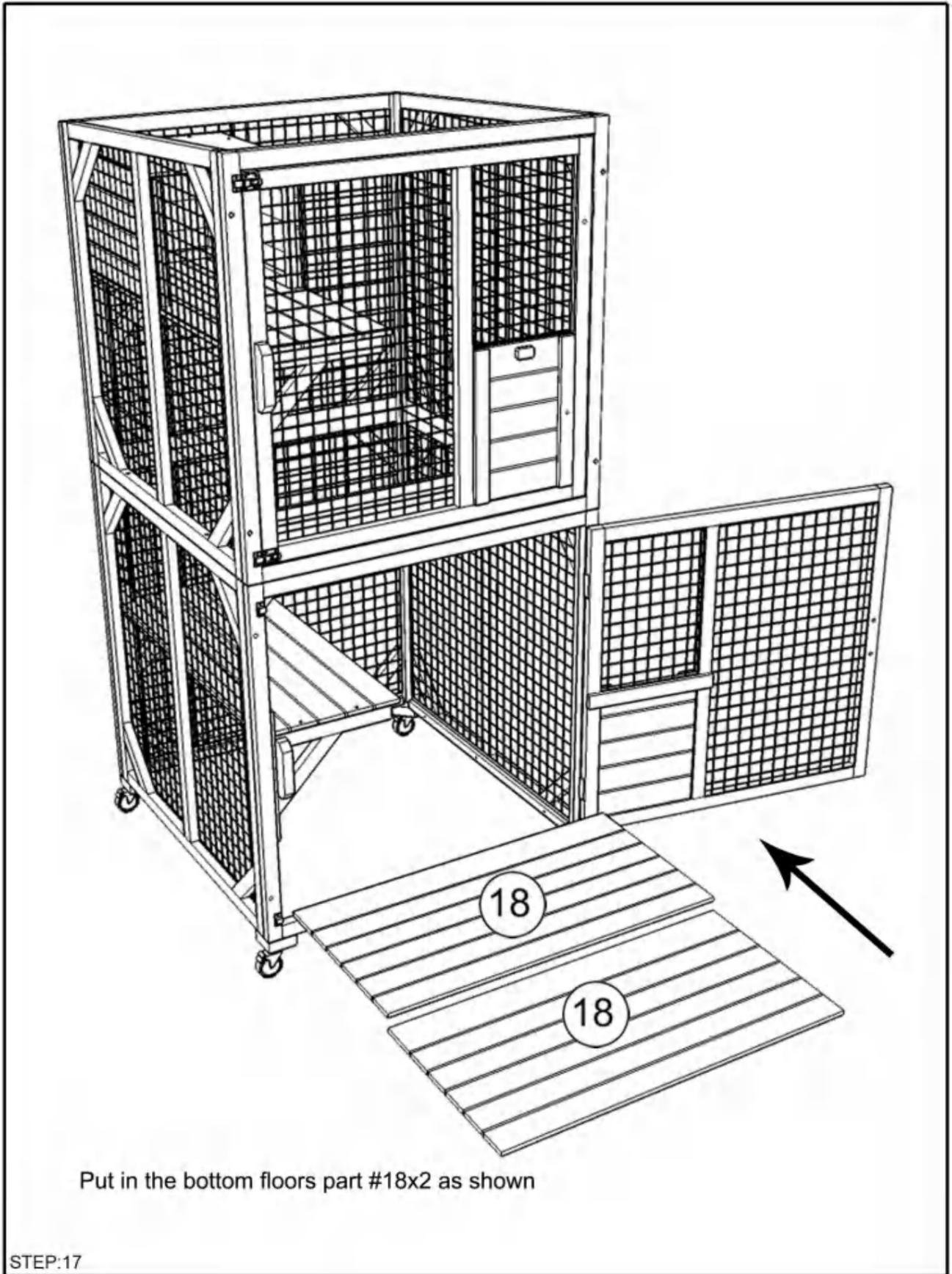

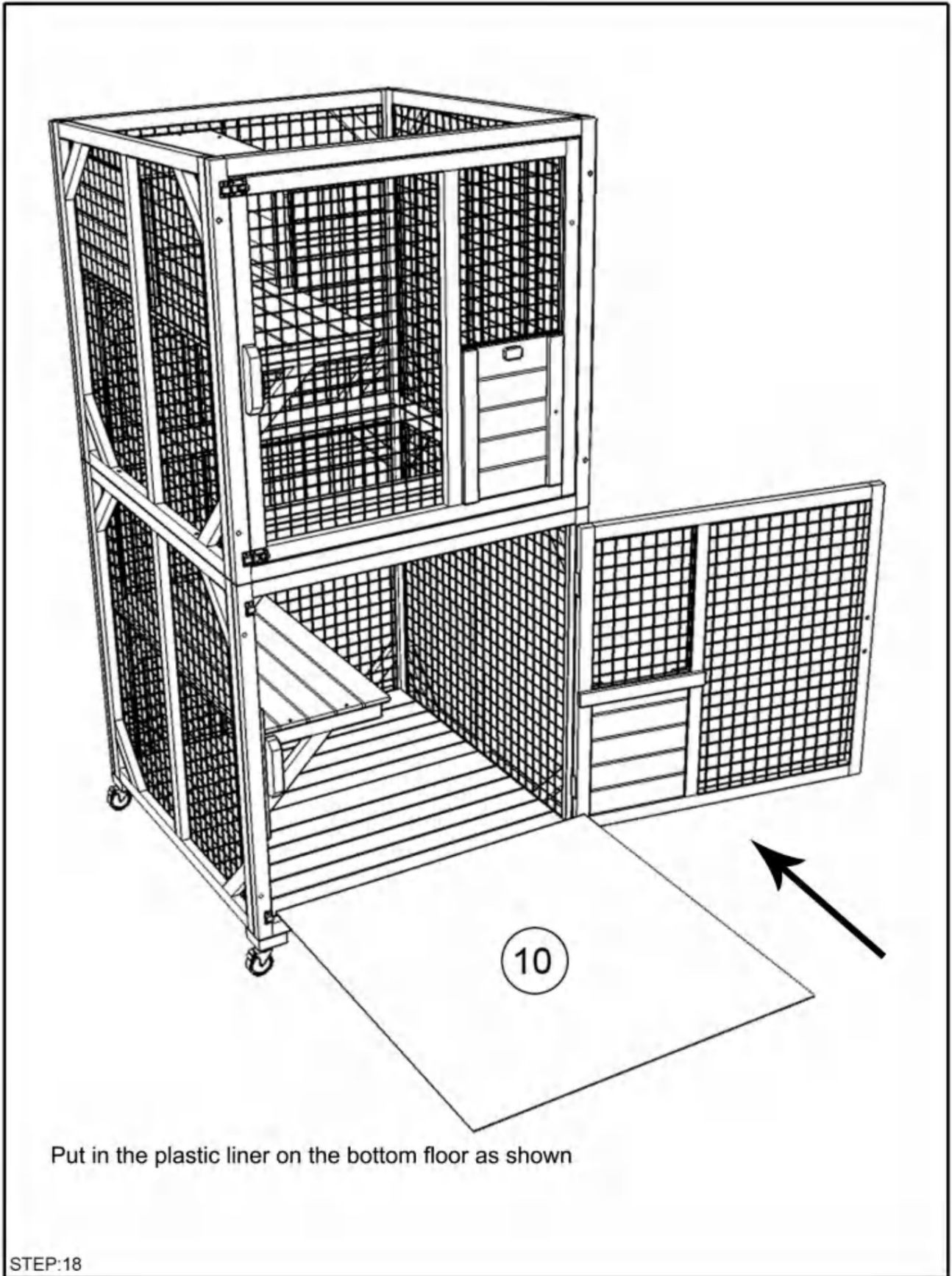

Install the felted roof part #3 with screws (D)x8

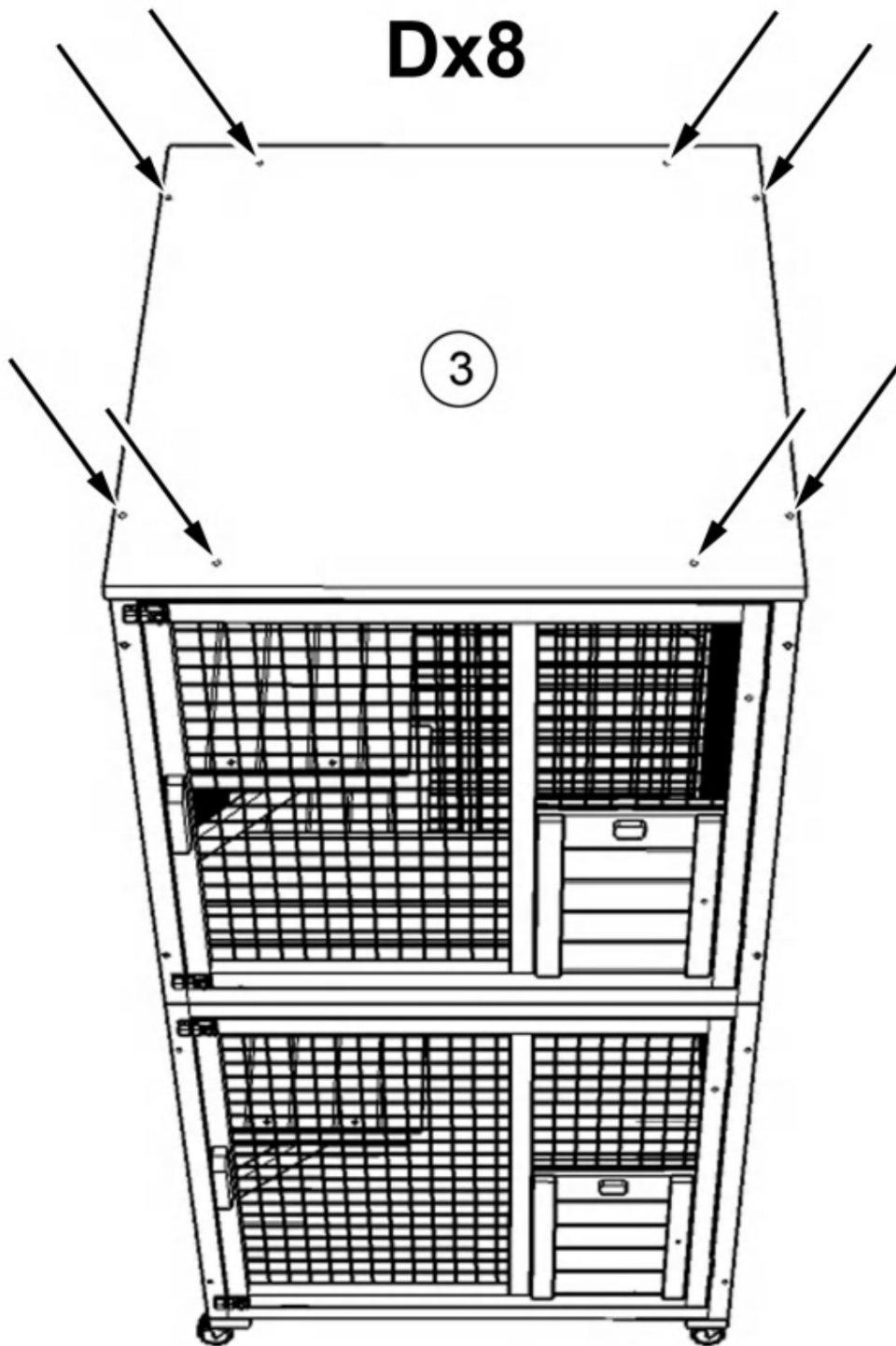

STEP:19

Shuangchenglu 803nong11hao1602A-1609shi, baoshanqu,
shanghai 200000 CN.



E-CrossStu GmbH.
Mainzer Landstr.69, 60329
Francfort-sur-le-Main.



YH CONSULTING LIMITÉE.
A/S YH Consulting Limited Bureau
147, Centurion House, London Road,
Staines-upon-Thames, Surrey, TW18 4AX

Importé aux États-Unis : Sanven Technology Ltd., Suite 250, 9166
Anaheim Place, Rancho Cucamonga, CA 91730

VEVOR[®]

TOUGH TOOLS, HALF PRICE

Technical Support and E-Warranty Certificate

www.vevor.com/support

VEVOR[®]

TOUGH TOOLS, HALF PRICE

Technical Support and E-Warranty Certificate www.vevor.com/support

INSTRUCTION FOR CAT CAGE

MODEL:CH470

Wir sind weiterhin bestrebt, Ihnen Werkzeuge zu wettbewerbsfähigen Preisen anzubieten. „Sparen Sie die Hälfte“, „Halber Preis“ oder andere ähnliche Ausdrücke, die wir verwenden, stellen nur eine Schätzung der Ersparnis dar, die Sie beim Kauf bestimmter Werkzeuge bei uns im Vergleich zu den großen Topmarken erzielen können, und decken nicht unbedingt alle von uns angebotenen Werkzeugkategorien ab. Wir möchten Sie freundlich daran erinnern, bei Ihrer Bestellung bei uns sorgfältig zu prüfen, ob Sie im Vergleich zu den großen Topmarken tatsächlich die Hälfte sparen.

VEVOR[®]
TOUGH TOOLS, HALF PRICE

CAT CAGE

CH470



NEED HELP? CONTACT US!

Have product questions? Need technical support? Please feel free to contact us:

Technischer Support und E-Garantie-Zertifikat www.vevor.com/support

This is the original instruction, please read all manual instructions carefully before operating. VEVOR reserves a clear interpretation of our user manual. The appearance of the product shall be subject to the product you received. Please forgive us that we won't inform you again if there are any technology or software updates on our product.

WARNING:

Read this material before using this product. Failure to do so can result in serious injury.

Assembly precautions

1. Assemble only according to these instructions. Improper assembly can create hazards.
2. In order to ensure your own safety, please make sure to ANSI-approved safety goggles and heavy-duty work gloves when installing this product.
3. Keep the assembly area clean and well lit.
4. Keep bystanders out of the area during assembly.
5. Do not assemble when tired or when under the influence of alcohol, drugs or medication.
6. Product capabilities apply to properly and completely assembled product only.
7. Assemble on a flat, level, hard and smooth surface capable of safely supporting a fully loaded cat cage.

Use precautions

TO PREVENT SERIOUS INJURY AND DEATH FROM TIPPING:

1. DO NOT SIT OR STAND ON THIS ITEM.
2. This product is not a toy. Do not allow children to play with or near this item. Please keep small spare parts out of children's reach.
3. Use only on a flat, level, hard and smooth surface capable of safely supporting a fully loaded cat cage.
4. Use as intended only.
5. Inspect before every use; do not use if parts are loose or damaged.

SAVE THESE INSTRUCTIONS

SPECIFICATIONS

Model	CH470
Product Size	760×865×1630mm
Color	Gray

COMPONENTS

Notice:

1. Various specifications of screws are used in the installation of this product. Pay attention to the correct use of screw specifications according to the instruction manual.
2. Please wear gloves when installing.

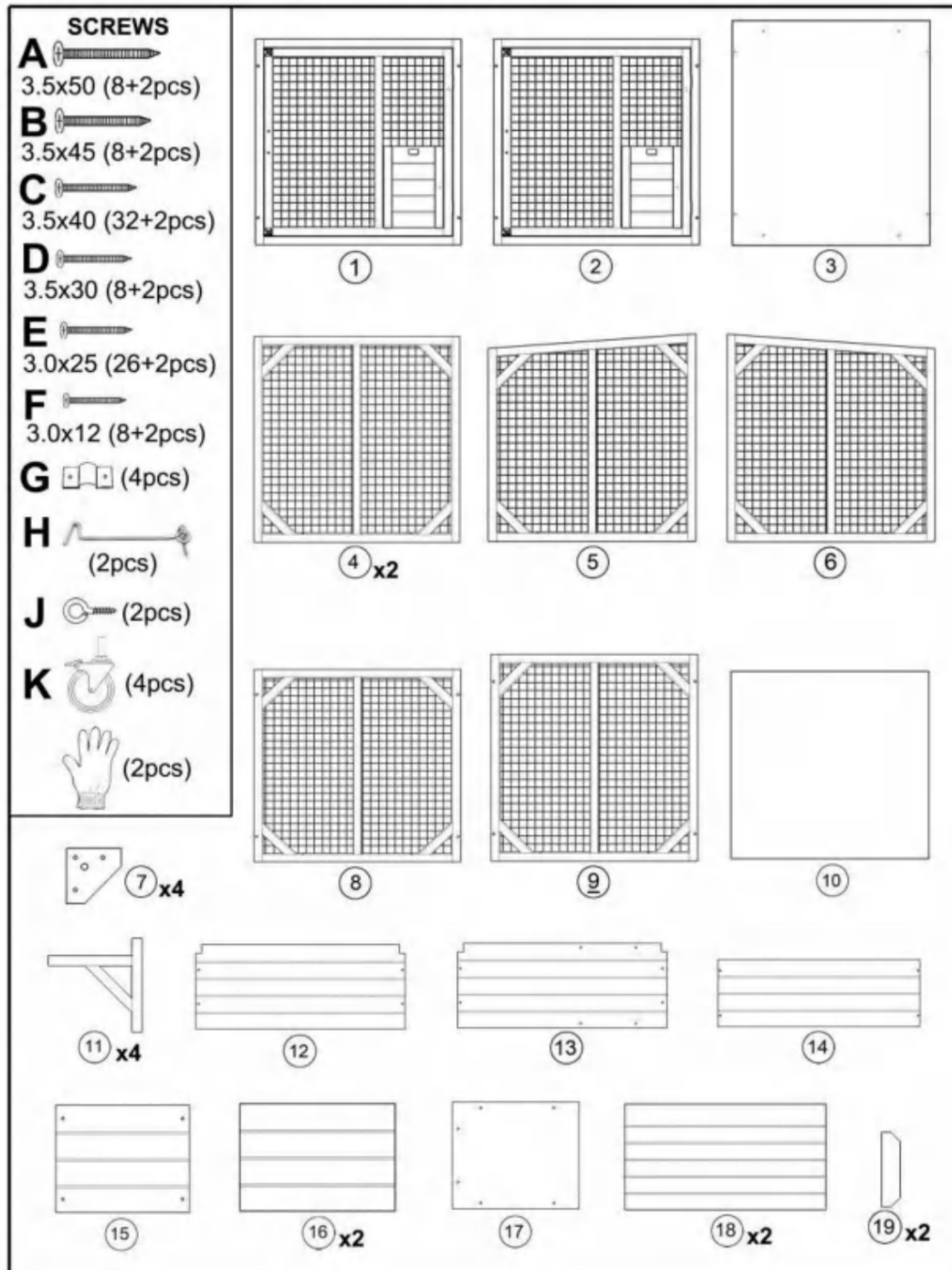

Assembly Instructions

Please be noted that the side with wire nailed on is back side, should be inward when installation

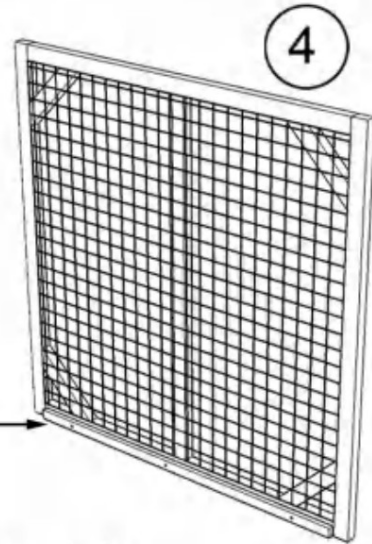

This end with a long piece of wood is placed at bottom

Assembling part #4x2 and part #1 with screws (C)x4 as shown below

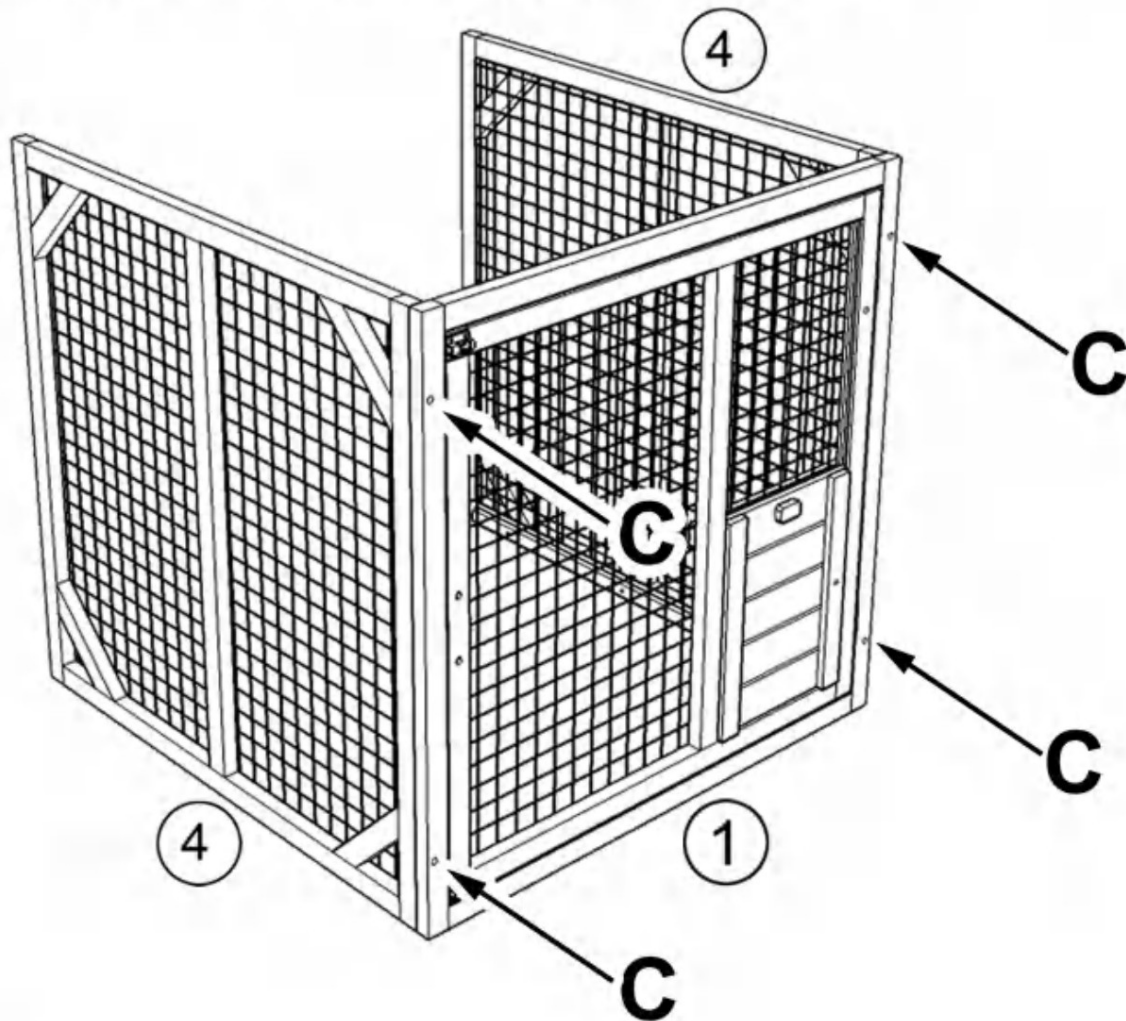

STEP:1

The part #2 (open the door) and part #5 has pre-drilled holes at bottom as shown, assemble part #2 and part #5 with screws (C)x2, then place them on the parts finished in last step and secure them with screws (A)x4 downwards

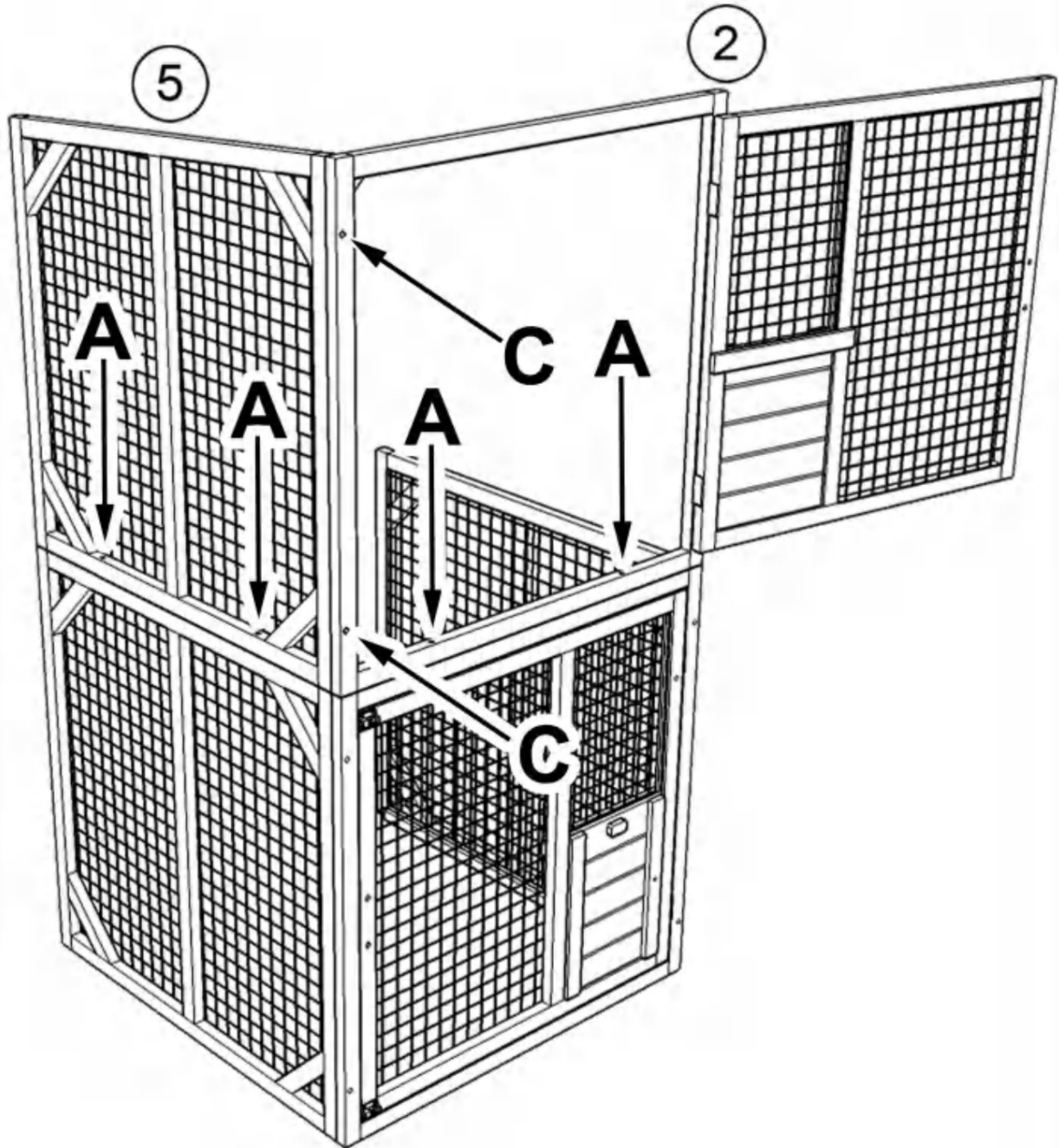

STEP:2

The part #6 has 2 pre-drilled holes at bottom, assembling part #6 with screws (C)x2 as shown and secure it to lower part with screws (A)x2 downwards

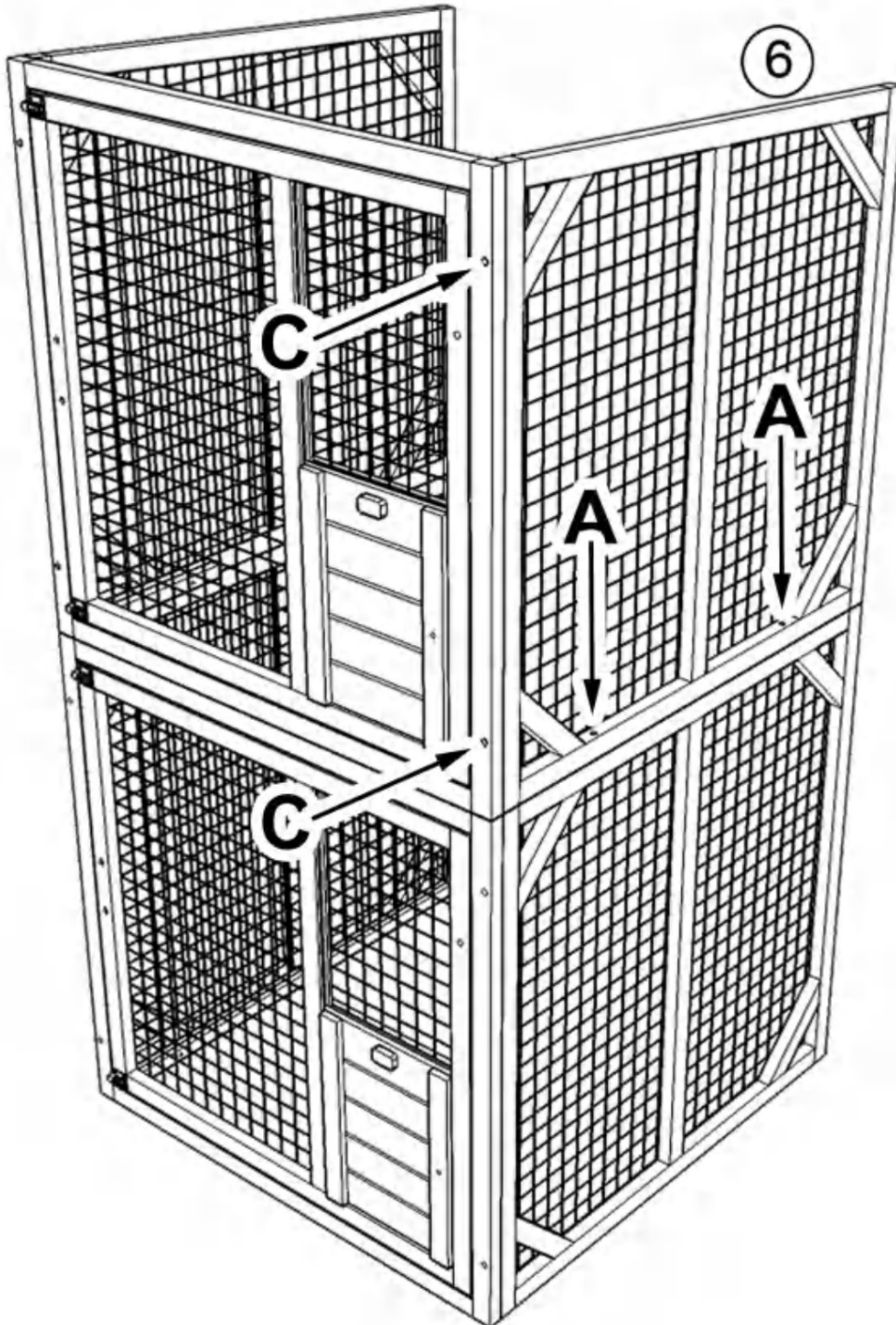

STEP:3

Assembling shelf with part #12 and part #11x2 by screws (E)x4 as shown

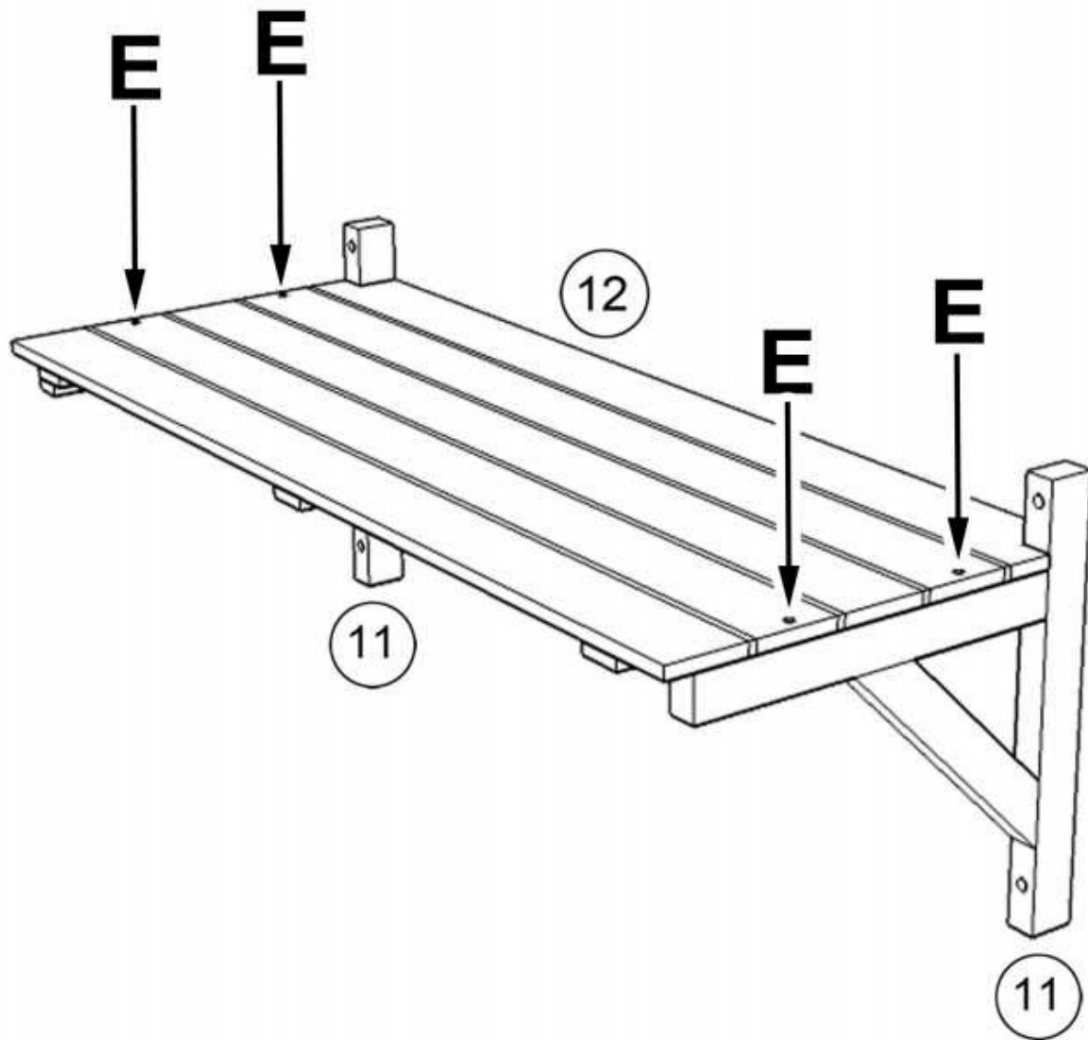

STEP:4

Mounting the shelf on right side as shown by screws (B)x4 at your preferred height

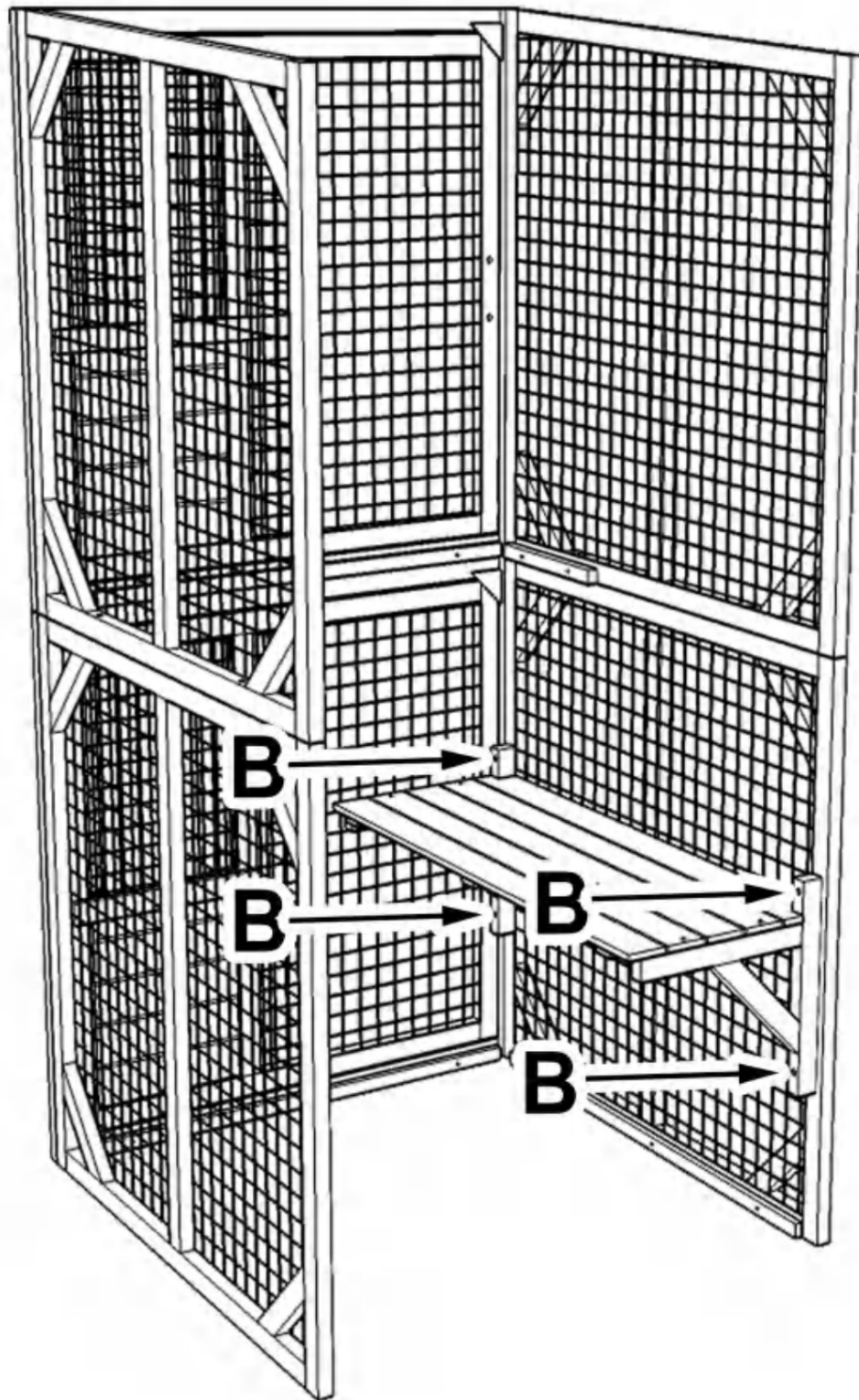

STEP:5

Placing part #14 on the short wood pieces on left and right side and secure it with screw (E)x4

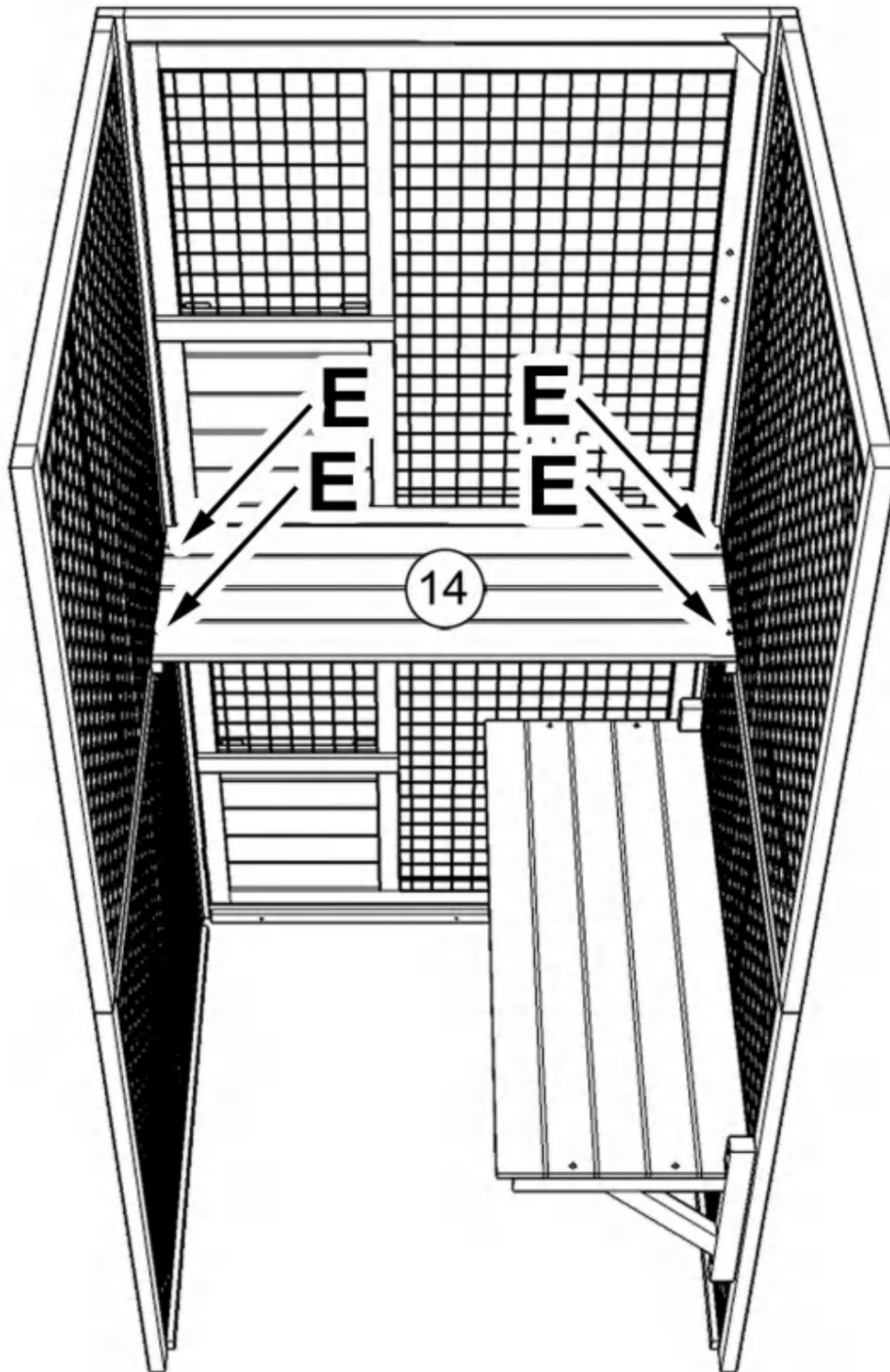

STEP:6

Assembling shelf with part #13 and part #11x2 by screws (E)x4 as shown

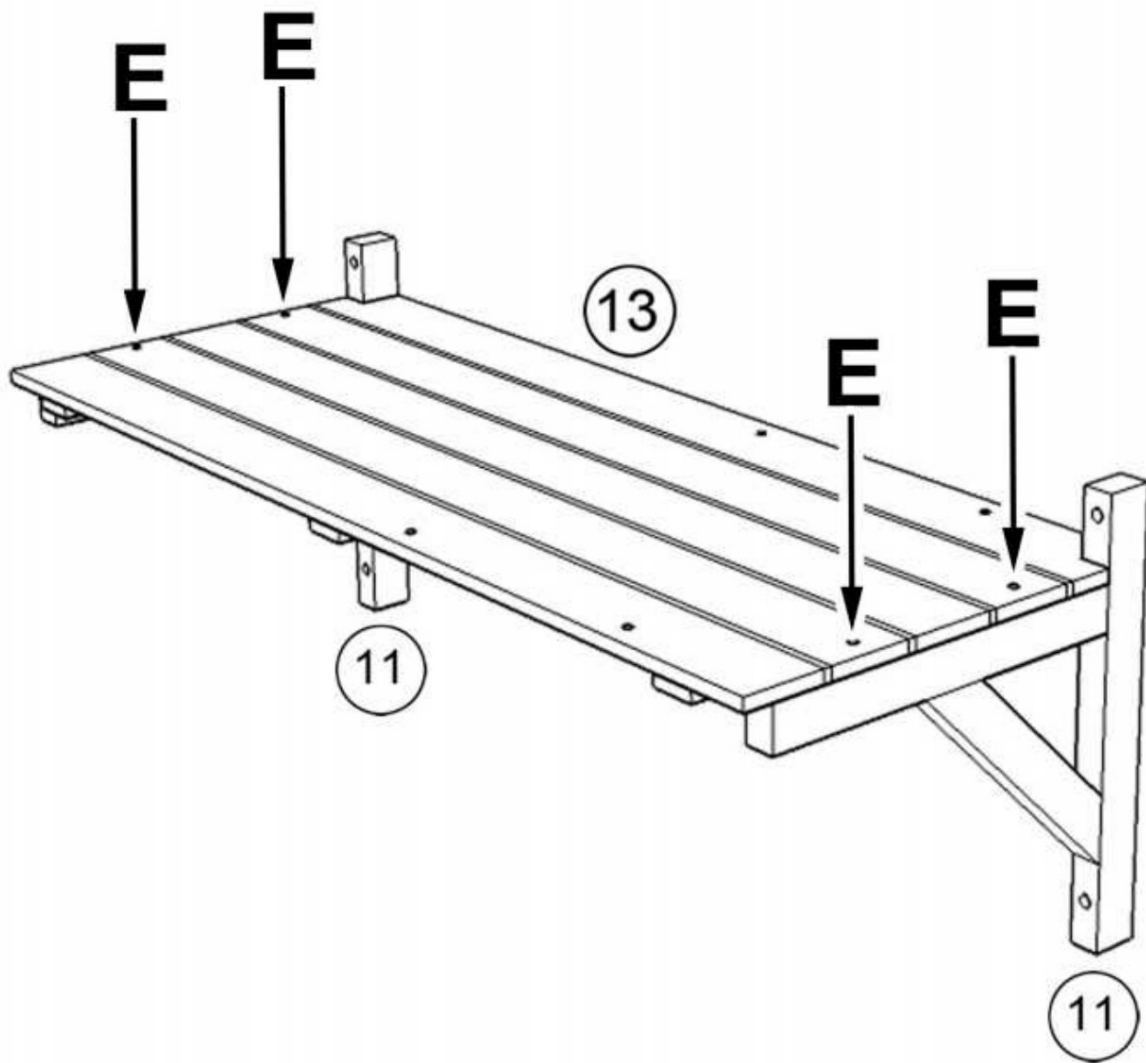

STEP:7

Mounting the shelf to the right side of board as shown with screws (B)x4 at your preferred height

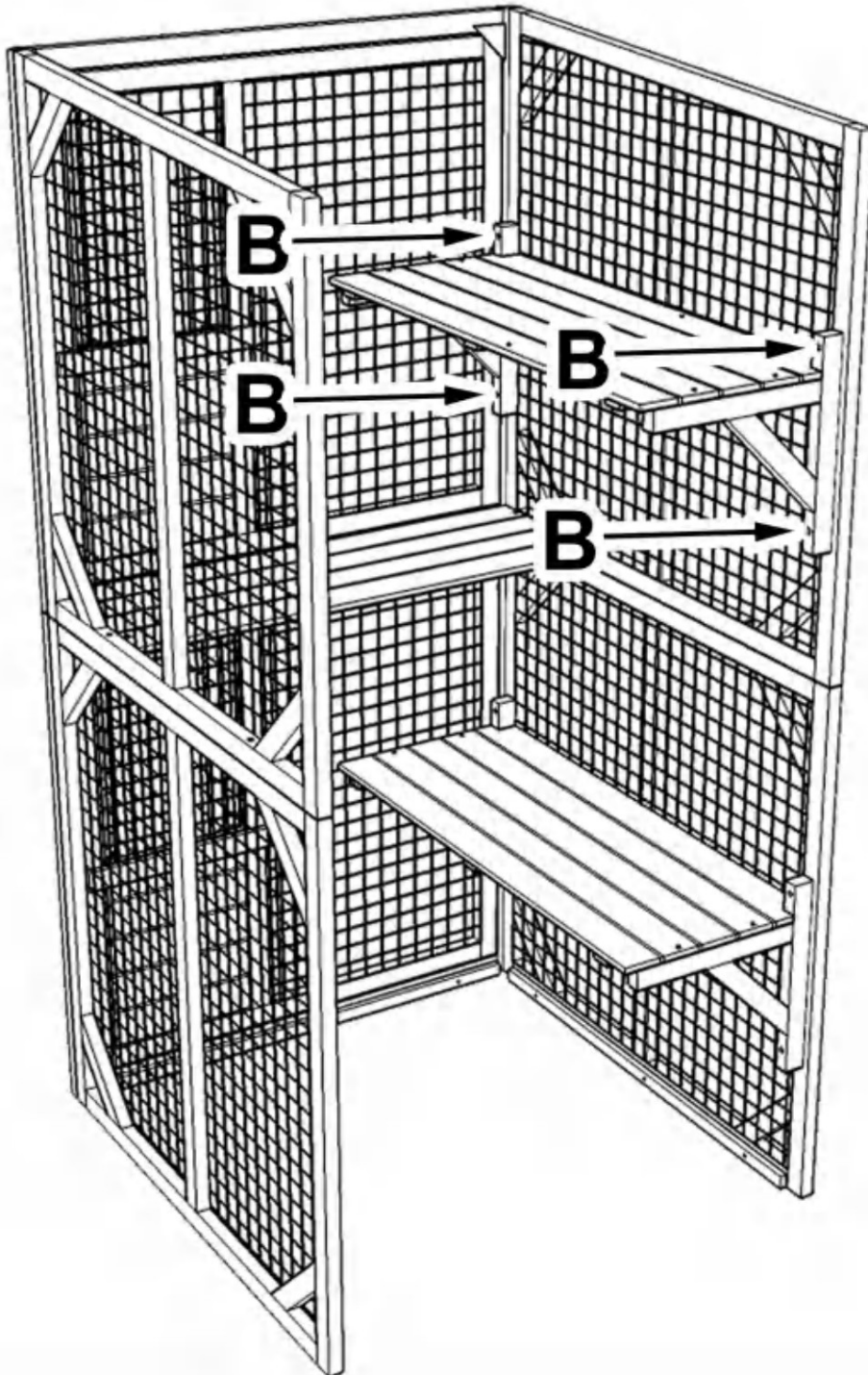

STEP:8

Assembling sleeping box with part #16x2, #17, #15 using screws (E)x10

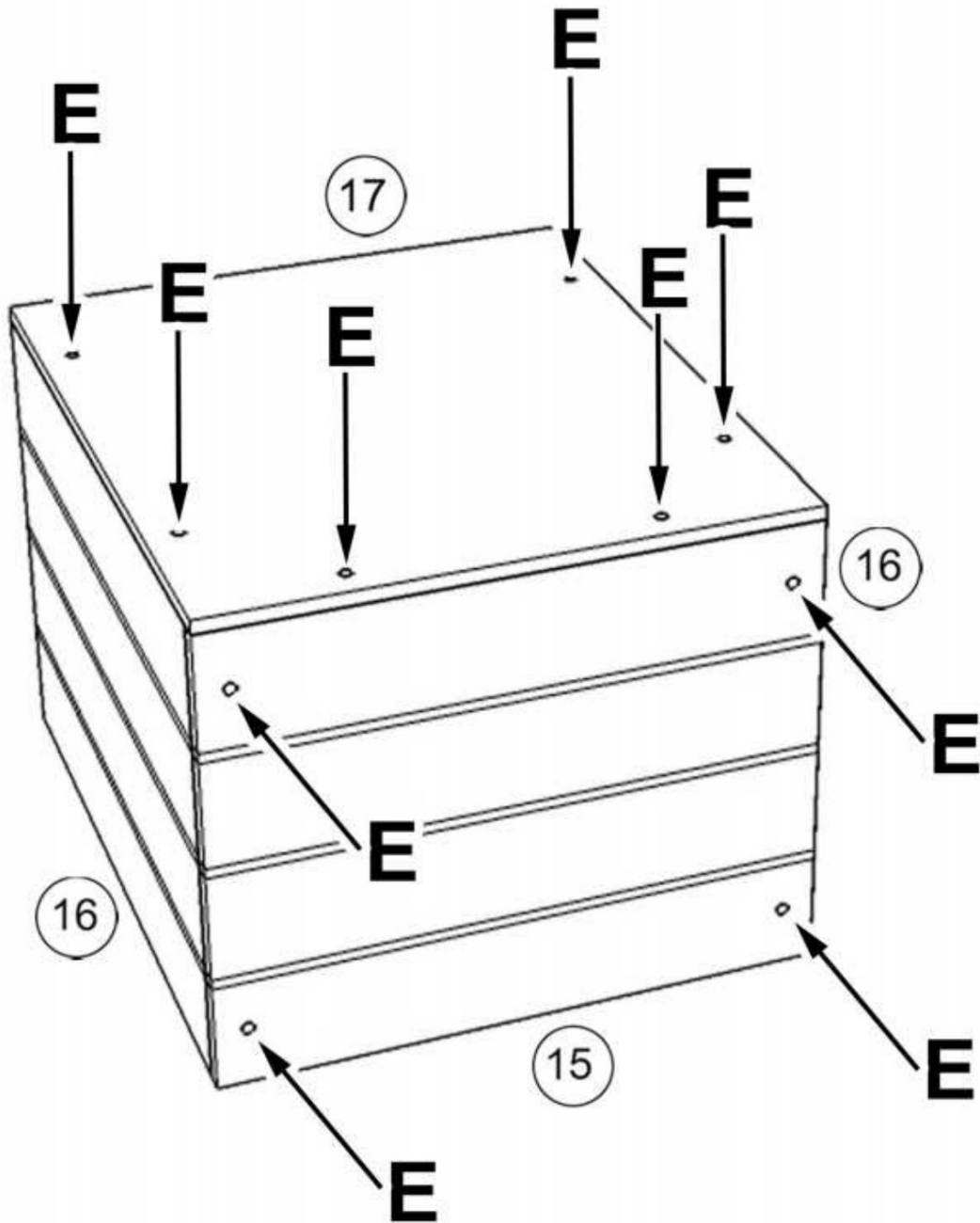

STEP:9

Placing sleeping box on the top of shelf as shown and secure it with screws (E)x4 from the bottom of shelf

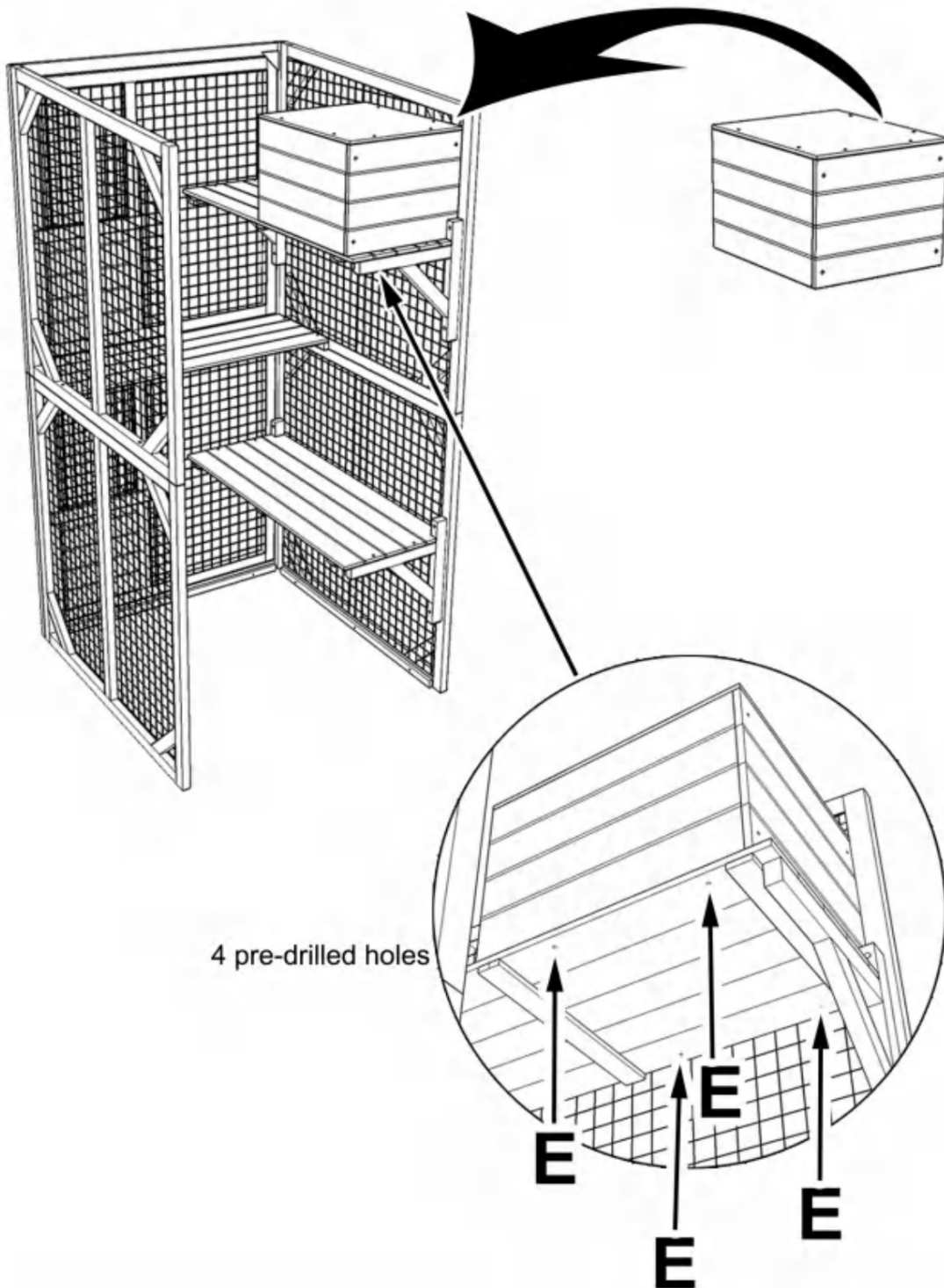

STEP:10

Assembling firstly part #9 (bottom) and then part #8 (2 holes at bottom) with screws (C)x8, then secure the 2 parts by screwing (A)x2 downwards as shown

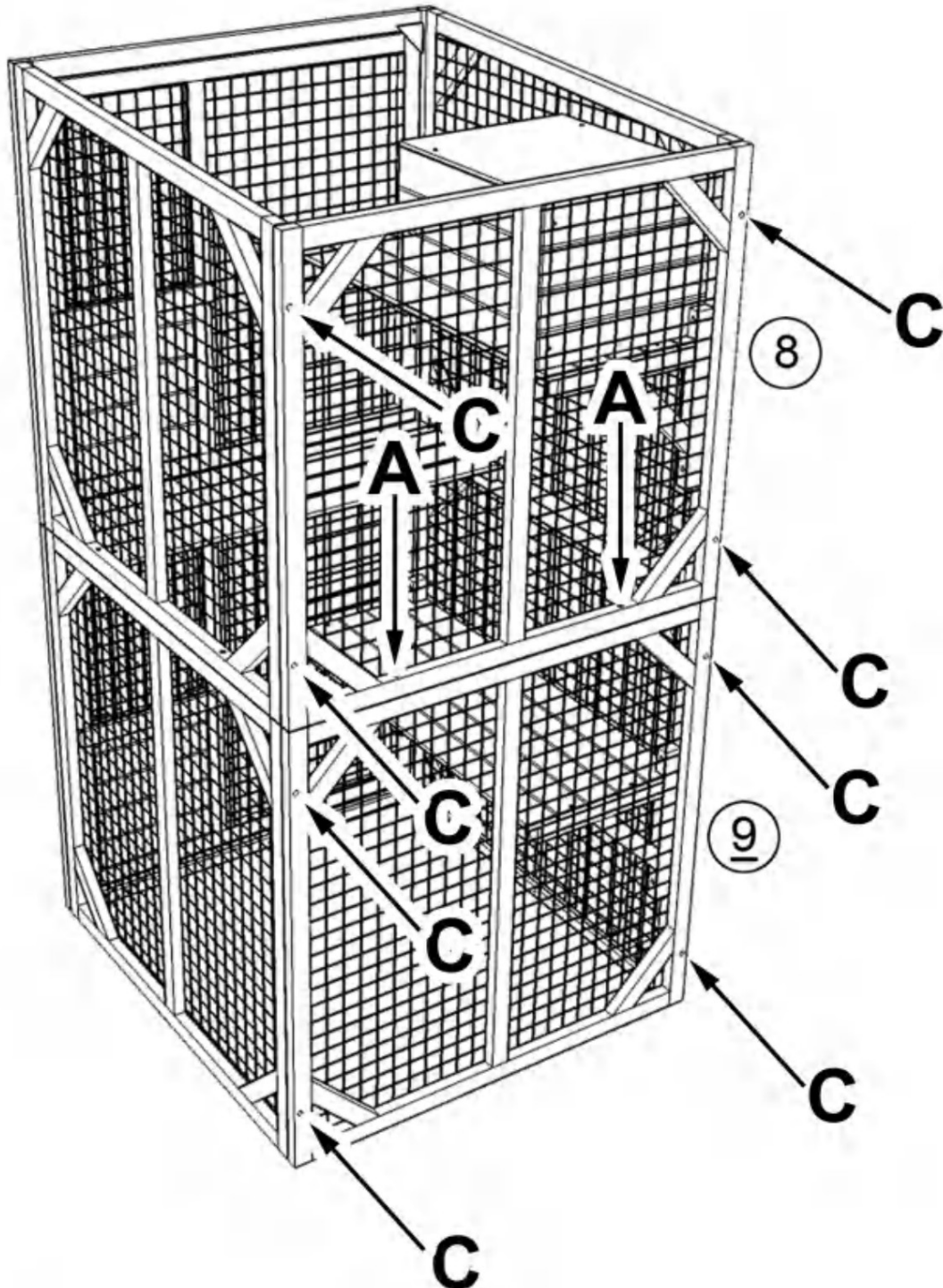

STEP:11

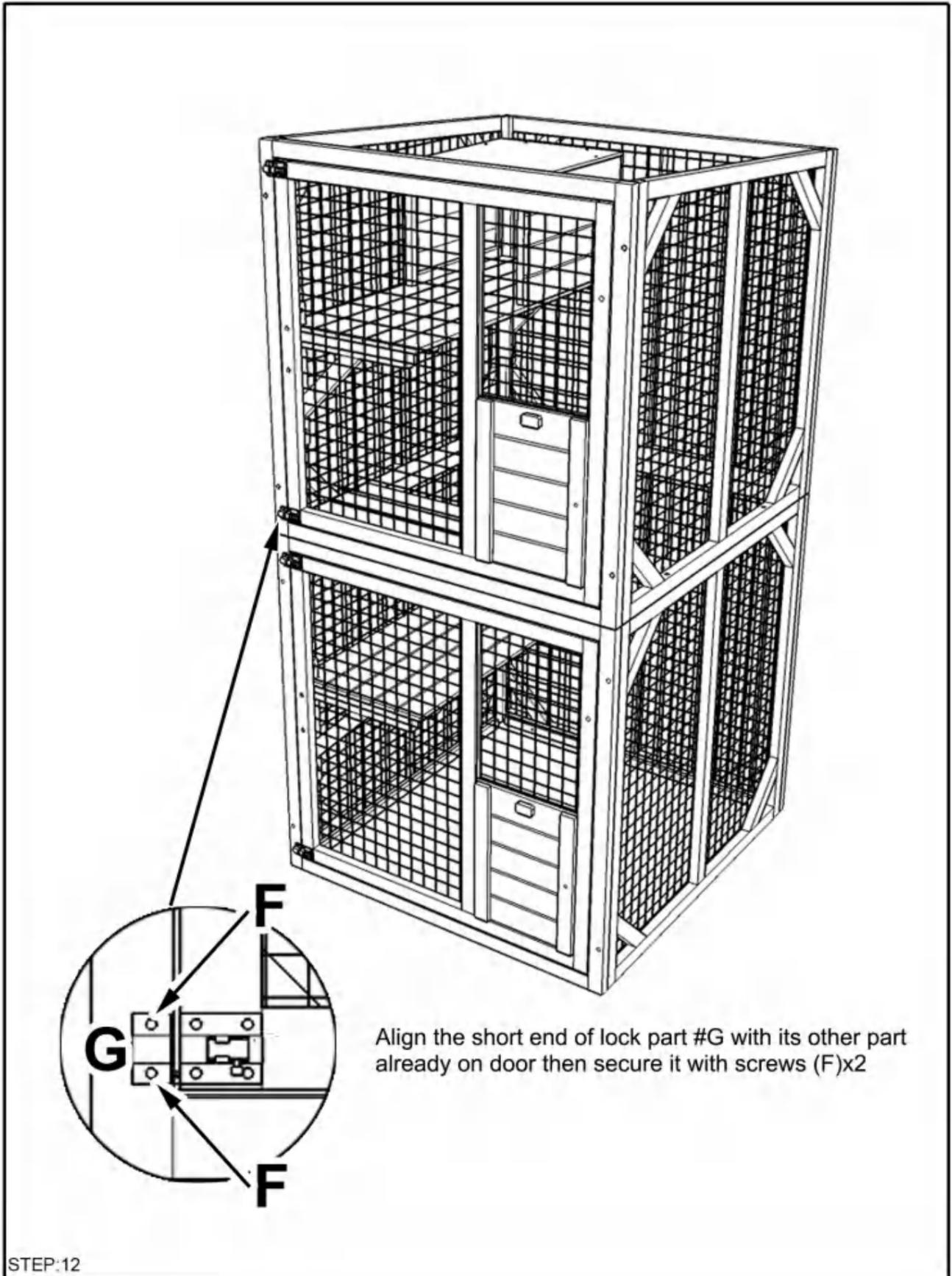

Align the short end of lock part #G with its other part already on door then secure it with screws (F)x2

STEP:12

Install handles parts #19x2 on doors with screws (C)x4 as shown

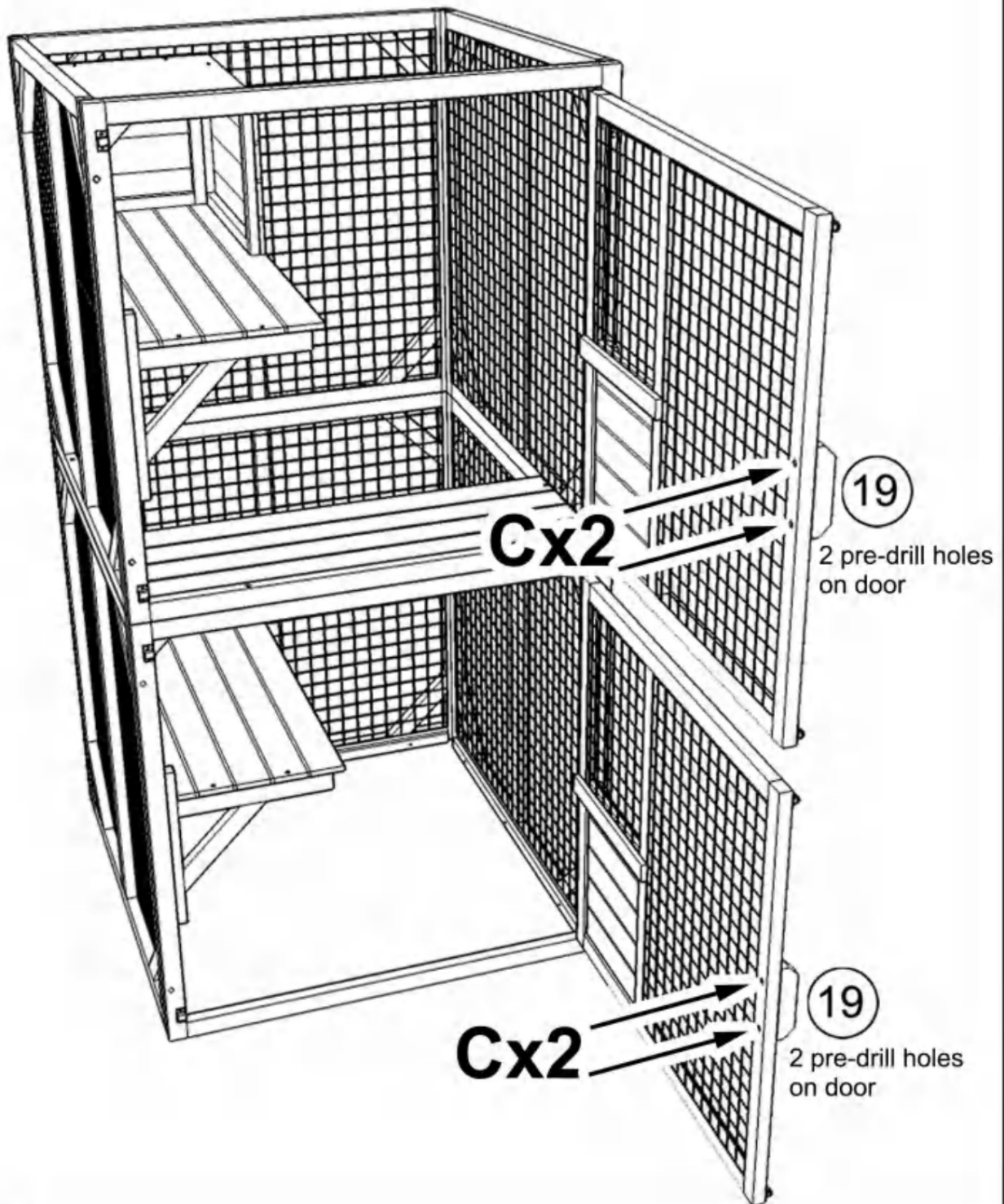

STEP:13

Install hooks as shown, long part is on the sliding door, short part is on the frame wood

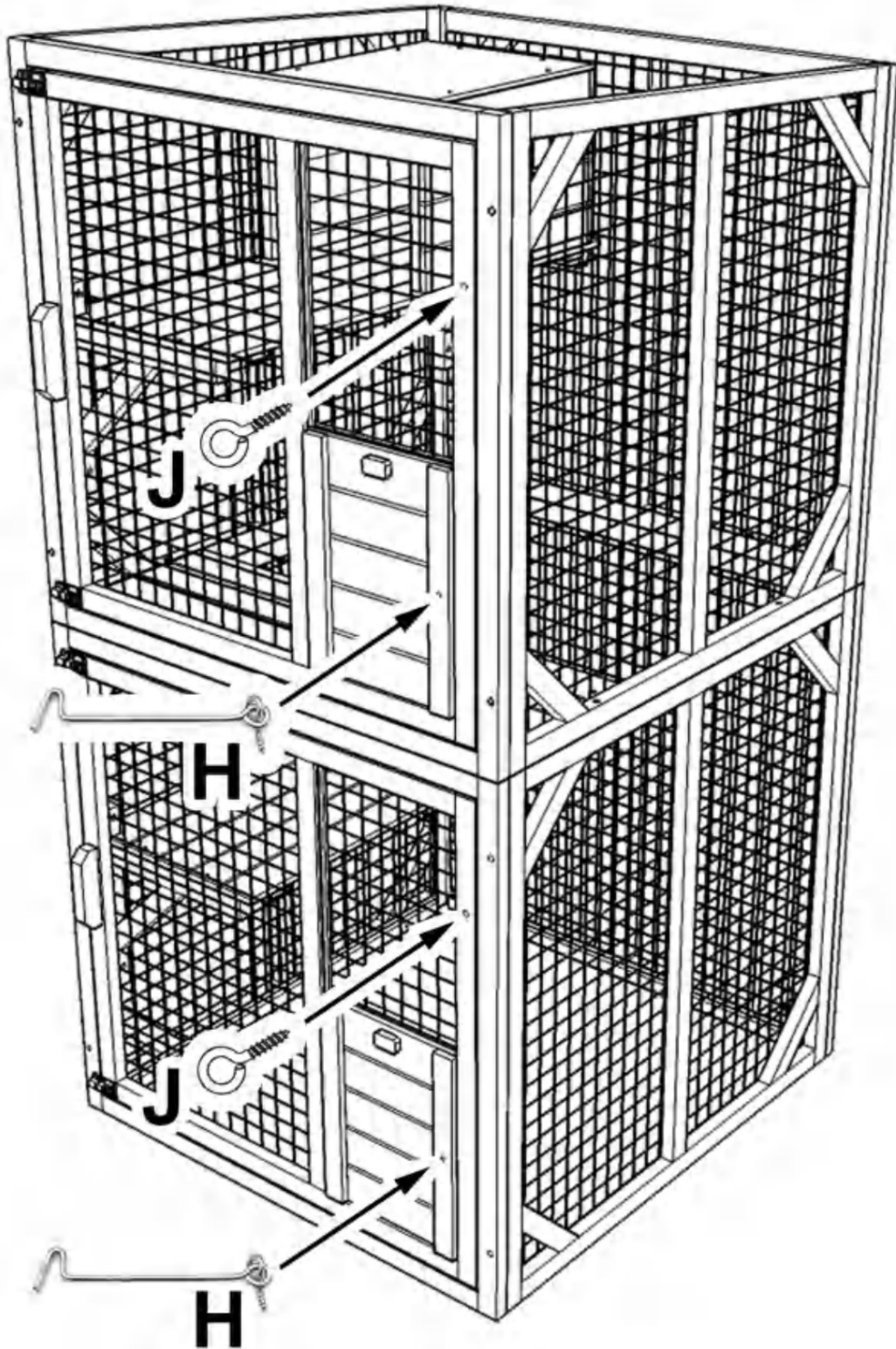

STEP:14

Gently let down the product, install part #7x4 as shown by screws (C)x12

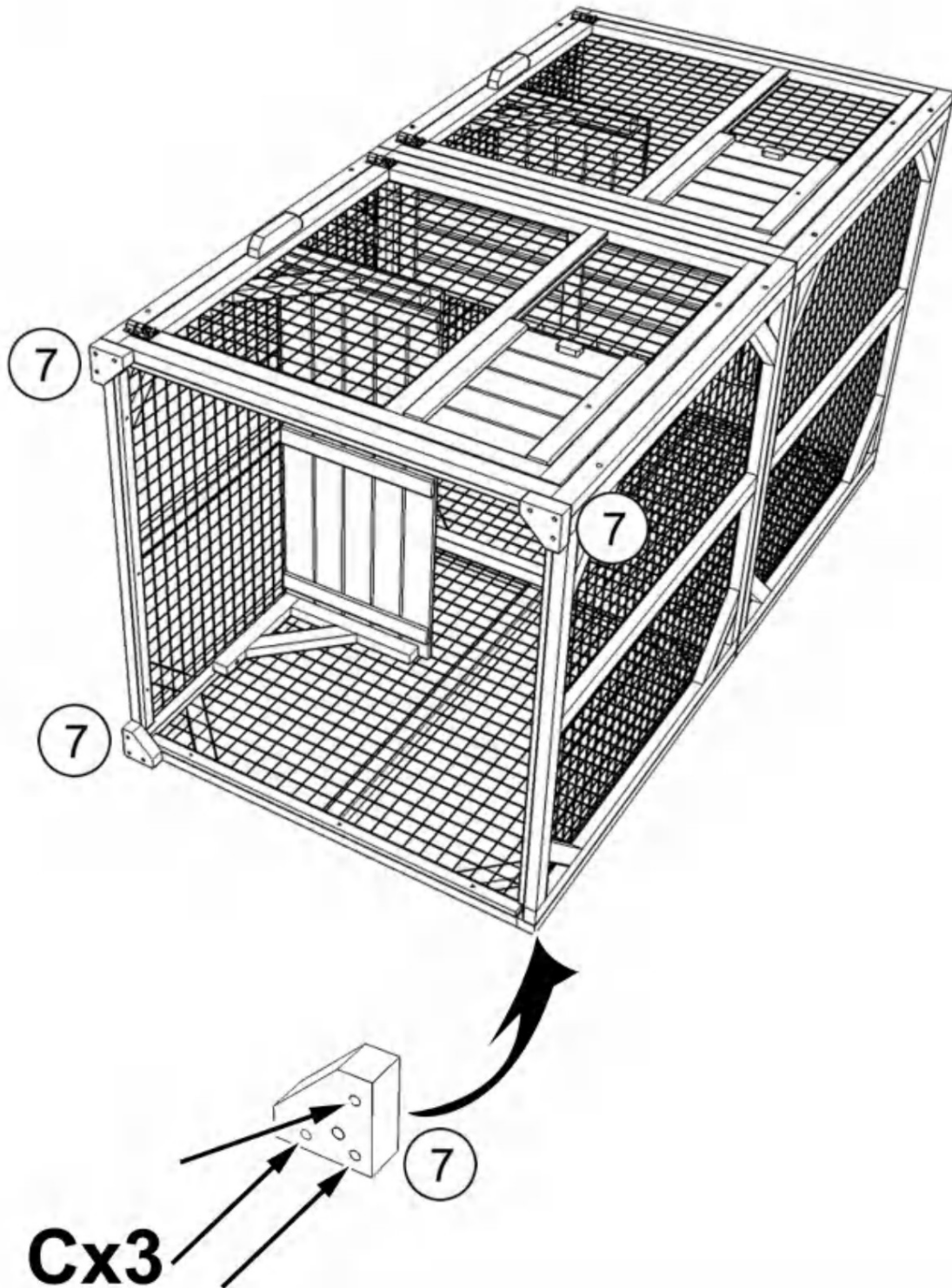

STEP:15

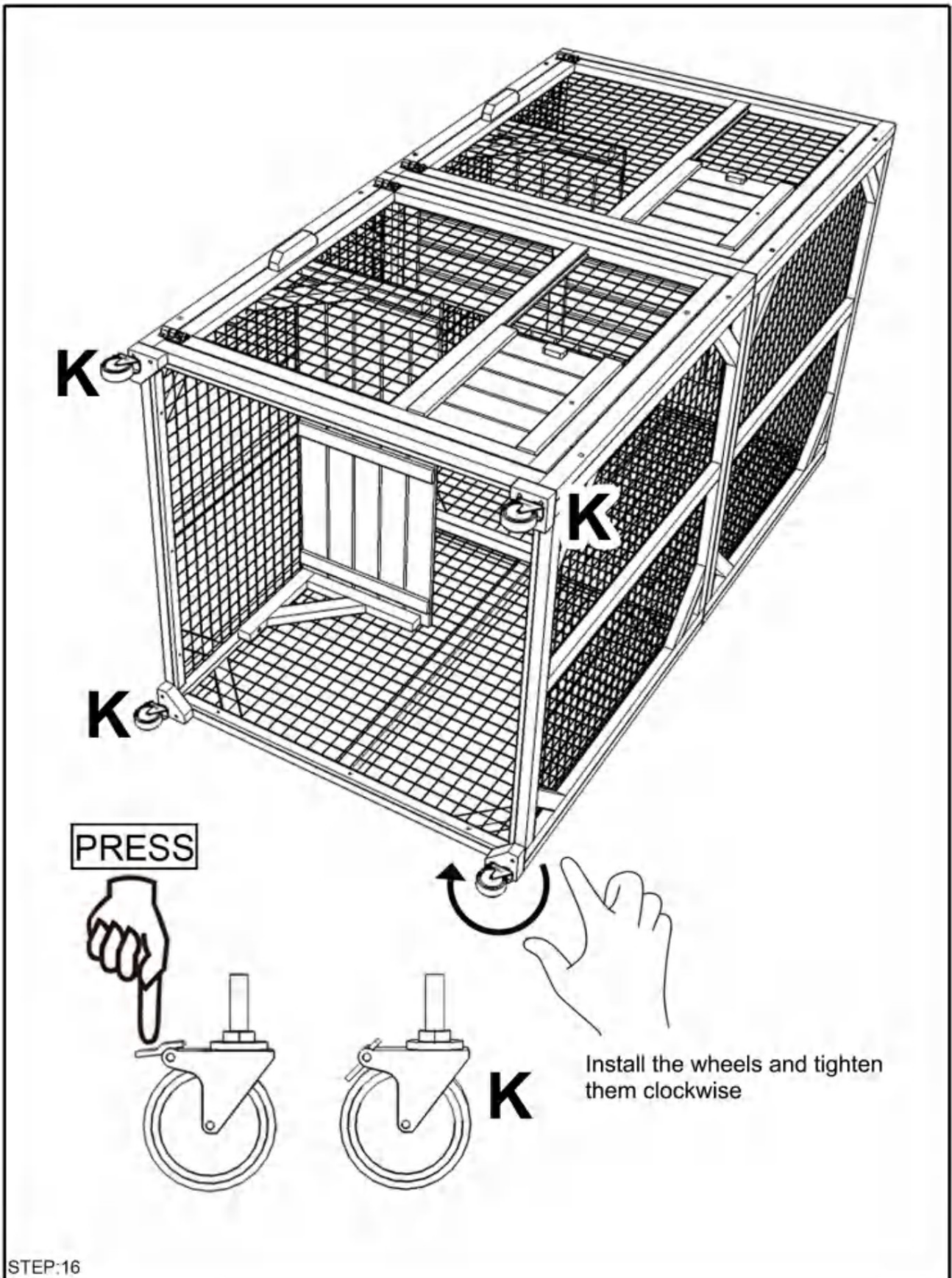

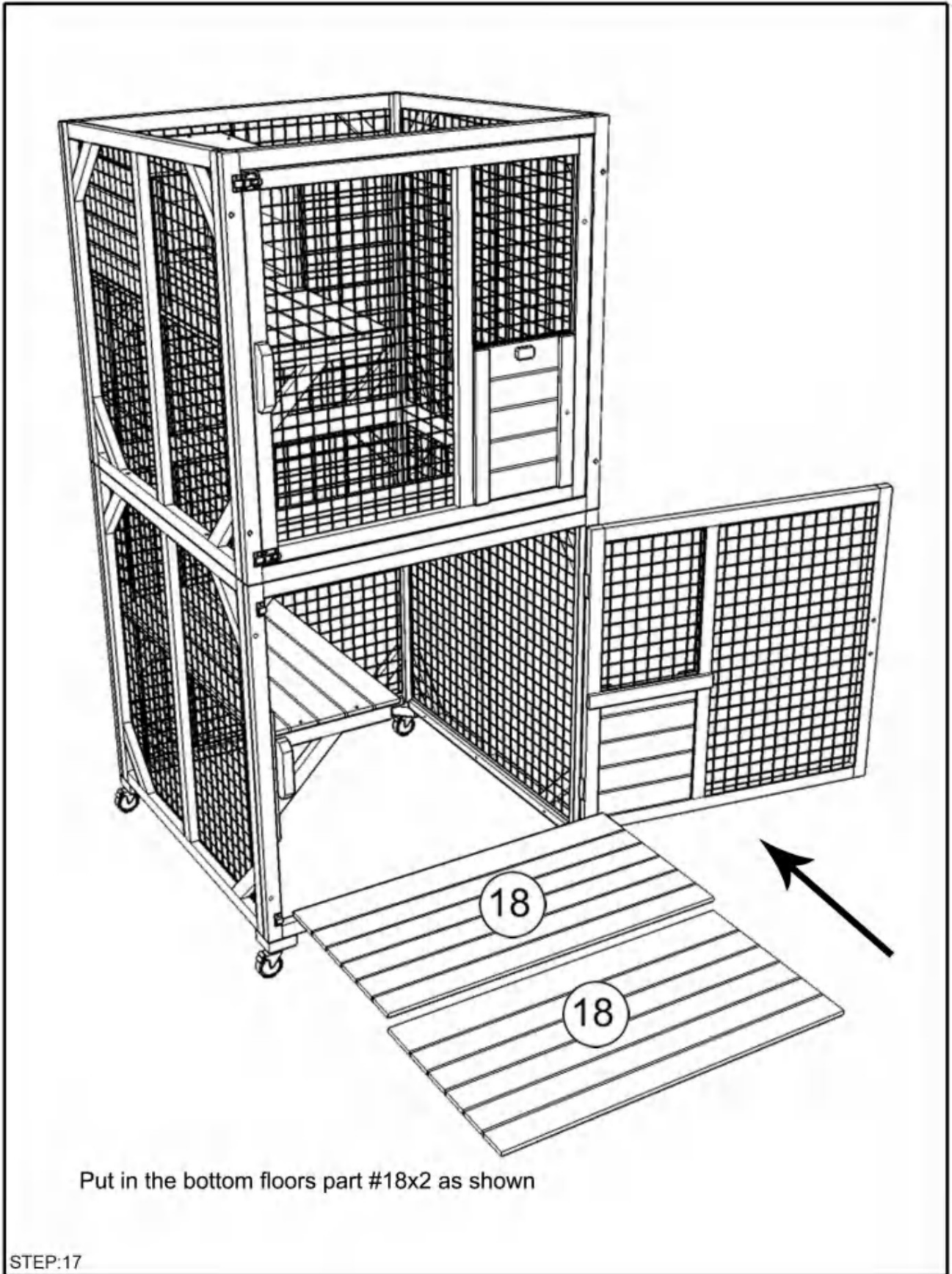

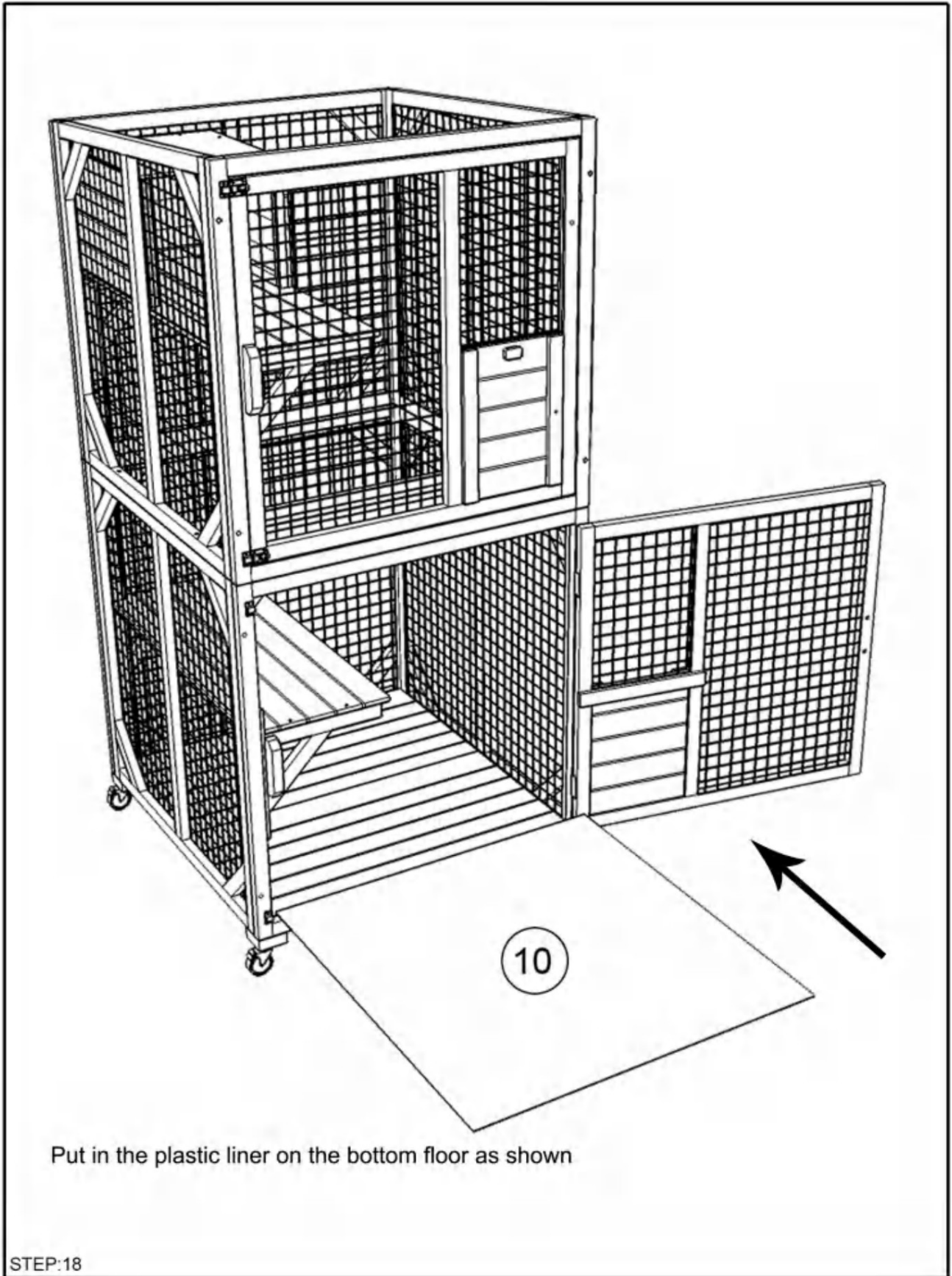

Install the felted roof part #3 with screws (D)x8

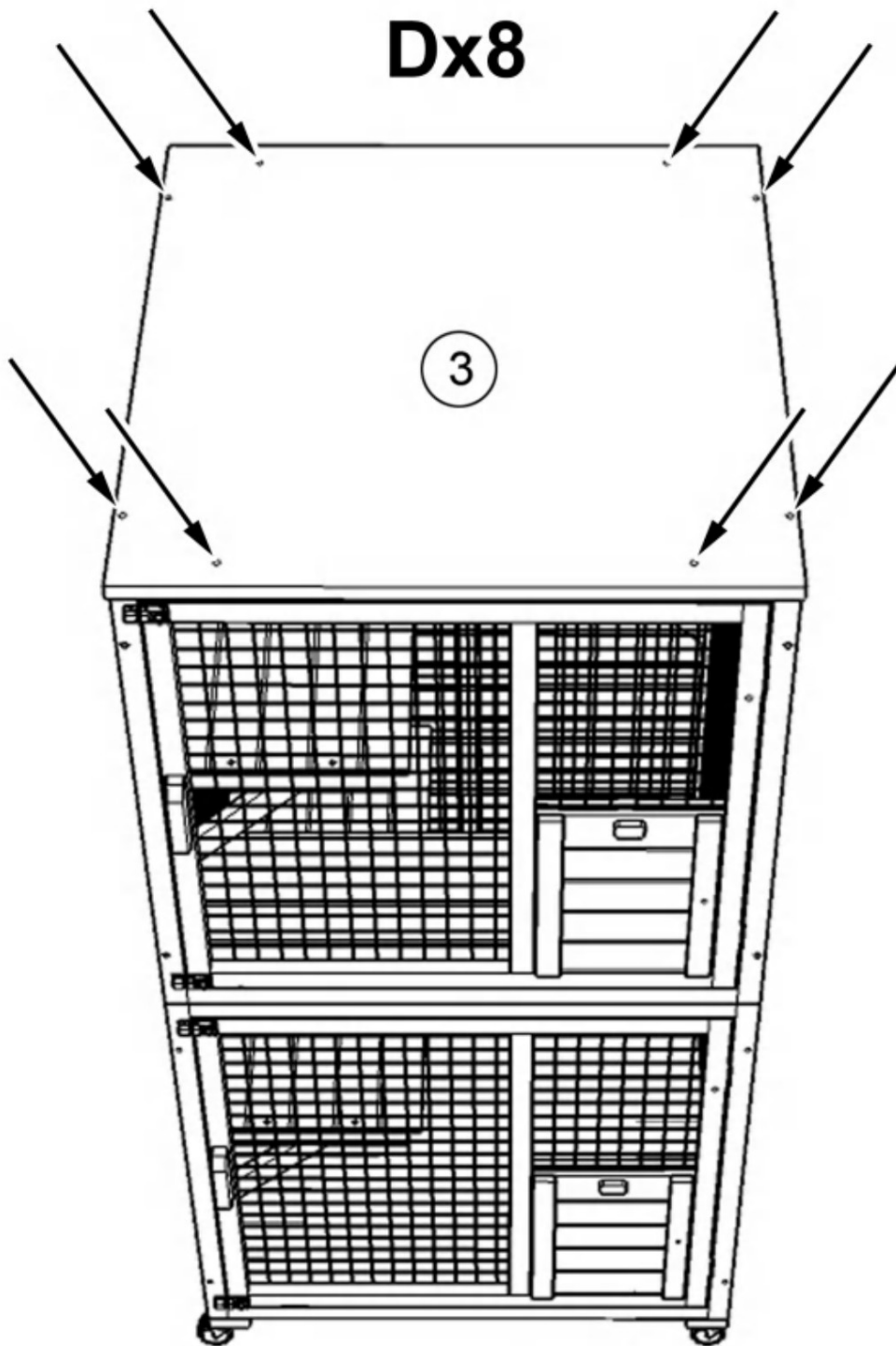

STEP:19

Shuangchenglu 803nong11hao1602A-1609shi, baoshanqu,
Shanghai 200000 CN.



E-CrossStu GmbH.
Mainzer Landstr.69, 60329
Frankfurt am Main.



YH CONSULTING LIMITED.
C/O YH Consulting Limited Office
147, Centurion House, London Road,
Staines-upon-Thames, Surrey, TW18 4AX

Importiert in die USA: Sanven Technology Ltd., Suite 250, 9166
Anaheim Place, Rancho Cucamonga, CA 91730

VEVOR[®]

TOUGH TOOLS, HALF PRICE

Technical Support and E-Warranty Certificate

www.vevor.com/support

VEVOR[®]

TOUGH TOOLS, HALF PRICE

Technical Support and E-Warranty Certificate www.vevor.com/support

INSTRUCTION FOR CAT CAGE

MODEL:CH470

Nadal staramy się oferować Państwu narzędzia w konkurencyjnych cenach. „Oszczędź połowę”, „Połowa ceny” lub inne podobne wyrażenia używane przez nas stanowią jedynie szacunkowe oszczędności, jakie możesz uzyskać, kupując u nas określone narzędzia w porównaniu z głównymi markami i niekoniecznie oznaczają one objęcie wszystkich kategorii narzędzi oferowanych przez nas. Uprzejmie przypominamy, aby dokładnie sprawdzić, czy składając u nas zamówienie faktycznie oszczędzasz połowę w porównaniu z głównymi markami.

VEVOR[®]
TOUGH TOOLS, HALF PRICE

CAT CAGE

CH470



NEED HELP? CONTACT US!

Have product questions? Need technical support? Please feel free to contact us:

Wsparcie techniczne i certyfikat gwarancji elektronicznej www.vevor.com/support

This is the original instruction, please read all manual instructions carefully before operating. VEVOR reserves a clear interpretation of our user manual. The appearance of the product shall be subject to the product you received. Please forgive us that we won't inform you again if there are any technology or software updates on our product.

WARNING:

Read this material before using this product. Failure to do so can result in serious injury.

Assembly precautions

1. Assemble only according to these instructions. Improper assembly can create hazards.
2. In order to ensure your own safety, please make sure to ANSI-approved safety goggles and heavy-duty work gloves when installing this product.
3. Keep the assembly area clean and well lit.
4. Keep bystanders out of the area during assembly.
5. Do not assemble when tired or when under the influence of alcohol, drugs or medication.
6. Product capabilities apply to properly and completely assembled product only.
7. Assemble on a flat, level, hard and smooth surface capable of safely supporting a fully loaded cat cage.

Use precautions

TO PREVENT SERIOUS INJURY AND DEATH FROM TIPPING:

1. DO NOT SIT OR STAND ON THIS ITEM.
2. This product is not a toy. Do not allow children to play with or near this item. Please keep small spare parts out of children's reach.
3. Use only on a flat, level, hard and smooth surface capable of safely supporting a fully loaded cat cage.
4. Use as intended only.
5. Inspect before every use; do not use if parts are loose or damaged.

SAVE THESE INSTRUCTIONS

SPECIFICATIONS

Model	CH470
Product Size	760×865×1630mm
Color	Gray

COMPONENTS

Notice:

1. Various specifications of screws are used in the installation of this product. Pay attention to the correct use of screw specifications according to the instruction manual.
2. Please wear gloves when installing.

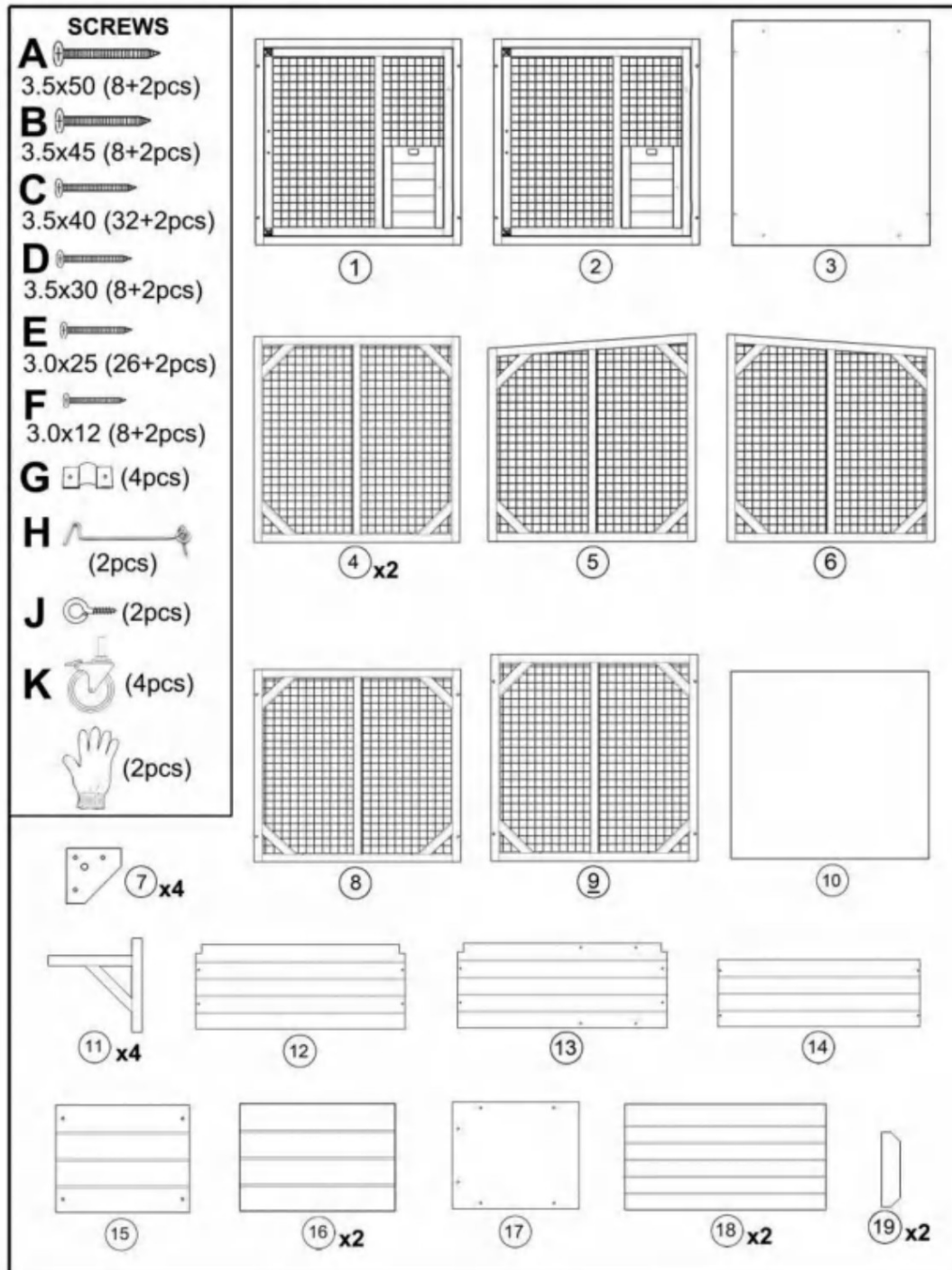

Assembly Instructions

Please be noted that the side with wire nailed on is back side, should be inward when installation

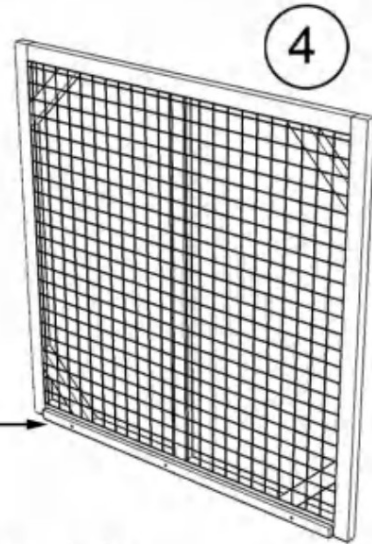

This end with a long piece of wood is placed at bottom

Assembling part #4x2 and part #1 with screws (C)x4 as shown below

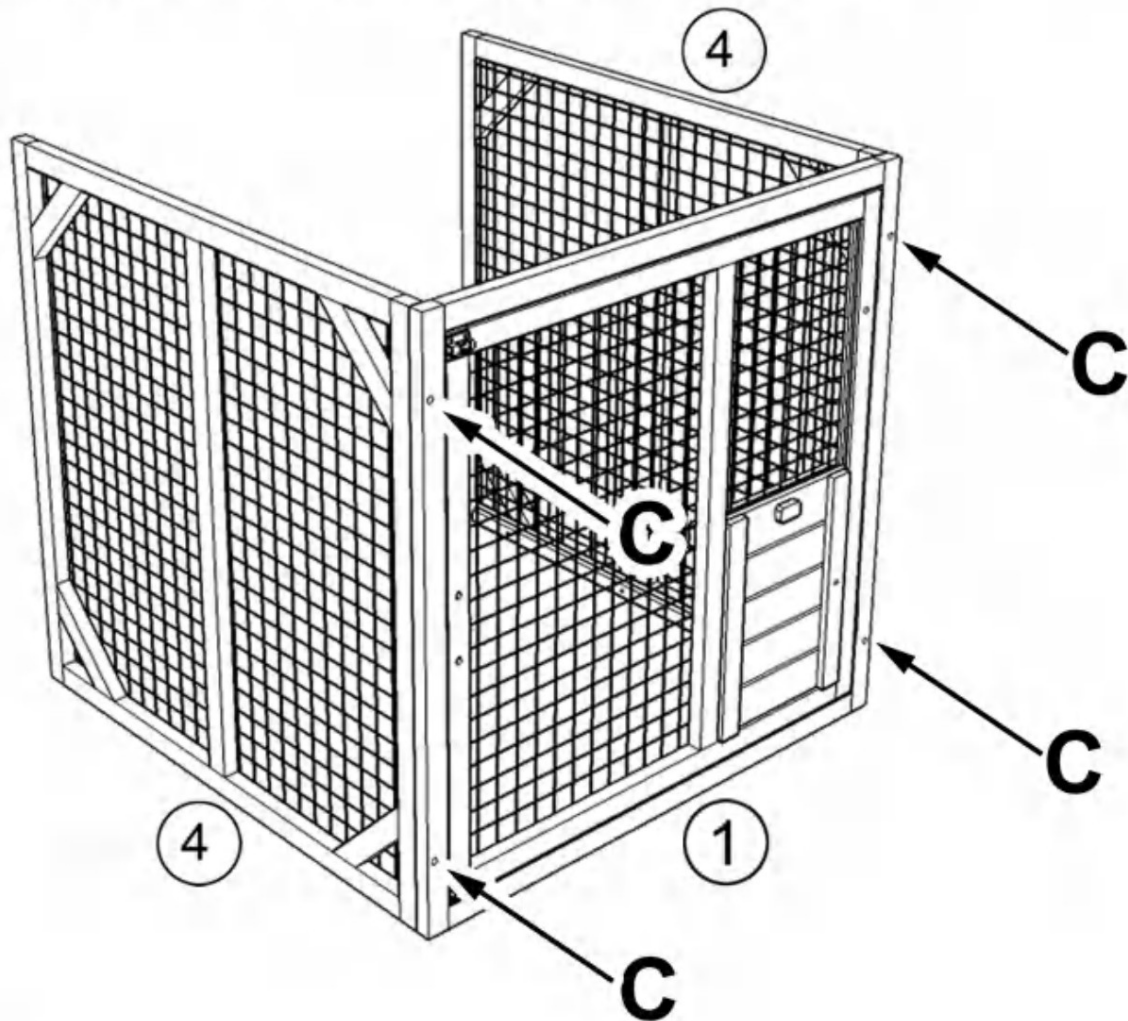

STEP:1

The part #2 (open the door) and part #5 has pre-drilled holes at bottom as shown, assemble part #2 and part #5 with screws (C)x2, then place them on the parts finished in last step and secure them with screws (A)x4 downwards

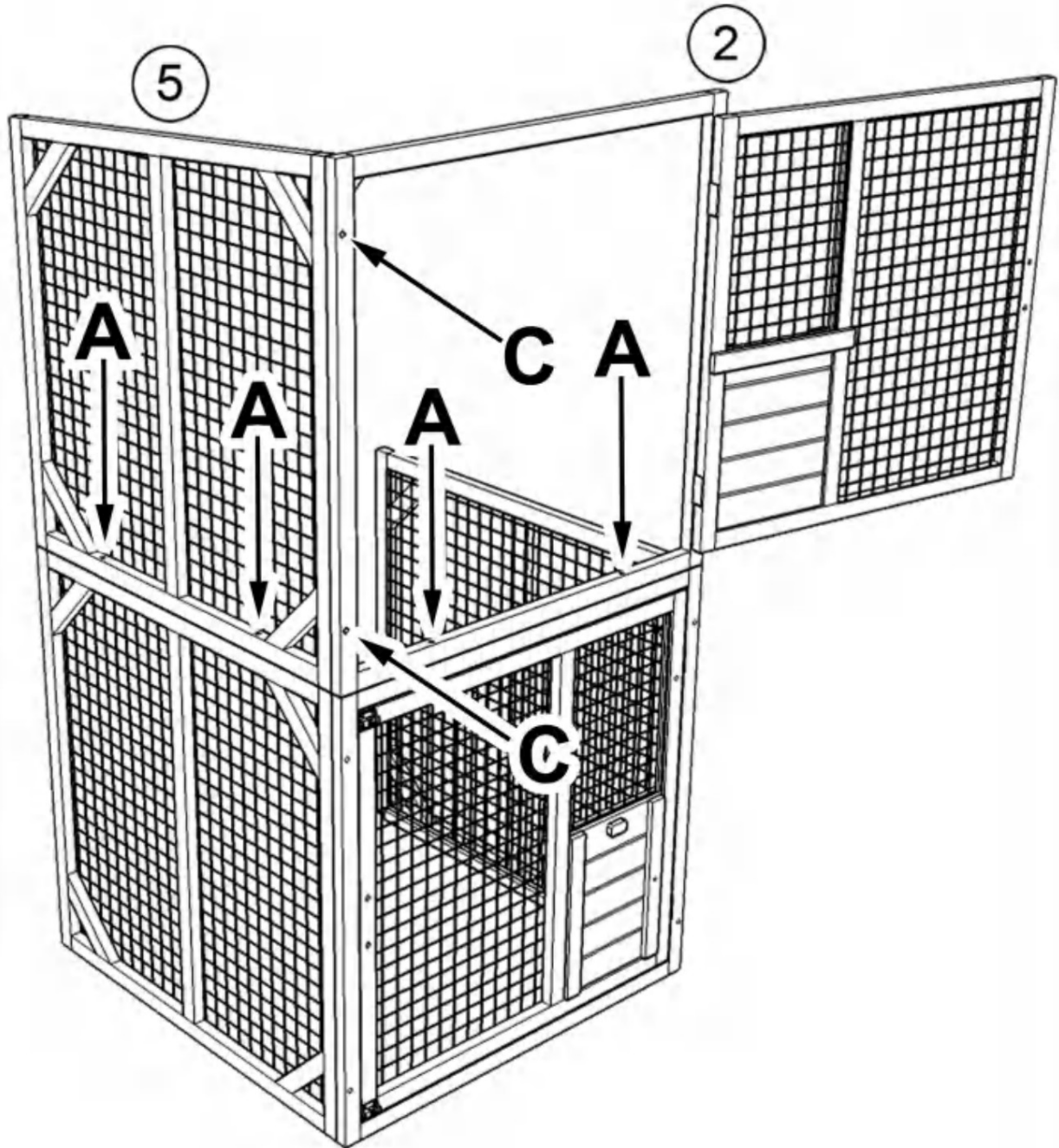

STEP:2

The part #6 has 2 pre-drilled holes at bottom, assembling part #6 with screws (C)x2 as shown and secure it to lower part with screws (A)x2 downwards

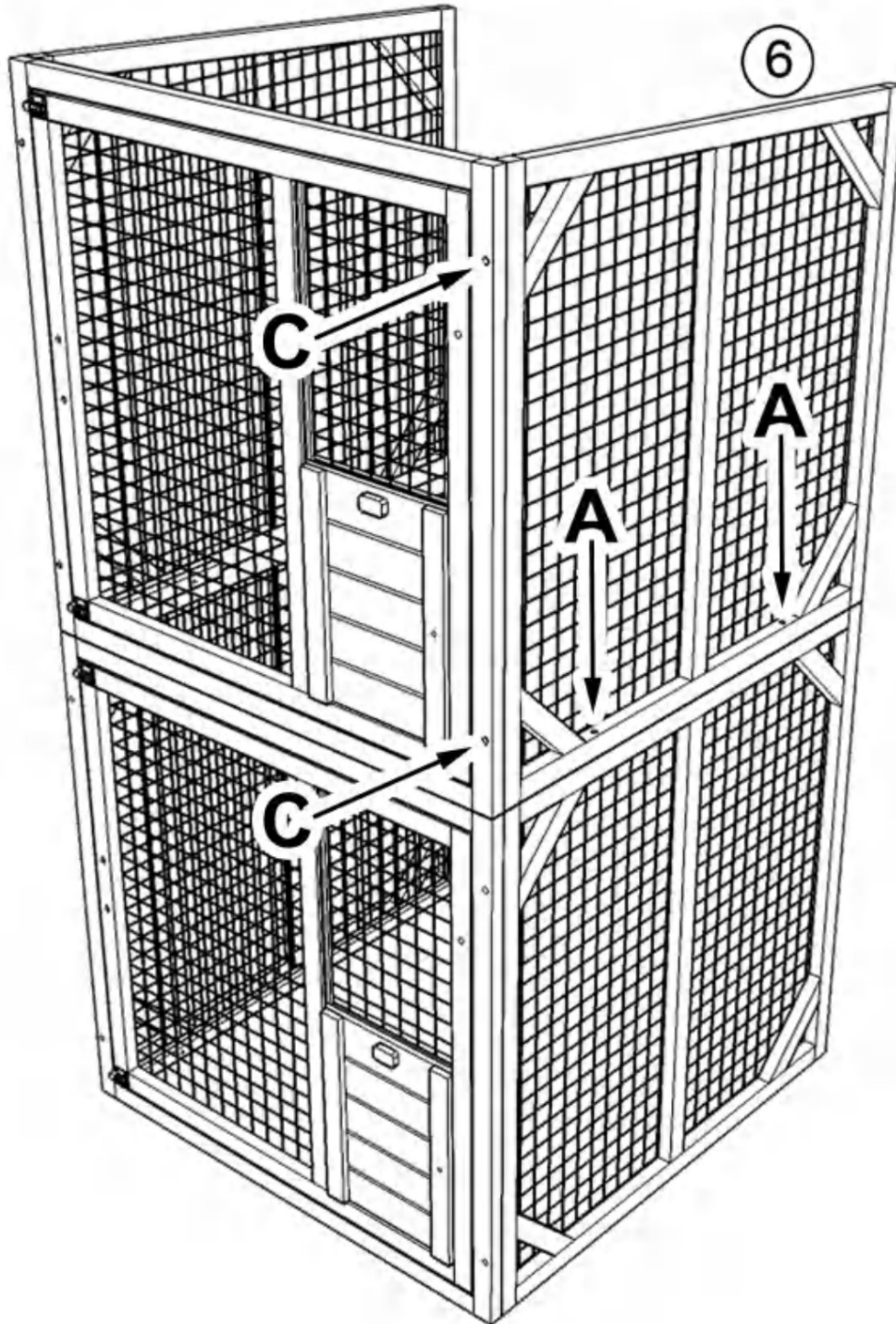

STEP:3

Assembling shelf with part #12 and part #11x2 by screws (E)x4 as shown

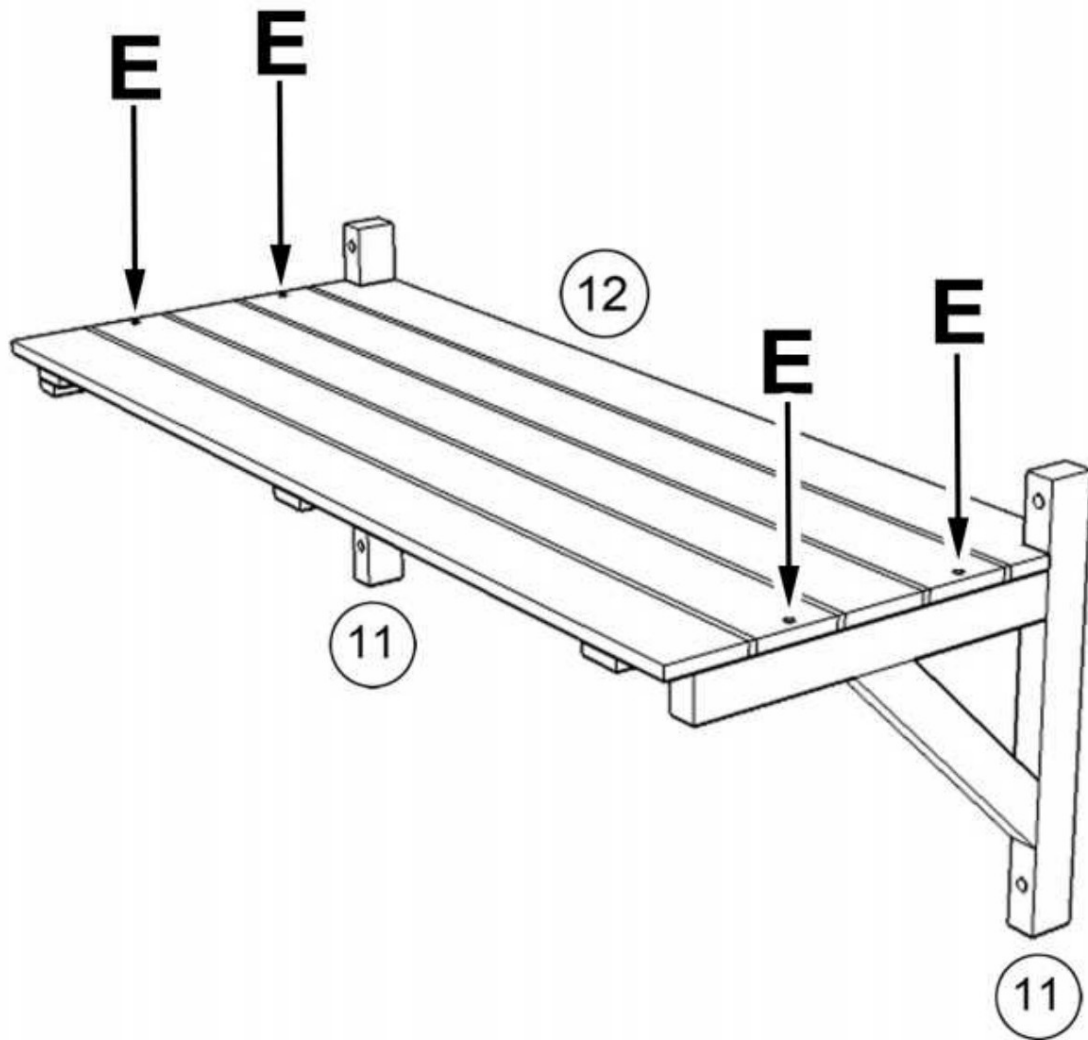

STEP:4

Mounting the shelf on right side as shown by screws (B)x4 at your preferred height

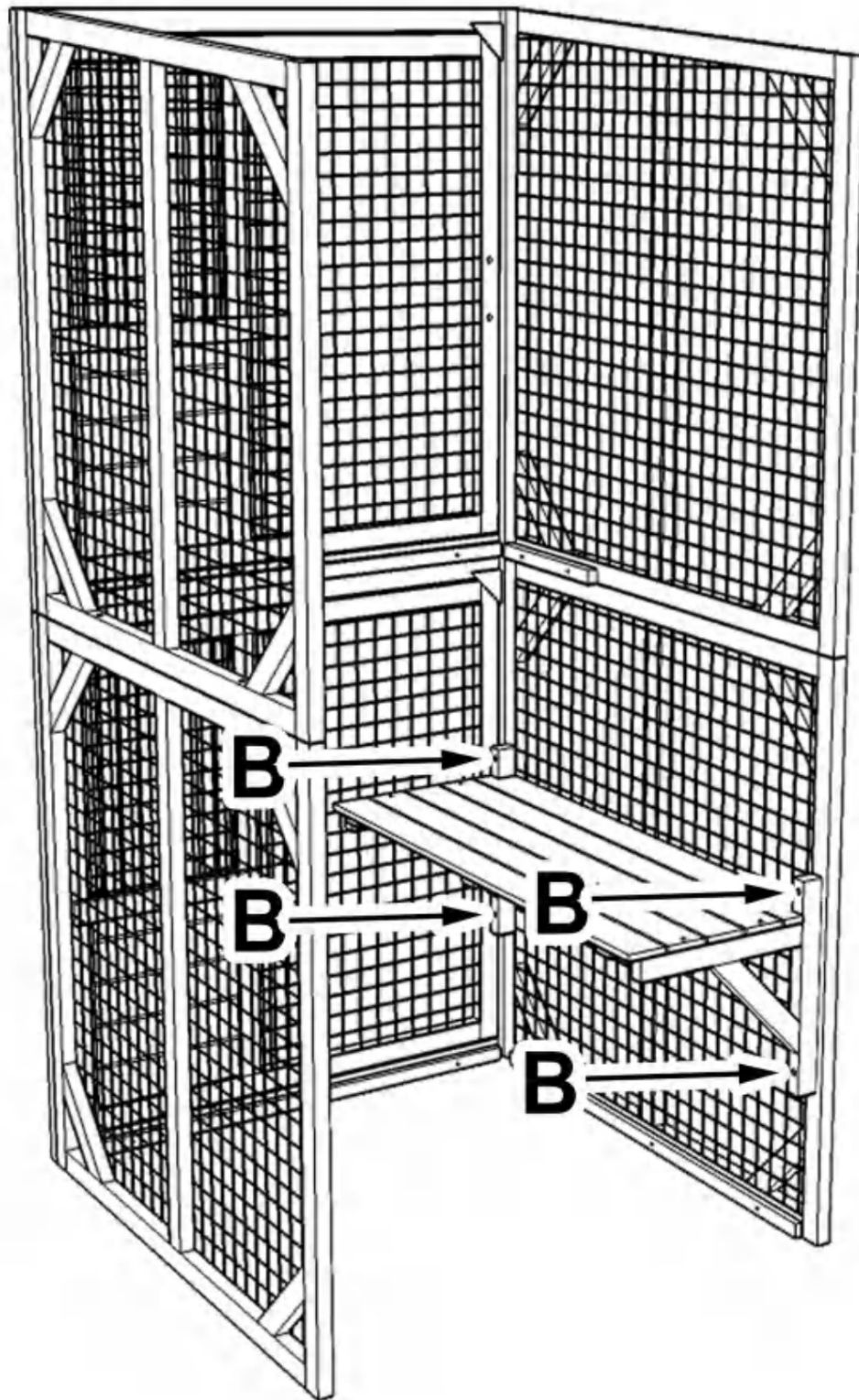

STEP:5

Placing part #14 on the short wood pieces on left and right side and secure it with screw (E)x4

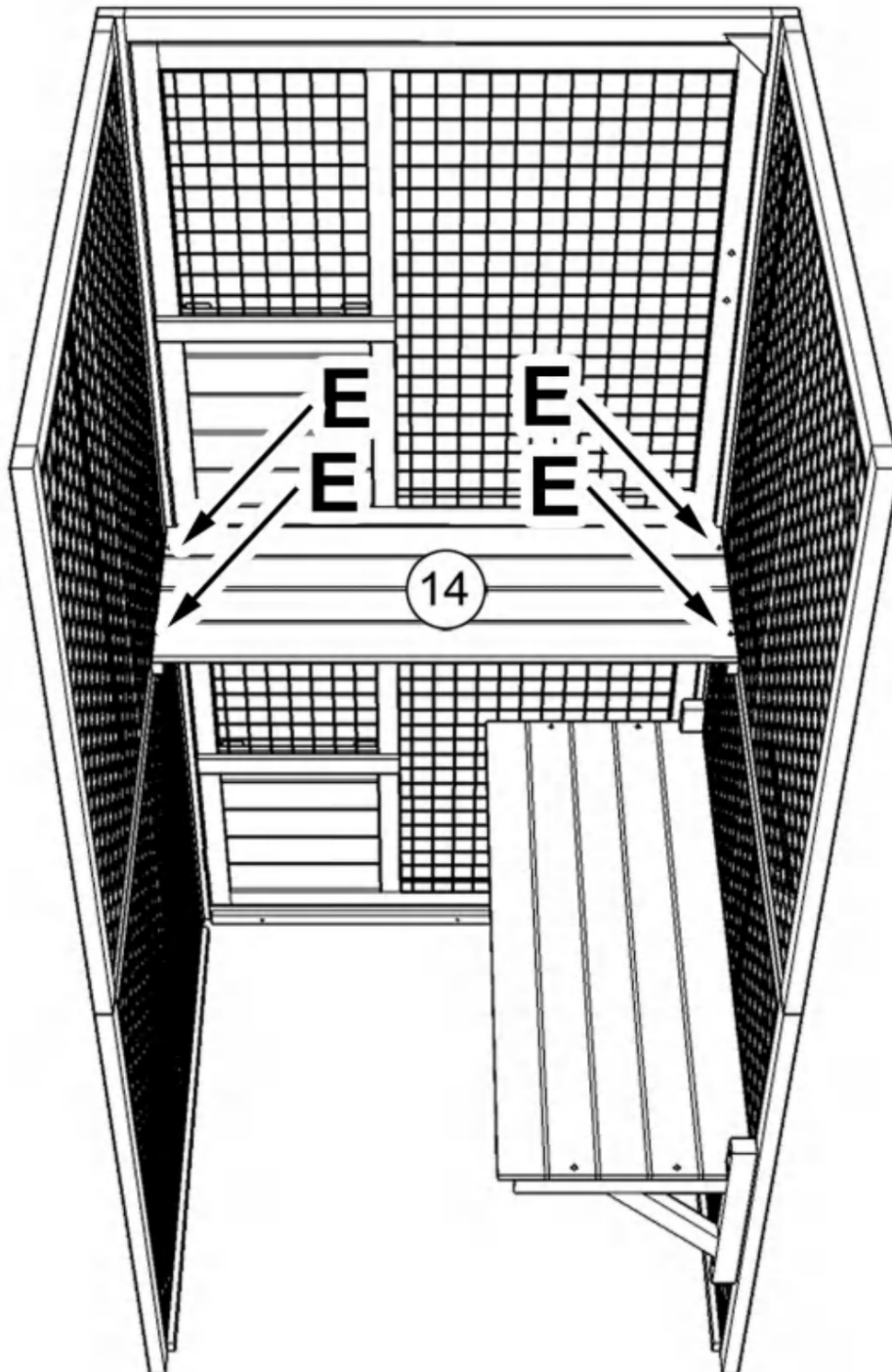

STEP:6

Assembling shelf with part #13 and part #11x2 by screws (E)x4 as shown

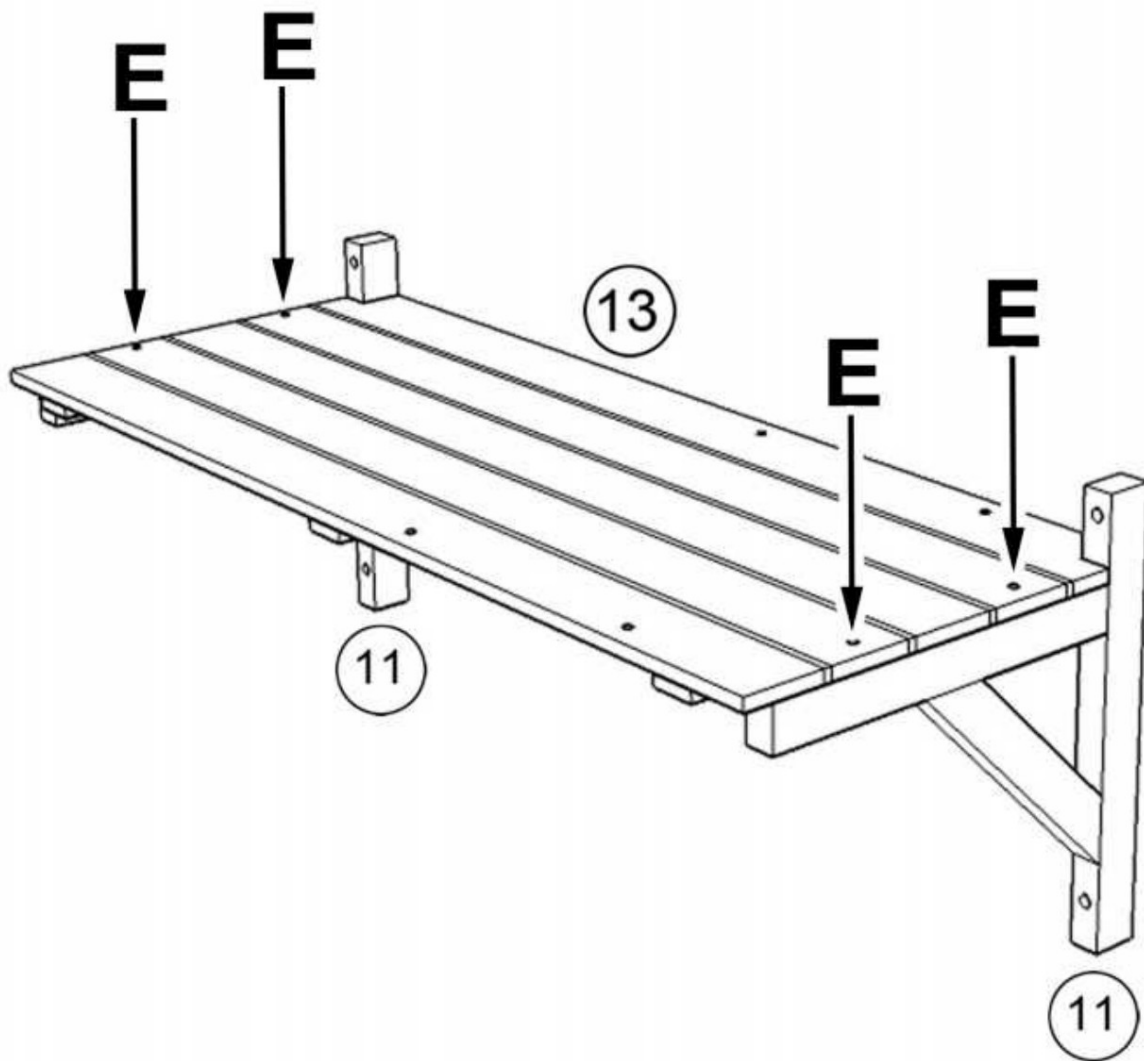

STEP:7

Mounting the shelf to the right side of board as shown with screws (B)x4 at your preferred height

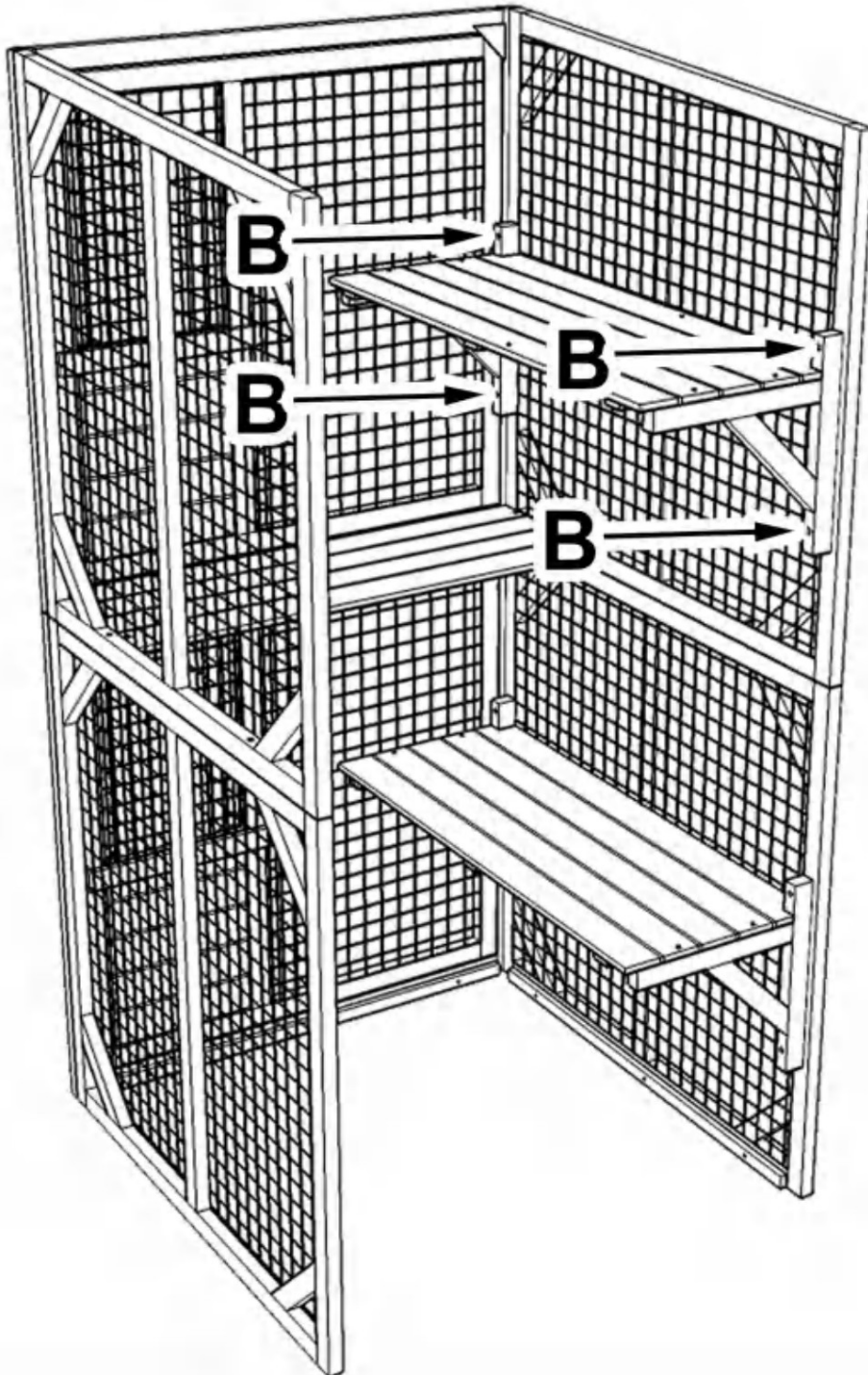

STEP:8

Assembling sleeping box with part #16x2, #17, #15 using screws (E)x10

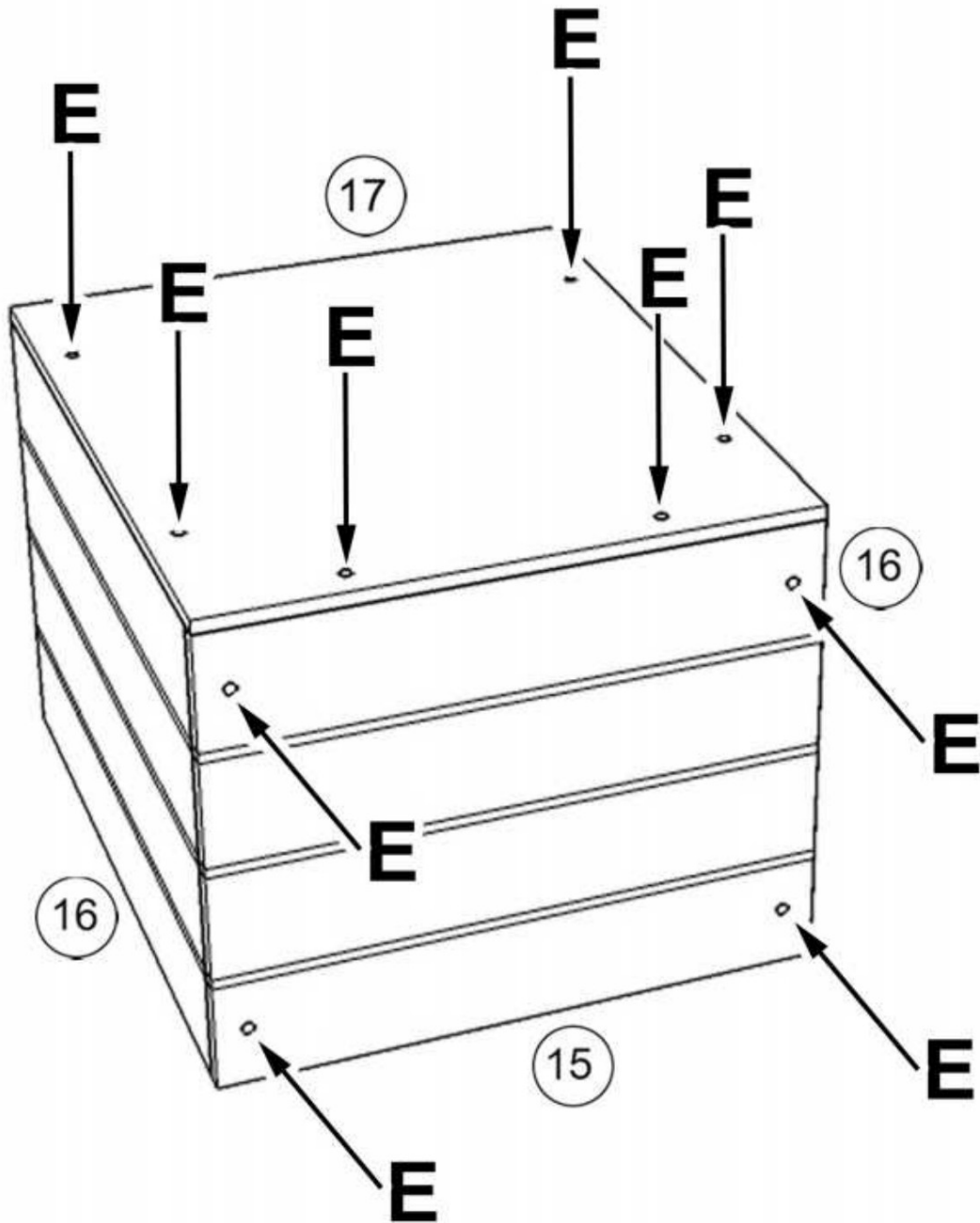

STEP:9

Placing sleeping box on the top of shelf as shown and secure it with screws (E)x4 from the bottom of shelf

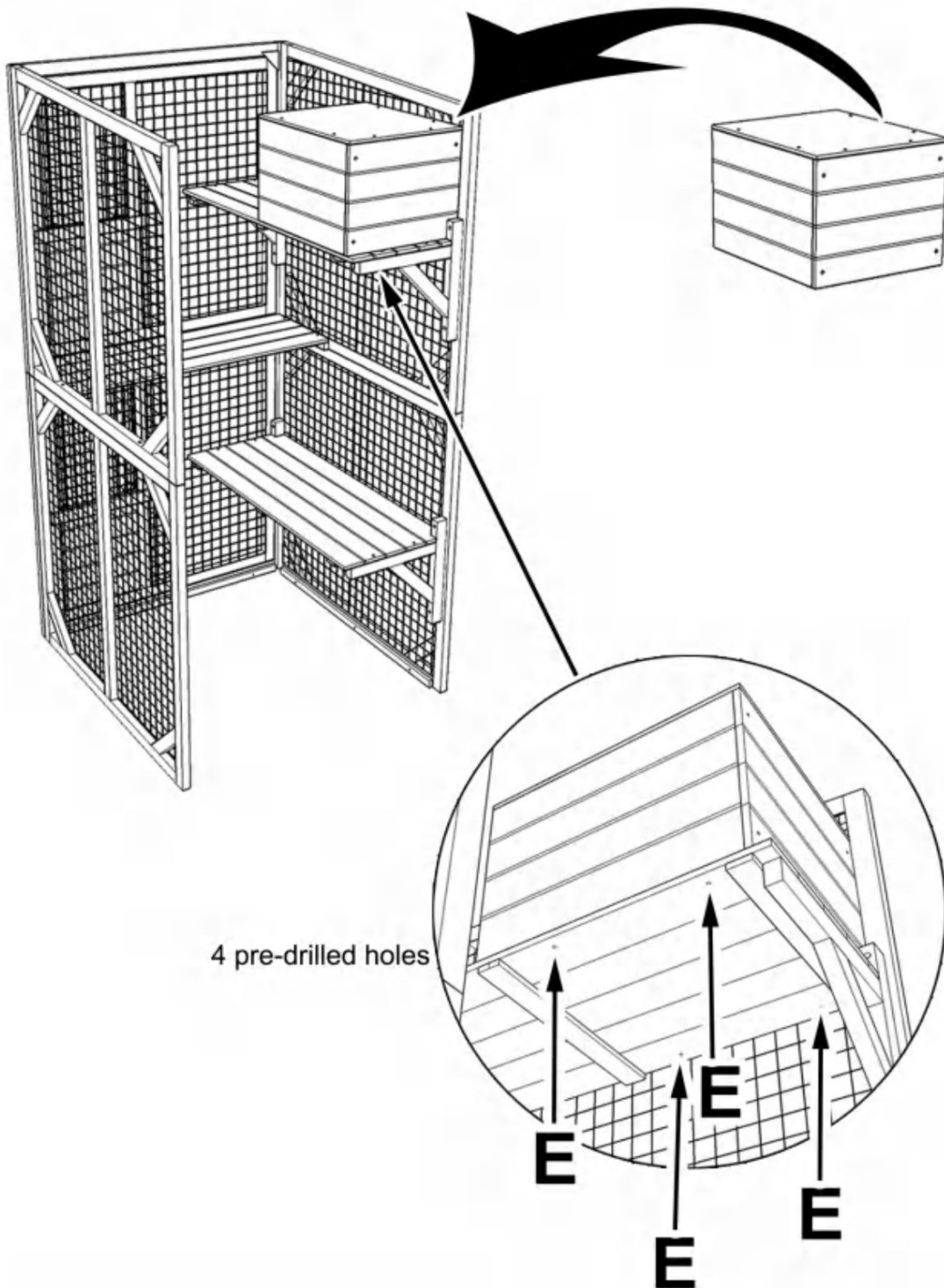

STEP:10

Assembling firstly part #9 (bottom) and then part #8 (2 holes at bottom) with screws (C)x8, then secure the 2 parts by screwing (A)x2 downwards as shown

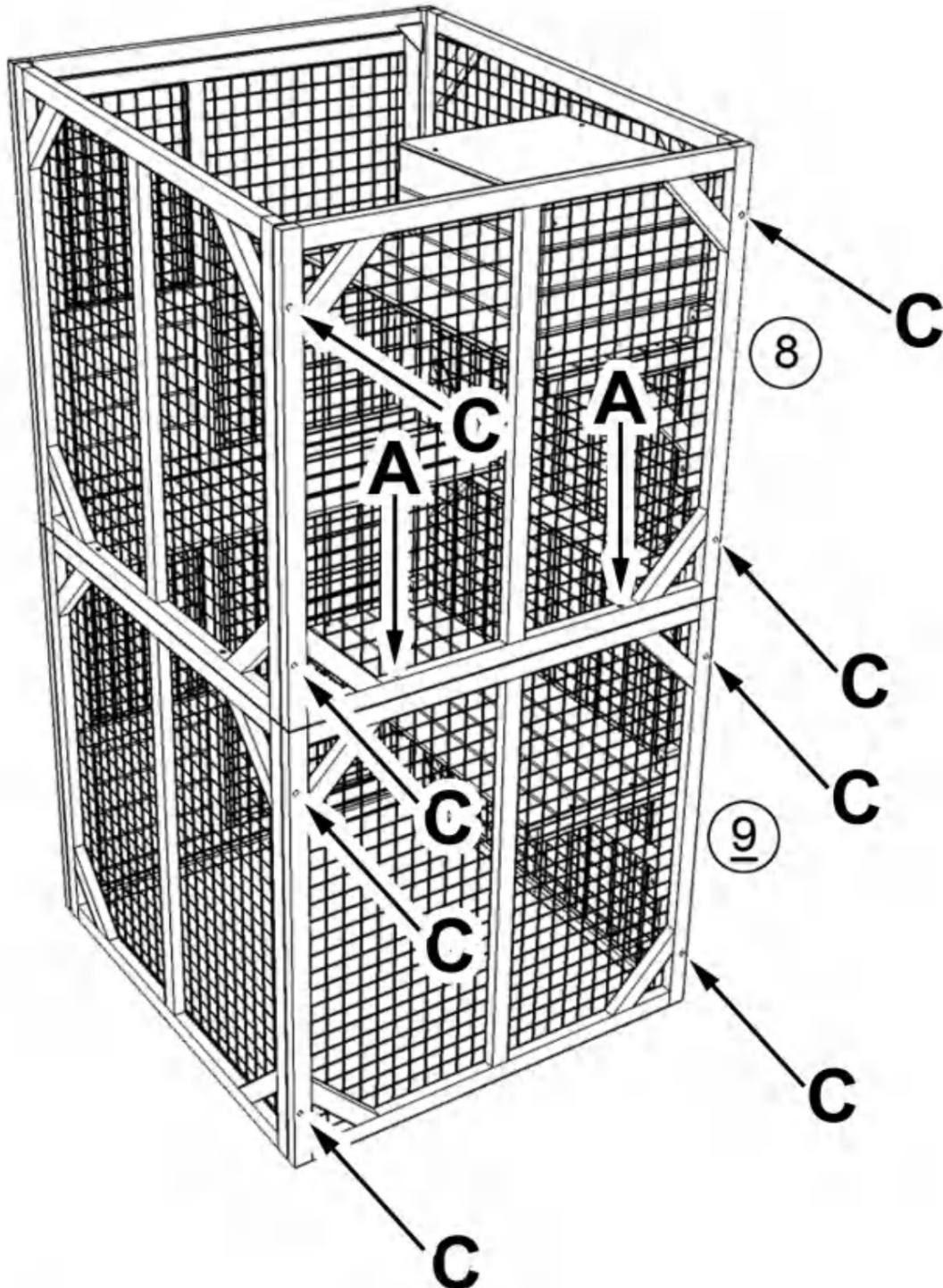

STEP:11

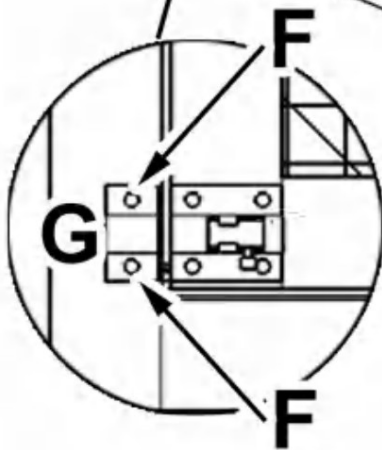
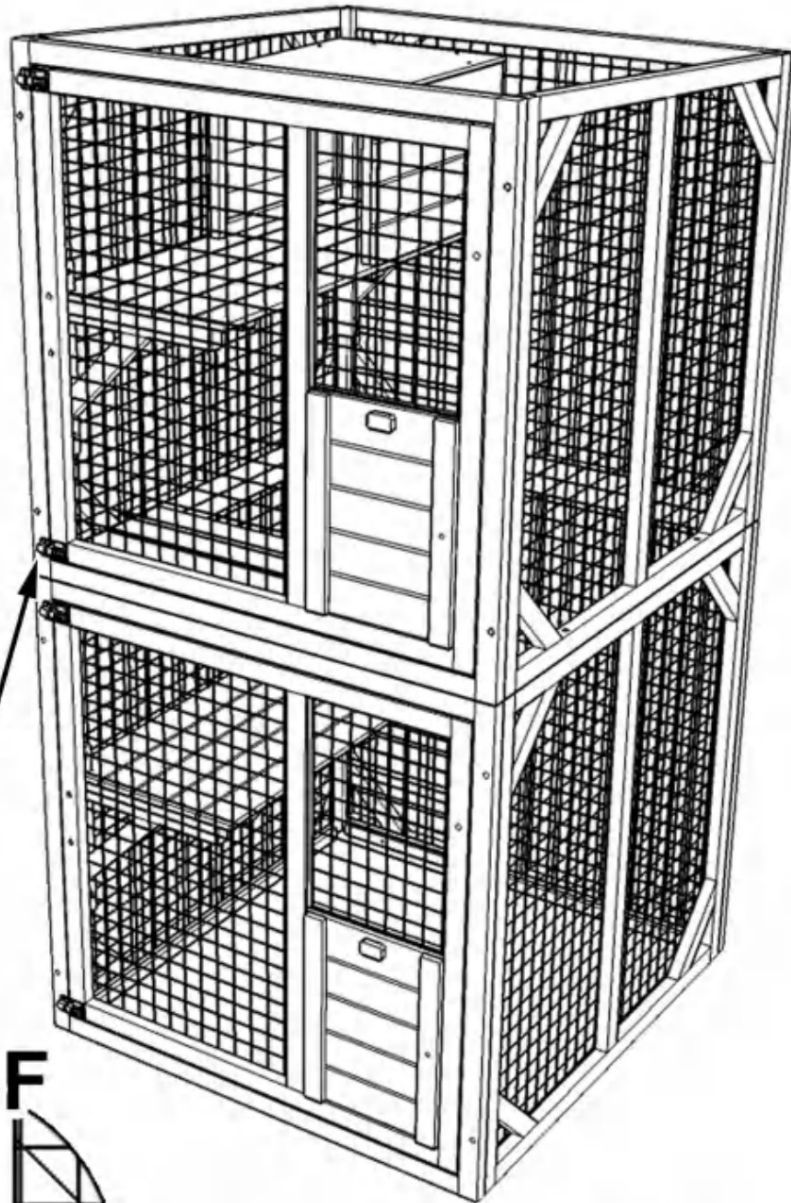

Align the short end of lock part #G with its other part already on door then secure it with screws (F)x2

STEP:12

Install handles parts #19x2 on doors with screws (C)x4 as shown

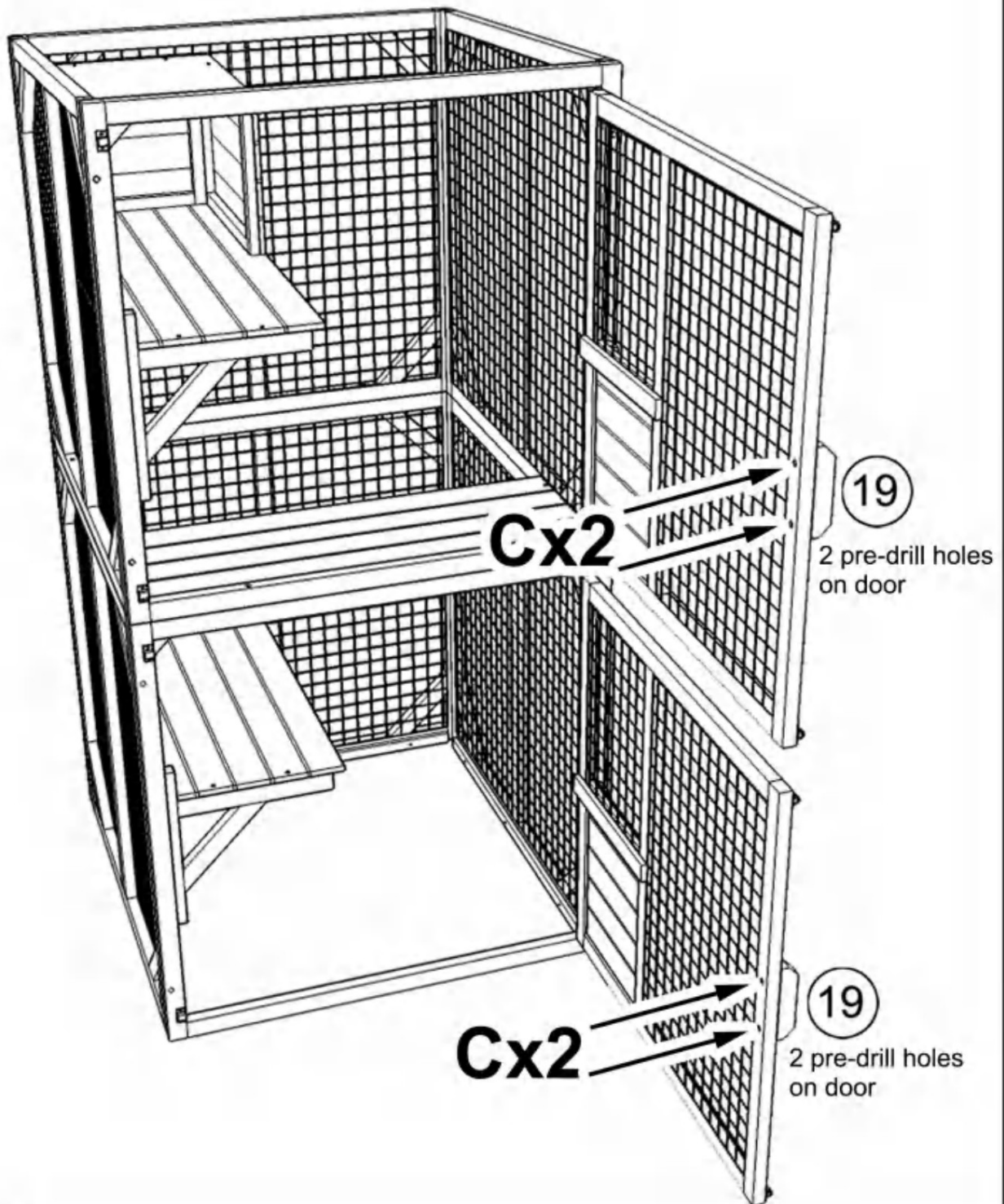

STEP:13

Install hooks as shown, long part is on the sliding door, short part is on the frame wood

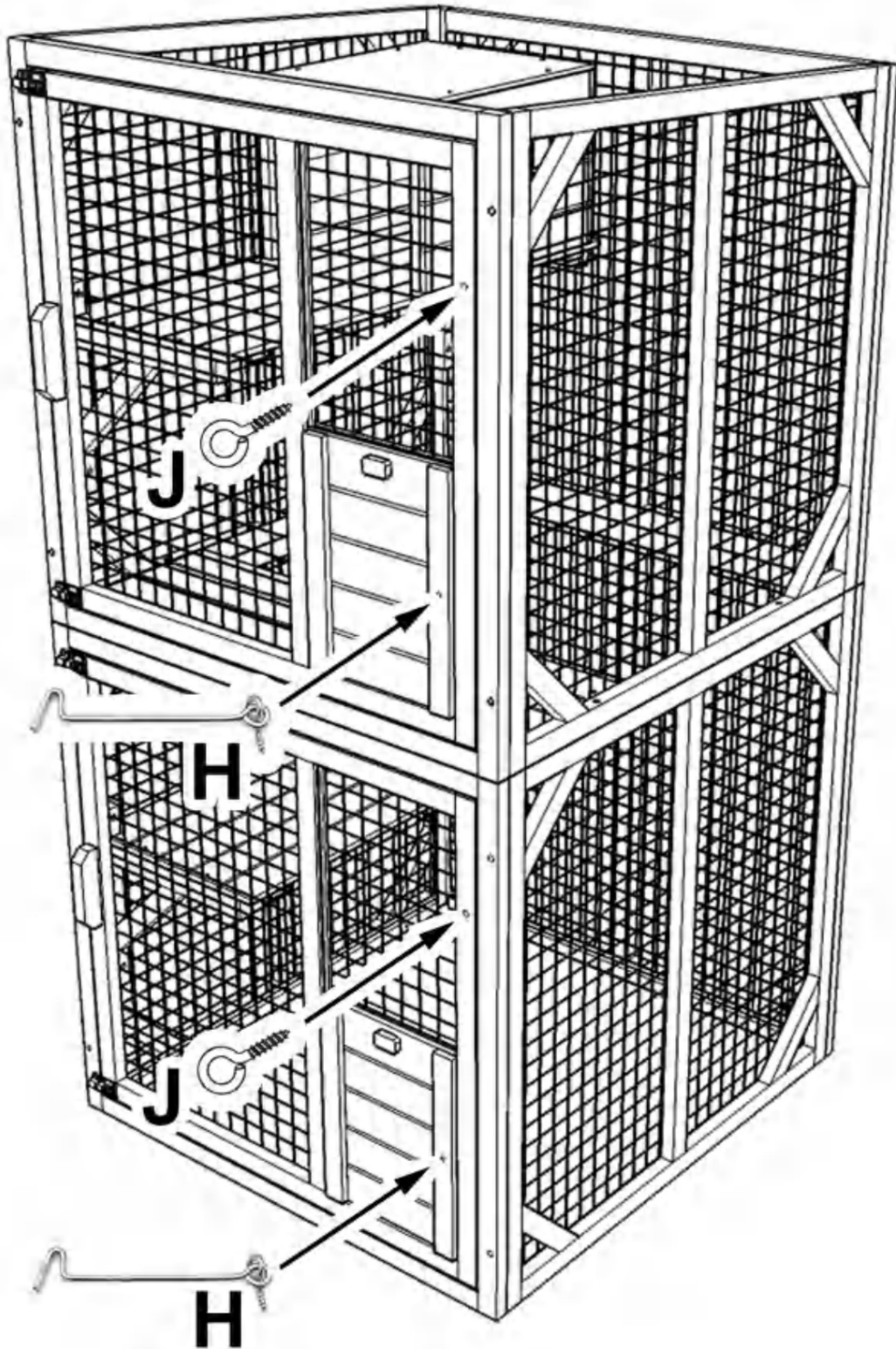

STEP:14

Gently let down the product, install part #7x4 as shown by screws (C)x12

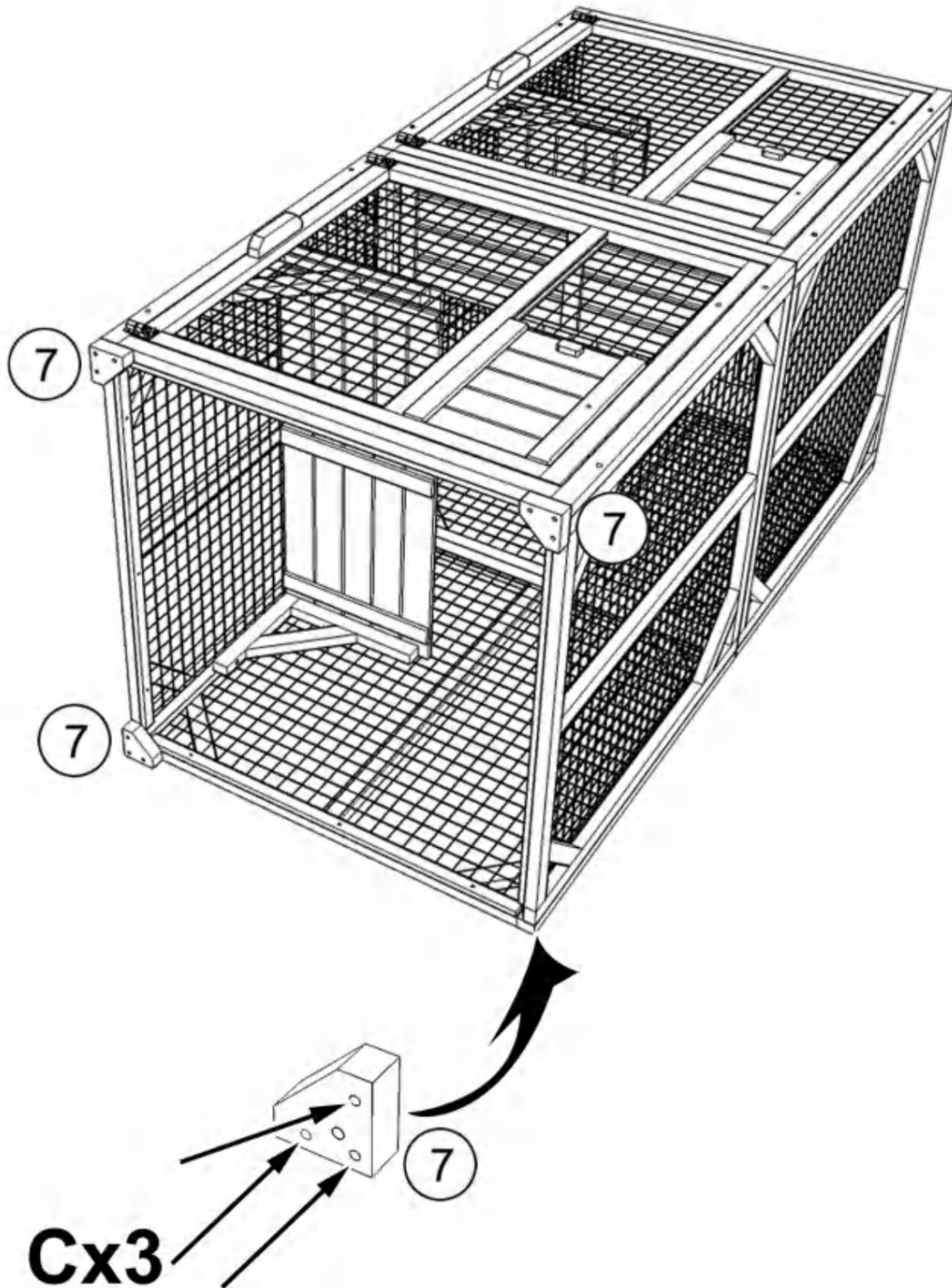

STEP:15

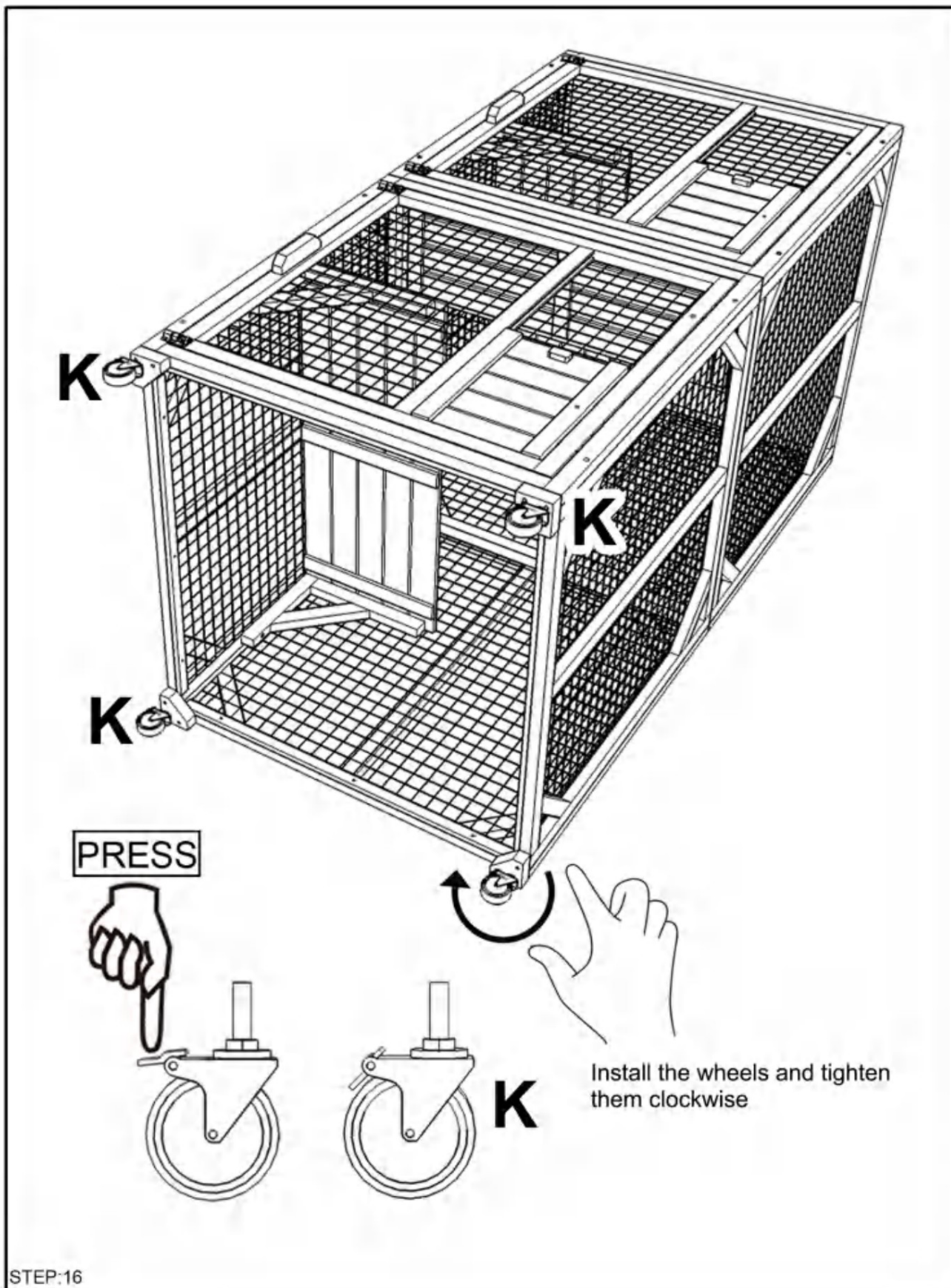

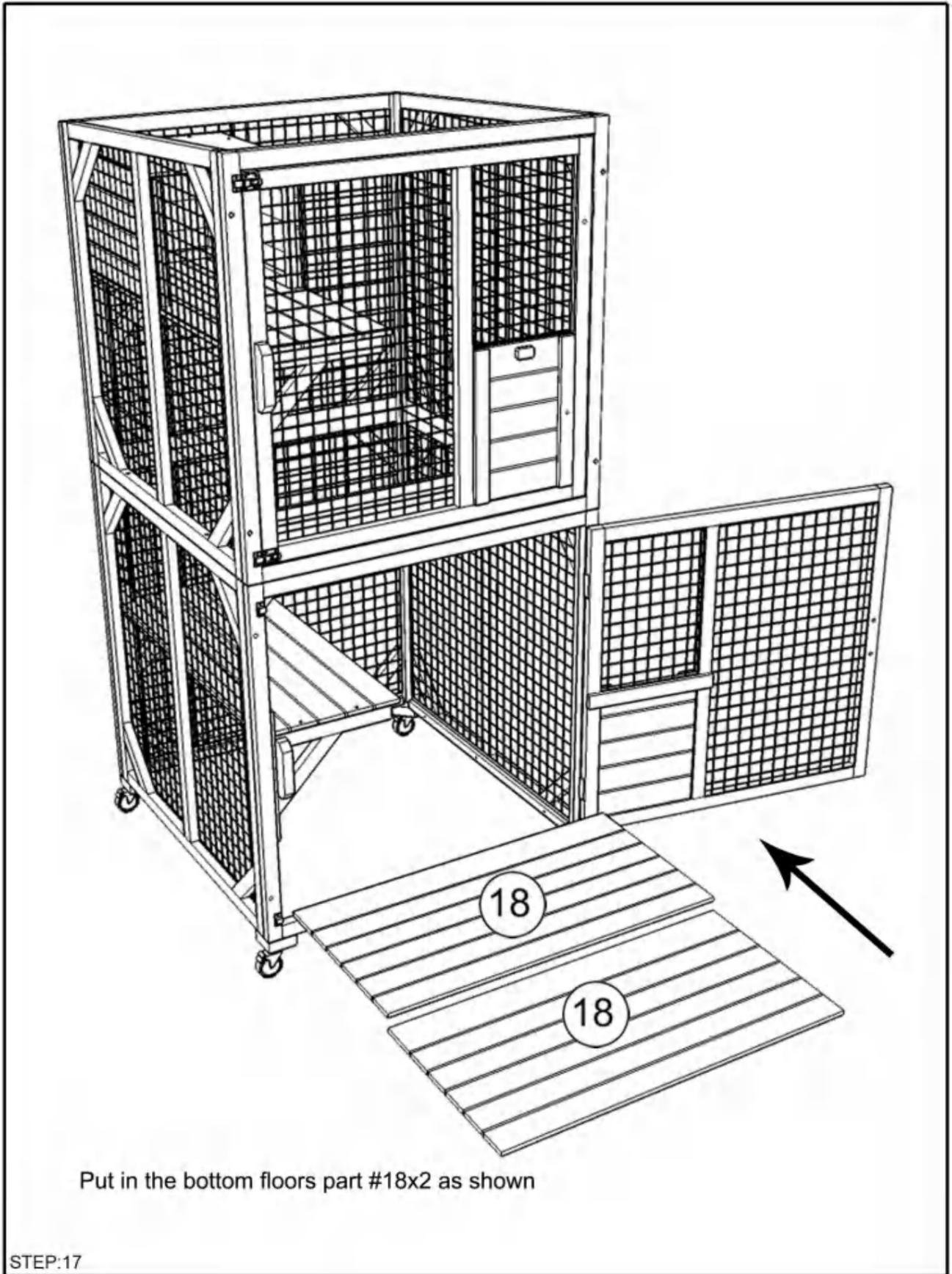

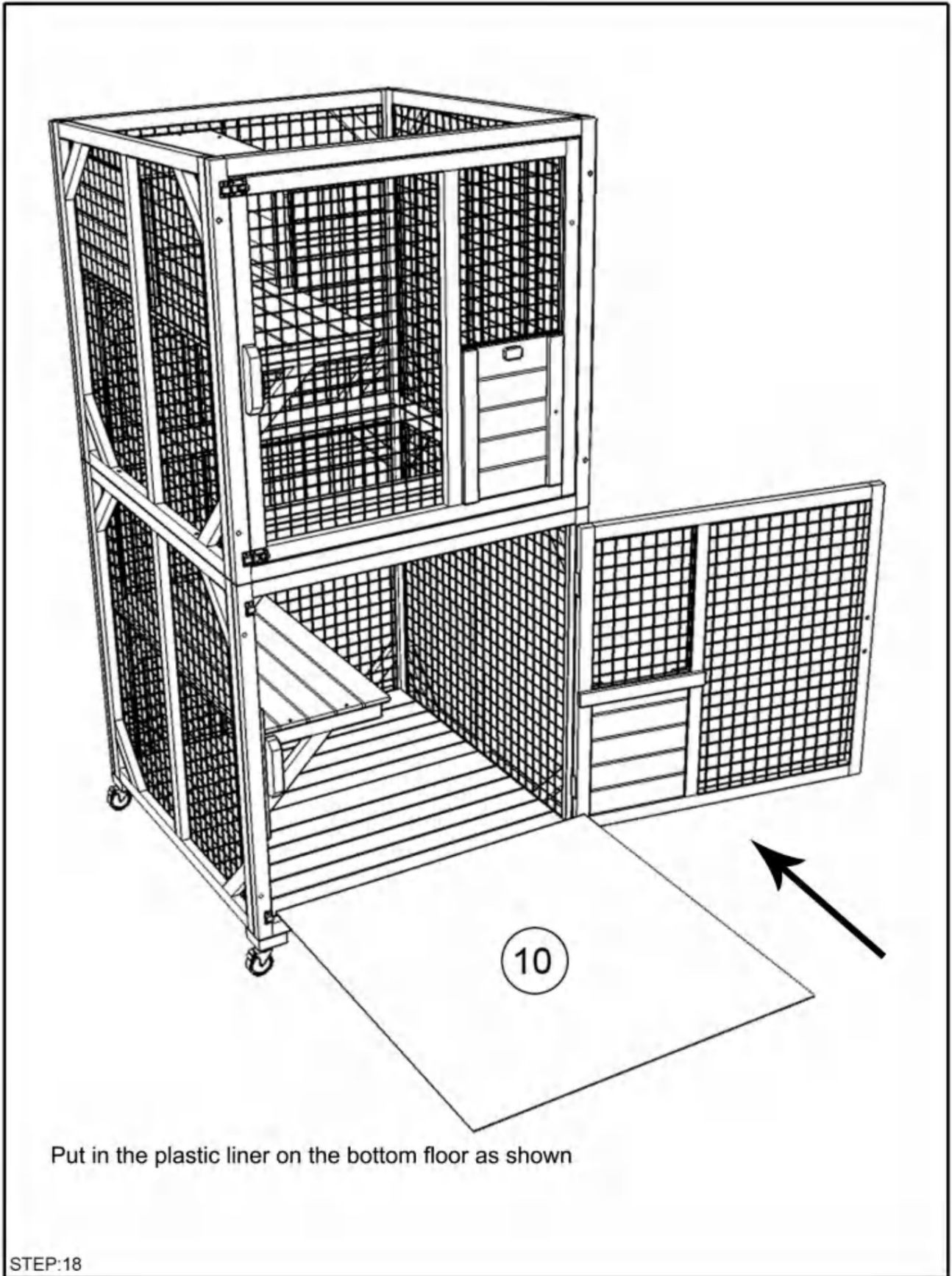

Install the felted roof part #3 with screws (D)x8

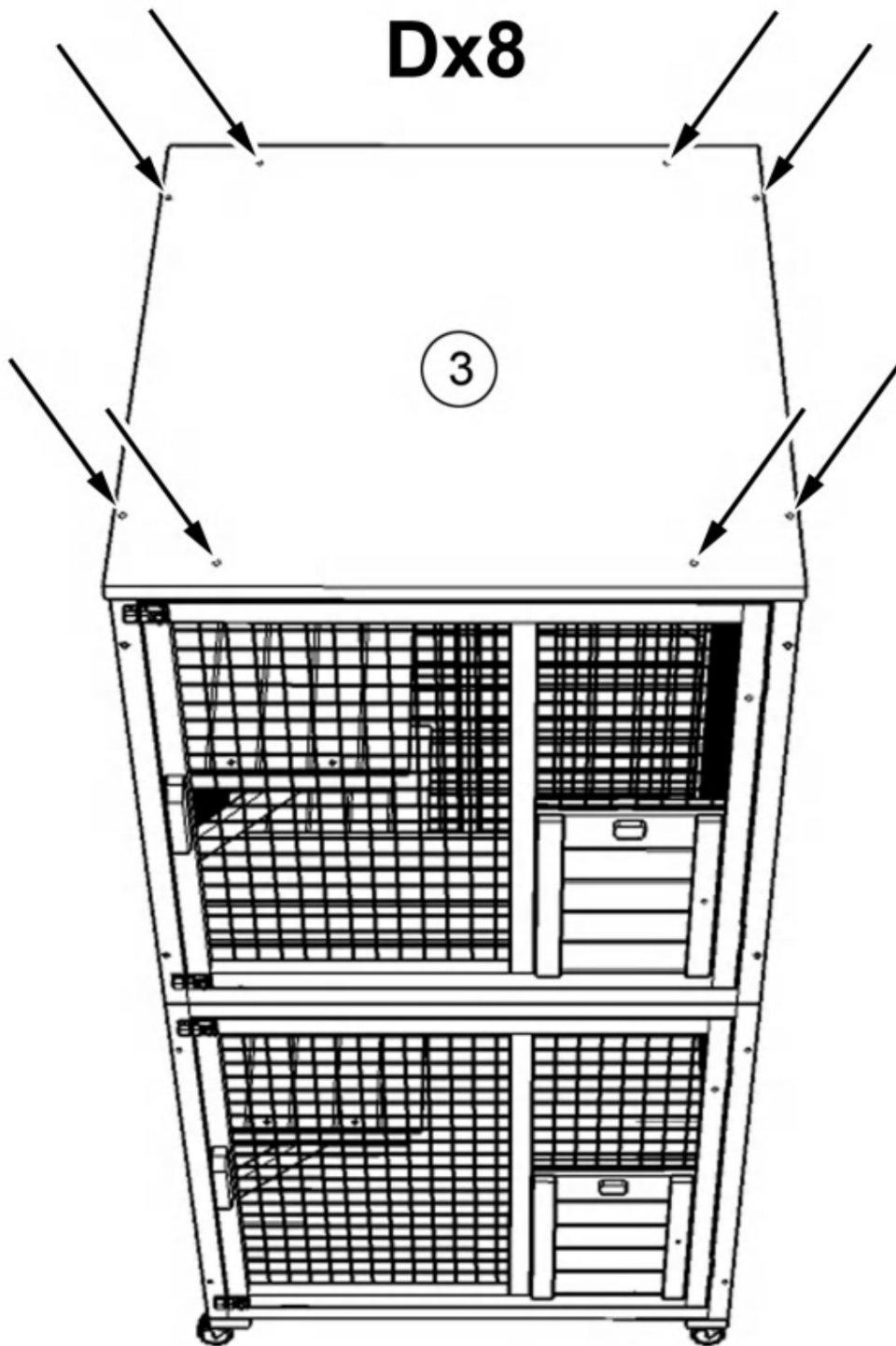

STEP:19

Shuangchenglu 803nong11hao1602A-1609shi, baoshanqu,
szanghaj 200000 CN.



Firma E-CrossStu GmbH.

Mainzer Landstr.69, 60329 Frankfurt
nad Menem.



YH CONSULTING LIMITED.

C/O YH Consulting Limited Biuro 147,
Centurion House, London Road, Staines-upon-
Thames, Surrey, TW18 4AX

Importowane do USA: Sanven Technology Ltd., Suite 250, 9166
Anaheim Place, Rancho Cucamonga, Kalifornia 91730

VEVOR[®]

TOUGH TOOLS, HALF PRICE

Technical Support and E-Warranty Certificate

www.vevor.com/support

VEVOR[®]

TOUGH TOOLS, HALF PRICE

Technical Support and E-Warranty Certificate www.vevor.com/support

INSTRUCTION FOR CAT CAGE

MODEL:CH470

Continuiamo a impegnarci per fornirvi strumenti a prezzi competitivi.

"Risparmia la metà", "Metà prezzo" o qualsiasi altra espressione simile da noi utilizzata rappresenta solo una stima del risparmio che potresti ottenere acquistando determinati utensili con noi rispetto ai principali marchi principali e non significa necessariamente coprire tutte le categorie di utensili da noi offerti. Ti ricordiamo gentilmente di verificare attentamente quando effettui un ordine con noi se stai effettivamente risparmiando la metà rispetto ai principali marchi principali.

VEVOR[®]
TOUGH TOOLS, HALF PRICE

CAT CAGE

CH470

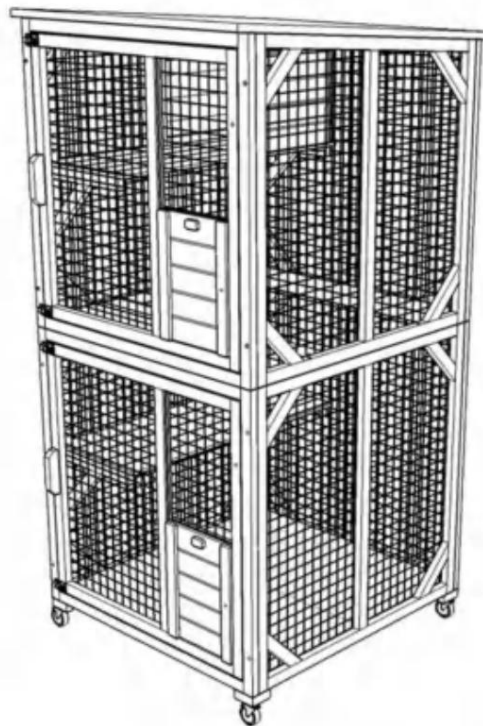

NEED HELP? CONTACT US!

Have product questions? Need technical support? Please feel free to contact us:

Supporto tecnico e certificato di garanzia elettronica www.vevor.com/support

This is the original instruction, please read all manual instructions carefully before operating. VEVOR reserves a clear interpretation of our user manual. The appearance of the product shall be subject to the product you received. Please forgive us that we won't inform you again if there are any technology or software updates on our product.

WARNING:

Read this material before using this product. Failure to do so can result in serious injury.

Assembly precautions

1. Assemble only according to these instructions. Improper assembly can create hazards.
2. In order to ensure your own safety, please make sure to ANSI-approved safety goggles and heavy-duty work gloves when installing this product.
3. Keep the assembly area clean and well lit.
4. Keep bystanders out of the area during assembly.
5. Do not assemble when tired or when under the influence of alcohol, drugs or medication.
6. Product capabilities apply to properly and completely assembled product only.
7. Assemble on a flat, level, hard and smooth surface capable of safely supporting a fully loaded cat cage.

Use precautions

TO PREVENT SERIOUS INJURY AND DEATH FROM TIPPING:

1. DO NOT SIT OR STAND ON THIS ITEM.
2. This product is not a toy. Do not allow children to play with or near this item. Please keep small spare parts out of children's reach.
3. Use only on a flat, level, hard and smooth surface capable of safely supporting a fully loaded cat cage.
4. Use as intended only.
5. Inspect before every use; do not use if parts are loose or damaged.

SAVE THESE INSTRUCTIONS

SPECIFICATIONS

Model	CH470
Product Size	760×865×1630mm
Color	Gray

COMPONENTS

Notice:

1. Various specifications of screws are used in the installation of this product. Pay attention to the correct use of screw specifications according to the instruction manual.
2. Please wear gloves when installing.

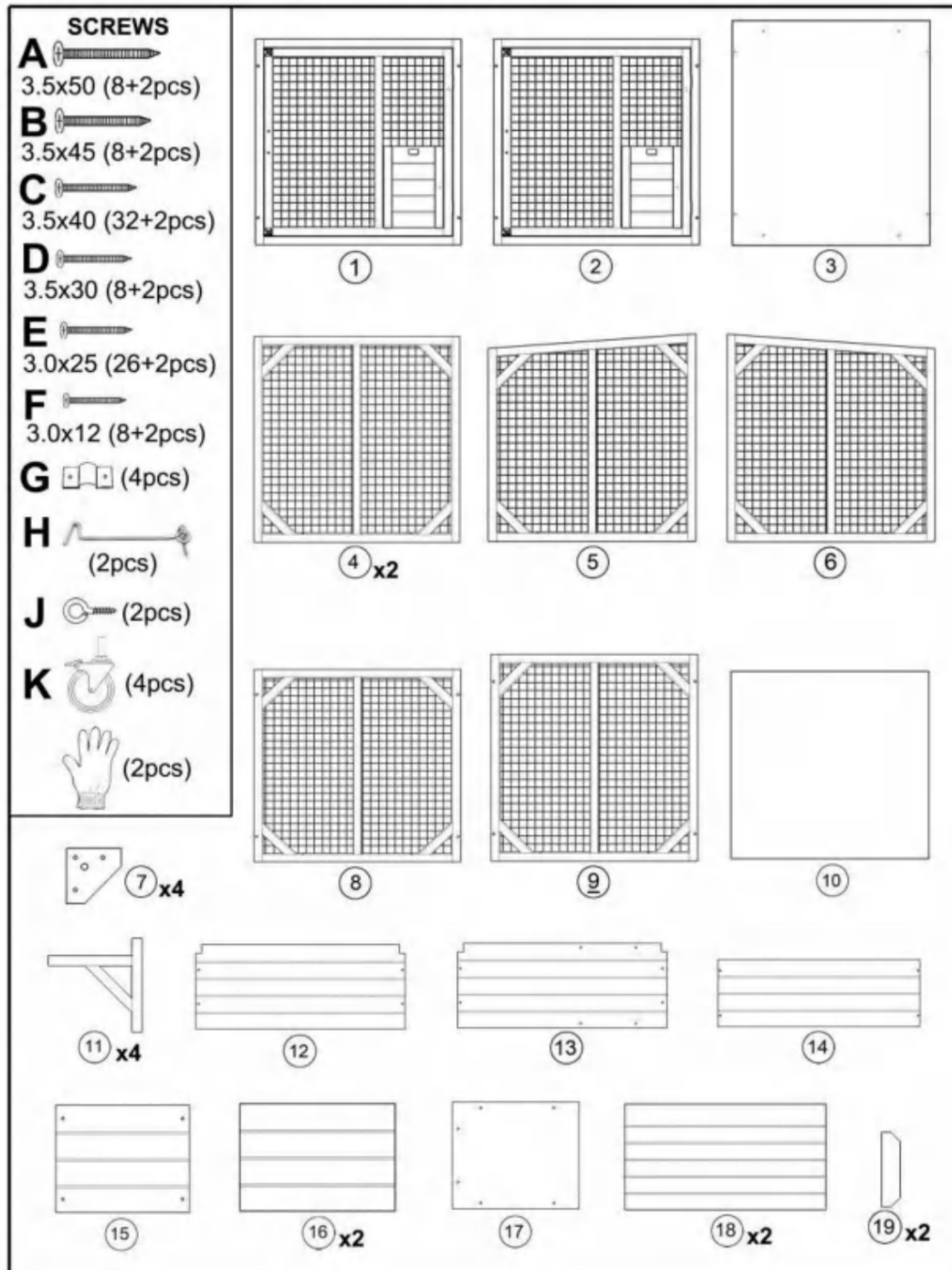

Assembly Instructions

Please be noted that the side with wire nailed on is back side, should be inward when installation

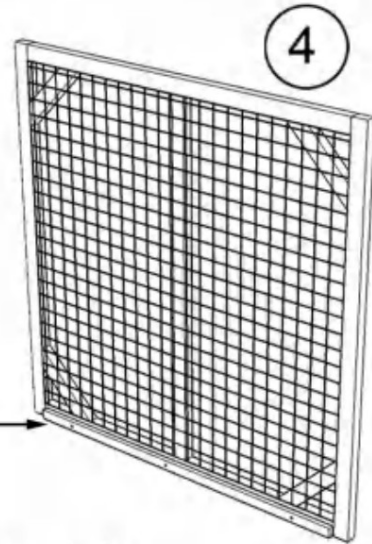

This end with a long piece of wood is placed at bottom

Assembling part #4x2 and part #1 with screws (C)x4 as shown below

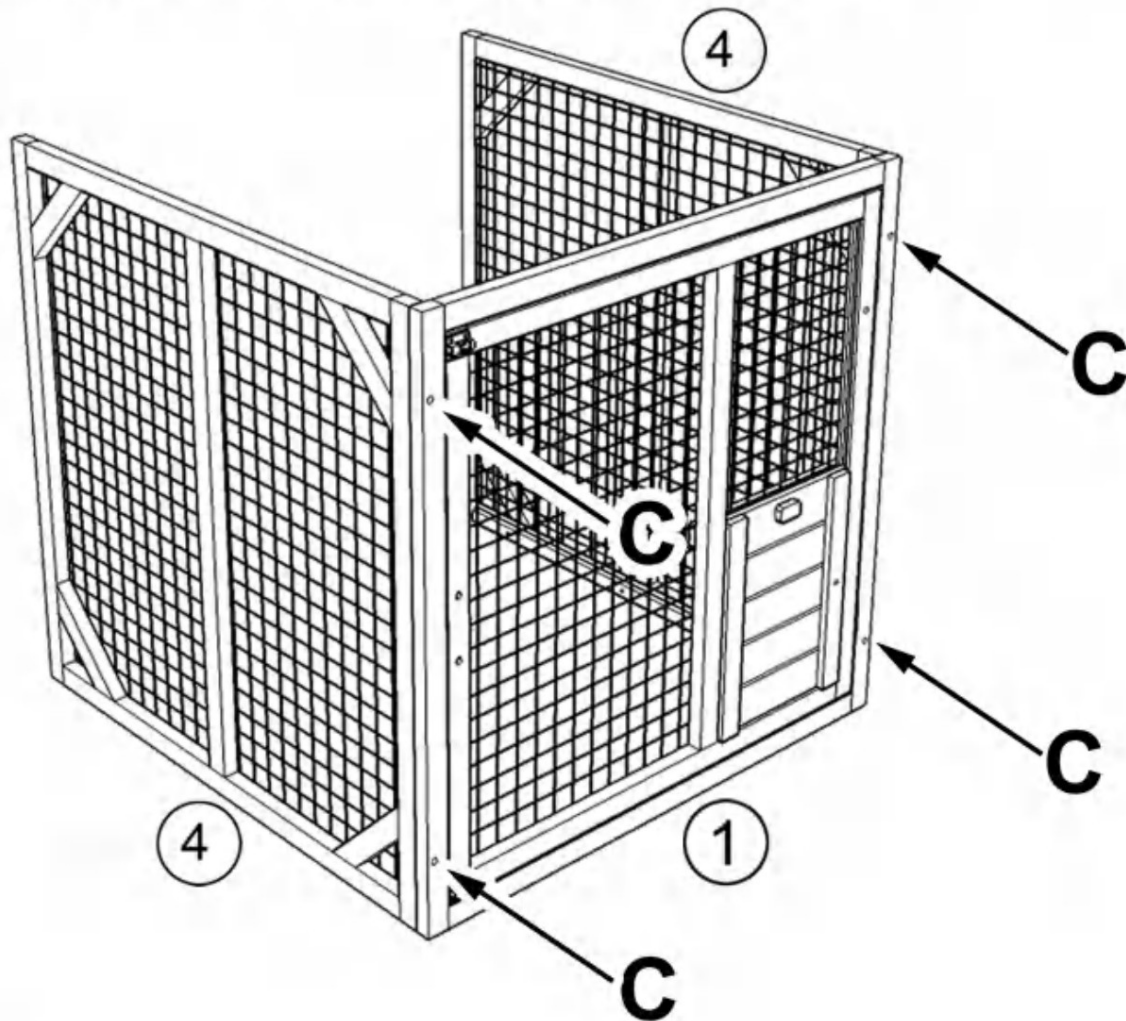

STEP:1

The part #2 (open the door) and part #5 has pre-drilled holes at bottom as shown, assemble part #2 and part #5 with screws (C)x2, then place them on the parts finished in last step and secure them with screws (A)x4 downwards

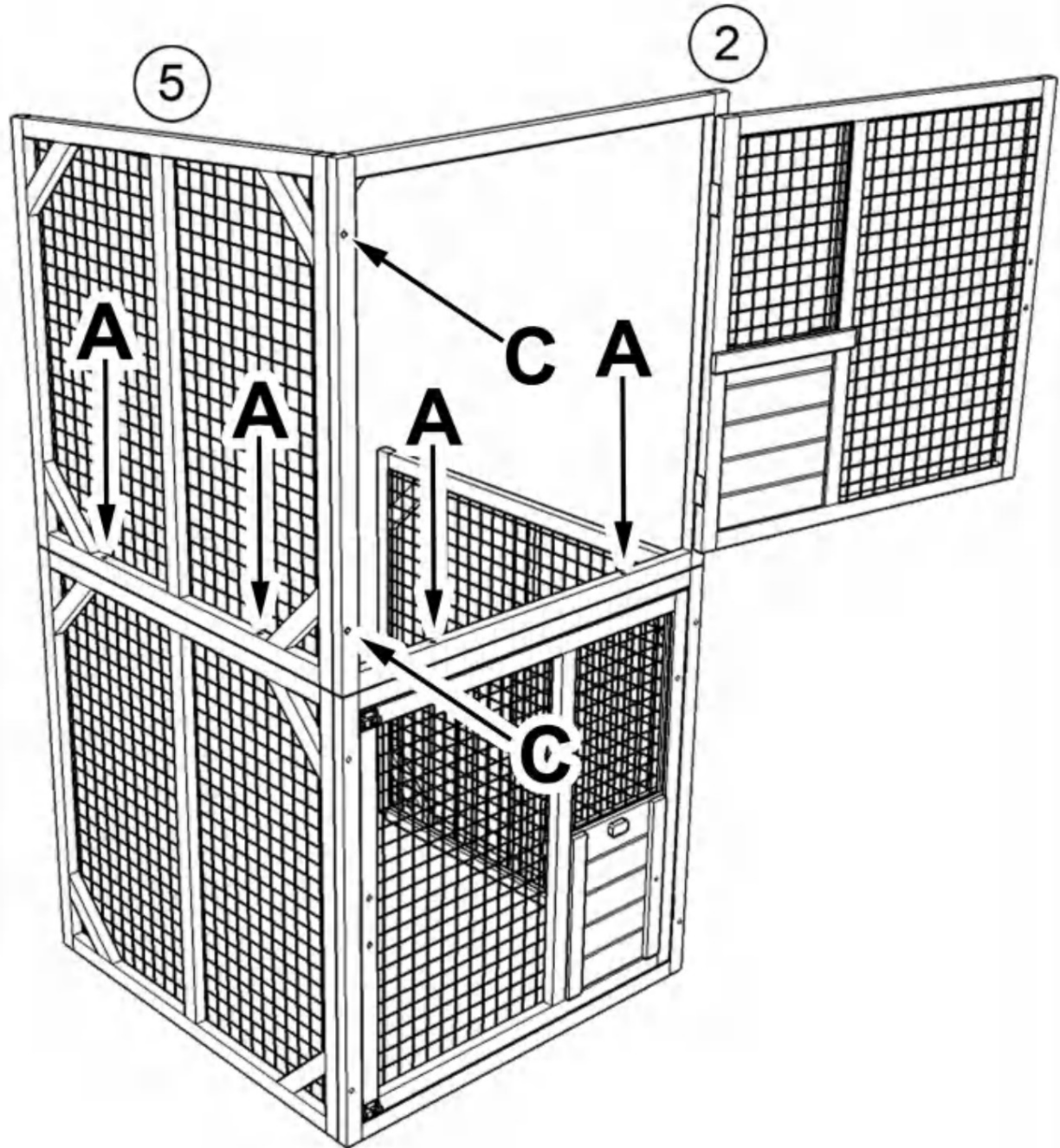

STEP:2

The part #6 has 2 pre-drilled holes at bottom, assembling part #6 with screws (C)x2 as shown and secure it to lower part with screws (A)x2 downwards

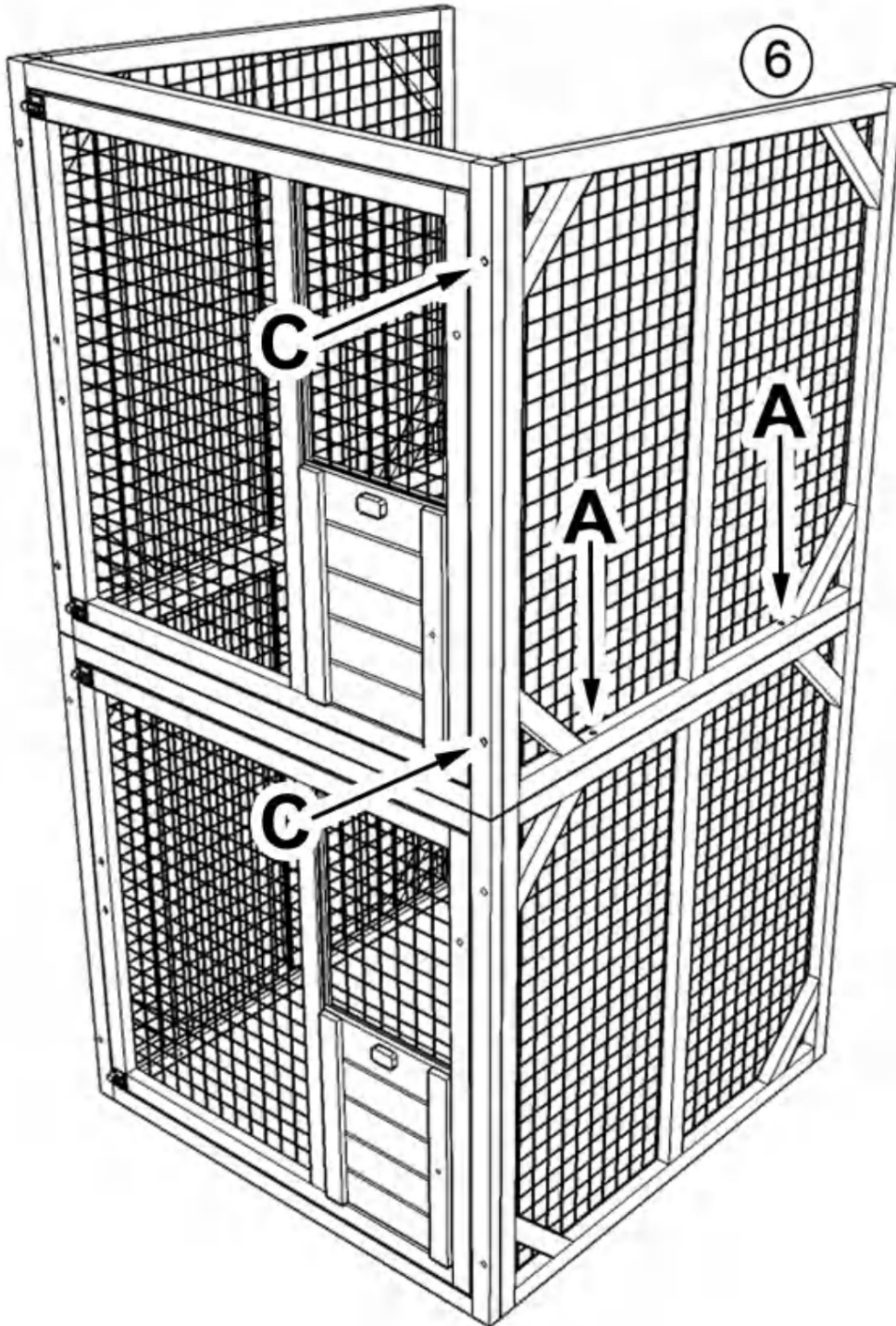

STEP:3

Assembling shelf with part #12 and part #11x2 by screws (E)x4 as shown

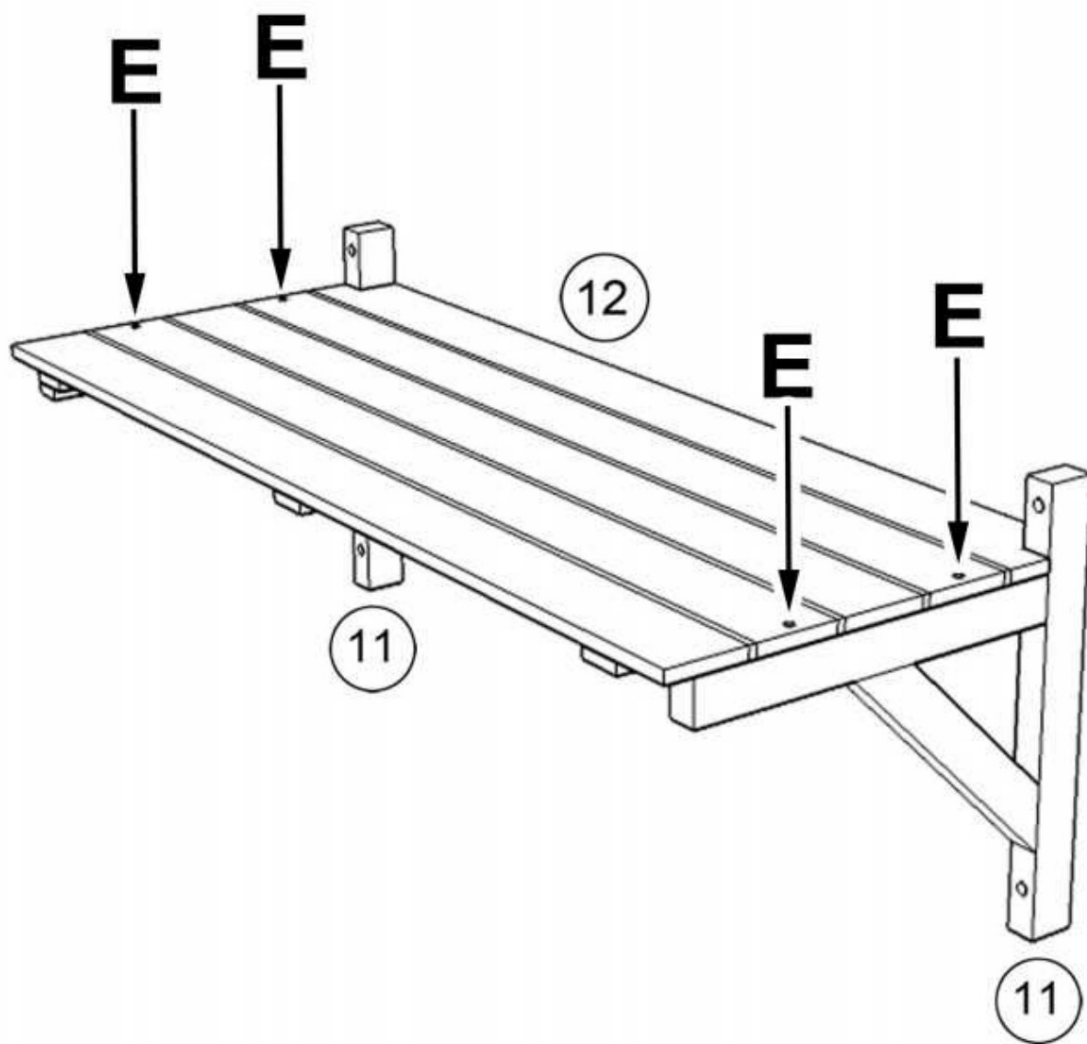

STEP:4

Mounting the shelf on right side as shown by screws (B)x4 at your preferred height

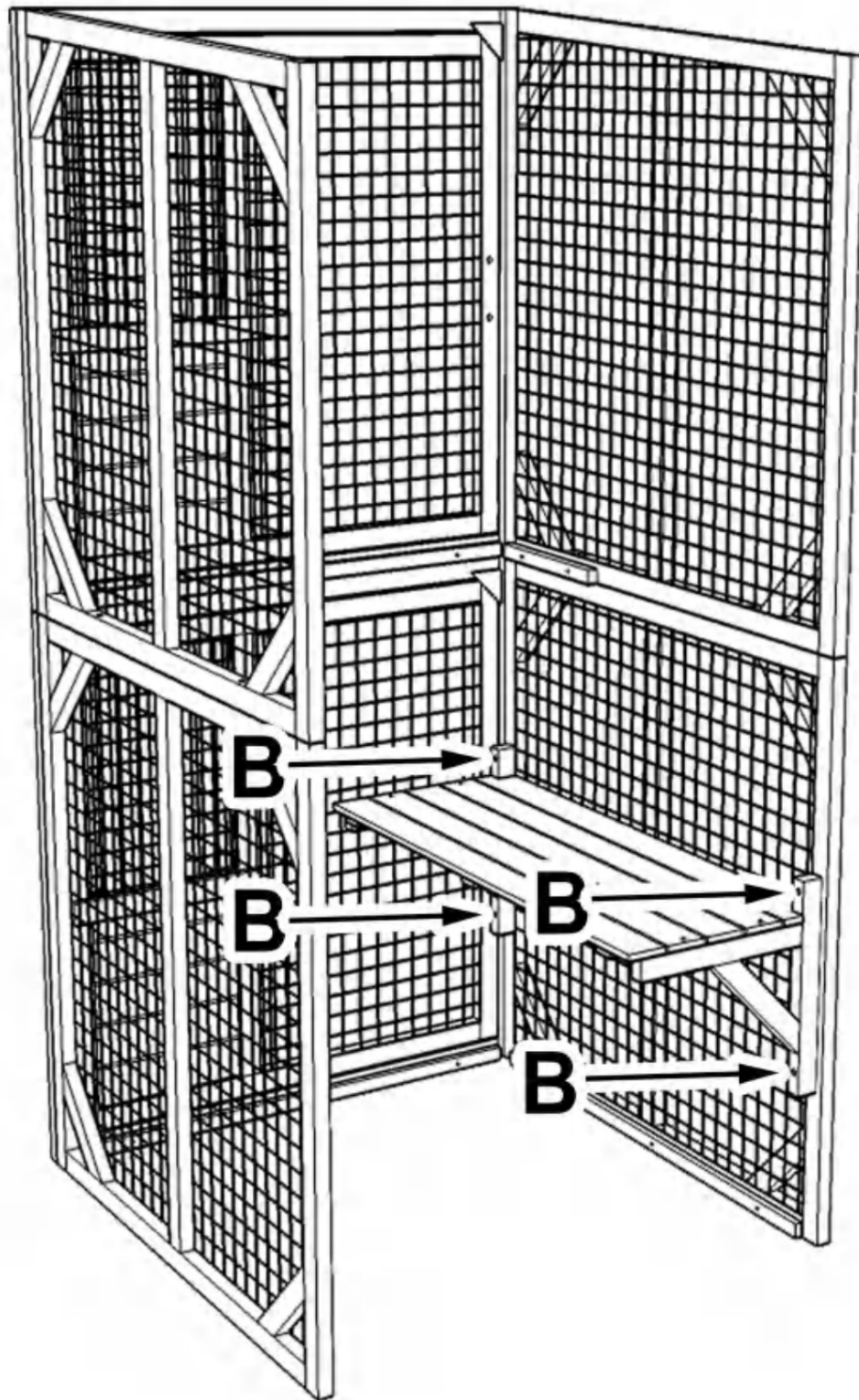

STEP:5

Placing part #14 on the short wood pieces on left and right side and secure it with screw (E)x4

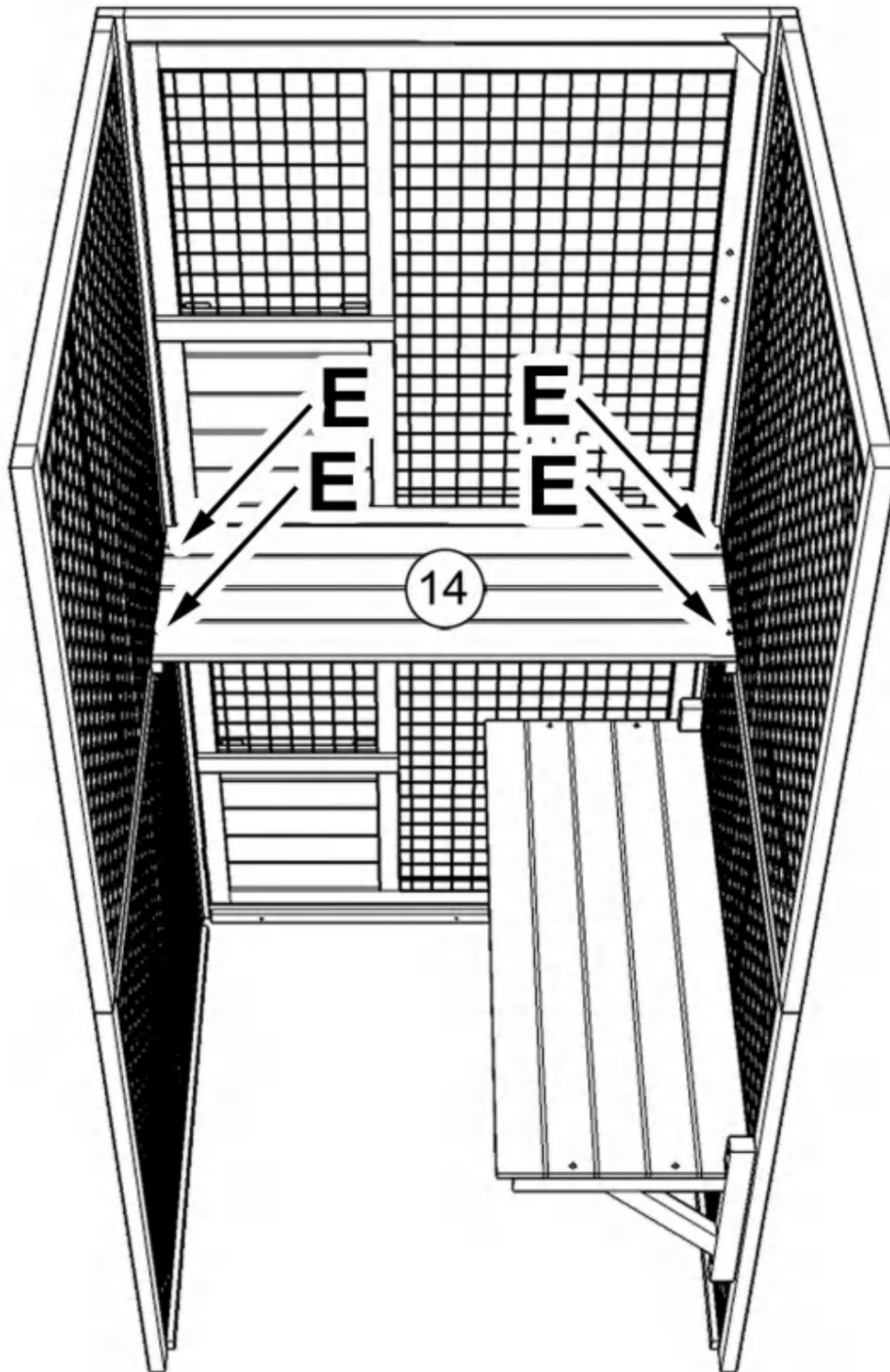

STEP:6

Assembling shelf with part #13 and part #11x2 by screws (E)x4 as shown

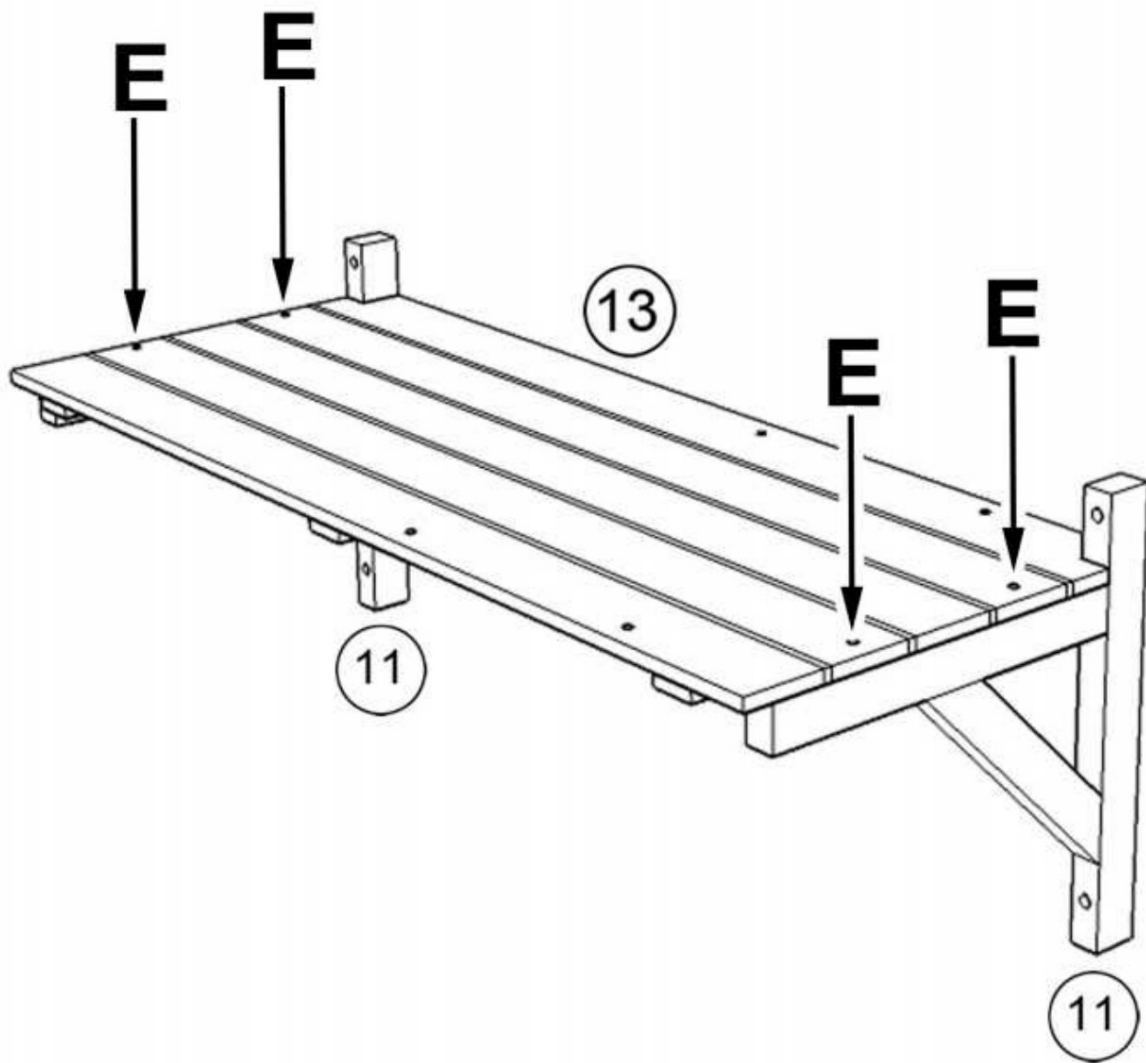

STEP:7

Mounting the shelf to the right side of board as shown with screws (B)x4 at your preferred height

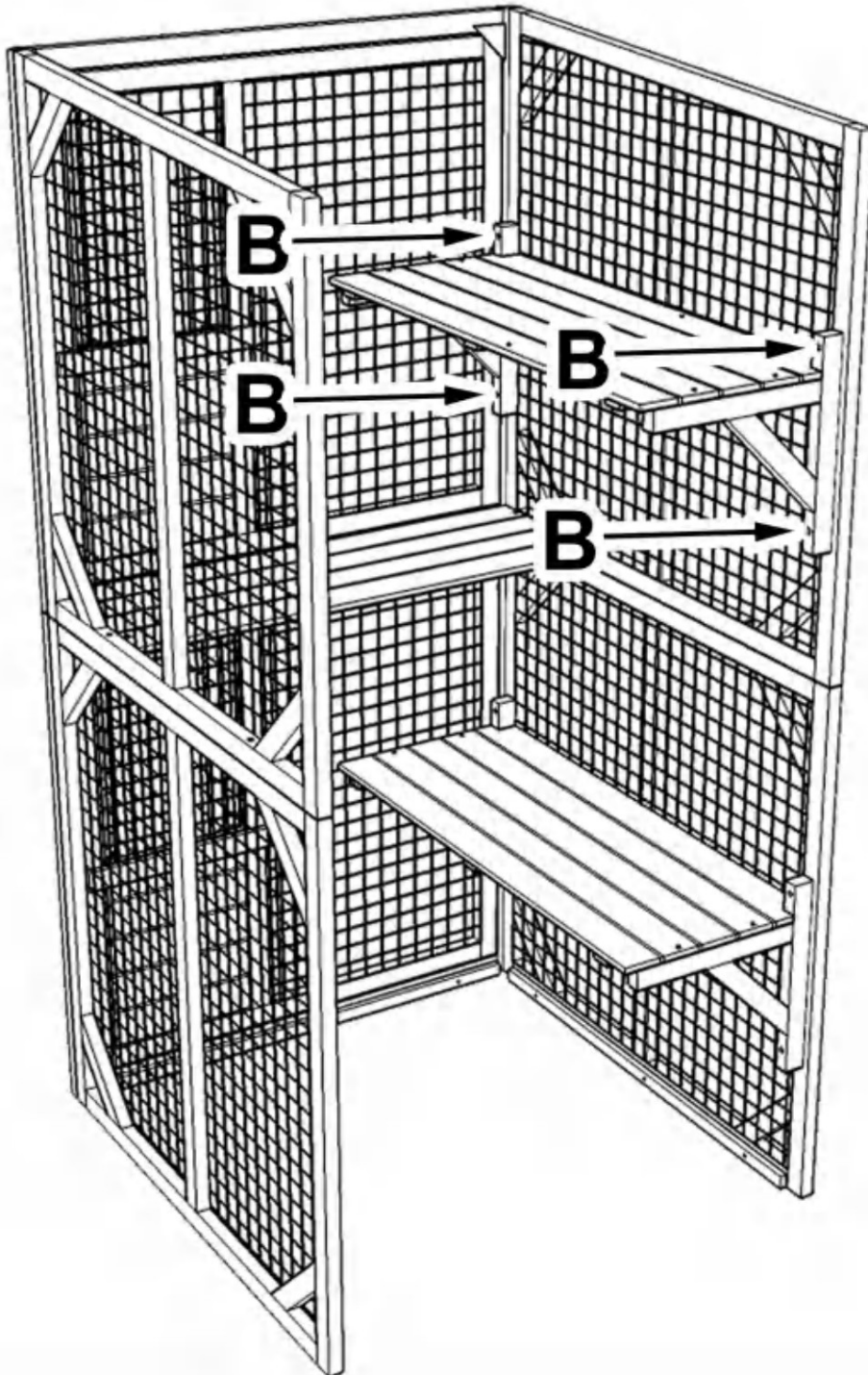

STEP:8

Assembling sleeping box with part #16x2, #17, #15 using screws (E)x10

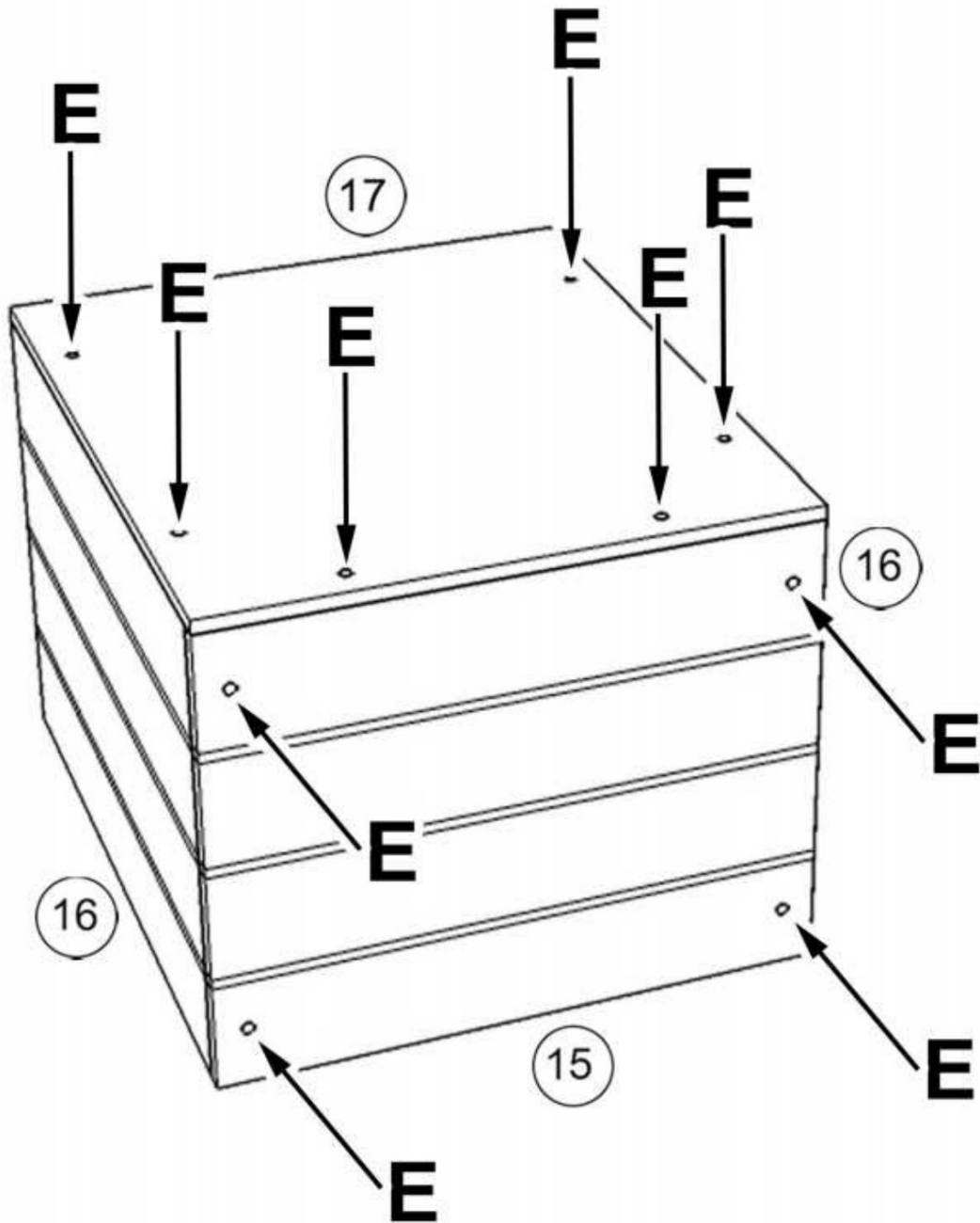

STEP:9

Placing sleeping box on the top of shelf as shown and secure it with screws (E)x4 from the bottom of shelf

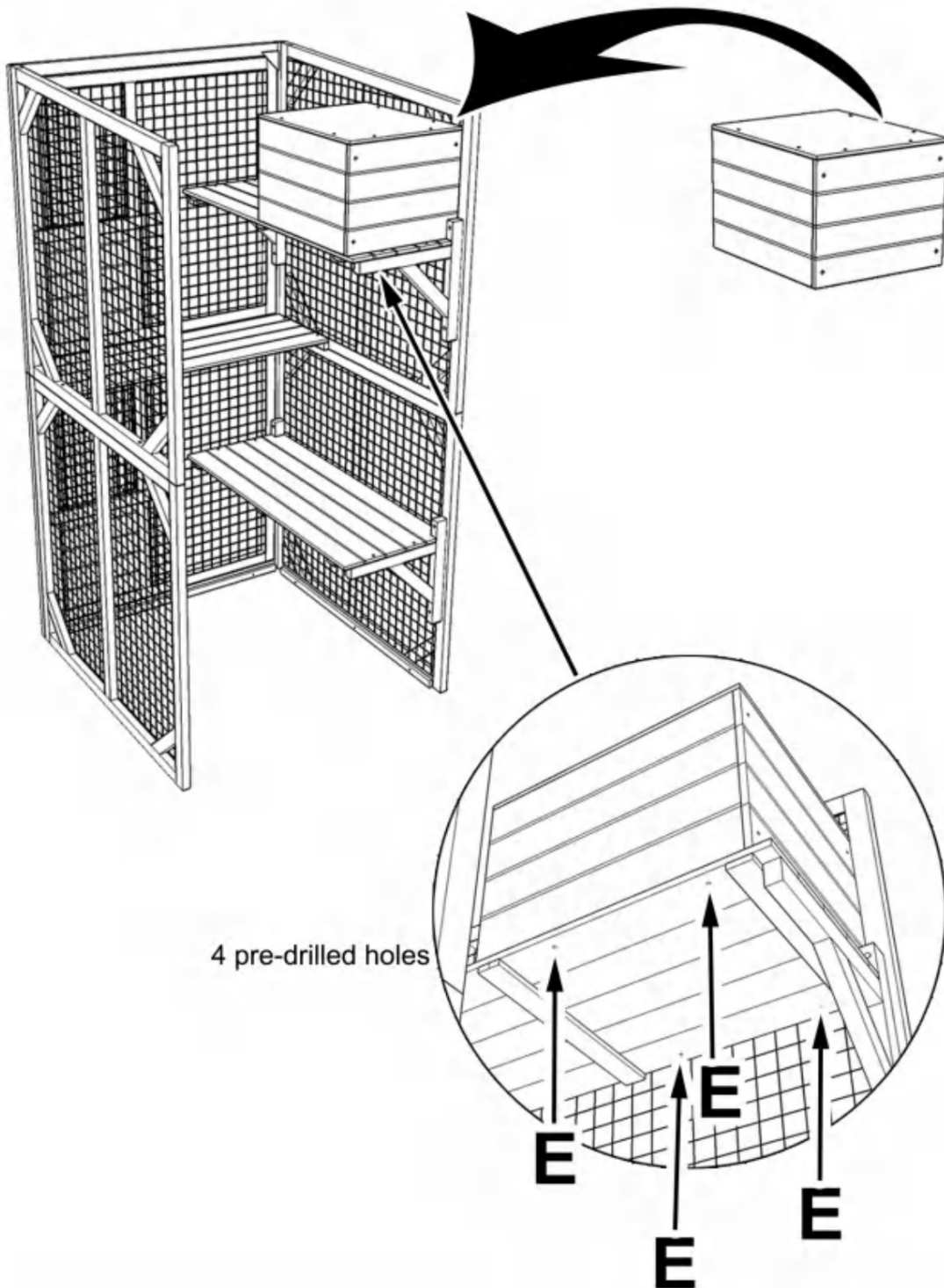

STEP:10

Assembling firstly part #9 (bottom) and then part #8 (2 holes at bottom) with screws (C)x8, then secure the 2 parts by screwing (A)x2 downwards as shown

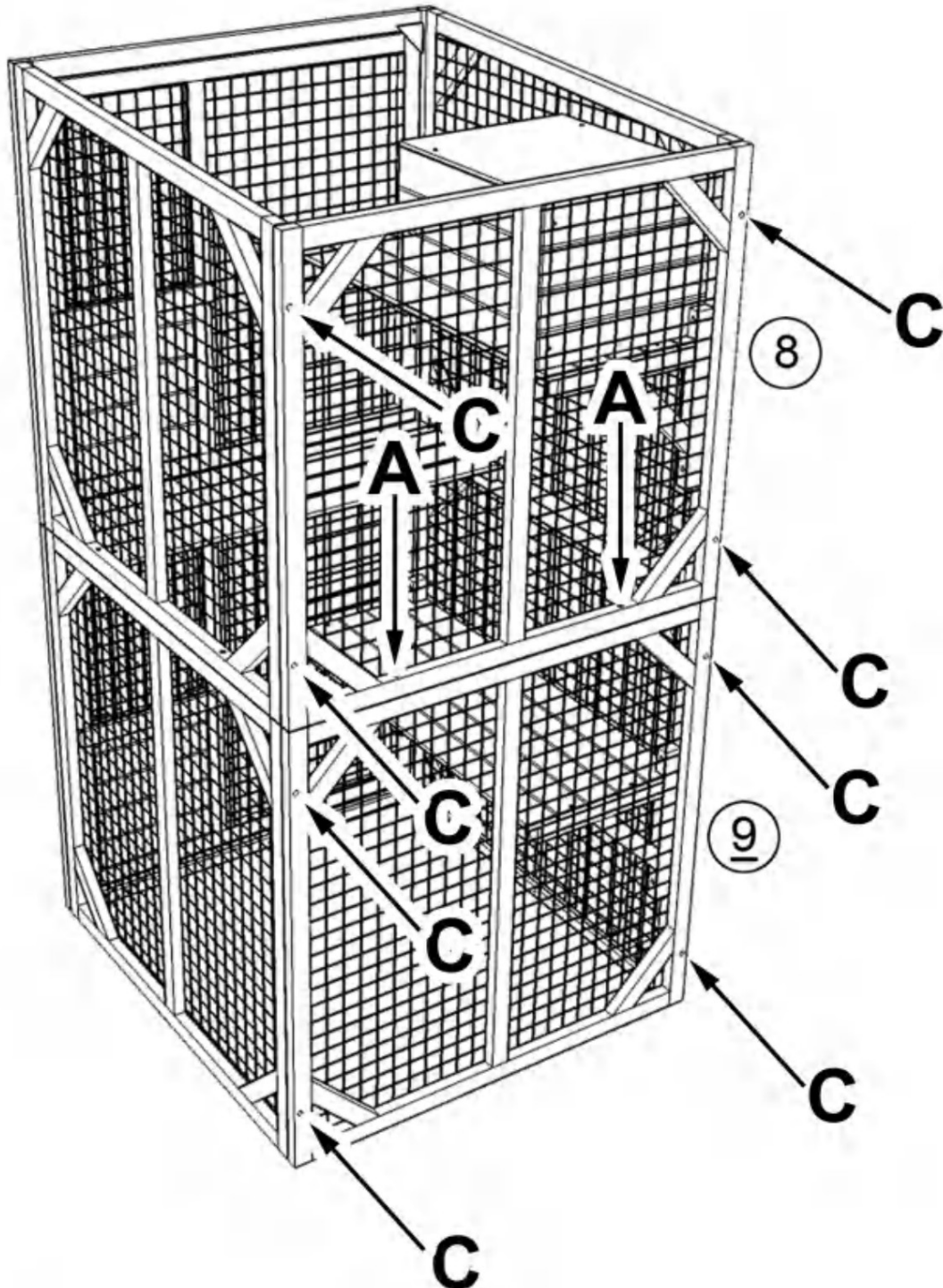

STEP:11

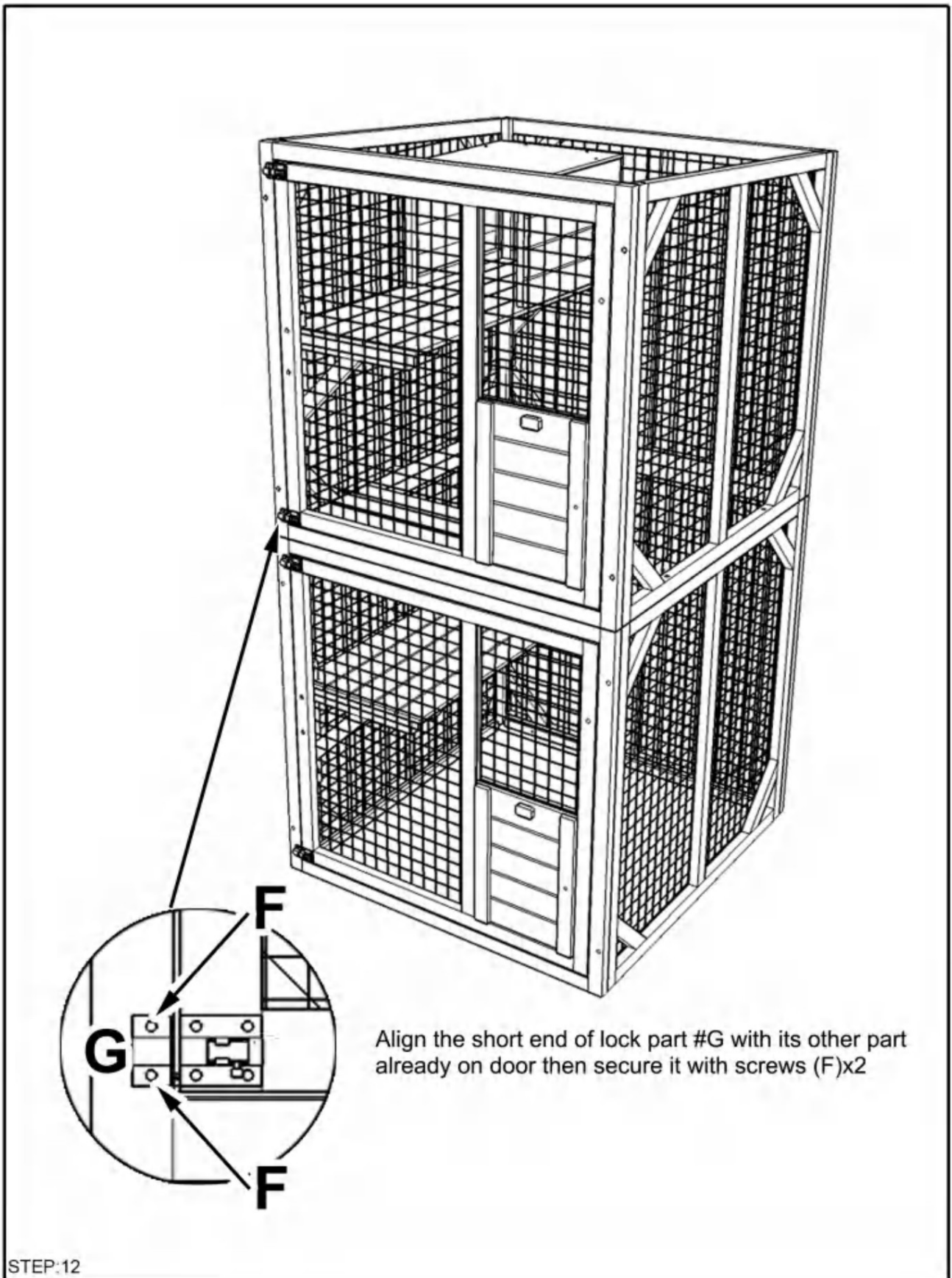

STEP:12

Install handles parts #19x2 on doors with screws (C)x4 as shown

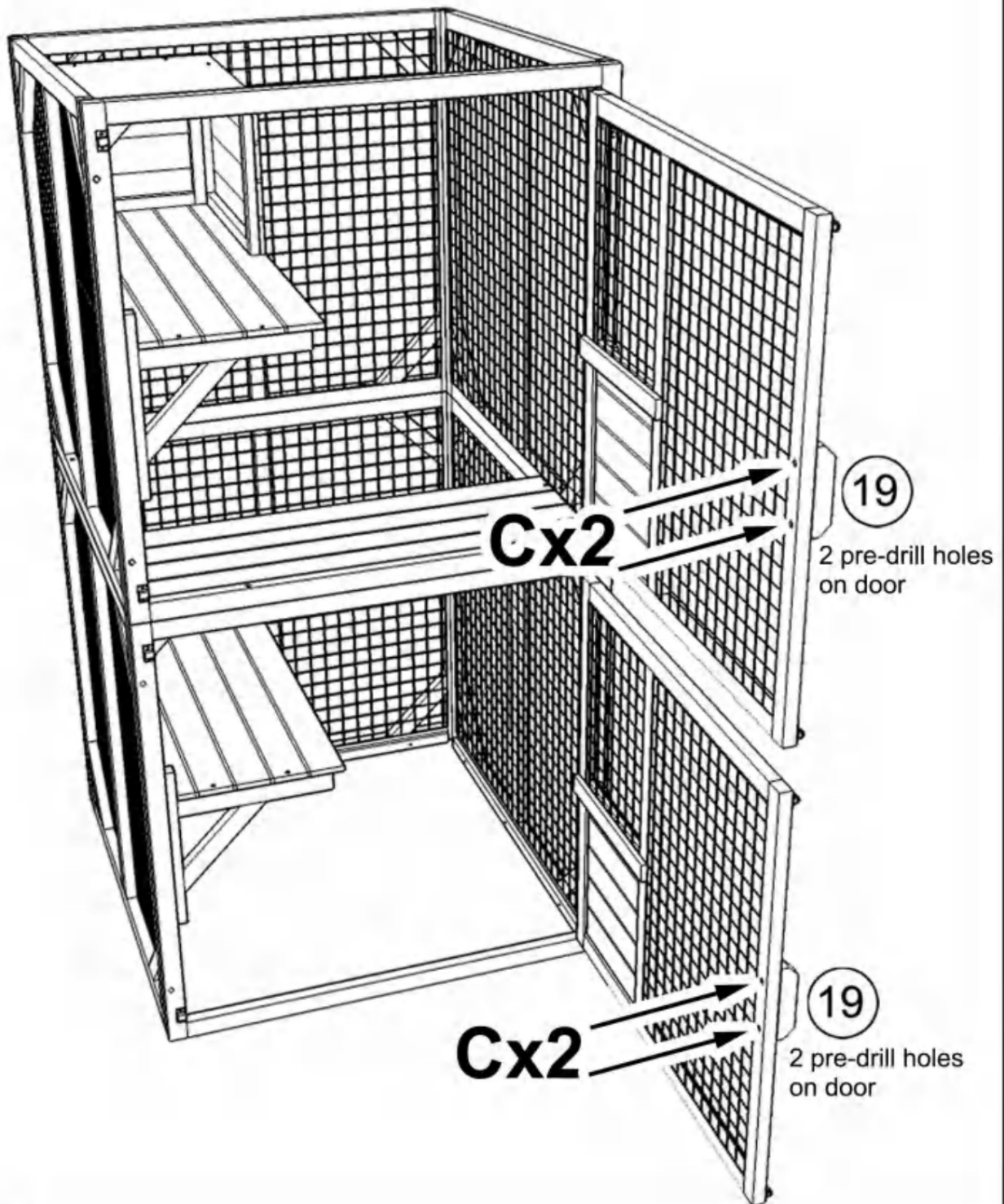

STEP:13

Install hooks as shown, long part is on the sliding door, short part is on the frame wood

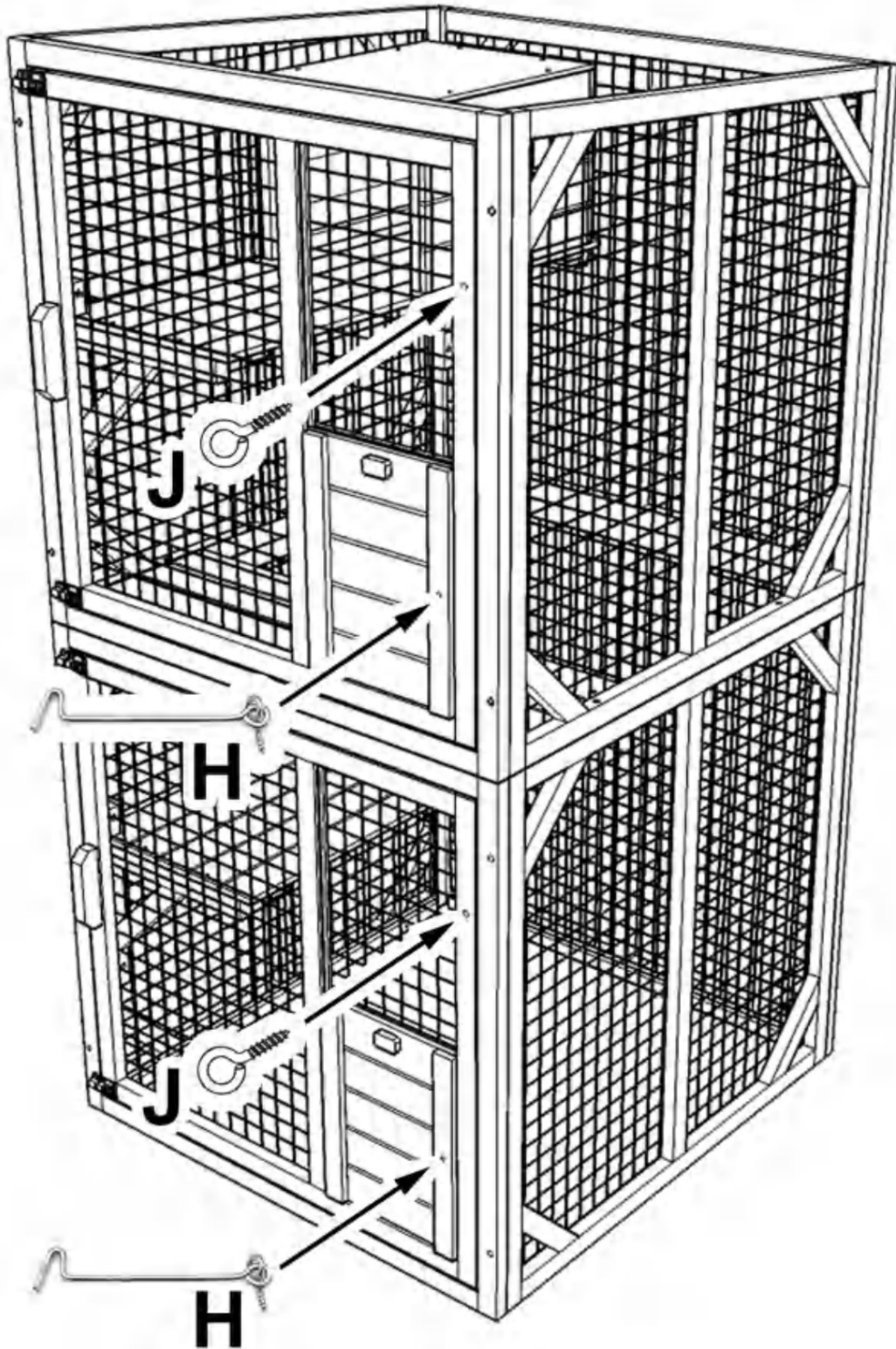

STEP:14

Gently let down the product, install part #7x4 as shown by screws (C)x12

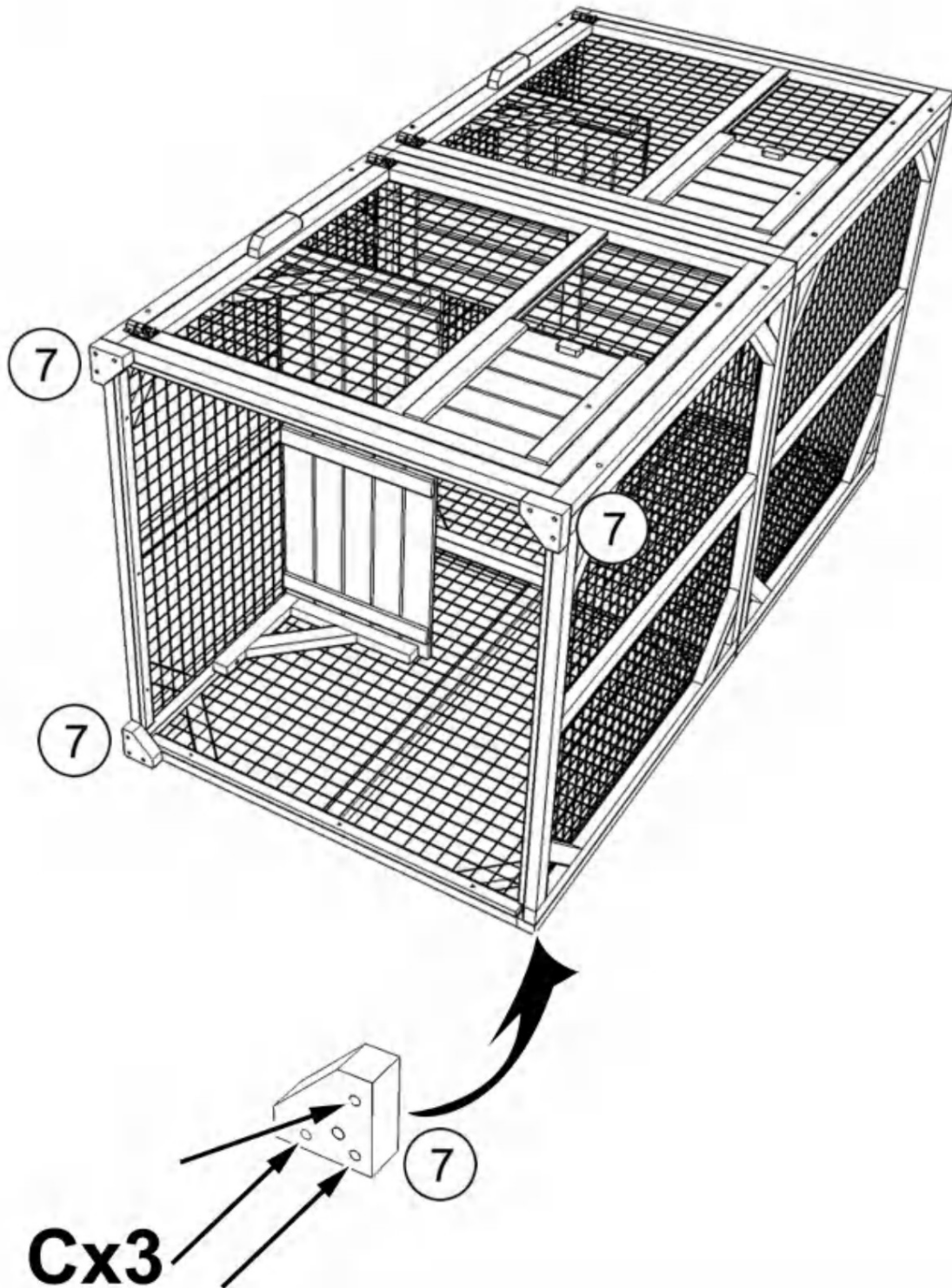

STEP:15

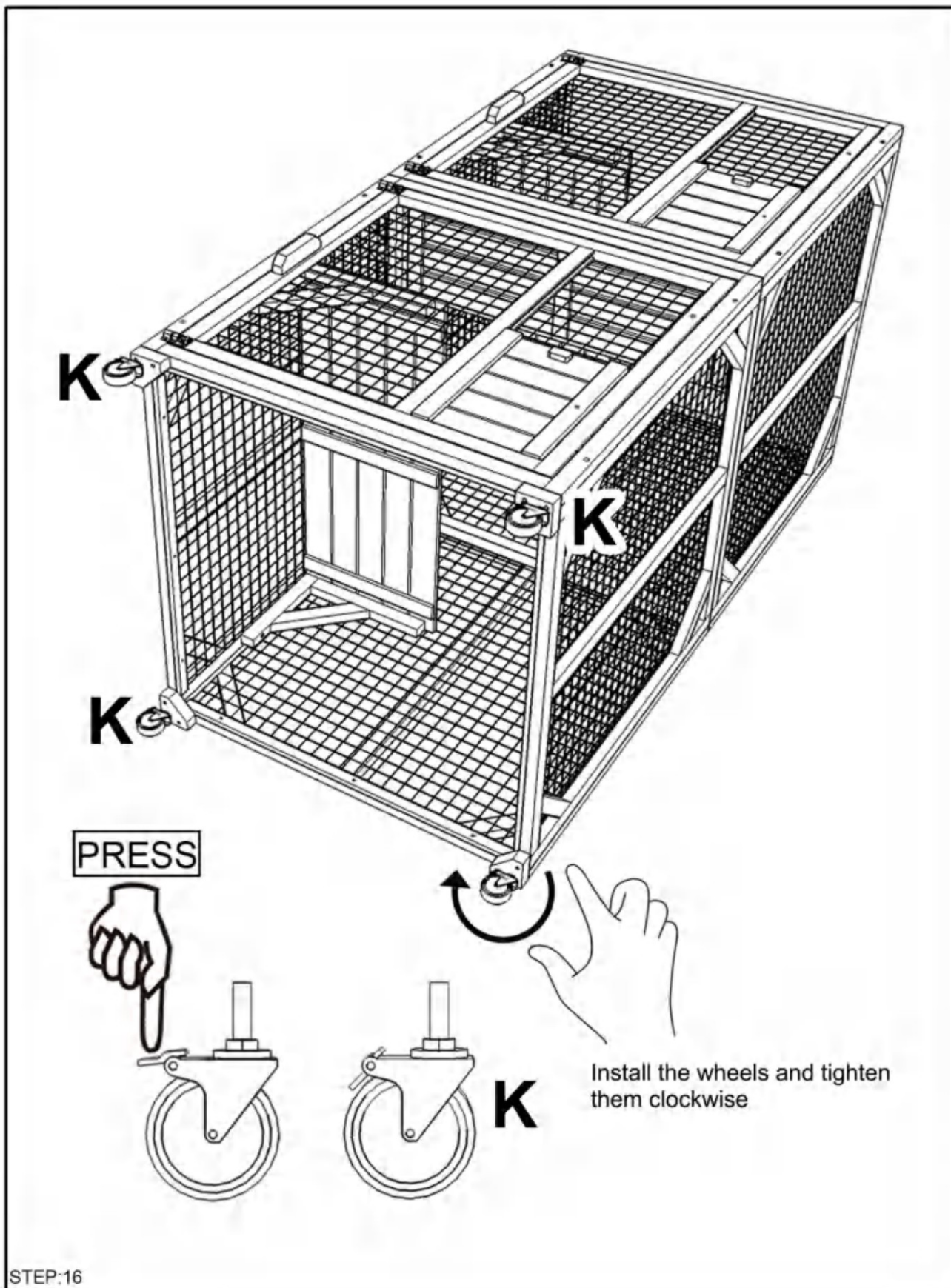

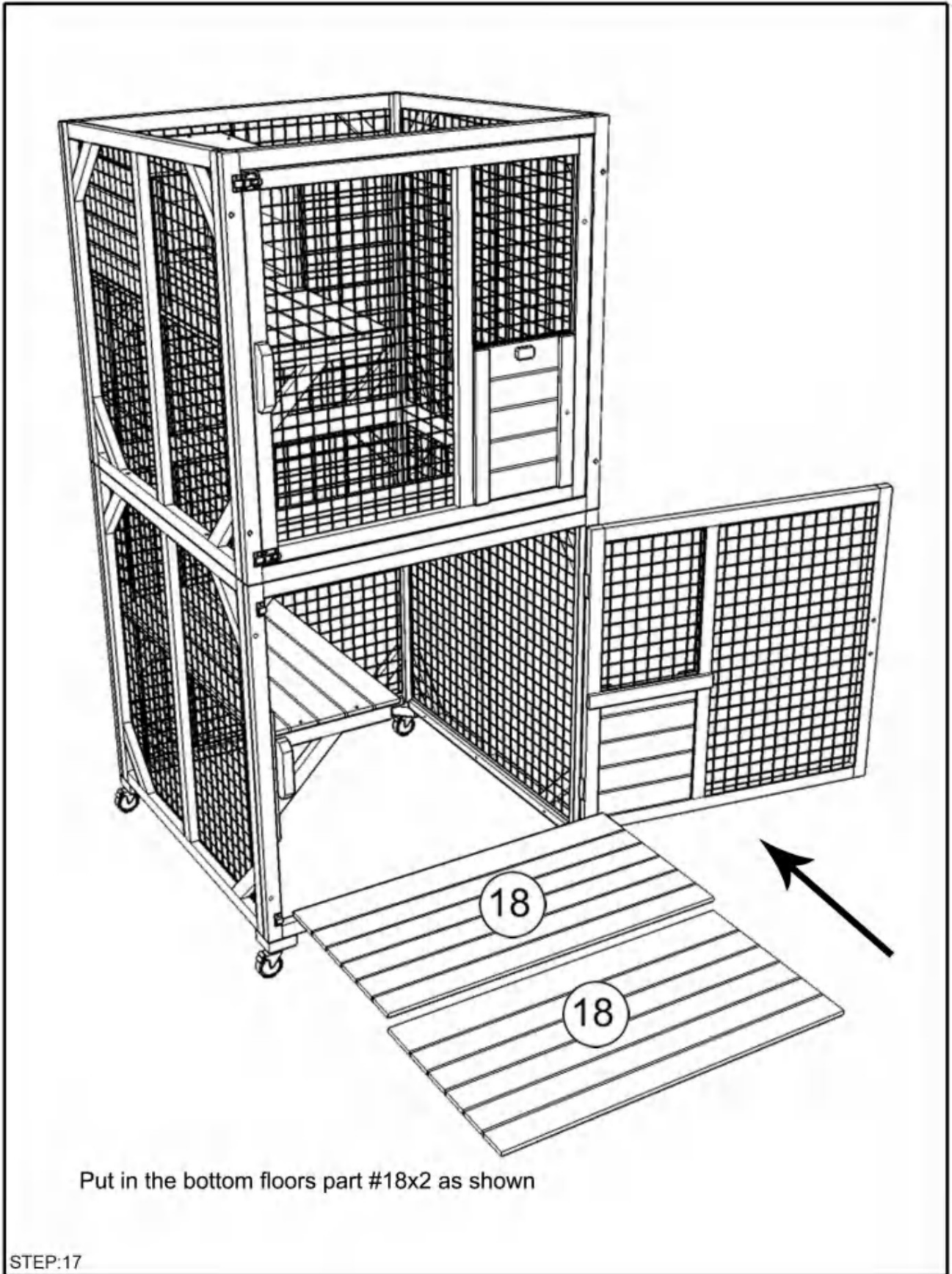

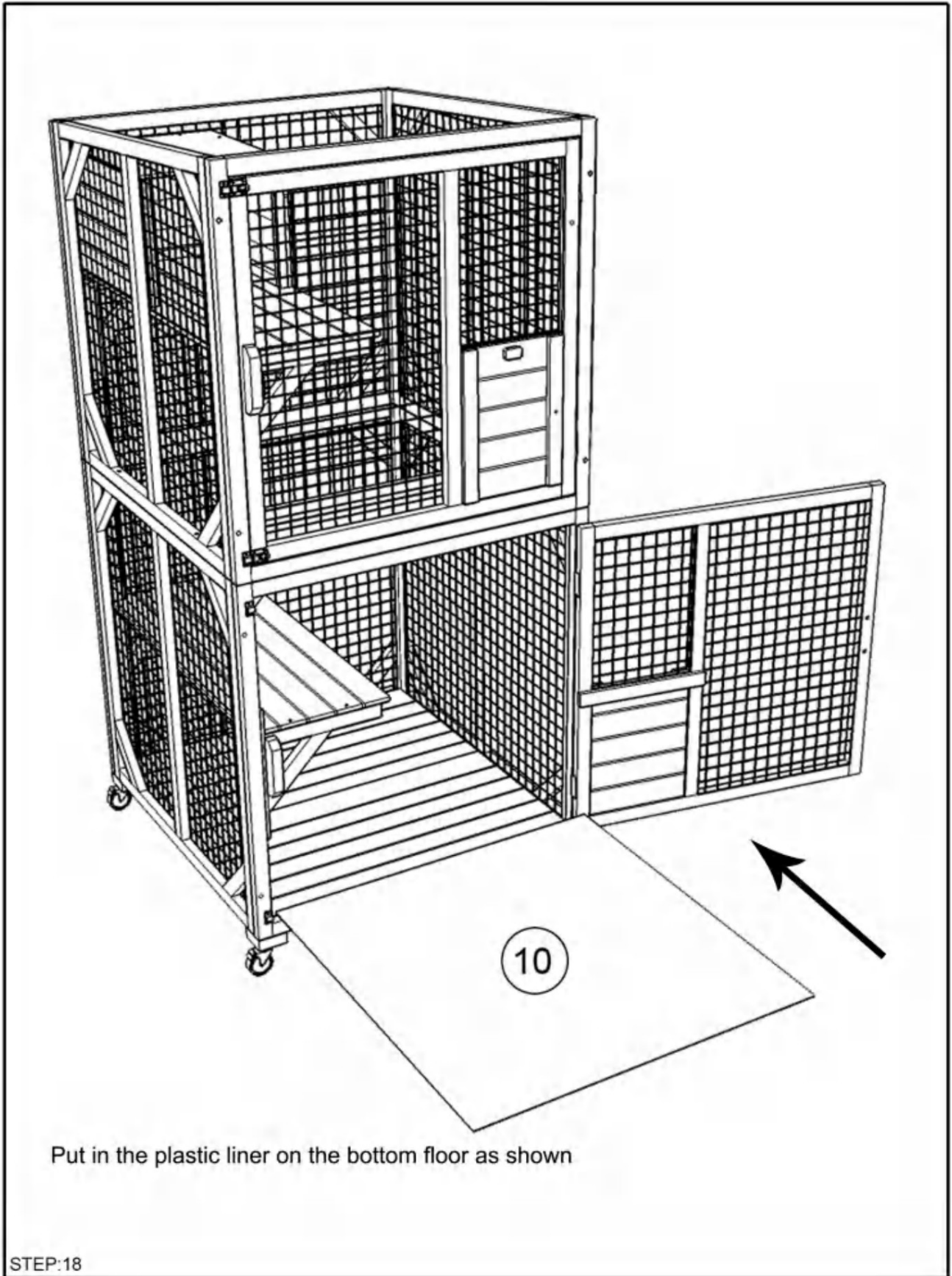

Install the felted roof part #3 with screws (D)x8

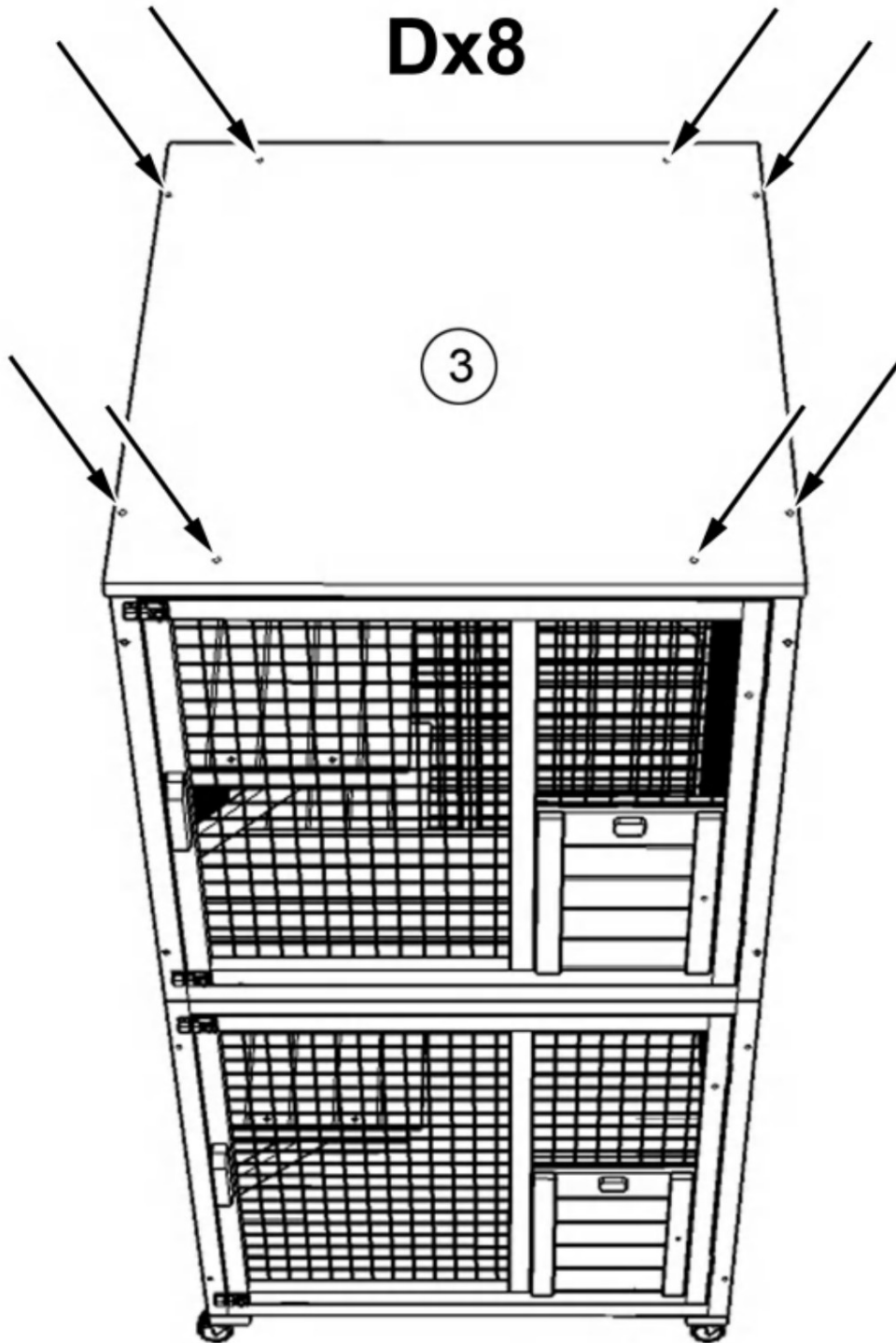

STEP:19

Shuangchenglu 803nong11hao1602A-1609shi, baoshanqu,
shanghai 200000 CN.



Azienda: E-CrossStu GmbH.

Mainzer Landstr.69, 60329
Francoforte sul Meno.



CONSULENZA YH LIMITATA.

C/O YH Consulting Limited Ufficio 147,
Centurion House, London Road, Staines-
upon-Thames, Surrey, TW18 4AX

Importato negli USA: Sanven Technology Ltd., Suite 250, 9166
Anaheim Place, Rancho Cucamonga, CA 91730

VEVOR[®]

TOUGH TOOLS, HALF PRICE

Technical Support and E-Warranty Certificate

www.vevor.com/support