

VEVOR[®]

TOUGH TOOLS, HALF PRICE

Technical Support and E-Warranty Certificate

www.vevor.com/support

PROJECTION SCREEN

USER MANUAL

MODEL NO.: YD-90, YD-135, YD-150, YD-180

We continue to be committed to provide you tools with competitive price.

"Save Half", "Half Price" or any other similar expressions used by us only represents an estimate of savings you might benefit from buying certain tools with us compared to the major top brands and does not necessarily mean to cover all categories of tools offered by us. You are kindly reminded to verify carefully when you are placing an order with us if you are actually saving half in comparison with the top major brands.

VEVOR®

TOUGH TOOLS, HALF PRICE

Projection Screen

MODEL NO.: YD-90, YD-135, YD-150, YD-180

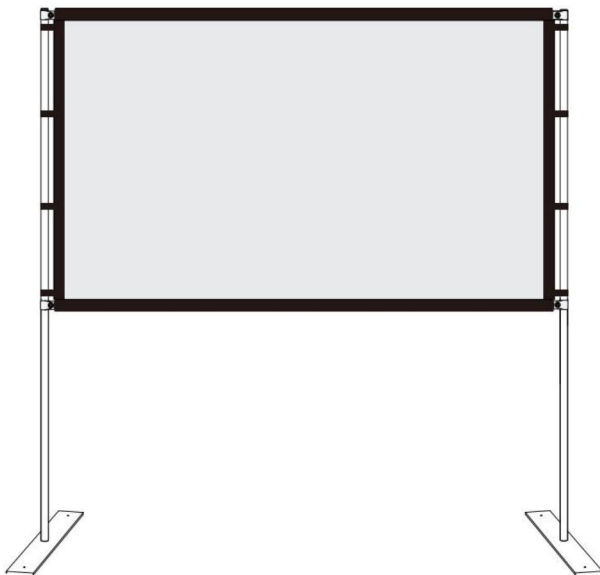

NEED HELP? CONTACT US!

Have product questions? Need technical support? Please feel free to contact us:

Technical Support and E-Warranty Certificate
www.vevor.com/support

This is the original instruction, please read all manual instructions carefully before operating. VEVOR reserves a clear interpretation of our user manual. The appearance of the product shall be subject to the product you received. Please forgive us that we won't inform you again if there are any technology or software updates on our product.

 **WARNING:**

Please read this manual carefully before using the product. Failure to do so may result in serious injury. SAVE THESE INSTRUCTION

ASSEMBLY PRECAUTIONS

1. Assemble only according to these instructions. Improper assembly can create hazards.
2. Wear ANSI-approved safety goggles and work gloves during assembly.
3. Keep the assembly area clean and well-lit.
4. Keep bystanders out of the area during assembly.
5. Do not assemble when tired or under the influence of alcohol, drugs or medication.
6. The product capabilities apply to properly and completely assembled products only.
7. Assemble on a flat, level, hard and smooth surface capable of safely supporting the Projection Screen.
8. For additional information regarding the parts listed in the following pages, please refer to the Assembly Diagram of this manual. Unwrap and separate all parts in a clean work area.
9. The warranty will only be valid if you follow the instructions below carefully! Improper use and care may cause serious injury and/or damage!
10. Make sure the surface you have chosen for installing the screen is flat and secure.. Please read the following as any damage to the screen surface will impact the image's quality:
 - A. Do not touch the screen surface by hand.
 - B. Do not write or draw on the screen surface.
 - C. Do not poke the screen surface with finger or edge tools as it may cause scratches or tears.
11. Retract the screen after every use.
12. Do not pull two sides of the screen fabric by hands, do not fold the screen fabric.

13. To prevent unnecessary damage, the operation and maintenance of the screen should be done by adult.



Ignoring the safety warnings may lead to injuries or damaging the product.



Retract the screen after every use. Leave it hanging for a long period may cause screen fabric to become loose.



Avoid hanging anything on the screen as it may cause the screen to fall down.



The screen should be installed at a secure place to avoid any accidents or the screen falling down.



Loose parts may cause the screen to fall down.

USE PRECAUTIONS

TO PREVENT SERIOUS INJURY AND DEATH FROM TIPPING:

1. DO NOT SIT OR STAND ON THIS ITEM.

2. This product is not a toy. Do not allow children to play with or near this item.
3. Use only on a flat, level, hard and smooth surface capable of safely supporting a fully loaded Projection Screen.
4. Use as intended only.
5. Inspect before every use. Do not use if parts are loose or damaged.
6. Clear out an area to assemble the screen. Make sure the area is larger than the size of the screen.
7. Remember that the assembly will require at least two people for some steps.
8. Do not assemble in areas with a high temperature to avoid damaging the screen.
9. Read through this entire Assembly Guide before.

SAVE THESE INSTRUCTIONS

TECHNICAL SPECIFICATIONS

Model	YD-90	YD-135
Screen Size	90 inch, 16:9	135 inch, 16:9
Product Dimensions (LxWxH)(mm)	2216*400*1930	3346*400*2400
Packing Size (LxWxH)(mm)	1060*130*115	1110*170*130
Net Weight (kg)	About 5.1	About 6.5
Gross Weight (kg)	About 5.6	About 7

Model	YD-150	YD-180
Screen Size	150 inch, 16:9	180 inch, 16:9
Product Dimensions (LxWxH)(mm)	3576*400*2550	4236*400*2850
Packing Size (LxWxH)(mm)	1110*170*130	1110*170*130
Net Weight (kg)	About 6.8	About 7.6
Gross Weight (kg)	About 7.3	About 8.1

PACKAGE CONTENTS

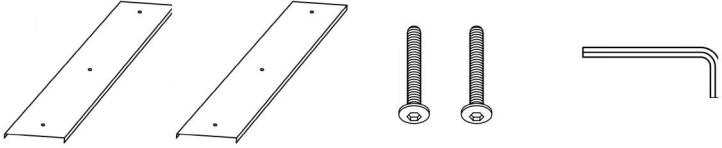

standing feet standing feet bolt + screwdriver

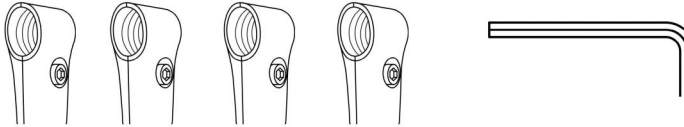

connector + connector screwdriver



projector screen fabric

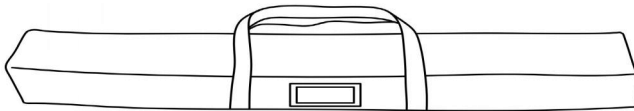

carrying bag

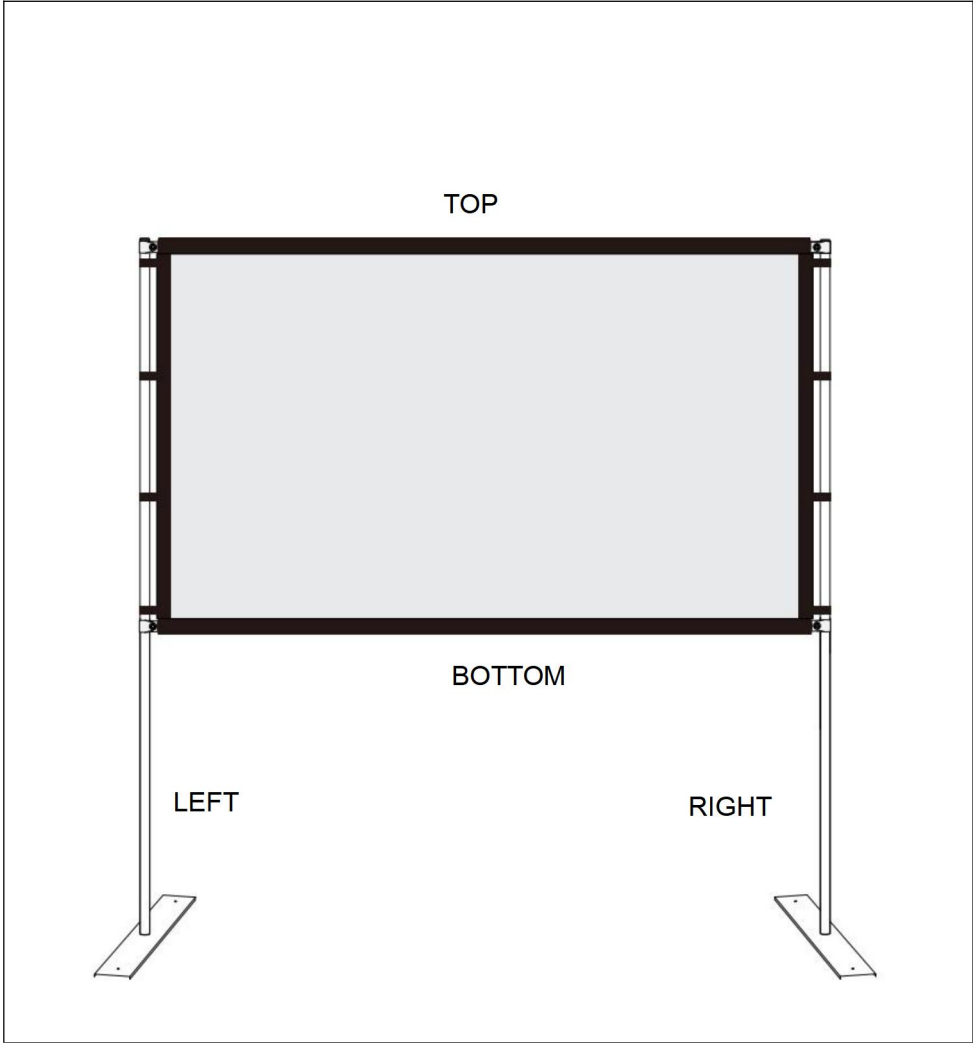

ASSEMBLY STEPS

STEP1

- Press the button snap, assemble the 4 sets of poles top, bottom, left and right.

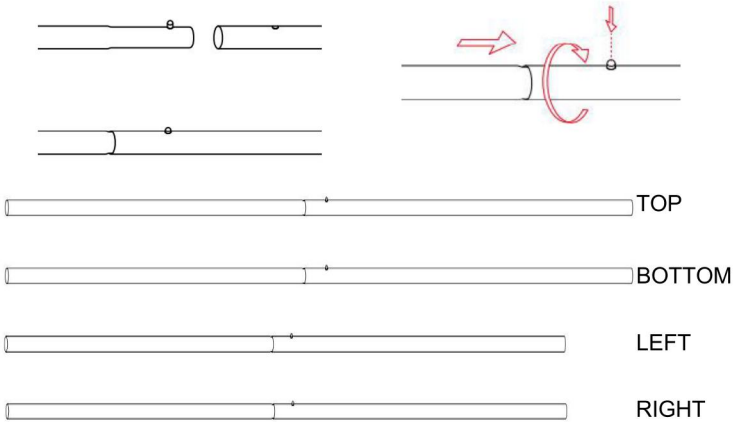

STEP2

- Attach the vertical poles (LEFT & RIGHT) to the feet using the included bolts and screwdriver.

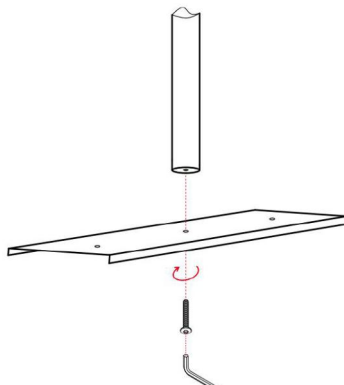

STEP3

- Slide the horizontal poles (TOP & BOTTOM) through the top and bottom pole pocket.

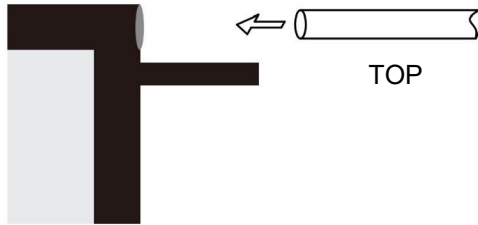

STEP4

- Attach the horizontal poles (TOP & BOTTOM) to the vertical poles (LEFT & RIGHT) by the metal connectors. Use the velcro on the fabric to fix the vertical poles, make the screen tight and smooth.

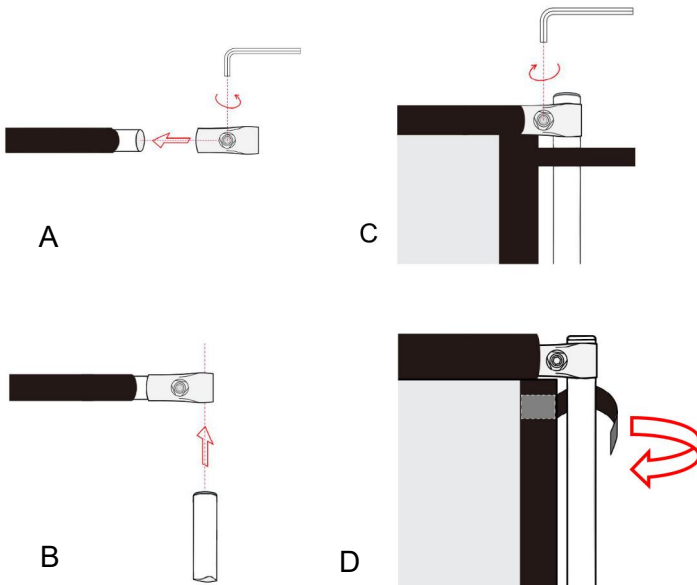

COMPLETION

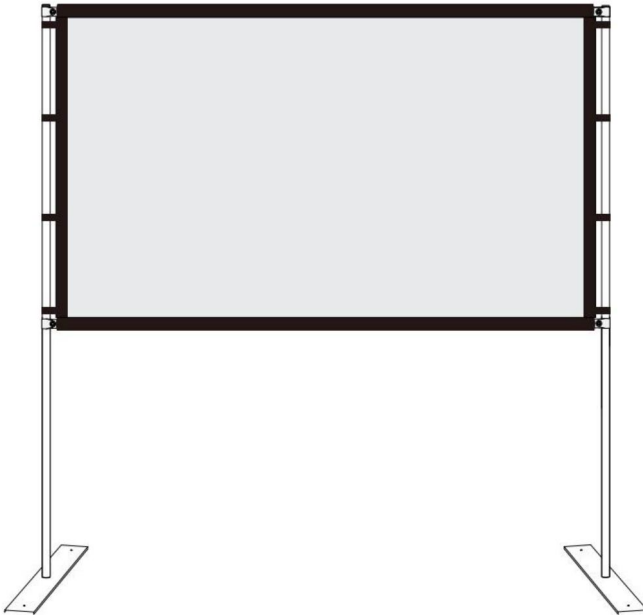

Manufacturer: Shanghaimuxinmuyeyouxiangongsi

Address: Shuangchenglu 803nong11hao1602A-1609shi, baoshanqu, shanghai 200000 CN.

Imported to AUS: SIHAO PTY LTD. 1 ROKEVA STREETEASTWOOD NSW 2122 Australia

Imported to USA: Sanven Technology Ltd. Suite 250, 9166 Anaheim Place, Rancho Cucamonga, CA 91730

EC	REP
-----------	------------

E-CrossStu GmbH
Mainzer Landstr.69, 60329 Frankfurt am Main.

UK	REP
-----------	------------

YH CONSULTING LIMITED.
C/O YH Consulting Limited Office 147, Centurion House, London Road, Staines-upon-Thames, Surrey, TW18 4AX

VEVOR[®]

TOUGH TOOLS, HALF PRICE

Technical Support and E-Warranty Certificate

www.vevor.com/support

VEVOR[®]

TOUGH TOOLS, HALF PRICE

Techniczny Wsparcie i certyfikat e-gwarancji

www.vevor.com/support

EKRAN PROJEKCYJNY

INSTRUKCJA OBSŁUGI

NR MODELU: YD-90, YD-135, YD-150, YD-180

We continue to be committed to provide you tools with competitive price.

"Save Half", "Half Price" or any other similar expressions used by us only represents an estimate of savings you might benefit from buying certain tools with us compared to the major top brands and does not necessarily mean to cover all categories of tools offered by us. You are kindly reminded to verify carefully when you are placing an order with us if you are actually saving half in comparison with the top major brands.

VEVOR®

TOUGH TOOLS, HALF PRICE

Projection Screen

NR MODELU: YD-90, YD-135, YD-150, YD-180

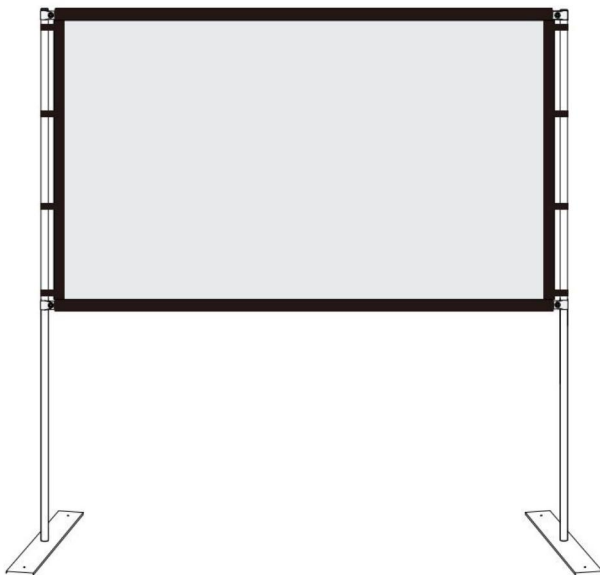

NEED HELP? CONTACT US!

Have product questions? Need technical support? Please feel free to contact us:

Technical Support and E-Warranty Certificate
www.vevor.com/support

This is the original instruction, please read all manual instructions carefully before operating. VEVOR reserves a clear interpretation of our user manual. The appearance of the product shall be subject to the product you received. Please forgive us that we won't inform you again if there are any technology or software updates on our product.



OSTRZEŻENIE:

uważnie przeczytać tę instrukcję. Nieprzestrzeganie jej może spowodować poważne obrażenia. ZACHOWAJ TE INSTRUKCJA

ASSEMBLY PRECAUTIONS

1. Montaż należy wykonywać wyłącznie zgodnie z niniejszą instrukcją. Nieprawidłowy montaż może stwarzać zagrożenia.
2. Podczas montażu należy nosić okulary ochronne i rękawice robocze zatwierdzone przez ANSI.
3. Utrzymuj miejsce zgromadzenia w czystości i zapewnij dobre oświetlenie.
4. Nie dopuszczać osób postronnych na teren montażu podczas jego trwania.
5. Nie przychodź na spotkania, jeśli jesteś zmęczony lub pod wpływem alkoholu, narkotyków lub leków.
6. Możliwości produktu odnoszą się wyłącznie do produktów prawidłowo i kompletnie zmontowanych.
7. Montaż należy wykonać na płaskiej, równej, twardej i gładkiej powierzchni, zapewniającej bezpieczne utrzymanie ekranu projekcyjnego.
8. Aby uzyskać dodatkowe informacje dotyczące części wymienionych na kolejnych stronach, zapoznaj się ze schematem montażu w tym podręczniku. Rozpakuj i oddziel wszystkie części w czystym miejscu pracy.
9. Gwarancja będzie ważna tylko wtedy, gdy będziesz dokładnie przestrzegać poniższych instrukcji! Niewłaściwe użytkowanie i pielęgnacja mogą spowodować poważne obrażenia i/lub uszkodzenia!
10. Upewnij się, że powierzchnia, którą wybrałeś do zainstalowania ekranu, jest płaska i bezpieczna. Przeczytaj poniższe informacje, ponieważ jakiegokolwiek uszkodzenie powierzchni ekranu będzie miało wpływ na jakość obrazu:
 - A. Nie dotykaj powierzchni ekranu rękami.

- B. Nie pisz i nie rysuj na powierzchni ekranu.
- C. Nie należy dotykać powierzchni ekranu palcami ani ostrymi narzędziami, ponieważ może to spowodować zarysowania lub rozdarcia.
11. Po każdym użyciu należy schować ekran.
12. Nie należy ciągnąć ręcznie za dwa boki materiału ekranu, nie należy go składać.
13. Aby zapobiec niepotrzebnym uszkodzeniom, obsługę i konserwację ekranu powinna wykonywać osoba dorosła.



Ignoring the safety warnings may lead to injuries or damaging the product.



The screen should be installed at secure place to avoid any accidents or the screen falling down



Retract the screen after every use. Leave it hanging for along period may cause screen fabric loose.



Loose parts may cause the screen fall down.



Avoid hanging anything on the screen as it may cause the screen to fall down.

USE PRECAUTIONS

ABY ZAPOBIEC POWAŻNYM OBRAŻENIOM I ŚMIERCI SPOWODOWANEJ PRZEWRÓCENIEM:

1. **NIE SIADAĆ ANI NIE STAWAĆ NA TYM PRZEDMIOCIE.**
2. Ten produkt nie jest zabawką. Nie pozwalaj dzieciom bawić się tym przedmiotem ani przebywać w jego pobliżu.
3. Używać wyłącznie na płaskiej, równej, twardej i gładkiej powierzchni, która może bezpiecznie utrzymać w pełni załadowany ekran projekcyjny.
4. Stosować wyłącznie zgodnie z przeznaczeniem.
5. Sprawdź przed każdym użyciem. Nie używaj, jeśli części są luźne lub uszkodzone.
6. Wyczyść obszar, aby złożyć ekran. Upewnij się, że obszar jest większy niż rozmiar ekranu.

7. Pamiętaj, że do wykonania niektórych czynności potrzebne będą co najmniej dwie osoby.
8. Aby uniknąć uszkodzenia ekranu, nie należy montować w miejscach o wysokiej temperaturze.
9. Przed montażem należy dokładnie zapoznać się z treścią niniejszego Poradnika montażu.

ZAPISZ TE INSTRUKCJE

TECHNICAL SPECIFICATIONS

Model	YD-90	YD-135
Rozmiar ekranu	90 cali, 16:9	135 cali, 16:9
Wymiary produktu (Dł. x Szer. x Wys.) (mm)	2216*400*1930	3346*400*2400
Rozmiar opakowania (Dł. x Szer. x Wys.) (mm)	1060*130*115	1110*170*130
Masa netto (kg)	Okolo 5.1	Okolo 6,5
Masa brutto (kg)	Okolo 5.6	Okolo 7

Model	YD-150	YD-180
Rozmiar ekranu	150 cali, 16:9	180 cali, 16:9
Wymiary produktu (Dł. x Szer. x Wys.) (mm)	3576*400*2550	4236*400*2850
Rozmiar opakowania (Dł. x Szer. x Wys.) (mm)	1110*170*130	1110*170*130
Masa netto (kg)	Okolo 6,8	Okolo 7,6

Masa brutto (kg)	Okolo 7.3	Okolo 8.1
------------------	-----------	-----------

PACKAGE CONTENTS

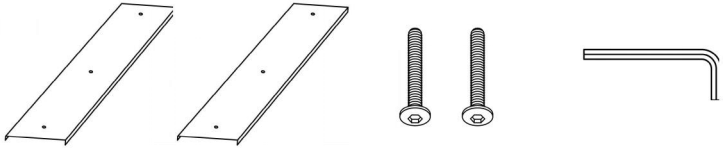

standing feet standing feet bolt + screwdriver

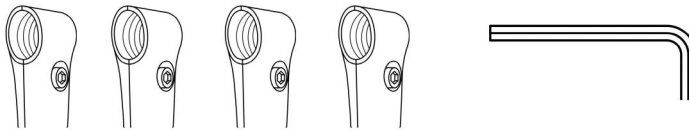

connector + connector screwdriver



projector screen fabric

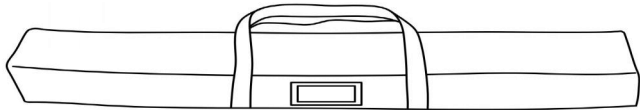

carrying bag

TOP

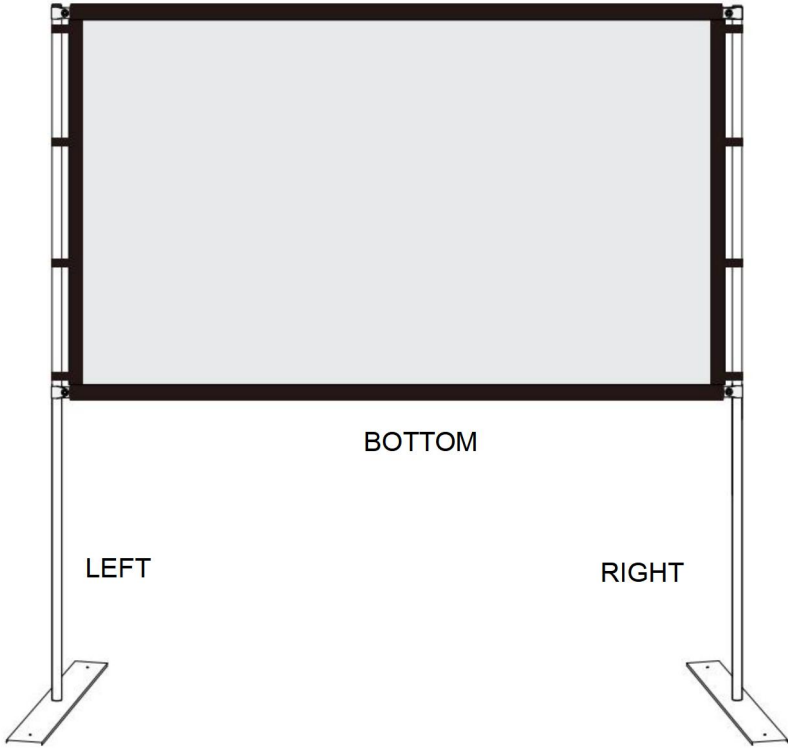

BOTTOM

LEFT

RIGHT

ASSEMBLY STEPS

KROK 1

- Naciśnij przycisk zatraskowy, złoż 4 zestawy słupków: górny, dolny, lewy i prawy.

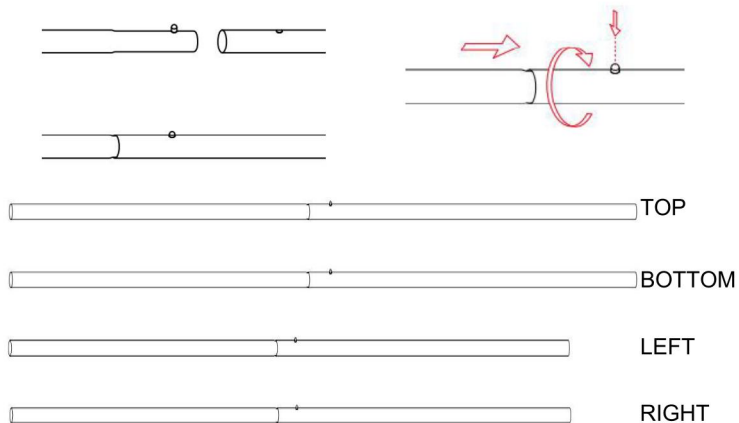

KROK 2

- Przymocuj pionowe drążki (LEWY i PRAWY) do nogi za pomocą dołączonych śrub i śrubokręta .

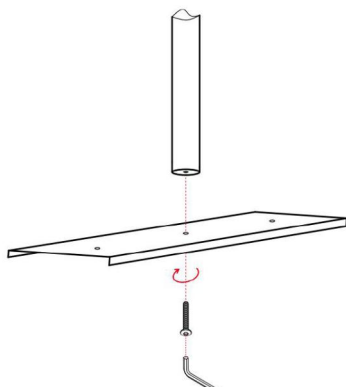

KROK 3

- Przesuń poziome drążki (GÓRA I DÓŁ) przez górną i dolną kieszeń na drążki.

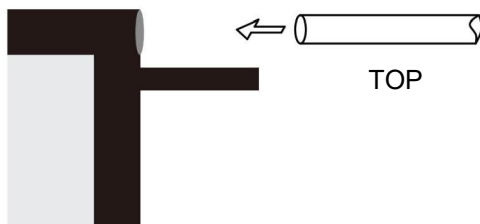

KROK 4

- Przymocuj poziome drążki (GÓRA i DÓŁ) do pionowych drążków (LEWY i PRAWY) za pomocą metalowych łączników. Użyj rzepu na tkaninie, aby przymocować pionowe drążki, aby ekran był szczelny i gładki.

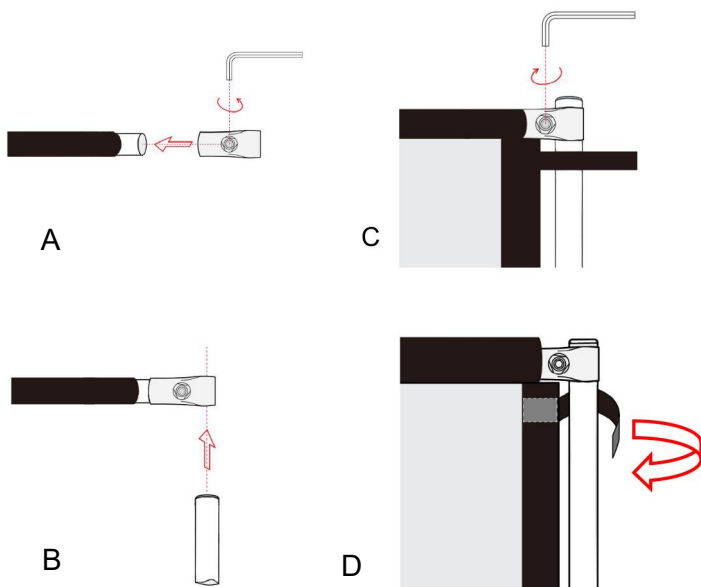

COMPLETION

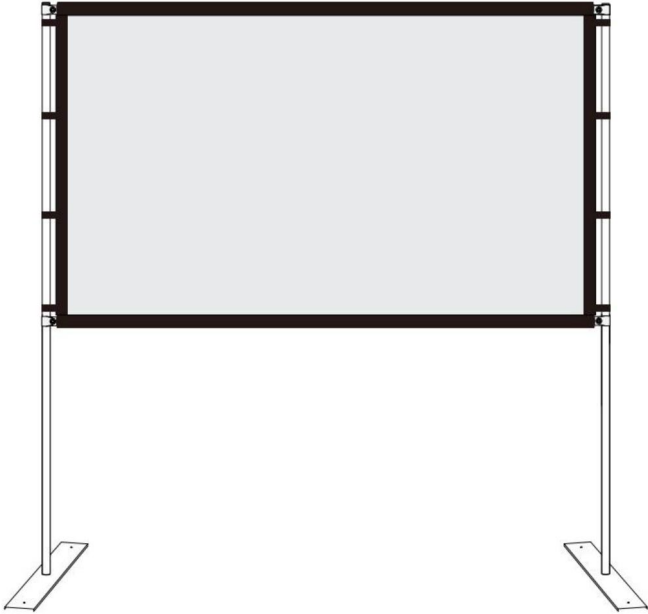

Producent: Shanghaimuxinmuyeyouxiangongsi

Adres: Shuangchenglu 803nong11hao1602A-1609shi, baoshanqu, szanghaj 200000 CN.

Importowane do AUS: SIHAO PTY LTD. 1 ROKEVA
STREETEASTWOOD NSW 2122 Australia

Importowane do USA: Sanven Technology Ltd. Suite 250, 9166 Anaheim
Place, Rancho Cucamonga, CA 91730

EC	REP
-----------	------------

E-CrossStu GmbH
Mainzer Landstr.69, 60329 Frankfurt am Main.

UK	REP
-----------	------------

YH CONSULTING LIMITED.
C/O YH Consulting Limited Office 147, Centurion
House, London Road, Staines-upon-Thames, Surrey,
TW18 4AX

VEVOR[®]

TOUGH TOOLS, HALF PRICE

Techniczny Wsparcie i certyfikat e-gwarancji

www.vevor.com/support

VEVOR[®]

TOUGH TOOLS, HALF PRICE

Technisch Support und E-Garantie-Zertifikat

www.vevor.com/support

PROJEKTIONSLEINWAND BENUTZERHANDBUCH

MODELL-NR.: YD-90, YD-135, YD-150, YD-180

We continue to be committed to provide you tools with competitive price.

"Save Half", "Half Price" or any other similar expressions used by us only represents an estimate of savings you might benefit from buying certain tools with us compared to the major top brands and does not necessarily mean to cover all categories of tools offered by us. You are kindly reminded to verify carefully when you are placing an order with us if you are actually saving half in comparison with the top major brands.

VEVOR®

TOUGH TOOLS, HALF PRICE

Projection Screen

MODELL-NR.: YD-90, YD-135, YD-150, YD-180

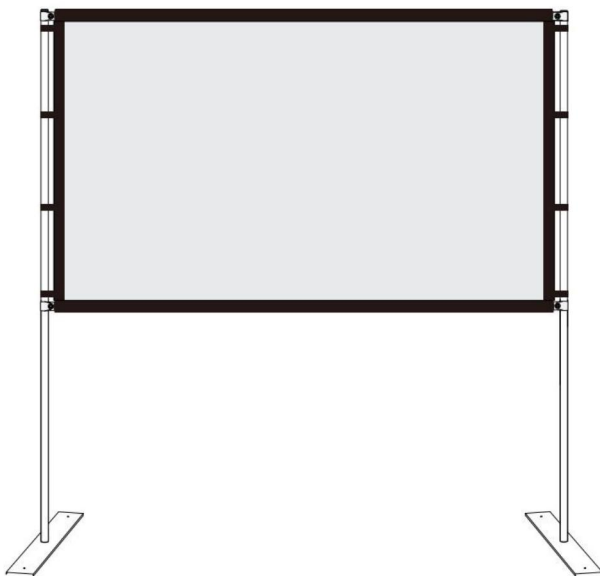

NEED HELP? CONTACT US!

Have product questions? Need technical support? Please feel free to contact us:

Technical Support and E-Warranty Certificate
www.vevor.com/support

This is the original instruction, please read all manual instructions carefully before operating. VEVOR reserves a clear interpretation of our user manual. The appearance of the product shall be subject to the product you received. Please forgive us that we won't inform you again if there are any technology or software updates on our product.

 **WARNUNG:**

, bevor Sie das Produkt verwenden. Andernfalls kann es zu schweren Verletzungen kommen. BEWAHREN SIE DIESES ANWEISUNG

ASSEMBLY PRECAUTIONS

1. Führen Sie die Montage nur gemäß dieser Anleitung durch. Eine unsachgemäße Montage kann zu Gefahren führen.
2. Tragen Sie während der Montage eine ANSI-geprüfte Schutzbrille und Arbeitshandschuhe.
3. Halten Sie den Versammlungsbereich sauber und gut beleuchtet.
4. Halten Sie während der Montage unbeteiligte Zuschauer vom Bereich fern.
5. Nicht zusammenbauen, wenn Sie müde sind oder unter Einfluss von Alkohol, Drogen oder Medikamenten stehen.
6. Die Produktfunktionen gelten nur für ordnungsgemäß und vollständig montierte Produkte.
7. Montieren Sie es auf einer flachen, ebenen, harten und glatten Oberfläche, die die Projektionsleinwand sicher tragen kann.
8. Weitere Informationen zu den auf den folgenden Seiten aufgeführten Teilen finden Sie im Montagediagramm dieses Handbuchs. Packen Sie alle Teile in einem sauberen Arbeitsbereich aus und trennen Sie sie.
9. Die Garantie gilt nur, wenn Sie die folgenden Anweisungen sorgfältig befolgen! Unsachgemäßer Gebrauch und Pflege können schwere Verletzungen und/oder Schäden verursachen!
10. Stellen Sie sicher, dass die von Ihnen für die Installation des Bildschirms gewählte Oberfläche eben und stabil ist. Beachten Sie bitte die folgenden Hinweise, da sich jegliche Beschädigung der Bildschirmoberfläche auf die Bildqualität auswirkt:
 - A. Berühren Sie die Bildschirmoberfläche nicht mit der Hand.
 - B. Schreiben oder zeichnen Sie nicht auf der Bildschirmoberfläche.
 - C. Stochern Sie nicht mit dem Finger oder mit Kantenwerkzeugen auf der Bildschirmoberfläche, da dies zu Kratzern oder Rissen führen kann.

11. Fahren Sie den Bildschirm nach jedem Gebrauch ein.
12. Ziehen Sie nicht mit der Hand an zwei Seiten des Leinwandgewebes und falten Sie das Leinwandgewebe nicht.
13. Um unnötige Schäden zu vermeiden, sollte die Bedienung und Wartung des Bildschirms von einem Erwachsenen durchgeführt werden.



Ignoring the safety warnings may lead to injuries or damaging the product.



The screen should be installed at secure place to avoid any accidents or the screen falling down



Retract the screen after every use. Leave it hanging for along period may cause screen fabric loose.



Loose parts may cause the screen fall down.



Avoid hanging anything on the screen as it may cause the screen to fall down.

USE PRECAUTIONS

UM SCHWERE VERLETZUNGEN UND TOD DURCH KIPPEN ZU VERMEIDEN:

1. **Setzen oder stellen Sie sich nicht auf diesen Gegenstand.**
2. Dieses Produkt ist kein Spielzeug. Erlauben Sie Kindern nicht, mit oder in der Nähe dieses Artikels zu spielen.
3. Nur auf einer flachen, ebenen, harten und glatten Oberfläche verwenden, die eine voll beladene Projektionsleinwand sicher tragen kann.
4. Nur bestimmungsgemäß verwenden.
5. Vor jedem Gebrauch prüfen. Nicht verwenden, wenn Teile lose oder beschädigt sind.
6. Räumen Sie einen Bereich frei, in dem Sie den Bildschirm montieren können. Stellen Sie sicher, dass der Bereich größer als die Größe des Bildschirms ist.
7. Bedenken Sie, dass für die Montage für einige Schritte mindestens zwei Personen erforderlich sind.

8. Um eine Beschädigung des Bildschirms zu vermeiden, montieren Sie den Bildschirm nicht in Bereichen mit hohen Temperaturen.

9. Lesen Sie vorher die gesamte Montageanleitung durch.

BEWAHREN SIE DIESE ANWEISUNGEN AUF

TECHNICAL SPECIFICATIONS

Modell	YD-90	YD-135
Bildschirmgröße	90 Zoll, 16:9	135 Zoll, 16:9
Technische Daten (L x B x H) (mm)	2216*400*1930	3346*400*2400
Verpackungsgröße (L x B x H) (mm)	1060*130*115	1110*170*130
Nettogewicht (kg)	Über 5.1	Etwa 6,5
Bruttogewicht (kg)	Über 5.6	Über 7

Modell	YD-150	YD-180
Bildschirmgröße	150 Zoll, 16:9	180 Zoll, 16:9
Technische Daten (L x B x H) (mm)	3576*400*2550	4236*400*2850
Verpackungsgröße (L x B x H) (mm)	1110*170*130	1110*170*130
Nettogewicht (kg)	Etwa 6,8	Über 7.6
Bruttogewicht (kg)	Über 7.3	Über 8.1

PACKAGE CONTENTS

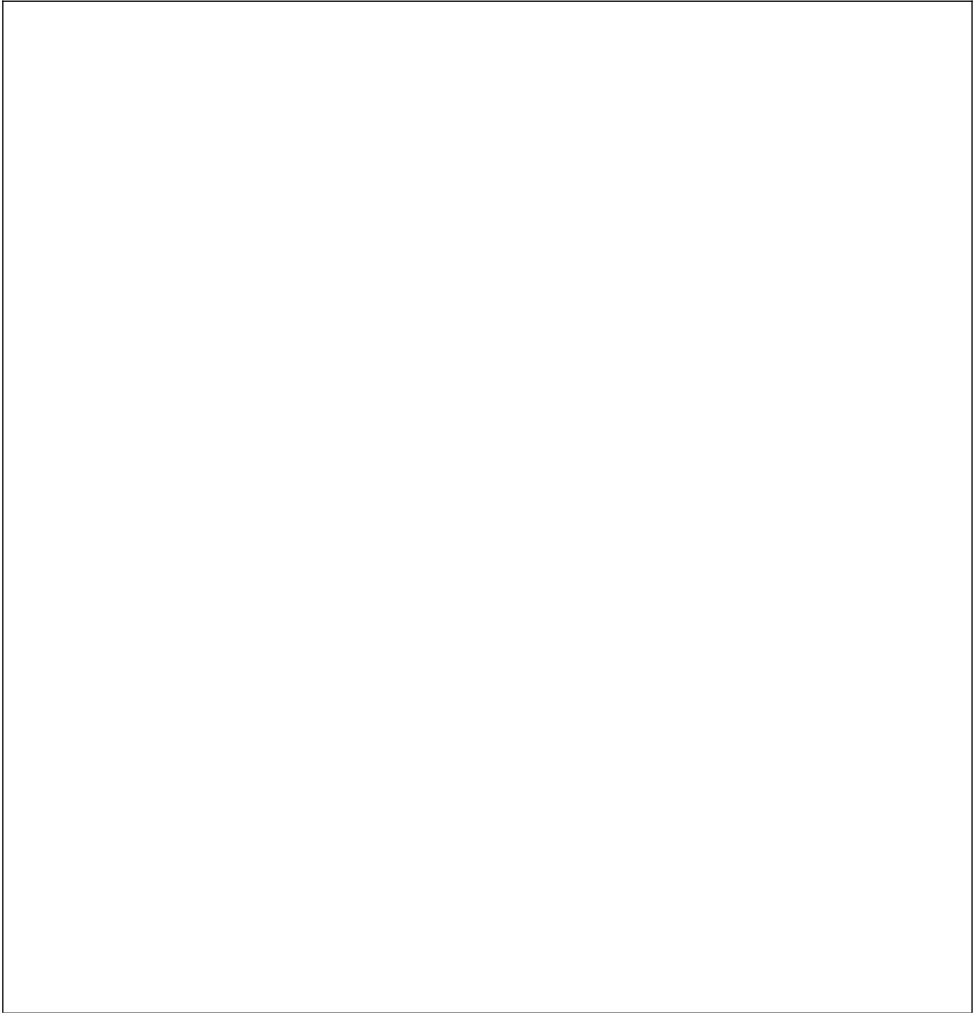

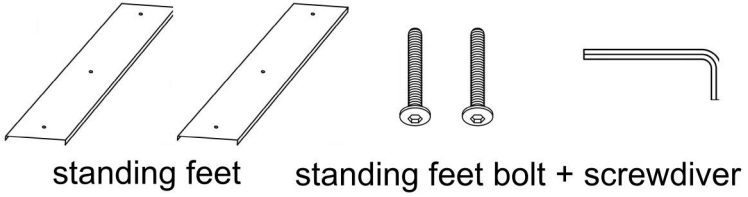

standing feet

standing feet bolt + screwdriver

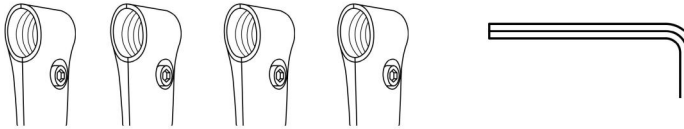

connector + connector screwdriver

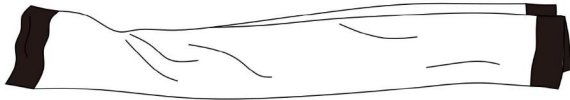

projector screen fabric

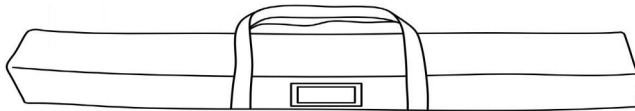

carrying bag

TOP

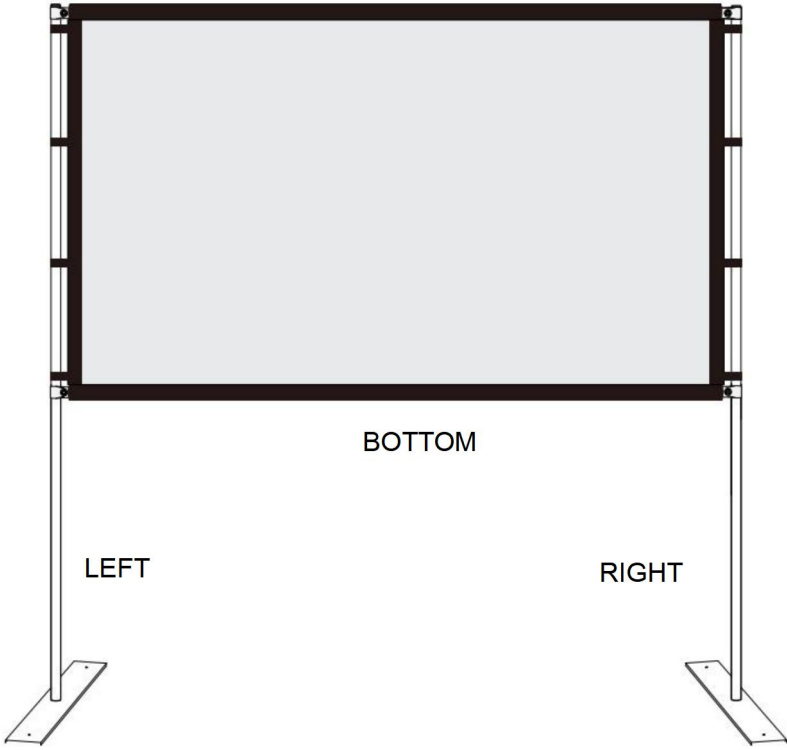

LEFT

BOTTOM

RIGHT

ASSEMBLY STEPS

SCHRITT 1

- Drücken Sie den Druckknopf und montieren Sie die 4 Stangensätze oben, unten, links und rechts.

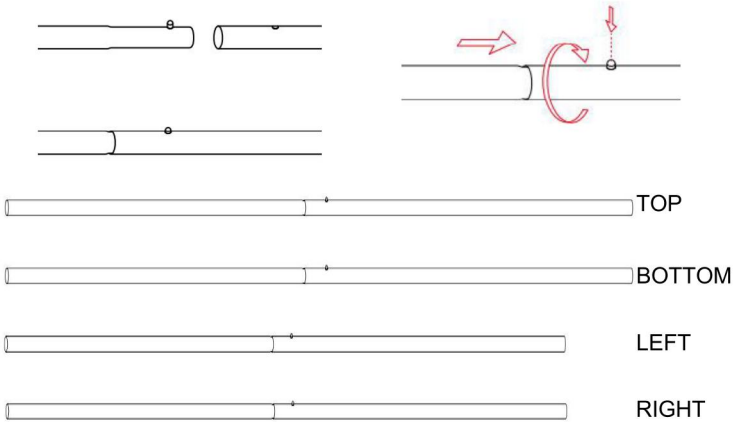

SCHRITT 2

- Befestigen Sie die vertikalen Stangen (LINKS & RECHTS) an der Füße mit den mitgelieferten Schrauben und dem Schraubendreher .

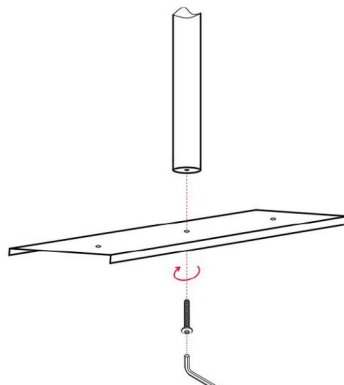

SCHRITT 3

- Schieben Sie die horizontalen Stangen (OBEN und UNTEN) durch die obere und untere Stangentasche.

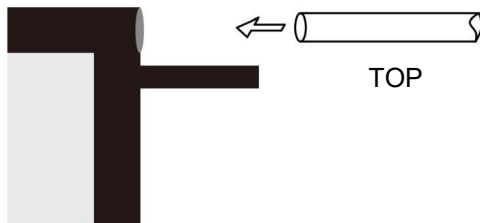

SCHRITT 4

- Befestigen Sie die horizontalen Stangen (OBEN & UNTEN) mit den Metallverbindern an den vertikalen Stangen (LINKS & RECHTS). Befestigen Sie die vertikalen Stangen mit dem Klettverschluss am Stoff, damit die Leinwand straff und glatt bleibt.

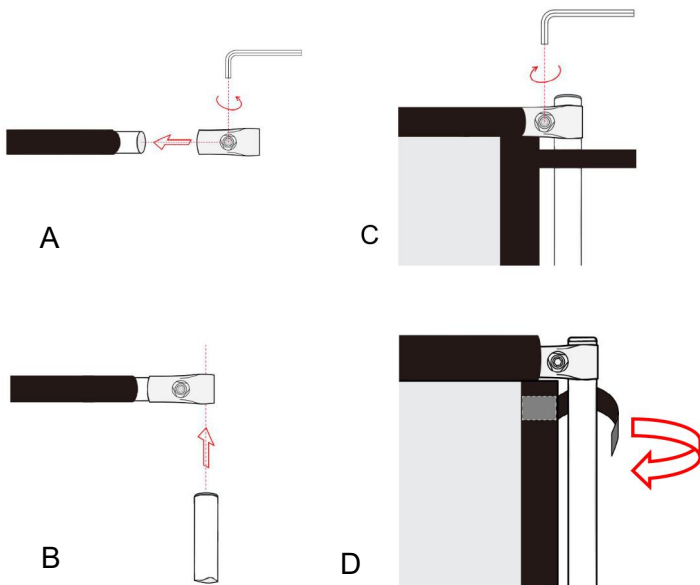

COMPLETION

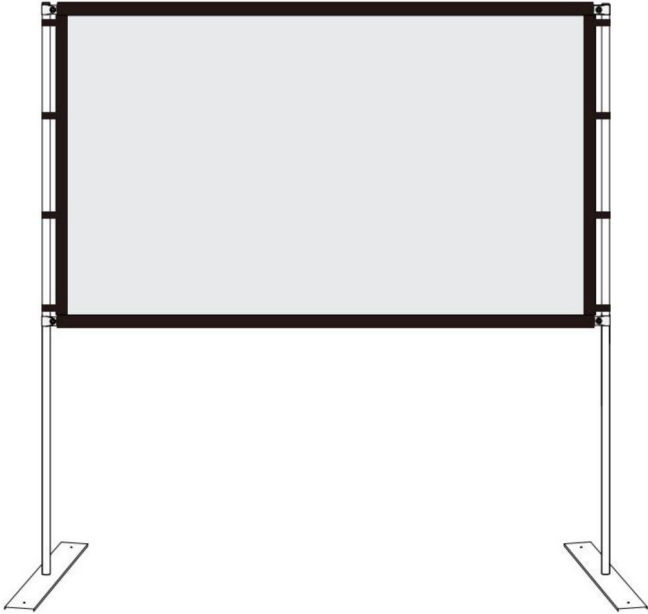

Hersteller: Shanghaimuxinmuyeyouxiangongsi

Adresse: Shuangchenglu 803nong11hao1602A-1609shi, baoshanqu, Shanghai 200000 CN.

Nach AUS importiert: SIHAO PTY LTD. 1 ROKEVA
STREETEASTWOOD NSW 2122 Australien

Importiert in die USA: Sanven Technology Ltd. Suite 250, 9166 Anaheim Place, Rancho Cucamonga, CA 91730

EC	REP
-----------	------------

E-CrossStu GmbH
Mainzer Landstr.69, 60329 Frankfurt am Main.

UK	REP
-----------	------------

YH CONSULTING LIMITED.
C/O YH Consulting Limited Office 147, Centurion House, London Road, Staines-upon-Thames, Surrey, TW18 4AX

VEVOR[®]

TOUGH TOOLS, HALF PRICE

Technisch Support und E-Garantie-Zertifikat

www.vevor.com/support

VEVOR[®]

TOUGH TOOLS, HALF PRICE

Technique Certificat d'assistance et de garantie électronique

www.vevor.com/support

ÉCRAN DE PROJECTION

MANUEL D' UTILISATION

N° DE MODÈLE : YD-90, YD-135, YD-150, YD-180

We continue to be committed to provide you tools with competitive price.

"Save Half", "Half Price" or any other similar expressions used by us only represents an estimate of savings you might benefit from buying certain tools with us compared to the major top brands and does not necessarily mean to cover all categories of tools offered by us. You are kindly reminded to verify carefully when you are placing an order with us if you are actually saving half in comparison with the top major brands.

VEVOR®

TOUGH TOOLS, HALF PRICE

Projection Screen

N° DE MODÈLE : YD-90, YD-135, YD-150, YD-180

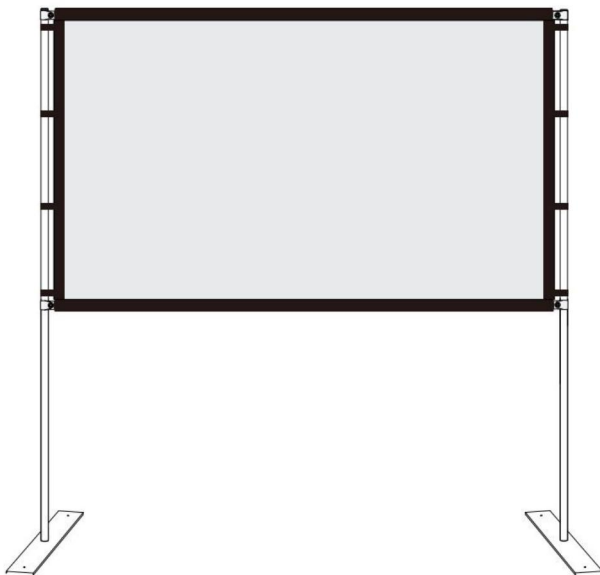

NEED HELP? CONTACT US!

Have product questions? Need technical support? Please feel free to contact us:

Technical Support and E-Warranty Certificate
www.vevor.com/support

This is the original instruction, please read all manual instructions carefully before operating. VEVOR reserves a clear interpretation of our user manual. The appearance of the product shall be subject to the product you received. Please forgive us that we won't inform you again if there are any technology or software updates on our product.



AVERTISSEMENT:

consigne peut entraîner des blessures graves. CONSERVEZ CE MANUEL INSTRUCTION

ASSEMBLY PRECAUTIONS

1. Assembler uniquement selon ces instructions. Un assemblage incorrect peut créer des dangers.
2. Portez des lunettes de sécurité et des gants de travail approuvés par l'ANSI pendant l'assemblage.
3. Gardez la zone de montage propre et bien éclairée.
4. Gardez les spectateurs hors de la zone pendant le montage.
5. Ne pas monter si vous êtes fatigué ou sous l'influence de l'alcool, de drogues ou de médicaments.
6. Les capacités du produit s'appliquent uniquement aux produits correctement et entièrement assemblés.
7. Assembler sur une surface plane, de niveau, dure et lisse capable de supporter en toute sécurité l'écran de projection.
8. Pour plus d'informations sur les pièces répertoriées dans les pages suivantes, reportez-vous au schéma d'assemblage de ce manuel. Déballez et séparez toutes les pièces dans un espace de travail propre.
9. La garantie ne sera valable que si vous suivez attentivement les instructions ci-dessous ! Une utilisation et un entretien inappropriés peuvent entraîner des blessures et/ou des dommages graves !
10. Assurez-vous que la surface que vous avez choisie pour installer l'écran est plane et sécurisée. Veuillez lire ce qui suit car tout dommage à la surface de l'écran aura un impact sur la qualité de l'image :
 - A. Ne touchez pas la surface de l'écran avec la main.
 - B. N'écrivez pas et ne dessinez pas sur la surface de l'écran.
 - C. Ne percez pas la surface de l'écran avec vos doigts ou des outils de

- bord, car cela pourrait provoquer des rayures ou des déchirures.
11. Rétractez l'écran après chaque utilisation.
 12. Ne tirez pas les deux côtés du tissu de l'écran avec les mains, ne pliez pas le tissu de l'écran.
 13. Pour éviter des dommages inutiles, l'utilisation et l'entretien de l'écran doivent être effectués par un adulte.



Ignoring the safety warnings may lead to injuries or damaging the product.



Retract the screen after every use. Leave it hanging for a long period may cause screen fabric loose.



Avoid hanging anything on the screen as it may cause the screen to fall down.



The screen should be installed at a secure place to avoid any accidents or the screen falling down.



Loose parts may cause the screen to fall down.

USE PRECAUTIONS

POUR ÉVITER LES BLESSURES GRAVES ET LA MORT RÉSULTANT DU BASCULEMENT :

1. **NE PAS S'ASSEOIR OU SE TENIR DEBOUT SUR CET ARTICLE.**
2. Ce produit n'est pas un jouet. Ne laissez pas les enfants jouer avec ou à proximité de cet article.
3. Utiliser uniquement sur une surface plane, dure et lisse capable de supporter en toute sécurité un écran de projection entièrement chargé.
4. Utiliser uniquement comme prévu.
5. Inspectez avant chaque utilisation. Ne pas utiliser si des pièces sont desserrées ou endommagées.
6. Dégagez une zone pour assembler l'écran. Assurez-vous que la zone est plus grande que la taille de l'écran.
7. N'oubliez pas que le montage nécessitera au moins deux personnes pour certaines étapes.

8. Ne pas assembler dans des zones à haute température pour éviter d'endommager l'écran.

9. Lisez d'abord l'intégralité de ce guide d'assemblage.

CONSERVEZ CES INSTRUCTIONS

TECHNICAL SPECIFICATIONS

Modèle	YD-90	YD-135
Taille de l'écran	90 pouces, 16:9	135 pouces, 16:9
Dimensions du produit (L x l x H) (mm)	2216*400*1930	3346*400*2400
Taille de l'emballage (L x l x H) (mm)	1060*130*115	1110*170*130
Poids net (kg)	À propos de 5.1	Environ 6,5
Poids brut (kg)	Environ 5,6	Environ 7

Modèle	YD-150	YD-180
Taille de l'écran	150 pouces, 16:9	180 pouces, 16:9
Dimensions du produit (L x l x H) (mm)	3576*400*2550	4236*400*2850
Taille de l'emballage (L x l x H) (mm)	1110*170*130	1110*170*130
Poids net (kg)	Environ 6,8	Environ 7,6
Poids brut (kg)	Environ 7,3	À propos de 8.1

PACKAGE CONTENTS

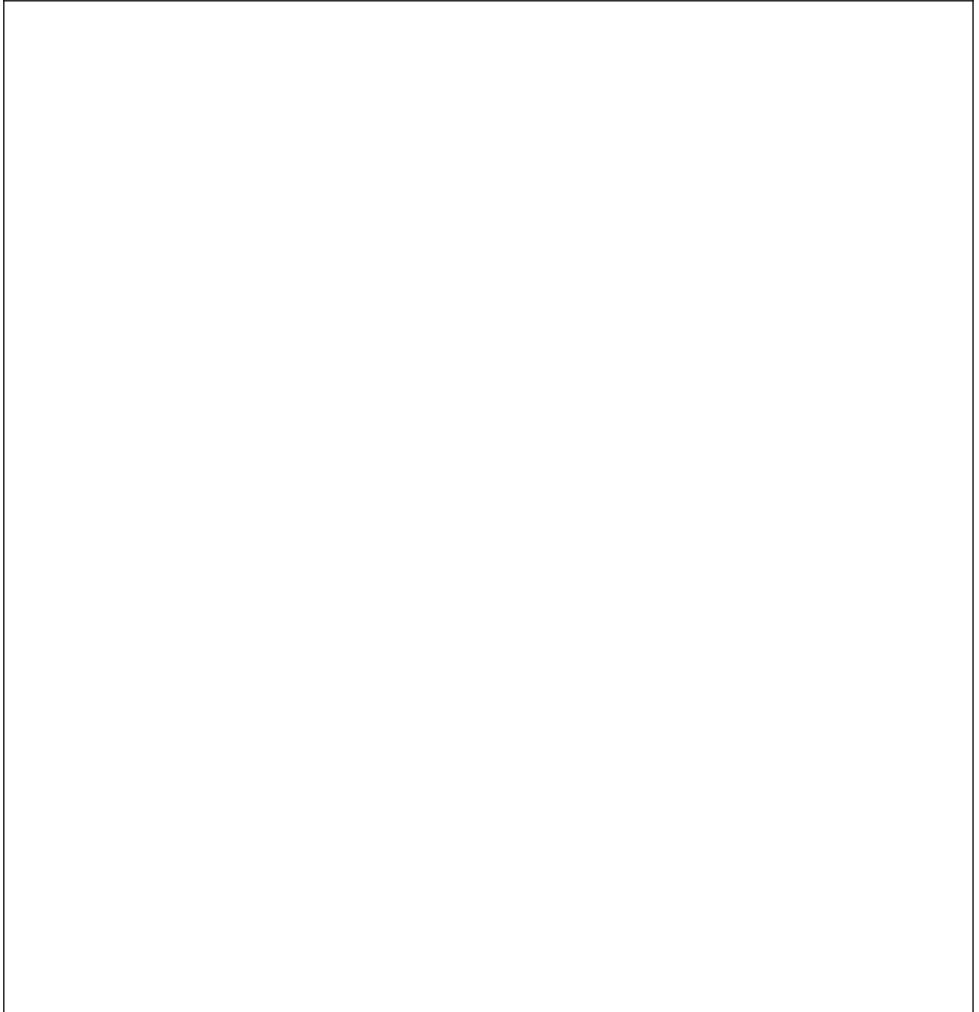

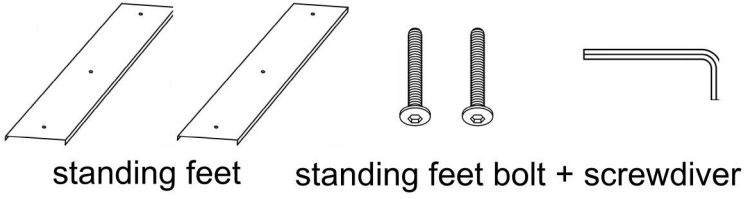

standing feet

standing feet bolt + screwdriver

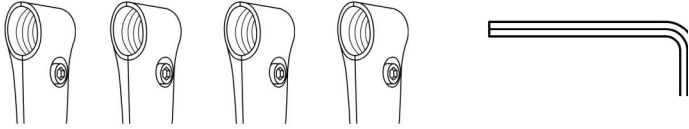

connector + connector screwdriver

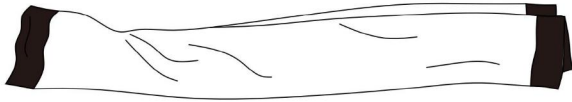

projector screen fabric

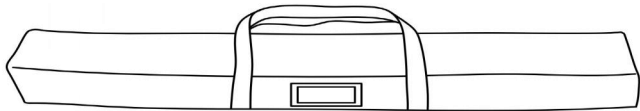

carrying bag

TOP

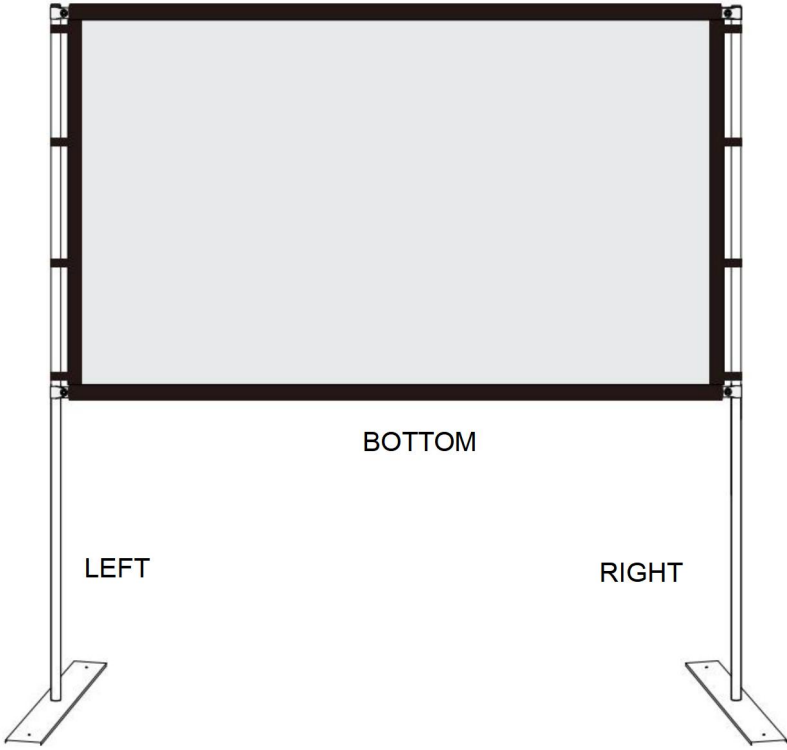

LEFT

BOTTOM

RIGHT

ASSEMBLY STEPS

ÉTAPE 1

- Appuyez sur le bouton pression, assemblez les 4 ensembles de poteaux haut, bas, gauche et droite.

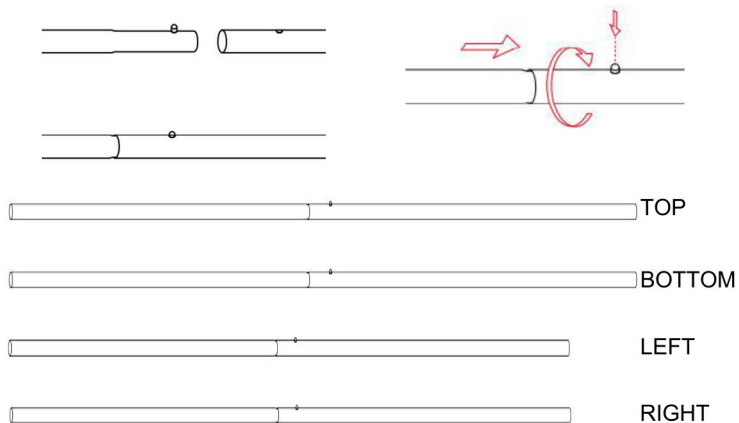

ÉTAPE 2

- Fixez les poteaux verticaux (GAUCHE ET DROITE) au pieds à l'aide des boulons et du tournevis fournis .

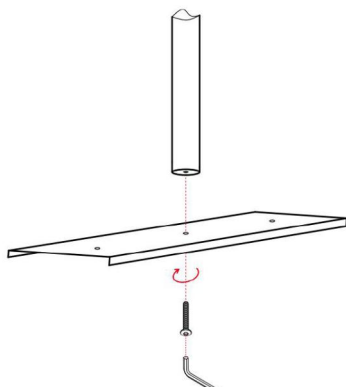

ÉTAPE 3

- Faites glisser les poteaux horizontaux (HAUT et BAS) à travers la poche du poteau supérieur et inférieur.

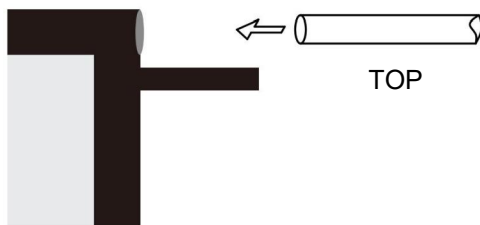

ÉTAPE 4

- Fixez les poteaux horizontaux (HAUT et BAS) aux poteaux verticaux (GAUCHE et DROITE) à l'aide des connecteurs métalliques. Utilisez le velcro sur le tissu pour fixer les poteaux verticaux, rendez l'écran serré et lisse.

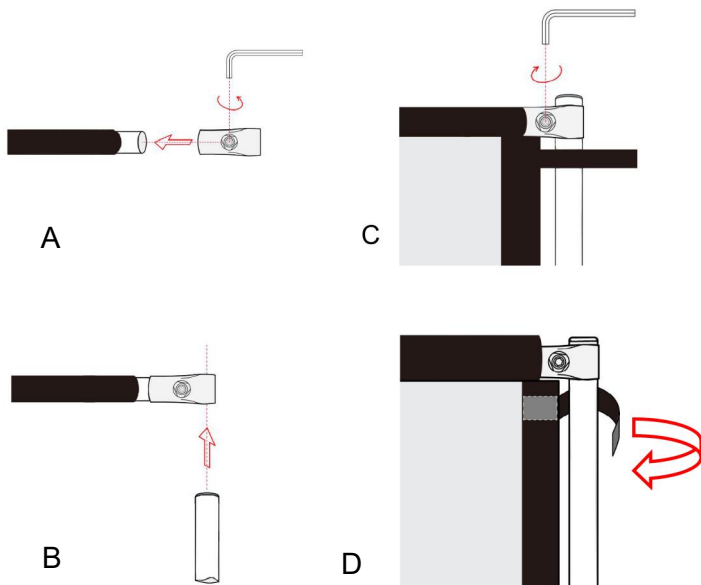

COMPLETION

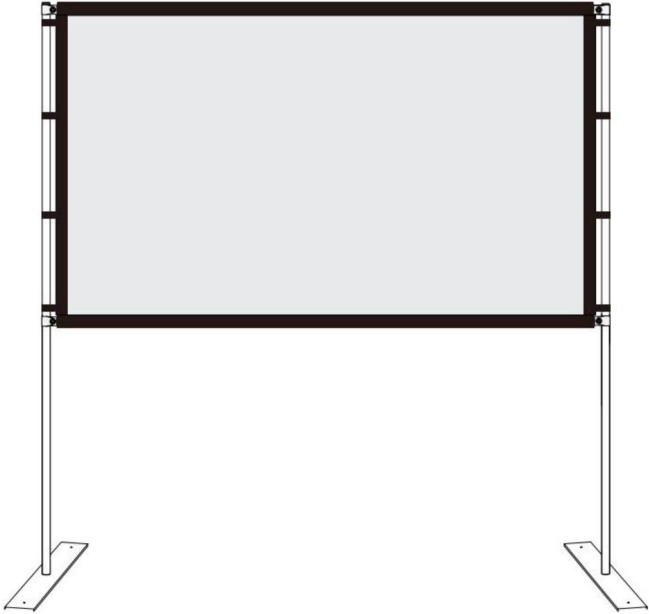

Fabricant : Shanghaimuxinmuyeyouxiangongsi

Adresse : Shuangchenglu 803nong11hao1602A-1609shi, baoshanqu, Shanghai 200000 CN.

Importé en Australie : SIHAO PTY LTD. 1 ROKEVA
STREETEASTWOOD NSW 2122 Australie

Importé aux États-Unis : Sanven Technology Ltd. Suite 250, 9166
Anaheim Place, Rancho Cucamonga, CA 91730

EC	REP
-----------	------------

E-CrossStu GmbH
Mainzer Landstr.69, 60329 Frankfurt am Main.

UK	REP
-----------	------------

YH CONSULTING LIMITED.
C/O YH Consulting Limited Office 147, Centurion
House, London Road, Staines-upon-Thames, Surrey,
TW18 4AX

VEVOR®

TOUGH TOOLS, HALF PRICE

Technique Certificat d'assistance et de garantie électronique

www.vevor.com/support

VEVOR[®]

TOUGH TOOLS, HALF PRICE

Technisch Ondersteuning en E-garantiecertificaat

www.vevor.com/support

PROJECTIESCHERM

GEBRUIKSAANWIJZING

MODEL NR.: YD-90, YD-135, YD-150, YD-180

We continue to be committed to provide you tools with competitive price.

"Save Half", "Half Price" or any other similar expressions used by us only represents an estimate of savings you might benefit from buying certain tools with us compared to the major top brands and does not necessarily mean to cover all categories of tools offered by us. You are kindly reminded to verify carefully when you are placing an order with us if you are actually saving half in comparison with the top major brands.

VEVOR®

TOUGH TOOLS, HALF PRICE

Projection Screen

MODEL NR.: YD-90, YD-135, YD-150, YD-180

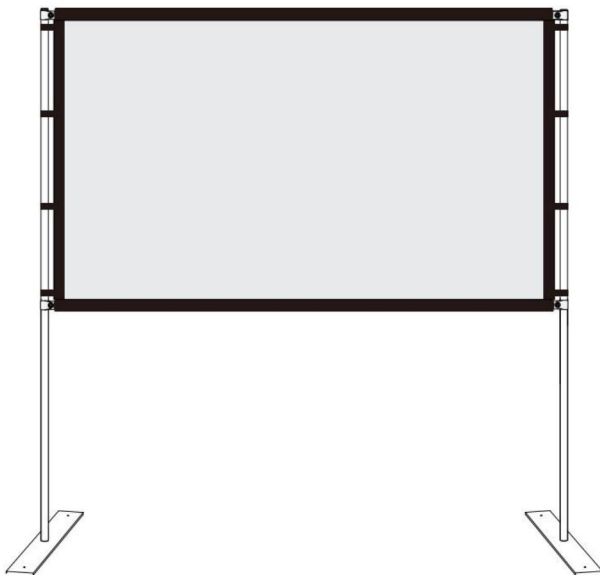

NEED HELP? CONTACT US!

Have product questions? Need technical support? Please feel free to contact us:

Technical Support and E-Warranty Certificate
www.vevor.com/support

This is the original instruction, please read all manual instructions carefully before operating. VEVOR reserves a clear interpretation of our user manual. The appearance of the product shall be subject to the product you received. Please forgive us that we won't inform you again if there are any technology or software updates on our product.



WAARSCHUWING:

dit niet doet, kan dit leiden tot ernstig letsel. BEWAAR DEZE INSTRUCTIE

ASSEMBLY PRECAUTIONS

1. Monteer alleen volgens deze instructies. Onjuiste montage kan gevaren opleveren.
2. Draag tijdens de montage een ANSI-goedgekeurde veiligheidsbril en werkhandschoenen.
3. Zorg ervoor dat de verzamelplaats schoon en goed verlicht is.
4. Houd omstanders uit de buurt tijdens de montage.
5. Kom niet in actie als u moe bent of onder invloed van alcohol, drugs of medicijnen.
6. De producteigenschappen gelden uitsluitend voor correct en volledig gemonteerde producten.
7. Monteer het geheel op een vlak, egaal, hard en glad oppervlak dat het projectiescherm veilig kan dragen.
8. Voor aanvullende informatie over de onderdelen die op de volgende pagina's worden vermeld, raadpleegt u het montageschema van deze handleiding. Pak alle onderdelen uit en scheid ze in een schone werkruimte.
9. De garantie is alleen geldig als u de onderstaande instructies zorgvuldig opvolgt! Onjuist gebruik en onderhoud kunnen ernstig letsel en/of schade veroorzaken!
10. Zorg ervoor dat het oppervlak dat u hebt gekozen voor de installatie van het scherm vlak en stevig is. Lees het volgende aandachtig door, aangezien schade aan het schermoppervlak de kwaliteit van de afbeelding kan beïnvloeden:
 - A. Raak het schermoppervlak niet met uw handen aan.
 - B. Schrijf of teken niet op het schermoppervlak.
 - C. Raak het schermoppervlak niet aan met uw vingers of met een scherp voorwerp, omdat dit krassen of scheuren kan veroorzaken.

11. Trek het scherm na elk gebruik terug.
12. Trek niet met de hand aan twee kanten van het gaasdoek en vouw het gaasdoek niet.
13. Om onnodige schade te voorkomen, dient de bediening en het onderhoud van het scherm door een volwassene te worden uitgevoerd.



Ignoring the safety warnings may lead to injuries or damaging the product.



The screen should be installed at secure place to avoid any accidents or the screen falling down



Retract the screen after every use. Leave it hanging for along period may cause screen fabric loose.



Loose parts may cause the screen fall down.



Avoid hanging anything on the screen as it may cause the screen to fall down.

USE PRECAUTIONS

OM ERNSTIG LETSEL EN DE DOOD DOOR KANTELEN TE VOORKOMEN:

1. NIET OP DIT ARTIKEL ZITTEN OF STAAN.
2. Dit product is geen speelgoed. Laat kinderen niet met of in de buurt van dit item spelen.
3. Gebruik het apparaat alleen op een vlak, egaal, hard en glad oppervlak dat een volledig beladen projectiescherm veilig kan dragen.
4. Alleen gebruiken zoals bedoeld.
5. Inspecteer voor elk gebruik. Niet gebruiken als onderdelen los of beschadigd zijn.
6. Maak een gebied vrij om het scherm te monteren. Zorg ervoor dat het gebied groter is dan de grootte van het scherm.
7. Houd er rekening mee dat er voor sommige stappen minimaal twee personen nodig zijn voor de montage.
8. Monteer het apparaat niet op een plek met een hoge temperatuur, om schade aan het scherm te voorkomen.

9. Lees eerst de hele montagehandleiding door.
BEWAAR DEZE INSTRUCTIES

TECHNICAL SPECIFICATIONS

Model	YD-90	YD-135
Schermgrootte	90 inch, 16:9	135 inch, 16:9
Productafmetingen (LxBxH)(mm)	2216*400*1930	3346*400*2400
Verpakkingsgrootte (LxBxH)(mm)	1060*130*115	1110*170*130
Nettogewicht (kg)	Ongeveer 5.1	Ongeveer 6,5
Brutogewicht (kg)	Ongeveer 5.6	Ongeveer 7

Model	YD-150	YD-180
Schermgrootte	150 inch, 16:9	180 inch, 16:9
Productafmetingen (LxBxH)(mm)	3576*400*2550	4236*400*2850
Verpakkingsgrootte (LxBxH)(mm)	1110*170*130	1110*170*130
Nettogewicht (kg)	Ongeveer 6,8	Ongeveer 7.6
Brutogewicht (kg)	Ongeveer 7.3	Ongeveer 8.1

PACKAGE CONTENTS

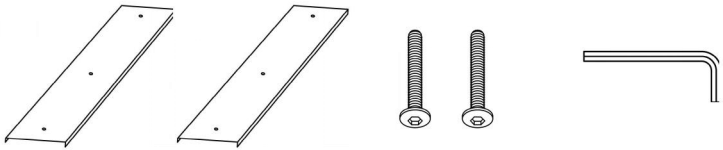

standing feet standing feet bolt + screwdriver

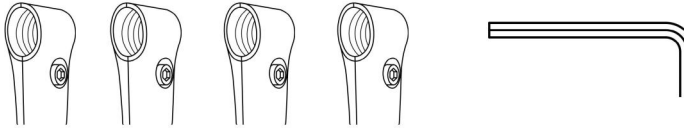

connector + connector screwdriver



projector screen fabric

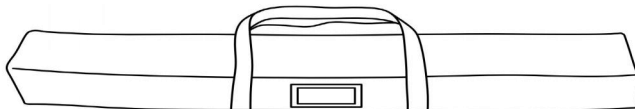

carrying bag

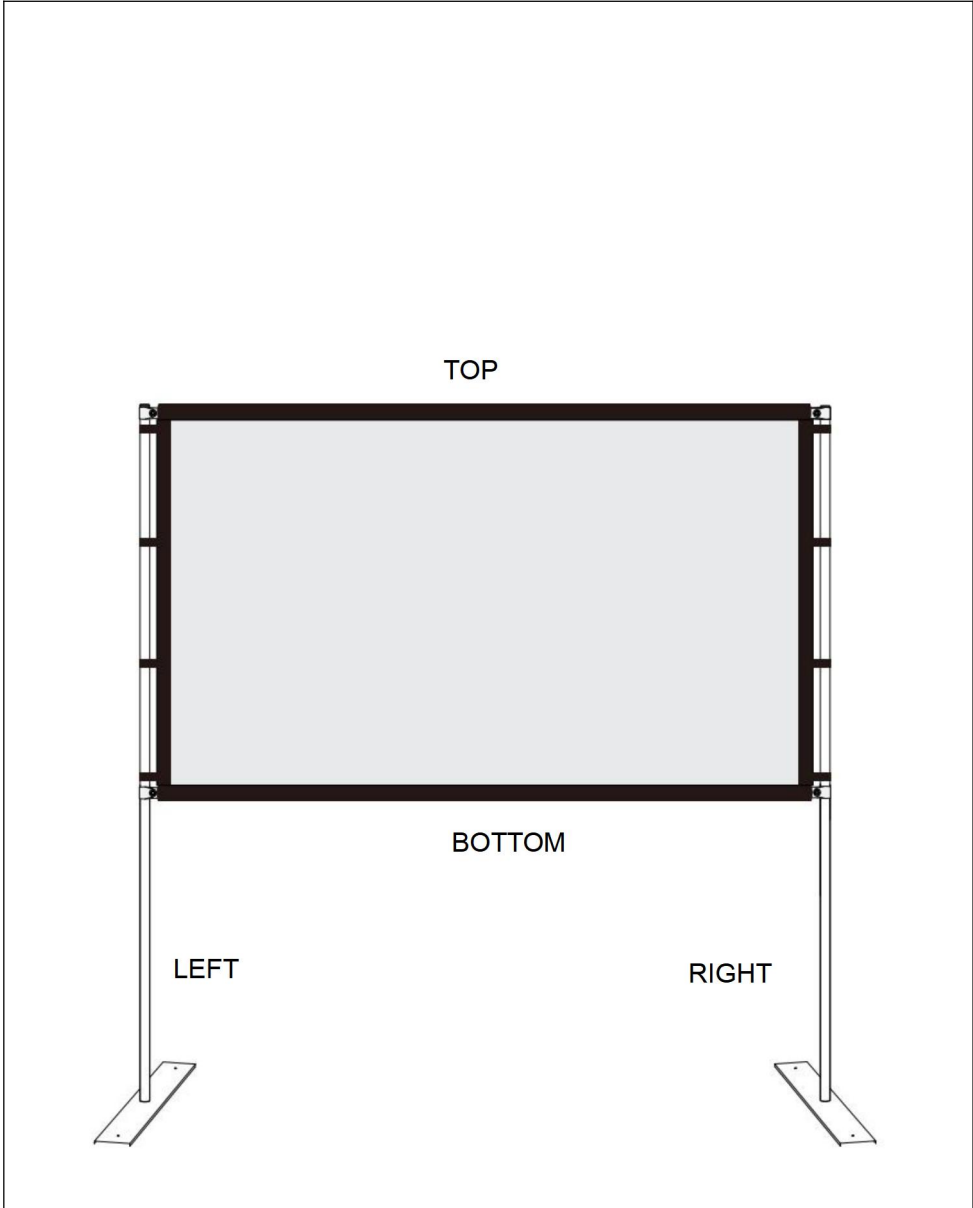

ASSEMBLY STEPS

STAP 1

- Druk op de drukknop en monteer de 4 sets palen: boven, onder, links en rechts.

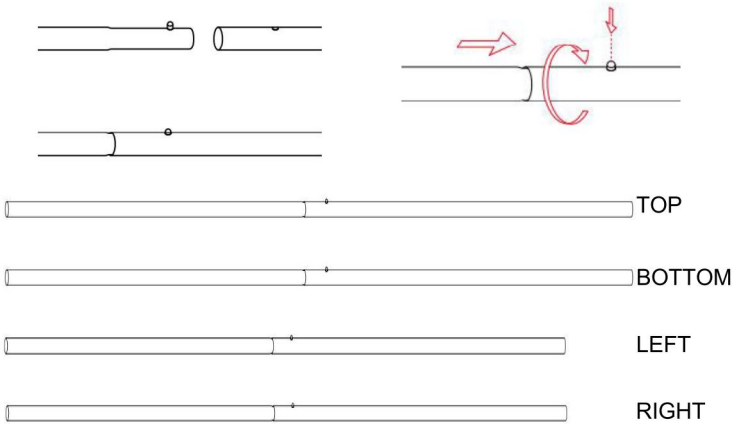

STAP 2

- Bevestig de verticale palen (LINKS & RECHTS) aan de voeten met behulp van de meegeleverde bouten en schroevendraaier .

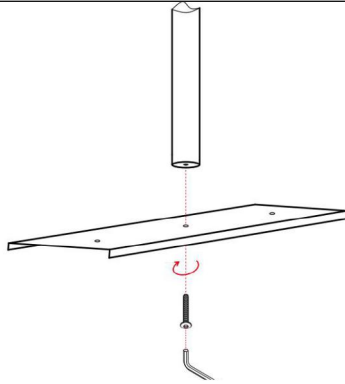

STAP 3

- Schuif de horizontale stokken (BOVEN & ONDER) door de bovenste en onderste stokkenopening.

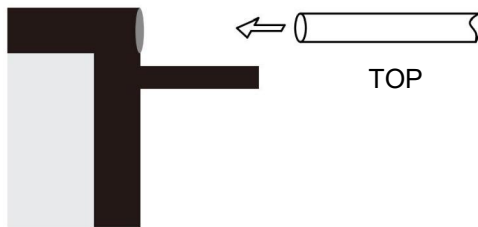

STAP 4

- Bevestig de horizontale palen (BOVEN & ONDER) aan de verticale palen (LINKS & RECHTS) met de metalen connectoren. Gebruik het klittenband op de stof om de verticale palen te bevestigen, maak het scherm strak en glad.

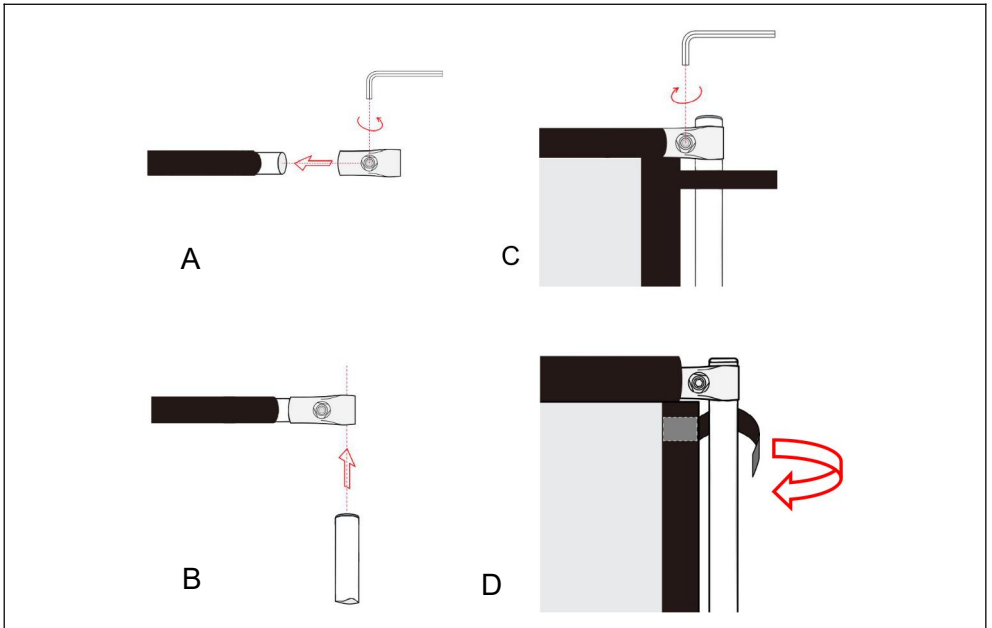

COMPLETION

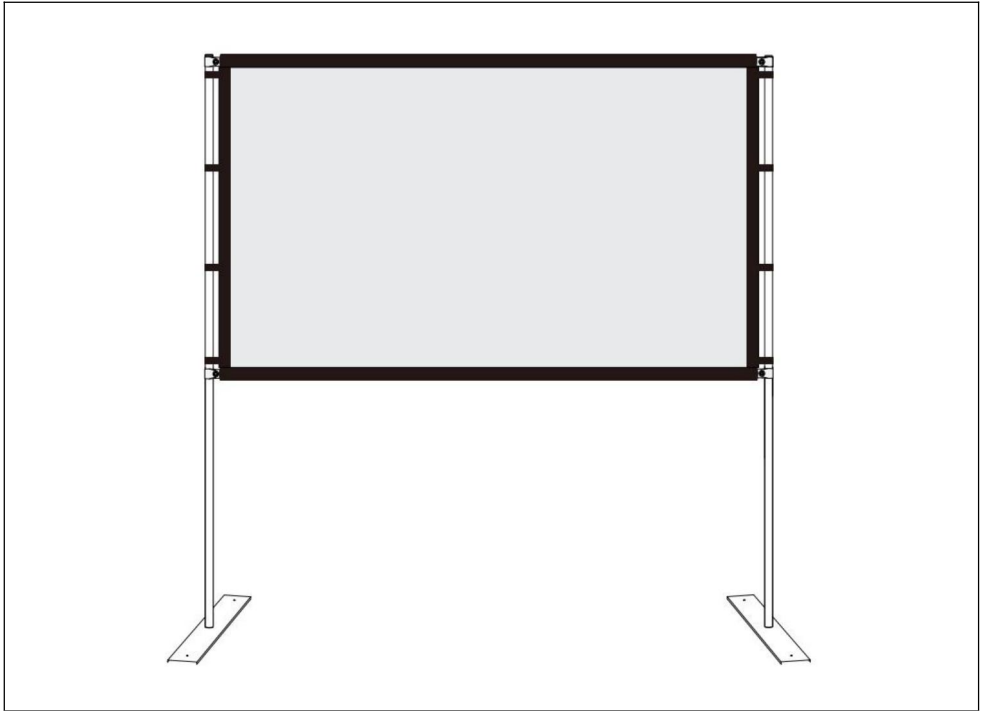

Fabrikant: Shanghaimuxinmuyeyouxiangongsi

Adres: Shuangchenglu 803nong11hao1602A-1609shi, baoshanqu,

shanghai 200000 CN.

Geïmporteerd naar AUS: SIHAO PTY LTD. 1 ROKEVA
STREETEASTWOOD NSW 2122 Australië

Geïmporteerd naar de VS: Sanven Technology Ltd. Suite 250, 9166
Anaheim Place, Rancho Cucamonga, CA 91730



E-CrossStu GmbH
Mainzer Landstr.69, 60329 Frankfurt am Main.



YH CONSULTING LIMITED.
C/O YH Consulting Limited Office 147, Centurion
House, London Road, Staines-upon-Thames, Surrey,
TW18 4AX

VEVOR[®]

TOUGH TOOLS, HALF PRICE

Technisch Ondersteuning en E-garantiecertificaat

www.vevor.com/support

VEVOR[®]

TOUGH TOOLS, HALF PRICE

Teknisk Support och e-garanticertifikat

www.vevor.com/support

PROJEKTIONSDUK

ANVÄNDARMANUAL

MODELLNR: YD-90, YD-135, YD-150, YD-180

We continue to be committed to provide you tools with competitive price.

"Save Half", "Half Price" or any other similar expressions used by us only represents an estimate of savings you might benefit from buying certain tools with us compared to the major top brands and does not necessarily mean to cover all categories of tools offered by us. You are kindly reminded to verify carefully when you are placing an order with us if you are actually saving half in comparison with the top major brands.

VEVOR®

TOUGH TOOLS, HALF PRICE

Projection Screen

MODELLNR: YD-90, YD-135, YD-150, YD-180

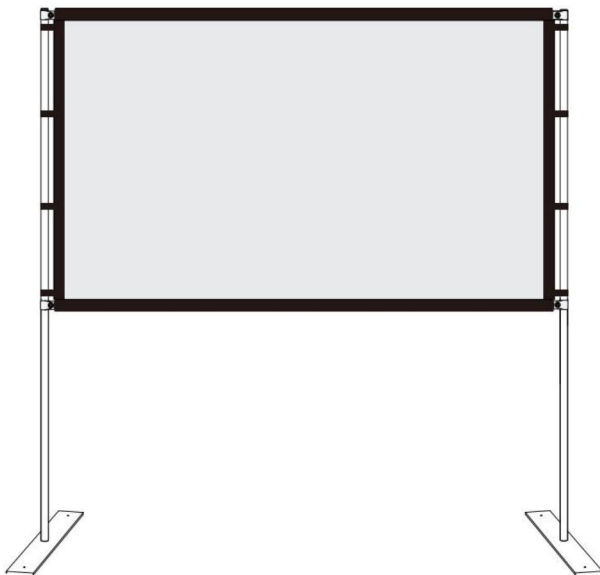

NEED HELP? CONTACT US!

Have product questions? Need technical support? Please feel free to contact us:

Technical Support and E-Warranty Certificate
www.vevor.com/support

This is the original instruction, please read all manual instructions carefully before operating. VEVOR reserves a clear interpretation of our user manual. The appearance of the product shall be subject to the product you received. Please forgive us that we won't inform you again if there are any technology or software updates on our product.

 **VARNING:**

**Läs denna bruksanvisning noggrant innan du använder produkten. Underlåtenhet att göra det kan leda till allvarliga skador. SPARA DET
E S E INSTRUKTION**

ASSEMBLY PRECAUTIONS

1. Montera endast enligt dessa instruktioner. Felaktig montering kan skapa faror.
2. Använd ANSI-godkända skyddsglasögon och arbetshandskar vid montering.
3. Håll monteringsområdet rent och väl upplyst.
4. Håll åskådare borta från området under monteringen.
5. Sätt dig inte ihop när du är trött eller påverkad av alkohol, droger eller mediciner.
6. Produktegenskaperna gäller endast för korrekt och färdigmonterade produkter.
7. Montera på en plan, jämn, hård och slät yta som säkert kan stödja projektduken.
8. För ytterligare information om delarna som listas på följande sidor, se monteringsdiagrammet i denna manual. Packa upp och separera alla delar på ett rent arbetsområde.
9. Garantin gäller endast om du följer instruktionerna nedan noggrant! Felaktig användning och skötsel kan orsaka allvarliga skador och/eller skada!
10. Se till att ytan du har valt för att installera skärmen är platt och säker. Läs följande eftersom eventuella skador på skärmens yta påverkar bildens kvalitet:
 - A. Rör inte skärmytan för hand.
 - B. Skriv eller rita inte på skärmytan.
 - C. Stick inte på skärmytan med finger- eller kantverktyg eftersom det kan orsaka repor eller revor.
11. Dra tillbaka skärmen efter varje användning.

12. Dra inte två sidor av skärmygget med händerna, vik inte skärmygget.

13. För att förhindra onödiga skador bör drift och underhåll av skärmen utföras av en vuxen.



Ignoring the safety warnings may lead to injuries or damaging the product.



Retract the screen after every use. Leave it hanging for a long period may cause screen fabric loose.



Avoid hanging anything on the screen as it may cause the screen to fall down.



The screen should be installed at a secure place to avoid any accidents or the screen falling down.



Loose parts may cause the screen to fall down.

USE PRECAUTIONS

FÖR ATT FÖRHINDRA ALLVARLIGA SKADA OCH DÖDSFALL VID VÄLLNING:

1. SIT ELLER STÅ INTE PÅ DETTA FÖREMÅL.

2. Denna produkt är inte en leksak. Låt inte barn leka med eller nära detta föremål.

3. Använd endast på en plan, jämn, hård och slät yta som säkert kan stödja en fullastad projektduk.

4. Använd endast som avsett.

5. Inspektera före varje användning. Använd inte om delar är lösa eller skadade.

6. Rensa ut ett område för att montera skärmen. Se till att området är större än storleken på skärmen.

7. Kom ihåg att monteringen kommer att kräva minst två personer för vissa moment.

8. Montera inte i områden med hög temperatur för att undvika att skada skärmen.

9. Läs igenom hela denna monteringsguide innan.

SPARA DESSA INSTRUKTIONER

TECHNICAL SPECIFICATIONS

Modell	YD-90	YD-135
S skärmstorlek	90 tum, 16:9	135 tum, 16:9
Produktens mått (LxBxH)(mm)	2216*400*1930	3346*400*2400
Förpackningsstorlek (LxBxH)(mm)	1060*130*115	1110*170*130
Nettovikt (kg)	Ungefär 5.1	Cirka 6,5
Bruttovikt (kg)	Cirka 5,6	Cirka 7

Modell	YD-150	YD-180
S skärmstorlek	150 tum, 16:9	180 tum, 16:9
Produktens mått (LxBxH)(mm)	3576*400*2550	4236*400*2850
Förpackningsstorlek (LxBxH)(mm)	1110*170*130	1110*170*130
Nettovikt (kg)	Cirka 6,8	Cirka 7,6
Bruttovikt (kg)	Cirka 7,3	Cirka 8.1

PACKAGE CONTENTS

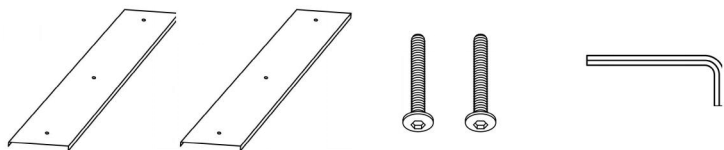

standing feet standing feet bolt + screwdriver

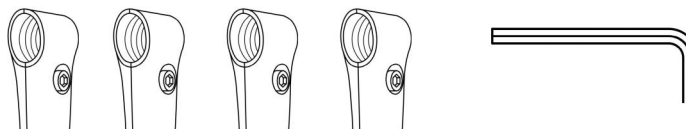

connector + connector screwdriver



projector screen fabric

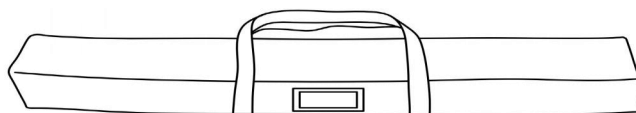

carrying bag

TOP

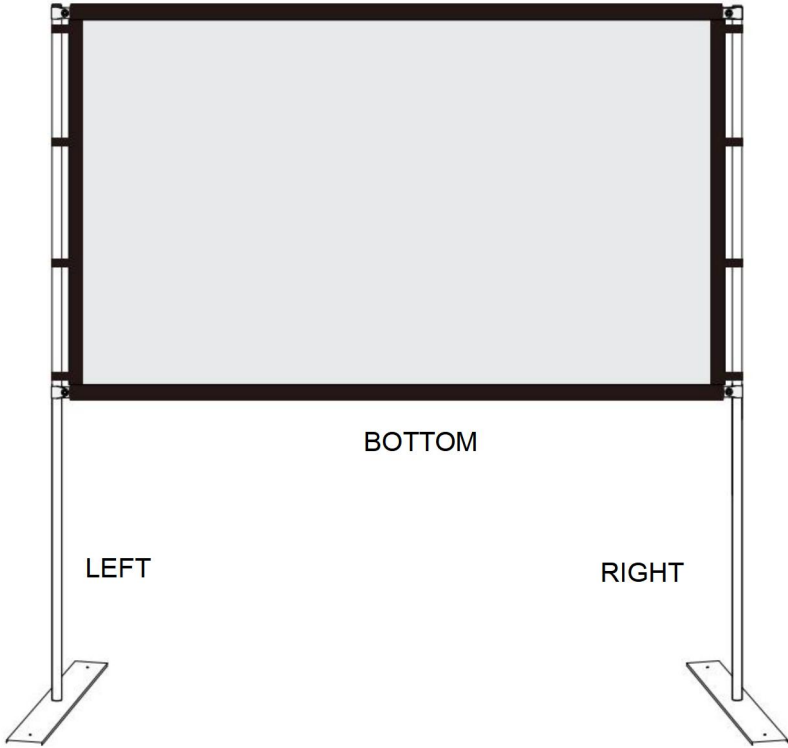

LEFT

BOTTOM

RIGHT

ASSEMBLY STEPS

STEG 1

- Tryck på knappsnapet, sätt ihop de 4 uppsättningarna av stolpar upptill, botten, vänster och höger.

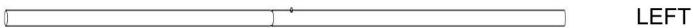
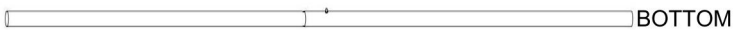
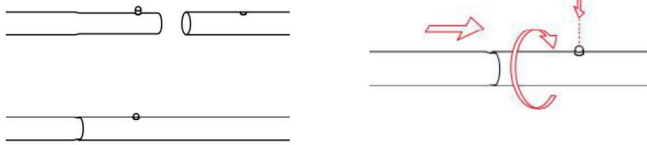

STEG 2

- Fäst de vertikala stolparna (VÄNSTER & HÖGER) på fötter med de medföljande bultarna och skruvmejseln .

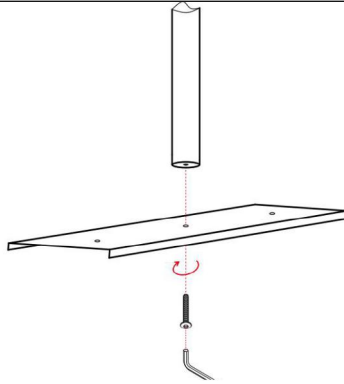

STEG 3

- Skjut de horisontella stolparna (TOPP & NEDERL) genom den övre och nedre stolpfickan.

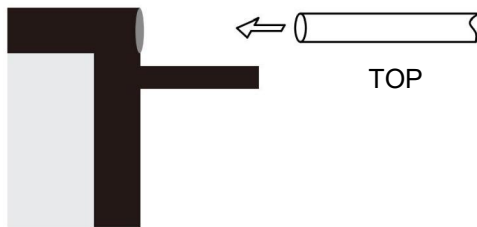

STEG 4

- Fäst de horisontella polerna (TOPP & NEDERL) till de vertikala polerna (VÄNSTER & HÖGER) med metallkontaktarna. Använd kadborrhbandet på tyget för att fixera de vertikala stolparna, göra skärmen tät och slät.

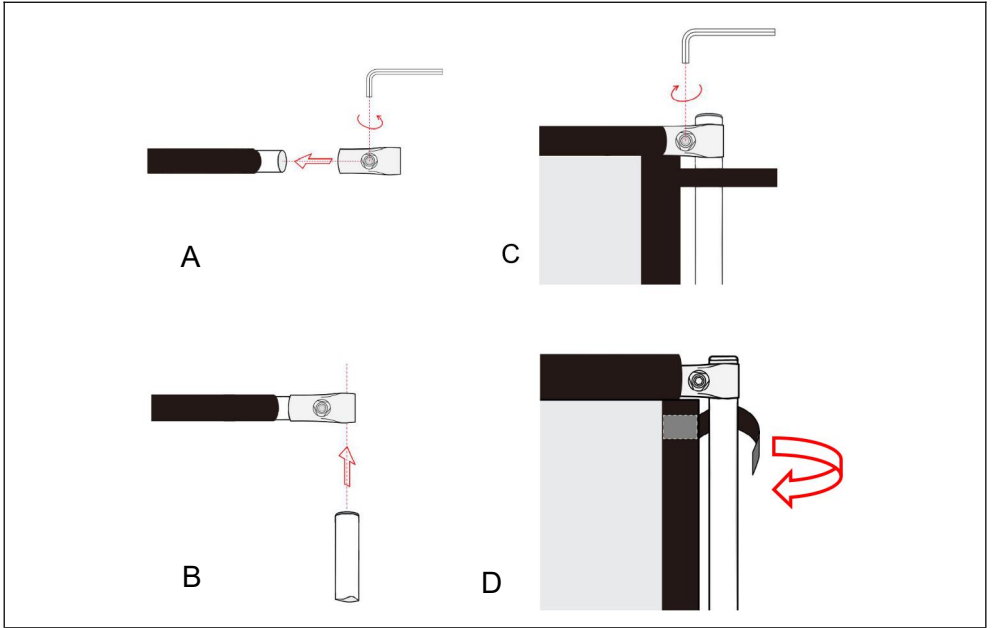

COMPLETION

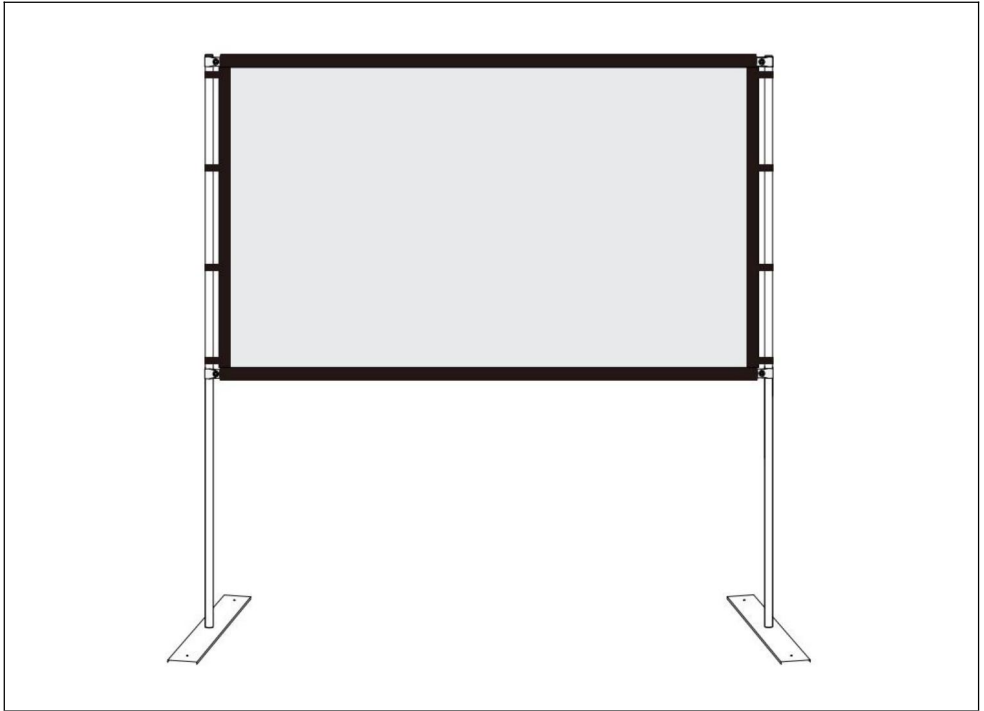

Tillverkare: Shanghaimuxinmuyeyouxiangongsi

Adress: Shuangchenglu 803nong11hao1602A-1609shi, baoshanqu,

shanghai 200000 CN.

Importerad till AUS: SIHAO PTY LTD. 1 ROKEVA STREETEASTWOOD
NSW 2122 Australien

Importerad till USA: Sanven Technology Ltd. Suite 250, 9166 Anaheim
Place, Rancho Cucamonga, CA 91730



E-CrossStu GmbH
Mainzer Landstr.69, 60329 Frankfurt am Main.



YH CONSULTING LIMITED.
C/O YH Consulting Limited Office 147, Centurion
House, London Road, Staines-upon-Thames, Surrey,
TW18 4AX

VEVOR[®]

TOUGH TOOLS, HALF PRICE

Teknisk Support och e-garanticertifikat

www.vevor.com/support

VEVOR[®]

TOUGH TOOLS, HALF PRICE

Técnico Certificado de soporte y garantía electrónica
www.vevor.com/support

PANTALLA DE PROYECCIÓN

MANUAL DEL USUARIO

N.º DE MODELO: YD-90, YD-135, YD-150, YD-180

We continue to be committed to provide you tools with competitive price.

"Save Half", "Half Price" or any other similar expressions used by us only represents an estimate of savings you might benefit from buying certain tools with us compared to the major top brands and does not necessarily mean to cover all categories of tools offered by us. You are kindly reminded to verify carefully when you are placing an order with us if you are actually saving half in comparison with the top major brands.

VEVOR®

TOUGH TOOLS, HALF PRICE

Projection Screen

N.º DE MODELO: YD-90, YD-135, YD-150, YD-180

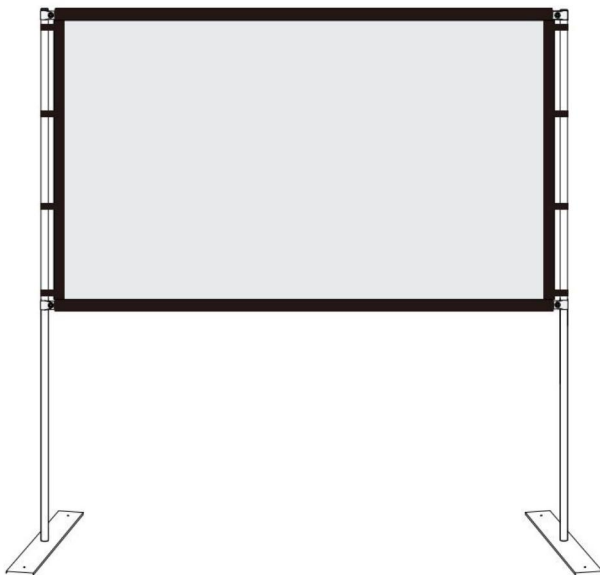

NEED HELP? CONTACT US!

Have product questions? Need technical support? Please feel free to contact us:

Technical Support and E-Warranty Certificate
www.vevor.com/support

This is the original instruction, please read all manual instructions carefully before operating. VEVOR reserves a clear interpretation of our user manual. The appearance of the product shall be subject to the product you received. Please forgive us that we won't inform you again if there are any technology or software updates on our product.



ADVERTENCIA:

Lea atentamente este manual antes de utilizar el producto. De lo contrario, podría sufrir lesiones graves. GUARDE ESTE MANUAL INSTRUCCIÓN

ASSEMBLY PRECAUTIONS

1. Realice el montaje únicamente de acuerdo con estas instrucciones. Un montaje inadecuado puede generar peligros.
2. Use gafas de seguridad y guantes de trabajo aprobados por ANSI durante el montaje.
3. Mantenga el área de reunión limpia y bien iluminada.
4. Mantenga a los transeúntes fuera del área durante el montaje.
5. No se reúna cuando esté cansado o bajo la influencia del alcohol, drogas o medicamentos.
6. Las capacidades del producto se aplican únicamente a productos ensamblados de forma correcta y completa.
7. Móntelo sobre una superficie plana, nivelada, dura y lisa capaz de soportar de forma segura la pantalla de proyección.
8. Para obtener información adicional sobre las piezas que se enumeran en las páginas siguientes, consulte el diagrama de ensamblaje de este manual. Desembale y separe todas las piezas en un área de trabajo limpia.
9. ¡La garantía solo será válida si sigue atentamente las instrucciones que se indican a continuación! ¡El uso y el cuidado inadecuados pueden provocar lesiones y/o daños graves!
10. Asegúrese de que la superficie que ha elegido para instalar la pantalla sea plana y segura. Lea lo siguiente, ya que cualquier daño a la superficie de la pantalla afectará la calidad de la imagen:
 - A. No toque la superficie de la pantalla con la mano.
 - B. No escriba ni dibuje sobre la superficie de la pantalla.

- C. No golpee la superficie de la pantalla con los dedos ni con herramientas de borde, ya que puede causar rayones o rasgaduras.
11. Retraiga la pantalla después de cada uso.
 12. No tire de los dos lados de la tela de la pantalla con las manos, no doble la tela de la pantalla.
 13. Para evitar daños innecesarios, la operación y el mantenimiento de la pantalla deben ser realizados por un adulto.



Ignoring the safety warnings may lead to injuries or damaging the product.



The screen should be installed at secure place to avoid any accidents or the screen falling down



Retract the screen after every use. Leave it hanging for along period may cause screen fabric loose.



Loose parts may cause the screen fall down.



Avoid hanging anything on the screen as it may cause the screen to fall down.

USE PRECAUTIONS

PARA EVITAR LESIONES GRAVES Y LA MUERTE POR VUELCO:

1. **NO SE SIENTA NI SE PARE SOBRE ESTE ARTÍCULO.**
2. Este producto no es un juguete. No permita que los niños jueguen con este artículo ni cerca de él.
3. Úselo únicamente sobre una superficie plana, nivelada, dura y lisa capaz de soportar de forma segura una pantalla de proyección completamente cargada.
4. Úselo únicamente según lo previsto.
5. Inspeccione el producto antes de cada uso. No lo utilice si hay piezas sueltas o dañadas.
6. Despeje un área para ensamblar la pantalla. Asegúrese de que el área sea más grande que el tamaño de la pantalla.
7. Recuerde que el montaje requerirá al menos dos personas para algunos pasos.

8. No montar en zonas con altas temperaturas para evitar dañar la pantalla.

9. Lea esta guía de montaje completa antes.

GUARDE ESTAS INSTRUCCIONES

TECHNICAL SPECIFICATIONS

Modelo	YD-90	YD-135
Tamaño de la pantalla	90 pulgadas, 16:9	135 pulgadas, 16:9
Dimensiones del producto (Largo x Ancho x Alto) (mm)	2216*400*1930	3346*400*2400
Tamaño del embalaje (Largo x Ancho x Alto) (mm)	1060*130*115	1110*170*130
Peso neto (kg)	Acerca de 5.1	Aproximadamente 6,5
Peso bruto (kg)	Acerca de 5.6	Acerca de 7

Modelo	YD-150	YD-180
Tamaño de la pantalla	150 pulgadas, 16:9	180 pulgadas, 16:9
Dimensiones del producto (Largo x Ancho x Alto) (mm)	3576*400*2550	4236*400*2850

Tamaño del embalaje (Largo x Ancho x Alto) (mm)	1110*170*130	1110*170*130
Peso neto (kg)	Acerca de 6.8	Acerca de 7.6
Peso bruto (kg)	Acerca de 7.3	Acerca de 8.1

PACKAGE CONTENTS

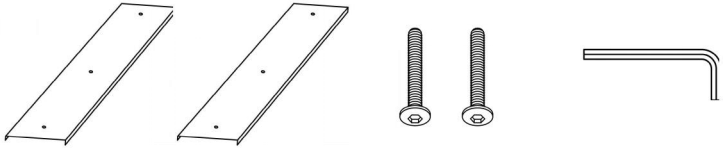

standing feet standing feet bolt + screwdriver

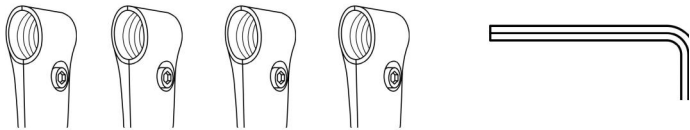

connector + connector screwdriver



projector screen fabric

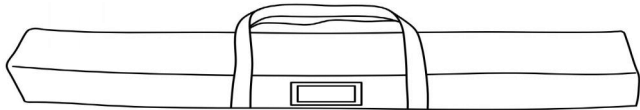

carrying bag

TOP

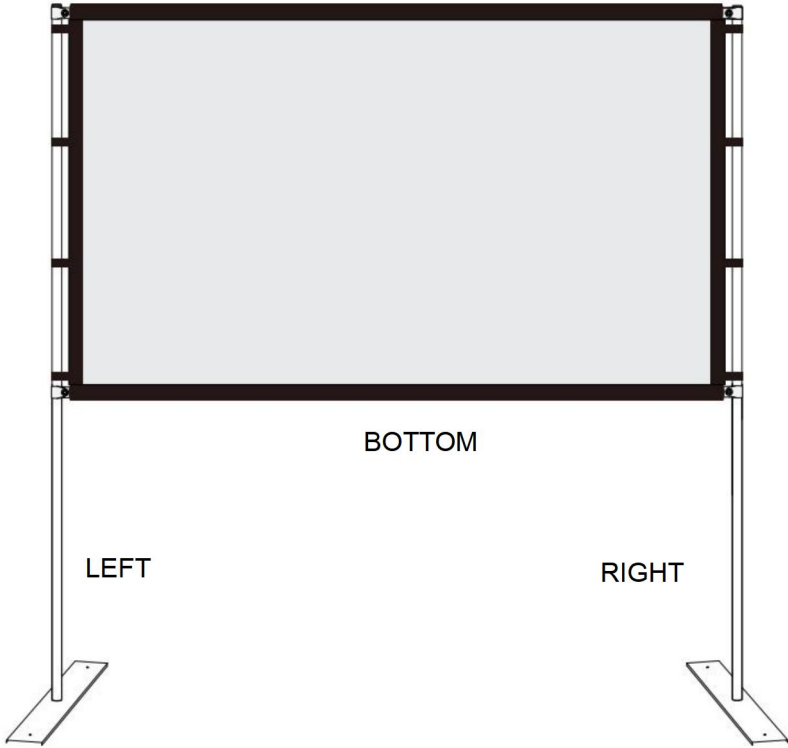

BOTTOM

LEFT

RIGHT

ASSEMBLY STEPS

PASO 1

- Presione el botón a presión, ensamble los 4 juegos de postes superior, inferior, izquierdo y derecho.

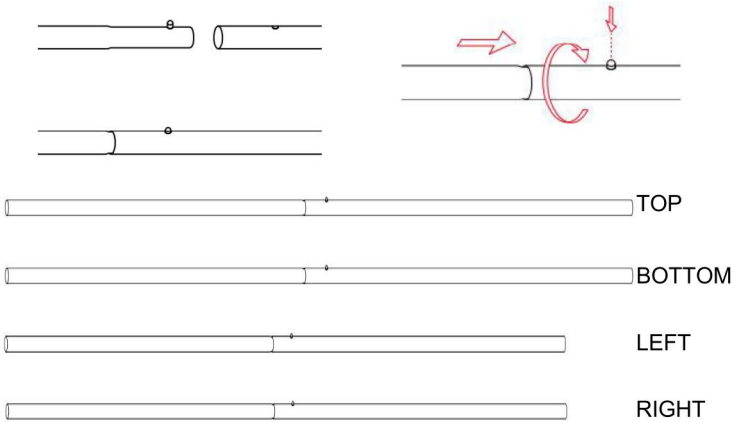

PASO 2

- Fije los postes verticales (IZQUIERDO Y DERECHO) a la pies utilizando los tornillos y el destornillador incluidos .

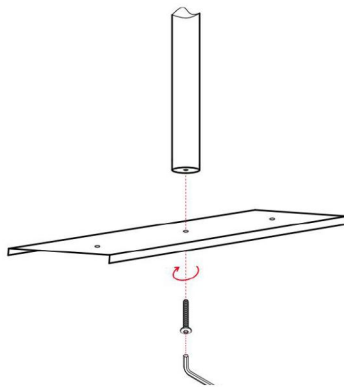

PASO 3

- Deslice los postes horizontales (SUPERIOR E INFERIOR) a través de los bolsillos para postes superior e inferior.

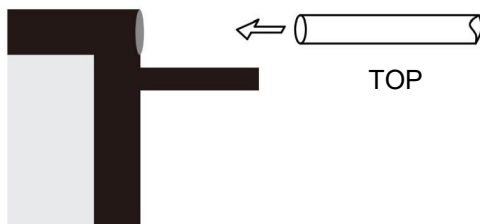

PASO 4

- Fije los postes horizontales (SUPERIOR E INFERIOR) a los postes verticales (IZQUIERDO Y DERECHO) mediante los conectores metálicos. Utilice el velcro de la tela para fijar los postes verticales y hacer que la pantalla quede firme y lisa.

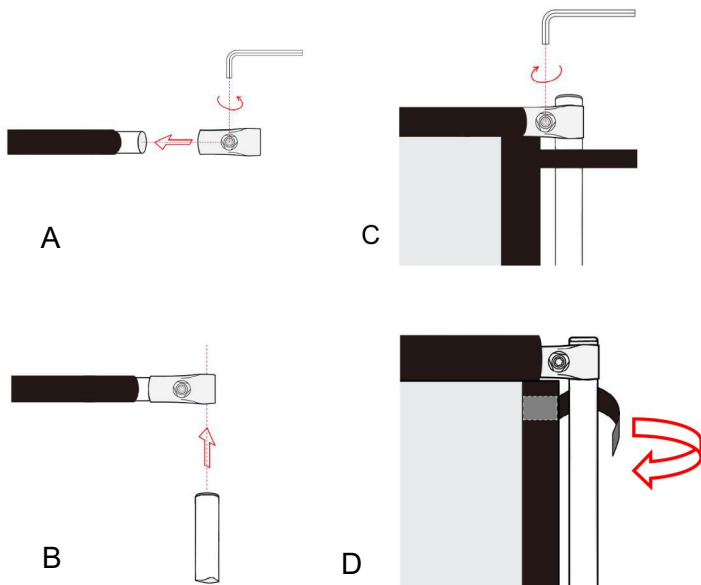

COMPLETION

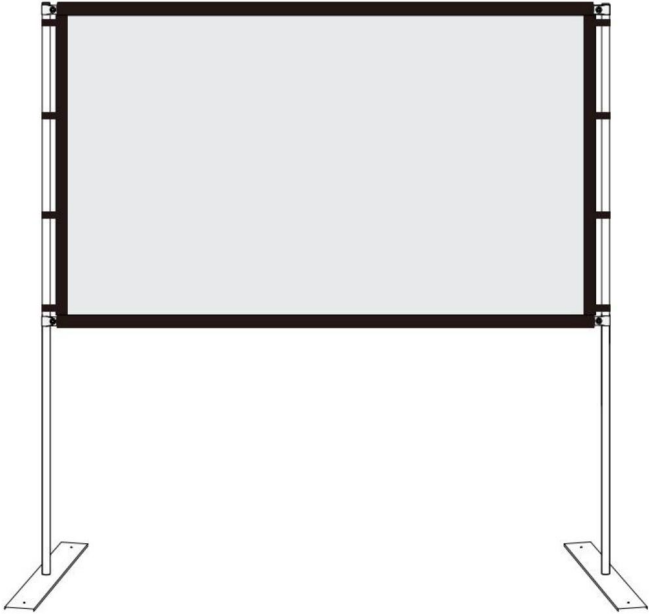

Fabricante: Shanghaimuxinmuyeyouxiangongsi

Dirección: Shuangchenglu 803nong11hao1602A-1609shi, baoshanqu, shanghai 200000 CN.

Importado a AUS: SIHAO PTY LTD. 1 ROKEVA STREETEASTWOOD NSW 2122 Australia

Importado a EE. UU.: Sanven Technology Ltd. Suite 250, 9166 Anaheim Place, Rancho Cucamonga, CA 91730

EC	REP
-----------	------------

E-CrossStu GmbH
Mainzer Landstr.69, 60329 Frankfurt am Main.

UK	REP
-----------	------------

YH CONSULTING LIMITED.
C/O YH Consulting Limited Office 147, Centurion House, London Road, Staines-upon-Thames, Surrey, TW18 4AX

VEVOR[®]

TOUGH TOOLS, HALF PRICE

Técnico Certificado de soporte y garantía electrónica

www.vevor.com/support

VEVOR[®]

TOUGH TOOLS, HALF PRICE

Tecnico Supporto e certificato di garanzia elettronica

www.vevor.com/support

SCHERMO DI PROIEZIONE

MANUALE D' USO

MODELLO N.: YD-90, YD-135, YD-150, YD-180

We continue to be committed to provide you tools with competitive price.

"Save Half", "Half Price" or any other similar expressions used by us only represents an estimate of savings you might benefit from buying certain tools with us compared to the major top brands and does not necessarily mean to cover all categories of tools offered by us. You are kindly reminded to verify carefully when you are placing an order with us if you are actually saving half in comparison with the top major brands.

VEVOR®

TOUGH TOOLS, HALF PRICE

Projection Screen

MODELLO N.: YD-90, YD-135, YD-150, YD-180

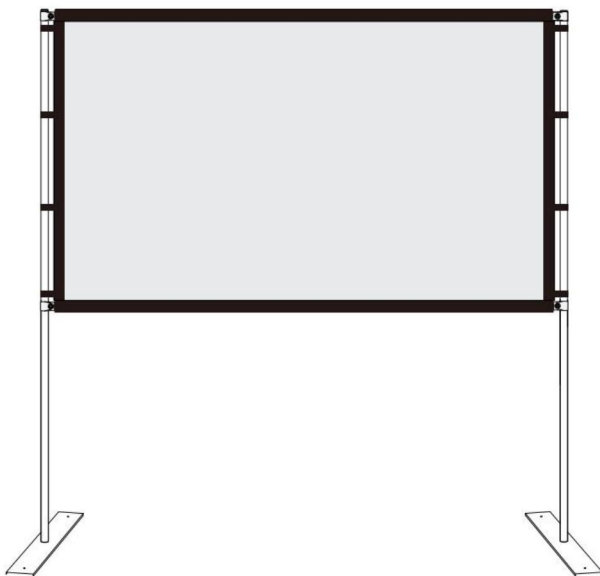

NEED HELP? CONTACT US!

Have product questions? Need technical support? Please feel free to contact us:

Technical Support and E-Warranty Certificate
www.vevor.com/support

This is the original instruction, please read all manual instructions carefully before operating. VEVOR reserves a clear interpretation of our user manual. The appearance of the product shall be subject to the product you received. Please forgive us that we won't inform you again if there are any technology or software updates on our product.



AVVERTIMENTO:

di utilizzare il prodotto. La mancata osservanza di questa precauzione potrebbe causare gravi lesioni. CONSERVARE QUESTO ISTRUZIONE

ASSEMBLY PRECAUTIONS

1. Montare solo secondo queste istruzioni. Un montaggio improprio può creare pericoli.
2. Durante il montaggio indossare occhiali di sicurezza e guanti da lavoro omologati ANSI.
3. Mantenere l'area di riunione pulita e ben illuminata.
4. Durante l'assemblea, tenere gli astanti lontani dall'area.
5. Non riunirsi quando si è stanchi o sotto l'effetto di alcol, droghe o farmaci.
6. Le capacità del prodotto si applicano solo ai prodotti correttamente e completamente assemblati.
7. Montare su una superficie piana, livellata, dura e liscia, in grado di sostenere in modo sicuro lo schermo di proiezione.
8. Per ulteriori informazioni sulle parti elencate nelle pagine seguenti, fare riferimento allo schema di montaggio di questo manuale. Disimballare e separare tutte le parti in un'area di lavoro pulita.
9. La garanzia sarà valida solo se seguirai attentamente le istruzioni sottostanti! Un uso e una cura impropri possono causare gravi lesioni e/o danni!
10. Assicurati che la superficie scelta per l'installazione dello schermo sia piana e sicura. Leggi quanto segue poiché eventuali danni alla superficie dello schermo influiranno sulla qualità dell'immagine:
 - A. Non toccare la superficie dello schermo con le mani.
 - B. Non scrivere o disegnare sulla superficie dello schermo.
 - C. Non toccare la superficie dello schermo con le dita o con utensili appuntiti perché potresti graffiarla o strapparla.
11. Ritirare lo schermo dopo ogni utilizzo.
12. Non tirare con le mani i due lati del telo dello schermo, non piegare il

telo dello schermo.

13. Per evitare danni inutili, l'uso e la manutenzione dello schermo devono essere eseguiti da un adulto.



Ignoring the safety warnings may lead to injuries or damaging the product.



Retract the screen after every use. Leave it hanging for a long period may cause screen fabric loose.



Avoid hanging anything on the screen as it may cause the screen to fall down.



The screen should be installed at a secure place to avoid any accidents or the screen falling down.



Loose parts may cause the screen to fall down.

USE PRECAUTIONS

PER PREVENIRE LESIONI GRAVI E MORTALI DOVUTE AL RIBALTAMENTO:

- 1. NON SEDERSI O STARE IN PIEDI SU QUESTO OGGETTO.**
- Questo prodotto non è un giocattolo. Non permettere ai bambini di giocare con o vicino a questo articolo.
- Utilizzare solo su una superficie piana, livellata, dura e liscia, in grado di sostenere in modo sicuro uno schermo di proiezione completamente carico.
- Utilizzare solo come previsto.
- Ispezionare prima di ogni utilizzo. Non utilizzare se le parti sono allentate o danneggiate.
- Liberare un'area per montare lo schermo. Assicurarsi che l'area sia più grande delle dimensioni dello schermo.
- Ricordatevi che per alcune fasi del montaggio saranno necessarie almeno due persone.
- Non montare in aree con temperature elevate per evitare di danneggiare lo schermo.
- Prima di tutto, leggere attentamente questa Guida al montaggio.

TECHNICAL SPECIFICATIONS

Modello	YD-90	YD-135
Dimensioni dello schermo	90 pollici, 16:9	135 pollici, 16:9
Dimensioni del prodotto (Lunghezza x Larghezza x Altezza)(mm)	Dimensioni: 2216*400*1930	Dimensioni: 3346*400*2400
Dimensioni dell'imballaggio (Lunghezza x Larghezza x Altezza)(mm)	Dimensioni: 1060*130*115	Dimensioni: 1110*170*130
Peso netto (kg)	Circa 5.1	Circa 6,5
Peso lordo (kg)	Circa 5.6	Circa 7

Modello	YD-150	YD-180
Dimensioni dello schermo	150 pollici, 16:9	180 pollici, 16:9
Dimensioni del prodotto (Lunghezza x Larghezza x Altezza)(mm)	Dimensioni: 3576*400*2550	Dimensioni: 4236*400*2850
Dimensioni dell'imballaggio (Lunghezza x Larghezza x Altezza)(mm)	Dimensioni: 1110*170*130	Dimensioni: 1110*170*130

Peso netto (kg)	Circa 6,8	Circa 7.6
Peso lordo (kg)	Circa 7.3	Circa 8.1

PACKAGE CONTENTS

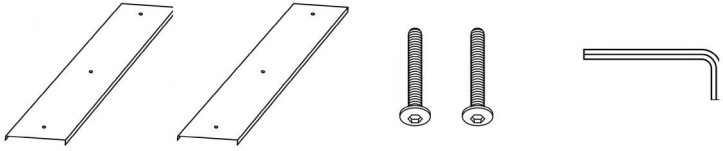

standing feet standing feet bolt + screwdriver

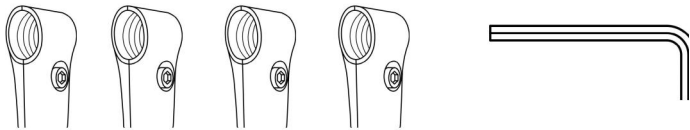

connector + connector screwdriver



projector screen fabric

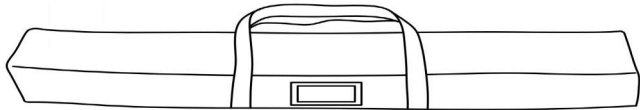

carrying bag

TOP

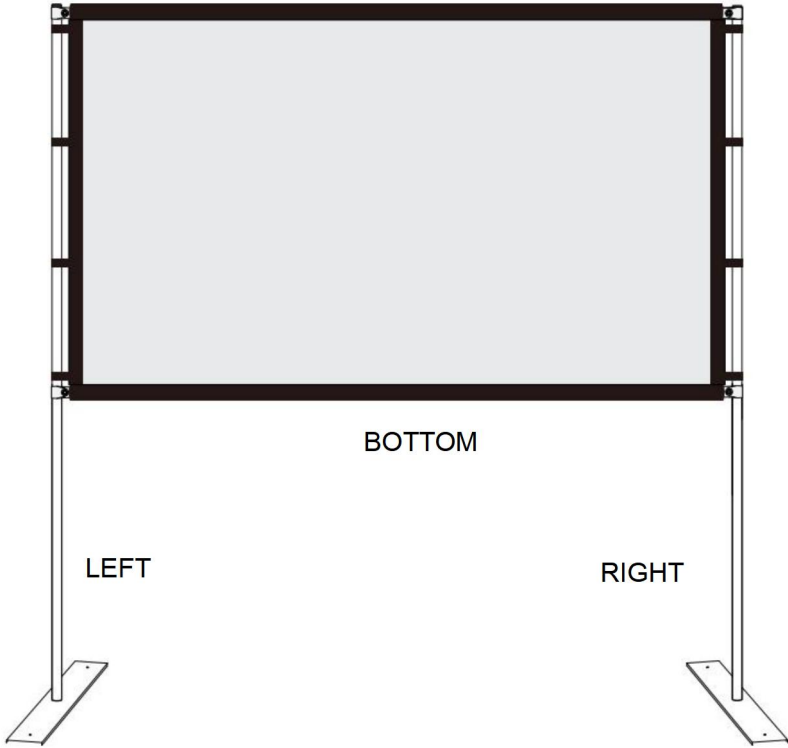

BOTTOM

LEFT

RIGHT

ASSEMBLY STEPS

PASSO 1

- Premere il pulsante a scatto e assemblare i 4 set di pali: superiore, inferiore, sinistro e destro.

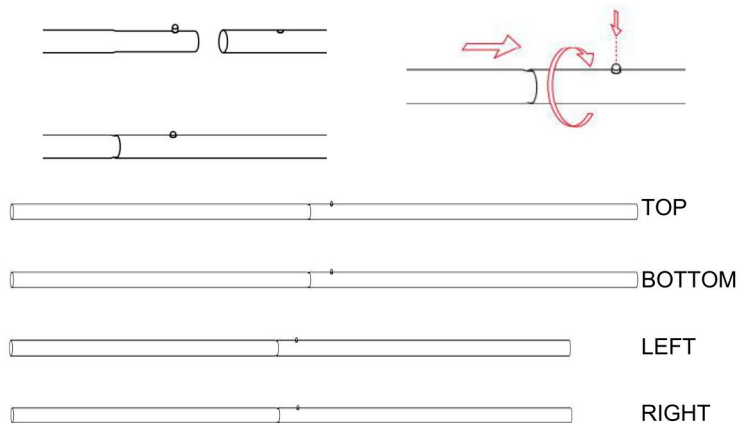

PASSO 2

- Fissare i pali verticali (SINISTRO e DESTRO) al piedi utilizzando i bulloni e il cacciavite inclusi .

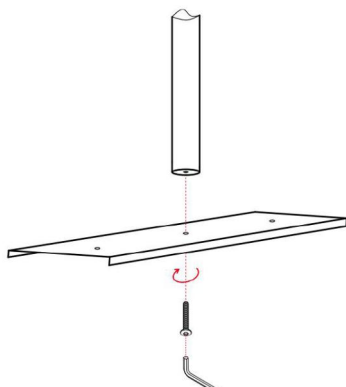

PASSO 3

- Far scorrere i pali orizzontali (SUPERIORE E INFERIORE) attraverso la tasca superiore e inferiore del palo.

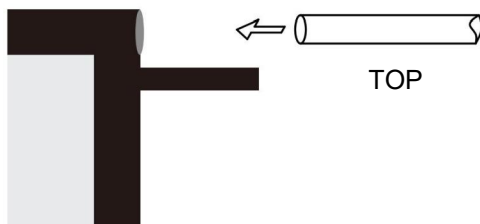

PASSO 4

- Fissare i pali orizzontali (ALTO E BASSO) ai pali verticali (SINISTRO E DESTRO) tramite i connettori metallici. Utilizzare il velcro sul tessuto per fissare i pali verticali, rendere lo schermo stretto e liscio.

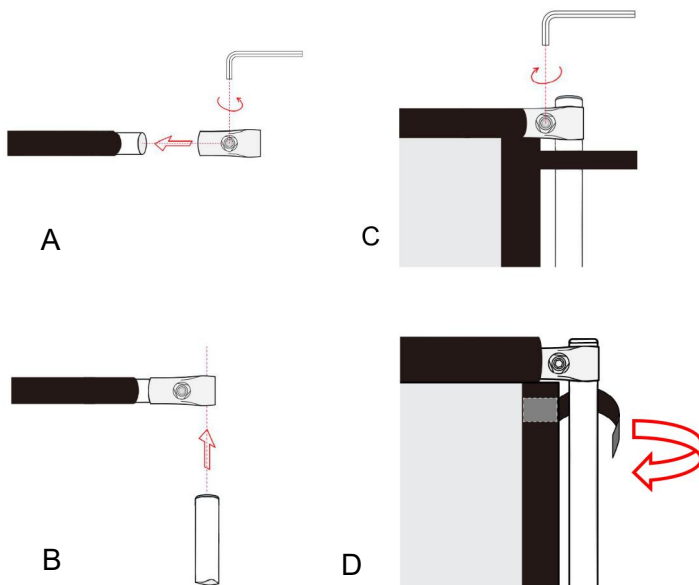

COMPLETION

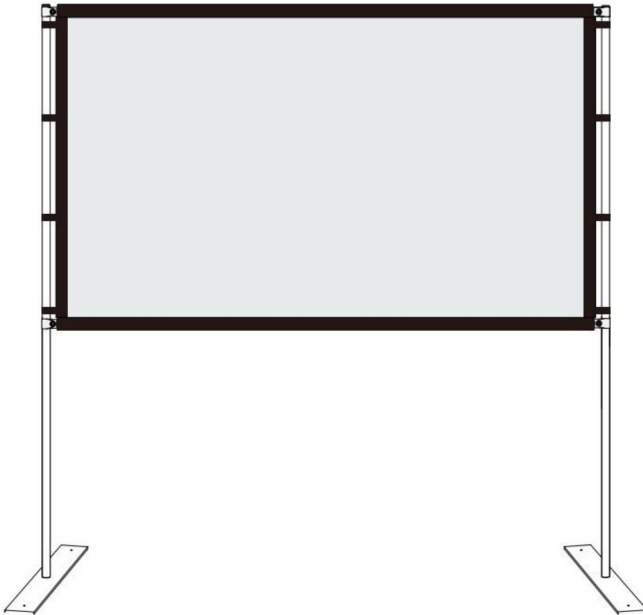

Produttore: Shanghaimuxinmuyeyouxiangongsi

Indirizzo: Shuangchenglu 803nong11hao1602A-1609shi, baoshanqu, shanghai 200000 CN.

Importato in AUS: SIHAO PTY LTD. 1 ROKEVA STREETEASTWOOD NSW 2122 Australia

Importato negli USA: Sanven Technology Ltd. Suite 250, 9166 Anaheim Place, Rancho Cucamonga, CA 91730



E-CrossStu GmbH
Mainzer Landstr.69, 60329 Frankfurt am Main.



YH CONSULTING LIMITED.
C/O YH Consulting Limited Office 147, Centurion House, London Road, Staines-upon-Thames, Surrey, TW18 4AX

VEVOR[®]

TOUGH TOOLS, HALF PRICE

Tecnico Supporto e certificato di garanzia elettronica

www.vevor.com/support