

VEVOR[®]

TOUGH TOOLS, HALF PRICE

Technical Support and E-Warranty Certificate www.vevor.com/support

POSITIONING SQUARES

We continue to be committed to provide you tools with competitive price.

"Save Half", "Half Price" or any other similar expressions used by us only represents an estimate of savings you might benefit from buying certain tools with us compared to the major top brands and does not necessarily mean to cover all categories of tools offered by us. You are kindly reminded to verify carefully when you are placing an order with us if you are actually saving half in comparison with the top major brands.

VEVOR[®]

TOUGH TOOLS, HALF PRICE

POSITIONING SQUARES

MODEL:140*140*4

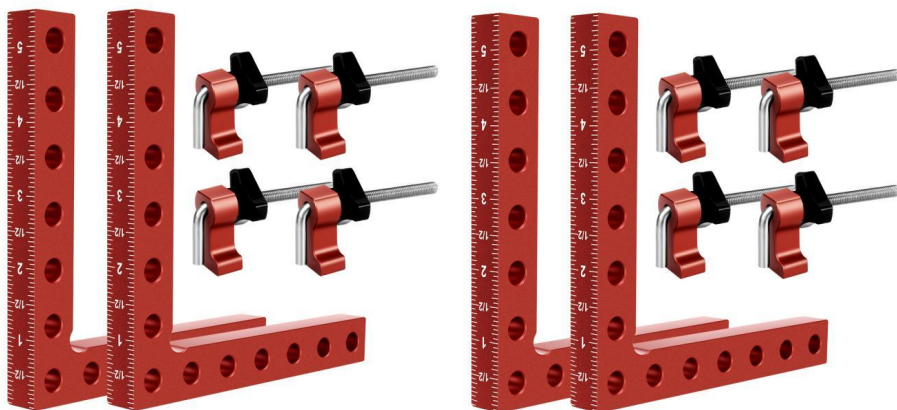

NEED HELP? CONTACT US!

Have product questions? Need technical support? Please feel free to contact us:

Technical Support and E-Warranty Certificate
www.vevor.com/support

This is the original instruction, please read all manual instructions carefully before operating. VEVOR reserves a clear interpretation of our user manual. The appearance of the product shall be subject to the product you received. Please forgive us that we won't inform you again if there are any technology or software updates on our product.



Warning-To reduce the risk of injury, user must read instructions manual carefully.

INTRODUCE ITM DETAILS



90 Degree Right Positioning Clamp

*4



Suitable for Thicker Plates

*8



High Quality Plastic Knobs

*8



Adjustable Fixed Block

*8

These assembly tools are CNC machined out of one solid chunk of aluminum to a tolerance of ± 0.0255 degrees.

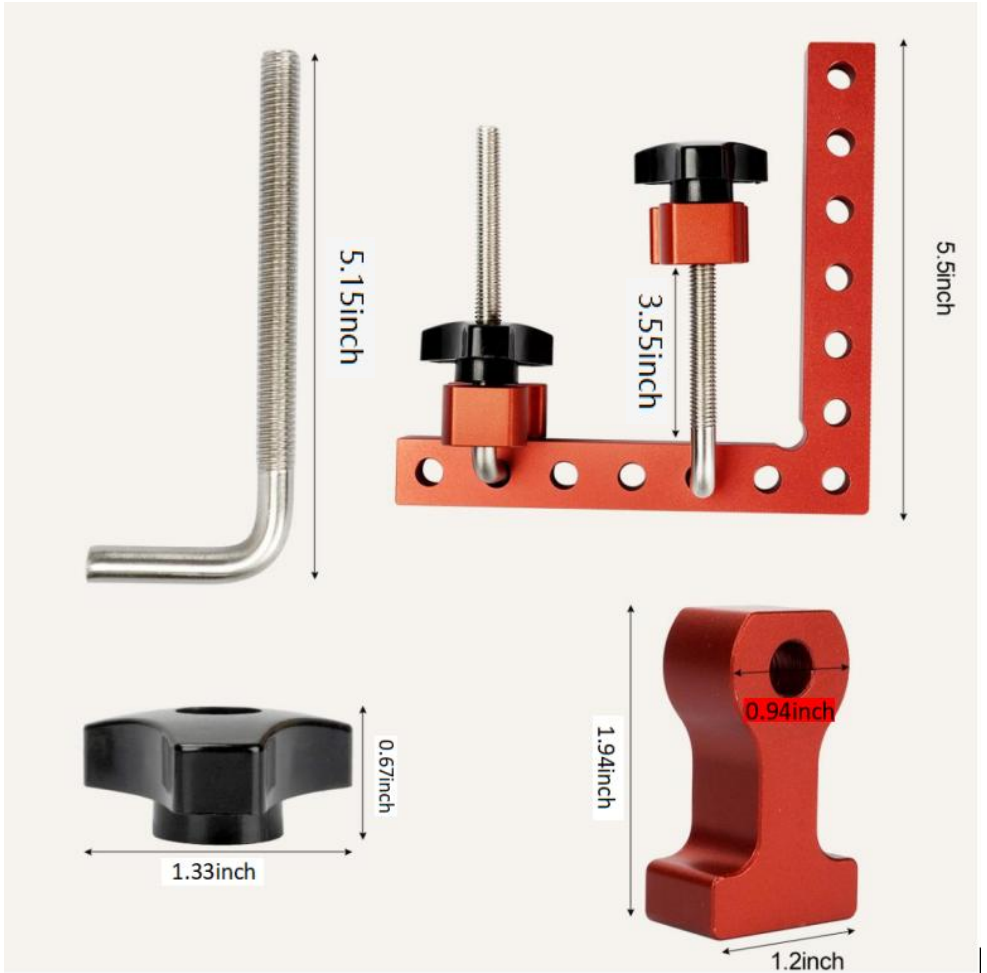

ANODIZED ALUMINUM ALLOY STRUCTUE

Two measurement methods, laser engraving, accurate scale, durable and easy to read. The 90-degree positioning clip adopts a high-strength metal structure to ensure the best durability and lightweight usability.

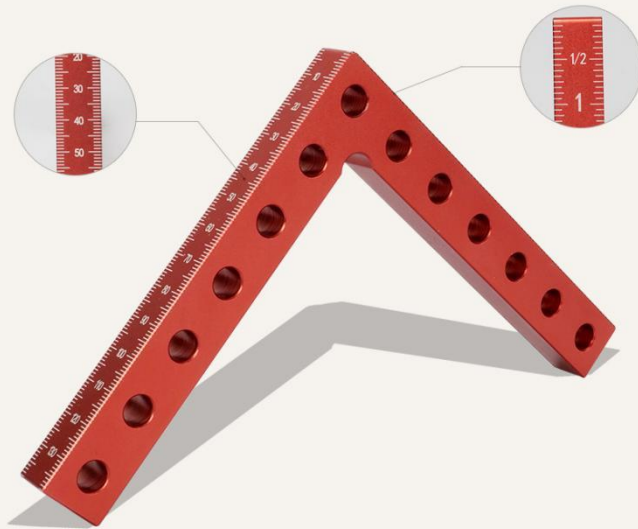

PERFECT 90 DEGREE

This clamping squares for woodworking are precision engineered and rigorously tested to ensure you get the dead square corners and joints so necessary for keeping your projects in specification.

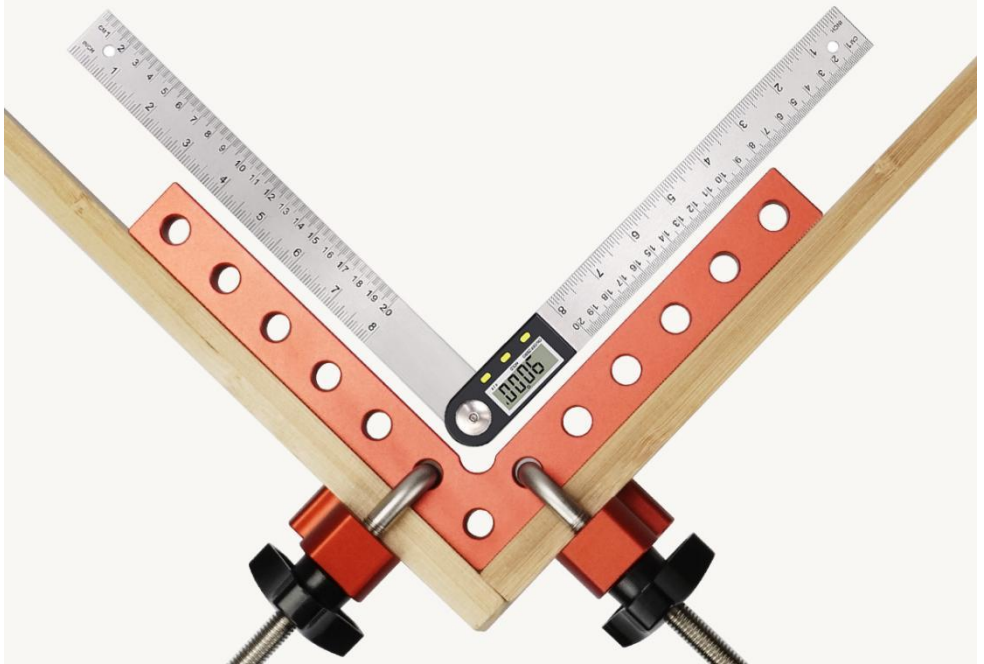

EXQUISITE CRAFTSMANSHIP

Suitable for some home projects.



VEVOR[®]

TOUGH TOOLS, HALF PRICE

Technical Support and E-Warranty Certificate

www.vevor.com/support

VEVOR[®]

TOUGH TOOLS, HALF PRICE

Assistance technique et certificat de garantie électronique www.vevor.com/support

CARRES DE POSITIONNEMENT

Nous continuons à nous engager à vous fournir des outils à des prix compétitifs.

« Économisez la moitié », « Moitié prix » ou toute autre expression similaire utilisée par nous ne représente qu'une estimation des économies que vous pourriez réaliser en achetant certains outils chez nous par rapport aux grandes marques et ne couvre pas nécessairement toutes les catégories d'outils que nous proposons.

Nous vous rappelons de bien vouloir vérifier soigneusement lorsque vous passez une commande chez nous si vous économisez réellement la moitié par rapport aux grandes marques.

VEVOR[®]
TOUGH TOOLS, HALF PRICE

CARRES DE POSITIONNEMENT

MODÈLE : 140*140*4

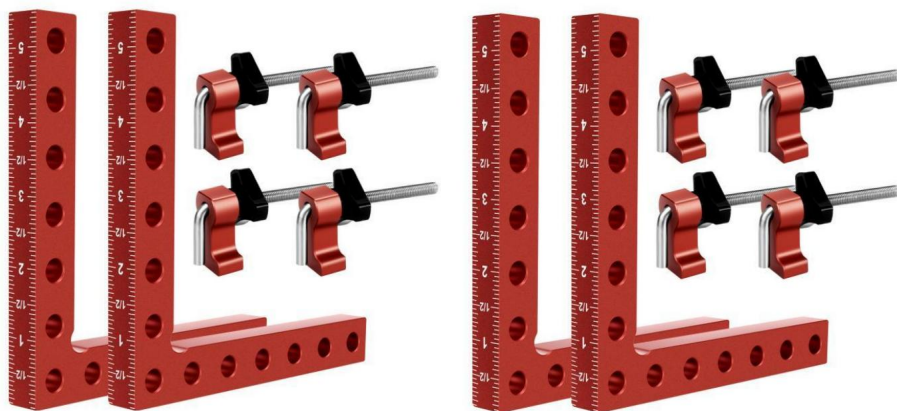

BESOIN D'AIDE? CONTACTEZ-NOUS!

Vous avez des questions sur nos produits ? Vous avez besoin d'assistance technique ?
N'hésitez pas

à nous contacter : Assistance technique et certificat de garantie
électronique www.vevor.com/support

Il s'agit de la notice d'utilisation d'origine. Veuillez lire attentivement toutes les instructions du manuel avant de l'utiliser. VEVOR se réserve le droit d'interpréter clairement notre manuel d'utilisation. L'apparence du produit dépend du produit que vous avez reçu. Veuillez nous excuser, nous ne vous informerons plus en cas de mise à jour technologique ou logicielle de notre produit.



Avertissement - Pour réduire le risque de blessure, l'utilisateur doit lire attentivement le manuel d'instructions.

INTRODUCE ITM DETAILS

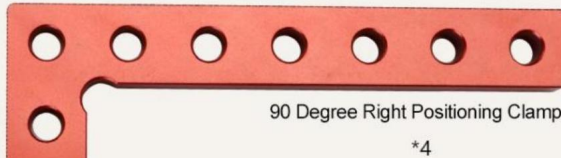

Suitable for Thicker Plates
*8



High Quality Plastic Knobs
*8



Adjustable Fixed Block
*8

These assembly tools are CNC machined out of one solid chunk of aluminum to a tolerance of $+.0255$ degrees.

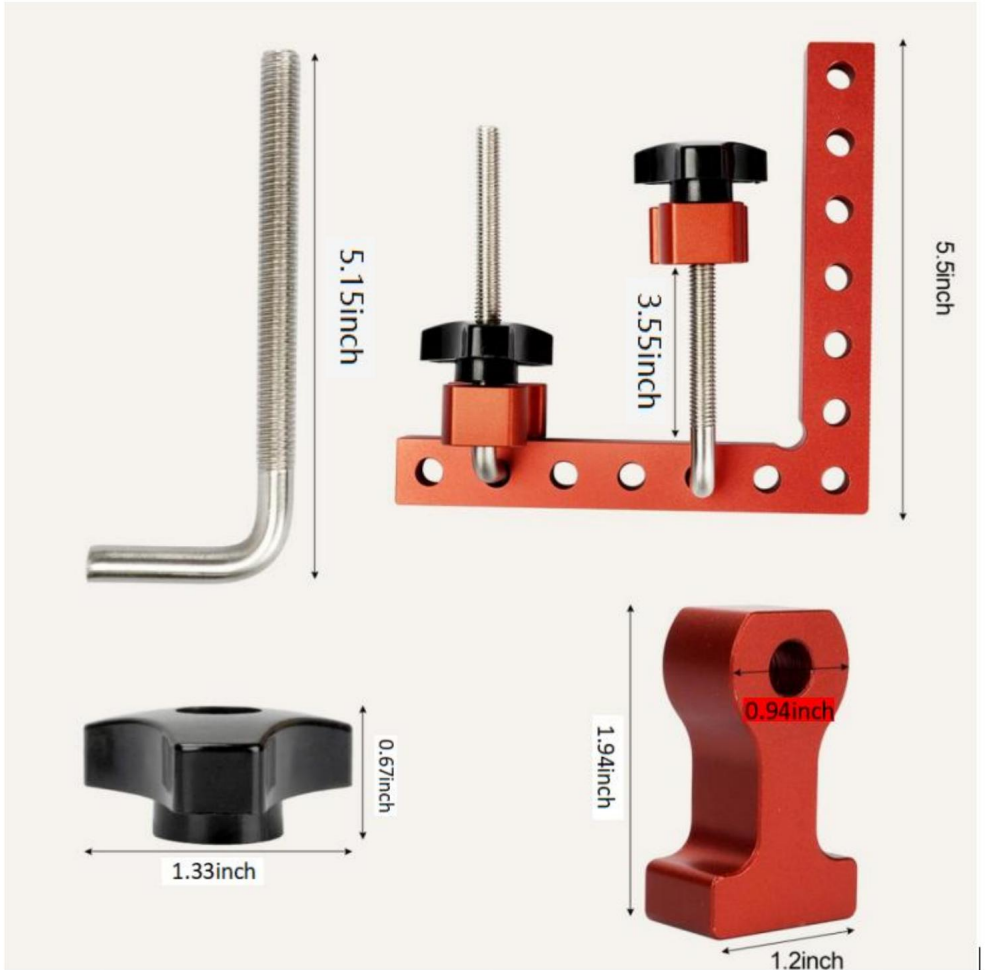

ANODIZED ALUMINUM ALLOY STRUCTUE

Two measurement methods, laser engraving, accurate scale, durable and easy to read. The 90-degree positioning clip adopts a high-strength metal structure to ensure the best durability and lightweight usability.

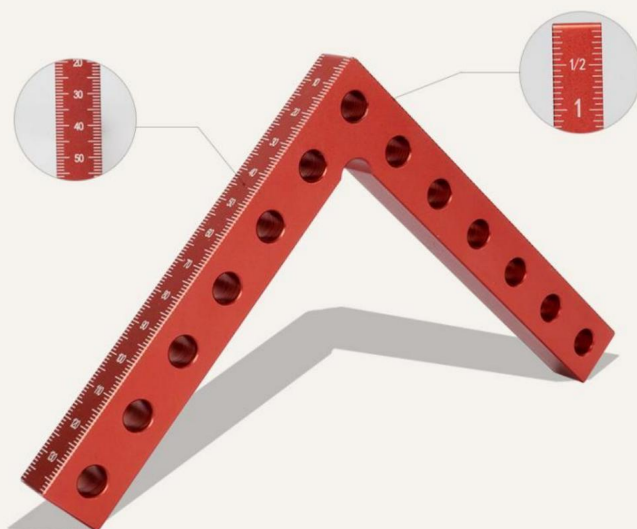

PERFECT 90 DEGREE

This clamping squares for woodworking are precision engineered and rigorously tested to ensure you get the dead square corners and joints so necessary for keeping your projects in specification.

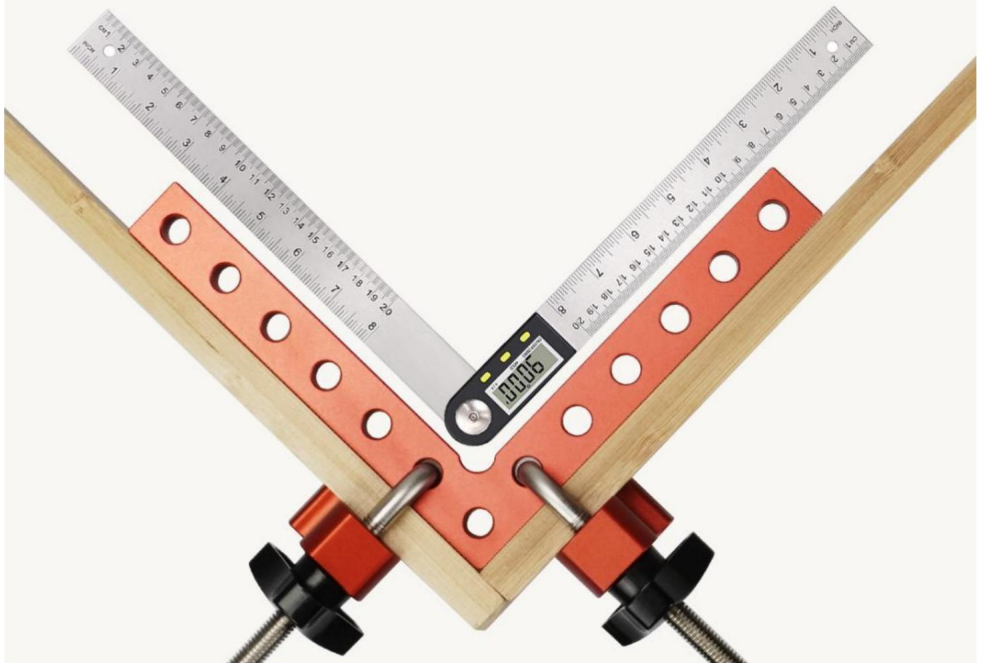

EXQUISITE CRAFTSMANSHIP

Suitable for some home projects.



VEVOR[®]

TOUGH TOOLS, HALF PRICE

Assistance technique et certificat de garantie
électronique www.vevor.com/support

VEVOR[®]

TOUGH TOOLS, HALF PRICE

Technischer Support und E-Garantie-Zertifikat www.vevor.com/support

POSITIONIERUNGSQUADRATE

Wir sind weiterhin bestrebt, Ihnen Werkzeuge zu wettbewerbsfähigen Preisen anzubieten.

„Sparen Sie die Hälfte“, „Halber Preis“ oder andere ähnliche Ausdrücke, die wir verwenden, stellen nur eine Schätzung der Ersparnis dar, die Sie beim Kauf bestimmter Werkzeuge bei uns im Vergleich zu den großen Topmarken erzielen können, und decken nicht notwendigerweise alle von uns angebotenen Werkzeugkategorien ab. Wir möchten Sie freundlich daran erinnern, bei Ihrer Bestellung bei uns sorgfältig zu prüfen, ob Sie im Vergleich zu den großen Topmarken tatsächlich die Hälfte sparen.

VEVOR[®]
TOUGH TOOLS, HALF PRICE

POSITIONIERUNGSQUADRATE

MODELL: 140 * 140 * 4

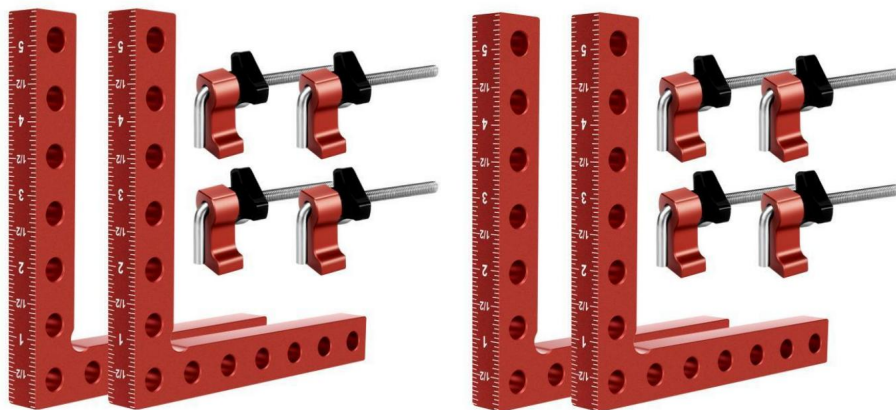

Brauchen Sie Hilfe? Kontaktieren Sie uns!

Haben Sie Fragen zum Produkt? Benötigen Sie technischen Support? Bitte kontaktieren Sie uns:

Technischer Support und E-Garantie-Zertifikat www.vevor.com/support

Dies ist die Originalanleitung. Bitte lesen Sie alle Anweisungen sorgfältig durch, bevor Sie das Gerät in Betrieb nehmen. VEVOR behält sich eine klare Auslegung unserer Bedienungsanleitung vor. Das Erscheinungsbild des Produkts richtet sich nach dem Produkt, das Sie erhalten haben. Bitte verzeihen Sie uns, dass wir Sie nicht erneut informieren, wenn es Technologie- oder Software-Updates für unser Produkt gibt.



Warnung: Um das Verletzungsrisiko zu verringern, muss der Benutzer die Bedienungsanleitung sorgfältig lesen.

INTRODUCE ITM DETAILS

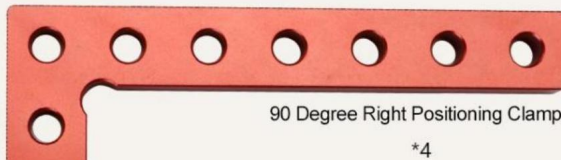

Suitable for Thicker Plates
*8



High Quality Plastic Knobs
*8



Adjustable Fixed Block
*8

These assembly tools are CNC machined out of one solid chunk of aluminum to a tolerance of ± 0.0255 degrees.

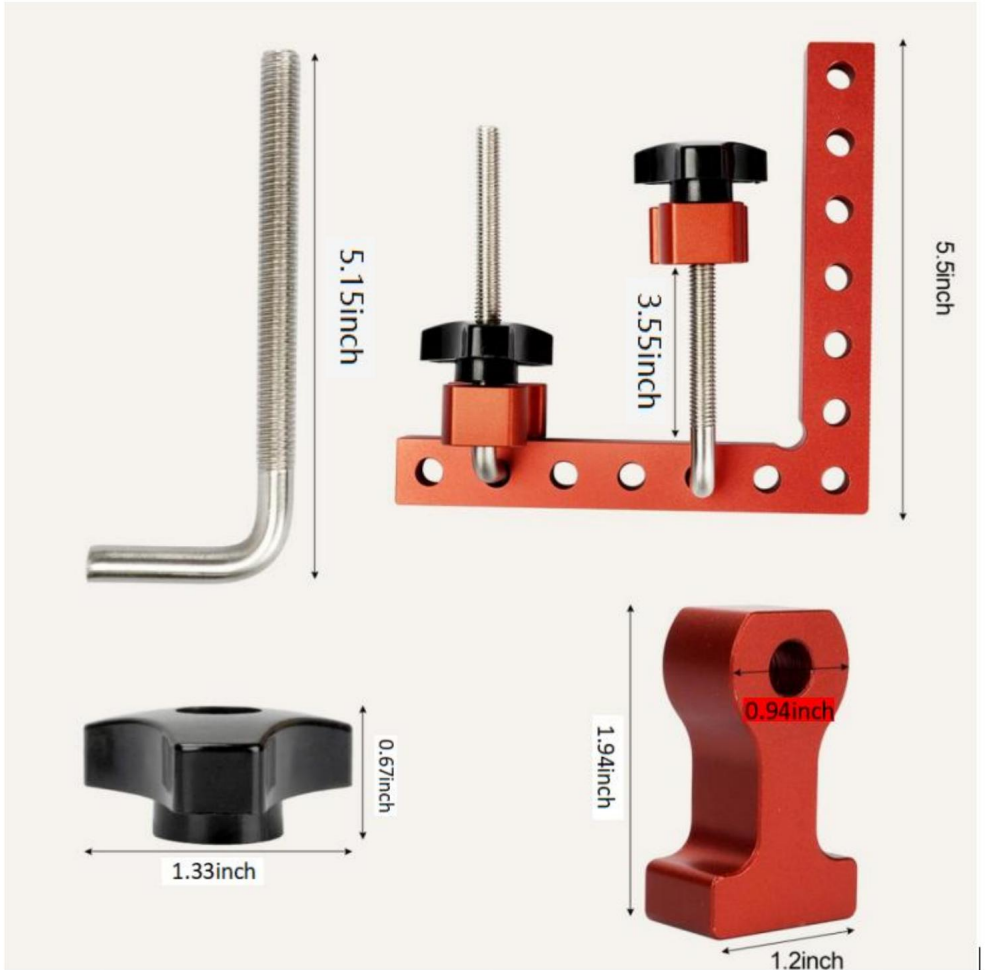

ANODIZED ALUMINUM ALLOY STRUCTUE

Two measurement methods, laser engraving, accurate scale, durable and easy to read. The 90-degree positioning clip adopts a high-strength metal structure to ensure the best durability and lightweight usability.

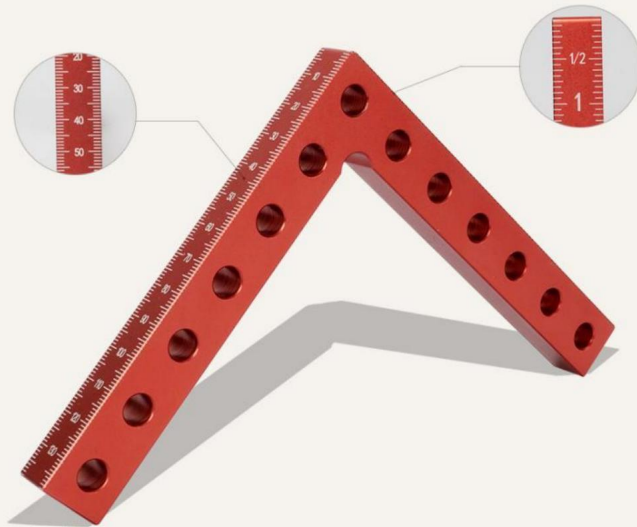

PERFECT 90 DEGREE

This clamping squares for woodworking are precision engineered and rigorously tested to ensure you get the dead square corners and joints so necessary for keeping your projects in specification.

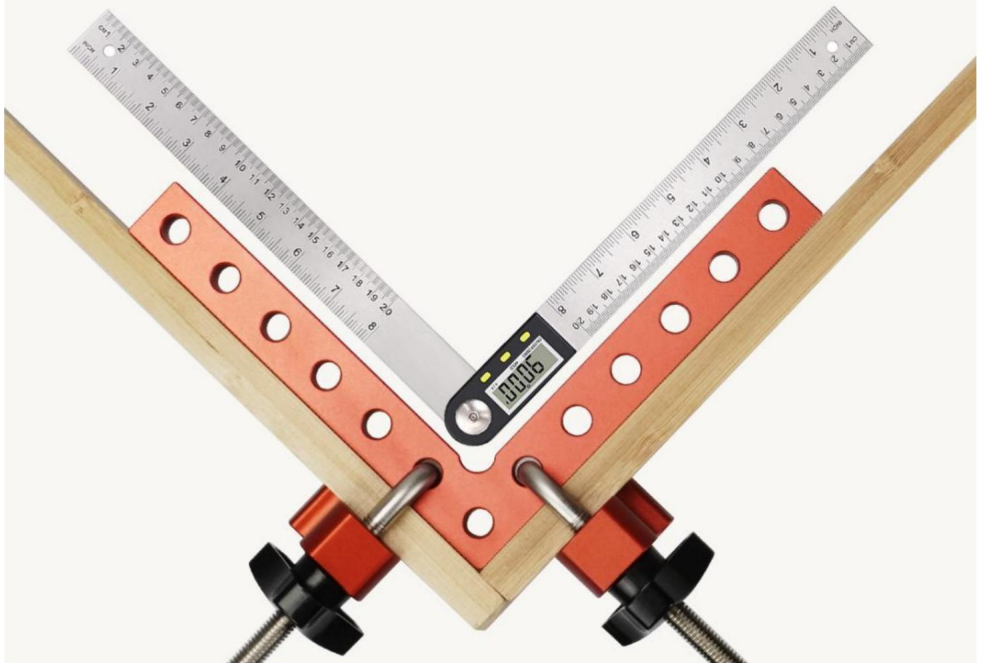

EXQUISITE CRAFTSMANSHIP

Suitable for some home projects.



VEVOR[®]

TOUGH TOOLS, HALF PRICE

Technischer Support und E-Garantie-Zertifikat

www.vevor.com/support

VEVOR[®]

TOUGH TOOLS, HALF PRICE

Supporto tecnico e certificato di garanzia elettronica www.vevor.com/support

POSIZIONAMENTO DEI QUADRATI

Continuiamo a impegnarci per fornirvi strumenti a prezzi competitivi.

"Risparmia la metà", "Metà prezzo" o qualsiasi altra espressione simile da noi utilizzata rappresenta solo una stima del risparmio che potresti ottenere acquistando determinati utensili con noi rispetto ai principali marchi principali e non significa necessariamente coprire tutte le categorie di utensili da noi offerti. Ti ricordiamo gentilmente di verificare attentamente quando effettui un ordine con noi se stai effettivamente risparmiando la metà rispetto ai principali marchi principali.

VEVOR[®]
TOUGH TOOLS, HALF PRICE

POSIZIONAMENTO DEI QUADRATI

MODELLO:140*140*4

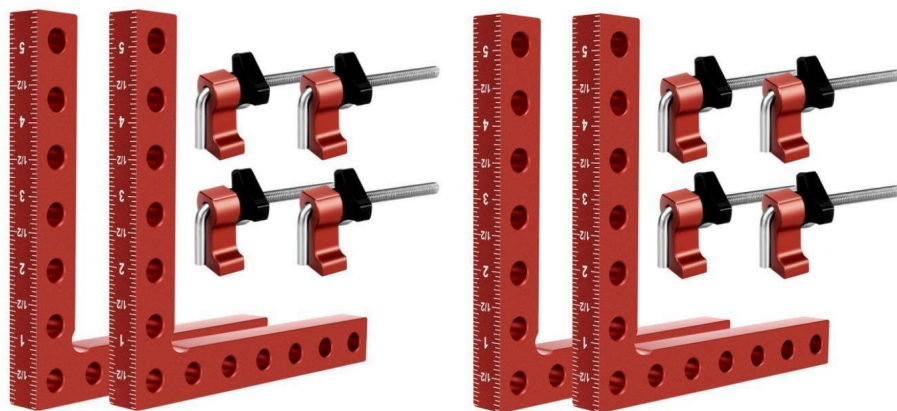

HAI BISOGNO DI AIUTO? CONTATTACI!

Hai domande sul prodotto? Hai bisogno di supporto tecnico? Non esitare a contattarci:

Supporto

**tecnico e certificato di garanzia elettronica [www.vevor.com/
support](http://www.vevor.com/support)**

Questa è l'istruzione originale, si prega di leggere attentamente tutte le istruzioni del manuale prima di utilizzare. VEVOR si riserva una chiara interpretazione del nostro manuale utente. L'aspetto del prodotto sarà soggetto al prodotto ricevuto. Vi preghiamo di perdonarci se non vi informeremo di nuovo se ci sono aggiornamenti tecnologici o software sul nostro prodotto.



Attenzione: per ridurre il rischio di lesioni, l'utente deve leggere attentamente il manuale di istruzioni.

INTRODUCE ITM DETAILS

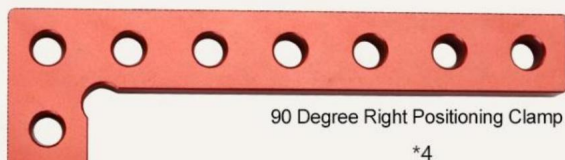

Suitable for Thicker Plates
*8



High Quality Plastic Knobs
*8



Adjustable Fixed Block
*8

These assembly tools are CNC machined out of one solid chunk of aluminum to a tolerance of ± 0.0255 degrees.

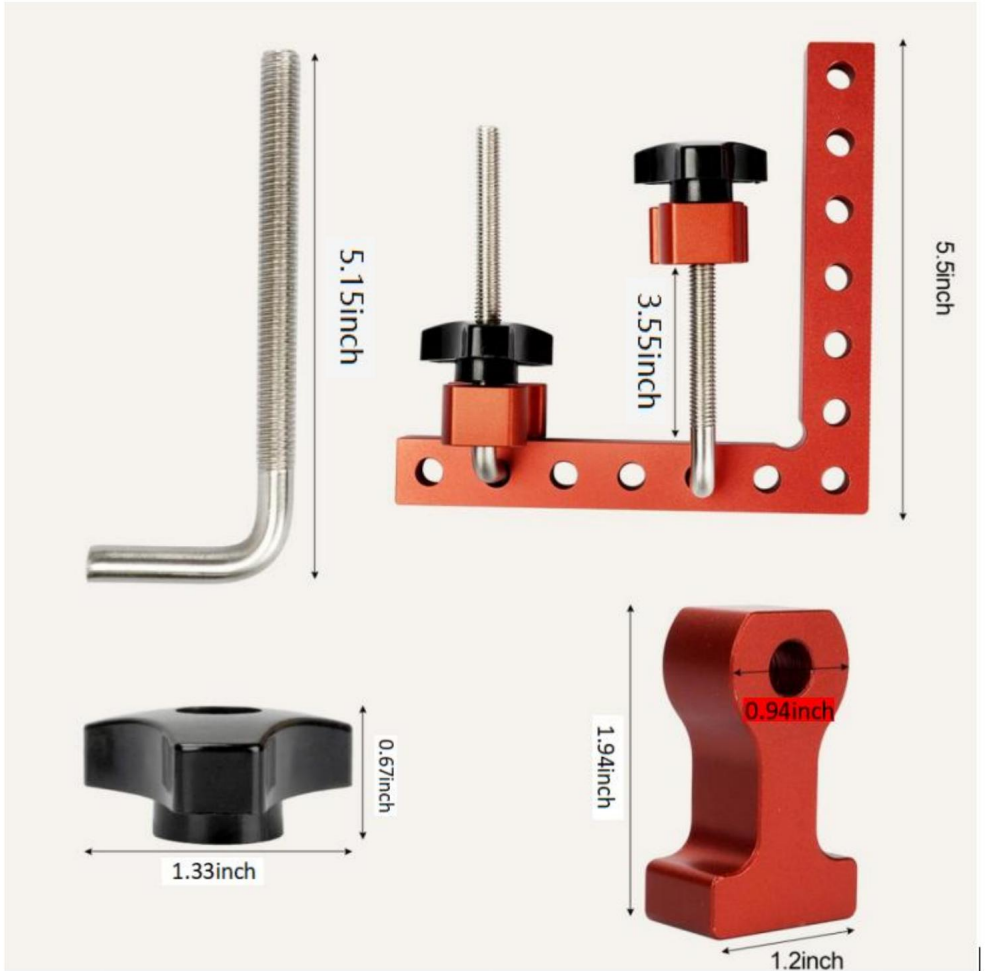

ANODIZED ALUMINUM ALLOY STRUCTUE

Two measurement methods, laser engraving, accurate scale, durable and easy to read. The 90-degree positioning clip adopts a high-strength metal structure to ensure the best durability and lightweight usability.

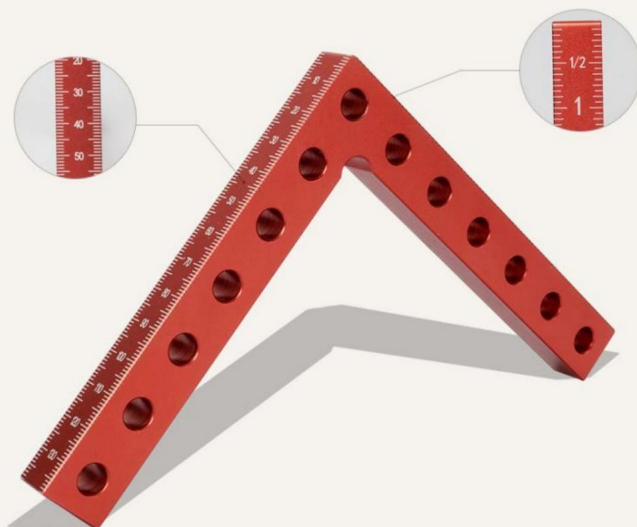

PERFECT 90 DEGREE

This clamping squares for woodworking are precision engineered and rigorously tested to ensure you get the dead square corners and joints so necessary for keeping your projects in specification.

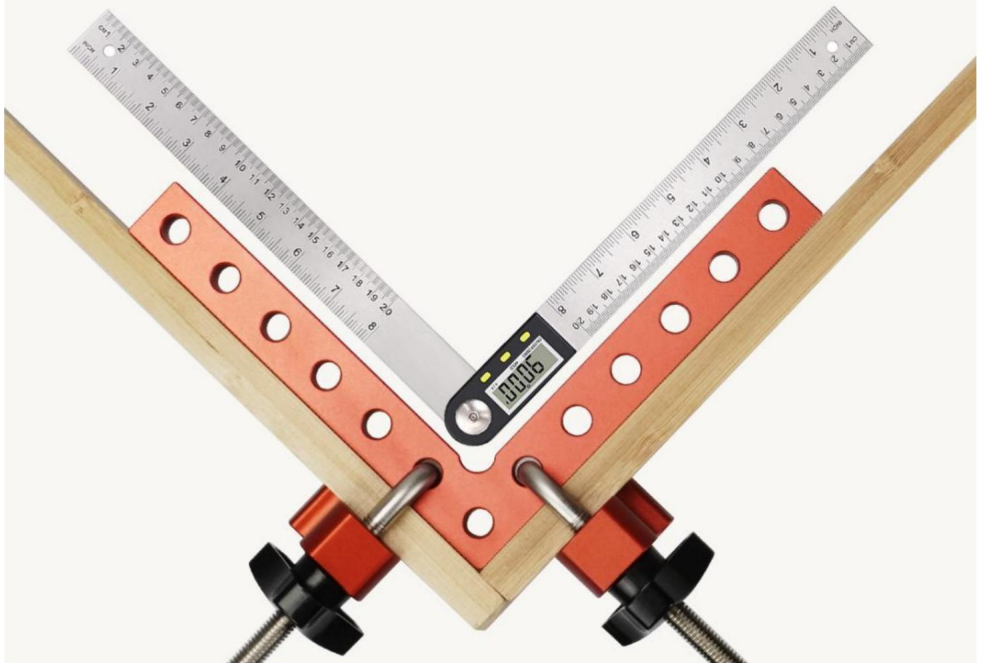

EXQUISITE CRAFTSMANSHIP

Suitable for some home projects.



VEVOR®

TOUGH TOOLS, HALF PRICE

**Supporto tecnico e certificato di garanzia
elettronica www.vevor.com/support**

VEVOR[®]

TOUGH TOOLS, HALF PRICE

Soporte técnico y certificado de garantía electrónica www.vevor.com/support

CUADRADOS DE POSICIONAMIENTO

Seguimos comprometidos a brindarle herramientas a precios competitivos.

"Ahorre la mitad", "mitad de precio" o cualquier otra expresión similar que utilicemos solo representa una estimación del ahorro que podría obtener al comprar ciertas herramientas con nosotros en comparación con las principales marcas y no necesariamente significa que cubra todas las categorías de herramientas que ofrecemos. Le recordamos que, al realizar un pedido con nosotros, verifique cuidadosamente si realmente está ahorrando la mitad en comparación con las principales marcas.

VEVOR[®]

TOUGH TOOLS, HALF PRICE

CUADRADOS DE POSICIONAMIENTO

MODELO: 140*140*4

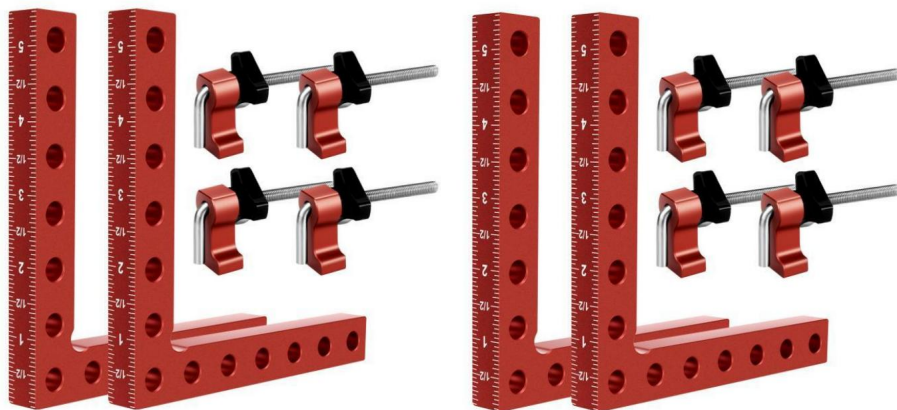

¿NECESITA AYUDA? ¡CONTÁCTENOS!

¿Tiene preguntas sobre el producto? ¿Necesita asistencia técnica? No dude en ponerse en contacto con

nosotros: Asistencia técnica y certificado de garantía electrónica
www.vevor.com/support

Estas son las instrucciones originales, lea atentamente todas las instrucciones del manual antes de utilizar el producto. VEVOR se reserva una interpretación clara de nuestro manual de usuario. La apariencia del producto estará sujeta al producto que recibió. Perdónenos por no informarle nuevamente si hay actualizaciones de tecnología o software en nuestro producto.



Advertencia: Para reducir el riesgo de lesiones, el usuario debe leer atentamente el manual de instrucciones.

INTRODUCE ITM DETAILS

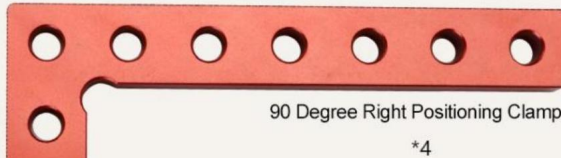

Suitable for Thicker Plates
*8



High Quality Plastic Knobs
*8



Adjustable Fixed Block
*8

These assembly tools are CNC machined out of one solid chunk of aluminum to a tolerance of ± 0.0255 degrees.

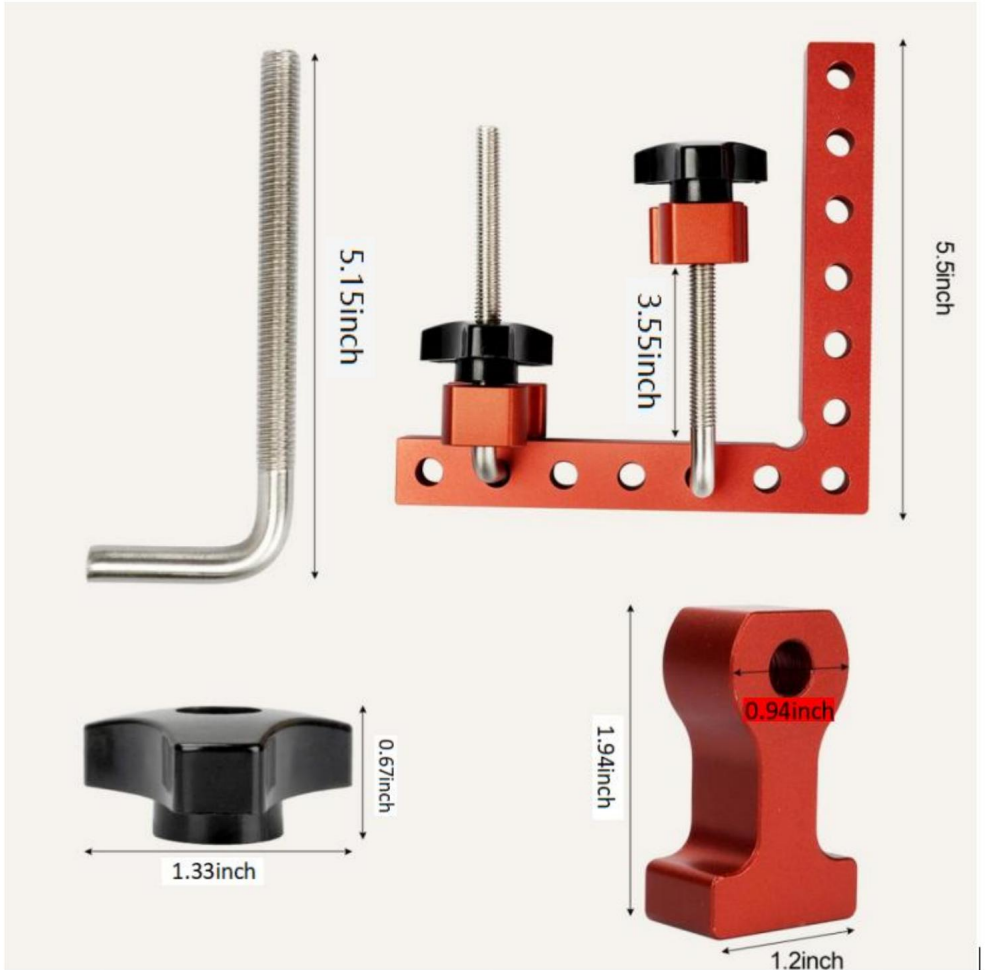

ANODIZED ALUMINUM ALLOY STRUCTUE

Two measurement methods, laser engraving, accurate scale, durable and easy to read. The 90-degree positioning clip adopts a high-strength metal structure to ensure the best durability and lightweight usability.

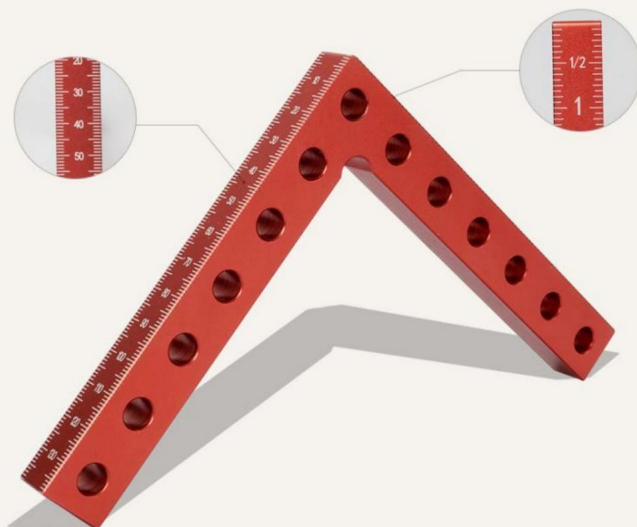

PERFECT 90 DEGREE

This clamping squares for woodworking are precision engineered and rigorously tested to ensure you get the dead square corners and joints so necessary for keeping your projects in specification.

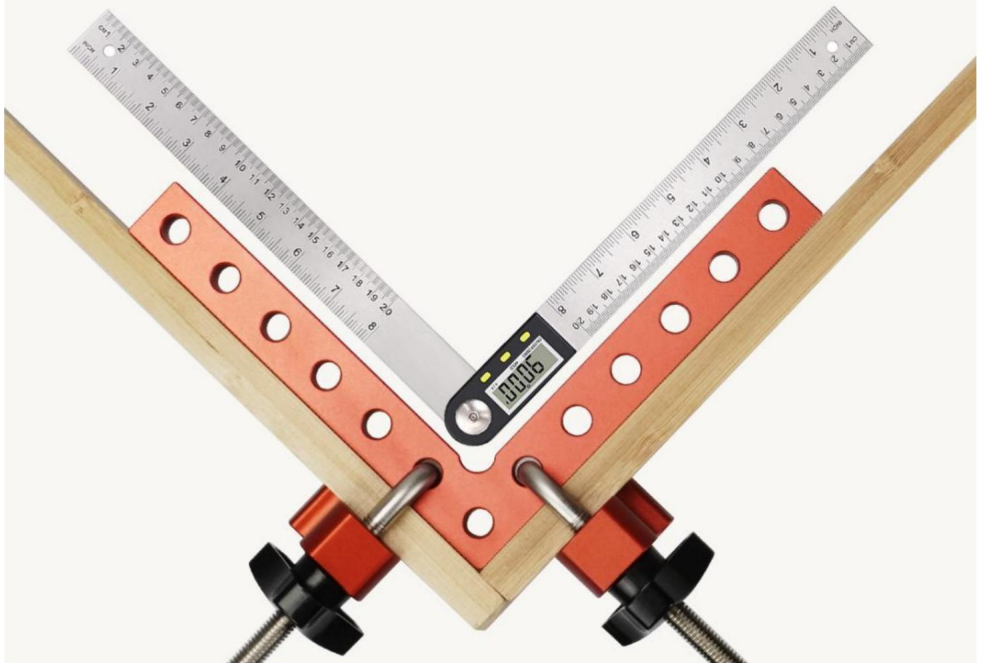

EXQUISITE CRAFTSMANSHIP

Suitable for some home projects.



VEVOR®

TOUGH TOOLS, HALF PRICE

Soporte técnico y certificado de garantía
electrónica www.vevor.com/support

VEVOR®

TOUGH TOOLS, HALF PRICE

Wsparcie techniczne i certyfikat gwarancji elektronicznej www.vevor.com/support

KWADRATY POZYCJONUJĄCE

Nadal staramy się oferować Państwu narzędzia w konkurencyjnych cenach.

„Oszczędź połowę”, „Połowa ceny” lub inne podobne wyrażenia używane przez nas stanowią jedynie szacunkowe oszczędności, jakie możesz uzyskać, kupując u nas określone narzędzia w porównaniu z głównymi markami i niekoniecznie oznaczają one objęcie wszystkich kategorii narzędzi oferowanych przez nas. Uprzejmie przypominamy, aby dokładnie sprawdzić, czy składając u nas zamówienie faktycznie oszczędzasz połowę w porównaniu z głównymi markami.

VEVOR[®]
TOUGH TOOLS, HALF PRICE

KWADRATY POZYCJONUJĄCE

MODEL: 140*140*4

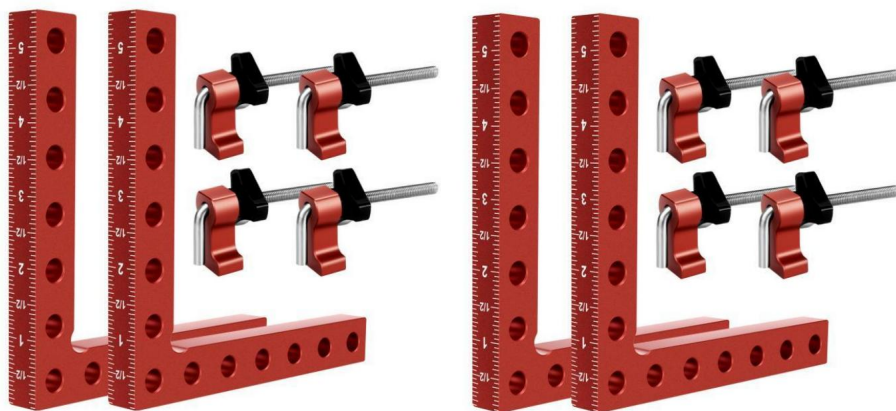

POTRZEBUJESZ POMOCY? SKONTAKTUJ SIĘ Z NAMI!

Masz pytania dotyczące produktu? Potrzebujesz wsparcia technicznego? Skontaktuj się z nami: Wsparcie

techniczne i certyfikat E-Gwarancji www.vevor.com/support

To jest oryginalna instrukcja, przed użyciem należy uważnie przeczytać wszystkie instrukcje. VEVOR zastrzega sobie jasną interpretację naszej instrukcji obsługi. Wygląd produktu będzie zależał od produktu, który otrzymałeś. Prosimy o wybaczenie, że nie poinformujemy Cię ponownie, jeśli w naszym produkcie pojawią się jakiegokolwiek aktualizacje technologiczne lub oprogramowania.



Ostrzeżenie: Aby zminimalizować ryzyko obrażeń, użytkownik powinien uważnie przeczytać instrukcję obsługi.

INTRODUCE ITM DETAILS



90 Degree Right Positioning Clamp

*4



Suitable for Thicker Plates

*8



High Quality Plastic Knobs

*8



Adjustable Fixed Block

*8

These assembly tools are CNC machined out of one solid chunk of aluminum to a tolerance of ± 0.0255 degrees.

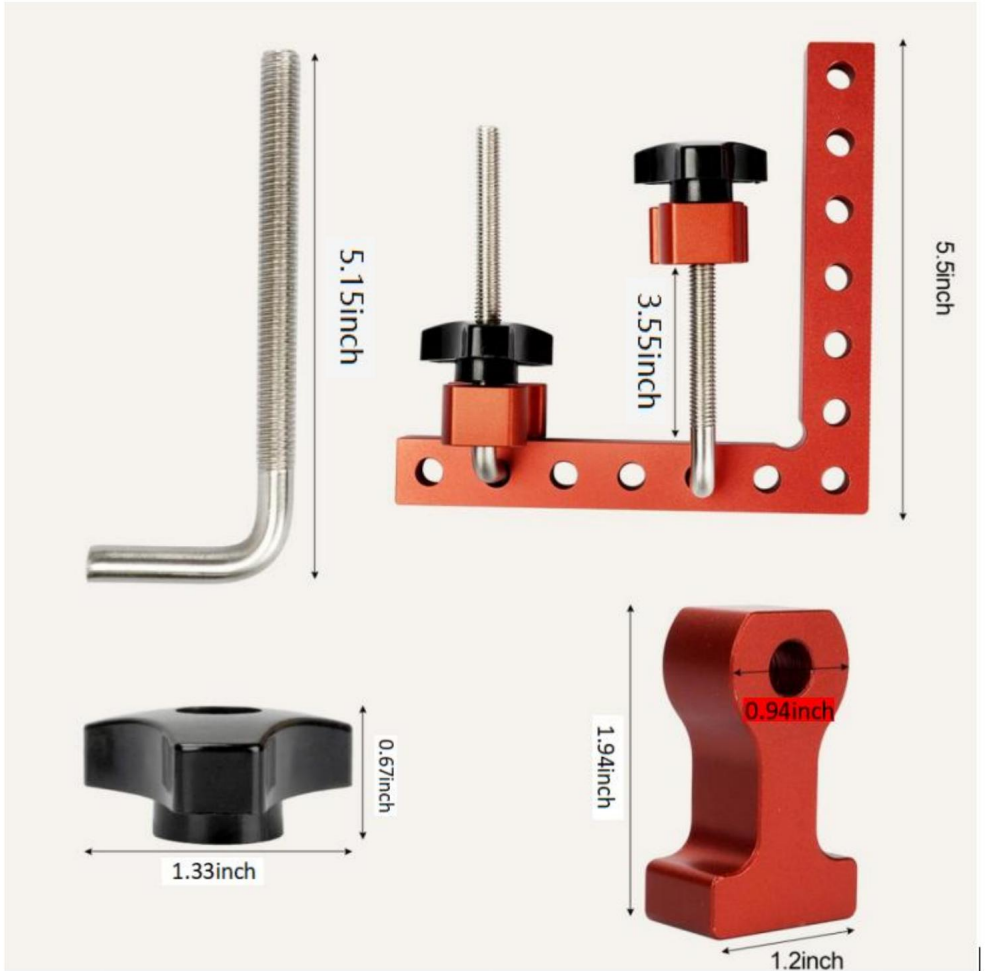

ANODIZED ALUMINUM ALLOY STRUCTUE

Two measurement methods, laser engraving, accurate scale, durable and easy to read. The 90-degree positioning clip adopts a high-strength metal structure to ensure the best durability and lightweight usability.

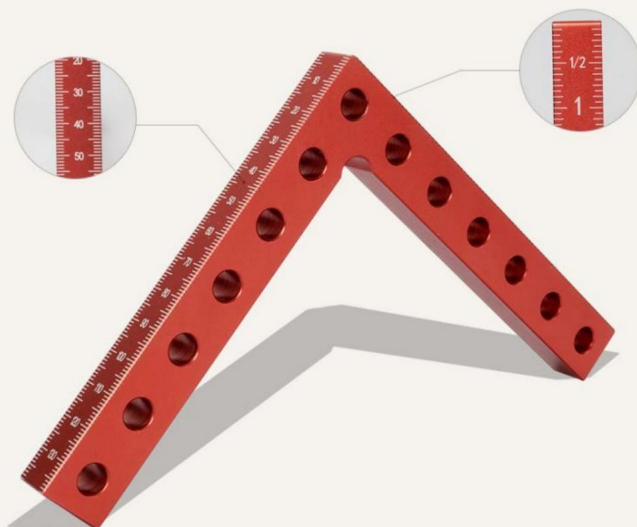

PERFECT 90 DEGREE

This clamping squares for woodworking are precision engineered and rigorously tested to ensure you get the dead square corners and joints so necessary for keeping your projects in specification.

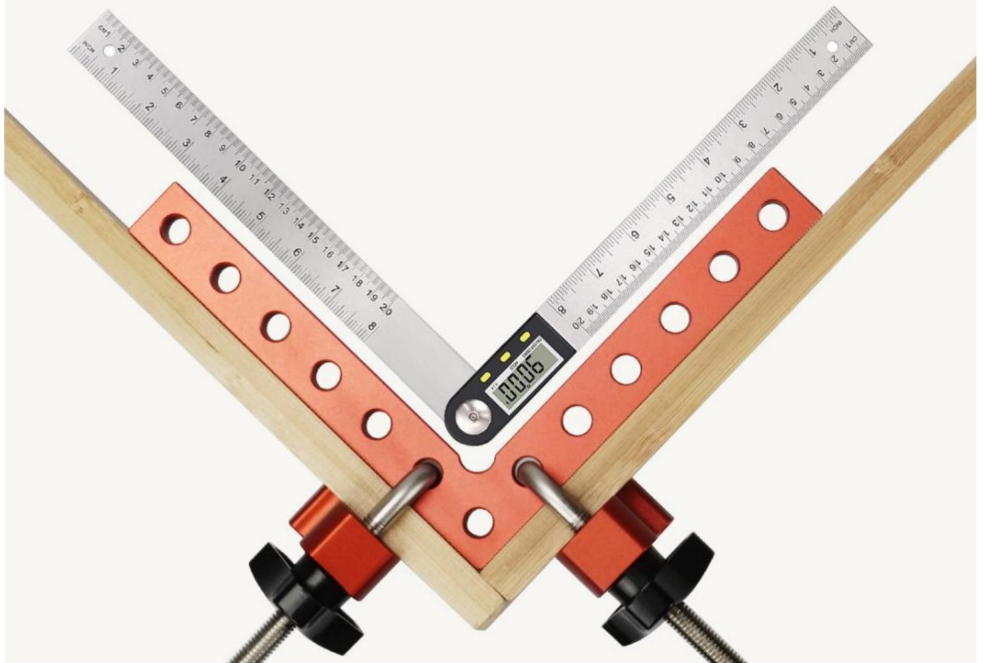

EXQUISITE CRAFTSMANSHIP

Suitable for some home projects.



VEVOR®

TOUGH TOOLS, HALF PRICE

Wsparcie techniczne i certyfikat gwarancji
elektronicznej www.vevor.com/support

VEVOR[®]

TOUGH TOOLS, HALF PRICE

Technische ondersteuning en e-garantiecertificaat www.vevor.com/support

POSITIONERINGSVIERKANTEN

Wij streven er voortdurend naar om u gereedschappen tegen concurrerende prijzen te leveren.

"Save Half", "Half Price" of andere soortgelijke uitdrukkingen die wij gebruiken, geven alleen een schatting weer van de besparingen die u kunt behalen door bepaalde gereedschappen bij ons te kopen in vergelijking met de grote topmerken en betekent niet noodzakelijkerwijs dat alle categorieën gereedschappen die wij aanbieden, worden gedekt.

Wij herinneren u eraan om zorgvuldig te controleren of u daadwerkelijk de helft bespaart in vergelijking met de grote topmerken wanneer u een bestelling bij ons plaatst.

VEVOR[®]

TOUGH TOOLS, HALF PRICE

POSITIONERINGSVIERKANTEN

MODEL: 140*140*4

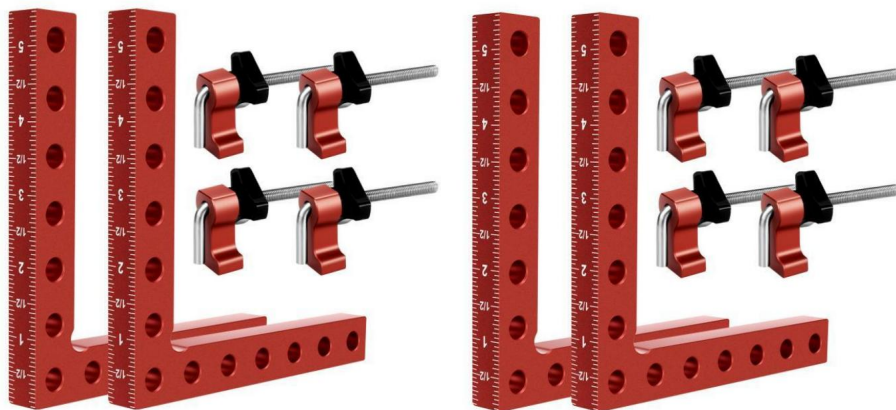

HULP NODIG? NEEM CONTACT MET ONS OP!

Heeft u vragen over het product? Heeft u technische ondersteuning nodig? Neem dan gerust contact met

ons op: **Technische ondersteuning en E-garantiecertificaat**
www.vevor.com/support

Dit is de originele instructie, lees alle handleidingen zorgvuldig door voordat u het product gebruikt. VEVOR behoudt zich een duidelijke interpretatie van onze gebruikershandleiding voor. Het uiterlijk van het product is afhankelijk van het product dat u hebt ontvangen. Vergeef ons dat we u niet opnieuw zullen informeren als er technologie- of software-updates voor ons product zijn.



Waarschuwing: om het risico op letsel te verkleinen, moet de gebruiker de gebruiksaanwijzing zorgvuldig lezen.

INTRODUCE ITM DETAILS

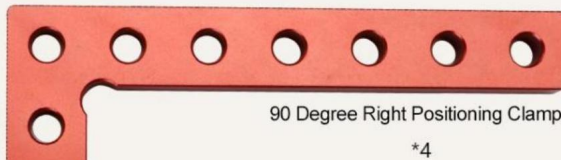

Suitable for Thicker Plates
*8



High Quality Plastic Knobs
*8



Adjustable Fixed Block
*8

These assembly tools are CNC machined out of one solid chunk of aluminum to a tolerance of ± 0.0255 degrees.

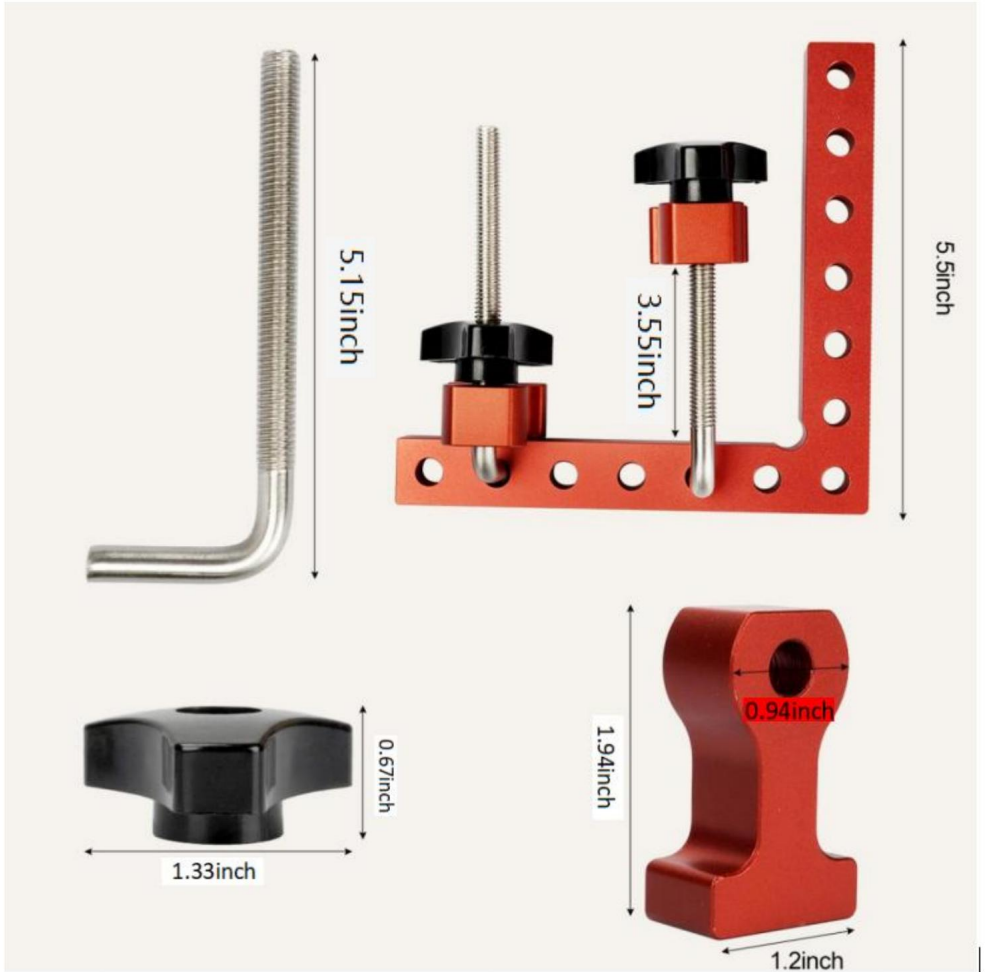

ANODIZED ALUMINUM ALLOY STRUCTUE

Two measurement methods, laser engraving, accurate scale, durable and easy to read. The 90-degree positioning clip adopts a high-strength metal structure to ensure the best durability and lightweight usability.

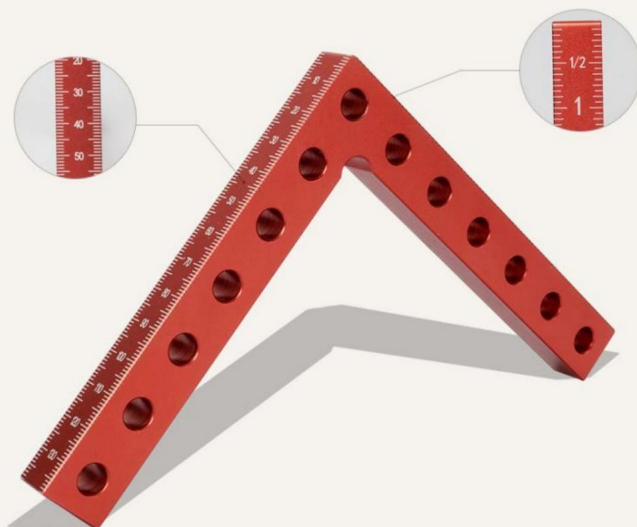

PERFECT 90 DEGREE

This clamping squares for woodworking are precision engineered and rigorously tested to ensure you get the dead square corners and joints so necessary for keeping your projects in specification.

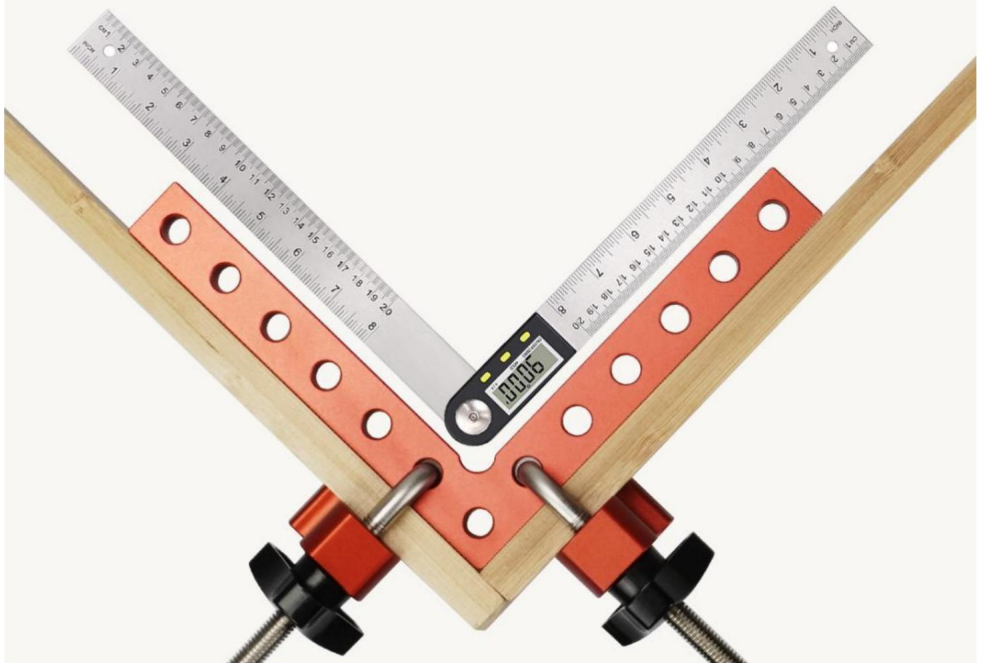

EXQUISITE CRAFTSMANSHIP

Suitable for some home projects.



VEVOR[®]

TOUGH TOOLS, HALF PRICE

**Technische ondersteuning en e-
garantiecertificaat www.vevor.com/support**

VEVOR[®]

TOUGH TOOLS, HALF PRICE

Teknisk support och e-garanticertifikat www.vevor.com/support

POSITIONERINGSKVADRAT

Vi fortsätter att vara engagerade i att ge dig verktyg till konkurrenskraftiga priser.

"Spara hälften", "halva priset" eller andra liknande uttryck som används av oss representerar bara en uppskattning av besparingar du kan dra nytta av att köpa vissa verktyg hos oss jämfört med de stora toppmärkena och betyder inte nödvändigtvis att täcka alla kategorier av verktyg som erbjuds av oss. Du påminns vänligen om att noggrant kontrollera när du gör en beställning hos oss om du faktiskt sparar hälften i jämförelse med de främsta stora varumärkena.

VEVOR[®]

TOUGH TOOLS, HALF PRICE

POSITIONERINGSKVADRAT

MODELL:140*140*4

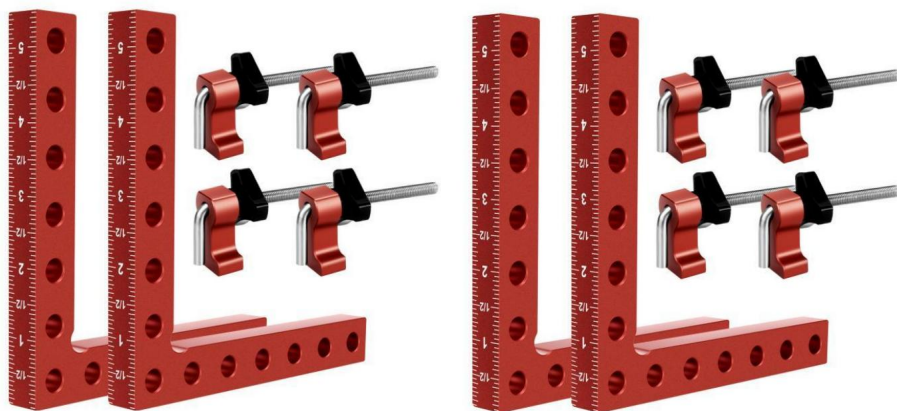

BEHÖVER HJÄLP? KONTAKTA OSS!

Har du produktfrågor? Behöver du teknisk support? Kontakta oss gärna: **Teknisk support och e-garanticertifikat www.vevor.com/support**

Detta är den ursprungliga instruktionen, läs alla instruktioner noggrant innan du använder den. VEVOR reserverar sig för en tydlig tolkning av vår användarmanual. Utseendet på produkten är beroende av den produkt du fått. Ursäkta oss att vi inte kommer att informera dig igen om det finns någon teknik eller mjukvaruuppdateringar på vår produkt.



Varning - För att minska risken för skada måste användaren läsa instruktionerna noggrant.

INTRODUCE ITM DETAILS

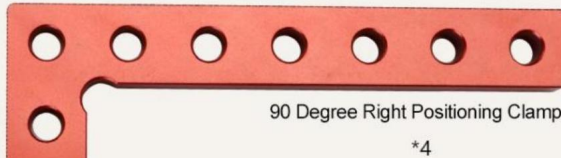

Suitable for Thicker Plates
*8



High Quality Plastic Knobs
*8



Adjustable Fixed Block
*8

These assembly tools are CNC machined out of one solid chunk of aluminum to a tolerance of $+0.0255$ degrees.

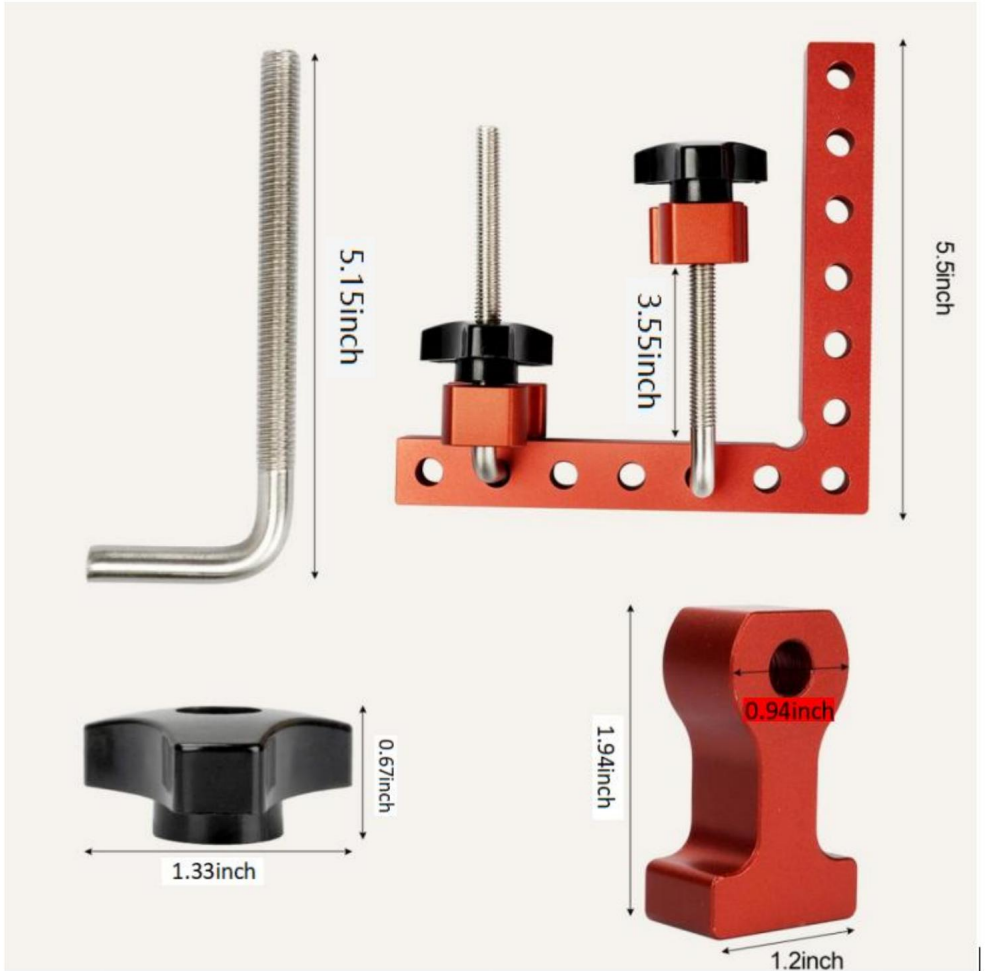

ANODIZED ALUMINUM ALLOY STRUCTUE

Two measurement methods, laser engraving, accurate scale, durable and easy to read. The 90-degree positioning clip adopts a high-strength metal structure to ensure the best durability and lightweight usability.

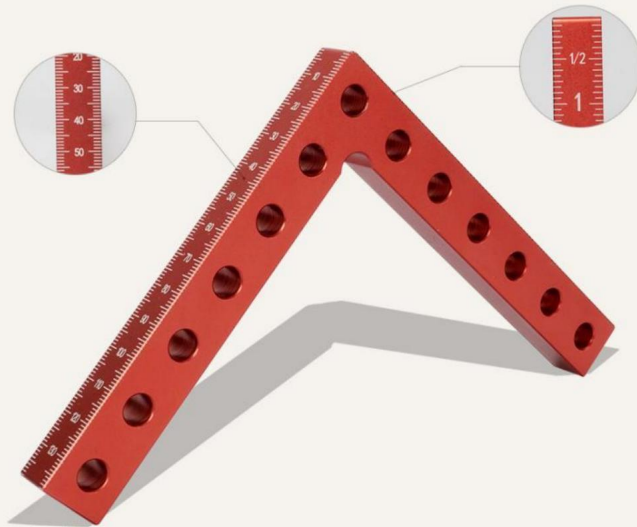

PERFECT 90 DEGREE

This clamping squares for woodworking are precision engineered and rigorously tested to ensure you get the dead square corners and joints so necessary for keeping your projects in specification.

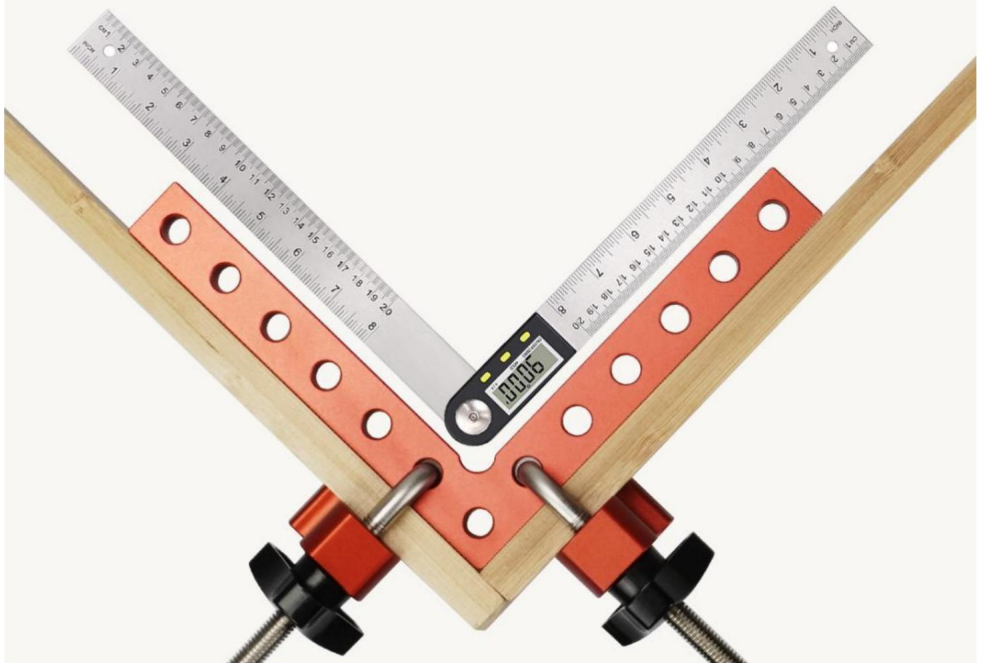

EXQUISITE CRAFTSMANSHIP

Suitable for some home projects.



VEVOR[®]

TOUGH TOOLS, HALF PRICE

Teknisk support och e-garanticertifikat

www.vevor.com/support