

VEVOR[®]

TOUGH TOOLS, HALF PRICE

Technical Support and E-Warranty Certificate

www.vevor.com/support

RATTAN COFFEE TABLE USER MANUAL

MODEL NO.: SR191630WT, SR191630BK, SR191630ND

We continue to be committed to provide you tools with competitive price.

"Save Half", "Half Price" or any other similar expressions used by us only represents an estimate of savings you might benefit from buying certain tools with us compared to the major top brands and does not necessarily mean to cover all categories of tools offered by us. You are kindly reminded to verify carefully when you are placing an order with us if you are actually saving half in comparison with the top major brands.

VEVOR[®]

TOUGH TOOLS, HALF PRICE

Rattan Coffee Table

MODEL NO.: SR191630WT, SR191630BK, SR191630ND

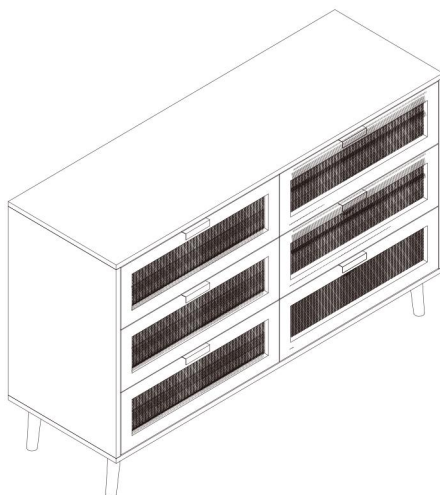

NEED HELP? CONTACT US!

Have product questions? Need technical support? Please feel free to contact us:

Technical Support and E-Warranty Certificate
www.vevor.com/support

This is the original instruction, please read all manual instructions carefully before operating. VEVOR reserves a clear interpretation of our user manual. The appearance of the product shall be subject to the product you received. Please forgive us that we won't inform you again if there are any technology or software updates on our product.

 **WARNING:**

Please read this manual carefully before using the product. Failure to do so may result in serious injury.

ASSEMBLY PRECAUTIONS

1. Assemble only according to these instructions. Improper assembly can create hazards.
2. Wear ANSI-approved safety goggles and heavy-duty work gloves during assembly.
3. Keep the assembly area clean and well-lit.
4. Keep bystanders out of the area during assembly.
5. Do not assemble when tired or when under the influence of alcohol, drugs or medication.
6. The product capabilities apply to properly and completely assembled products only.
7. Assemble on a flat, level, hard and smooth surface capable of safely supporting the Rattan Coffee Table.
8. For additional information regarding the parts listed in the following pages, please refer to the Assembly Diagram of this manual. Unwrap and separate all parts in a clean work area.

SAVE THESE INSTRUCTIONS

USE PRECAUTIONS

TO PREVENT SERIOUS INJURY AND DEATH FROM TIPPING:

1. This product is not a toy Do not allow children to play with or near this item.
2. Do not exceed weight capacities, before moving.
3. Use only on a flat, hard and smooth surface capable of safely supporting a fully loaded Rattan Coffee Table.
4. Use as intended only.
Inspect before every use; do not use if parts are loose or damaged.









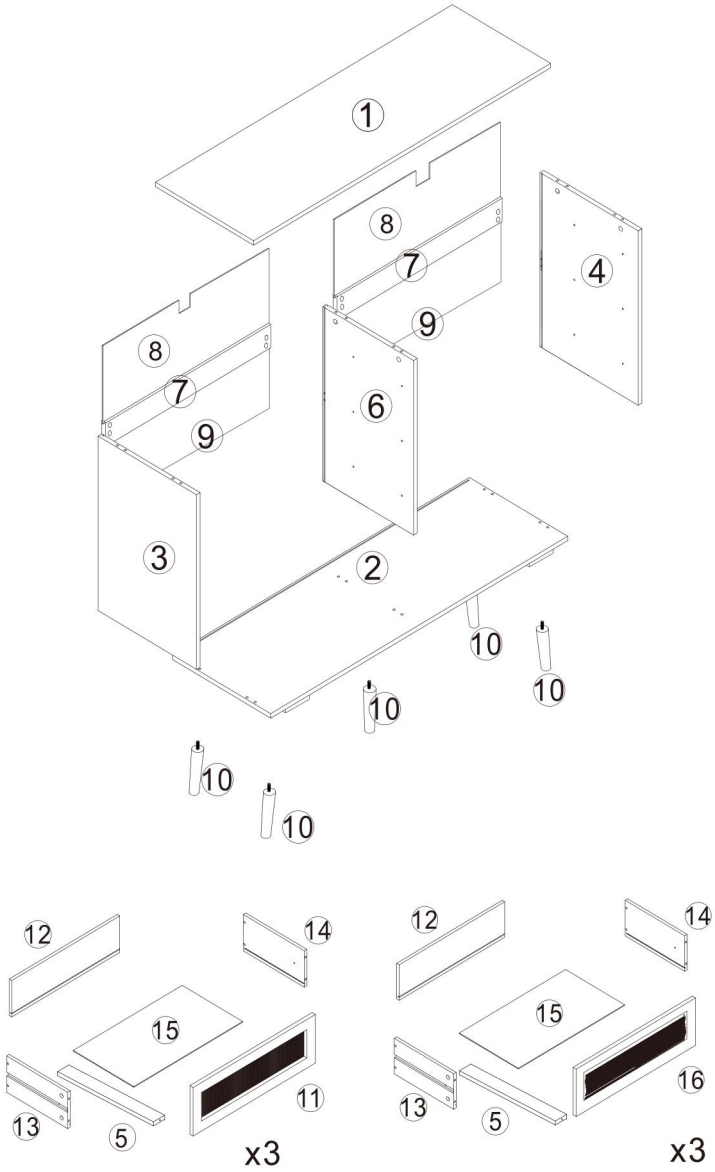







TECHNICAL SPECIFICATIONS

Model	SR191630WT	SR191630BK	SR191630ND
Color	White	Black	Wood
Product Dimensions (LxWxH)(mm)	1100*400*755		
Packing Size(LxWxH)(mm)	1210*485*185		
Net Weight(kg)	About 32.7		
Gross Weight(kg)	About 34.9		

*Products such as specifications, appearance, and design are subject to modification without prior notice.

PACKAGE CONTENTS



ITEM	PART	QTY	ITEM	PART	QTY
A		44 PCS	B		44 PCS
C		12 PCS	D		30 PCS
E		24PCS	F		2 PCS
G		6 PCS	H		2 PCS
I		2 PCS	K		6 PCS
L		2 PCS	M		12 PCS
N		12 PCS	O		16 PCS
P		16 PCS	Q		12 PCS

ASSEMBLY STEPS

step 1

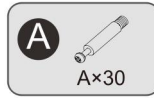

X6

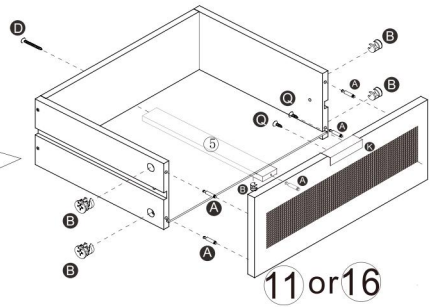
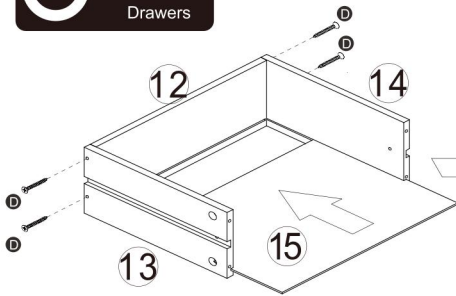

step 2

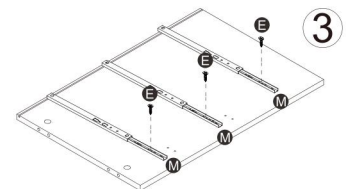
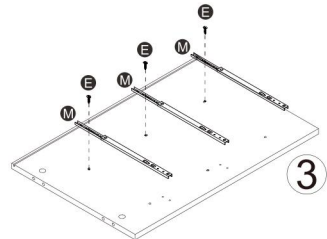
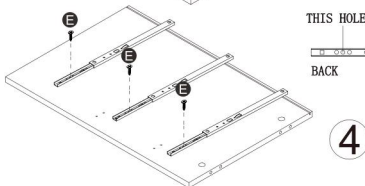
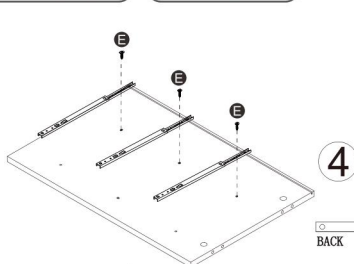

step 3



NOTE: Please pay attention to distinguishing the left and right direction of #6 board. The upper part is the right side to install #6 board, and the lower part is the left side.

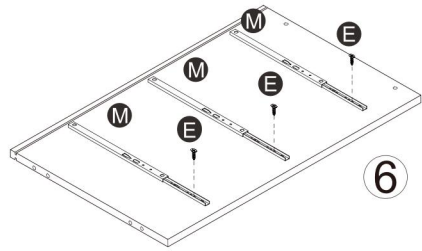
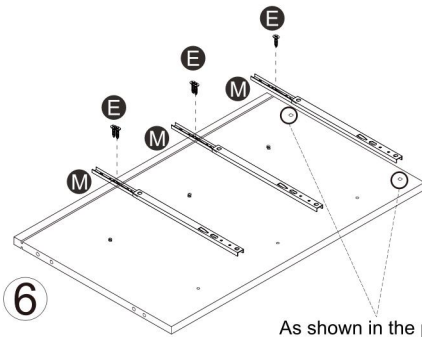
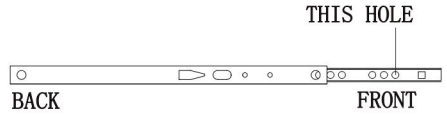

As shown in the picture above, the side of the board with the TWO HOLES is the left side.

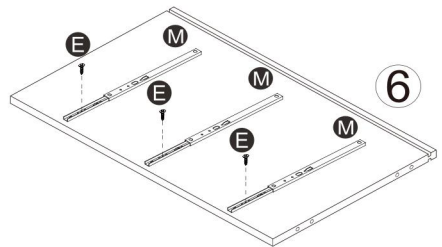
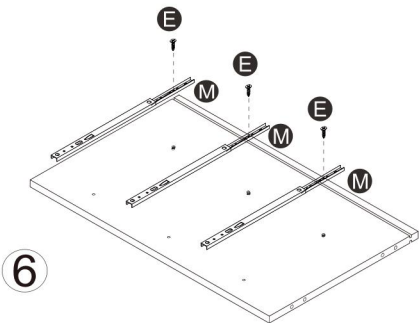
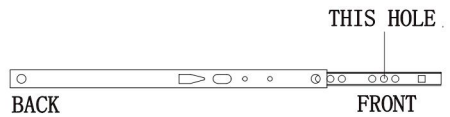

step 4



NOTE: In the next steps 4, 5, and 6, please pay attention to distinguish the direction of the board #3 and #4.

The #3 board is installed on the left side of the dresser, and the #4 board is installed on the right side.

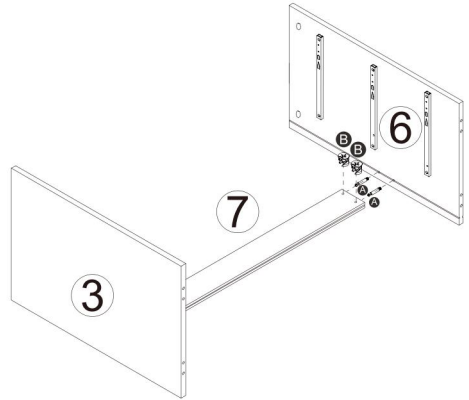
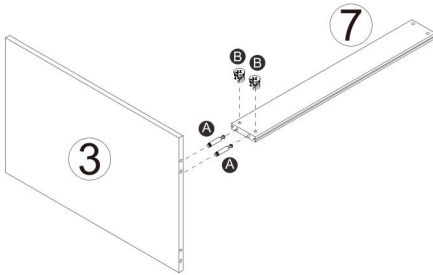

step 5

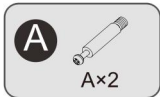

As shown in the picture above, the side of the board with the TWO HOLES is the right side.

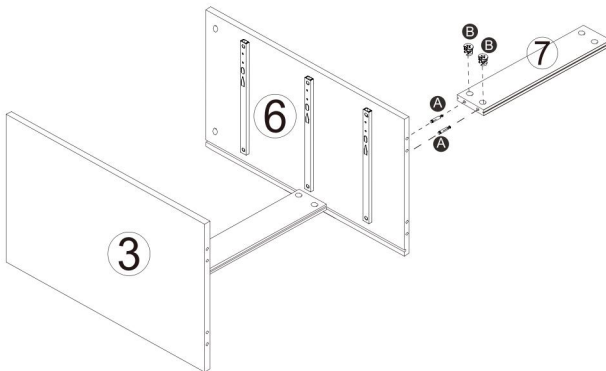

step 6

A



A×2

B



B×2

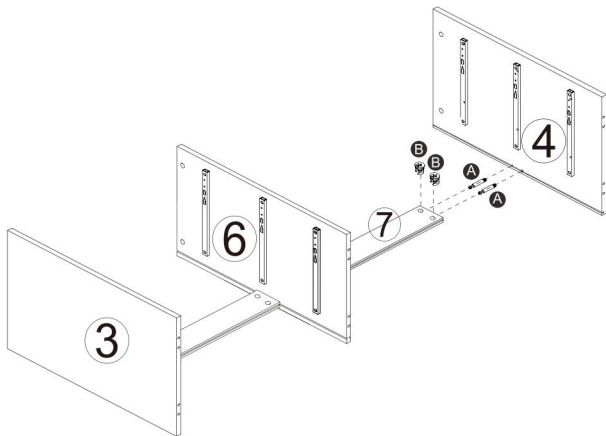

step 7

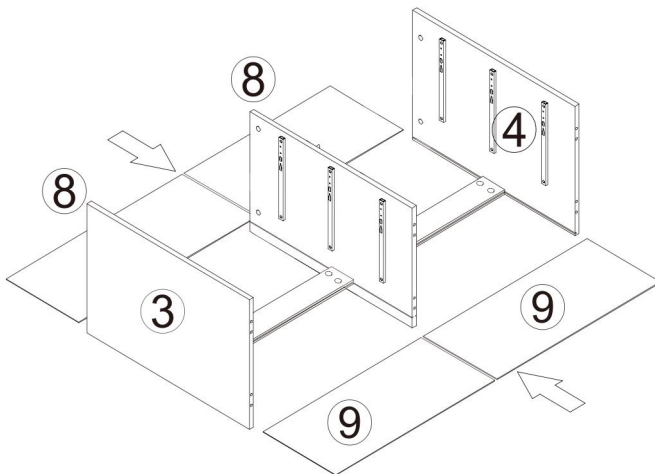

step 8

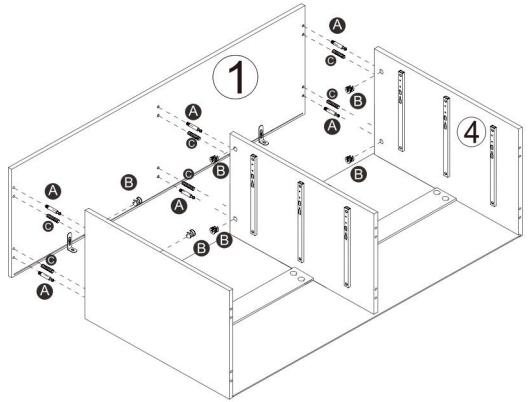
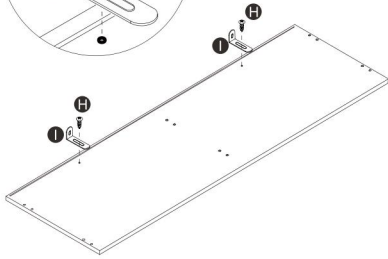
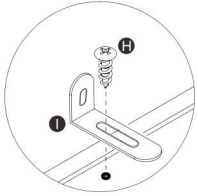
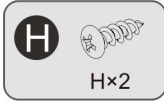

step 9

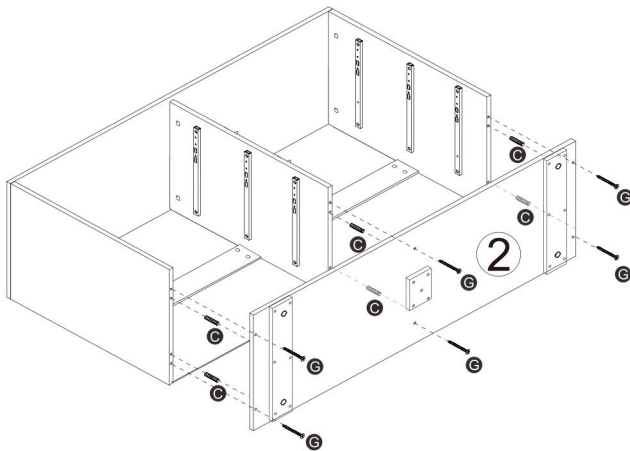

step 10

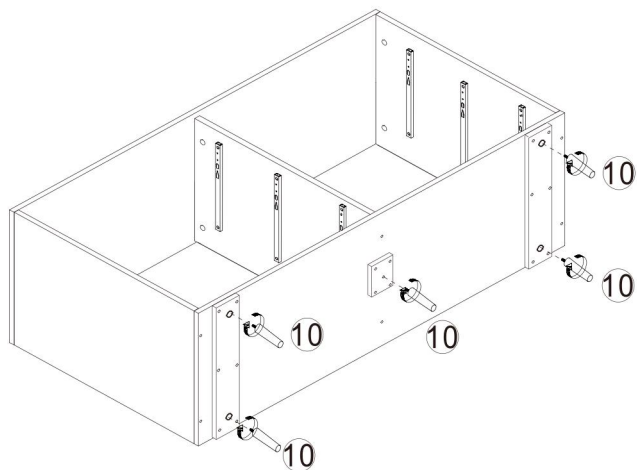

step 11

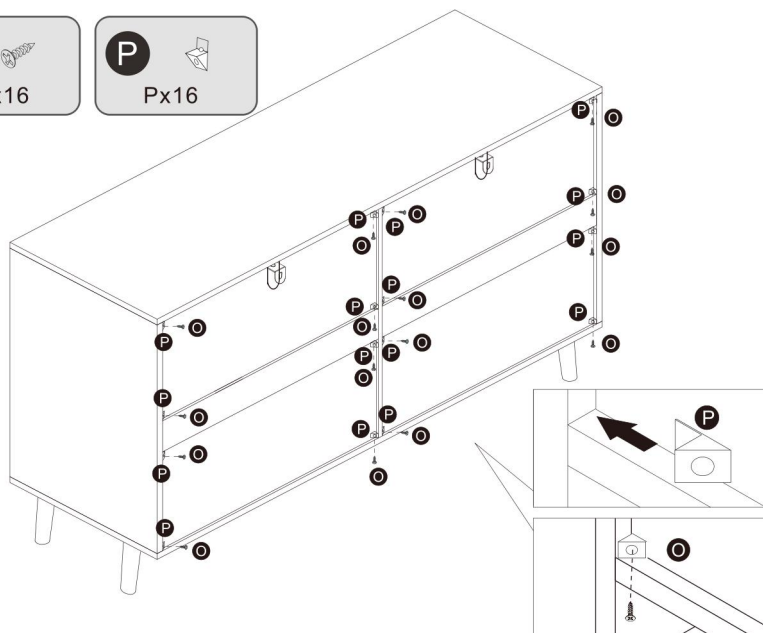

step 12

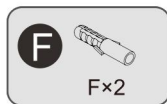

Important Note : Young children can be seriously injured by tipping furniture. You must install the tipping restraint hardware (included) with the unit to prevent the unit from tipping, causing any accidents or damage. The tipping restraints are intended only as a deterrent, they are not substitute for proper adult supervision. The tipping restraints are not earthquake restraints. If you wish to add the extra security of earthquake restraints, they must be purchased and installed separately.

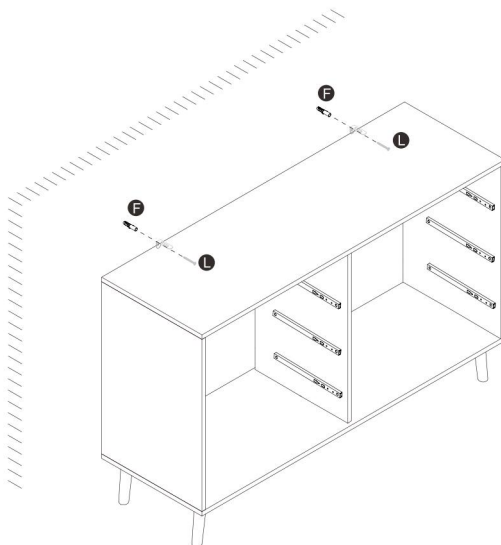

step 13

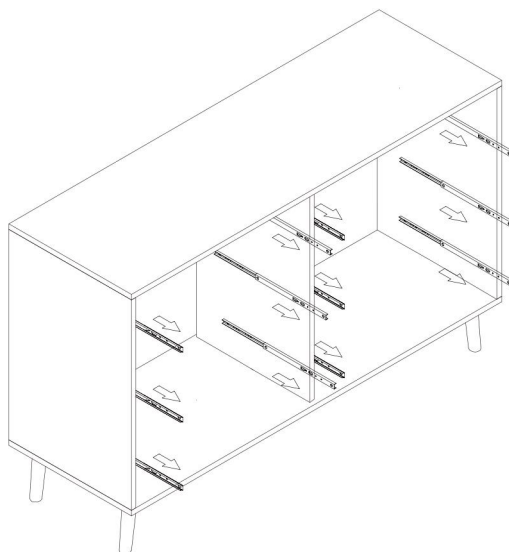

step 14

Note: Please pay attention to distinguishing the left and right directions of the drawer.
The #11 board is on the left side of the drawer, and the #16 board is on the right side.

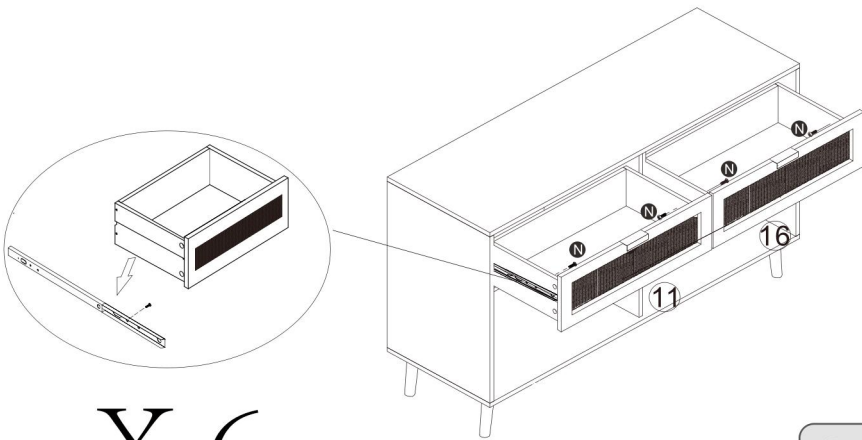

X 6



step 15

Congratulations!!

You have successfully completed the assembly!



COMPLETION



Manufacturer: Shanghaimuxinmuyeyouxiangongsi

Address: Shuangchenglu 803nong11hao1602A-1609shi, baoshanqu, shanghai 200000 CN.

Imported to AUS: SIHAO PTY LTD. 1 ROKEVA STREETEASTWOOD NSW 2122 Australia

Imported to USA: Sanven Technology Ltd. Suite 250, 9166 Anaheim Place, Rancho Cucamonga, CA 91730

EC

REP

E-CrossStu GmbH
Mainzer Landstr.69, 60329 Frankfurt am Main.

UK

REP

YH CONSULTING LIMITED.
C/O YH Consulting Limited Office 147, Centurion House, London Road, Staines-upon-Thames, Surrey, TW18 4AX

VEVOR[®]

TOUGH TOOLS, HALF PRICE

Technical Support and E-Warranty Certificate

www.vevor.com/support

VEVOR[®]

TOUGH TOOLS, HALF PRICE

Technisch Support und E-Garantie-Zertifikat

www.vevor.com/support

RATTAN COUCHTISCH

BENUTZERHANDBUCH

MODELLNR.: SR191630WT, SR191630BK, SR191630ND

We continue to be committed to provide you tools with competitive price.

"Save Half", "Half Price" or any other similar expressions used by us only represents an estimate of savings you might benefit from buying certain tools with us compared to the major top brands and does not necessarily mean to cover all categories of tools offered by us. You are kindly reminded to verify carefully when you are placing an order with us if you are actually saving half in comparison with the top major brands.

VEVOR®

TOUGH TOOLS, HALF PRICE

Rattan Coffee Table

MODELL NR.: SR191630WT, SR191630BK, SR191630ND

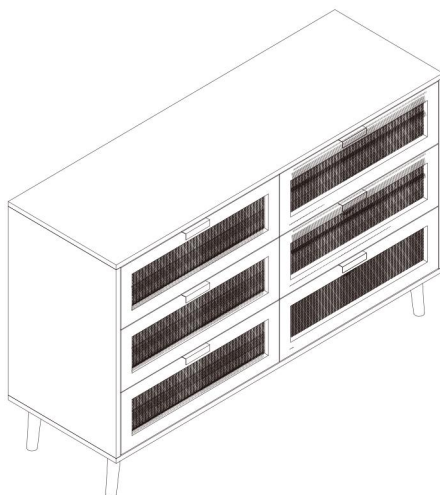

NEED HELP? CONTACT US!

Have product questions? Need technical support? Please feel free to contact us:

Technical Support and E-Warranty Certificate
www.vevor.com/support

This is the original instruction, please read all manual instructions carefully before operating. VEVOR reserves a clear interpretation of our user manual. The appearance of the product shall be subject to the product you received. Please forgive us that we won't inform you again if there are any technology or software updates on our product.

 **WARNUNG:**

Bitte lesen Sie dieses Handbuch vor der Verwendung des Produkts sorgfältig durch. Andernfalls kann es zu schweren Verletzungen kommen.

VORSICHTSMASSNAHMEN BEI DER MONTAGE

9. Führen Sie die Montage nur gemäß dieser Anleitung durch. Eine unsachgemäße Montage kann zu Gefahren führen.
10. Tragen Sie während der Montage eine ANSI-geprüfte Schutzbrille und robuste Arbeitshandschuhe.
11. Halten Sie den Versammlungsbereich sauber und gut beleuchtet.
12. Halten Sie während der Montage unbeteiligte Zuschauer vom Bereich fern.
13. Nicht zusammenbauen, wenn Sie müde sind oder unter Einfluss von Alkohol, Drogen oder Medikamenten stehen.
14. Die Produktfunktionen gelten nur für ordnungsgemäß und vollständig montierte Produkte.
15. Stellen Sie die Montage auf eine flache, ebene, harte und glatte Oberfläche, auf der der Rattan-Couchtisch sicher stehen kann.
16. Weitere Informationen zu den auf den folgenden Seiten aufgeführten Teilen finden Sie im Montagediagramm dieses Handbuchs. Packen Sie alle Teile in einem sauberen Arbeitsbereich aus und trennen Sie sie.

VORSICHTSMASSNAHMEN BEIM GEBRAUCH

UM SCHWERE VERLETZUNGEN UND TOD DURCH KIPPEN ZU VERMEIDEN:

5. Dieses Produkt ist kein Spielzeug. Erlauben Sie Kindern nicht, mit diesem Artikel oder in seiner Nähe zu spielen.
6. Überschreiten Sie vor dem Bewegen nicht die Gewichtskapazität.
7. Verwenden Sie es nur auf einer flachen, harten und glatten Oberfläche, die einen voll beladenen Rattan-Couchtisch sicher tragen kann.
8. Nur bestimmungsgemäß verwenden.
Vor jedem Gebrauch prüfen; nicht verwenden, wenn Teile lose oder beschädigt sind.

TECHNICAL SPECIFICATIONS









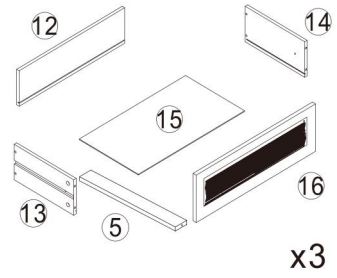
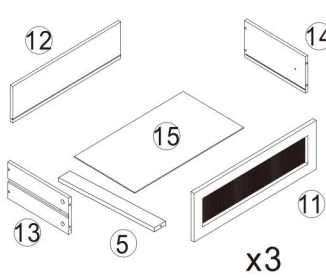
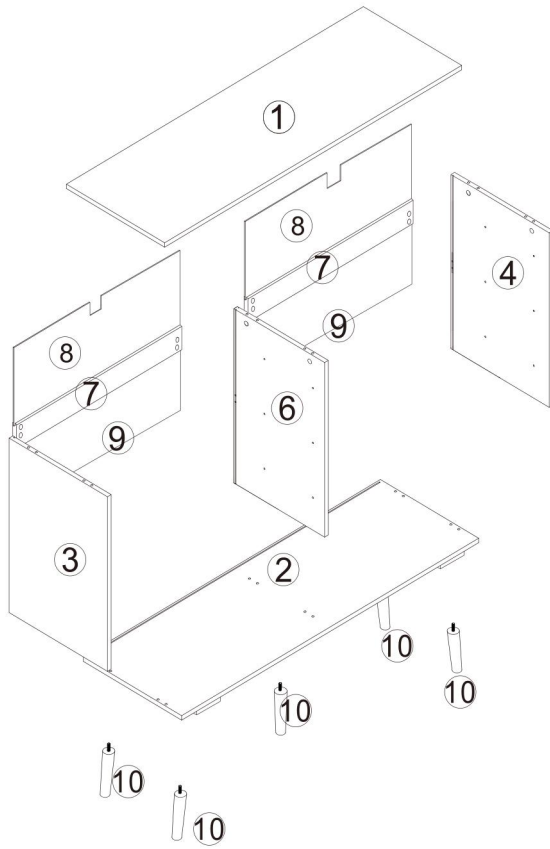







Modell	SR191630WT	SR191630BK	SR191630ND
Farbe	Weiß	Schwarz	Holz
Technische Daten (L x B x H) (mm)	1100*400*755		
Verpackungsgröße (L x B x H) (mm)	1210*485*185		

Nettogewicht / kg)	Etwa 32,7
Bruttogewicht (kg)	Etwa 34,9

*Produkte wie Spezifikationen, Aussehen und Design können ohne vorherige Ankündigung geändert werden.

PACKAGE CONTENTS



ITEM	PART	QTY	ITEM	PART	QTY
A		44 PCS	B		44 PCS
C		12 PCS	D		30 PCS
E		24PCS	F		2 PCS
G		6 PCS	H		2 PCS
I		2 PCS	K		6 PCS
L		2 PCS	M		12 PCS
N		12 PCS	O		16 PCS
P		16 PCS	Q		12 PCS

ASSEMBLY STEPS

step 1

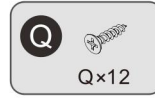
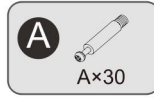

X6

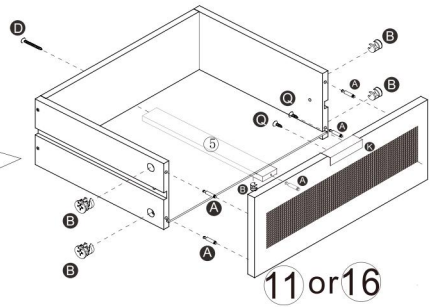
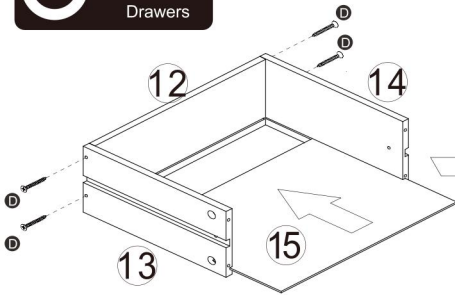

step 2

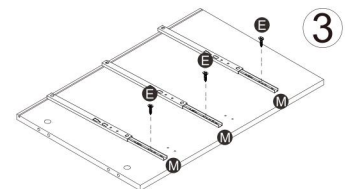
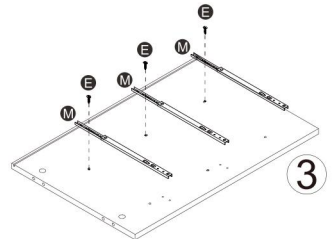
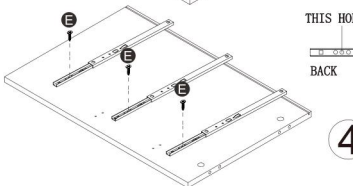
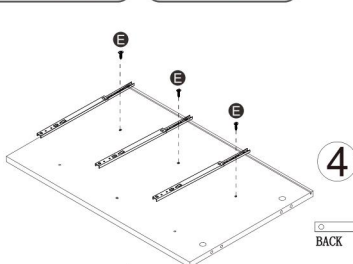

step 3



NOTE: Please pay attention to distinguishing the left and right direction of #6 board. The upper part is the right side to install #6 board, and the lower part is the left side.

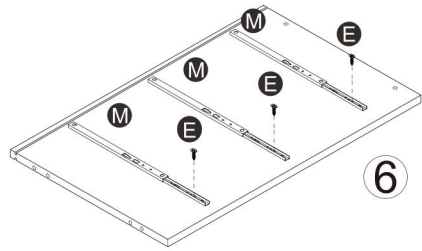
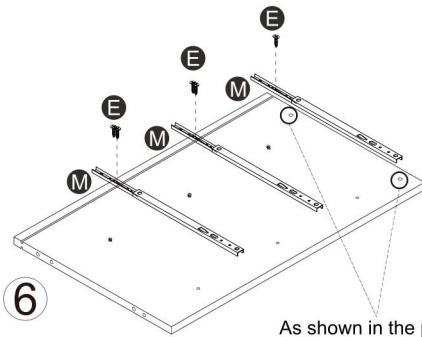
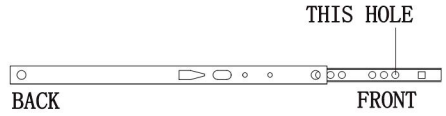

As shown in the picture above, the side of the board with the TWO HOLES is the left side.

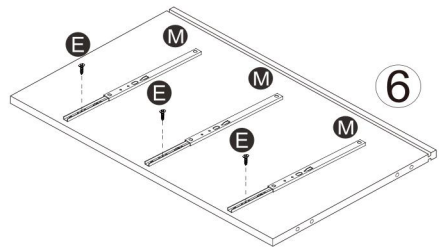
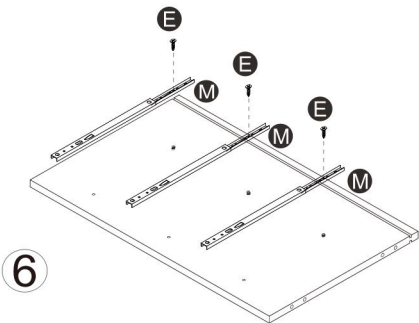
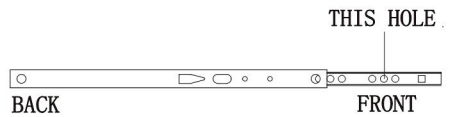

step 4

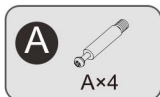

NOTE: In the next steps 4, 5, and 6, please pay attention to distinguish the direction of the board #3 and #4.

The #3 board is installed on the left side of the dresser, and the #4 board is installed on the right side.

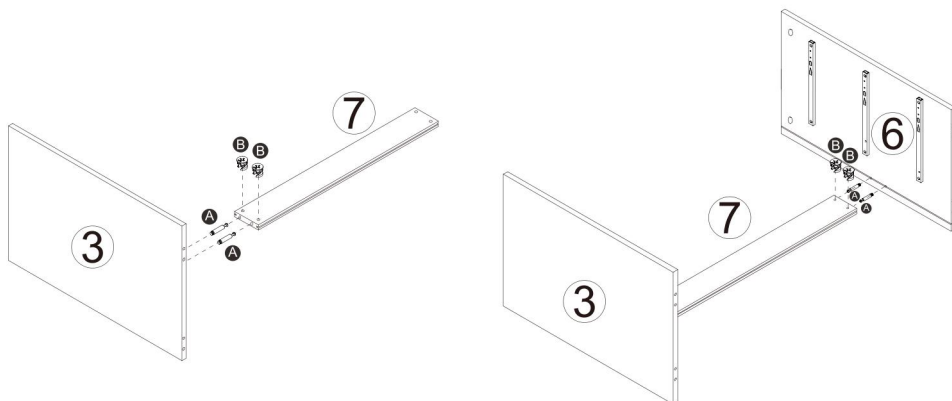

step 5

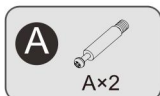

As shown in the picture above, the side of the board with the TWO HOLES is the right side.

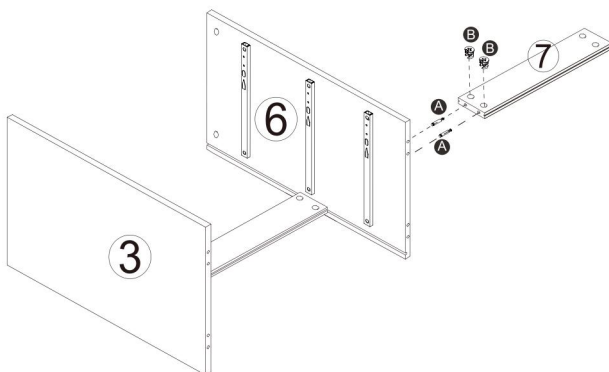

step 6

A



A×2

B



B×2

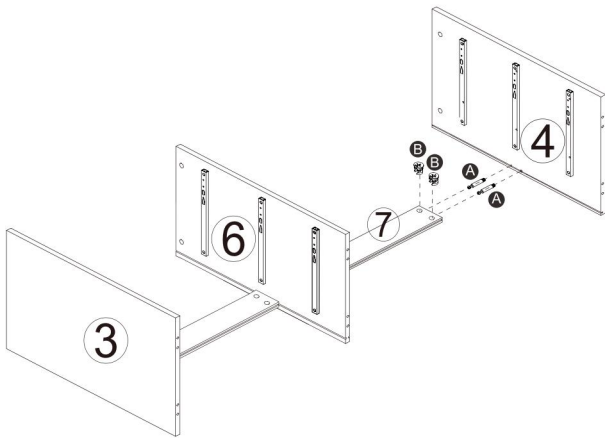

step 7

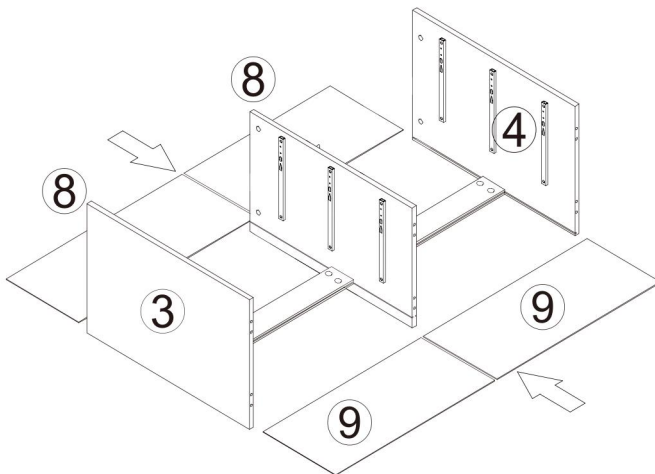

step 8

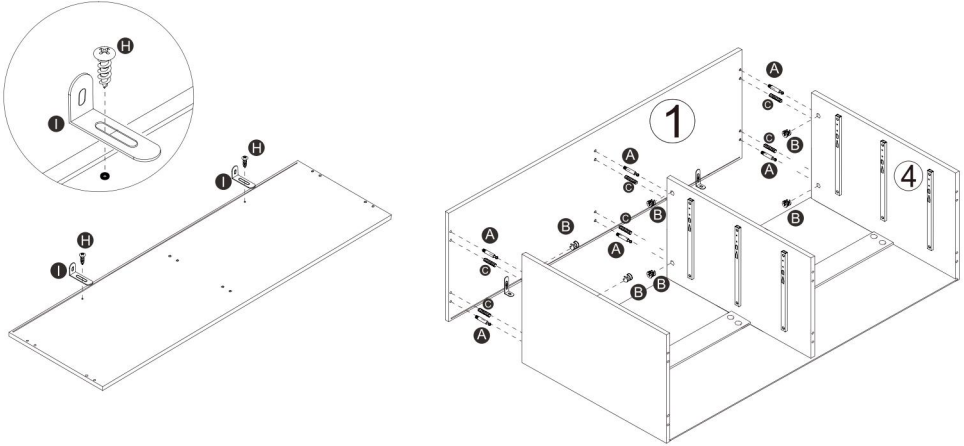
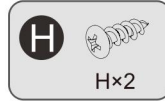

step 9

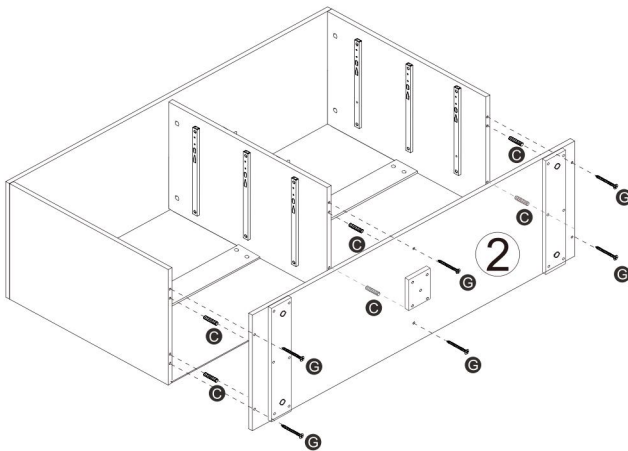

step 10

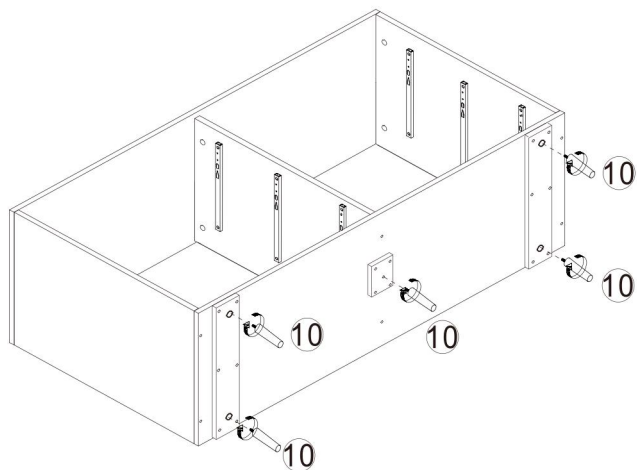

step 11

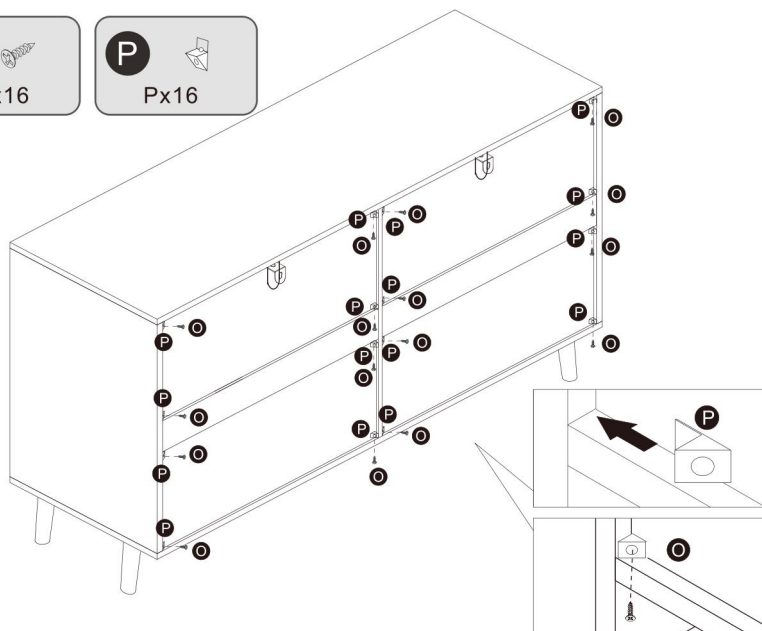

step 12

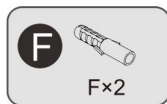

Important Note : Young children can be seriously injured by tipping furniture. You must install the tipping restraint hardware (included) with the unit to prevent the unit from tipping, causing any accidents or damage. The tipping restraints are intended only as a deterrent, they are not substitute for proper adult supervision. The tipping restraints are not earthquake restraints. If you wish to add the extra security of earthquake restraints, they must be purchased and installed separately.

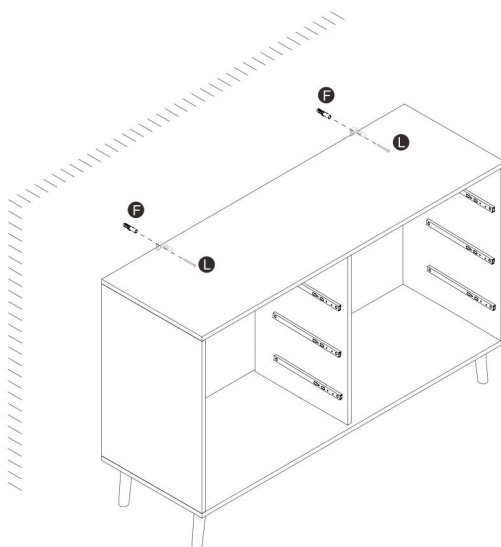

step 13

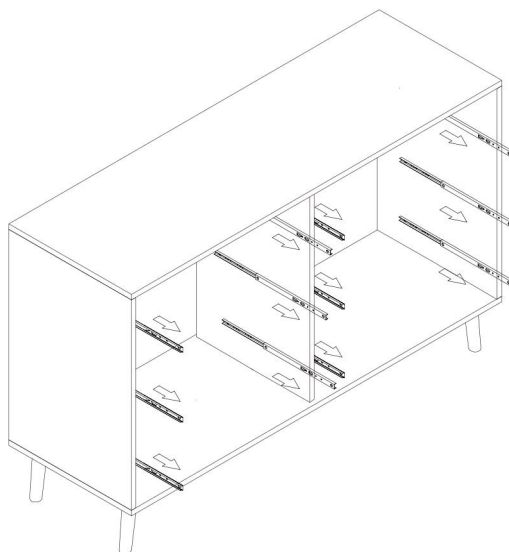

step 14

Note: Please pay attention to distinguishing the left and right directions of the drawer.
The #11 board is on the left side of the drawer, and the #16 board is on the right side.

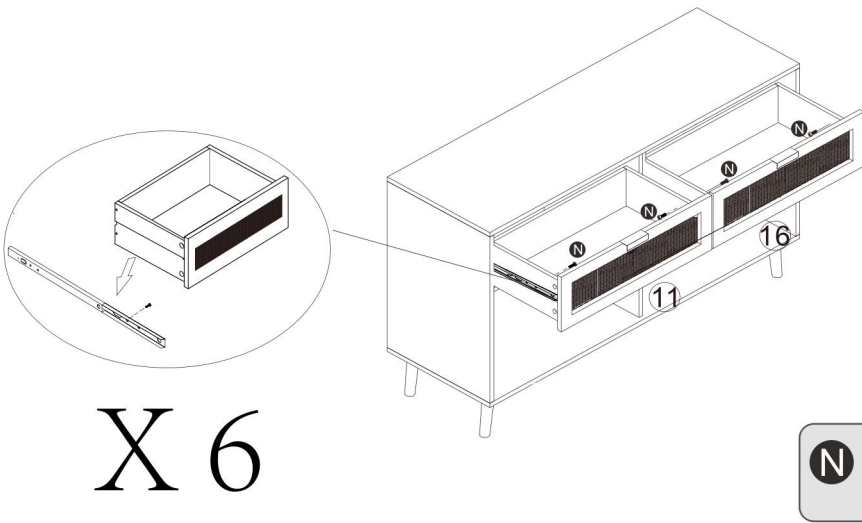

step 15

Congratulations!!

You have successfully completed the assembly!



COMPLETION



Hersteller: Shanghaimuxinmuyeyouxiangongsi

Adresse: Shuangchenglu 803nong11hao1602A-1609shi, Baoshanqu, Shanghai 200000 CN.

Nach AUS importiert: SIHAO PTY LTD. 1 ROKEVA
STREETEASTWOOD NSW 2122 Australien

Importiert in die USA: Sanven Technology Ltd. Suite 250, 9166 Anaheim
Place, Rancho Cucamonga, CA 91730

EC

REP

E-CrossStu GmbH
Mainzer Landstr.69, 60329 Frankfurt am Main.

UK

REP

YH CONSULTING LIMITED.
C/O YH Consulting Limited Office 147, Centurion
House, London Road, Staines-upon-Thames, Surrey,
TW18 4AX

VEVOR[®]

TOUGH TOOLS, HALF PRICE

Technisch Support und E-Garantie-Zertifikat

www.vevor.com/support

VEVOR[®]

TOUGH TOOLS, HALF PRICE

Tecnico Supporto e certificato di garanzia elettronica
www.vevor.com/support

TAVOLINO DA CAFFÈ IN RATTAN

MANUALE D' USO

MODELLO N.: SR191630WT, SR191630BK, SR191630ND

We continue to be committed to provide you tools with competitive price.

"Save Half", "Half Price" or any other similar expressions used by us only represents an estimate of savings you might benefit from buying certain tools with us compared to the major top brands and does not necessarily mean to cover all categories of tools offered by us. You are kindly reminded to verify carefully when you are placing an order with us if you are actually saving half in comparison with the top major brands.

VEVOR®

TOUGH TOOLS, HALF PRICE

Rattan Coffee Table

MODELLO NUMERO.: SR191630WT, SR191630BK, SR191630ND

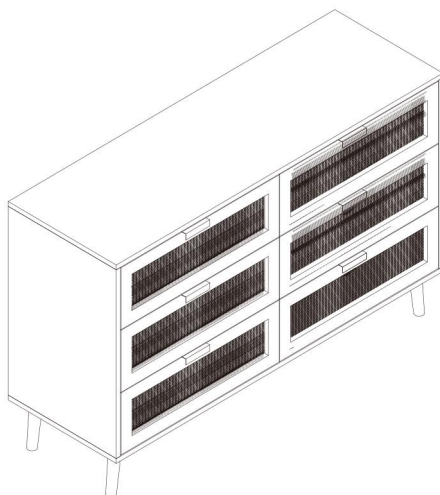

NEED HELP? CONTACT US!

Have product questions? Need technical support? Please feel free to contact us:

Technical Support and E-Warranty Certificate
www.vevor.com/support

This is the original instruction, please read all manual instructions carefully before operating. VEVOR reserves a clear interpretation of our user manual. The appearance of the product shall be subject to the product you received. Please forgive us that we won't inform you again if there are any technology or software updates on our product.

 **AVVERTIMENTO:**

Si prega di leggere attentamente questo manuale prima di utilizzare il prodotto. In caso contrario, si potrebbero causare lesioni gravi.

PRECAUZIONI DI MONTAGGIO

17. Assemblare solo secondo queste istruzioni. Un montaggio improprio può creare pericoli.
18. Indossare occhiali di sicurezza approvati ANSI e guanti da lavoro pesanti durante il montaggio.
19. Mantenere l'area di assemblaggio pulita e ben illuminata.
20. Tenere gli astanti lontani dall'area durante il montaggio.
21. Non montare in caso di stanchezza o sotto l'effetto di alcol, droghe o farmaci.
22. Le funzionalità del prodotto si applicano solo ai prodotti correttamente e completamente assemblati.
23. Montare su una superficie piana, livellata, dura e liscia in grado di sostenere in modo sicuro il tavolino in rattan.
24. Per ulteriori informazioni riguardanti le parti elencate nelle pagine seguenti, fare riferimento allo Schema di Montaggio di questo manuale. Scartare e separare tutte le parti in un'area di lavoro pulita.

CONSERVARE QUESTE ISTRUZIONI

USARE LE PRECAUZIONI

PER PREVENIRE LESIONI GRAVI E MORTE DOVUTE AL RIBALTAMENTO:

9. Questo prodotto non è un giocattolo. Non permettere ai bambini di giocare con o vicino a questo articolo.

10. Non superare le capacità di peso, prima dello spostamento.

11. Utilizzare solo su una superficie piana, dura e liscia in grado di sostenere in modo sicuro un tavolino da caffè in rattan completamente carico.

12. Utilizzare solo come previsto.

Ispezionare prima di ogni utilizzo; non utilizzare se le parti sono allentate o danneggiate.

TECHNICAL SPECIFICATIONS









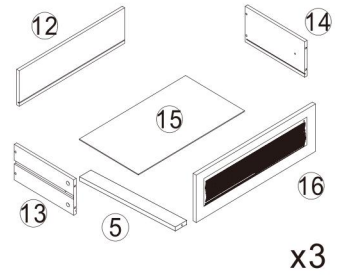
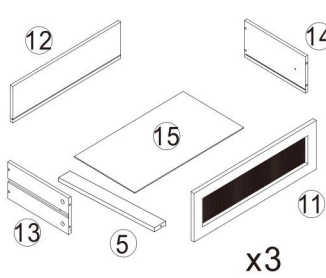
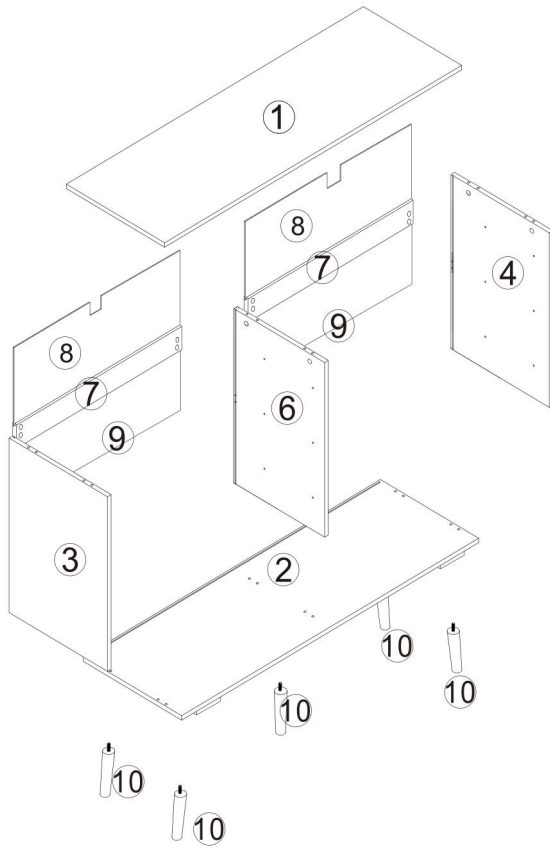







Modello	SR191630WT	SR191630BK	SR191630ND
Colore	Bianco	Nero	Legna
Dimensioni del prodotto (LxLxA)(mm)	1100*400*755		
Dimensioni imballo (LxLxA) (mm)	1210*485*185		
Peso netto (chilogrammo)	Circa 32,7		

Peso lordo (chilogrammo)	Circa 34,9
-----------------------------	------------

*Prodotti quali specifiche, aspetto e design sono soggetti a modifiche senza preavviso.

PACKAGE CONTENTS



ITEM	PART	QTY	ITEM	PART	QTY
A		44 PCS	B		44 PCS
C		12 PCS	D		30 PCS
E		24PCS	F		2 PCS
G		6 PCS	H		2 PCS
I		2 PCS	K		6 PCS
L		2 PCS	M		12 PCS
N		12 PCS	O		16 PCS
P		16 PCS	Q		12 PCS

ASSEMBLY STEPS

step 1

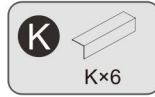
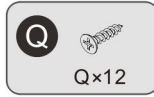
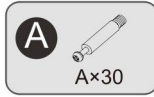

X6

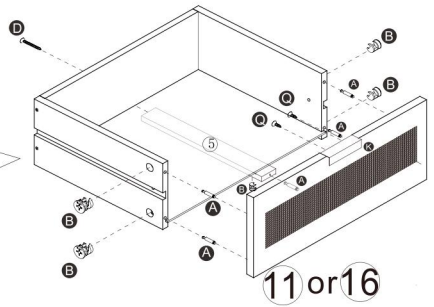
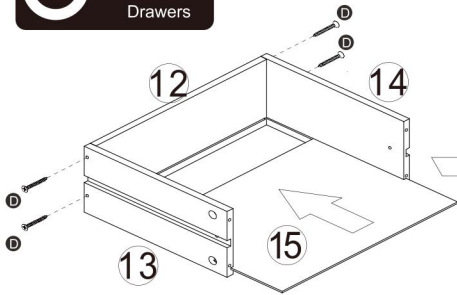

step 2

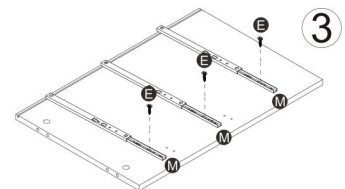
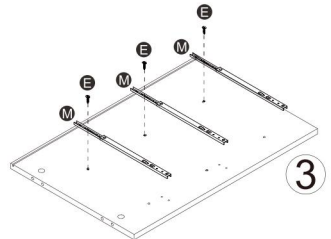
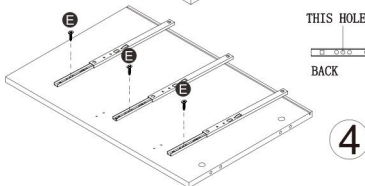
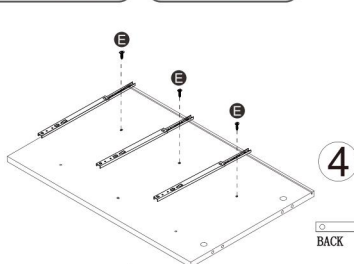

step 3



NOTE: Please pay attention to distinguishing the left and right direction of #6 board. The upper part is the right side to install #6 board, and the lower part is the left side.

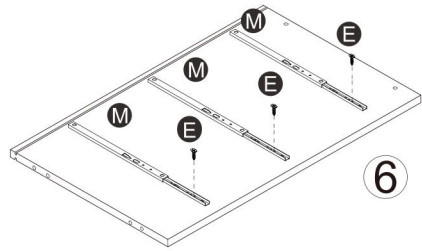
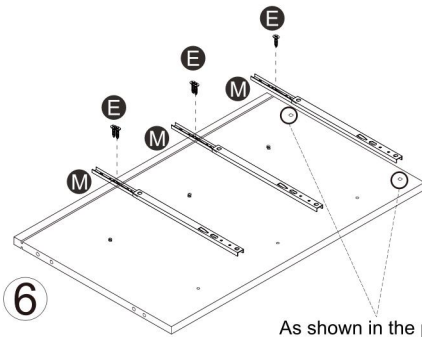
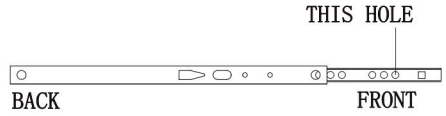

As shown in the picture above, the side of the board with the TWO HOLES is the left side.

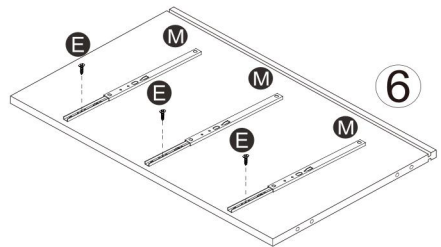
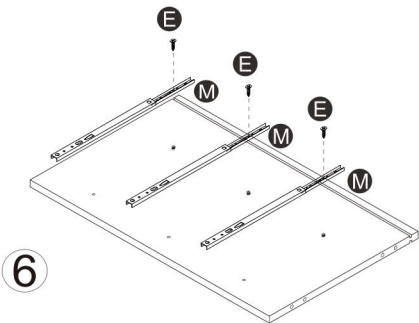
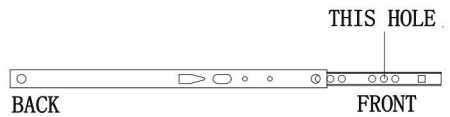

step 4

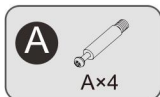

NOTE: In the next steps 4, 5, and 6, please pay attention to distinguish the direction of the board #3 and #4.

The #3 board is installed on the left side of the dresser, and the #4 board is installed on the right side.

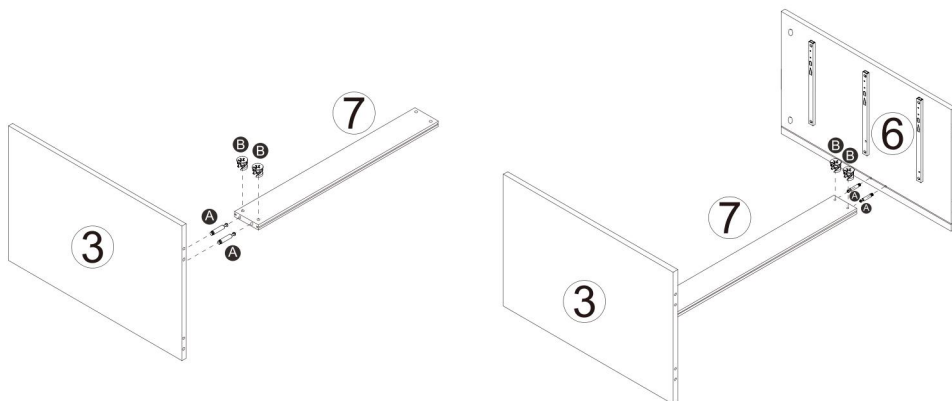

step 5

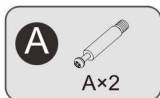

As shown in the picture above, the side of the board with the TWO HOLES is the right side.

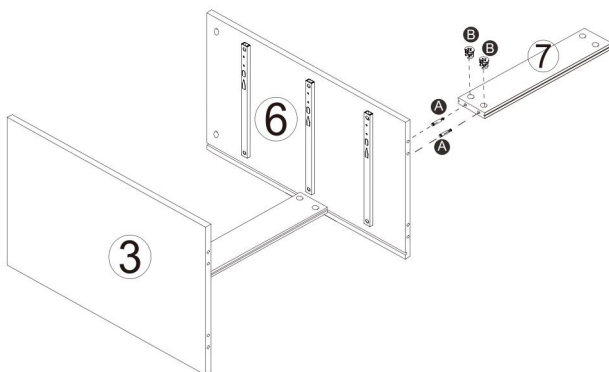

step 6

A



A×2

B



B×2

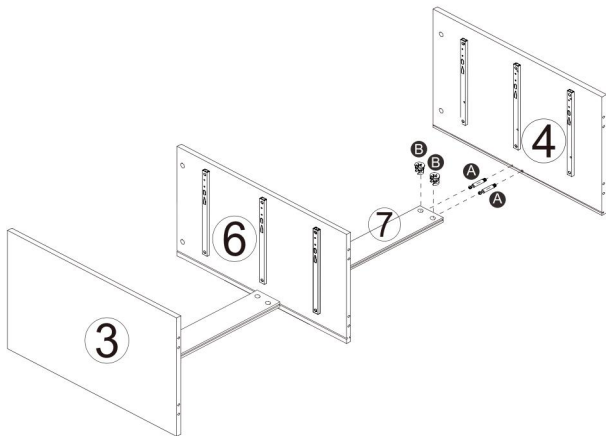

step 7

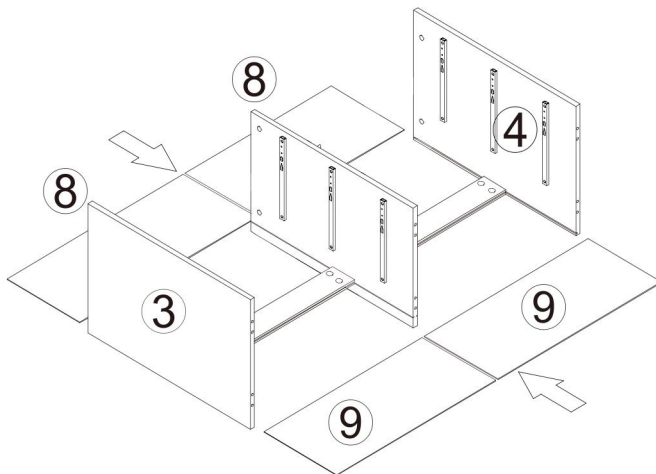

step 8

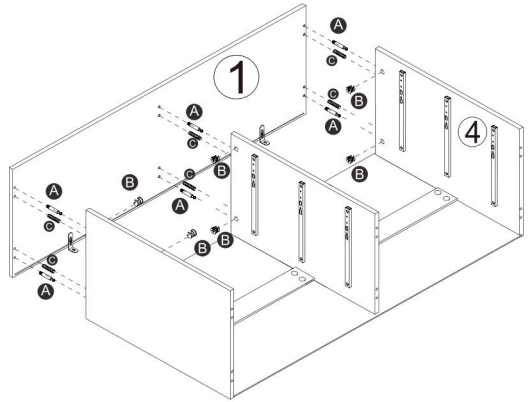
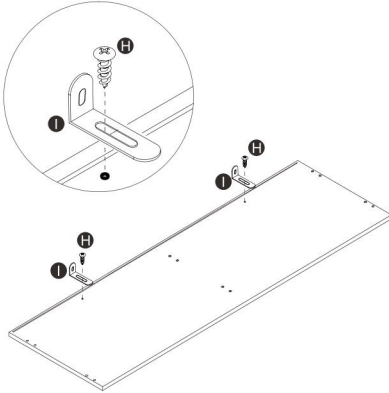
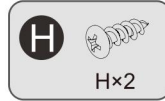

step 9

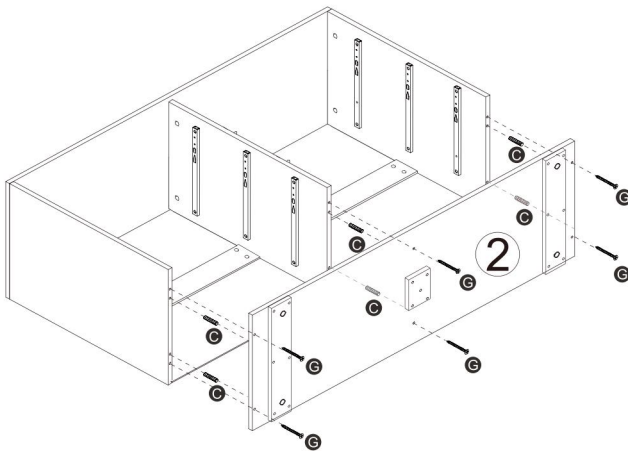

step 10

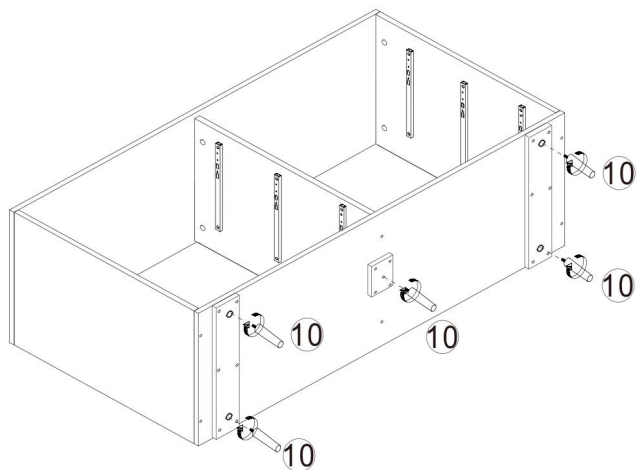

step 11

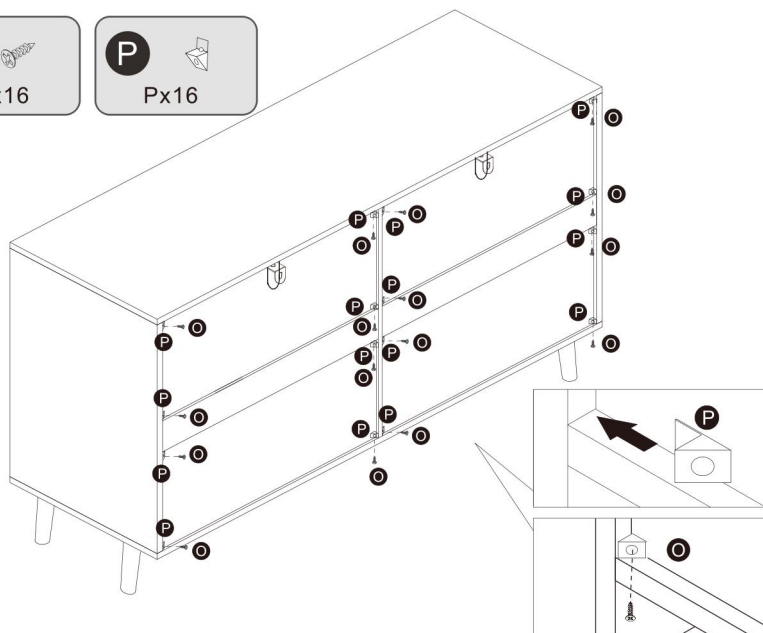

step 12

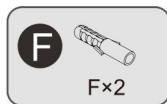

Important Note : Young children can be seriously injured by tipping furniture. You must install the tipping restraint hardware (included) with the unit to prevent the unit from tipping, causing any accidents or damage. The tipping restraints are intended only as a deterrent, they are not substitute for proper adult supervision. The tipping restraints are not earthquake restraints. If you wish to add the extra security of earthquake restraints, they must be purchased and installed separately.

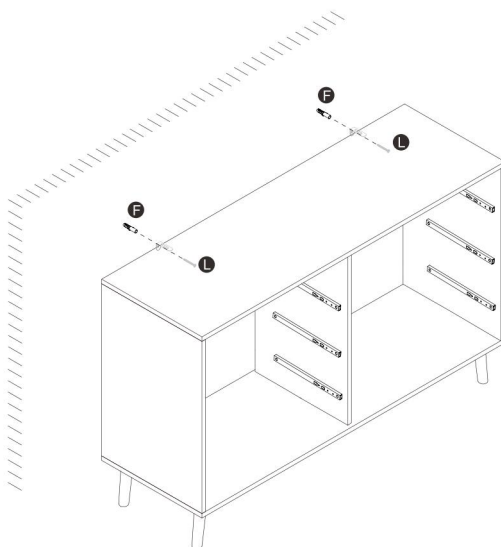

step 13

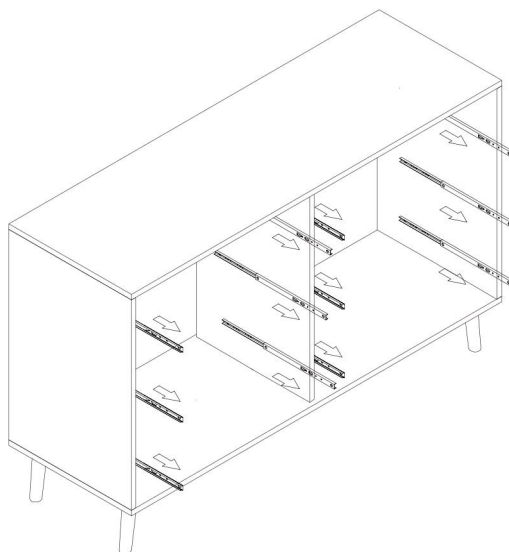

step 14

Note: Please pay attention to distinguishing the left and right directions of the drawer.
The #11 board is on the left side of the drawer, and the #16 board is on the right side.

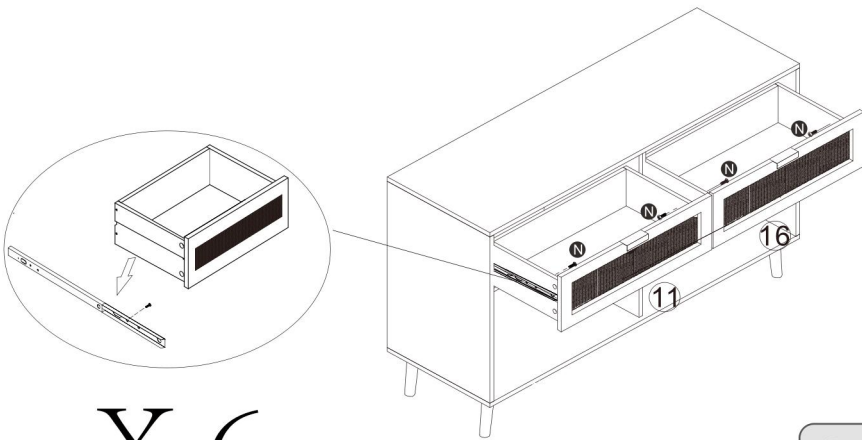

X 6



step 15

Congratulations!!

You have successfully completed the assembly!



COMPLETION



Produttore: Shanghaimuxinmuyeyouxiangongsi

Indirizzo: Shuangchenglu 803nong11hao1602A-1609shi, baoshanqu, shanghai 200000 CN.

Importato in AUS: SIHAO PTY LTD. 1 ROKEVA STREETEASTWOOD NSW 2122 Australia

Importato negli Stati Uniti: Sanven Technology Ltd. Suite 250, 9166 Anaheim Place, Rancho Cucamonga, CA 91730

EC

REP

E-CrossStu GmbH
Mainzer Landstr.69, 60329 Frankfurt am Main.

UK

REP

YH CONSULTING LIMITED.
C/O YH Consulting Limited Office 147, Centurion House, London Road, Staines-upon-Thames, Surrey, TW18 4AX

VEVOR[®]

TOUGH TOOLS, HALF PRICE

Tecnico Supporto e certificato di garanzia elettronica

www.vevor.com/support

VEVOR[®]

TOUGH TOOLS, HALF PRICE

Técnico Certificado de soporte y garantía electrónica
www.vevor.com/support

MESA DE CENTRO DE RATÁN

MANUAL DE USUARIO

N.º DE MODELO: SR191630WT, SR191630BK, SR191630ND

We continue to be committed to provide you tools with competitive price.

"Save Half", "Half Price" or any other similar expressions used by us only represents an estimate of savings you might benefit from buying certain tools with us compared to the major top brands and does not necessarily mean to cover all categories of tools offered by us. You are kindly reminded to verify carefully when you are placing an order with us if you are actually saving half in comparison with the top major brands.

VEVOR®

TOUGH TOOLS, HALF PRICE

Rattan Coffee Table

N ° DE MODELO.: SR191630WT, SR191630BK, SR191630ND

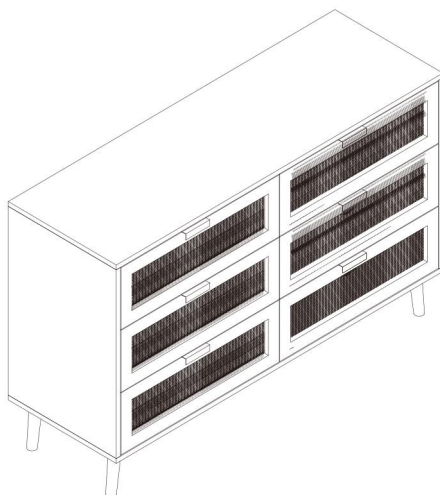

NEED HELP? CONTACT US!

Have product questions? Need technical support? Please feel free to contact us:

Technical Support and E-Warranty Certificate
www.vevor.com/support

This is the original instruction, please read all manual instructions carefully before operating. VEVOR reserves a clear interpretation of our user manual. The appearance of the product shall be subject to the product you received. Please forgive us that we won't inform you again if there are any technology or software updates on our product.

 **ADVERTENCIA:**

Lea atentamente este manual antes de utilizar el producto. De lo contrario, podrían producirse lesiones graves.

PRECAUCIONES DE MONTAJE

25. Ensamble únicamente de acuerdo con estas instrucciones. Un montaje inadecuado puede crear peligros.
26. Use gafas de seguridad aprobadas por ANSI y guantes de trabajo resistentes durante el montaje.
27. Mantenga el área de reunión limpia y bien iluminada.
28. Mantenga a los transeúntes fuera del área durante el montaje.
29. No se reúna cuando esté cansado o bajo la influencia de alcohol, drogas o medicamentos.
30. Las capacidades del producto se aplican únicamente a productos ensamblados de manera adecuada y completa.
31. Ensamble sobre una superficie plana, nivelada, dura y lisa capaz de soportar de manera segura la mesa de centro de ratán.
32. Para obtener información adicional sobre las piezas enumeradas en las siguientes páginas, consulte el diagrama de montaje de este manual. Desenvuelva y separe todas las piezas en un área de trabajo limpia.

GUARDA ESTAS INSTRUCCIONES

PRECAUCIONES DE USO

PARA EVITAR LESIONES GRAVES Y LA MUERTE POR VUELCO:

13. Este producto no es un juguete. No permita que los niños jueguen con este artículo o cerca de él.
14. No exceda las capacidades de peso antes de moverse.
15. Úselo únicamente sobre una superficie plana, dura y lisa capaz de soportar de manera segura una mesa de centro de ratán completamente cargada.
16. Úselo únicamente según lo previsto.
Inspeccionar antes de cada uso; no lo utilice si las piezas están sueltas o dañadas.









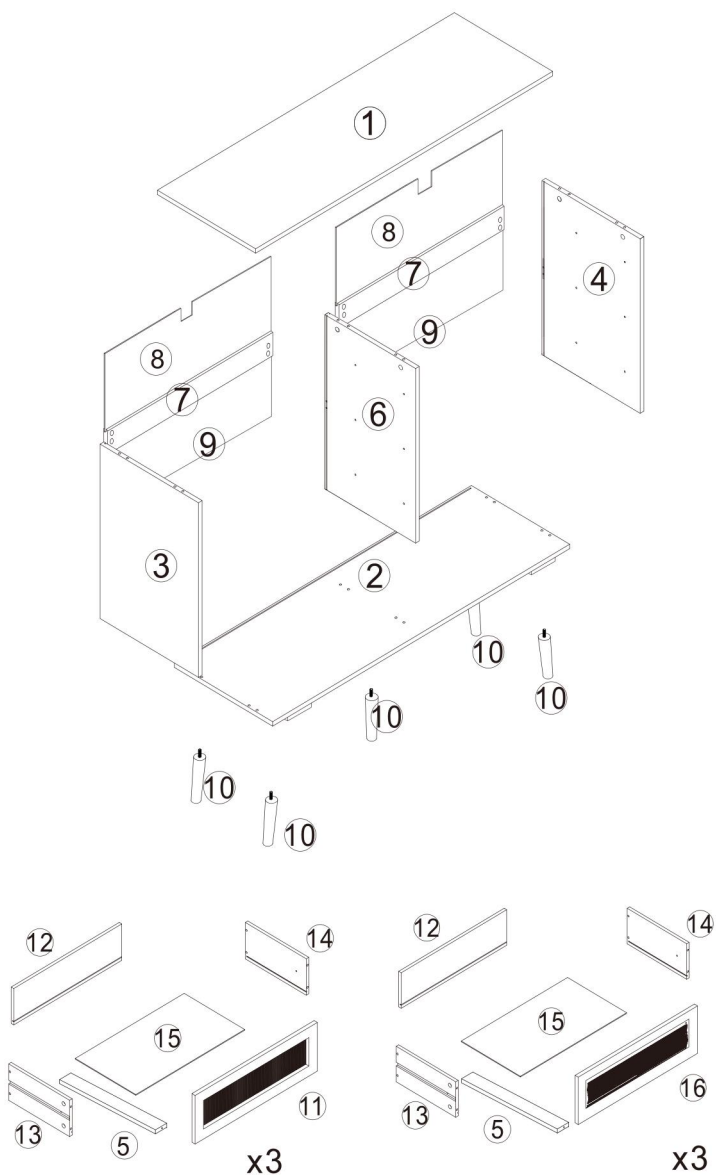







TECHNICAL SPECIFICATIONS

Modelo	SR191630WT	SR191630BK	SR191630ND
Color	Blanco	Negro	Madera
Dimensiones del producto (LxAnxAl)(mm)	1100*400*755		
Tamaño del embalaje (largo x ancho x alto) (mm)	1210*485*185		
Peso neto / kg)	Alrededor de 32,7		
Peso bruto (kg)	Alrededor de 34,9		

*Productos como especificaciones, apariencia y diseño están sujetos a modificaciones sin previo aviso.

PACKAGE CONTENTS



ITEM	PART	QTY	ITEM	PART	QTY
A		44 PCS	B		44 PCS
C		12 PCS	D		30 PCS
E		24PCS	F		2 PCS
G		6 PCS	H		2 PCS
I		2 PCS	K		6 PCS
L		2 PCS	M		12 PCS
N		12 PCS	O		16 PCS
P		16 PCS	Q		12 PCS

ASSEMBLY STEPS

step 1

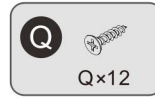
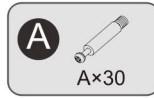

X6

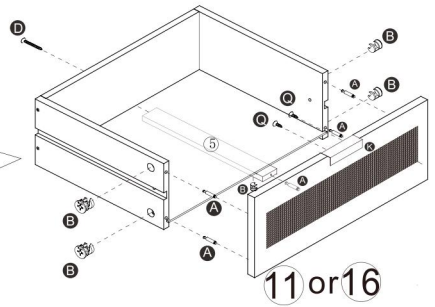
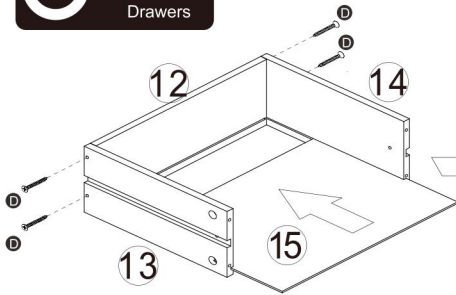

step 2

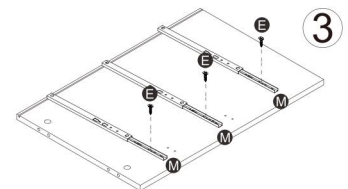
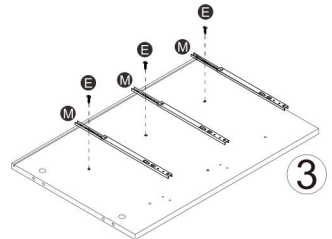
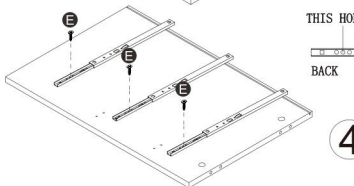
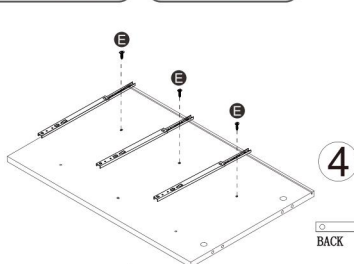

step 3

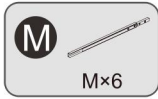

NOTE: Please pay attention to distinguishing the left and right direction of #6 board. The upper part is the right side to install #6 board, and the lower part is the left side.

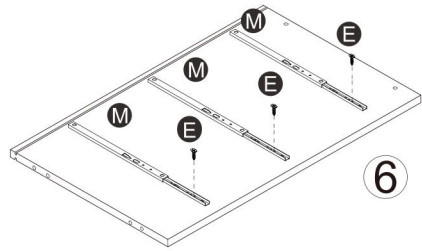
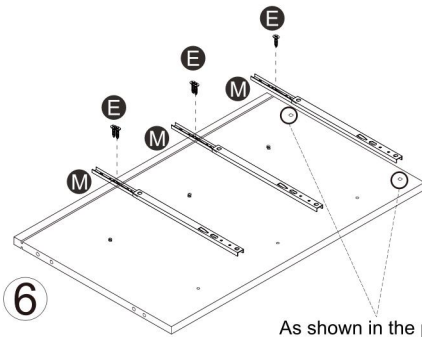
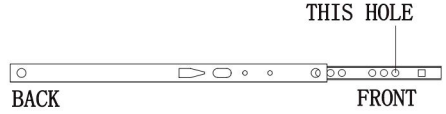

As shown in the picture above, the side of the board with the TWO HOLES is the left side.

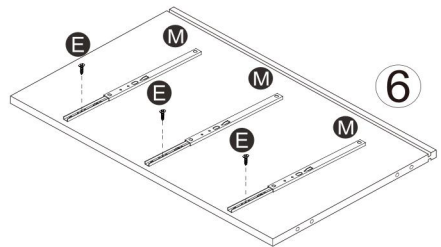
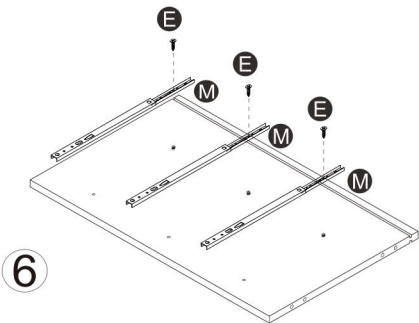
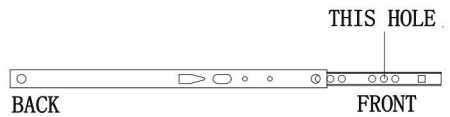

step 4

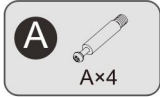

NOTE: In the next steps 4, 5, and 6, please pay attention to distinguish the direction of the board #3 and #4.

The #3 board is installed on the left side of the dresser, and the #4 board is installed on the right side.

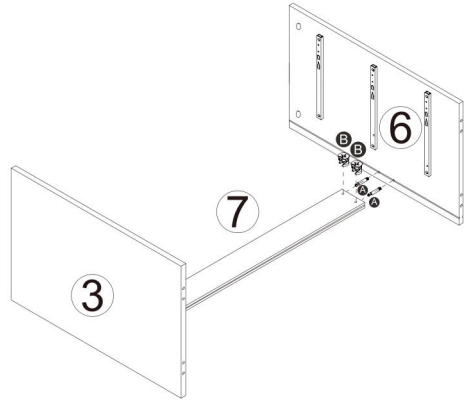
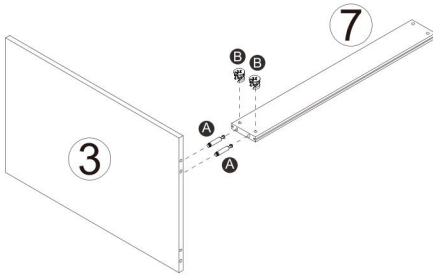

step 5

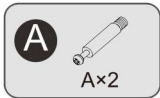

As shown in the picture above, the side of the board with the TWO HOLES is the right side.

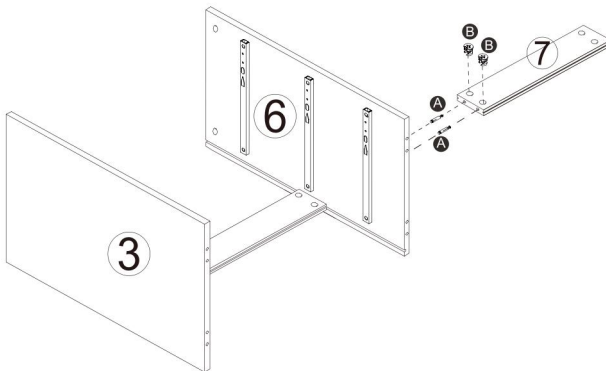

step 6

A



A×2

B



B×2

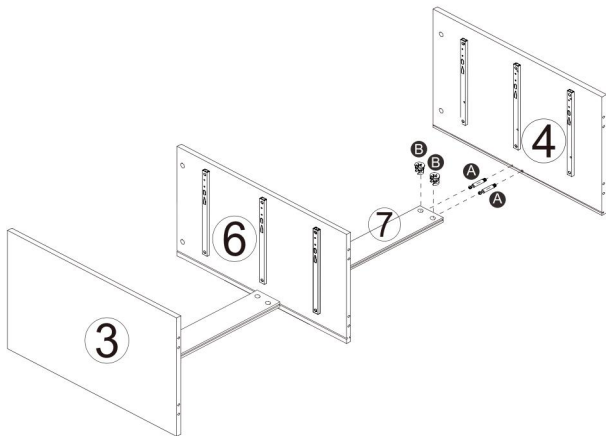

step 7

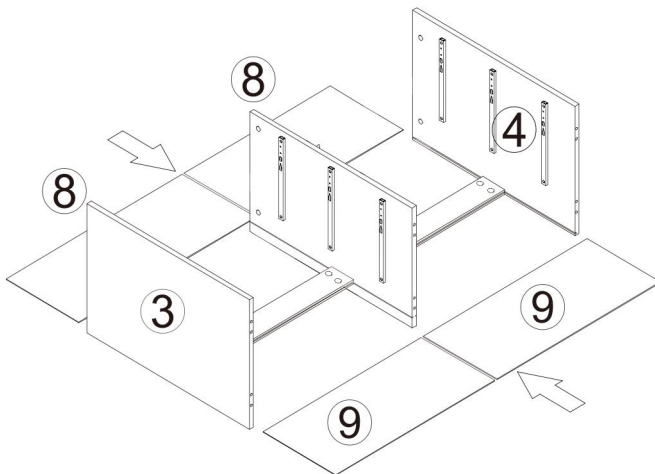

step 8

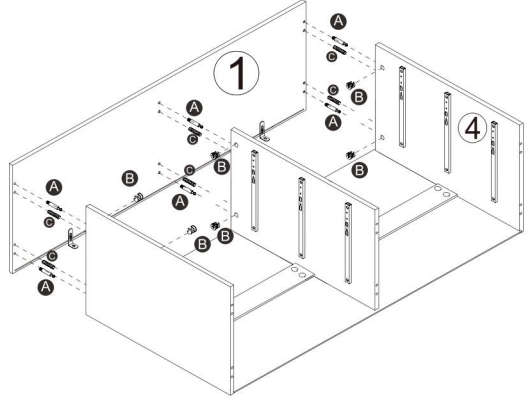
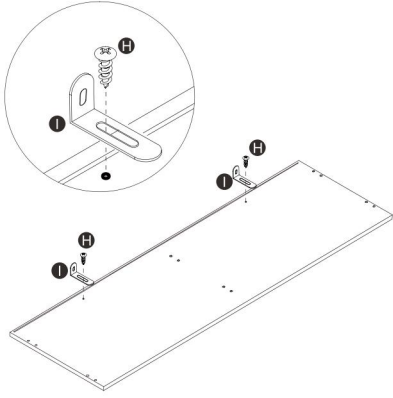
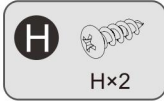

step 9

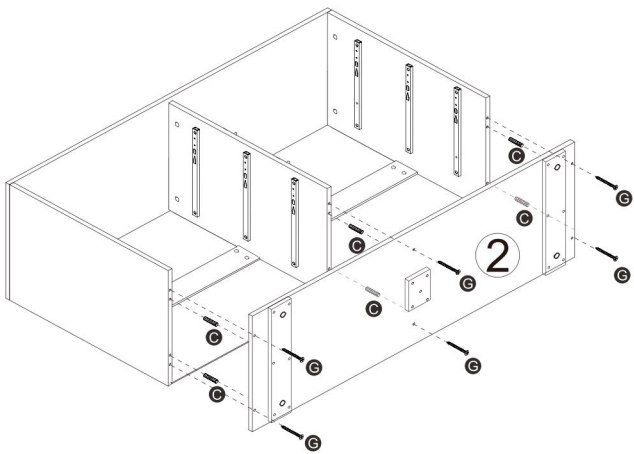

step 10

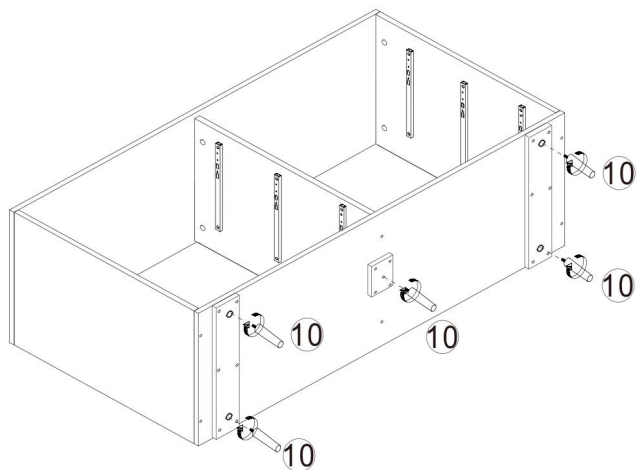

step 11

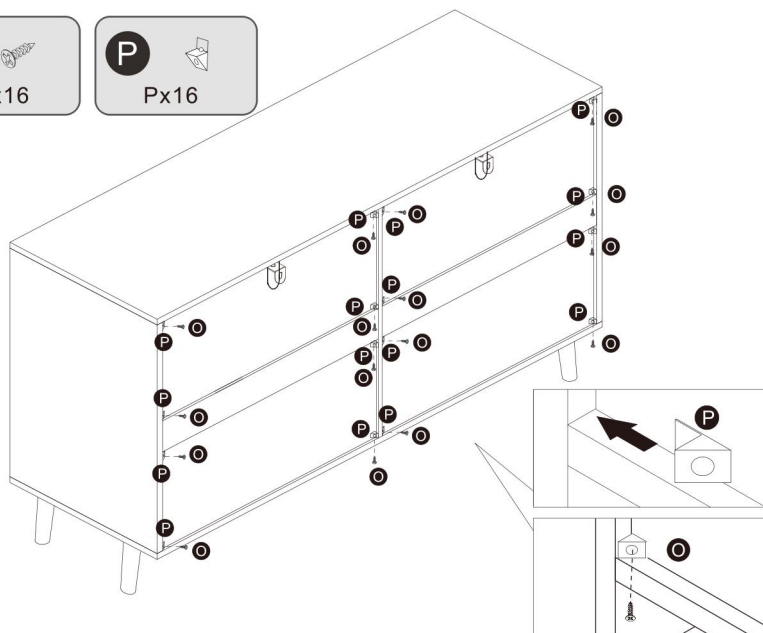

step 12

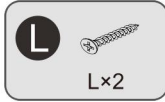
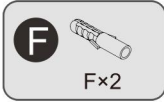

Important Note : Young children can be seriously injured by tipping furniture. You must install the tipping restraint hardware (included) with the unit to prevent the unit from tipping, causing any accidents or damage. The tipping restraints are intended only as a deterrent, they are not substitute for proper adult supervision. The tipping restraints are not earthquake restraints. If you wish to add the extra security of earthquake restraints, they must be purchased and installed separately.

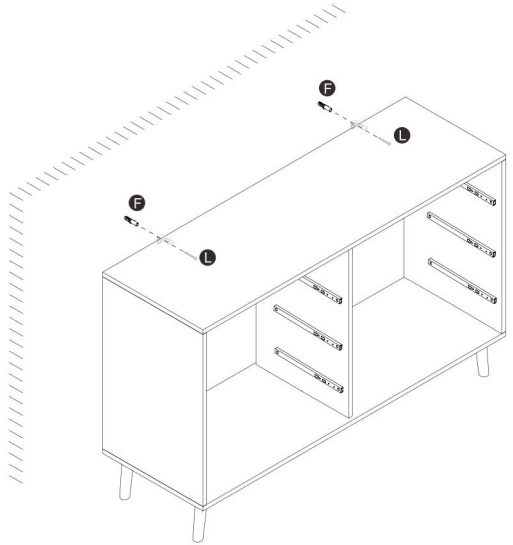

step 13

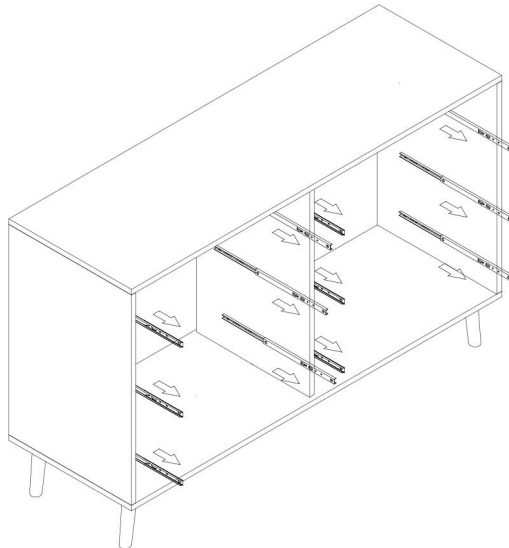

step 14

Note: Please pay attention to distinguishing the left and right directions of the drawer.
The #11 board is on the left side of the drawer, and the #16 board is on the right side.

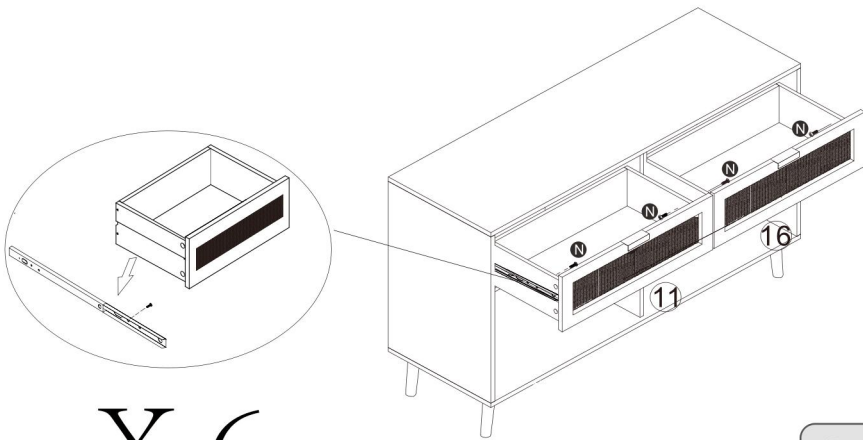

X 6



step 15

Congratulations!!

You have successfully completed the assembly!



COMPLETION



Fabricante: Shanghaimuxinmuyeyouxiangongsi

Dirección: Shuangchenglu 803nong11hao1602A-1609shi, baoshanqu, shanghai 200000 CN.

Importado a AUS: SIHAO PTY LTD. 1 ROKEVA STREET ASTWOOD NSW 2122 Australia

Importado a EE. UU.: Sanven Technology Ltd. Suite 250, 9166 Anaheim Place, Rancho Cucamonga, CA 91730

EC

REP

E-CrossStu GmbH
Mainzer Landstr.69, 60329 Frankfurt am Main.

UK

REP

YH CONSULTING LIMITED.
C/O YH Consulting Limited Office 147, Centurion House, London Road, Staines-upon-Thames, Surrey, TW18 4AX

VEVOR[®]

TOUGH TOOLS, HALF PRICE

Técnico Certificado de soporte y garantía electrónica

www.vevor.com/support

VEVOR[®]

TOUGH TOOLS, HALF PRICE

Techniczny Certyfikat wsparcia i e-gwarancji

www.vevor.com/support

RATTANOWY STOLIK KAWOWY

INSTRUKCJA OBSŁUGI

NR MODELU: SR191630WT, SR191630BK, SR191630ND

We continue to be committed to provide you tools with competitive price.

"Save Half", "Half Price" or any other similar expressions used by us only represents an estimate of savings you might benefit from buying certain tools with us compared to the major top brands and does not necessarily mean to cover all categories of tools offered by us. You are kindly reminded to verify carefully when you are placing an order with us if you are actually saving half in comparison with the top major brands.

VEVOR[®]

TOUGH TOOLS, HALF PRICE

Rattan Coffee Table

MODEL NR.: SR191630WT, SR191630BK, SR191630ND

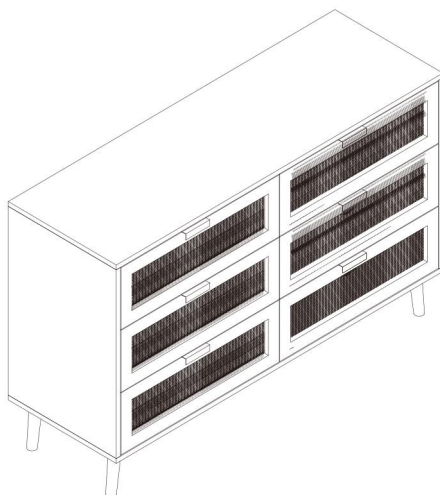

NEED HELP? CONTACT US!

Have product questions? Need technical support? Please feel free to contact us:

Technical Support and E-Warranty Certificate
www.vevor.com/support

This is the original instruction, please read all manual instructions carefully before operating. VEVOR reserves a clear interpretation of our user manual. The appearance of the product shall be subject to the product you received. Please forgive us that we won't inform you again if there are any technology or software updates on our product.

OSTRZEŻENIE:

Przed użyciem produktu prosimy o dokładne zapoznanie się z niniejszą instrukcją. Niezastosowanie się do tego może spowodować poważne obrażenia.

ŚRODKI OSTROŻNOŚCI PRZY MONTAŻU

33. Montaż wyłącznie zgodnie z niniejszą instrukcją. Nieprawidłowy montaż może stworzyć zagrożenie.
34. Podczas montażu należy nosić okulary ochronne i wytrzymałe rękawice robocze zatwierdzone przez ANSI.
35. Utrzymuj miejsce zbiórki w czystości i dobrze oświetlone.
36. Podczas montażu trzymaj osoby postronne z dala od obszaru.
37. Nie należy montować, gdy jest się zmęczonym lub pod wpływem alkoholu, narkotyków lub leków.
38. Możliwości produktu dotyczą wyłącznie produktów prawidłowo i całkowicie zmontowanych.
39. Zmontuj na płaskiej, poziomej, twardej i gładkiej powierzchni, która może bezpiecznie utrzymać rattanowy stolik kawowy.
40. Dodatkowe informacje dotyczące części wymienionych na kolejnych stronach można znaleźć w schemacie montażu w niniejszej instrukcji. Rozpakuj i oddziel wszystkie części w czystym miejscu pracy.

ZACHOWAJ TE INSTRUKCJE

STOSOWAĆ ŚRODKI OSTROŻNOŚCI

ABY ZAPOBIEC POWAŻNYM OBRAŻENIOM LUB ŚMIERCI W PRZYPADKU WYWROTU:

17. Ten produkt nie jest zabawką. Nie pozwalaj dzieciom bawić się tym przedmiotem lub w jego pobliżu.

18. Przed przeniesieniem nie należy przekraczać udźwigu.

19. Używaj wyłącznie na płaskiej, twardej i gładkiej powierzchni, która może bezpiecznie utrzymać w pełni obciążony rattanowy stolik kawowy.

20. Używaj wyłącznie zgodnie z przeznaczeniem.

Sprawdź przed każdym użyciem; nie używać, jeśli części są luźne lub uszkodzone.









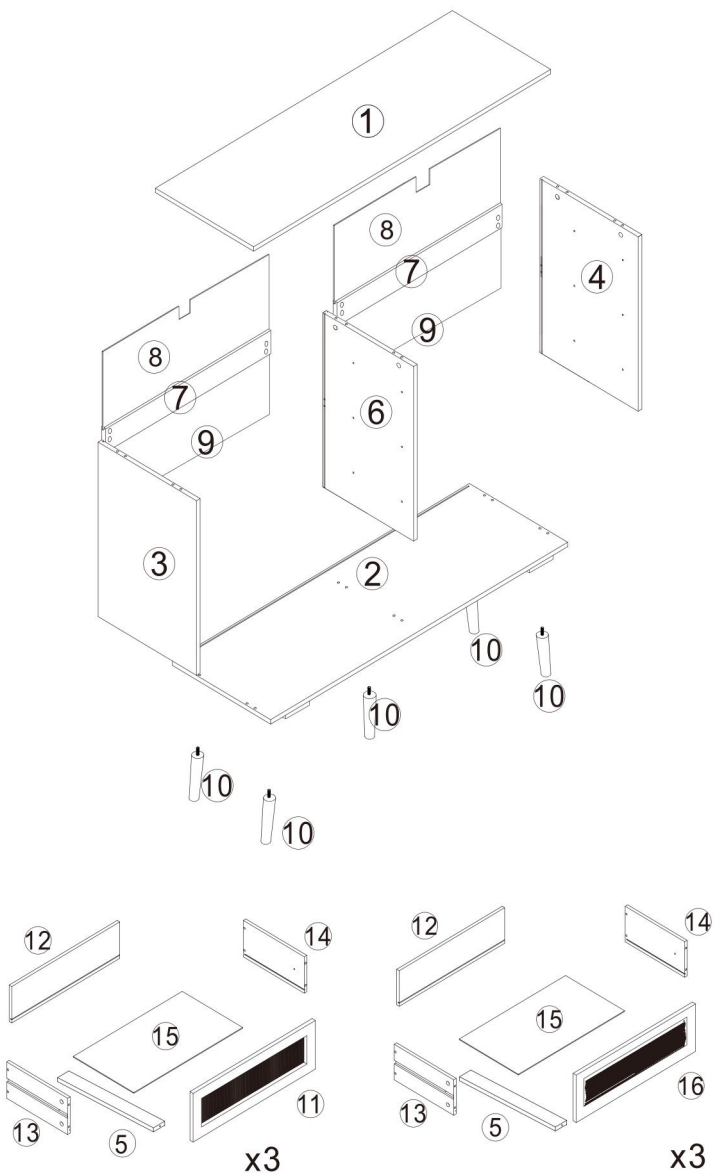







TECHNICAL SPECIFICATIONS

Model	SR191630WT	SR191630BK	SR191630ND
Kolor	Biały	Czarny	Drewno
wymiary produktu (DxSxW) (mm)	1100*400*755		
Rozmiar opakowania (dł. x szer. x wys.) (mm)	1210*485*185		
Masa netto (kg)	Okolo 32,7		
Waga brutto (kg)	Okolo 34,9		

*Produkty takie jak dane techniczne, wygląd i konstrukcja mogą podlegać modyfikacjom bez wcześniejszego powiadomienia.

PACKAGE CONTENTS



ITEM	PART	QTY	ITEM	PART	QTY
A		44 PCS	B		44 PCS
C		12 PCS	D		30 PCS
E		24PCS	F		2 PCS
G		6 PCS	H		2 PCS
I		2 PCS	K		6 PCS
L		2 PCS	M		12 PCS
N		12 PCS	O		16 PCS
P		16 PCS	Q		12 PCS

ASSEMBLY STEPS

step 1

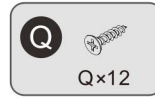
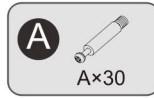

X6

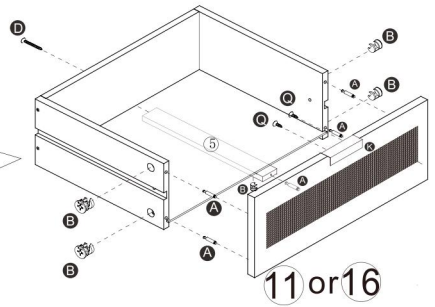
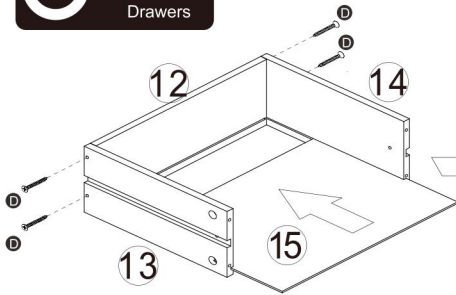

step 2

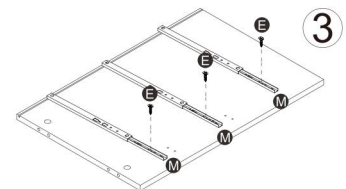
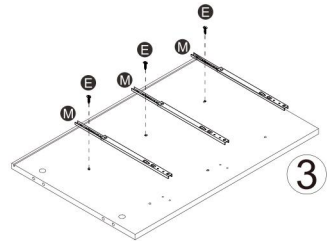
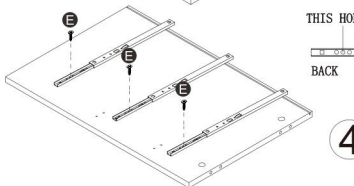
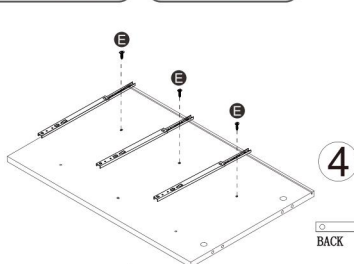

step 3

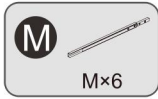

NOTE: Please pay attention to distinguishing the left and right direction of #6 board. The upper part is the right side to install #6 board, and the lower part is the left side.

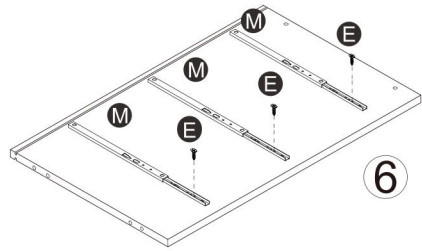
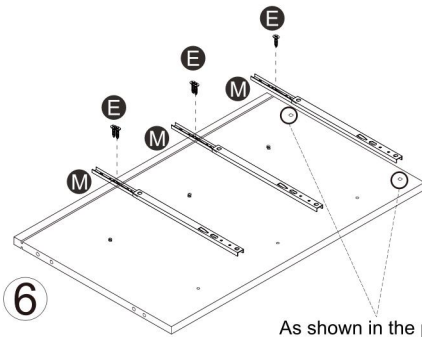
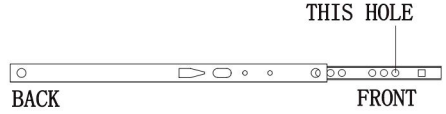

As shown in the picture above, the side of the board with the TWO HOLES is the left side.

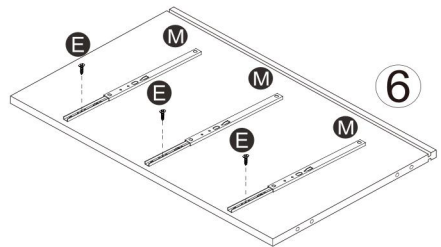
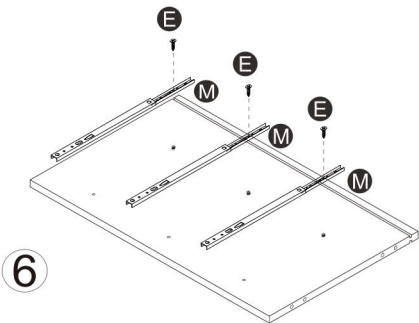
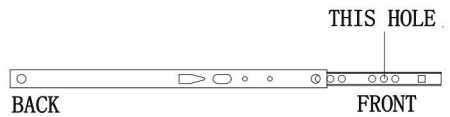

step 4

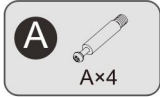

NOTE: In the next steps 4, 5, and 6, please pay attention to distinguish the direction of the board #3 and #4.

The #3 board is installed on the left side of the dresser, and the #4 board is installed on the right side.

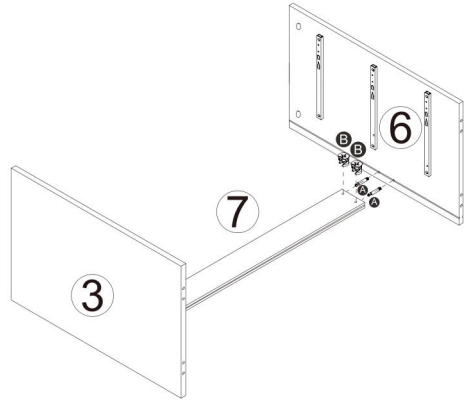
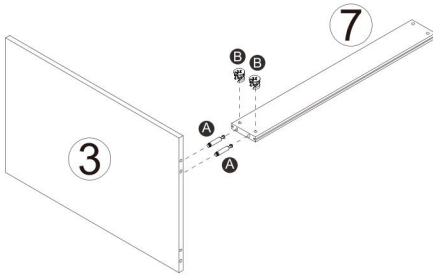

step 5

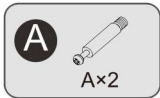

As shown in the picture above, the side of the board with the TWO HOLES is the right side.

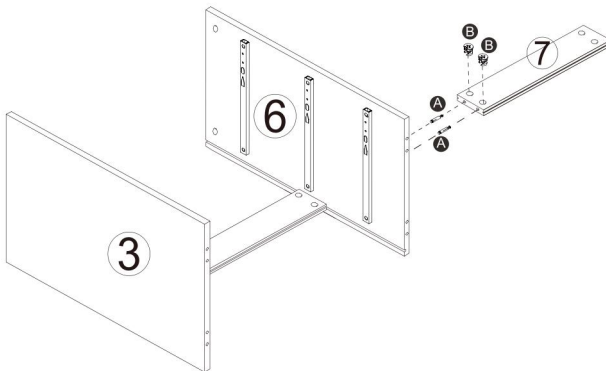

step 6

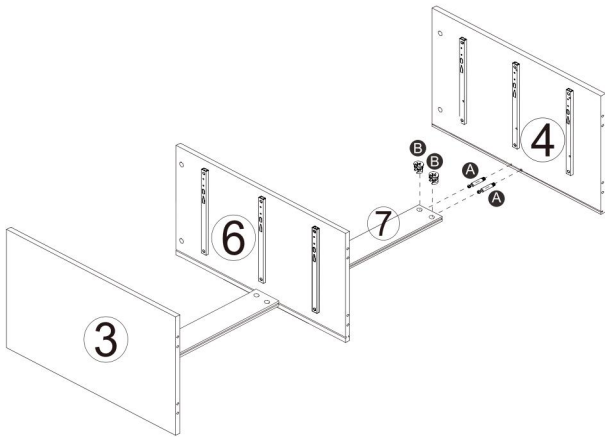

step 7

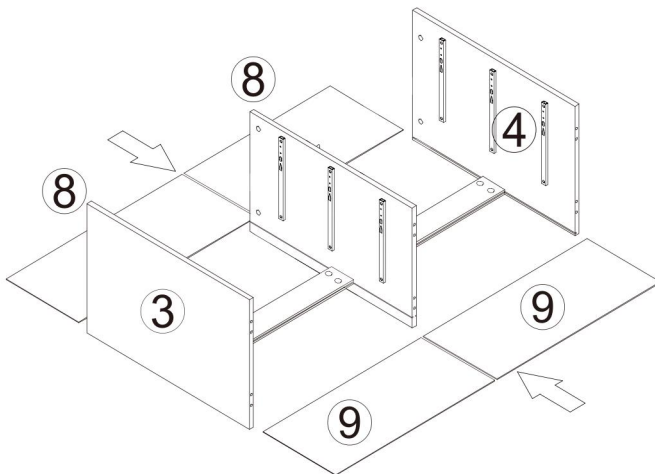

step 8

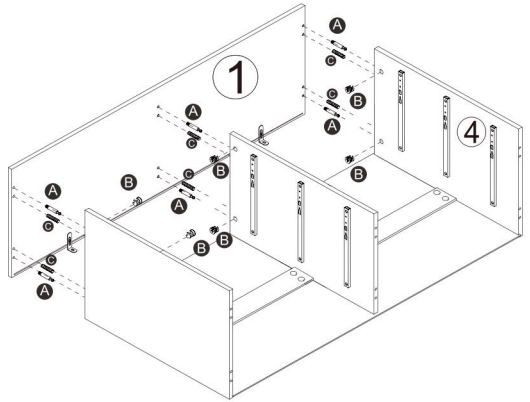
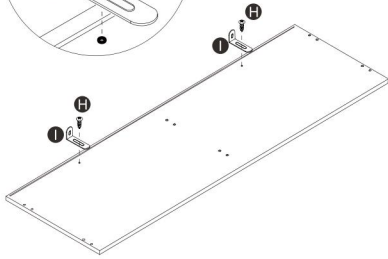
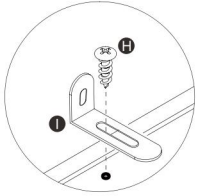
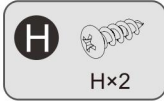

step 9

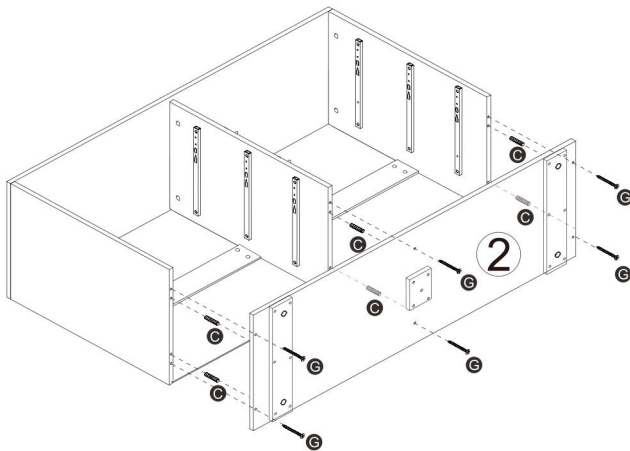

step 10

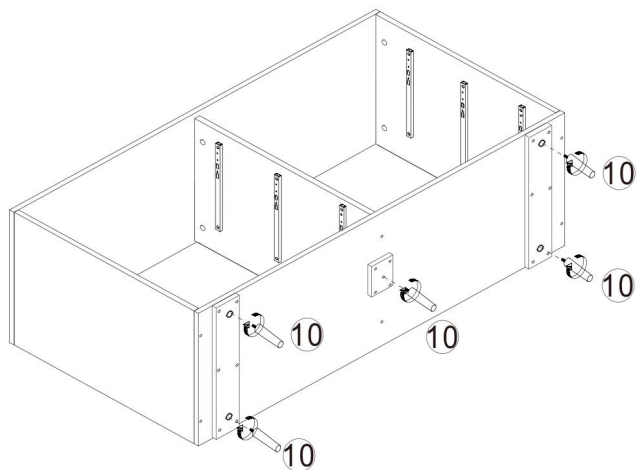

step 11

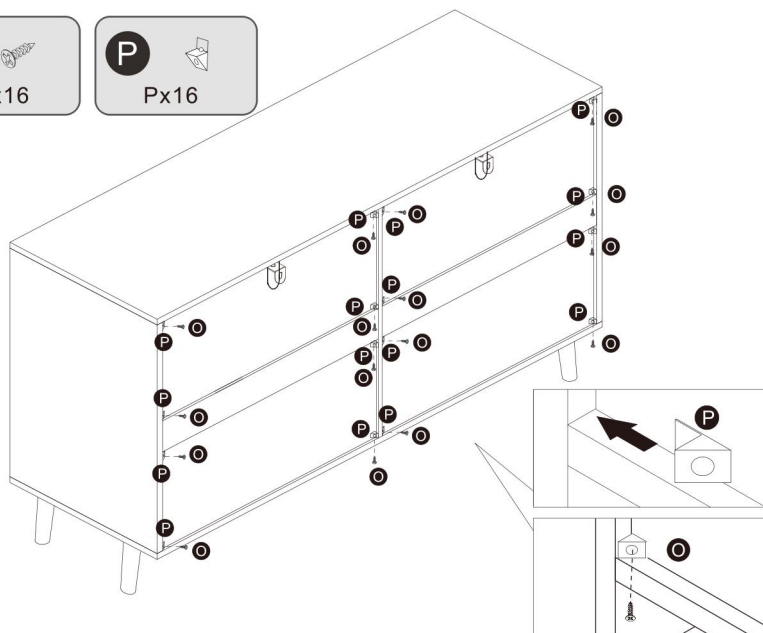

step 12

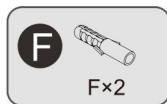

Important Note : Young children can be seriously injured by tipping furniture. You must install the tipping restraint hardware (included) with the unit to prevent the unit from tipping, causing any accidents or damage. The tipping restraints are intended only as a deterrent, they are not substitute for proper adult supervision. The tipping restraints are not earthquake restraints. If you wish to add the extra security of earthquake restraints, they must be purchased and installed separately.

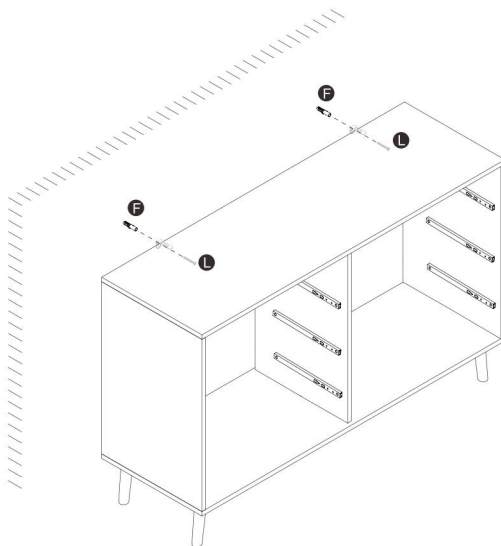

step 13

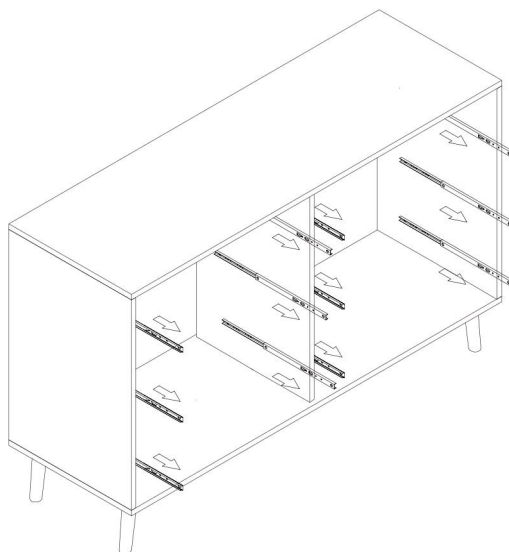

step 14

Note: Please pay attention to distinguishing the left and right directions of the drawer.
The #11 board is on the left side of the drawer, and the #16 board is on the right side.

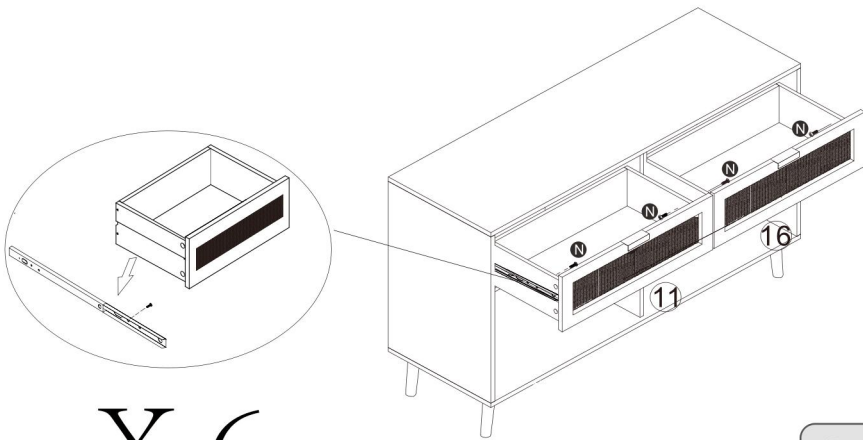

X 6



step 15

Congratulations!!

You have successfully completed the assembly!



COMPLETION



Producent: Shanghaimuxinmuyeyouxiangongsi

Adres: Shuangchenglu 803nong11hao1602A-1609shi, baoshanqu, szanghaj 200000 CN.

Import do AUS: SIHAO PTY LTD. 1 ROKEVA STREETEASTWOOD NSW 2122 Australia

Import do USA: Sanven Technology Ltd. Suite 250, 9166 Anaheim Place, Rancho Cucamonga, CA 91730

EC

REP

E-CrossStu GmbH
Mainzer Landstr.69, 60329 Frankfurt am Main.

UK

REP

YH CONSULTING LIMITED.
C/O YH Consulting Limited Office 147, Centurion House, London Road, Staines-upon-Thames, Surrey, TW18 4AX

VEVOR[®]

TOUGH TOOLS, HALF PRICE

Techniczny Certyfikat wsparcia i e-gwarancji

www.vevor.com/support

VEVOR[®]

TOUGH TOOLS, HALF PRICE

Technisch Ondersteuning en e-garantiecertificaat
www.vevor.com/support

ROTAN SALONTAFEL

HANDLEIDING

MODELNR.: SR191630WT, SR191630BK, SR191630ND

We continue to be committed to provide you tools with competitive price. "Save Half", "Half Price" or any other similar expressions used by us only represents an estimate of savings you might benefit from buying certain tools with us compared to the major top brands and does not necessarily mean to cover all categories of tools offered by us. You are kindly reminded to verify carefully when you are placing an order with us if you are actually saving half in comparison with the top major brands.

VEVOR®

TOUGH TOOLS, HALF PRICE

Rattan Coffee Table

MODELNR.: SR191630WT, SR191630BK, SR191630ND

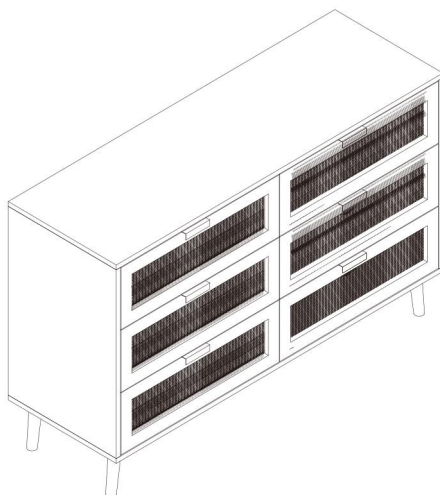

NEED HELP? CONTACT US!

Have product questions? Need technical support? Please feel free to contact us:

Technical Support and E-Warranty Certificate
www.vevor.com/support

This is the original instruction, please read all manual instructions carefully before operating. VEVOR reserves a clear interpretation of our user manual. The appearance of the product shall be subject to the product you received. Please forgive us that we won't inform you again if there are any technology or software updates on our product.

WAARSCHUWING:

Lees deze handleiding zorgvuldig door voordat u het product gebruikt. Als u dit niet doet, kan dit leiden tot ernstig letsel.

MONTAGEVOORZORGSMATREGELEN

41. Monteer uitsluitend volgens deze instructies. Onjuiste montage kan gevaren veroorzaken.
42. Draag tijdens de montage een ANSI-goedgekeurde veiligheidsbril en stevige werkhandschoenen.
43. Houd de verzamelplaats schoon en goed verlicht.
44. Houd omstanders tijdens de montage uit de buurt.
45. Niet monteren als u moe bent of onder invloed bent van alcohol, drugs of medicijnen.
46. De productmogelijkheden zijn alleen van toepassing op correct en volledig gemonteerde producten.
47. Monteer op een vlak, vlak, hard en glad oppervlak dat de rotan salontafel veilig kan ondersteunen.
48. Voor aanvullende informatie over de onderdelen die op de volgende pagina's worden vermeld, verwijzen wij u naar het montageschema van deze handleiding. Pak alle onderdelen uit en scheid ze van elkaar op een schone werkplek.

BEWAAR DEZE INSTRUCTIES

GEBRUIK VOORZORGSMAATREGELEN

OM ERNSTIG LETSEL EN DE DOOD DOOR KANTELEN TE VOORKOMEN:

21. Dit product is geen speelgoed. Laat kinderen niet met of in de buurt van dit artikel spelen.
22. Overschrijd het gewicht niet voordat u gaat verhuizen.
23. Alleen gebruiken op een vlak, hard en glad oppervlak dat een volledig beladen rotan salontafel veilig kan ondersteunen.
24. Alleen gebruiken zoals bedoeld.
Inspecteer vóór elk gebruik; niet gebruiken als onderdelen los of beschadigd zijn.









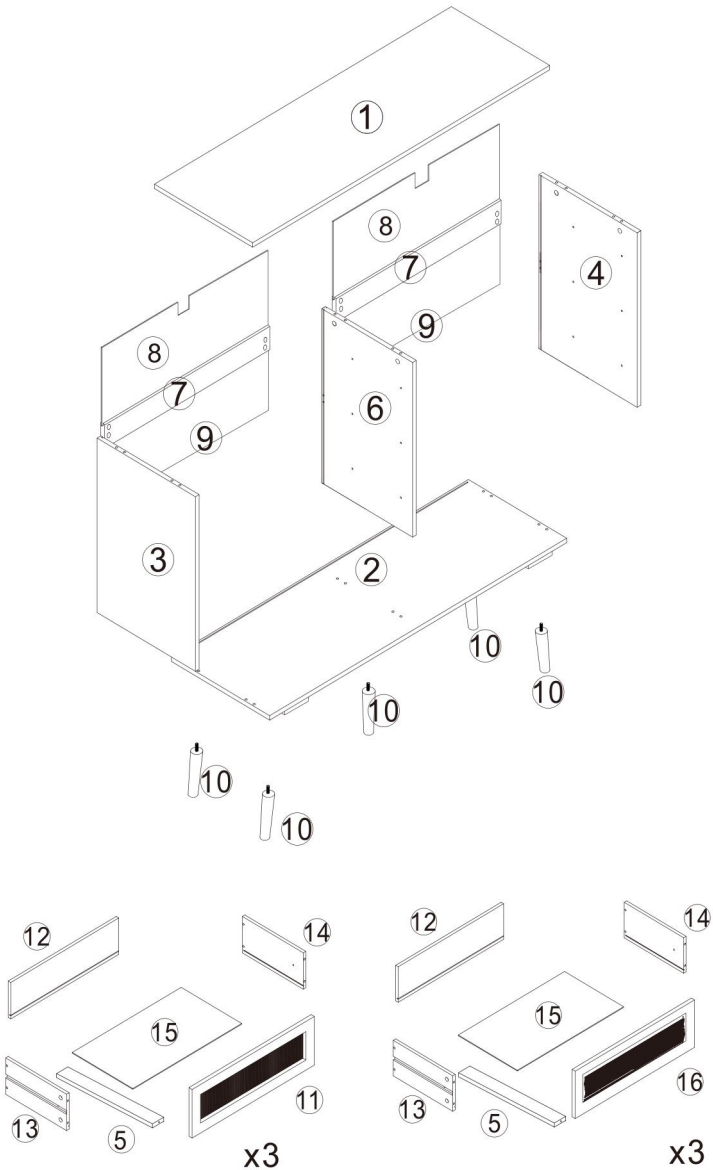







TECHNICAL SPECIFICATIONS

Model	SR191630WT	SR191630BK	SR191630ND
Kleur	Wit	Zwart	Hout
Productafmetingen (LxBxH)(mm)	1100*400*755		
Verpakkingsgrootte (LxBxH) (mm)	1210*485*185		
Netto gewicht / kg)	Ongeveer 32,7		
Bruto gewicht (kg)	Ongeveer 34,9		

*Producten zoals specificaties, uiterlijk en ontwerp kunnen zonder voorafgaande kennisgeving worden gewijzigd.

PACKAGE CONTENTS



ITEM	PART	QTY	ITEM	PART	QTY
A		44 PCS	B		44 PCS
C		12 PCS	D		30 PCS
E		24PCS	F		2 PCS
G		6 PCS	H		2 PCS
I		2 PCS	K		6 PCS
L		2 PCS	M		12 PCS
N		12 PCS	O		16 PCS
P		16 PCS	Q		12 PCS

ASSEMBLY STEPS

step 1

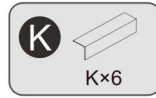
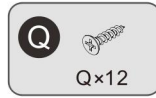
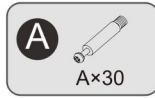

X6

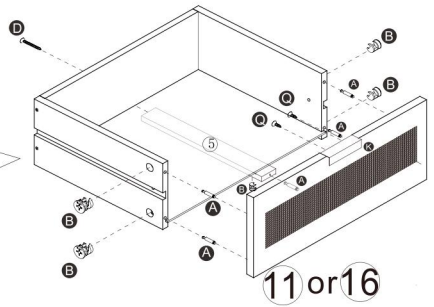
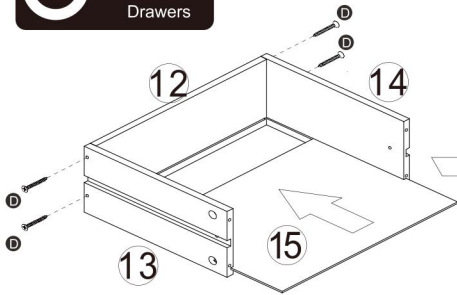

step 2

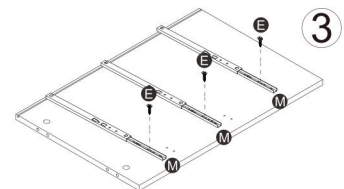
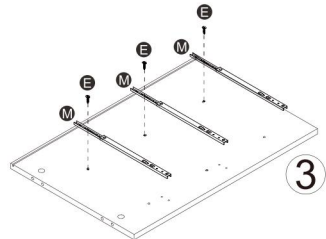
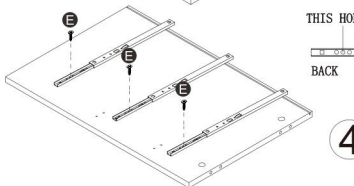
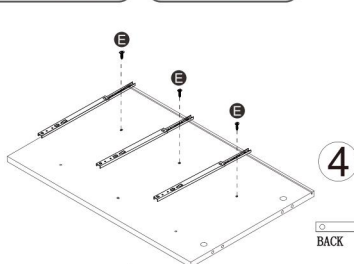
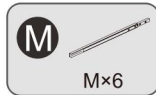

step 3

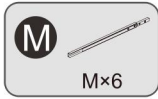

NOTE: Please pay attention to distinguishing the left and right direction of #6 board. The upper part is the right side to install #6 board, and the lower part is the left side.

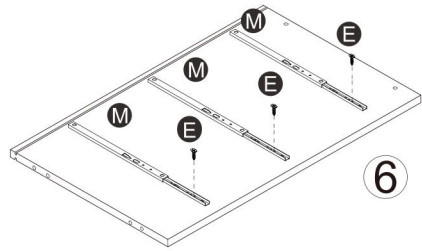
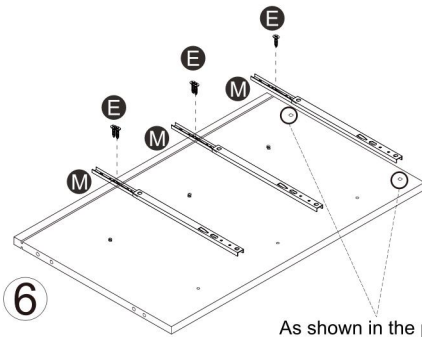
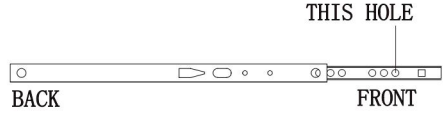

As shown in the picture above, the side of the board with the TWO HOLES is the left side.

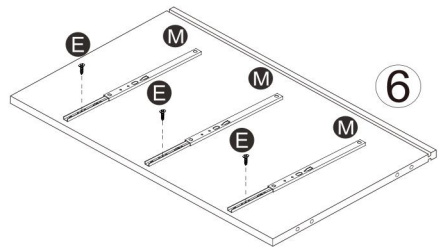
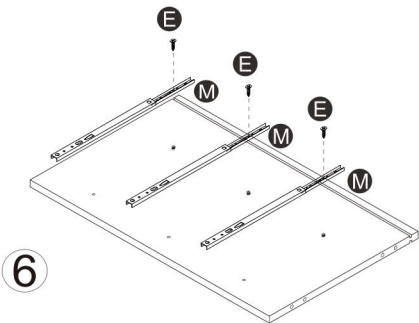
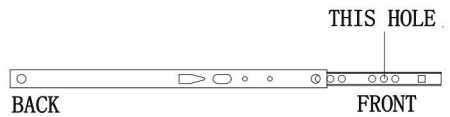

step 4

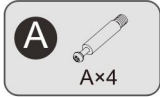

NOTE: In the next steps 4, 5, and 6, please pay attention to distinguish the direction of the board #3 and #4.

The #3 board is installed on the left side of the dresser, and the #4 board is installed on the right side.

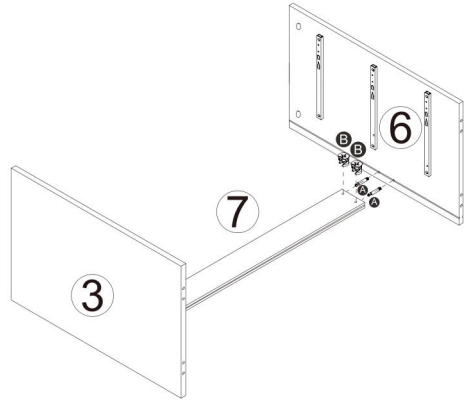
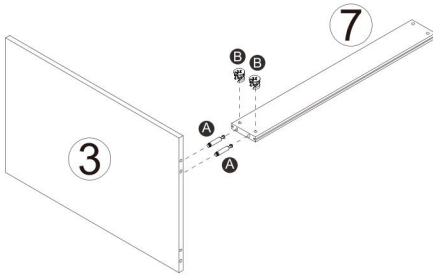

step 5

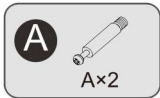

As shown in the picture above, the side of the board with the TWO HOLES is the right side.

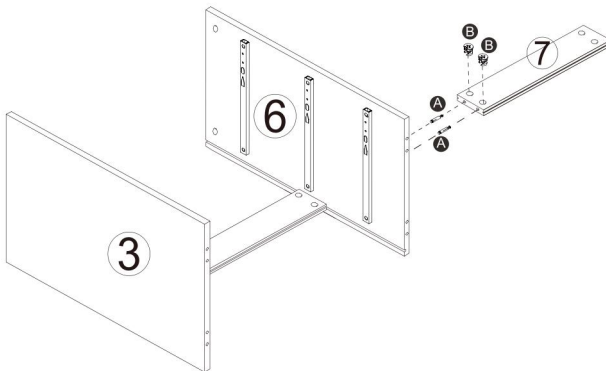

step 6

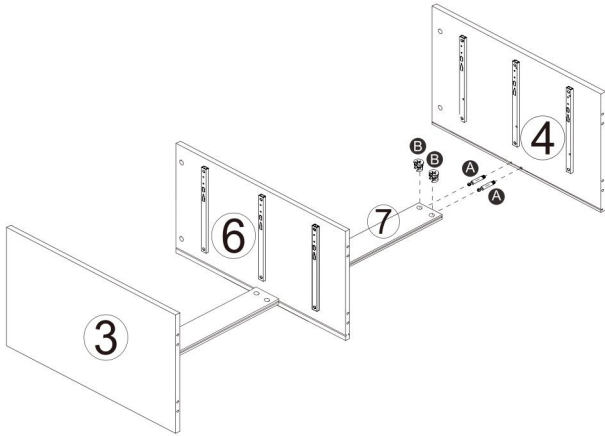
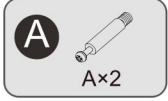

step 7

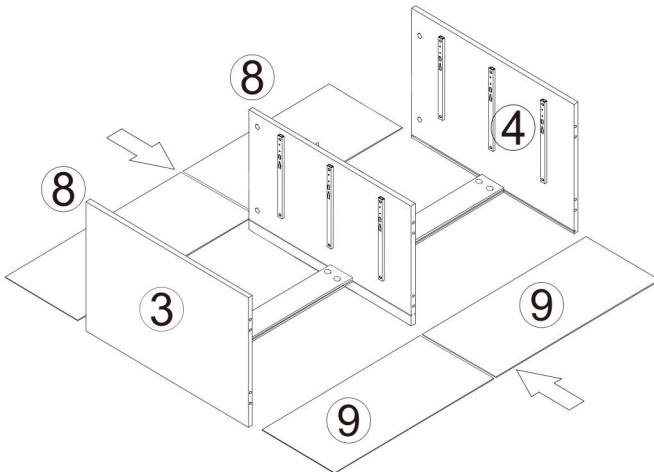

step 8

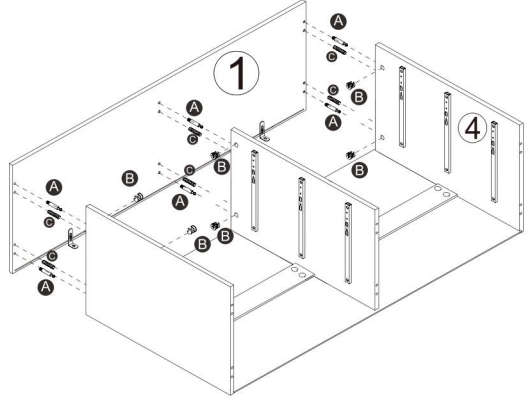
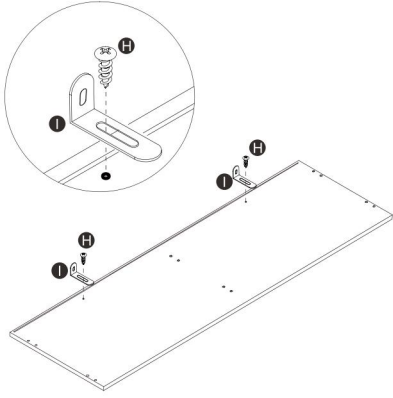
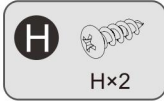

step 9

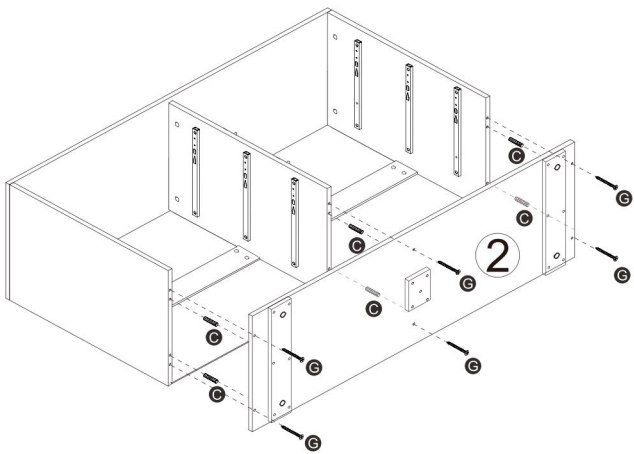

step 10

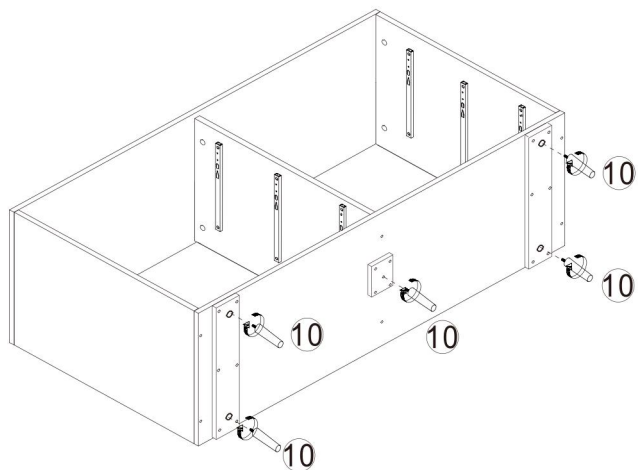

step 11

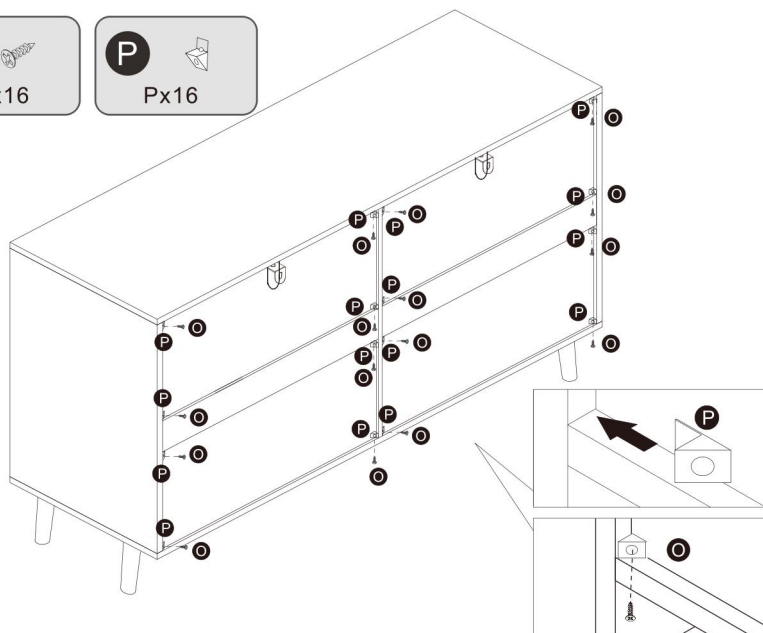

step 12

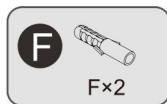

Important Note : Young children can be seriously injured by tipping furniture. You must install the tipping restraint hardware (included) with the unit to prevent the unit from tipping, causing any accidents or damage. The tipping restraints are intended only as a deterrent, they are not substitute for proper adult supervision. The tipping restraints are not earthquake restraints. If you wish to add the extra security of earthquake restraints, they must be purchased and installed separately.

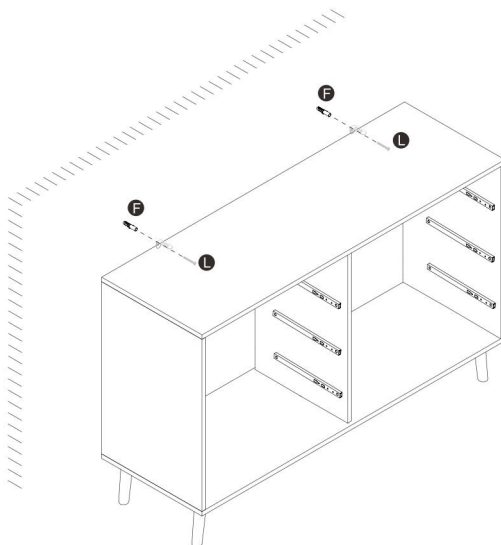

step 13

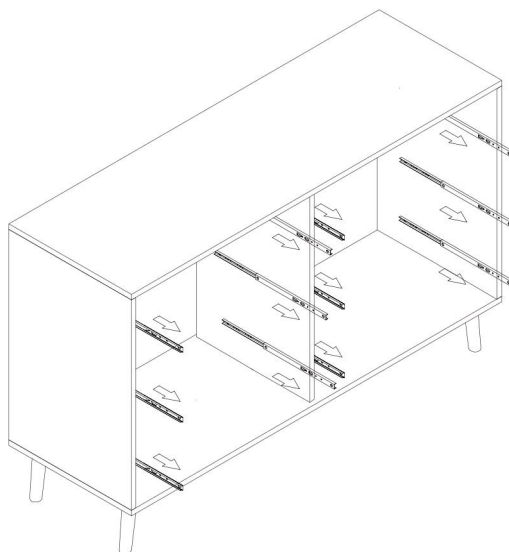

step 14

Note: Please pay attention to distinguishing the left and right directions of the drawer.
The #11 board is on the left side of the drawer, and the #16 board is on the right side.

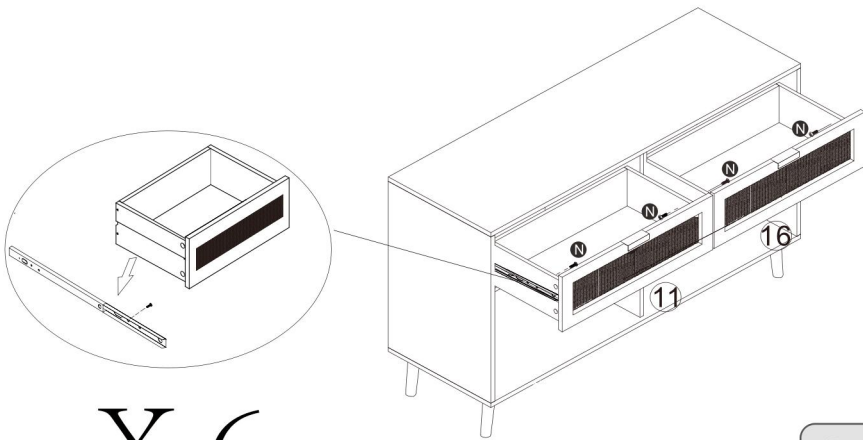

X 6



step 15

Congratulations!!

You have successfully completed the assembly!



COMPLETION



Fabrikant: Shanghaimuxinmuyeyouxiangongsi

Adres: Shuangchenglu 803nong11hao1602A-1609shi, baoshanqu, shanghai 200000 CN.

Geïmporteerd naar AUS: SIHAO PTY LTD. 1 ROKEVA
STREETEASTWOOD NSW 2122 Australië

Geïmporteerd naar de VS: Sanven Technology Ltd. Suite 250, 9166
Anaheim Place, Rancho Cucamonga, CA 91730

EC

REP

E-CrossStu GmbH
Mainzer Landstr.69, 60329 Frankfurt am Main.

UK

REP

YH CONSULTING LIMITED.
C/O YH Consulting Limited Office 147, Centurion
House, London Road, Staines-upon-Thames, Surrey,
TW18 4AX

VEVOR[®]

TOUGH TOOLS, HALF PRICE

Technisch Ondersteuning en e-garantiecertificaat

www.vevor.com/support

VEVOR[®]

TOUGH TOOLS, HALF PRICE

Teknisk Support och e-garanticertifikat

www.vevor.com/support

SOFFBORD I ROTTING

ANVÄNDARMANUAL

MODELLNR: SR191630WT, SR191630BK, SR191630ND

We continue to be committed to provide you tools with competitive price.

"Save Half", "Half Price" or any other similar expressions used by us only represents an estimate of savings you might benefit from buying certain tools with us compared to the major top brands and does not necessarily mean to cover all categories of tools offered by us. You are kindly reminded to verify carefully when you are placing an order with us if you are actually saving half in comparison with the top major brands.

VEVOR[®]

TOUGH TOOLS, HALF PRICE

Rattan Coffee Table

MODELL NR.: SR191630WT, SR191630BK, SR191630ND

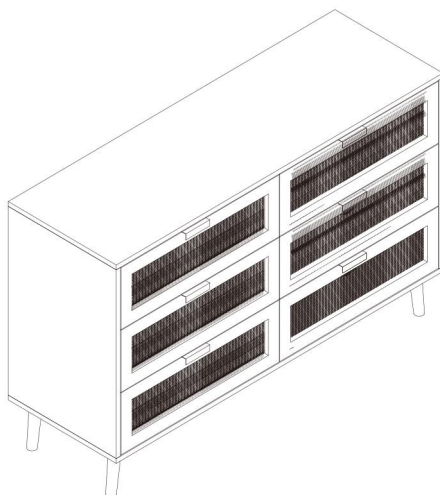

NEED HELP? CONTACT US!

Have product questions? Need technical support? Please feel free to contact us:

Technical Support and E-Warranty Certificate
www.vevor.com/support

This is the original instruction, please read all manual instructions carefully before operating. VEVOR reserves a clear interpretation of our user manual. The appearance of the product shall be subject to the product you received. Please forgive us that we won't inform you again if there are any technology or software updates on our product.

 **VARNING:**

Läs denna bruksanvisning noggrant innan du använder produkten. Underlåtenhet att göra det kan leda till allvarliga skador.

FÖRSIKTIGHETSÅTGÄRDER FÖR MONTERING

49. Montera endast enligt dessa instruktioner. Felaktig montering kan skapa faror.
50. Använd ANSI-godkända skyddsglasögon och kraftiga arbetshandskar vid montering.
51. Håll monteringsområdet rent och väl upplyst.
52. Håll åskådare borta från området under monteringen.
53. Sätt dig inte ihop när du är trött eller påverkad av alkohol, droger eller mediciner.
54. Produktegenskaperna gäller endast för korrekt och färdigmonterade produkter.
55. Montera på en plan, jämn, hård och slät yta som säkert kan stödja rottingsoffbordet.
56. För ytterligare information om delarna som listas på följande sidor, se monteringsdiagrammet i denna manual. Packa upp och separera alla delar på ett rent arbetsområde.

SPARA DESSA E INSTRUKTIONER

ANVÄND FÖRSIKTIGHETSÅTGÄRDER

FÖR ATT FÖRHINDRA ALLVARLIGA SKADA OCH DÖDSFALL VID VÄLLNING:

25. Denna produkt är inte en leksak. Tillåt inte barn att leka med eller i närheten av detta föremål.
26. Överskrid inte viktkapaciteten innan du flyttar.
27. Använd endast på en plan, hård och slät yta som säkert kan bära ett fullastat soffbord i rotting.
28. Använd endast som avsett.
Inspektera före varje användning; Använd inte om delar är lösa eller skadade.









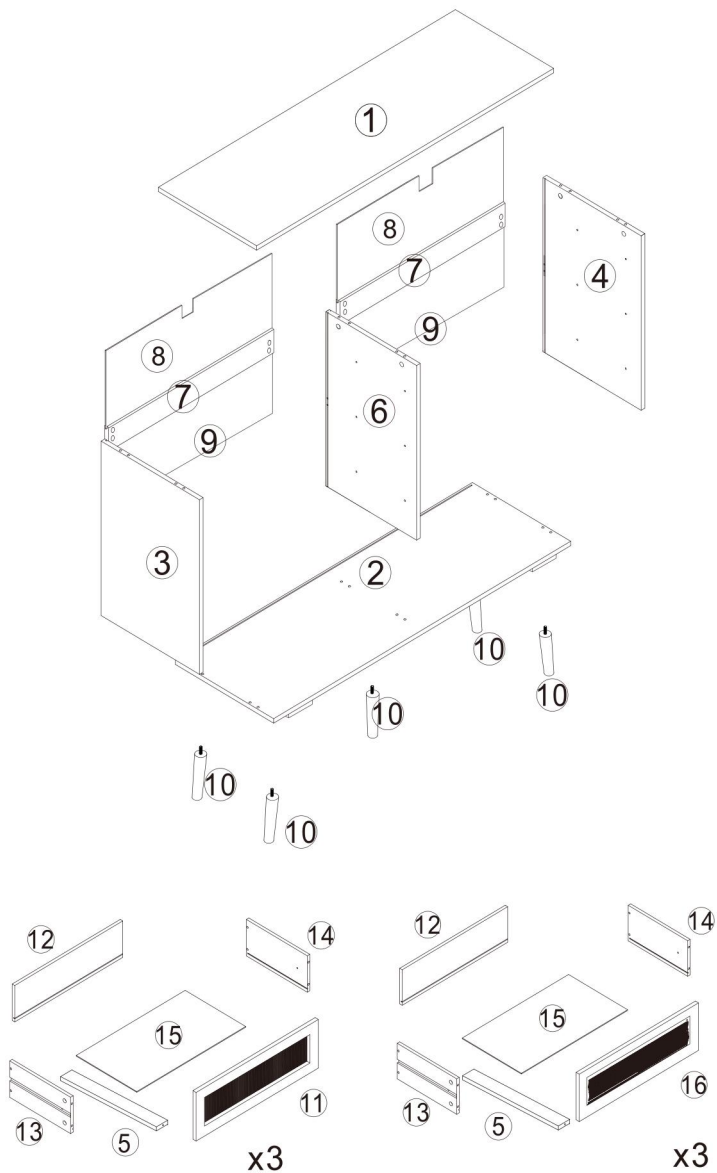







TECHNICAL SPECIFICATIONS

Modell	SR191630WT	SR191630BK	SR191630ND
Färg	Vit	Svart	Trä
Produktens mått (LxBxH)(mm)	1100*400*755		
Förpackningsstorle k(LxBxH)(mm)	1210*485*185		
Nettovikt (kg)	Cirka 32,7		
Bruttovikt (kg)	Cirka 34,9		

*Produkter som specifikationer, utseende och design kan ändras utan föregående meddelande.

PACKAGE CONTENTS



ITEM	PART	QTY	ITEM	PART	QTY
A		44 PCS	B		44 PCS
C		12 PCS	D		30 PCS
E		24PCS	F		2 PCS
G		6 PCS	H		2 PCS
I		2 PCS	K		6 PCS
L		2 PCS	M		12 PCS
N		12 PCS	O		16 PCS
P		16 PCS	Q		12 PCS

ASSEMBLY STEPS

step 1

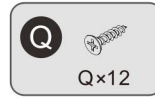
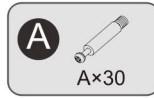

X6

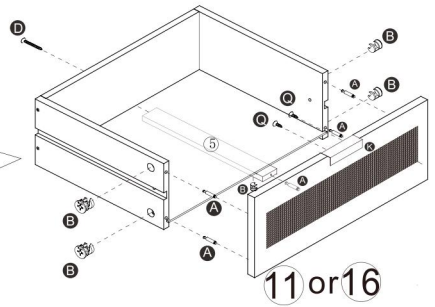
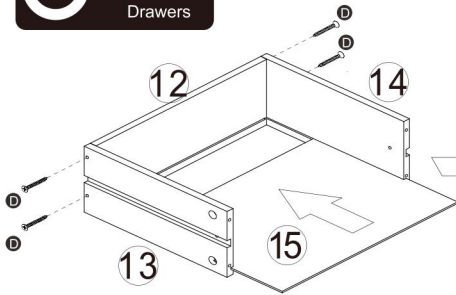

step 2

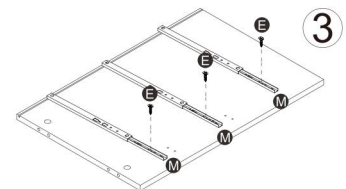
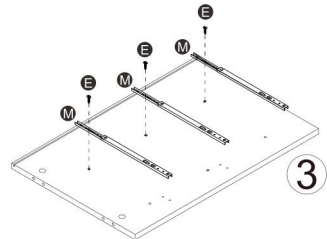
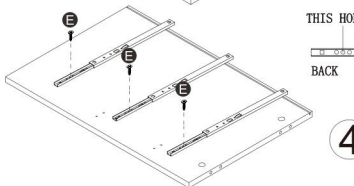
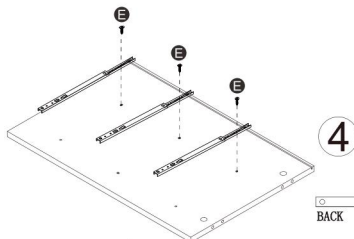

step 3

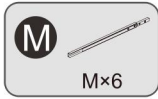

NOTE: Please pay attention to distinguishing the left and right direction of #6 board. The upper part is the right side to install #6 board, and the lower part is the left side.

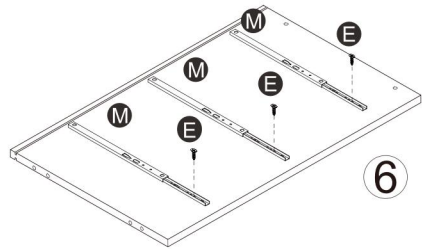
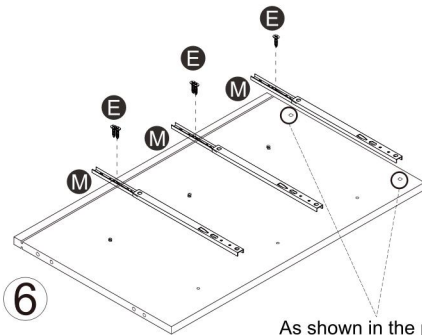
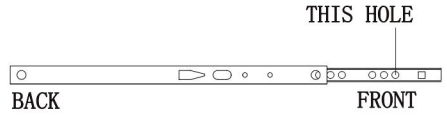

As shown in the picture above, the side of the board with the TWO HOLES is the left side.

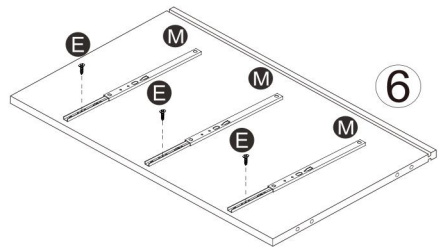
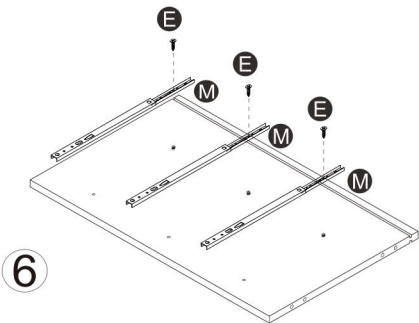
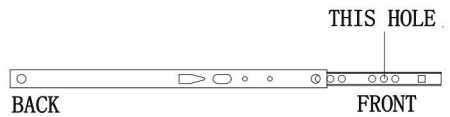

step 4

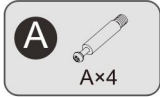

NOTE: In the next steps 4, 5, and 6, please pay attention to distinguish the direction of the board #3 and #4.

The #3 board is installed on the left side of the dresser, and the #4 board is installed on the right side.

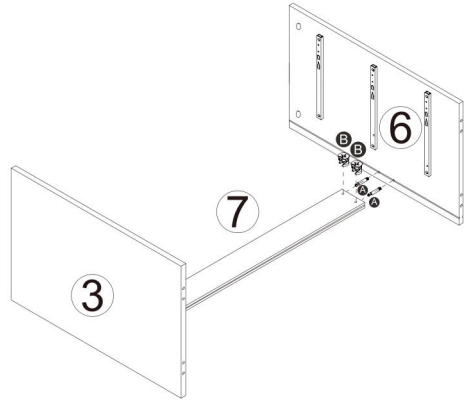
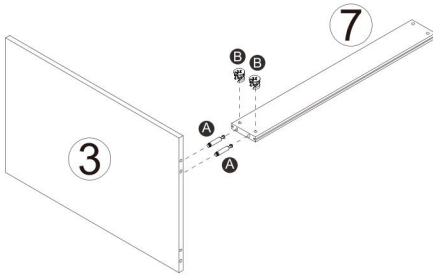

step 5

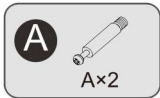

As shown in the picture above, the side of the board with the TWO HOLES is the right side.

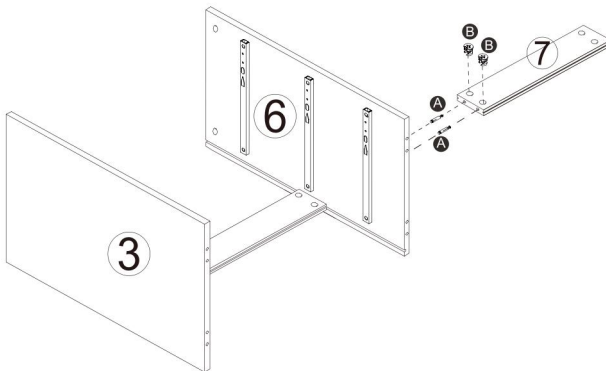

step 6

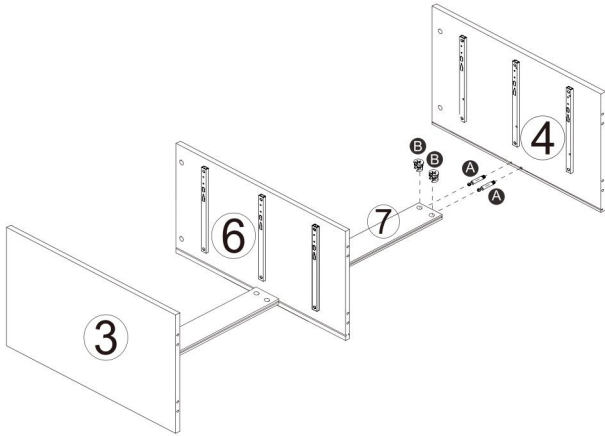
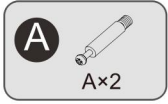

step 7

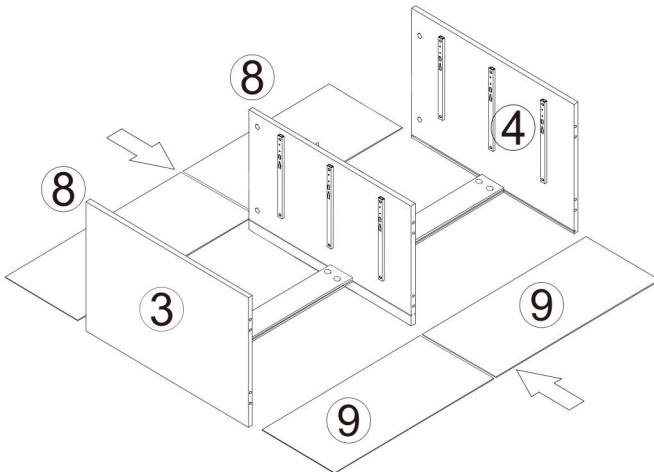

step 8

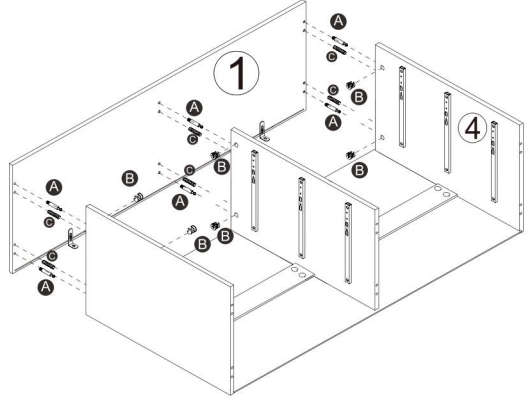
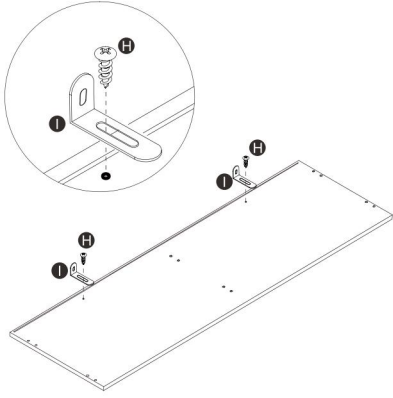
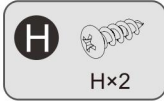

step 9

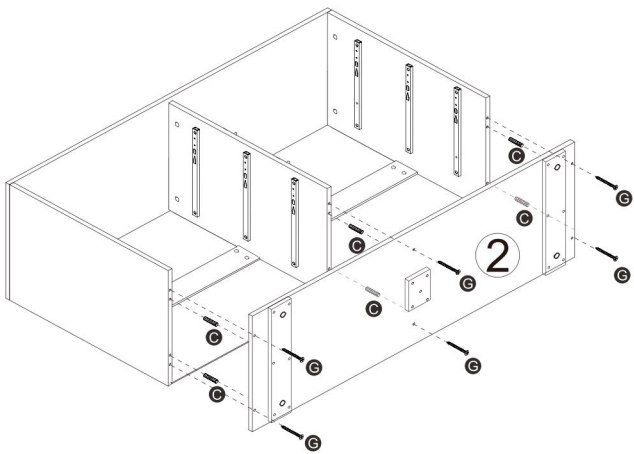

step 10

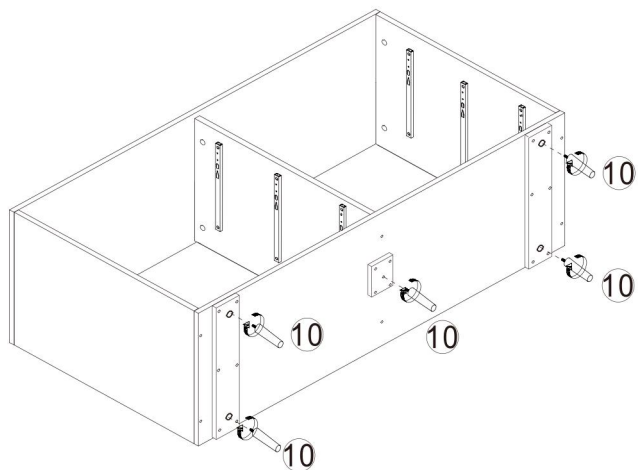

step 11

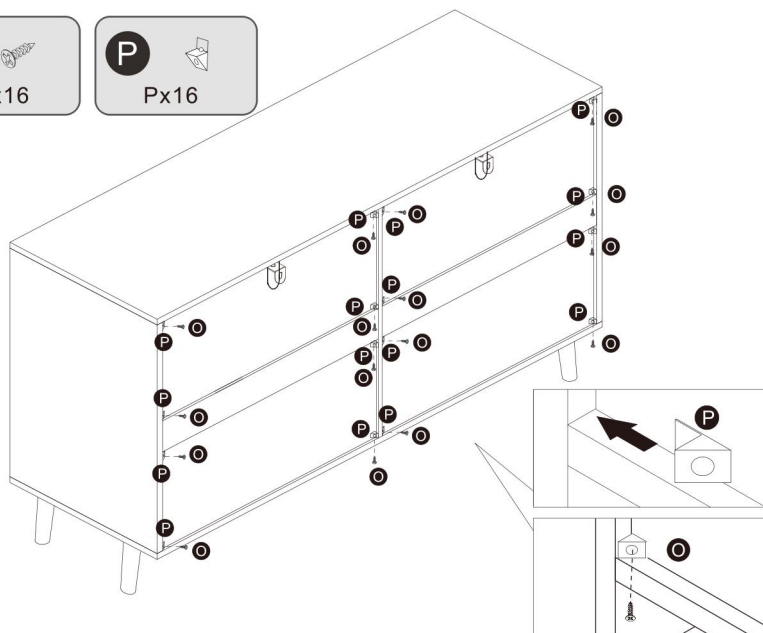

step 12

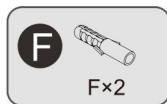

Important Note : Young children can be seriously injured by tipping furniture. You must install the tipping restraint hardware (included) with the unit to prevent the unit from tipping, causing any accidents or damage. The tipping restraints are intended only as a deterrent, they are not substitute for proper adult supervision. The tipping restraints are not earthquake restraints. If you wish to add the extra security of earthquake restraints, they must be purchased and installed separately.

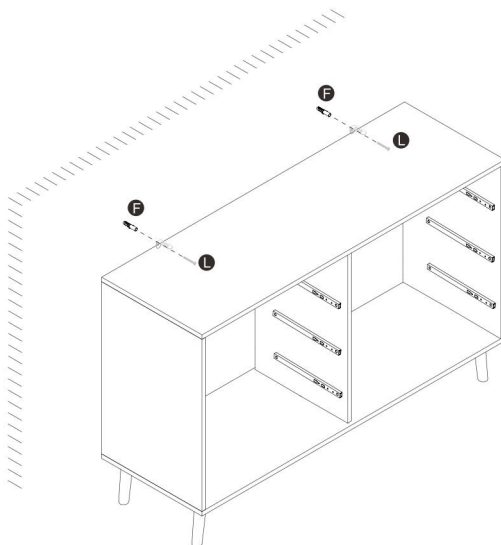

step 13

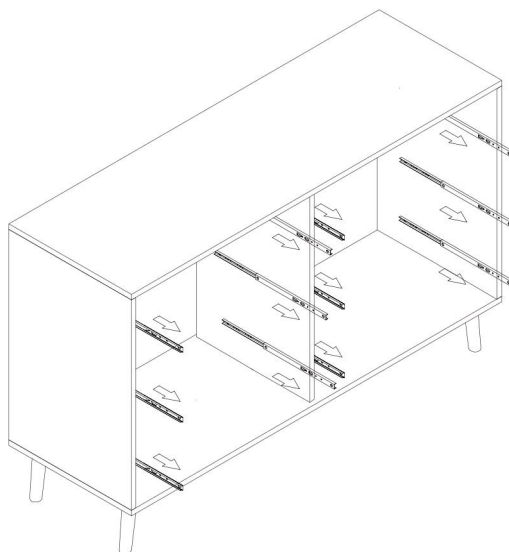

step 14

Note: Please pay attention to distinguishing the left and right directions of the drawer.
The #11 board is on the left side of the drawer, and the #16 board is on the right side.

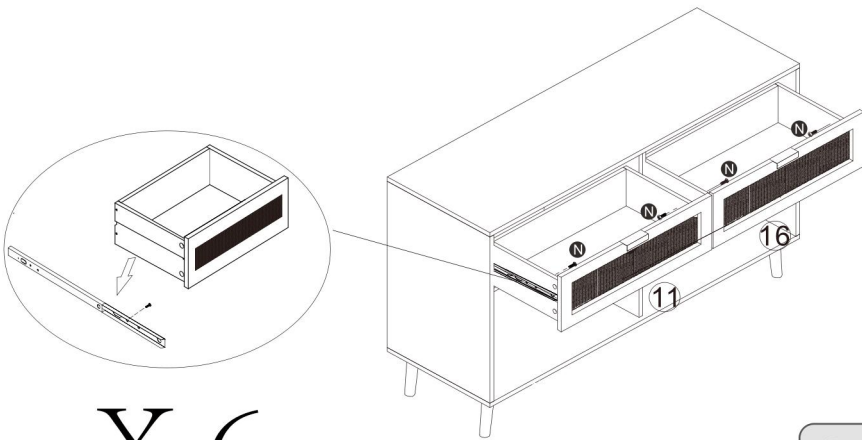

X 6



step 15

Congratulations!!

You have successfully completed the assembly!



COMPLETION



Tillverkare: Shanghaimuxinmuyeyouxiangongsi

Adress: Shuangchenglu 803nong11hao1602A-1609shi, baoshanqu, shanghai 200000 CN.

Importerad till AUS: SIHAO PTY LTD. 1 ROKEVA STREETEASTWOOD NSW 2122 Australien

Importerad till USA: Sanven Technology Ltd. Suite 250, 9166 Anaheim Place, Rancho Cucamonga, CA 91730

EC

REP

E-CrossStu GmbH
Mainzer Landstr.69, 60329 Frankfurt am Main.

UK

REP

YH CONSULTING LIMITED.
C/O YH Consulting Limited Office 147, Centurion House, London Road, Staines-upon-Thames, Surrey, TW18 4AX

VEVOR[®]

TOUGH TOOLS, HALF PRICE

Teknisk Support och e-garanticertifikat

www.vevor.com/support

VEVOR[®]

TOUGH TOOLS, HALF PRICE

Technique Assistance et certificat de garantie électronique

www.vevor.com/support

TABLE BASSE EN ROTIN

MANUEL DE L'UTILISATEUR

N° DE MODÈLE : SR191630WT, SR191630BK, SR191630ND

We continue to be committed to provide you tools with competitive price.

"Save Half", "Half Price" or any other similar expressions used by us only represents an estimate of savings you might benefit from buying certain tools with us compared to the major top brands and does not necessarily mean to cover all categories of tools offered by us. You are kindly reminded to verify carefully when you are placing an order with us if you are actually saving half in comparison with the top major brands.

VEVOR®

TOUGH TOOLS, HALF PRICE

Rattan Coffee Table

N° DE MODÈLE : SR191630WT, SR191630BK, SR191630ND

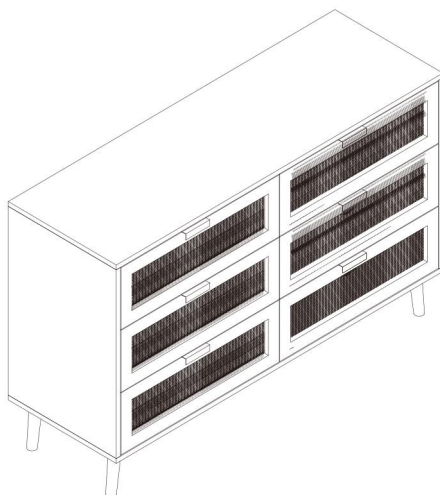

NEED HELP? CONTACT US!

Have product questions? Need technical support? Please feel free to contact us:

Technical Support and E-Warranty Certificate
www.vevor.com/support

This is the original instruction, please read all manual instructions carefully before operating. VEVOR reserves a clear interpretation of our user manual. The appearance of the product shall be subject to the product you received. Please forgive us that we won't inform you again if there are any technology or software updates on our product.

 **AVERTISSEMENT:**

Veillez lire attentivement ce manuel avant d'utiliser le produit. Ne pas le faire pourrait entraîner des blessures graves.

PRÉCAUTIONS DE MONTAGE

57. Assemblez uniquement selon ces instructions. Un assemblage incorrect peut créer des dangers.

58. Portez des lunettes de sécurité approuvées par l'ANSI et des gants de travail robustes pendant l'assemblage.

59. Gardez la zone de rassemblement propre et bien éclairée.

60. Gardez les spectateurs hors de la zone pendant l' assemblage.

61. Ne vous rassemblez pas lorsque vous êtes fatigué ou sous l' influence de l' alcool, de drogues ou de médicaments.

62. Les capacités du produit s'appliquent uniquement aux produits correctement et complètement assemblés.

63. Assemblez-le sur une surface plane, dure et lisse, capable de soutenir en toute sécurité la table basse en rotin.

64. Pour plus d'informations concernant les pièces répertoriées dans les pages suivantes, veuillez vous référer au schéma d'assemblage de ce manuel. Déballez et séparez toutes les pièces dans une zone de travail propre.

CONSERVEZ CES INSTRUCTIONS

PRÉCAUTIONS D'UTILISATION

POUR ÉVITER DES BLESSURES GRAVES ET LA MORT PAR BASCULEMENT :

29. Ce produit n'est pas un jouet. Ne laissez pas les enfants jouer avec ou à proximité de cet article.

30. Ne dépassez pas les capacités de poids avant de vous déplacer.

31. Utiliser uniquement sur une surface plane, dure et lisse capable de supporter en toute sécurité une table basse en rotin entièrement chargée.

32. Utiliser uniquement comme prévu.

Inspectez avant chaque utilisation ; ne pas utiliser si les pièces sont desserrées ou endommagées.

TECHNICAL SPECIFICATIONS









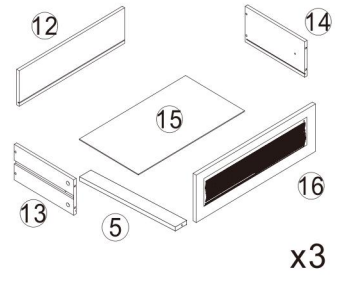
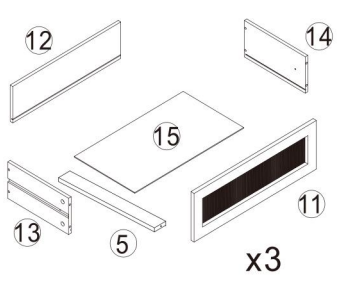
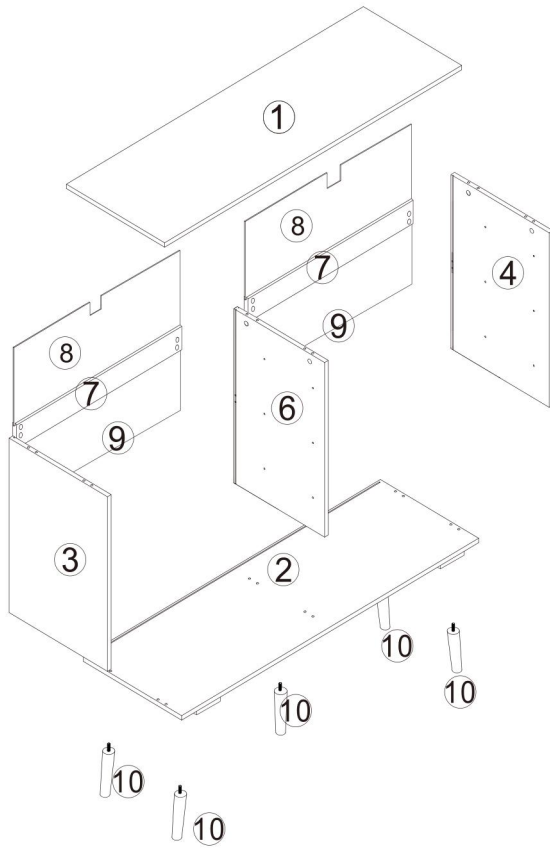







Modèle	SR191630WT	SR191630BK	SR191630ND
Couleur	Blanc	Noir	Bois
dimensions du produit (LxIxH)(mm)	1100*400*755		
Taille de l'emballage (LxIxH)(mm)	1210*485*185		
Poids net / kg	Environ 32,7		

Poids brut (kg)	Environ 34,9
-----------------	--------------

*Les produits tels que les spécifications, l'apparence et la conception sont sujets à modification sans préavis.

PACKAGE CONTENTS



ITEM	PART	QTY	ITEM	PART	QTY
A		44 PCS	B		44 PCS
C		12 PCS	D		30 PCS
E		24PCS	F		2 PCS
G		6 PCS	H		2 PCS
I		2 PCS	K		6 PCS
L		2 PCS	M		12 PCS
N		12 PCS	O		16 PCS
P		16 PCS	Q		12 PCS

ASSEMBLY STEPS

step 1

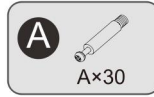

X6

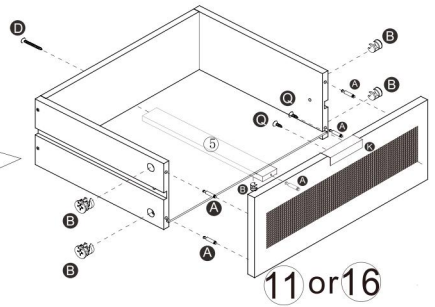
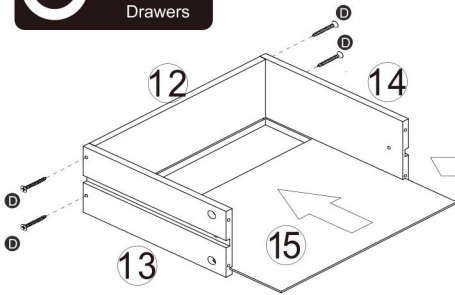

step 2

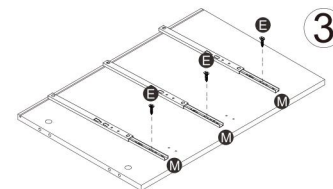
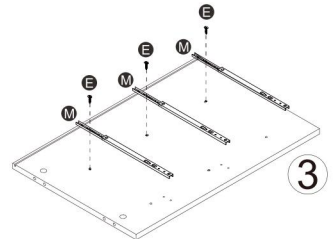
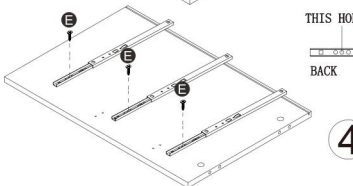
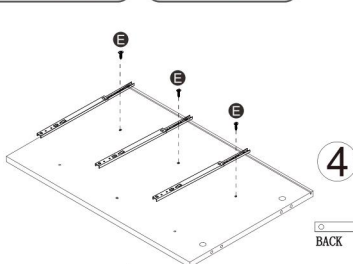
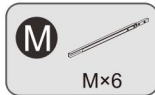

step 3



NOTE: Please pay attention to distinguishing the left and right direction of #6 board. The upper part is the right side to install #6 board, and the lower part is the left side.

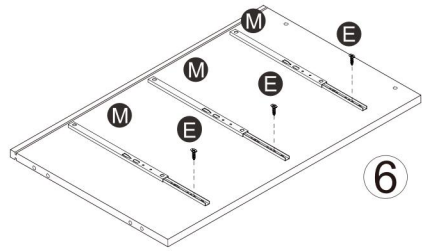
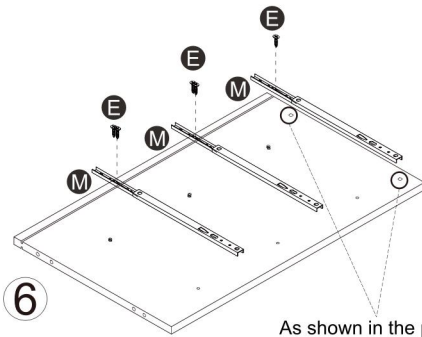
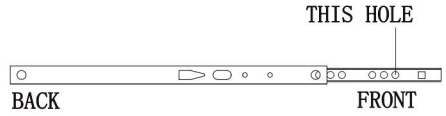

As shown in the picture above, the side of the board with the TWO HOLES is the left side.

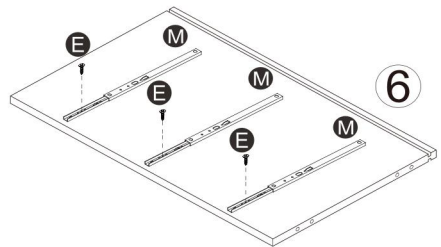
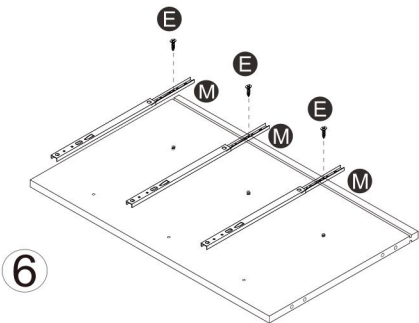
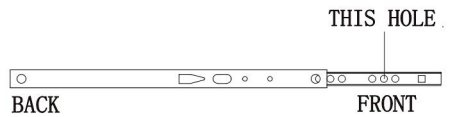

step 4

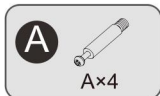

NOTE: In the next steps 4, 5, and 6, please pay attention to distinguish the direction of the board #3 and #4.

The #3 board is installed on the left side of the dresser, and the #4 board is installed on the right side.

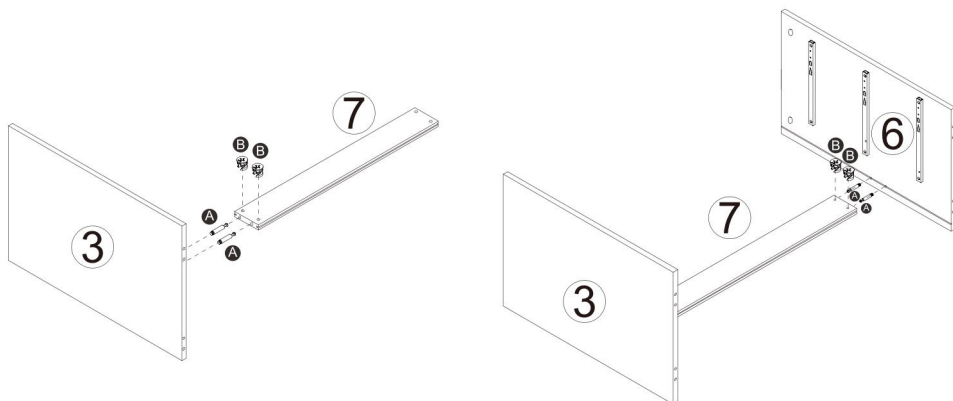

step 5

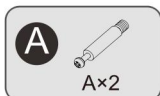

As shown in the picture above, the side of the board with the TWO HOLES is the right side.

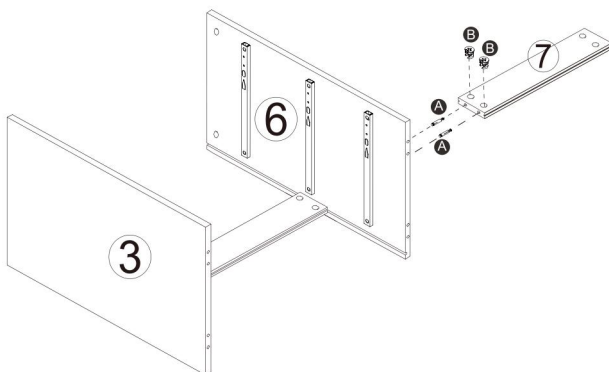

step 6

A



A×2

B



B×2

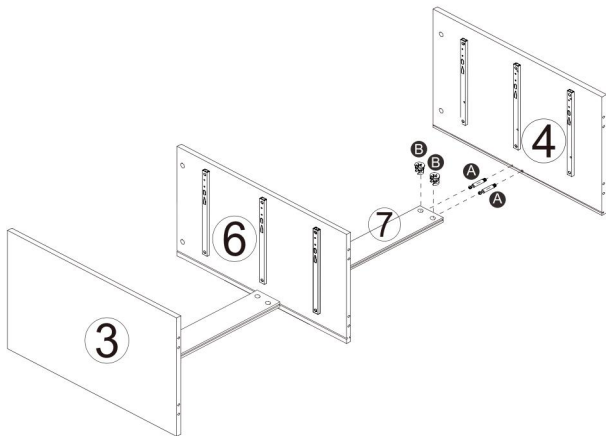

step 7

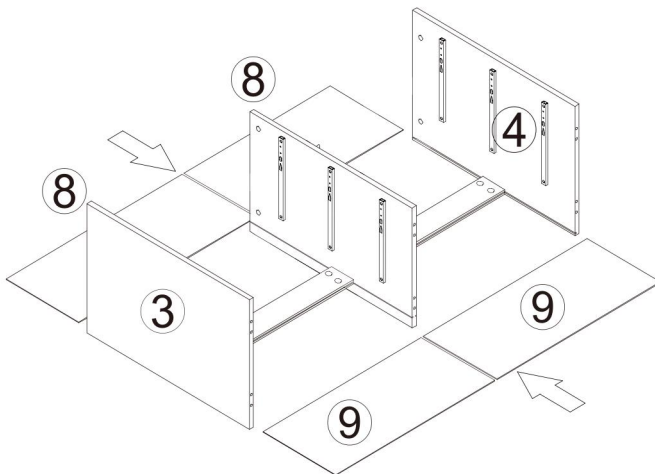

step 8

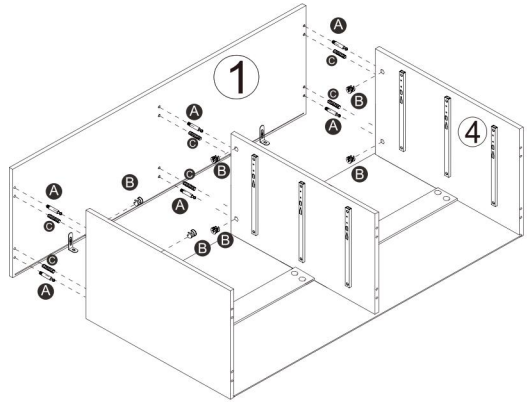
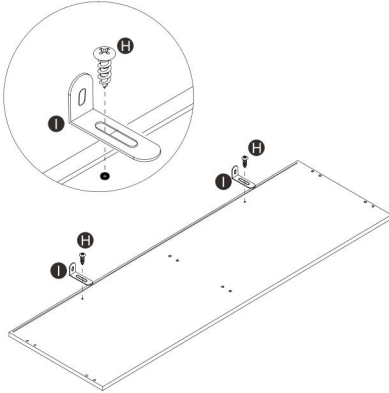
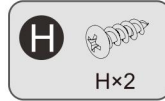

step 9

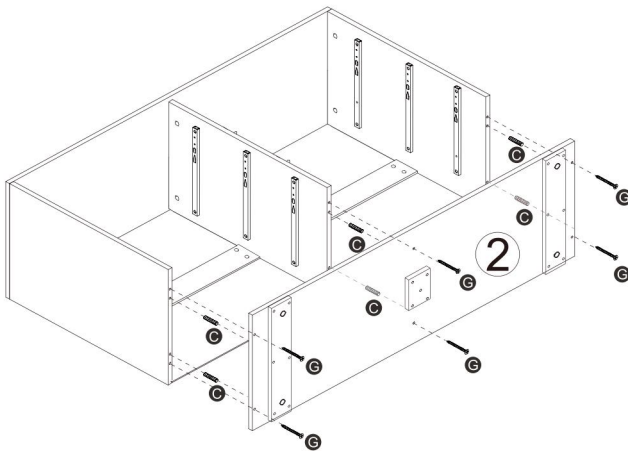

step 10

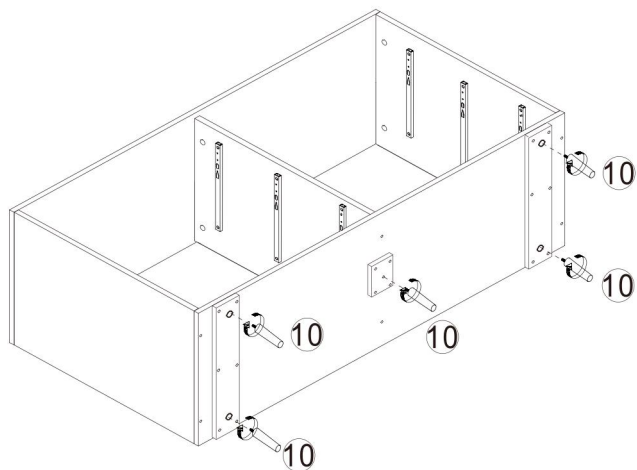

step 11

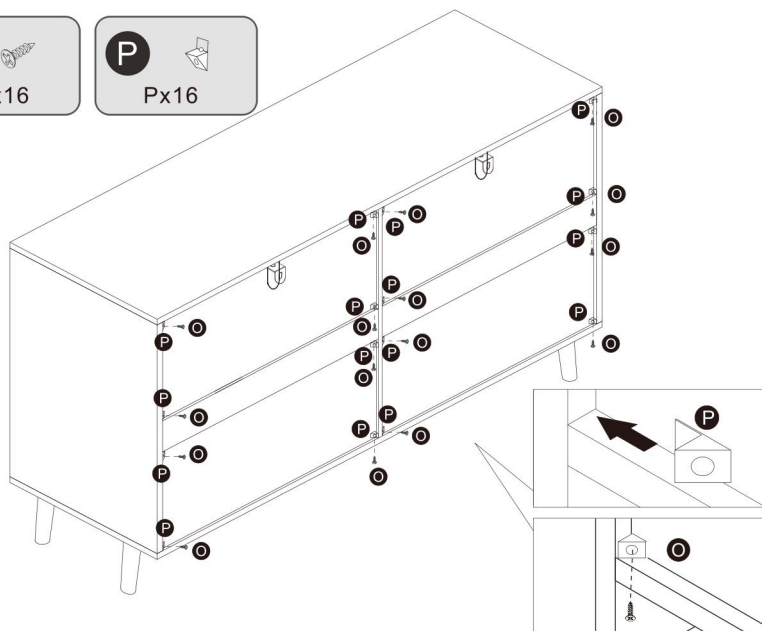

step 12

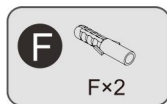

Important Note : Young children can be seriously injured by tipping furniture. You must install the tipping restraint hardware (included) with the unit to prevent the unit from tipping, causing any accidents or damage. The tipping restraints are intended only as a deterrent, they are not substitute for proper adult supervision. The tipping restraints are not earthquake restraints. If you wish to add the extra security of earthquake restraints, they must be purchased and installed separately.

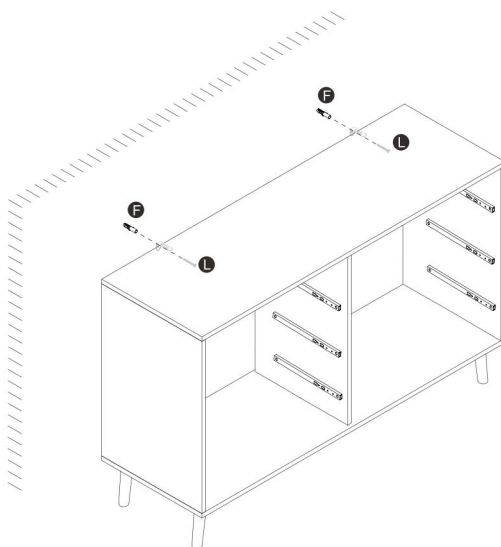

step 13

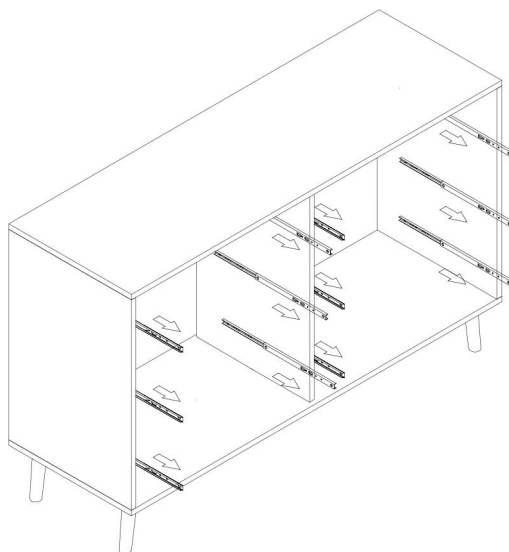

step 14

Note: Please pay attention to distinguishing the left and right directions of the drawer.
The #11 board is on the left side of the drawer, and the #16 board is on the right side.

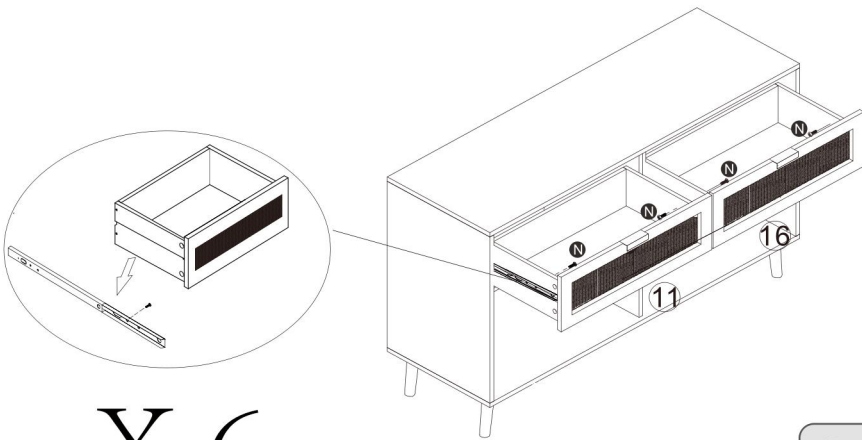

X 6



step 15

Congratulations!!

You have successfully completed the assembly!



COMPLETION



Fabricant : Shanghaimuxinmuyeyouxiangongsi

Adresse : Shuangchenglu 803nong11hao1602A-1609shi, baoshanqu, Shanghai 200000 CN.

Importé en Australie : SIHAO PTY LTD. 1 ROKEVA STREETASTWOOD NSW 2122 Australie

Importé aux États-Unis : Sanven Technology Ltd. Suite 250, 9166 Anaheim Place, Rancho Cucamonga, CA 91730

EC	REP
-----------	------------

E-CrossStu GmbH
Mainzer Landstr.69, 60329 Frankfurt am Main.

UK	REP
-----------	------------

YH CONSULTING LIMITED.
C/O YH Consulting Limited Office 147, Centurion House, London Road, Staines-upon-Thames, Surrey, TW18 4AX

VEVOR[®]

TOUGH TOOLS, HALF PRICE

Technique Assistance et certificat de garantie électronique

www.vevor.com/support

