

VEVOR[®]

TOUGH TOOLS, HALF PRICE

Technical Support and E-Warranty Certificate www.vevor.com/support

SHOWER PANEL TOWER

MODEL:8015FL/6002FL/8039FL/8009FL/8004FL/7009FL

We continue to be committed to provide you tools with competitive price.

"Save Half", "Half Price" or any other similar expressions used by us only represents an estimate of savings you might benefit from buying certain tools with us compared to the major top brands and does not necessarily mean to cover all categories of tools offered by us. You are kindly reminded to verify carefully when you are placing an order with us if you are actually saving half in comparison with the top major brands.

VEVOR®

TOUGH TOOLS, HALF PRICE

SHOWER PANEL TOWER



8015FL

6002FL

8039FL

8009FL

8004FL

7009FL

NEED HELP? CONTACT US!

Have product questions? Need technical support? Please feel free to contact us:

Technical Support and E-Warranty Certificate
www.vevor.com/support

This is the original instruction, please read all manual instructions carefully before operating. VEVOR reserves a clear interpretation of our user manual. The appearance of the product shall be subject to the product you received. Please forgive us that we won't inform you again if there are any technology or software updates on our product.

PRODUCT INTRODUCTION



Warning-To reduce the risk of injury, user must read instructions manual carefully.



CORRECT DISPOSAL

This product is subject to the provision of European Directive 2012/19/EC. The symbol showing a wheellie bin crossed through indicates that the product requires separate refuse collection in the European Union. This applies to the product and all accessories marked with this symbol. Products marked as such may not be discarded with normal domestic waste but must be taken to a collection point for recycling electrical and electronic devices.

Warning Tips:

1. During the installation process, it is best to wear gloves to prevent sharp corners on the panel from scratching the palm of the hand.
2. When installing the shower, ensure that all joints are fully tightened to avoid water leakage.
3. Ensure that the red and blue water inlet pipes inside the panel are in a non folded state to avoid affecting water pressure.
4. When the shower is not in use, please close the switch valve of the shower.



SAVE THESE INSTRUCTIONS

FCC Information

CAUTION: Changes or modifications not expressly approved by the party responsible for compliance could void the user's authority to operate the equipment!

This device complies with Part 15 of the FCC Rules. Operation is subject to the following two conditions:

- 1) This product may cause harmful interference.
- 2) This product must accept any interference received, including interference that may cause undesired operation.

WARNING: Changes or modifications to this product are not expressly approved by the party. Responsibility for compliance could void the user's authority to operate the product.

Note: This product has been tested and found to comply with the limits for a Class B digital device pursuant to Part 15 of the FCC Rules. These limits are designed to provide reasonable protection against harmful interference in a residential installation.



This product generates, uses and can radiate radio frequency energy, and if not installed and used in accordance with the instructions, may cause harmful interference to radio communications. However, there is no guarantee that interference will not occur in a particular installation. If this product does cause harmful interference to radio or television reception, which can be determined by turning the product off and on, the user is encouraged to try to correct the interference by one or more of the following measures.









- Reorient or relocate the receiving antenna.
- Increase the distance between the product and the receiver.
- Connect the product to an outlet on a circuit different from that to which the receiver is connected.
- Consult the dealer or an experienced radio/TV technician for assistance.

INSTALLATION INSTRUCTIONS

Model	8015FL	6002FL	8039FL	8009FL	8004FL	7009FL
Mounting Type	Wall Mount	Wall Mount	Wall Mount	Wall Mount	Wall Mount	Wall Mount
Connection Thread	G1/2"	G1/2"	G1/2"	G1/2"	G1/2"	G1/2"
Functions	Four Modes	Five Modes	Six Modes	Six Modes	Six Modes	Five Modes
Tub Spout	×	√	√	√	√	√
Temperature Display	×	×	√	√	√	√
LED Lamp	×	√	√	√	√	×
Power	×	Dry Cell (DC3V)	Dry Cell (DC3V)	Hydro Power (AC6V)	Hydro Power (AC6V)	Dry Cell (DC3V)
Hand Shower	3-Setting	1-Setting	3-Setting	3-Setting	3-Setting	3-Setting
Finish	Fingerprint-free Brushed Nickel shower system					
Material	Stainless Steel, Brass, PVC, ABS					

PARTS LIST

MODEL		8015FL 8039FL 8009FL	6002FL	8004FL	7009FL
M6 nut		4pcs	4pcs	0pcs	0pcs
M6 * 10 screw		4pcs	4pcs	0pcs	0pcs
Hose Clamp		2pcs	2pcs	2pcs	0pcs
M4 * 10 screw		0pcs	0pcs	2pcs	0pcs
Brass shower arm		0pcs	0pcs	0pcs	1pcs
Single function handheld shower		0pcs	1pcs	0pcs	0pcs
Panel cotton bag		1pcs	1pcs	1pcs	1pcs
Top spray cotton bag		1pcs	1pcs	1pcs	0pcs

MODEL		8015FL 8039FL 8009FL	6002FL	8004FL	7009FL
Three function handheld shower		1pcs	0pcs	1pcs	1pcs
1.5 meter hand spray hose		1pcs	1pcs	1pcs	1pcs
Hand spray seat		1pcs	1pcs	1pcs	1pcs
1/2 right angle adapter		2pcs	2pcs	2pcs	2pcs
4-point rubber		2pcs	2pcs	2pcs	2pcs
Self tapping screw		4pcs	4pcs	4pcs	4pcs
Fastener		2pcs	2pcs	2pcs	2pcs
Grommet		1pcs	1pcs	1pcs	1pcs
Hexagon nut		1pcs	1pcs	1pcs	1pcs

ASSEMBLY INSTRUCTIONS

MODEL 8015FL/6002FL/8039FL/8009FL



1
Insert the PVC pipe from the top opening To pierce out



2
Route the LED light wire along the hole Insert into the motherboard



3
Fix the motherboard and top spray with 4 pairs of M6 screws and nuts



4
Fix the PVC pipe with a throat clamp On the top spray joint

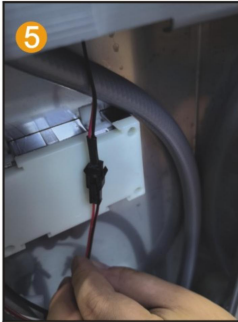

5
Connect the LED light cable and power supplyline



6
Install 2 No. 5 batteries to chargePool box



7
Point the switch of the battery box towards ON



8
Insert the hand spray nozzle into the panel And install the gasket



9
Spray socket with hexagonal nut handle Fixed on the panel

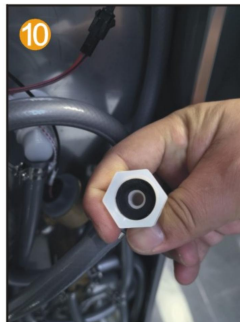

10
Put the 4-point rubber into the hand spray Inside the joint of the seat

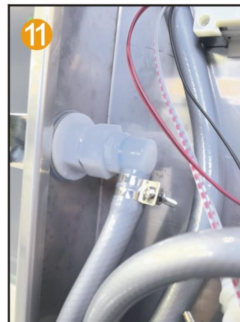

11
Connect the water outlet connector and hand spray Seat joint



12
Connect the hand spray hose to the handheld one shower head

Note: 8015FL don't have steps 2, 5, 6 and 7. 8009FL don't have steps 6 and 7.

MODEL 8004FL

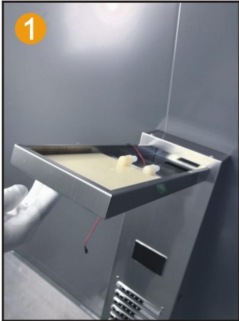

1
Insert the top spray into the motherboard inside the hole



2
Use 2 M4 screws to secure the main Fixed plate and top spray



3
Connect PVC pipes and LED light wires through the hole



4
Fix the PVC pipe with a throat clamp on the top spray joint

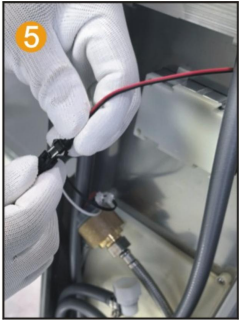

5
Connect the LED light cable and power supply line

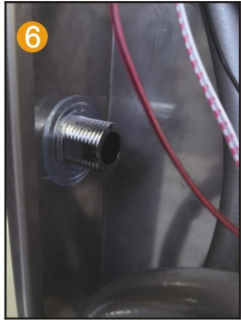

6
Insert the hand spray nozzle into the panel and install the gasket



7
Spray socket with hexagonal nut handle fixed on the panel



8
Spray socket with hexagonal nut handle fixed on the panel and spray it by hand inside the seat

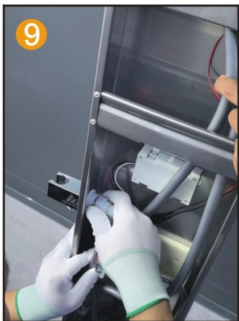

9
Connect the water outlet connector and hand spray hose to the handheld one

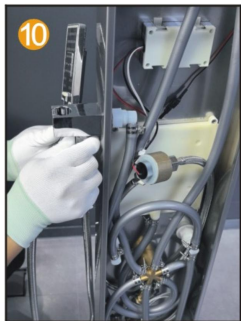

10
Connect the hand spray hose to the handheld shower head

MODEL 7009FL

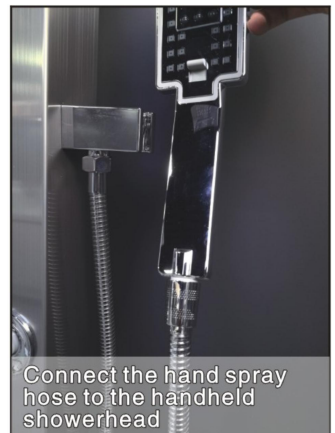
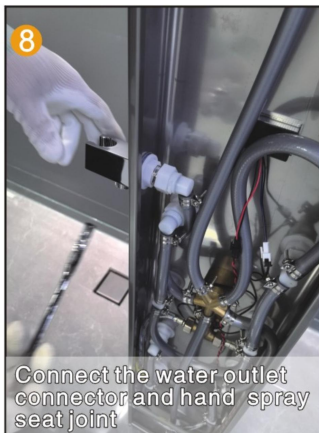
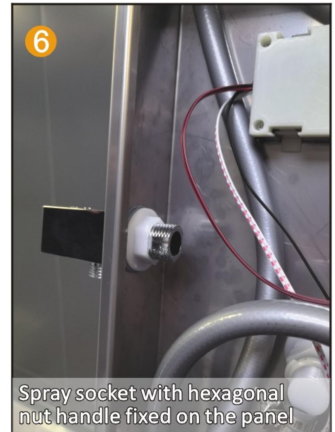
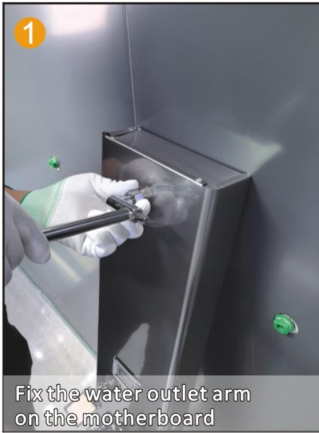

INSTALLATION STEPS (GENERAL)

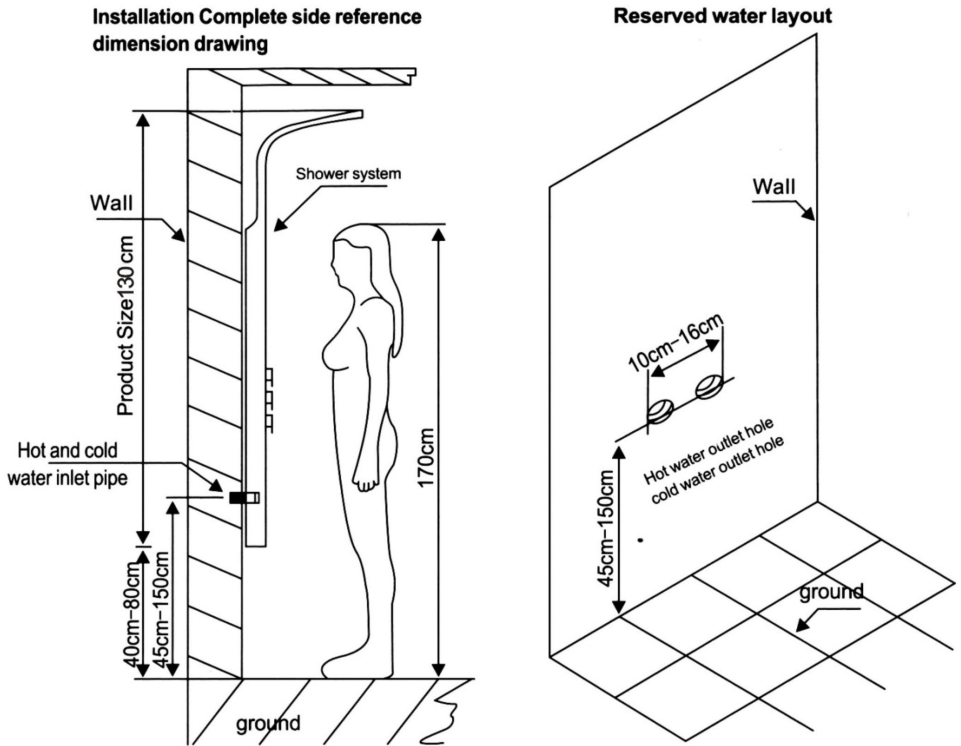

Installation Notes

1. According to the height of the family height budget shower system installation height, measure the shower system on the back of the bar Distance, mark on the wall, in the corresponding position of the tag fixed hanging iron (up and down each one).
2. Connect the hot and cold water hose (be sure to clean the magazine and the dirt in the wall Scale so as not to block, affect the water effect).
3. Shower system hanging on the wall, the upper and lower two cards were clamped in two hanging pastes (Note: shower After the system wall, the main body close to the wall is not shaking, do not need to use another glass glue and other tools fixed).

Stainless steel shower system maintenance methods:

1. Regular cleaning of the product in order to keep its appearance bright and clean;
2. Clean the surface with water or a mild detergent and wipe it with a soft towel.
3. Note that the clean product of the hidden position, timely cleaning can make products lasting.

SHOWER PANEL SERIES INSTALLATION DIAGRAM

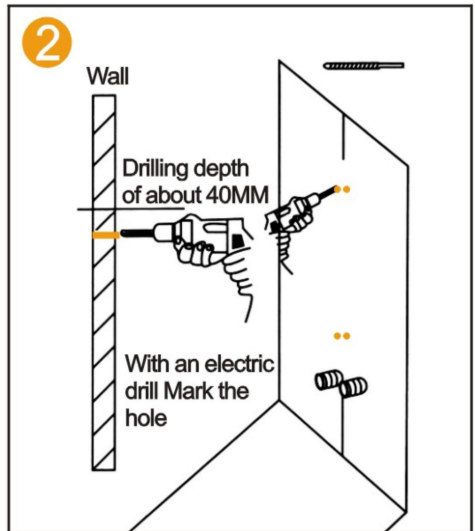
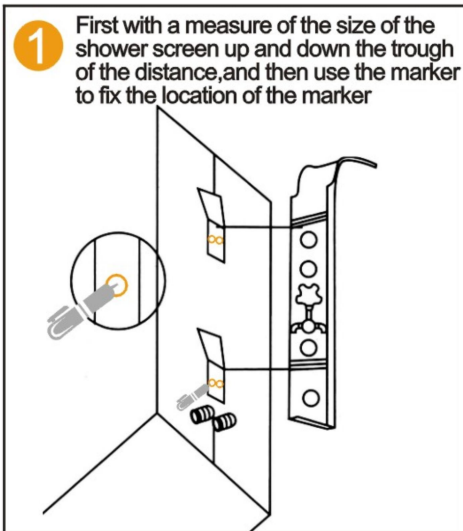

3 First with a hammer will be inflated
Screw into the wall

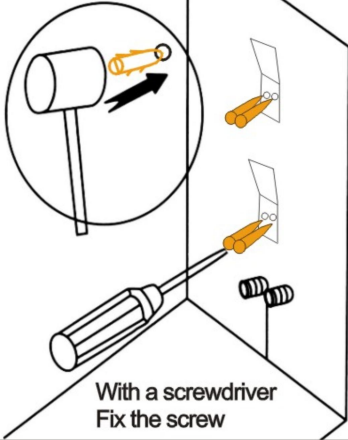

4

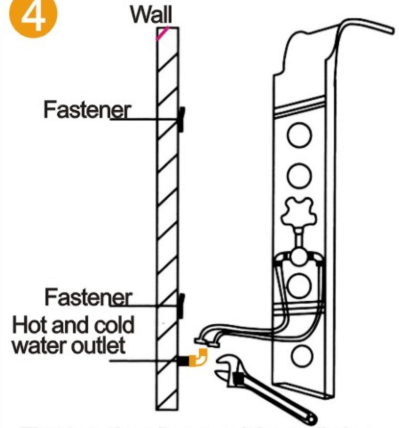

First turn the elbow and the wall pipe connected respectively. And then the hot and cold water pipes and elbows can be connected

5

Hang the shower panel on the fasteners

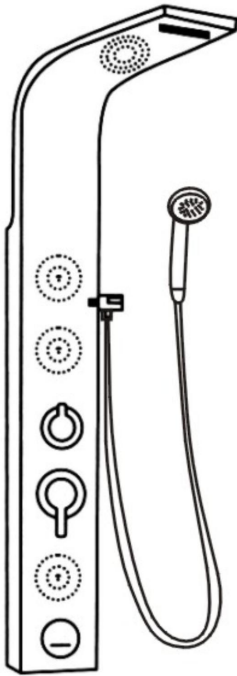

FUNCTION INTRODUCTION

8015FL

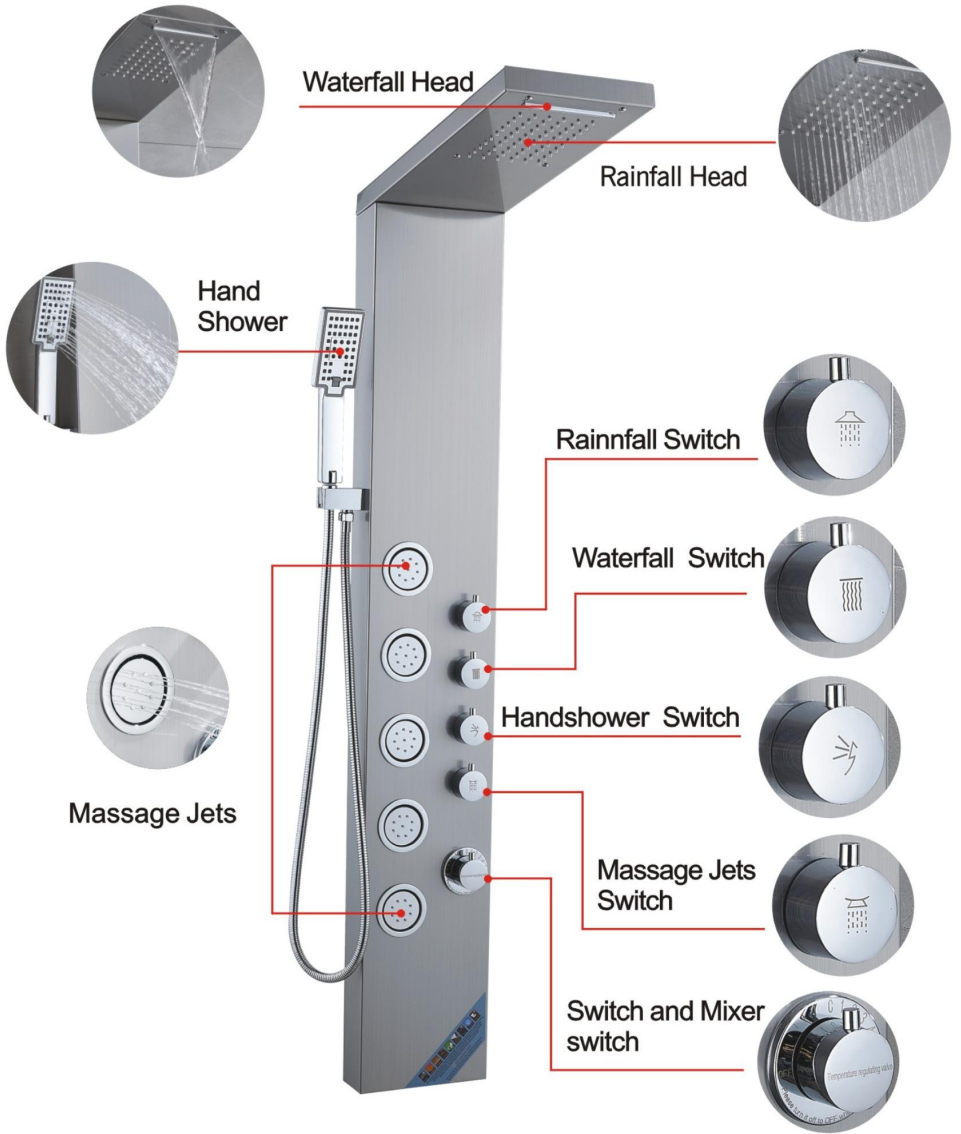

FUNCTION INTRODUCTION

6002FL



FUNCTION INTRODUCTION

8039FL

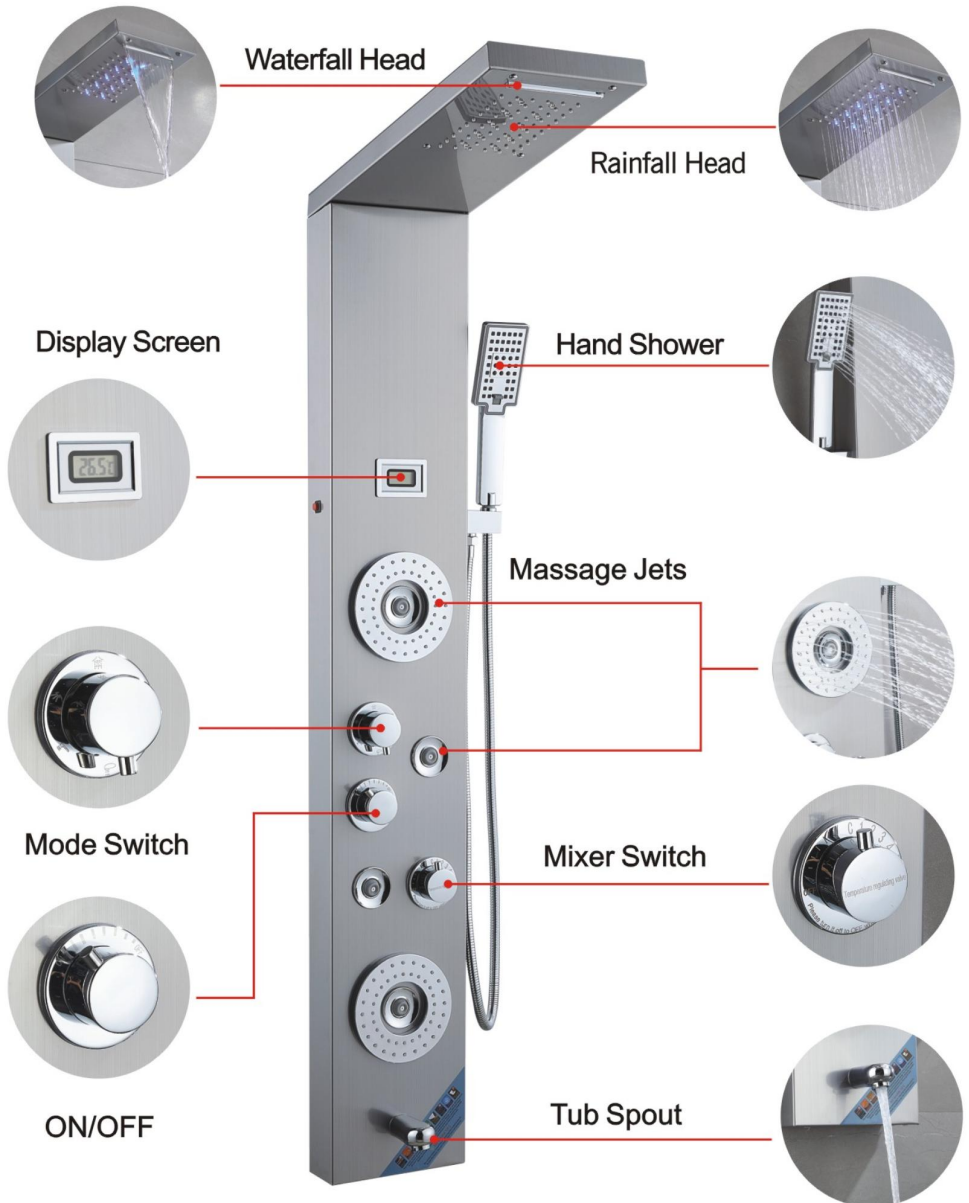

FUNCTION INTRODUCTION

8009FL

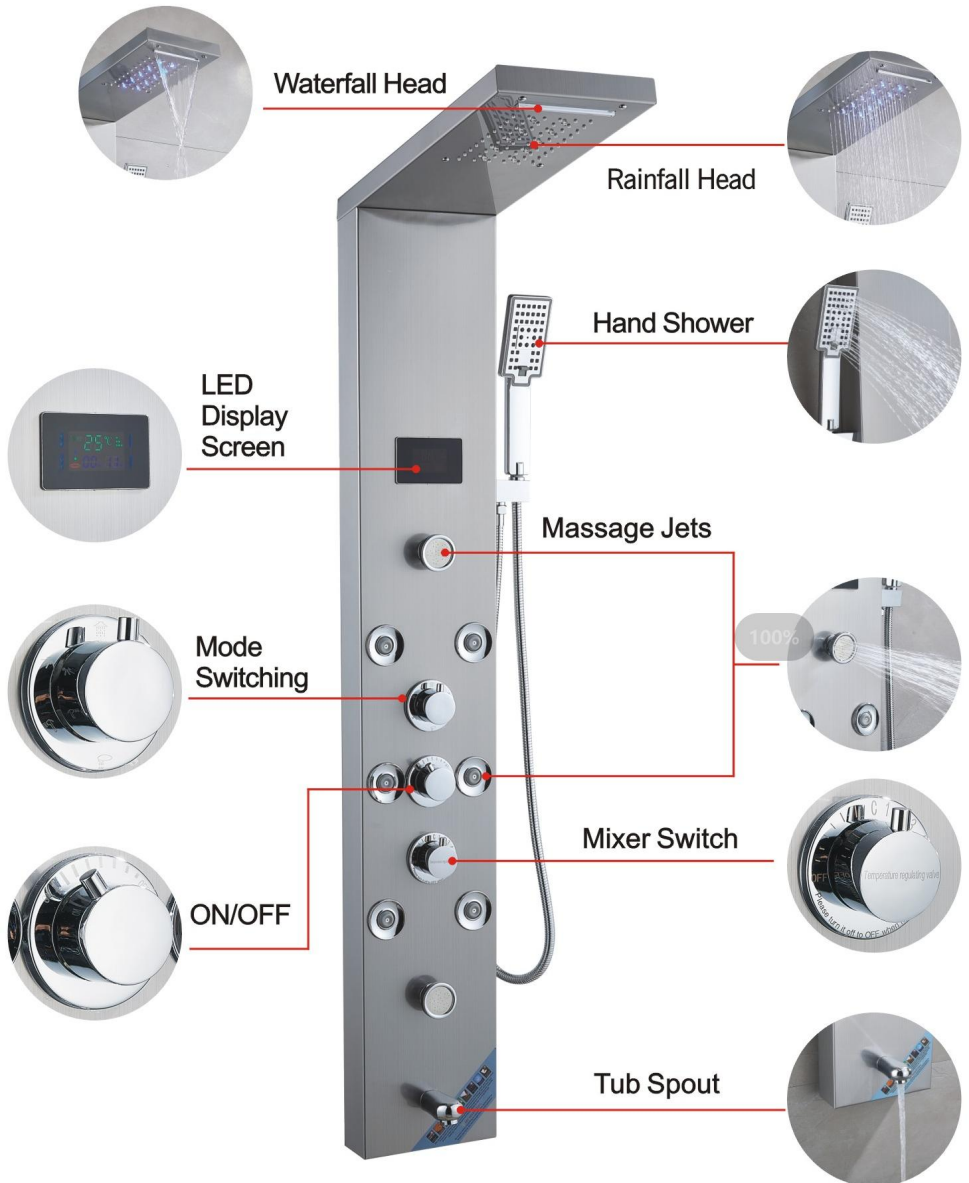

FUNCTION INTRODUCTION

8004FL

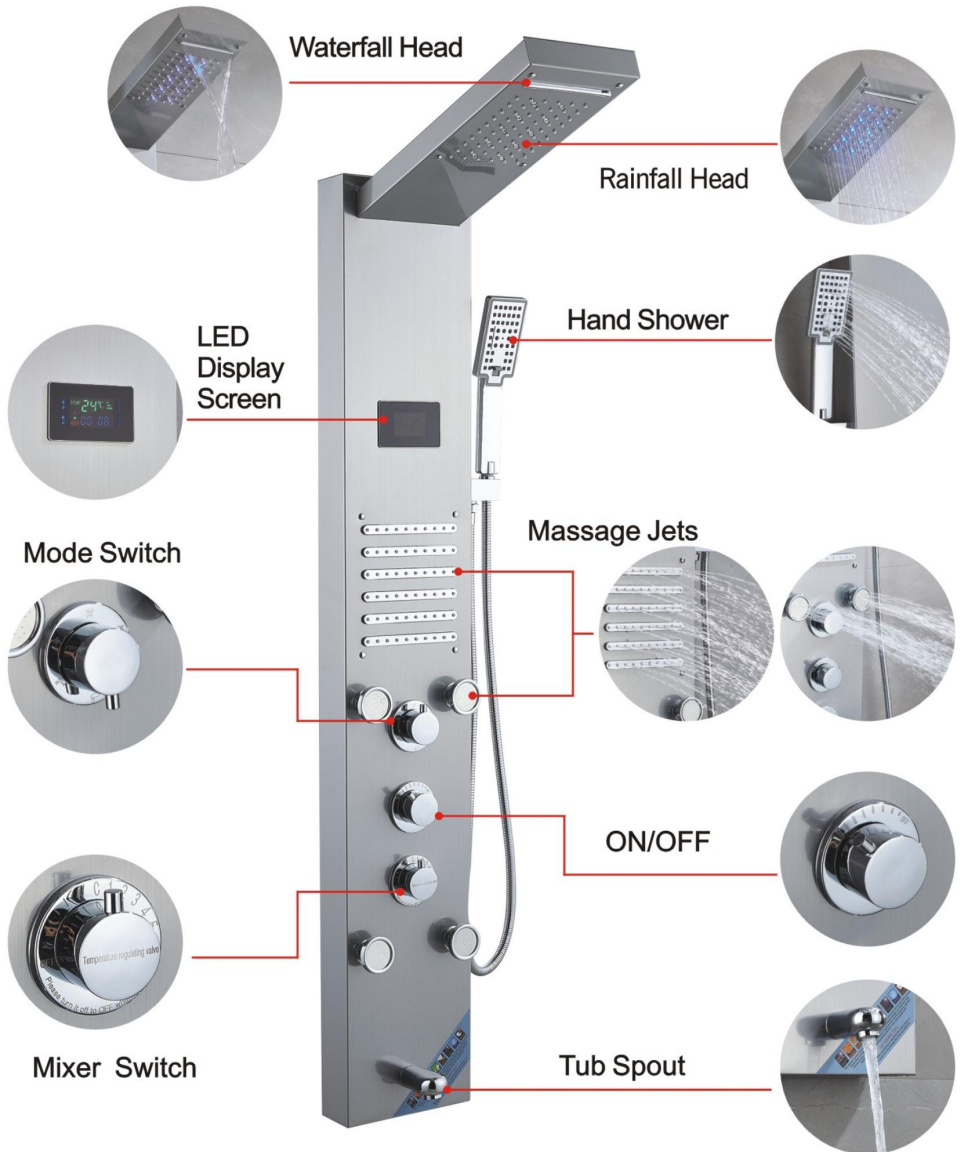

FUNCTION INTRODUCTION

7009FL

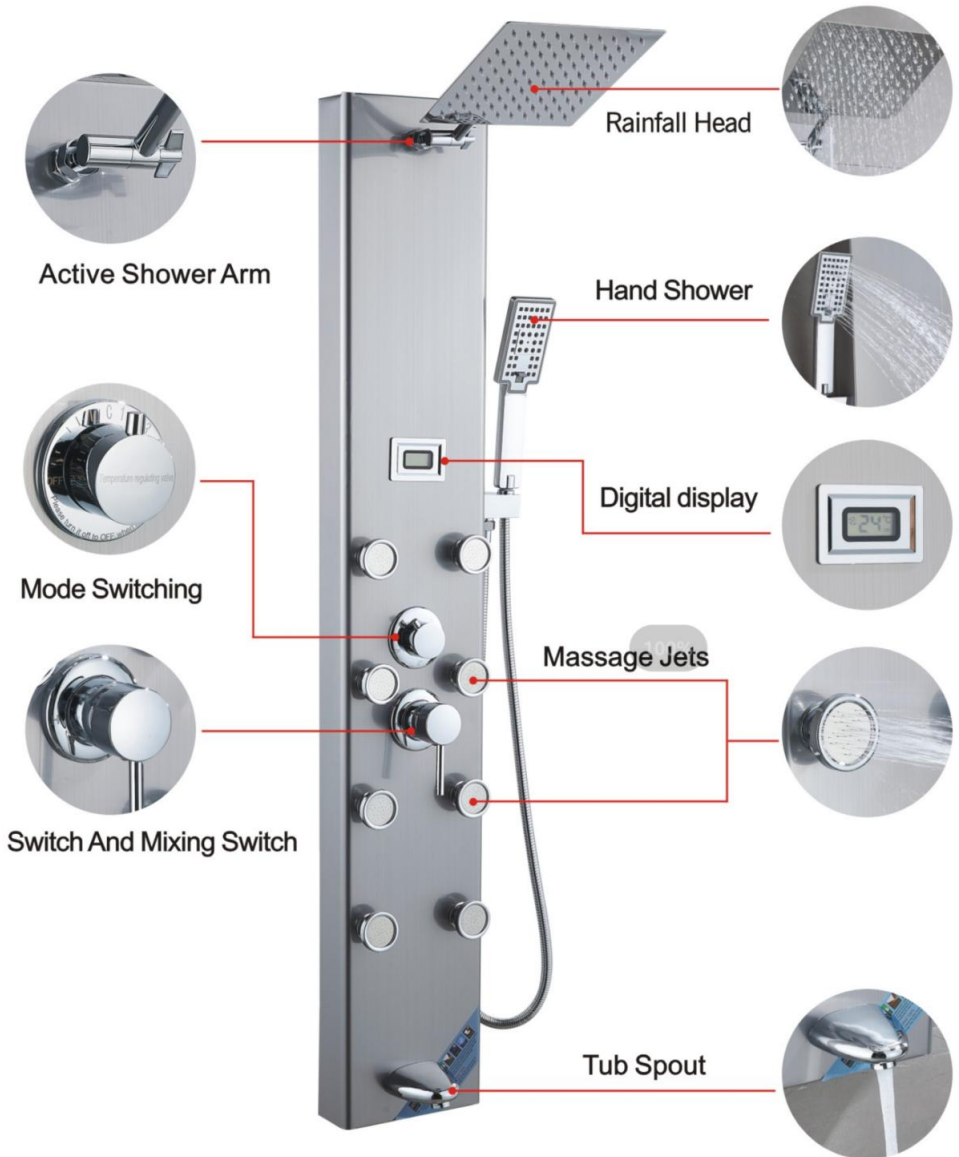

Made In China

VEVOR[®]

TOUGH TOOLS, HALF PRICE

Technical Support and E-Warranty Certificate

www.vevor.com/support

VEVOR[®]

TOUGH TOOLS, HALF PRICE

Assistance technique et certificat de garantie électronique www.vevor.com/support

TOUR DE PANNEAU DE DOUCHE

Modèle : 8015FL/6002FL/8039FL/8009FL/8004FL/7009FL.

Nous continuons à nous engager à vous fournir des outils à des prix compétitifs.

"Économisez la moitié", "Moitié prix" ou toute autre expression similaire que nous utilisons ne représente qu'une estimation des économies dont vous pourriez bénéficier en achetant certains outils chez nous par rapport aux grandes marques et ne signifie pas nécessairement couvrir toutes les catégories d'outils proposés. par nous.

Nous vous rappelons de bien vouloir vérifier attentivement lorsque vous passez une commande chez nous si vous économisez réellement la moitié par rapport aux grandes marques.

VEVOR[®]

TOUGH TOOLS, HALF PRICE

TOUR DE PANNEAU DE DOUCHE



8015FL



6002FL



8039FL



8009FL



8004FL



7009FL



BESOIN D'AIDE? CONTACTEZ-NOUS!

Vous avez des questions sur les produits ? Besoin d'une assistance technique ? N'hésitez pas à Contactez-nous:

Assistance technique et certificat de garantie électronique
www.vevor.com/support

Ceci est l'instruction originale, veuillez lire toutes les instructions du manuel soigneusement avant de l'utiliser. VEVOR se réserve une interprétation claire de nos Manuel de l'Utilisateur. L'apparence du produit est soumise aux produit que vous avez reçu. Veuillez pardonner, nous ne vous informerons plus si il existe des mises à jour technologiques ou logicielles sur notre produit.

PRÉSENTATION DU PRODUIT

	<p>Avertissement : Pour réduire le risque de blessure, l'utilisateur doit lire les instructions manuel avec soin.</p>
	<p>ÉLIMINATION CORRECTE</p> <p>Ce produit est soumis aux dispositions de la directive européenne 2012/19/CE. Le symbole représentant une poubelle barrée à travers indique que le produit nécessite des déchets séparés collection dans l'Union européenne. Ceci s'applique au produit et tous les accessoires marqués de ce symbole. Produits marqués en tant que tel, il ne peut pas être jeté avec les ordures ménagères normales, mais doivent être déposés dans un point de collecte pour le recyclage des appareils électriques et appareils électroniques.</p>

Conseils d'avertissement :

1. Pendant le processus d'installation, il est préférable de porter des gants pour éviter les objets tranchants. coins du panneau pour éviter de rayer la paume de la main.
2. Lors de l'installation de la douche, assurez-vous que tous les joints sont entièrement serré pour éviter les fuites d'eau.
3. Assurez-vous que les tuyaux d'entrée d'eau rouge et bleu à l'intérieur du panneau ne sont pas État plié pour éviter d'affecter la pression de l'eau.
4. Lorsque la douche n'est pas utilisée, veuillez fermer le robinet de commutation de la douche.



CONSERVEZ CES INSTRUCTIONS

Informations FCC

ATTENTION : Changements ou modifications non expressément approuvés par la partie responsable de la conformité pourraient annuler le droit de l'utilisateur à utiliser le équipement!

Cet appareil est conforme à la partie 15 des règles FCC. L'exploitation est soumise aux suivant deux conditions :

- 1) Ce produit peut provoquer des interférences nuisibles.
- 2) Ce produit doit accepter toute interférence reçue, y compris les interférences qui peut provoquer un fonctionnement indésirable.

AVERTISSEMENT : les changements ou modifications apportés à ce produit ne sont pas expressément approuvés par le parti. La responsabilité de la conformité pourrait annuler le pouvoir de l'utilisateur de faire fonctionner le produit.

Remarque : Ce produit a été testé et jugé conforme aux limites d'une classe

Appareil numérique B conformément à la partie 15 des règles de la FCC. Ces limites sont conçues pour fournir une protection raisonnable contre les interférences nuisibles dans un environnement résidentiel installation.

Ce produit génère, utilise et peut émettre de l'énergie radiofréquence, et sinon installé et utilisé conformément aux instructions, peut causer des dommages interférence avec les communications radio. Cependant, rien ne garantit que aucune interférence ne se produira dans une installation particulière. Si ce produit provoque interférences nuisibles à la réception radio ou télévision, qui peuvent être déterminées par en éteignant et en allumant le produit, l'utilisateur est encouragé à essayer de corriger le interférence par une ou plusieurs des mesures suivantes.









- Réorientez ou déplacez l'antenne de réception.
- Augmentez la distance entre le produit et le récepteur.
- Connectez le produit à une prise sur un circuit différent de celui auquel le le récepteur est connecté.
- Consultez le revendeur ou un technicien radio/TV expérimenté pour obtenir de l'aide.

INSTRUCTIONS D'INSTALLATION

Modèle	8015FL 6002	FL 8039FL 8009	FL 8004FL 7009	FL		
Montage	Mur	Mur	Mur	Mur	Mur	Mur
Taper	Monter	Monter	Monter	Monter	Monter	Monter
Connexion	G1/2"	G1/2"	G1/2"	G1/2"	G1/2"	G1/2"
Fil						
Les fonctions	Quatre Modes	Cinq Modes	Six Modes	Six Modes	Six Modes	Cinq Modes
Bec de baignoire	x	√	√	√	√	√
Température	x	x	√	√	√	√
e Affichage						
Lampe à LED	x	√	√	√	√	x
Pouvoir	x	Pile sèche (DC3V)	Pile sèche (DC3V)	Hydroélectricité Pouvoir (AC6V)	Hydroélectricité Pouvoir (AC6V)	Pile sèche (DC3V)
Main Douche	3 réglages	1 réglage	3 réglages	3 réglages	3 réglages	3 réglages
Finition	Système de douche en nickel brossé sans empreintes digitales					
Matériel	Acier inoxydable, laiton, PVC, ABS					

LISTE DES PIÈCES

MODEL		8015FL 8039FL 8009FL	6002FL	8004FL	7009FL
M6 nut		4pcs	4pcs	0pcs	0pcs
M6 * 10 screw		4pcs	4pcs	0pcs	0pcs
Hose Clamp		2pcs	2pcs	2pcs	0pcs
M4 * 10 screw		0pcs	0pcs	2pcs	0pcs
Brass shower arm		0pcs	0pcs	0pcs	1pcs
Single function handheld shower		0pcs	1pcs	0pcs	0pcs
Panel cotton bag		1pcs	1pcs	1pcs	1pcs
Top spray cotton bag		1pcs	1pcs	1pcs	0pcs

MODEL		8015FL 8039FL 8009FL	6002FL	8004FL	7009FL
Three function handheld shower		1pcs	0pcs	1pcs	1pcs
1.5 meter hand spray hose		1pcs	1pcs	1pcs	1pcs
Hand spray seat		1pcs	1pcs	1pcs	1pcs
1/2 right angle adapter		2pcs	2pcs	2pcs	2pcs
4-point rubber		2pcs	2pcs	2pcs	2pcs
Self tapping screw		4pcs	4pcs	4pcs	4pcs
Fastener		2pcs	2pcs	2pcs	2pcs
Grommet		1pcs	1pcs	1pcs	1pcs
Hexagon nut		1pcs	1pcs	1pcs	1pcs

INSTRUCTIONS DE MONTAGE

MODÈLE 8015FL/6002FL/8039FL/8009FL



1
Insert the PVC pipe from the top opening To pierce out



2
Route the LED light wire along the hole Insert into the motherboard



3
Fix the motherboard and top spray with 4 pairs of M6 screws and nuts

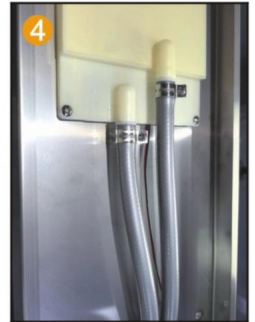

4
Fix the PVC pipe with a throat clamp On the top spray joint

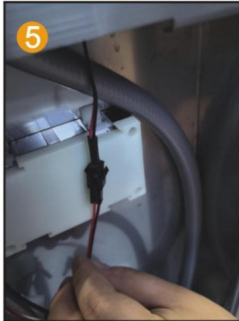

5
Connect the LED light cable and power supplyline



6
Install 2 No. 5 batteries to charge Pool box



7
Point the switch of the battery box towards ON



8
Insert the hand spray nozzle into the panel And install the gasket



9
Spray socket with hexagonal nut handle Fixed on the panel

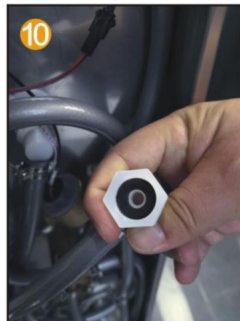

10
Put the 4-point rubber into the hand spray Inside the joint of the seat

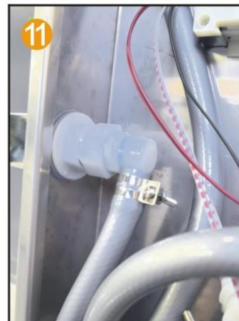

11
Connect the water outlet connector and hand spray Seat joint



12
Connect the hand spray hose to the handheld one shower head

Remarque : le 8015FL n'a pas les étapes 2, 5, 6 et 7. Le 8009FL n'a pas les étapes 6 et 7.

MODÈLE 8004FL

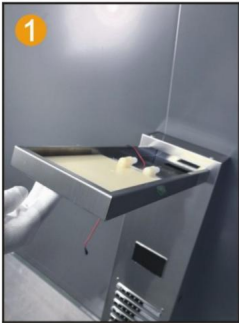

1
Insert the top spray into the motherboard inside the hole



2
Use 2 M4 screws to secure the main fixed plate and top spray



3
Connect PVC pipes and LED light wires through the hole



4
Fix the PVC pipe with a throat clamp on the top spray joint

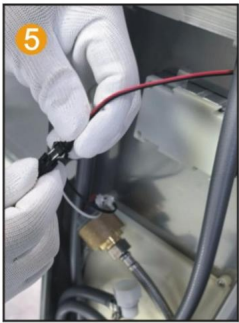

5
Connect the LED light cable and power supply line

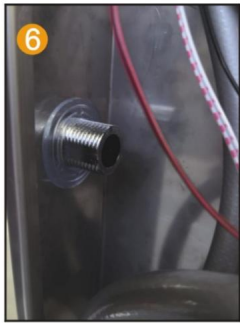

6
Insert the hand spray nozzle into the panel and install the gasket



7
Spray socket with hexagonal nut handle fixed on the panel



8
Spray socket with hexagonal nut handle. Fix the 4-point rubber on the panel and spray it by hand inside the seat joint

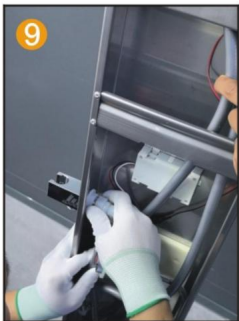

9
Connect the water outlet connector and hand spray seat joint

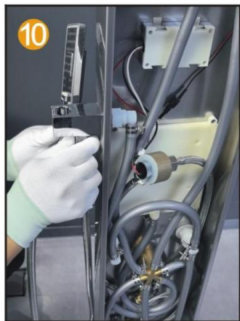

10
Connect the hand spray hose to the handheld shower head

MODÈLE 7009FL

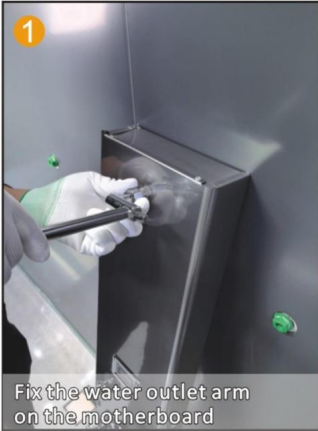

Fix the water outlet arm on the motherboard



Connect the top spray and outlet arm joints

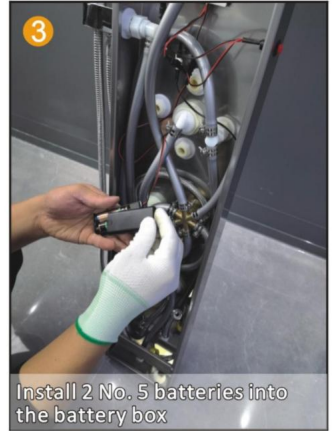

Install 2 No. 5 batteries into the battery box



Turn the switch of the battery box to ON



Insert the hand spray nozzle into the panel and install the gasket

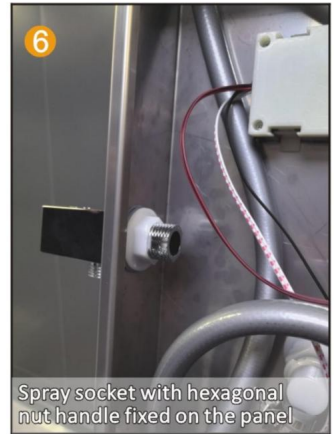

Spray socket with hexagonal nut handle fixed on the panel



Put the 4-cent eraser inside the joint of the hand spray seat



Connect the water outlet connector and hand spray seat joint

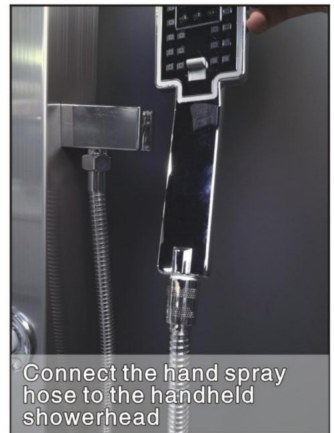

Connect the hand spray hose to the handheld showerhead

ÉTAPES D'INSTALLATION (GÉNÉRAL)

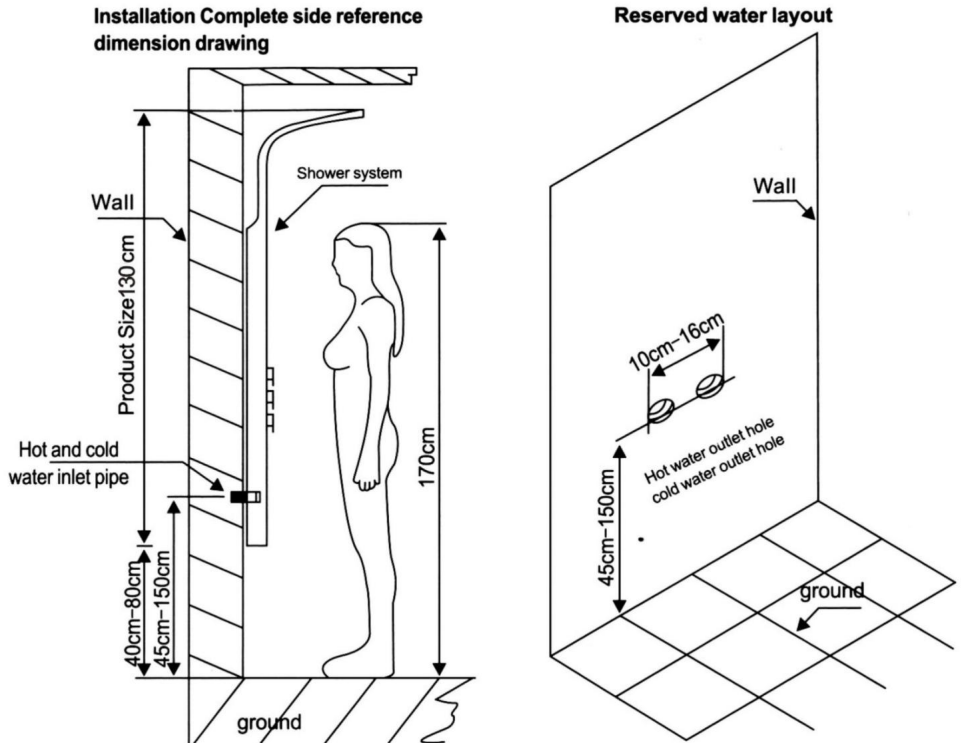

Notes d'installation

1. En fonction de la hauteur d'installation du système de douche économique, mesurez le système de douche à l'arrière de la barre, marquez sur le mur, dans la position correspondante de l'étiquette du fer de suspension fixe (de haut en bas chacun) .
2. Connectez le tuyau d'eau chaude et froide (assurez-vous de nettoyer le chargeur et la saleté dans la balance murale afin de ne pas bloquer, affecter l'effet de l'eau).
3. Système de douche accroché au mur, les deux cartes supérieures et inférieures ont été serrées dans deux pâtes suspendues (Remarque : douche après le mur du système, le corps principal près du mur ne tremble pas, il n'est pas nécessaire d'utiliser une autre colle à verre et autres outils corrigés).

Méthodes d'entretien du système de douche en acier inoxydable :

1. Nettoyage régulier du produit afin de conserver son aspect brillant et

faire le ménage:

2. Nettoyez la surface avec de l'eau ou un détergent doux et essuyez-la avec une serviette douce.
3. Notez que le produit propre de la position cachée, un nettoyage rapide peut faire produits durables.

SCHÉMA D'INSTALLATION DE LA SÉRIE DE PANNEAU DE DOUCHE

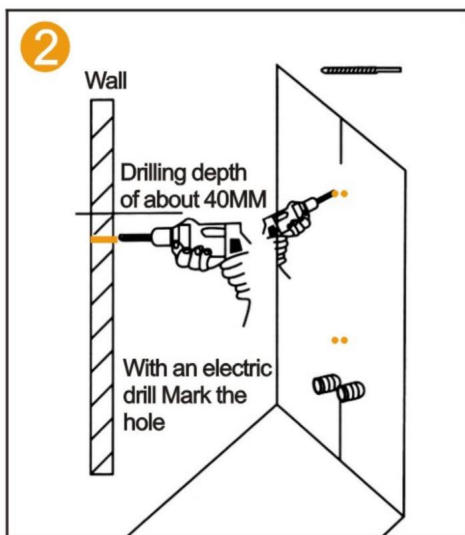
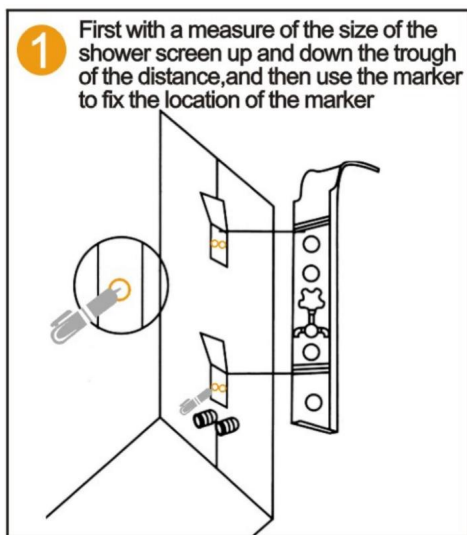

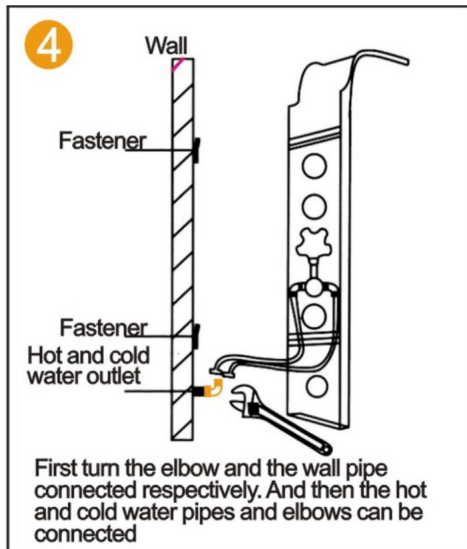
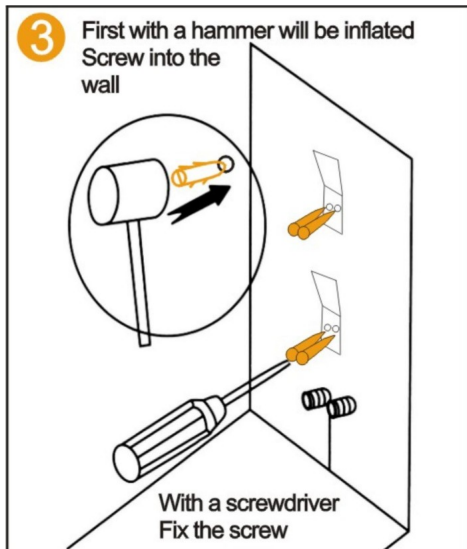

INTRODUCTION DES FONCTIONS

8015FL

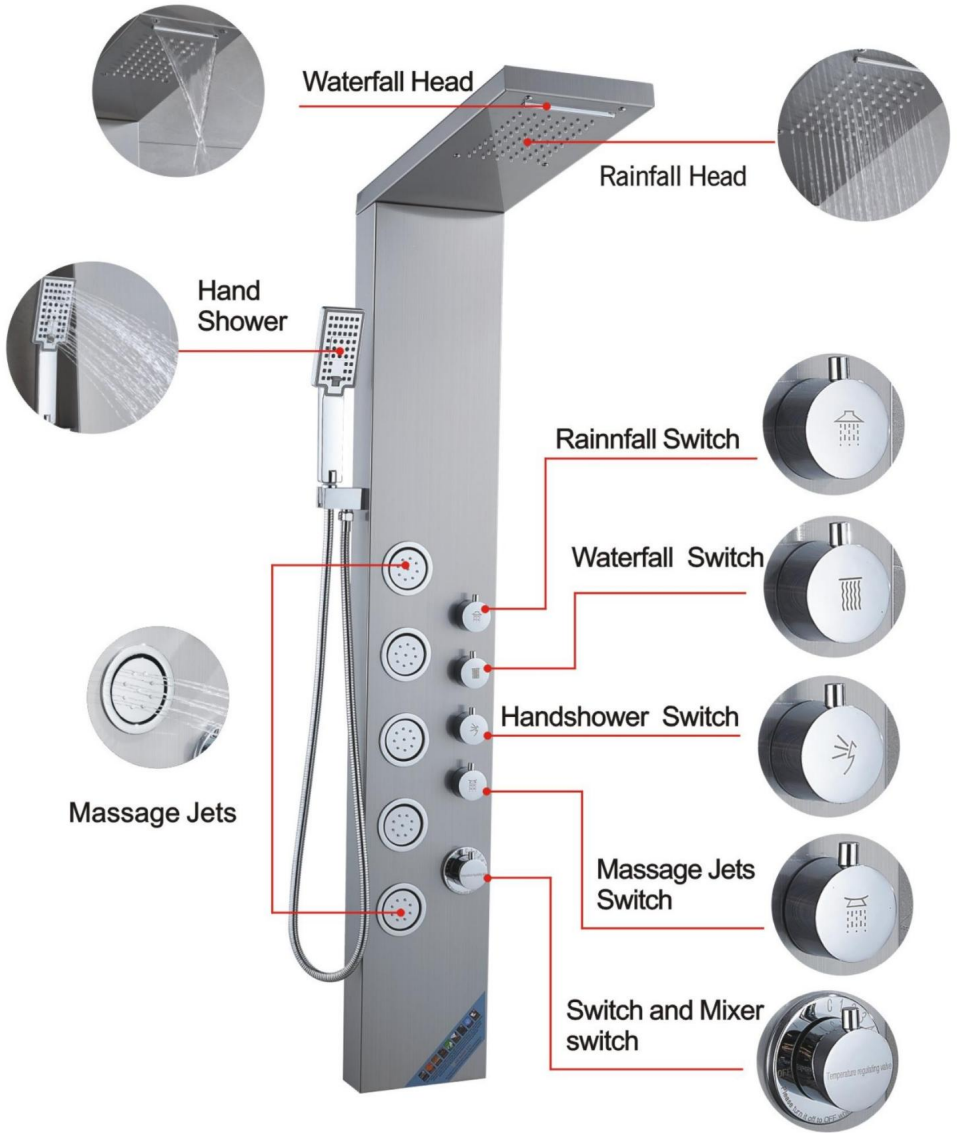

INTRODUCTION DES FONCTIONS

6002FL



INTRODUCTION DES FONCTIONS

8039FL

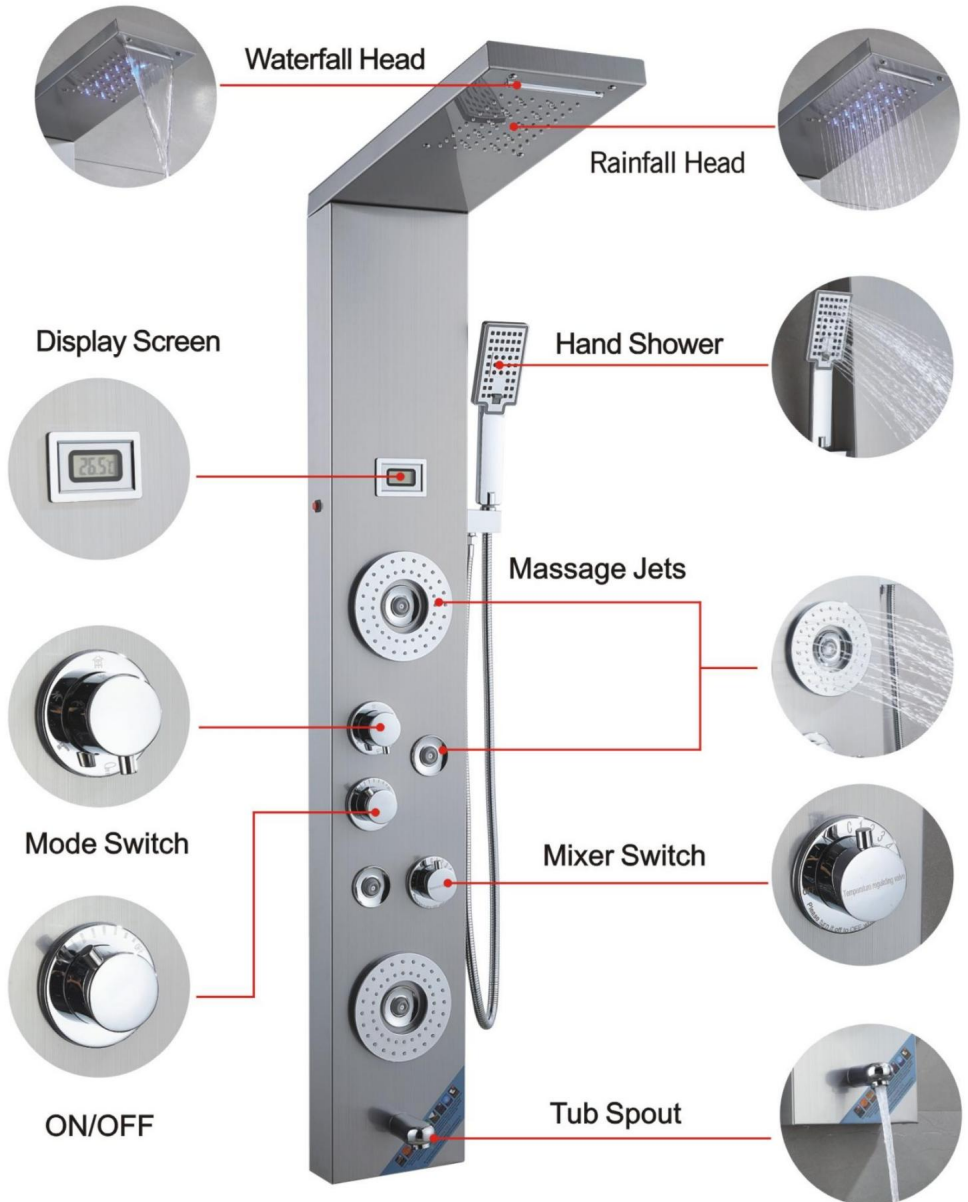

INTRODUCTION DES FONCTIONS

8009FL

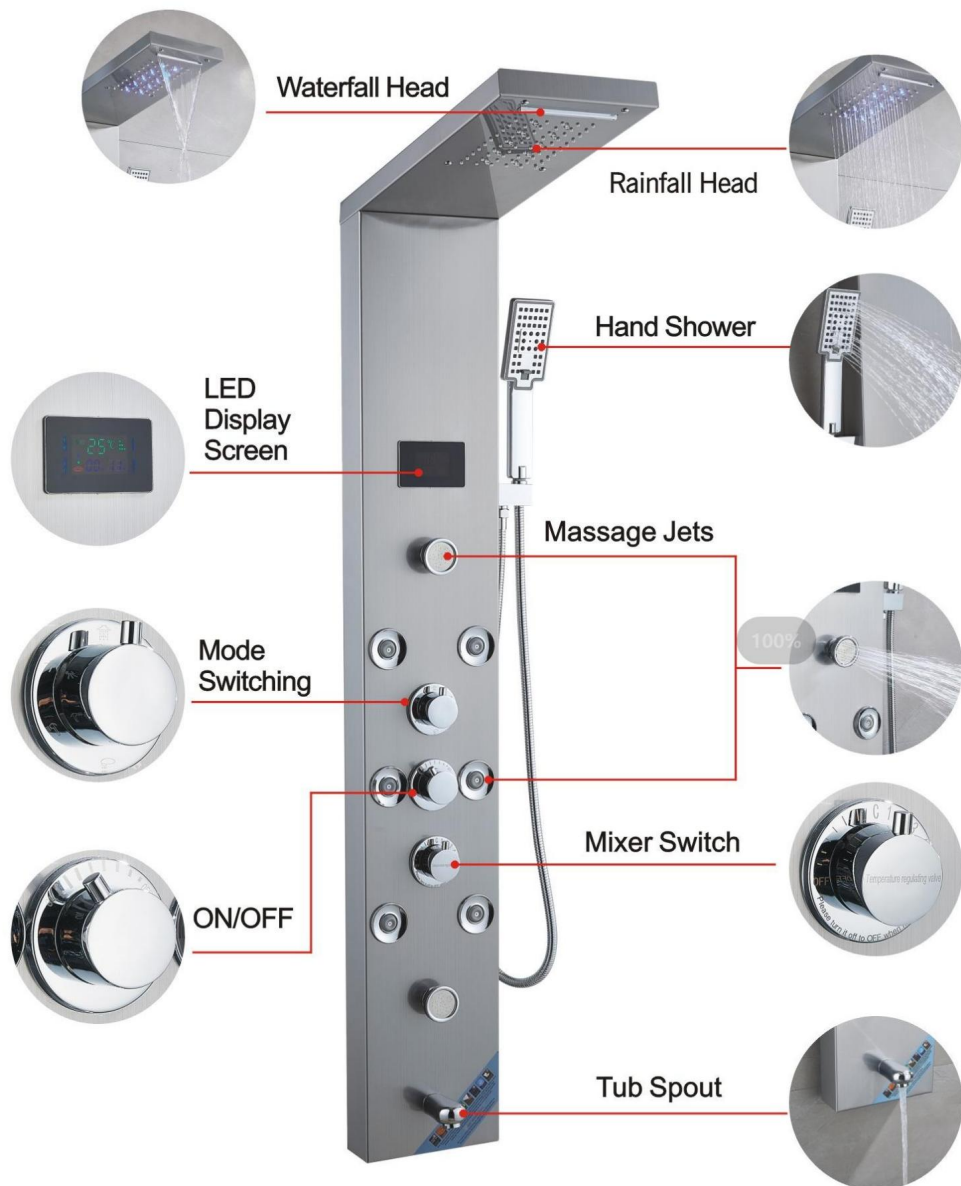

INTRODUCTION DES FONCTIONS

8004FL



INTRODUCTION DES FONCTIONS

7009FL

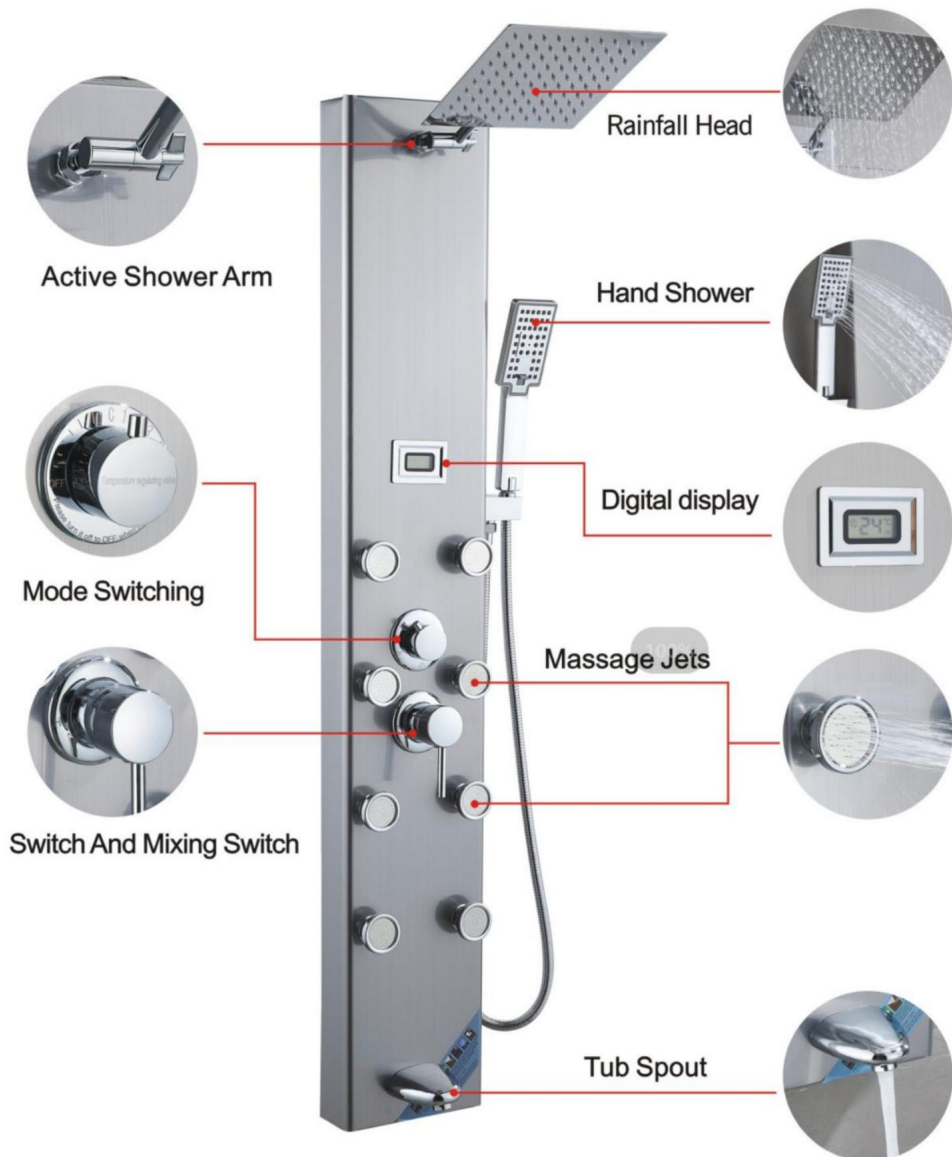

VEVOR[®]

TOUGH TOOLS, HALF PRICE

Assistance technique et certificat de garantie
électronique www.vevor.com/support

VEVOR[®]

TOUGH TOOLS, HALF PRICE

Technischer Support und E-Garantiezertifikat www.vevor.com/support

DUSCHPANEELTURM

MODELL:8015FL/6002FL/8039FL/8009FL/8004FL/7009FL

Wir sind weiterhin bestrebt, Ihnen Werkzeuge zu wettbewerbsfähigen Preisen anzubieten.

„Sparen Sie die Hälfte“, „Halber Preis“ oder andere ähnliche von uns verwendete Ausdrücke stellen lediglich eine Schätzung der Einsparungen dar, die Sie durch den Kauf bestimmter Werkzeuge bei uns im Vergleich zu den großen Top-Marken erzielen könnten, und bedeuten nicht unbedingt, dass alle angebotenen Werkzeugkategorien abgedeckt werden von uns. Bitte prüfen Sie bei Ihrer Bestellung sorgfältig, ob Sie im Vergleich zu den Top-Marken tatsächlich die Hälfte sparen.

VEVOR®

TOUGH TOOLS, HALF PRICE

DUSCHPANEELTUM



8015FL

6002FL

8039FL

8009FL

8004FL

7009FL

BRAUCHEN SIE HILFE? KONTAKTIERE UNS!

Haben Sie Fragen zum Produkt? Benötigen Sie technische Unterstützung? Bitte zögern Sie nicht kontaktiere uns:

Zertifikat für technischen Support und E-Garantie
www.vevor.com/support

Dies ist die Originalanleitung. Bitte lesen Sie alle manuellen Anweisungen vor dem Betrieb sorgfältig durch. VEVOR behält sich eine klare Interpretation unserer vor Benutzerhandbuch. Das Aussehen des Produkts unterliegt dem Produkt, das Sie erhalten haben. Bitte entschuldigen Sie, dass wir Sie nicht erneut informieren, wenn Es gibt Technologie- oder Software-Updates für unser Produkt.

PRODUKTEINFÜHRUNG



Warnung: Um das Verletzungsrisiko zu verringern, muss der Benutzer die Anweisungen lesen

Lesen Sie die Bedienungsanleitung sorgfältig durch.



RICHTIGE ENTSORGUNG

Dieses Produkt unterliegt den Bestimmungen der europäischen Richtlinie

2012/19/EG. Das Symbol einer durchgestrichenen Mülltonne

Durch bedeutet, dass das Produkt getrennt entsorgt werden muss

Sammlung in der Europäischen Union. Dies gilt für das Produkt

und alle mit diesem Symbol gekennzeichneten Zubehörteile. Produkte gekennzeichnet

Daher dürfen sie nicht mit dem normalen Hausmüll entsorgt werden

müssen zu einer Sammelstelle für das Recycling von Elektro- und Elektronikgeräten gebracht werden
elektronische Geräte.

Warnhinweise:

1. Während des Installationsvorgangs ist es am besten, Handschuhe zu tragen, um scharfe Kanten zu vermeiden
Ecken des Panels vor Kratzern auf der Handfläche.
2. Achten Sie beim Einbau der Dusche darauf, dass alle Fugen vollständig sind
festgezogen, um ein Austreten von Wasser zu verhindern.
3. Stellen Sie sicher, dass die roten und blauen Wassereinflussleitungen im Inneren des Panels nicht miteinander verbunden sind
zusammengeklappten Zustand, um eine Beeinträchtigung des Wasserdrucks zu vermeiden.
4. Wenn die Dusche nicht benutzt wird, schließen Sie bitte das Umschaltventil der Dusche.



ANLEITUNG AUFBEWAHREN

FCC-Informationen

ACHTUNG: Änderungen oder Modifikationen, die nicht ausdrücklich von der Partei genehmigt wurden Verantwortlich für die Einhaltung kann die Berechtigung des Benutzers zum Betrieb des Geräts erlöschen Ausrüstung!

Dieses Gerät entspricht Teil 15 der FCC-Bestimmungen. Der Betrieb unterliegt der folgende zwei Bedingungen:

- 1) Dieses Produkt kann schädliche Störungen verursachen.
- 2) Dieses Produkt muss alle empfangenen Störungen akzeptieren, einschließlich Störungen, die auftreten kann zu unerwünschtem Betrieb führen.

WARNUNG: Änderungen oder Modifikationen an diesem Produkt sind nicht ausdrücklich genehmigt von der Partei. Die Verantwortung für die Einhaltung kann zum Erlöschen der Berechtigung des Benutzers führen Betreiben Sie das Produkt.

Hinweis: Dieses Produkt wurde getestet und entspricht den Grenzwerten einer Klasse B-Digitalgerät gemäß Teil 15 der FCC-Bestimmungen. Diese Grenzwerte dienen dazu einen angemessenen Schutz vor schädlichen Störungen in einem Wohngebiet bieten Installation.

Dieses Produkt erzeugt und nutzt Hochfrequenzenergie und kann diese ausstrahlen Installation und Verwendung gemäß den Anweisungen können schädlich sein Störungen der Funkkommunikation. Eine Garantie dafür gibt es allerdings nicht In einer bestimmten Installation treten keine Störungen auf. Wenn dieses Produkt verursacht schädliche Störungen des Radio- oder Fernsehempfangs, die durch festgestellt werden können Beim Aus- und Einschalten des Produkts wird der Benutzer aufgefordert, zu versuchen, das Problem zu beheben Beeinträchtigung durch eine oder mehrere der folgenden Maßnahmen.









- Richten Sie die Empfangsantenne neu aus oder versetzen Sie sie.
- Erhöhen Sie den Abstand zwischen Produkt und Empfänger.
- Schließen Sie das Produkt an eine Steckdose an, die zu einem anderen Stromkreis gehört als dem, an den das Produkt angeschlossen ist Empfänger angeschlossen ist.
- Wenden Sie sich für Hilfe an den Händler oder einen erfahrenen Radio-/TV-Techniker.

INSTALLATIONSANLEITUNG

Modell	8015FL 6002FL	8039FL 8009FL	8004FL	7009FL		
Montage Typ	Wand Montieren	Wand Montieren	Wand Montieren	Wand Montieren	Wand Montieren	Wand Montieren
Verbindung Faden	G1/2"	G1/2"	G1/2"	G1/2"	G1/2"	G1/2"
Funktionen	Vier Modi	Fünf Modi	Sechs Modi	Sechs Modi	Sechs Modi	Fünf Modi
Wannenauslauf	×	ÿ	ÿ	ÿ	ÿ	ÿ
Temperatur e Anzeige	×	×	ÿ	ÿ	ÿ	ÿ
LED-Lampe	×	ÿ	ÿ	ÿ	ÿ	×
Leistung	×	Trockenbatterie (DC3V)	Trockenbatterie (DC3V)	Wasserkraft Leistung (AC6V)	Wasserkraft Leistung (AC6V)	Trockenbatterie (DC3V)
Hand Dusche	3-Einstellung	1-Einstellung	3-Einstellung	3-Einstellung	3-Einstellung	3-Einstellung
Beenden	Fingerabdruckfreies Duschsystem aus gebürstetem Nickel					
Material	Edelstahl, Messing, PVC, ABS					

LISTE DER EINZELTEILE

MODEL		8015FL 8039FL 8009FL	6002FL	8004FL	7009FL
M6 nut		4pcs	4pcs	0pcs	0pcs
M6 * 10 screw		4pcs	4pcs	0pcs	0pcs
Hose Clamp		2pcs	2pcs	2pcs	0pcs
M4 * 10 screw		0pcs	0pcs	2pcs	0pcs
Brass shower arm		0pcs	0pcs	0pcs	1pcs
Single function handheld shower		0pcs	1pcs	0pcs	0pcs
Panel cotton bag		1pcs	1pcs	1pcs	1pcs
Top spray cotton bag		1pcs	1pcs	1pcs	0pcs

MODEL		8015FL 8039FL 8009FL	6002FL	8004FL	7009FL
Three function handheld shower		1pcs	0pcs	1pcs	1pcs
1.5 meter hand spray hose		1pcs	1pcs	1pcs	1pcs
Hand spray seat		1pcs	1pcs	1pcs	1pcs
1/2 right angle adapter		2pcs	2pcs	2pcs	2pcs
4-point rubber		2pcs	2pcs	2pcs	2pcs
Self tapping screw		4pcs	4pcs	4pcs	4pcs
Fastener		2pcs	2pcs	2pcs	2pcs
Grommet		1pcs	1pcs	1pcs	1pcs
Hexagon nut		1pcs	1pcs	1pcs	1pcs

MONTAGEANLEITUNGEN

MODELL 8015FL/6002FL/8039FL/8009FL



1
Insert the PVC pipe from the top opening To pierce out



2
Route the LED light wire along the hole Insert into the motherboard



3
Fix the motherboard and top spray with 4 pairs of M6 screws and nuts



4
Fix the PVC pipe with a throat clamp On the top spray joint

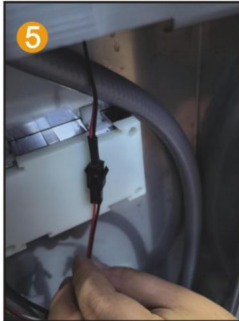

5
Connect the LED light cable and power supplyline



6
Install 2 No. 5 batteries to chargePool box



7
Point the switch of the battery box towards ON



8
Insert the hand spray nozzle into the panel And install the gasket



9
Spray socket with hexagonal nut handle Fixed on the panel

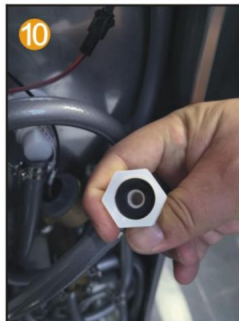

10
Put the 4-point rubber into the hand spray Inside the joint of the seat

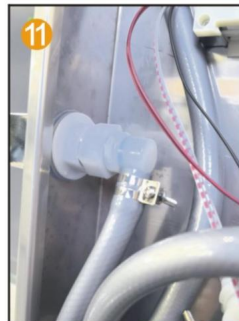

11
Connect the water outlet connector and hand spray Seat joint



12
Connect the hand spray hose to the handheld one shower head

Hinweis: Beim 8015FL fehlen die Schritte 2, 5, 6 und 7. Beim 8009FL fehlen die Schritte 6 und 7.

MODELL 8004FL

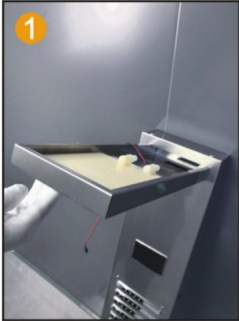

1
Insert the top spray into the motherboard inside the hole



2
Use 2 M4 screws to secure the main Fixed plate and top spray

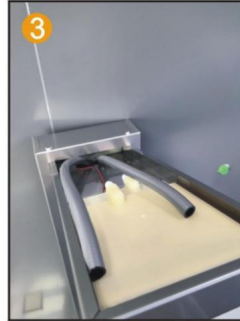

3
Connect PVC pipes and LED light wires Thread through the hole



4
Fix the PVC pipe with a throat clamp On the top spray joint

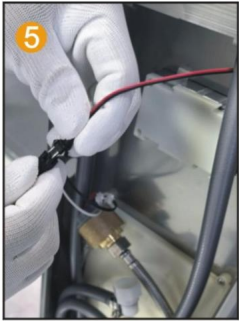

5
Connect the LED light cable and power supply line

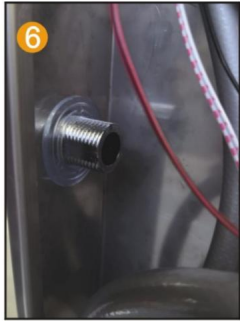

6
Insert the hand spray nozzle into the panel and install the gasket

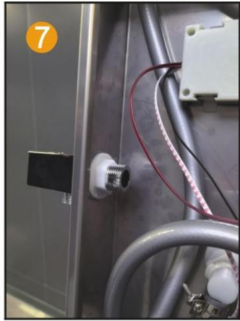

7
Spray socket with hexagonal nut handle Fixed on the panel

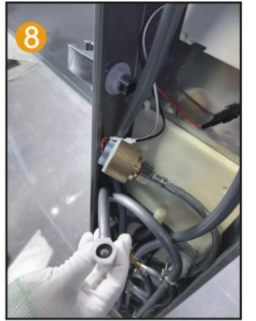

8
Spray socket with hexagonal nut handle Fix the 4-point rubber on the panel and spray it by hand Inside the seat joint

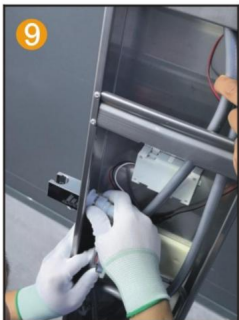

9
Connect the water outlet connector and hand spray Seat joint

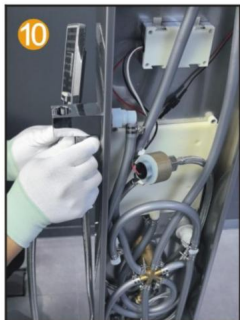

10
Connect the hand spray hose to the handheld one shower head

MODELL 7009FL

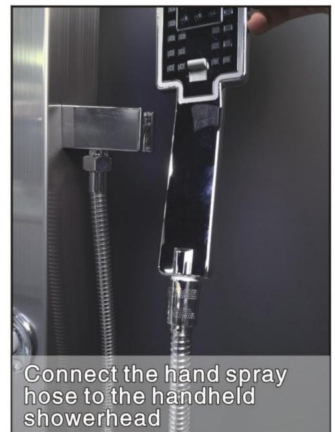
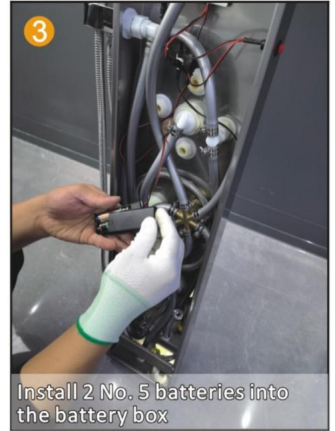
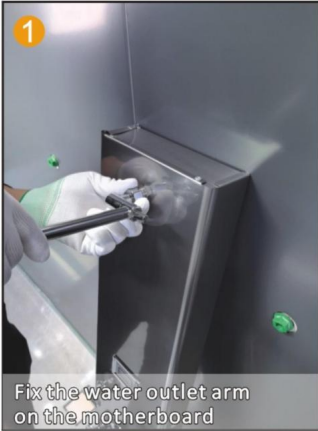

INSTALLATIONSSCHRITTE (ALLGEMEIN)

Installation Complete side reference dimension drawing

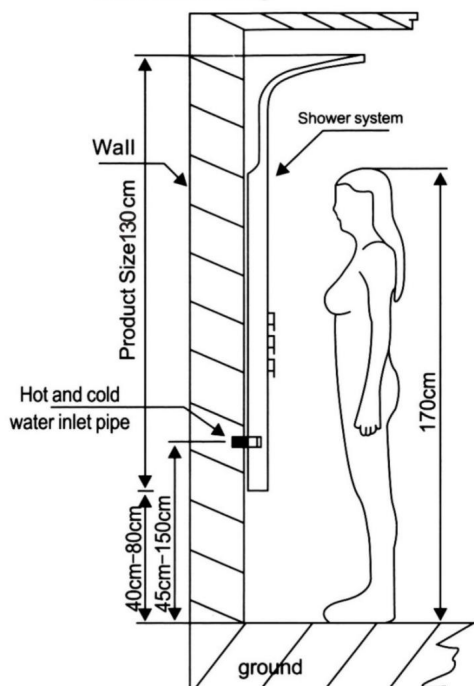

Reserved water layout

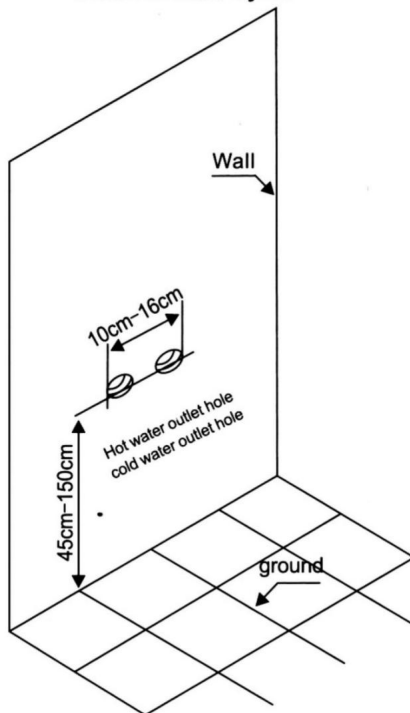

Installationshinweise

1. Messen Sie entsprechend der Installationshöhe des Familienhöhen-Budget-Duschsystems den Abstand des Duschsystems auf der Rückseite der Stange, markieren Sie ihn an der Wand und befestigen Sie ihn an der entsprechenden Position des Schilds mit hängendem Eisen (jeweils nach oben und unten).
2. Schließen Sie den Heiß- und Kaltwasserschlauch an (achten Sie darauf, das Magazin und den Schmutz in der Wand zu reinigen, damit er nicht verstopft und die Wasserwirkung beeinträchtigt wird).
3. An der Wand hängendes Duschsystem, die oberen und unteren beiden Karten wurden in zwei hängenden Pasten festgeklemt (Hinweis: Nach dem Duschen an der Systemwand wackelt der Hauptkörper in der Nähe der Wand nicht, es muss kein weiterer Glaskleber verwendet werden). andere Werkzeuge gehoben).

Wartungsmethoden für Duschsysteme aus Edelstahl:

1. Regelmäßige Reinigung des Produkts, um sein strahlendes Aussehen zu erhalten sauber;
2. Reinigen Sie die Oberfläche mit Wasser oder einem milden Reinigungsmittel und wischen Sie sie mit einem weichen Handtuch ab.
3. Beachten Sie, dass das saubere Produkt an der versteckten Position rechtzeitig gereinigt werden kann Produkte dauerhaft.

INSTALLATIONSDIAGRAMM DER DUSCHPANEEL-SERIE

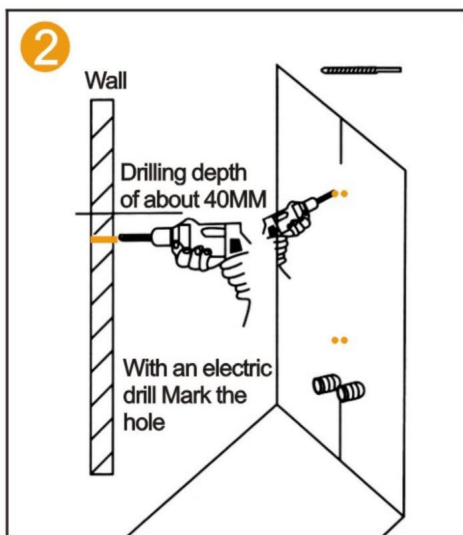
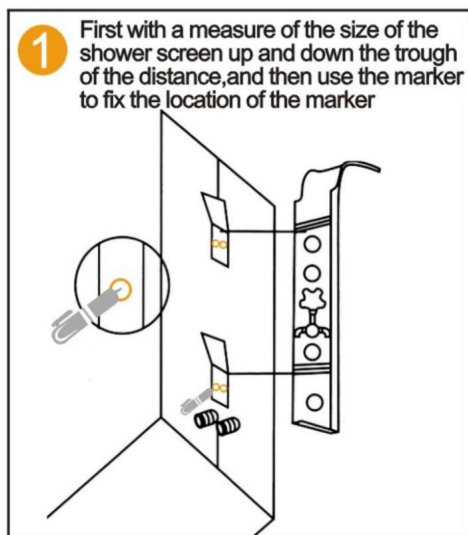

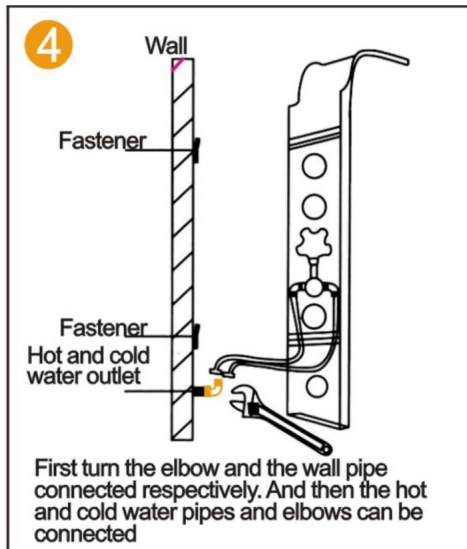
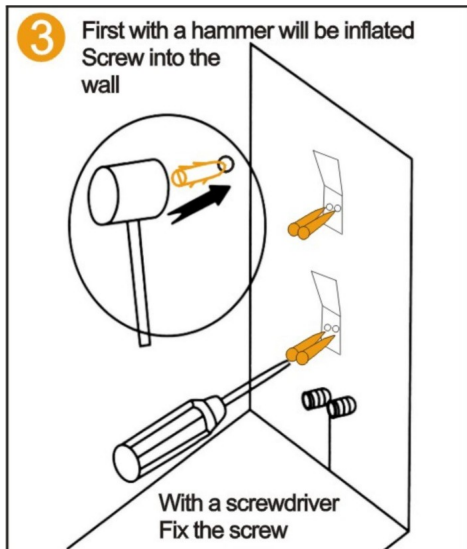

FUNKTIONSEINFÜHRUNG

8015FL

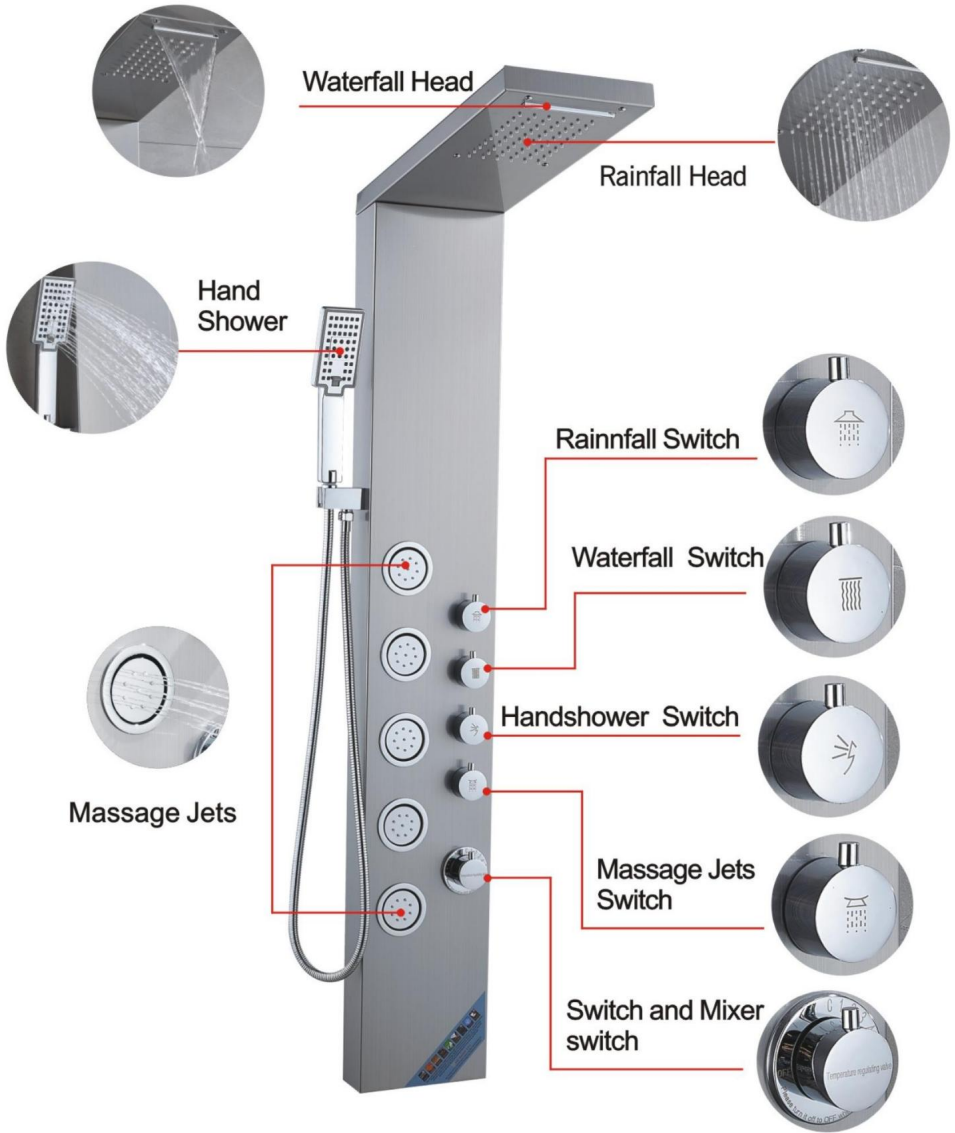

FUNKTIONSEINFÜHRUNG

6002FL



FUNKTIONSEINFÜHRUNG

8039FL

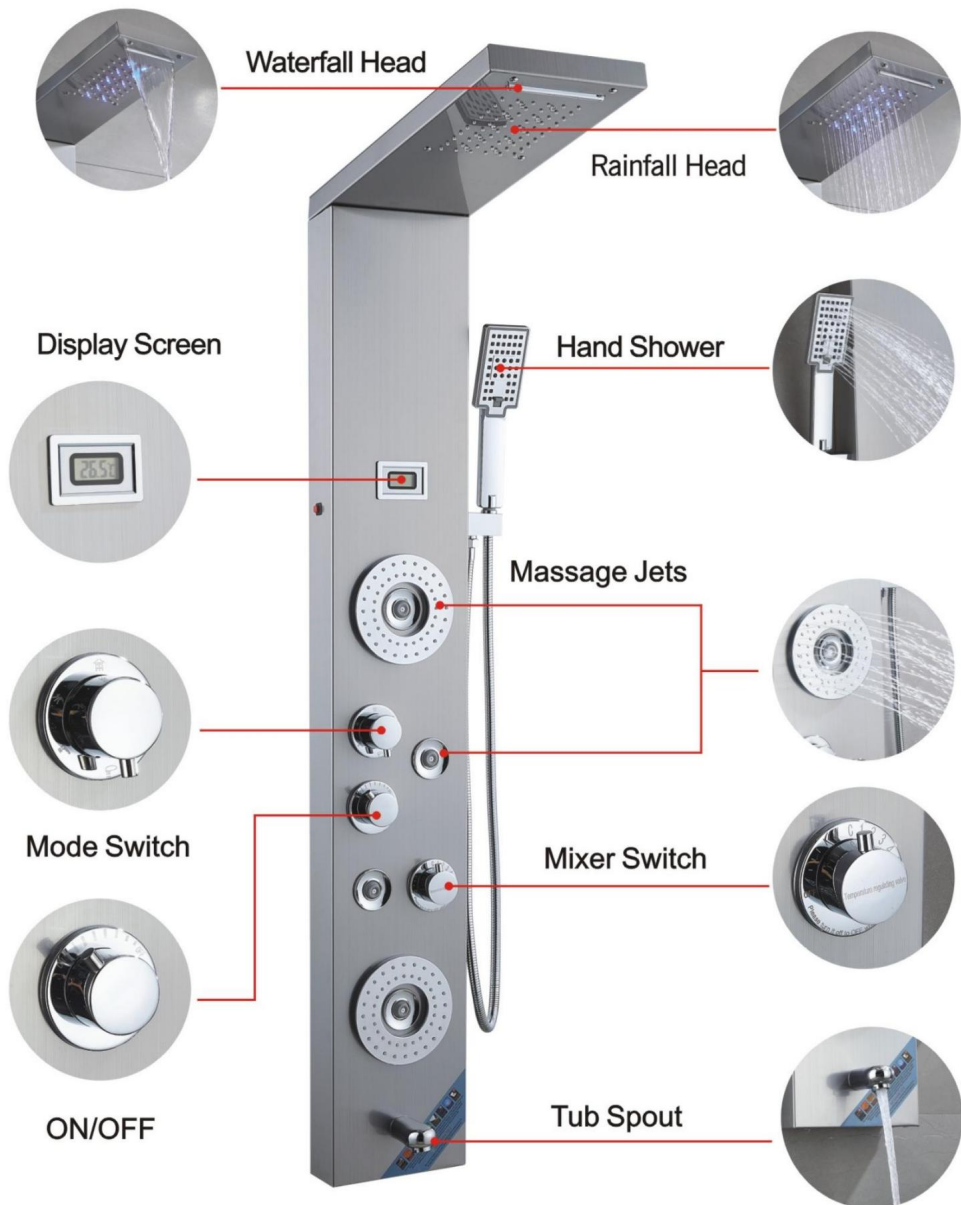

FUNKTIONSEINFÜHRUNG

8009FL



FUNKTIONSEINFÜHRUNG

8004FL



FUNKTIONSEINFÜHRUNG

7009FL

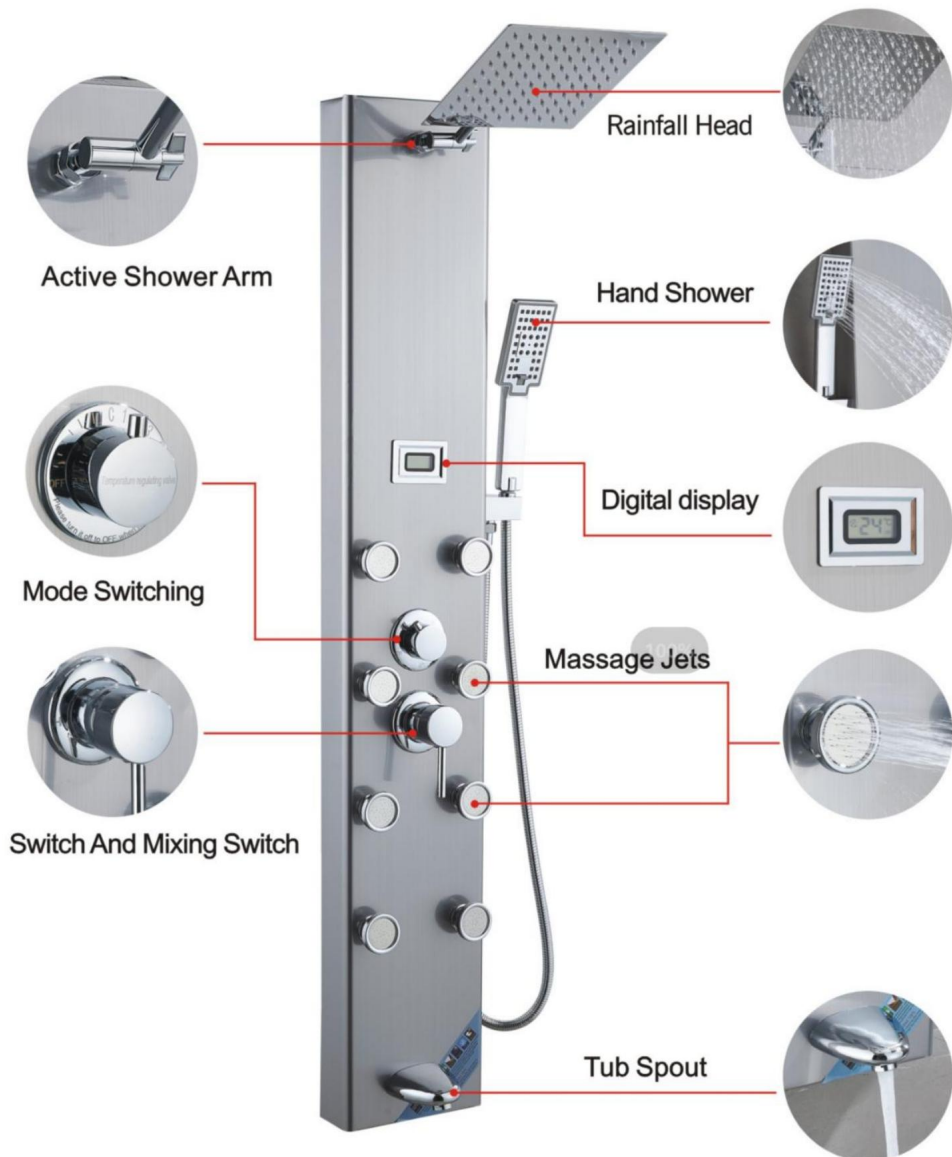

In China hergestellt

VEVOR[®]

TOUGH TOOLS, HALF PRICE

Technischer Support und E-Garantiezertifikat

www.vevor.com/support

VEVOR[®]

TOUGH TOOLS, HALF PRICE

Supporto tecnico e certificato di garanzia elettronica www.vevor.com/support

TORRE PANNELLO DOCCIA

MODELLO:8015FL/6002FL/8039FL/8009FL/8004FL/7009FL

Continuiamo a impegnarci per fornirvi strumenti a prezzi competitivi.

"Risparmia la metà", "Metà prezzo" o qualsiasi altra espressione simile da noi utilizzata rappresenta solo una stima del risparmio che potresti trarre dall'acquistare determinati strumenti con noi rispetto ai principali marchi più importanti e non significa necessariamente coprire tutte le categorie di strumenti offerti da noi. Ti ricordiamo di verificare attentamente quando effettui un ordine con noi se stai effettivamente risparmiando la metà rispetto ai migliori marchi principali.

VEVOR®

TOUGH TOOLS, HALF PRICE

TORRE PANNELLO DOCCIA



8015FL



6002FL



8039FL



8009FL



8004FL



7009FL

HO BISOGNO DI AIUTO? CONTATTACI!

Hai domande sul prodotto? Hai bisogno di supporto tecnico? Sentiti libero di Contattaci:

Supporto tecnico e certificato di garanzia elettronica
www.vevor.com/support

Questa è l'istruzione originale, si prega di leggere tutte le istruzioni del manuale attentamente prima di operare. VEVOR si riserva una chiara interpretazione della ns Manuale d'uso. L'aspetto del prodotto è soggetto al prodotto che hai ricevuto. Ti preghiamo di perdonarci se non ti informeremo più se sono presenti aggiornamenti tecnologici o software sul nostro prodotto.

INTRODUZIONE AL PRODOTTO



Avvertenza: per ridurre il rischio di lesioni, l'utente deve leggere le istruzioni manuale con attenzione.



CORRETTO SMALTIMENTO

Questo prodotto è soggetto alle disposizioni della Direttiva Europea 2012/19/CE. Il simbolo che mostra un bidone della spazzatura barrato attraverso indica che il prodotto necessita di raccolta differenziata raccolta nell'Unione Europea. Questo vale per il prodotto e tutti gli accessori contrassegnati da questo simbolo. Prodotti contrassegnati come tali non possono essere smaltiti con i normali rifiuti domestici ma devono essere portati in un punto di raccolta per il riciclaggio di materiale elettrico e dispositivi elettronici.

Suggerimenti per gli avvisi:

1. Durante il processo di installazione, è meglio indossare guanti per evitare tagli taglienti angoli del pannello da graffi sul palmo della mano.
2. Durante l'installazione della doccia, assicurarsi che tutte le giunture siano completamente chiuse serrato per evitare perdite d'acqua.
3. Assicurarsi che i tubi rosso e blu di ingresso dell'acqua all'interno del pannello siano in posizione non corretta stato piegato per evitare di influenzare la pressione dell'acqua.
4. Quando la doccia non è in uso, chiudere la valvola di commutazione della doccia.



CONSERVA QUESTE ISTRUZIONI

Informazioni FCC

ATTENZIONE: Variazioni o modifiche non espressamente approvate dalla parte responsabile della conformità potrebbe annullare l'autorità dell'utente a utilizzare il attrezzatura!

Questo dispositivo è conforme alla Parte 15 delle norme FCC. L'operazione è soggetta all'art seguenti due condizioni:

- 1) Questo prodotto può causare interferenze dannose.
- 2) Questo prodotto deve accettare qualsiasi interferenza ricevuta, inclusa l'interferenza potrebbe causare un funzionamento indesiderato.

ATTENZIONE: Cambiamenti o modifiche a questo prodotto non sono espressamente approvati dal partito. La responsabilità della conformità potrebbe invalidare l'autorità dell'utente a farlo utilizzare il prodotto.

Nota: questo prodotto è stato testato ed è risultato conforme ai limiti di una classe Dispositivo digitale B ai sensi della Parte 15 delle norme FCC. Questi limiti sono progettati per fornire una protezione ragionevole contro le interferenze dannose in un ambiente residenziale installazione.

Questo prodotto genera, utilizza e può irradiare energia in radiofrequenza e, in caso contrario installato e utilizzato in conformità con le istruzioni, può causare danni interferenze alle comunicazioni radio. Tuttavia, non vi è alcuna garanzia in tal senso non si verificheranno interferenze in una particolare installazione. Se questo prodotto causa interferenze dannose alla ricezione radiofonica o televisiva, che possono essere determinate da spegnendo e riaccendendo il prodotto, l'utente è invitato a provare a correggere il problema interferenza da parte di una o più delle seguenti misure.









- Riorientare o riposizionare l'antenna ricevente.
- Aumentare la distanza tra il prodotto e il ricevitore.
- Collegare il prodotto ad una presa su un circuito diverso da quello a cui è collegato il ricevitore è collegato.
- Consultare il rivenditore o un tecnico radio/TV esperto per assistenza.

ISTRUZIONI PER L'INSTALLAZIONE

Modello	8015FL 6002	FL 8039FL 8009	FL 8004FL 7009	FL		
Montaggio	Parete	Parete	Parete	Parete	Parete	Parete
Tipo	Montare	Montare	Montare	Montare	Montare	Montare
Connesione	G1/2"	G1/2"	G1/2"	G1/2"	G1/2"	G1/2"
Filo						
Funzioni	quattro Modalità	Cinque Modalità	Sei Modalità	Sei Modalità	Sei Modalità	Cinque Modalità
Beccuccio della vasca	×	ÿ	ÿ	ÿ	ÿ	ÿ
Temperatura	×	×	ÿ	ÿ	ÿ	ÿ
eVisualizzare						
Lampada a LED	×	ÿ	ÿ	ÿ	ÿ	×
Energia	×	Cella a secco ÿDC3Vÿ	Cella a secco ÿDC3Vÿ	Idro Energia ÿAC6Vÿ	Idro Energia ÿAC6Vÿ	Cella a secco ÿDC3Vÿ
Mano	3 impostazioni	1 impostazione	3 impostazioni	3 impostazioni	3 impostazioni	3 impostazioni
Doccia						
Fine	Sistema doccia in nichel spazzolato senza impronte digitali					
Materiale	Acciaio inossidabile, ottone, PVC, ABS					

ELENCO DELLE PARTI

MODEL		8015FL 8039FL 8009FL	6002FL	8004FL	7009FL
M6 nut		4pcs	4pcs	0pcs	0pcs
M6 * 10 screw		4pcs	4pcs	0pcs	0pcs
Hose Clamp		2pcs	2pcs	2pcs	0pcs
M4 * 10 screw		0pcs	0pcs	2pcs	0pcs
Brass shower arm		0pcs	0pcs	0pcs	1pcs
Single function handheld shower		0pcs	1pcs	0pcs	0pcs
Panel cotton bag		1pcs	1pcs	1pcs	1pcs
Top spray cotton bag		1pcs	1pcs	1pcs	0pcs

MODEL		8015FL 8039FL 8009FL	6002FL	8004FL	7009FL
Three function handheld shower		1pcs	0pcs	1pcs	1pcs
1.5 meter hand spray hose		1pcs	1pcs	1pcs	1pcs
Hand spray seat		1pcs	1pcs	1pcs	1pcs
1/2 right angle adapter		2pcs	2pcs	2pcs	2pcs
4-point rubber		2pcs	2pcs	2pcs	2pcs
Self tapping screw		4pcs	4pcs	4pcs	4pcs
Fastener		2pcs	2pcs	2pcs	2pcs
Grommet		1pcs	1pcs	1pcs	1pcs
Hexagon nut		1pcs	1pcs	1pcs	1pcs

ISTRUZIONI DI MONTAGGIO

MODELLO 8015FL/6002FL/8039FL/8009FL



1
Insert the PVC pipe from the top opening To pierce out



2
Route the LED light wire along the hole Insert into the motherboard



3
Fix the motherboard and top spray with 4 pairs of M6 screws and nuts

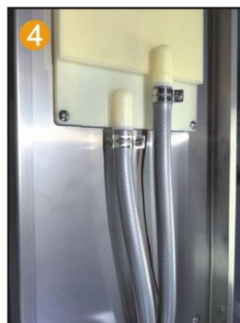

4
Fix the PVC pipe with a throat clamp On the top spray joint

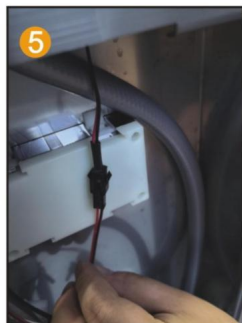

5
Connect the LED light cable and power supplyline

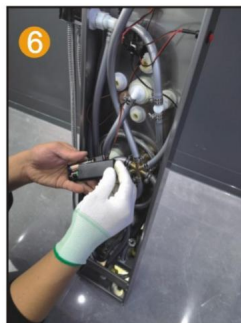

6
Install 2 No. 5 batteries to charge Pool box



7
Point the switch of the battery box towards ON



8
Insert the hand spray nozzle into the panel And install the gasket

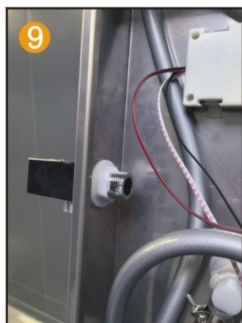

9
Spray socket with hexagonal nut handle Fixed on the panel

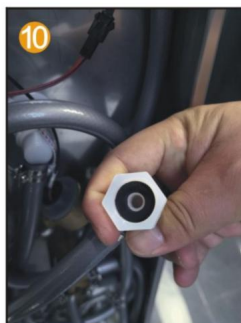

10
Put the 4-point rubber into the hand spray Inside the joint of the seat

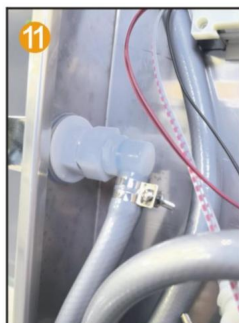

11
Connect the water outlet connector and hand spray Seat joint



12
Connect the hand spray hose to the handheld one shower head

Nota: l'8015FL non ha i passaggi 2, 5, 6 e 7. L'8009FL non ha i passaggi 6 e 7.

MODELLO 8004FL

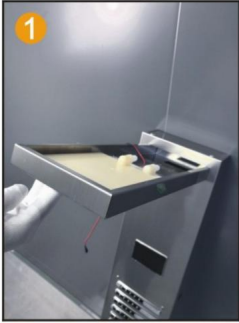

1
Insert the top spray into the motherboard inside the hole



2
Use 2 M4 screws to secure the main fixed plate and top spray



3
Connect PVC pipes and LED light wires through the hole



4
Fix the PVC pipe with a throat clamp on the top spray joint

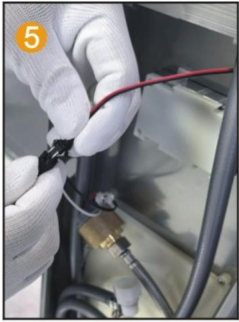

5
Connect the LED light cable and power supply line

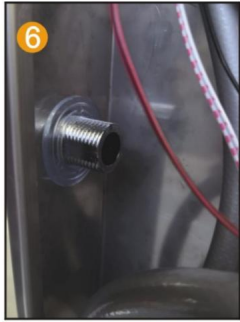

6
Insert the hand spray nozzle into the panel and install the gasket

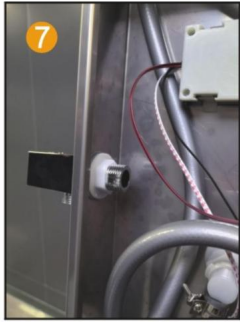

7
Spray socket with hexagonal nut handle fixed on the panel



8
Spray socket with hexagonal nut handle. Fix the 4-point rubber on the panel and spray it by hand inside the seat joint

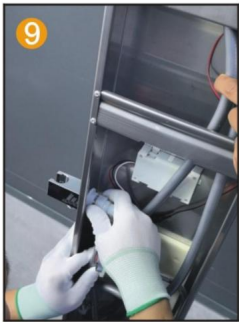

9
Connect the water outlet connector and hand spray seat joint

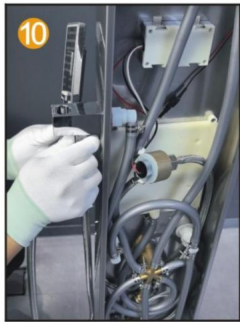

10
Connect the hand spray hose to the handheld shower head

MODELLO 7009FL

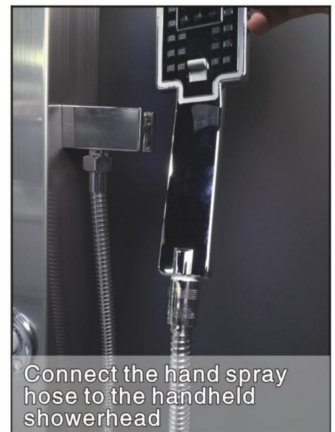
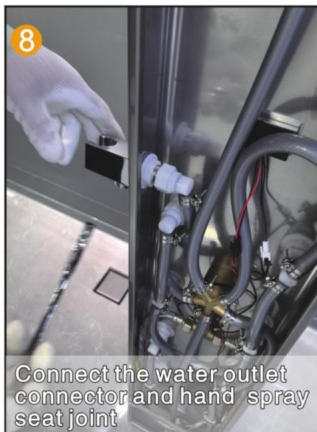
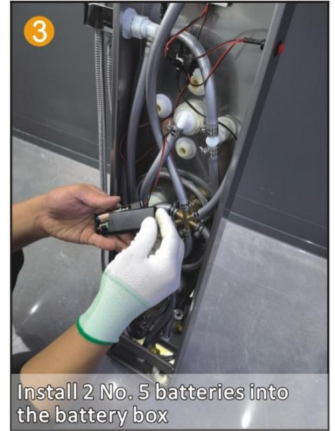
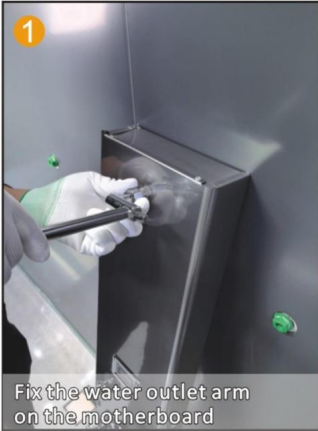

FASI DI INSTALLAZIONE (GENERALI)

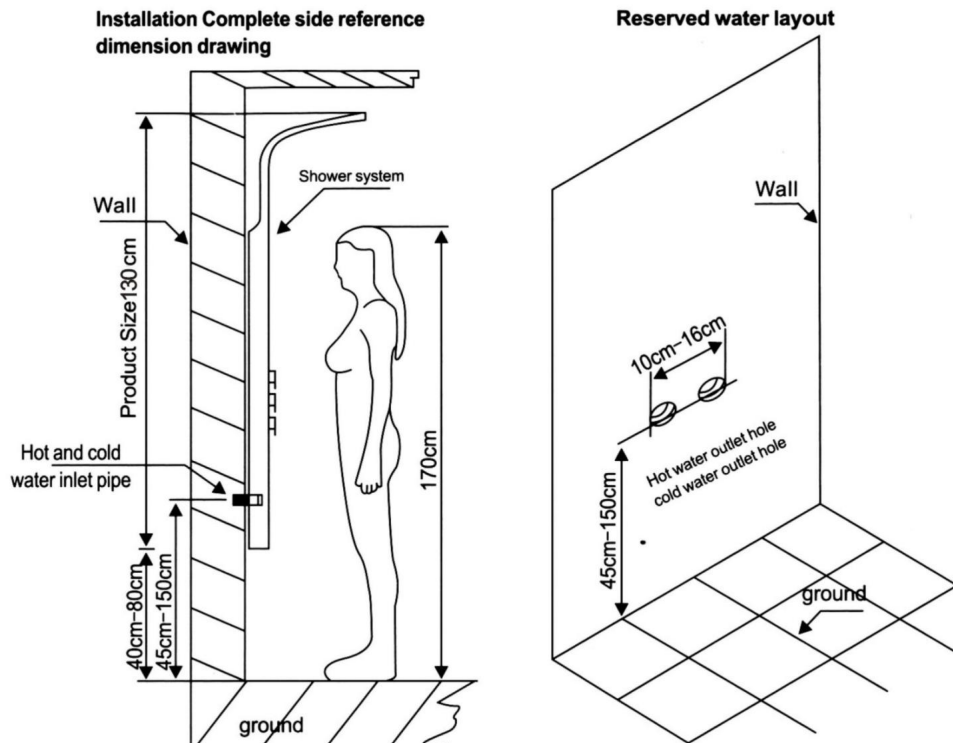

Note di installazione

1. In base all'altezza di installazione del sistema doccia economico dell'altezza della famiglia, misurare la distanza del sistema doccia sul retro della barra, segnare sul muro, nella posizione corrispondente dell'etichetta fissata sul ferro da stiro (su e giù ciascuno) .
2. Collegare il tubo dell'acqua calda e fredda (assicurarsi di pulire il caricatore e lo sporco nella bilancia a muro in modo da non bloccarlo e influenzare l'effetto dell'acqua).
3. Sistema doccia appeso al muro, le due schede superiore e inferiore sono fissate con due paste sospese (Nota: doccia Dopo il muro del sistema, il corpo principale vicino al muro non trema, non è necessario utilizzare un'altra colla per vetro e altri strumenti corretti).

Metodi di manutenzione del sistema doccia in acciaio inossidabile:

1. Pulizia regolare del prodotto per mantenerne l'aspetto brillante e pulito;
2. Pulisci la superficie con acqua o un detergente delicato e asciugala con un panno morbido.
3. Si noti che il prodotto pulito della posizione nascosta può fare una pulizia tempestiva prodotti duraturi.

SCHEMA INSTALLAZIONE SERIE PANNELLI DOCCIA

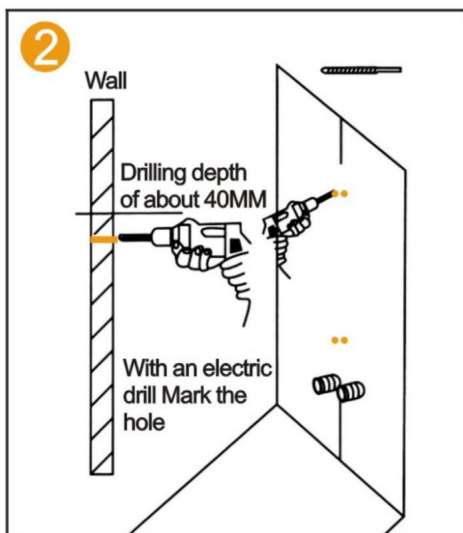
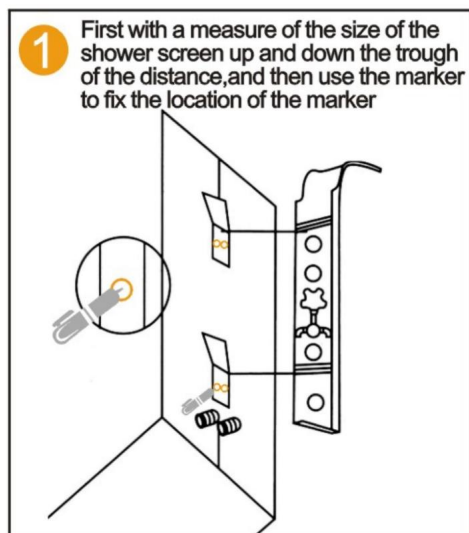

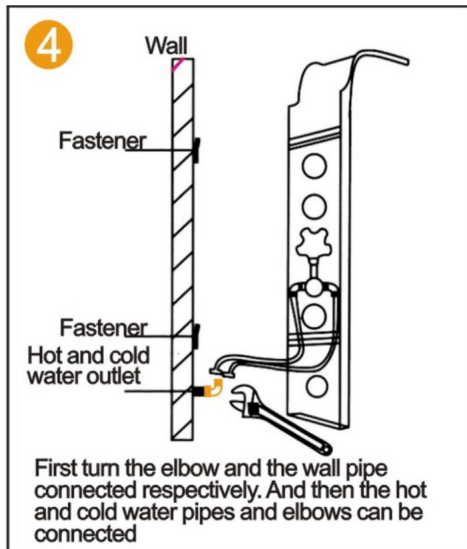
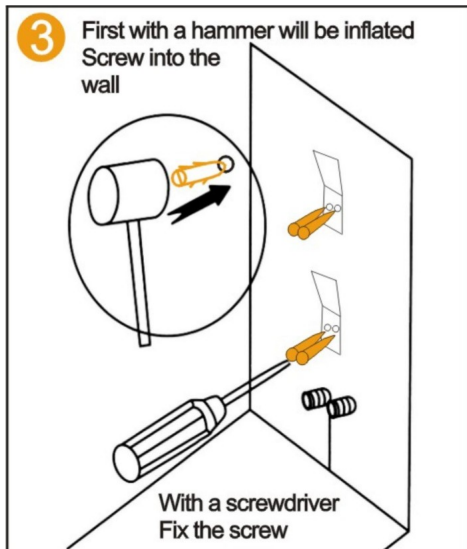

INTRODUZIONE ALLA FUNZIONE

8015FL

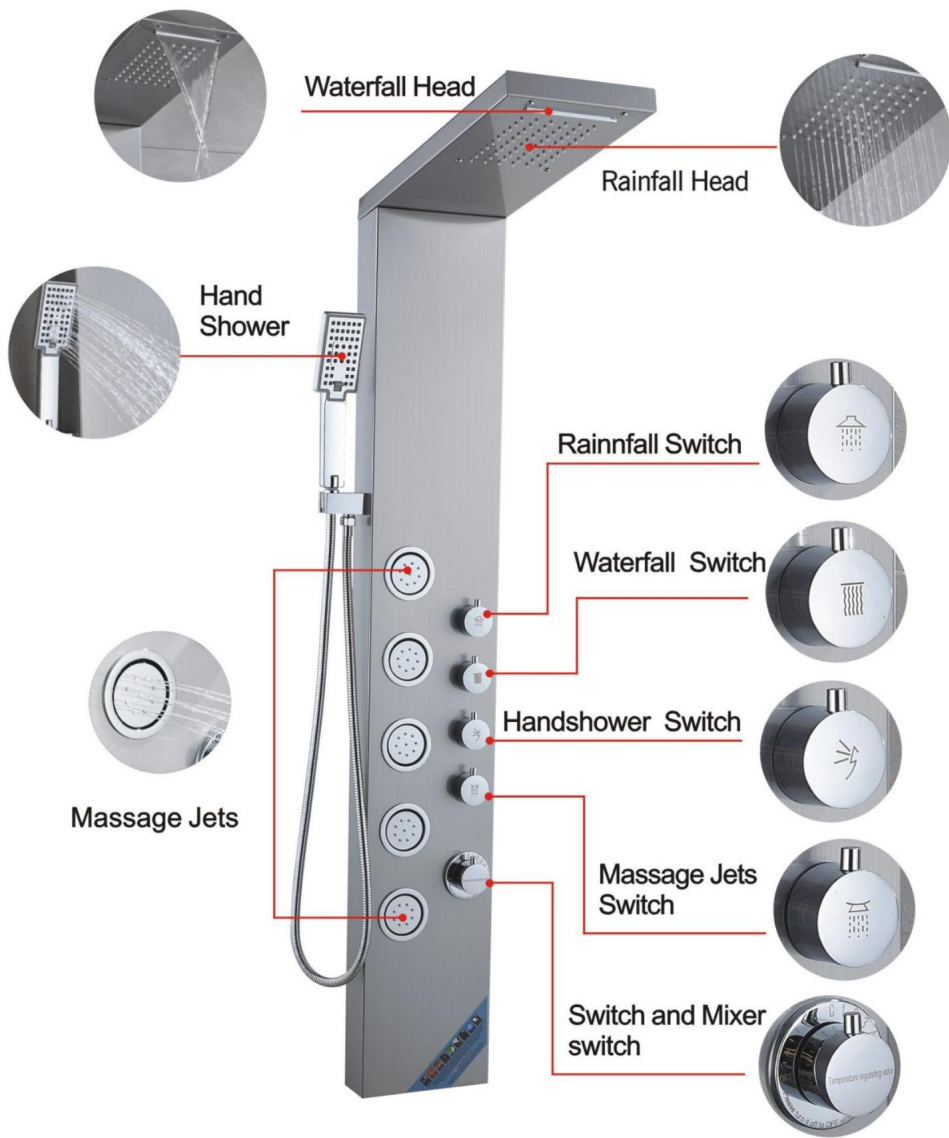

INTRODUZIONE ALLA FUNZIONE

6002FL



INTRODUZIONE ALLA FUNZIONE

8039FL

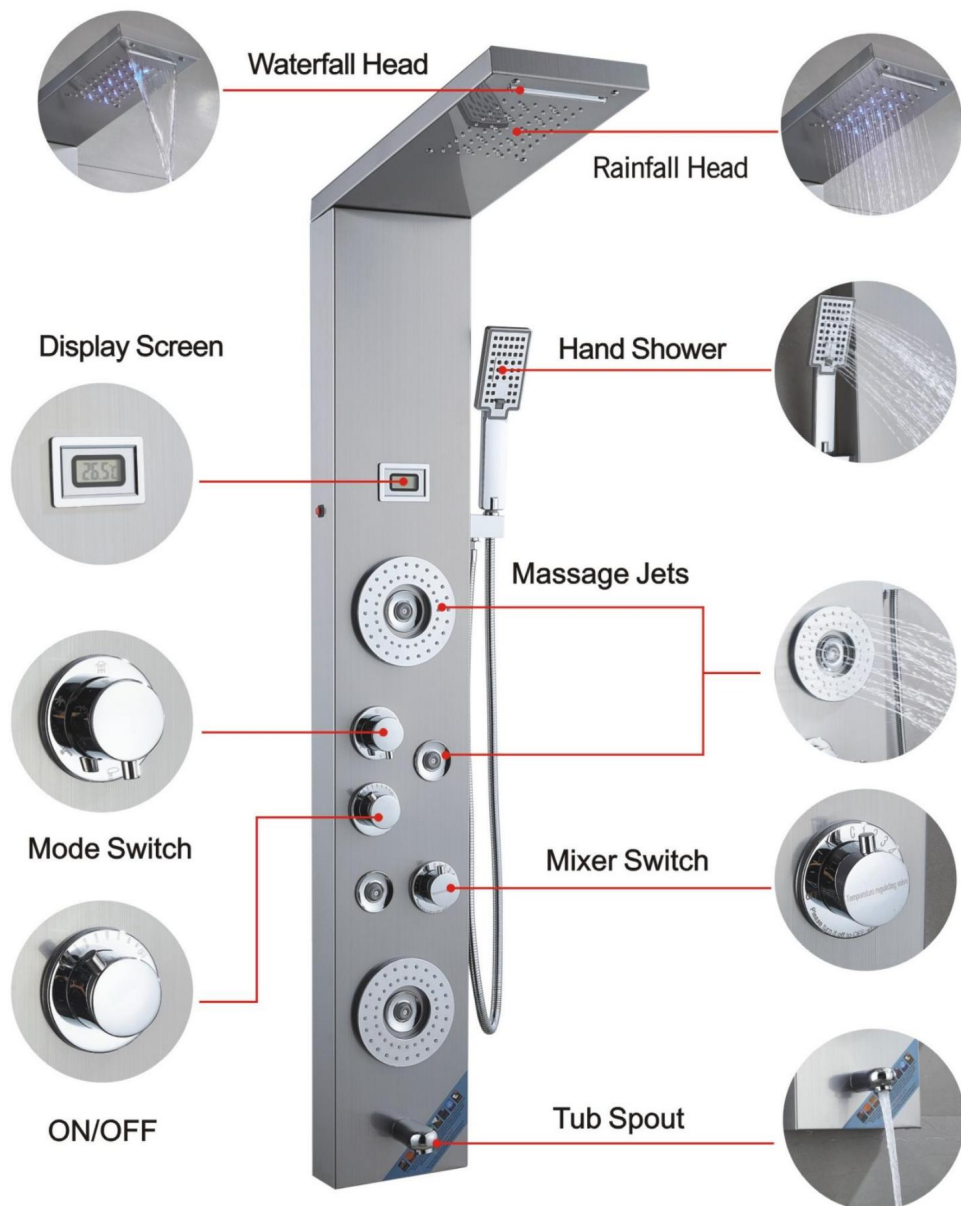

INTRODUZIONE ALLA FUNZIONE

8009FL

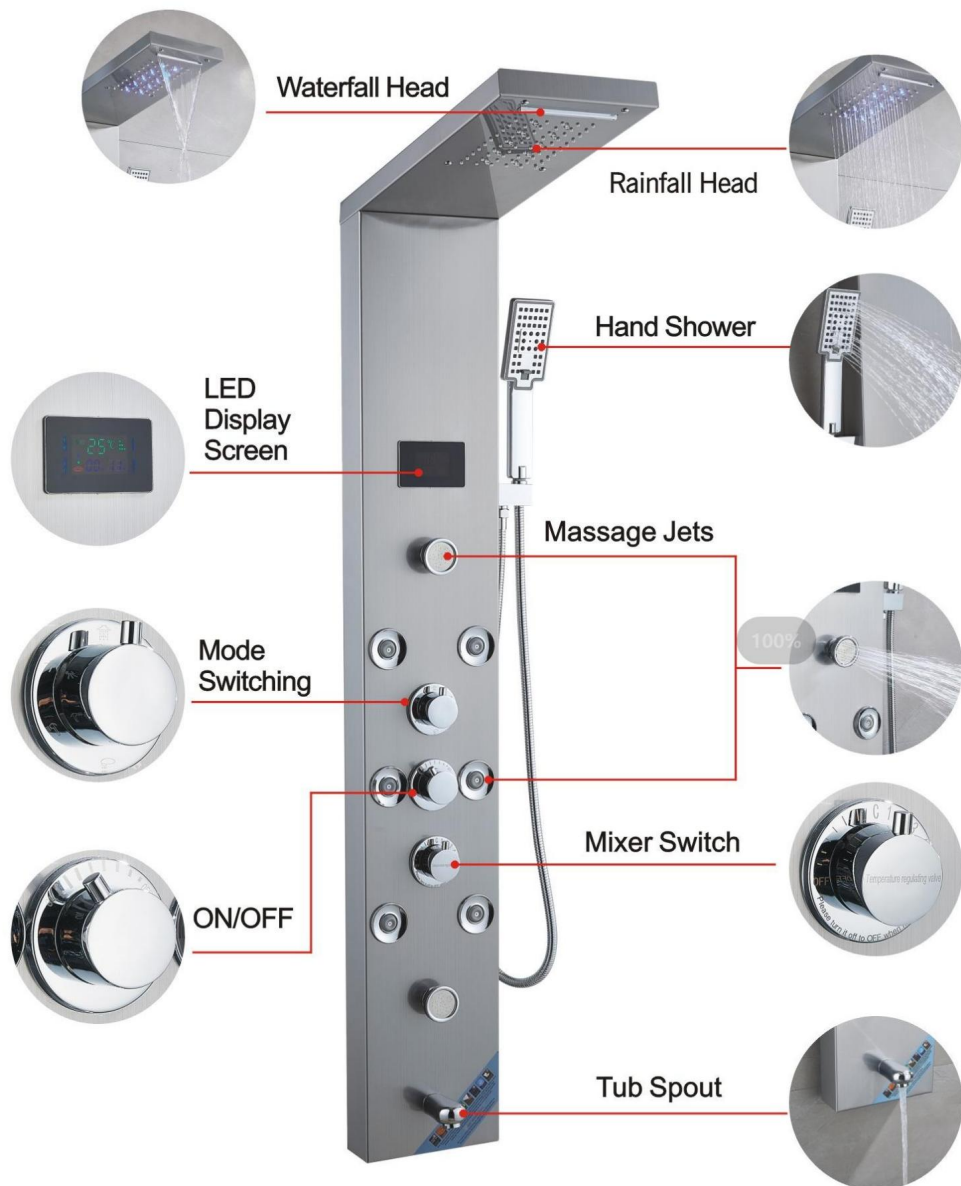

INTRODUZIONE ALLA FUNZIONE

8004FL

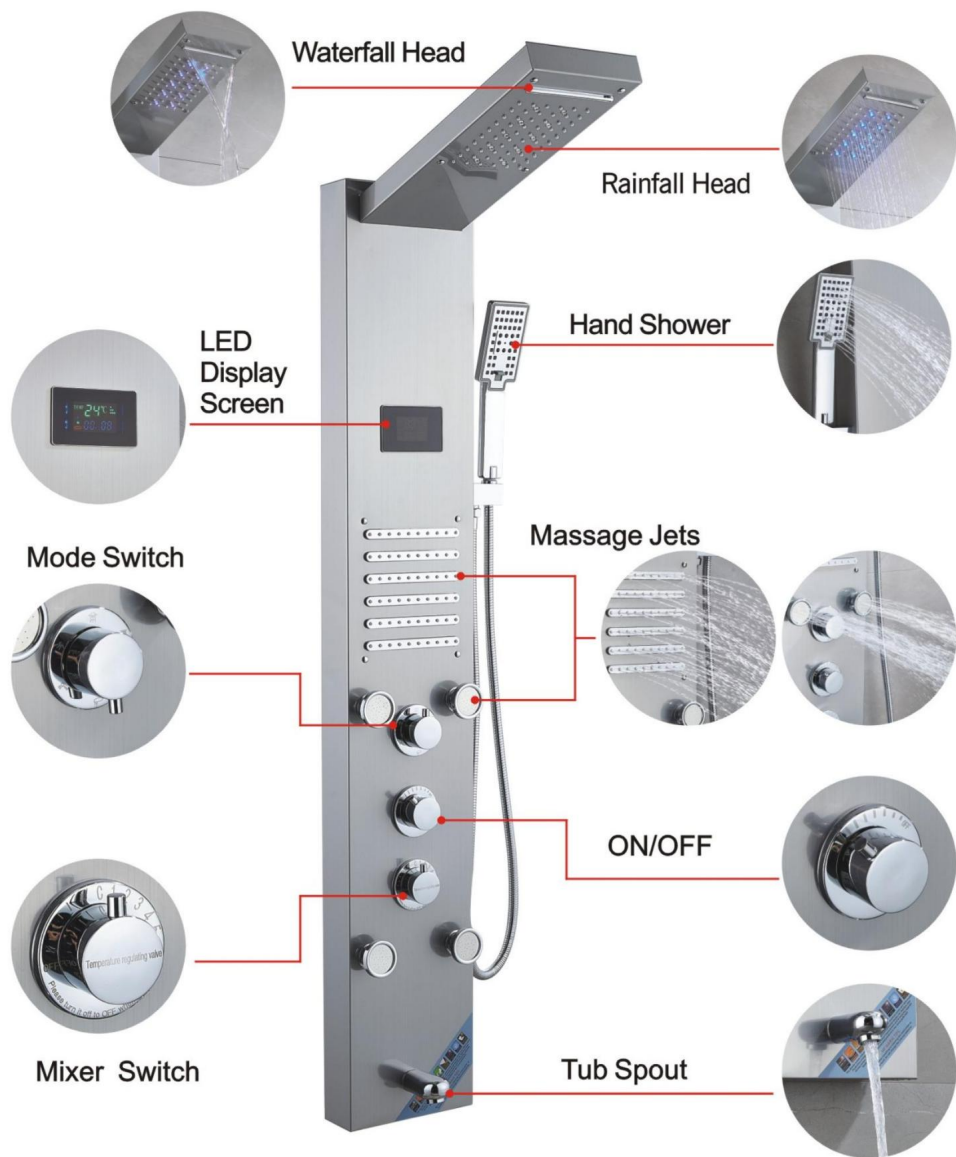

INTRODUZIONE ALLA FUNZIONE

7009FL

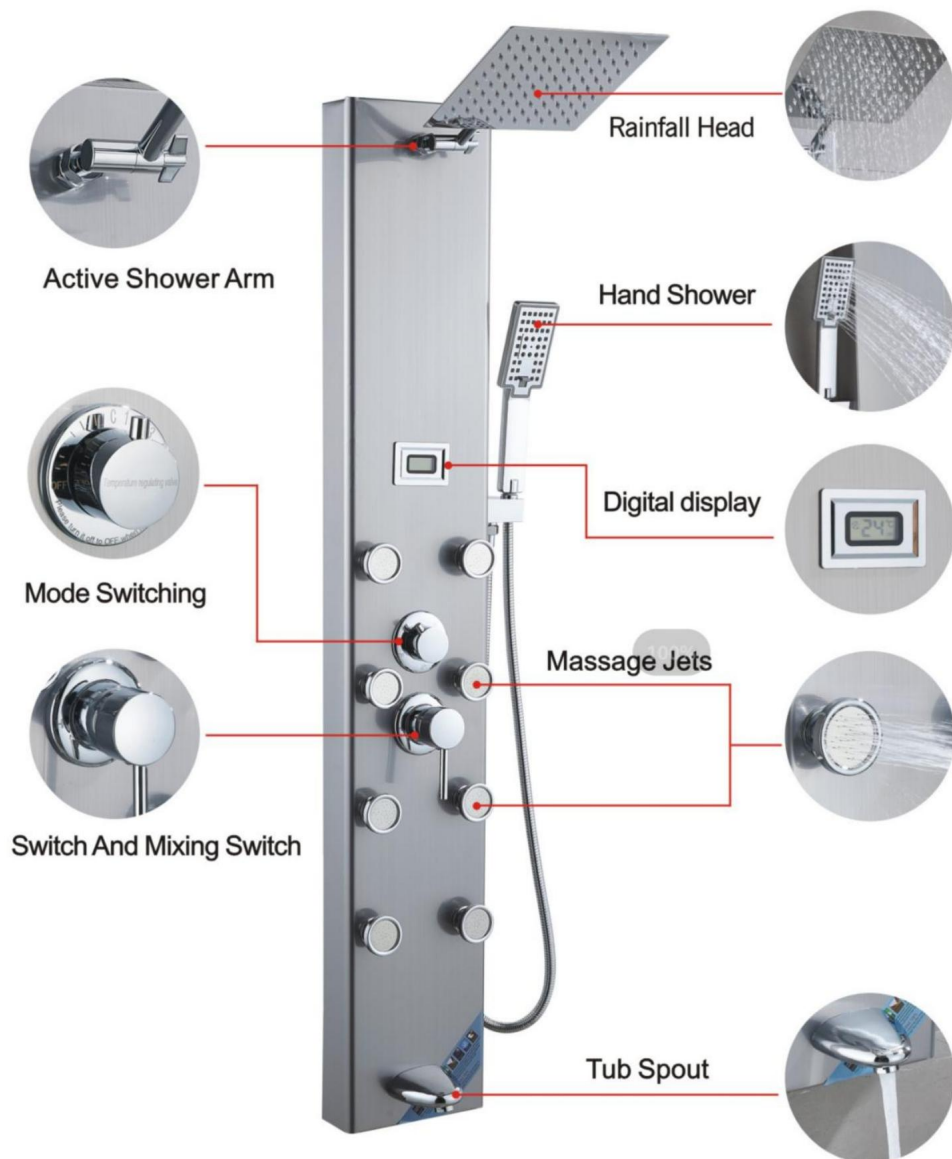

Made in China

VEVOR®

TOUGH TOOLS, HALF PRICE

**Supporto tecnico e certificato di garanzia
elettronica www.vevor.com/support**

VEVOR[®]

TOUGH TOOLS, HALF PRICE

Soporte técnico y certificado de garantía electrónica www.vevor.com/support

TORRE DE PANEL DE DUCHA

MODELO:8015FL/6002FL/8039FL/8009FL/8004FL/7009FL

Seguimos comprometidos a proporcionarle herramientas a precios competitivos.

"Ahorre a mitad de precio", "A mitad de precio" o cualquier otra expresión similar utilizada por nosotros solo representa una estimación de los ahorros que podría beneficiarse al comprar ciertas herramientas con nosotros en comparación con las principales marcas y no significa necesariamente cubrir todas las categorías de herramientas ofrecidas por nosotros. Le recordamos que, cuando realice un pedido con nosotros, verifique cuidadosamente si realmente está ahorrando la mitad en comparación con las principales marcas.

VEVOR®

TOUGH TOOLS, HALF PRICE

TORRE DE PANEL DE DUCHA



8015FL

6002FL

8039FL

8009FL

8004FL

7009FL



¿NECESITAS AYUDA? ¡CONTÁCTENOS!

¿Tiene preguntas sobre el producto? ¿Necesita soporte técnico? Por favor, siéntase libre de Contáctenos:

Soporte técnico y certificado de garantía electrónica
www.vevor.com/support

Estas son las instrucciones originales, lea todas las instrucciones del manual. cuidadosamente antes de operar. VEVOR se reserva una interpretación clara de nuestra manual de usuario. La apariencia del producto estará sujeta a la Producto que recibiste. Por favor perdónanos que no te informaremos nuevamente si hay actualizaciones de tecnología o software en nuestro producto.

INTRODUCCIÓN DEL PRODUCTO

	<p>Advertencia: para reducir el riesgo de lesiones, el usuario debe leer las instrucciones manual cuidadosamente.</p>
	<p>ELIMINACIÓN CORRECTA</p> <p>Este producto está sujeto a las disposiciones de la directiva europea. 2012/19/CE. El símbolo que muestra un contenedor con ruedas cruzado a través indica que el producto requiere rechazo por separado recogida en la Unión Europea. Esto se aplica al producto. y todos los accesorios marcados con este símbolo. Productos marcados como tal no se puede desechar con la basura doméstica normal, pero deben llevarse a un punto de recogida para el reciclaje de aparatos eléctricos y dispositivos electrónicos.</p>

Consejos de advertencia:

1. Durante el proceso de instalación, es mejor usar guantes para evitar cortes esquinas del panel para que no rayen la palma de la mano.
2. Al instalar la ducha, asegúrese de que todas las juntas estén completamente apretados para evitar fugas de agua.
3. Asegúrese de que las tuberías de entrada de agua roja y azul dentro del panel estén en una posición segura. Estado plegado para evitar afectar la presión del agua.
4. Cuando la ducha no esté en uso, cierre la válvula de conmutación de la ducha.



GUARDA ESTAS INSTRUCCIONES

Información de la FCC

PRECAUCIÓN: Cambios o modificaciones no aprobados expresamente por la parte responsable del cumplimiento podría anular la autoridad del usuario para operar el equipo!

Este dispositivo cumple con la Parte 15 de las normas de la FCC. La operación está sujeta a la siguientes dos condiciones:

- 1) Este producto puede causar interferencias perjudiciales.
- 2) Este producto debe aceptar cualquier interferencia recibida, incluidas las interferencias que puede causar un funcionamiento no deseado.

ADVERTENCIA: Los cambios o modificaciones a este producto no están aprobados expresamente por el partido. La responsabilidad por el cumplimiento podría anular la autoridad del usuario para operar el producto.

Nota: Este producto ha sido probado y cumple con los límites para una Clase

Dispositivo digital B de conformidad con la Parte 15 de las Reglas de la FCC. Estos límites están diseñados para Proporcionar una protección razonable contra interferencias perjudiciales en un entorno residencial. instalación.

Este producto genera, utiliza y puede irradiar energía de radiofrecuencia y, de no ser así, instalado y utilizado de acuerdo con las instrucciones, puede causar daños interferencias en las comunicaciones por radio. Sin embargo, no hay garantía de que No se producirán interferencias en una instalación en particular. Si este producto causa interferencia dañina a la recepción de radio o televisión, que puede determinarse mediante Al apagar y encender el producto, se recomienda al usuario que intente corregir el error. interferencia por una o más de las siguientes medidas.









- Reorientar o reubicar la antena receptora.
- Aumentar la distancia entre el producto y el receptor.
- Conecte el producto a una toma de corriente de un circuito diferente al que está conectado El receptor está conectado.
- Consulte al distribuidor o a un técnico experimentado en radio/TV para obtener ayuda.

INSTRUCCIONES DE INSTALACIÓN

Modelo	8015FL 6002	FL 8039FL 8009	FL 8004FL 7009	FL		
Montaje Tipo	Muro Montar	Muro Montar	Muro Montar	Muro Montar	Muro Montar	Muro Montar
Conexión Hilo	G1/2"	G1/2"	G1/2"	G1/2"	G1/2"	G1/2"
Funciones	cuatro Modos	Cinco Modos	Seis Modos	Seis Modos	Seis Modos	Cinco Modos
Caño para bañera	x	√	√	√	√	√
Temperatura e Pantalla	x	x	√	√	√	√
Lámpara led	x	√	√	√	√	x
Fuerza	x	Pila seca (CC3V)	Pila seca (CC3V)	Hidro Fuerza (AC6V)	Hidro Fuerza (AC6V)	Pila seca (CC3V)
Mano Ducha	3-Configuración	1-Configuración	3-Configuración	3-Configuración	3-Configuración	3-Configuración
Finalizar	Sistema de ducha de níquel cepillado sin huellas dactilares					
Material	Acero inoxidable, Latón, PVC, ABS					

LISTA DE PARTES

MODEL		8015FL 8039FL 8009FL	6002FL	8004FL	7009FL
M6 nut		4pcs	4pcs	0pcs	0pcs
M6 * 10 screw		4pcs	4pcs	0pcs	0pcs
Hose Clamp		2pcs	2pcs	2pcs	0pcs
M4 * 10 screw		0pcs	0pcs	2pcs	0pcs
Brass shower arm		0pcs	0pcs	0pcs	1pcs
Single function handheld shower		0pcs	1pcs	0pcs	0pcs
Panel cotton bag		1pcs	1pcs	1pcs	1pcs
Top spray cotton bag		1pcs	1pcs	1pcs	0pcs

MODEL		8015FL 8039FL 8009FL	6002FL	8004FL	7009FL
Three function handheld shower		1pcs	0pcs	1pcs	1pcs
1.5 meter hand spray hose		1pcs	1pcs	1pcs	1pcs
Hand spray seat		1pcs	1pcs	1pcs	1pcs
1/2 right angle adapter		2pcs	2pcs	2pcs	2pcs
4-point rubber		2pcs	2pcs	2pcs	2pcs
Self tapping screw		4pcs	4pcs	4pcs	4pcs
Fastener		2pcs	2pcs	2pcs	2pcs
Grommet		1pcs	1pcs	1pcs	1pcs
Hexagon nut		1pcs	1pcs	1pcs	1pcs

INSTRUCCIONES DE MONTAJE

MODELO 8015FL/6002FL/8039FL/8009FL



1 Insert the PVC pipe from the top opening To pierce out



2 Route the LED light wire along the hole Insert into the motherboard



3 Fix the motherboard and top spray with 4 pairs of M6 screws and nuts

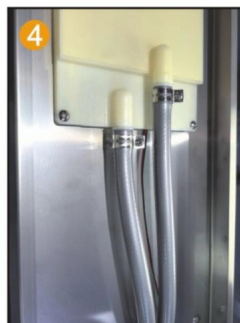

4 Fix the PVC pipe with a throat clamp On the top spray joint

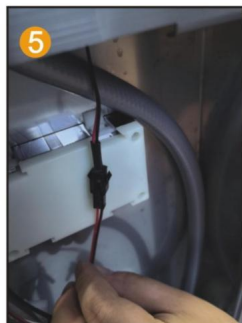

5 Connect the LED light cable and power supplyline



6 Install 2 No. 5 batteries to charge Pool box



7 Point the switch of the battery box towards ON



8 Insert the hand spray nozzle into the panel And install the gasket

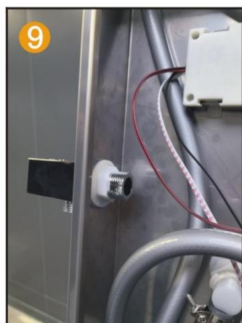

9 Spray socket with hexagonal nut handle Fixed on the panel

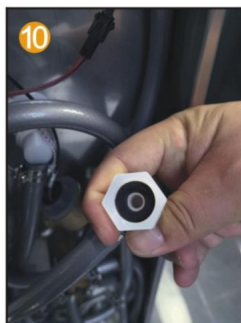

10 Put the 4-point rubber into the hand spray inside the joint of the seat

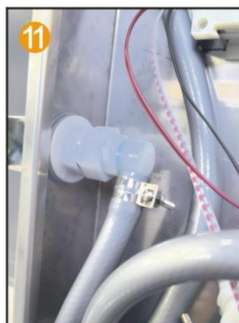

11 Connect the water outlet connector and hand spray Seat joint



12 Connect the hand spray hose to the handheld one shower head

Nota: 8015FL no tiene los pasos 2, 5, 6 y 7. 8009FL no tiene los pasos 6 y 7.

MODELO 8004FL

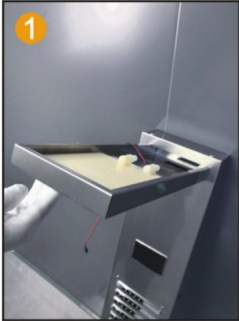

1
Insert the top spray into the motherboard inside the hole



2
Use 2 M4 screws to secure the main Fixed plate and top spray

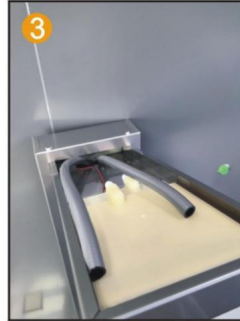

3
Connect PVC pipes and LED light wires Thread through the hole



4
Fix the PVC pipe with a throat clamp On the top spray joint

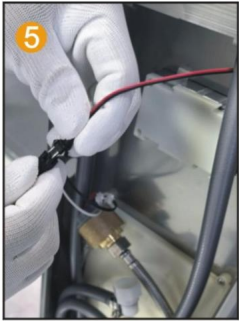

5
Connect the LED light cable and power supplyline

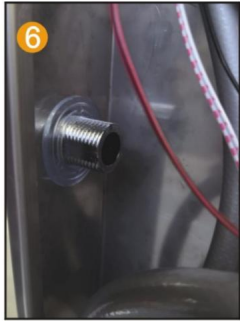

6
Insert the hand spray nozzle into the panel and install the gasket

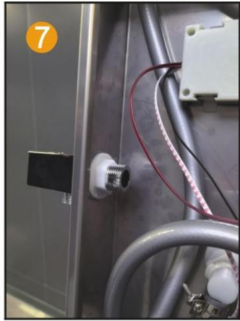

7
Spray socket with hexagonal nut handle Fixed on the panel

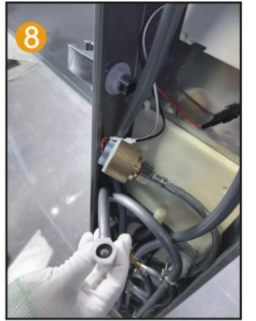

8
Spray socket with hexagonal nut handle Fix the 4-point rubber on the panel and spray it by hand Inside the seat

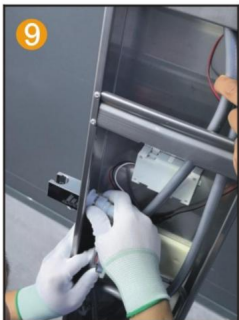

9
Connect the water outlet connector and hand spray Seat joint

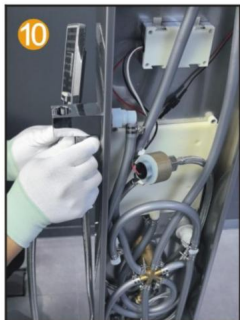

10
Connect the hand spray hose to the handheld one shower head

MODELO 7009FL

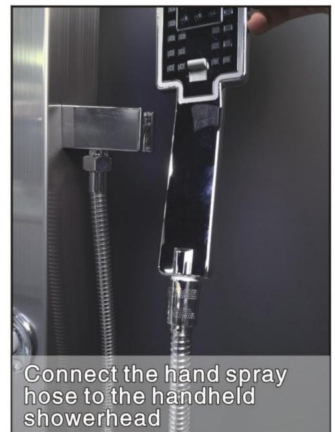
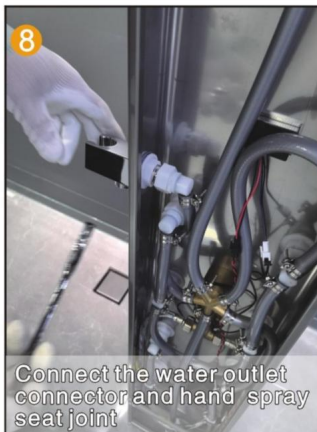
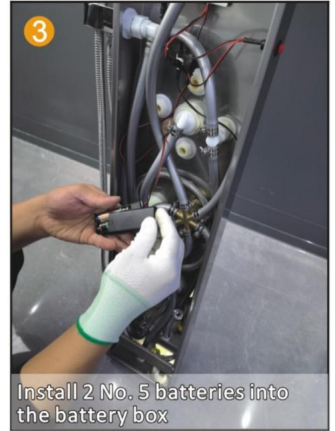
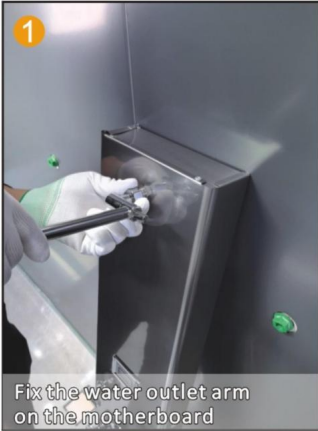

PASOS DE INSTALACIÓN (GENERALES)

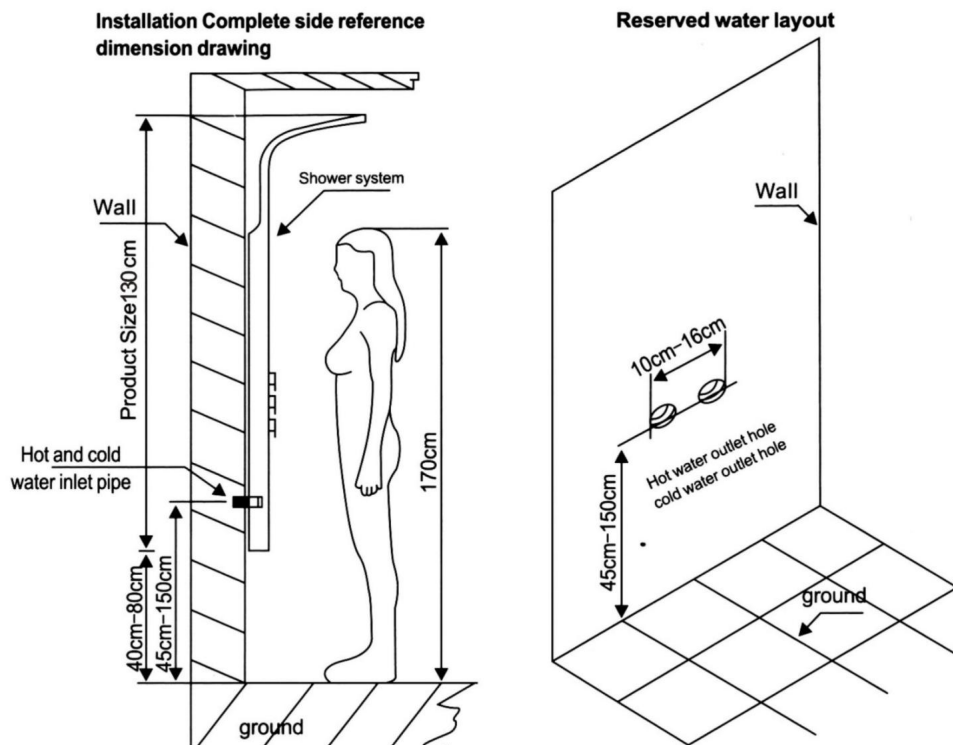

Notas de instalación

1. De acuerdo con la altura de instalación del sistema de ducha económica de altura familiar, mida el sistema de ducha en la parte posterior de la barra. Distancia, márkuela en la pared, en la posición correspondiente de la etiqueta de hierro colgante fijo (arriba y abajo de cada uno).
2. Conecte la manguera de agua fría y caliente (asegúrese de limpiar el cargador y la suciedad de la báscula de pared para no bloquearlo y afectar el efecto del agua).
3. Sistema de ducha colgado en la pared, las dos tarjetas superior e inferior se sujetaron con dos pastas para colgar (Nota: Después de la ducha después de la pared del sistema, el cuerpo principal cerca de la pared no tiembla, no es necesario usar otro pegamento para vidrio y otras herramientas fijas).

Métodos de mantenimiento del sistema de ducha de acero inoxidable:

1. Limpieza periódica del producto para mantener su apariencia brillante y limpio;
2. Limpia la superficie con agua o un detergente suave y sécala con una toalla suave.
3. Tenga en cuenta que el producto limpio de la posición oculta, la limpieza oportuna puede hacer productos duraderos.

ESQUEMA DE INSTALACIÓN SERIE PANELES DE DUCHA

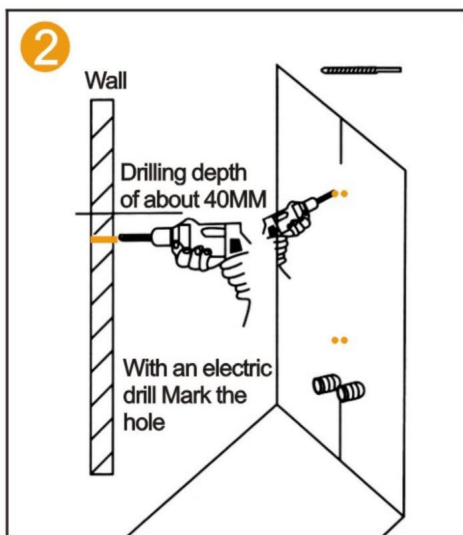
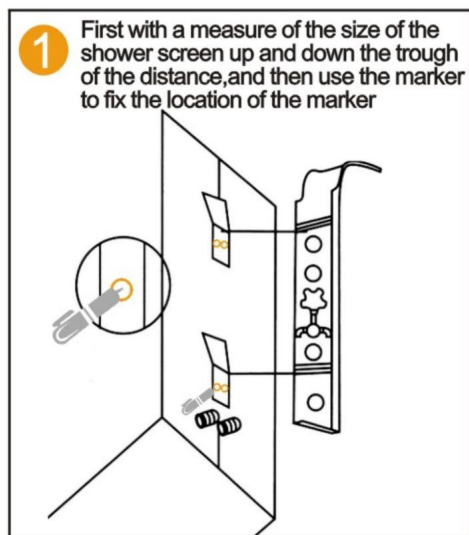

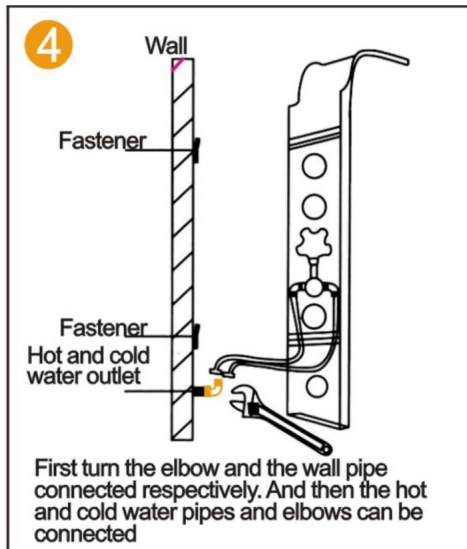
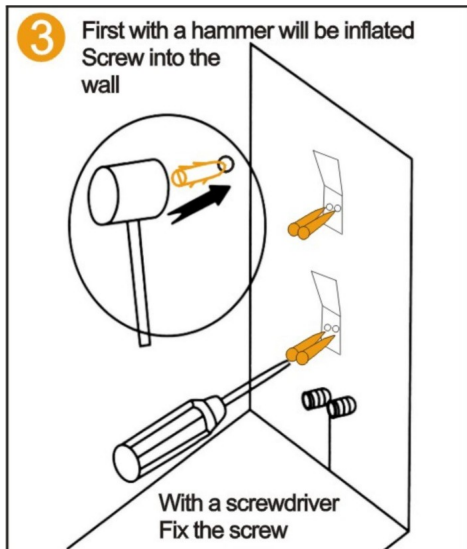

INTRODUCCIÓN A LA FUNCIÓN

8015FL

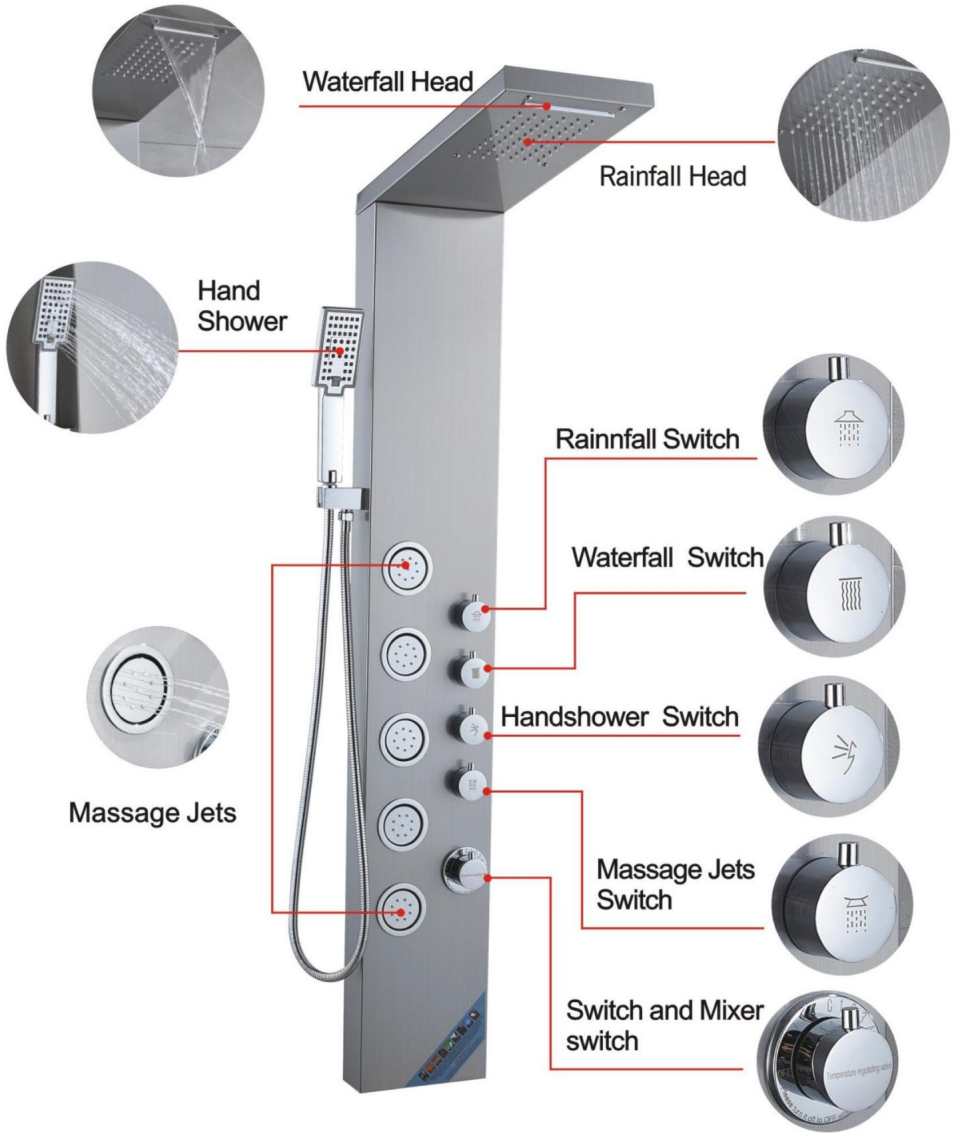

INTRODUCCIÓN A LA FUNCIÓN

6002FL



INTRODUCCIÓN A LA FUNCIÓN

8039FL

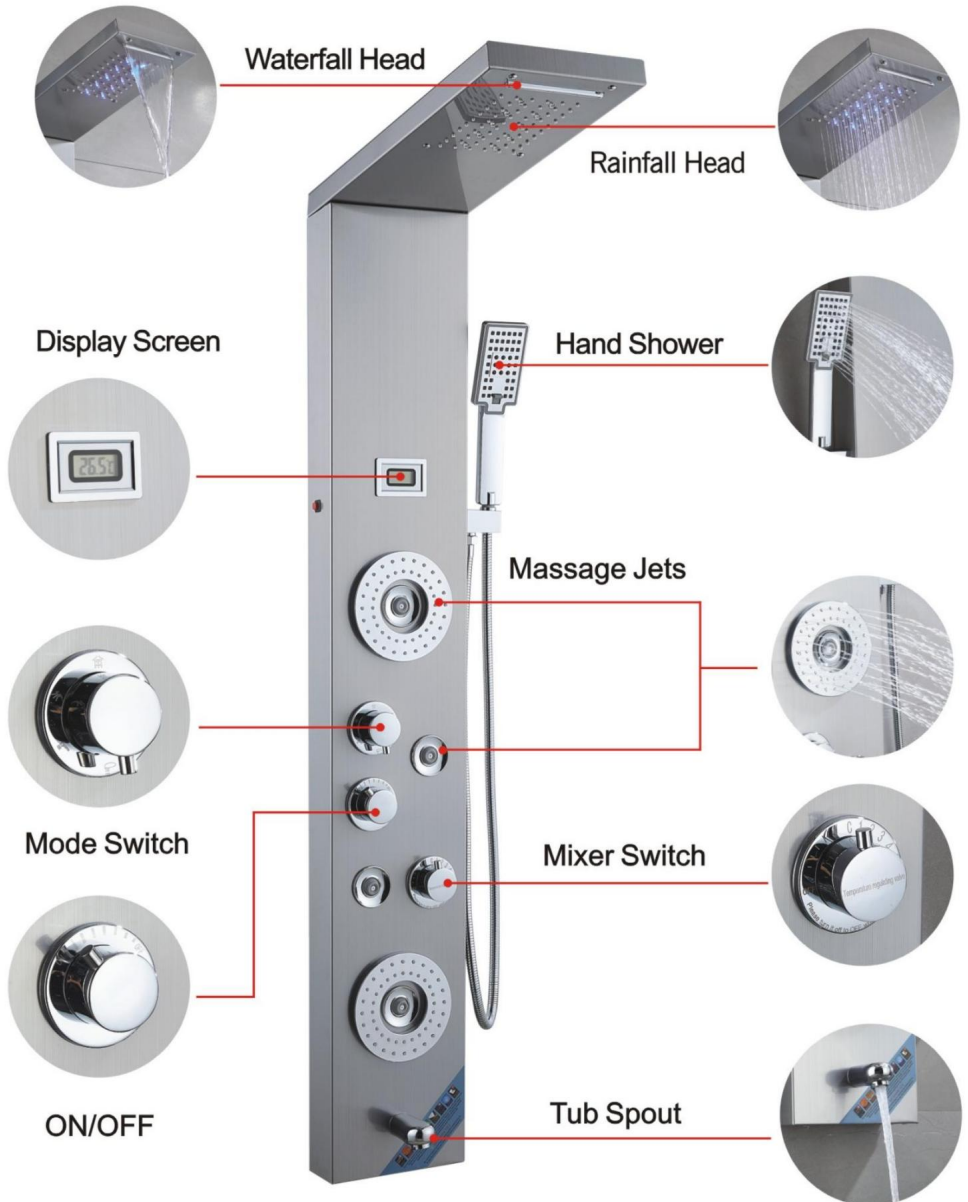

INTRODUCCIÓN A LA FUNCIÓN

8009FL

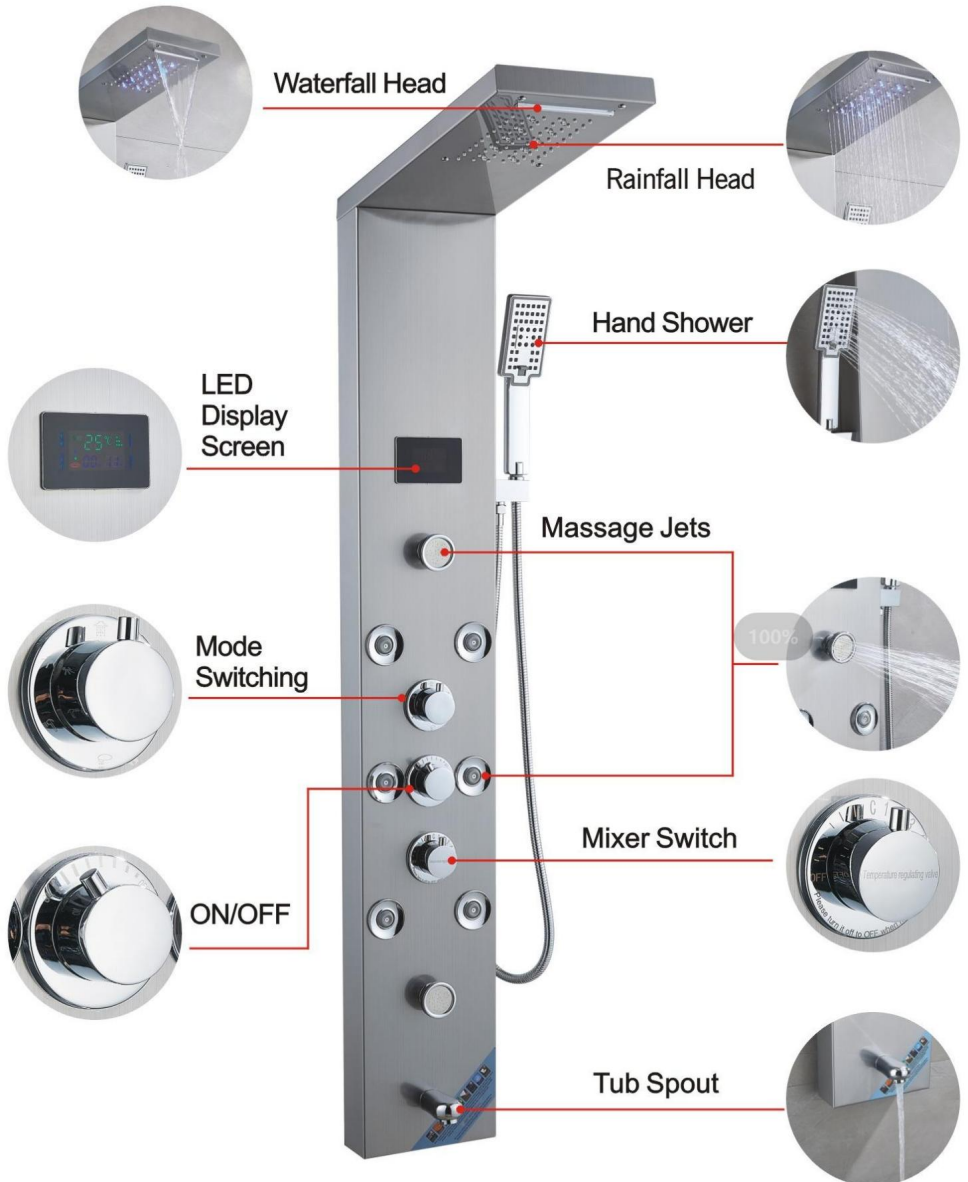

INTRODUCCIÓN A LA FUNCIÓN

8004FL



INTRODUCCIÓN A LA FUNCIÓN

7009FL

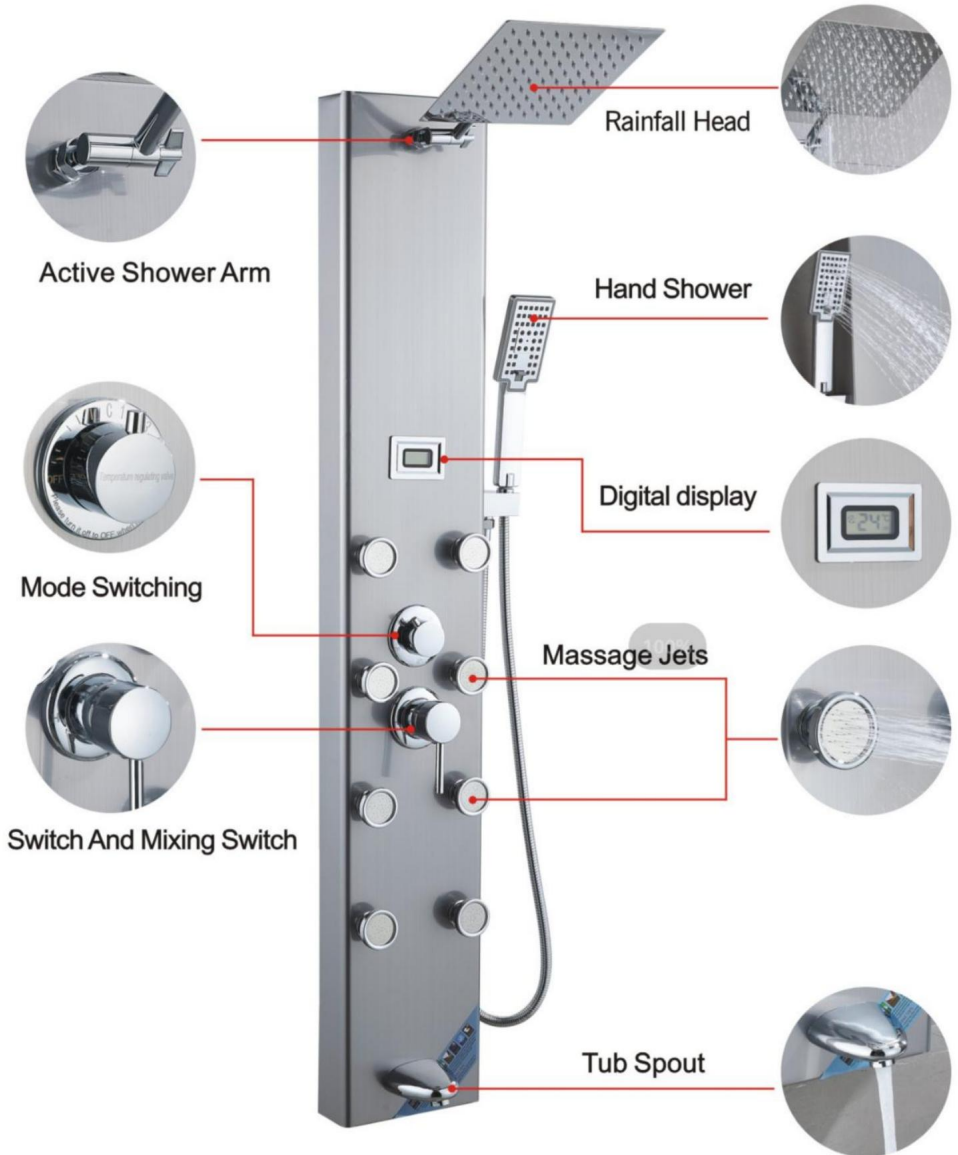

Hecho en china

VEVOR[®]

TOUGH TOOLS, HALF PRICE

Soporte técnico y certificado de garantía
electrónica www.vevor.com/support

VEVOR®

TOUGH TOOLS, HALF PRICE

Wsparcie techniczne i certyfikat e-gwarancji www.vevor.com/support

WIEŻA PANELÓW PRYSZNICOWYCH

MODEL: 8015FL/6002FL/8039FL/8009FL/8004FL/7009FL

Nadal dokładamy wszelkich starań, aby zapewnić Państwu narzędzia w konkurencyjnej cenie.

„Zaoszczędź o połowę”, „o połowę ceny” lub inne podobne wyrażenia używane przez nas przedstawiają jedynie szacunkową oszczędność, jaką możesz uzyskać kupując u nas określone narzędzia w porównaniu z głównymi najlepszymi markami i niekoniecznie oznaczają uwzględnienie wszystkich kategorii oferowanych narzędzi przez nas. Przypominamy, aby podczas składania zamówienia u nas dokładnie sprawdzić, czy faktycznie oszczędzisz połowę w porównaniu z czołowymi markami.

VEVOR®

TOUGH TOOLS, HALF PRICE

WIEŻA PANELÓW PRYSZNICOWYCH



8015FL



6002FL



8039FL



8009FL



8004FL



7009FL



POTRZEBUJĘ POMOCY? SKONTAKTUJ SIĘ Z NAMI!

Masz pytania dotyczące produktu? Potrzebujesz wsparcia technicznego? Proszę, czuj się swobodnie by Skontaktuj się z nami:

Wsparcie techniczne i certyfikat e-gwarancji
www.vevor.com/support

To jest oryginalna instrukcja. Prosimy o zapoznanie się ze wszystkimi instrukcjami zawartymi w instrukcji ostrożnie przed rozpoczęciem pracy. VEVOR zastrzega sobie jasną interpretację naszych instrukcja obsługi. Wygląd produktu podlega produkt, który otrzymałeś. Proszę nam wybaczyć, że nie będziemy Państwa ponownie informować, jeśli są jakieś aktualizacje technologii lub oprogramowania naszego produktu.

WPROWADZENIE PRODUKTÓW

	<p>Ostrzeżenie — aby zmniejszyć ryzyko obrażeń, użytkownik musi przeczytać instrukcję ręcznie.</p>
	<p>PRAWIDŁOWA UTYLIZACJA</p> <p>Ten produkt podlega przepisom Dyrektywy Europejskiej 2012/19/WE. Przekreślony symbol przedstawiający kosz na śmieci na kółkach przez wskazuje, że produkt wymaga osobnego odpadu zbiórka w Unii Europejskiej. Dotyczy to produktu oraz wszystkie akcesoria oznaczone tym symbolem. Produkty oznaczone jako takie nie mogą być wyrzucane razem ze zwykłymi odpadami domowymi, ale należy oddać do punktu zbiórki odpadów elektrycznych i elektrycznych urządzenia elektryczne.</p>

Wskazówki ostrzegawcze:

1. Podczas instalacji najlepiej nosić rękawiczki, aby zapobiec ostrym zjawiskom rogi panelu przed zarysowaniem dłoni.
2. Podczas montażu prysznic należy upewnić się, że wszystkie złącza są dobrze dokręcone, aby uniknąć wycieku wody.
3. Upewnij się, że czerwona i niebieska rura wlotowa wody wewnątrz panelu nie są podłączone w stanie złożonym, aby uniknąć wpływu na ciśnienie wody.
4. Gdy prysznic nie jest używany, zamknij zawór przełączający prysznic.



ZACHOWAJ TE INSTRUKCJE

Informacje FCC

UWAGA: Zmiany lub modyfikacje, które nie zostały wyraźnie zatwierdzone przez stronę odpowiedzialną za zgodność, może unieważnić uprawnienia użytkownika do obsługi sprzętu!

To urządzenie jest zgodne z częścią 15 przepisów FCC. Eksploatacja podlega następującym dwóm warunkom:

- 1) Ten produkt może powodować szkodliwe zakłócenia.
- 2) Ten produkt musi akceptować wszelkie odbierane zakłócenia, w tym zakłócenia, które mogą spowodować niepożądane działanie.

OSTRZEŻENIE: Zmiany lub modyfikacje tego produktu nie są wyraźnie zatwierdzone przez imprezę. Odpowiedzialność za zgodność może unieważnić uprawnienia użytkownika do obsługi produktu.

Uwaga: ten produkt został przetestowany i uznany za zgodny z ograniczeniami danej klasy B urządzenie cyfrowe zgodnie z częścią 15 przepisów FCC. Limity te mają na celu zapewniając odpowiednią ochronę przed szkodliwymi zakłóceniami w budynkach mieszkalnych instalacja.

Ten produkt generuje, wykorzystuje i może emitować energię o częstotliwości radiowej, a jeśli nie, to zainstalowane i używane zgodnie z instrukcją, mogą być szkodliwe zakłócenia w komunikacji radiowej. Jednak nie ma na to gwarancji zakłócenia nie wystąpią w konkretnej instalacji. Jeśli ten produkt powoduje szkodliwe zakłócenia w odbiorze radiowym lub telewizyjnym, które można określić na podstawie: wyłączając i włączając produkt, zachęca się użytkownika do podjęcia próby skorygowania usterek zakłócenia poprzez jeden lub więcej z następujących środków.









- Zmień orientację lub położenie anteny odbiorczej.
- Zwiększ odległość pomiędzy produktem a odbiornikiem.
- Podłącz produkt do gniazdka w obwodzie innym niż ten, do którego podłączony jest produkt odbiornik jest podłączony.
- Skonsultuj się ze sprzedawcą lub doświadczonym technikiem radio-telewizyjnym w celu uzyskania pomocy.

INSTRUKCJE INSTALACJI

Model	8015FL 6002FL	8039FL 8009FL	8004FL 7009FL			
Montowanie	Ściana	Ściana	Ściana	Ściana	Ściana	Ściana
Typ	Uchwyt	Uchwyt	Uchwyt	Uchwyt	Uchwyt	Uchwyt
Połączenie	G1/2"	G1/2"	G1/2"	G1/2"	G1/2"	G1/2"
Nitka						
Funkcje	Cztery Tryby	Pięć Tryby	Sześć Tryby	Sześć Tryby	Sześć Tryby	Pięć Tryby
Wylewka wanny	x					
Temperatura	x	x				
Wyświetlacz						
Lampa LED	x					x
Moc	x	Suche komórki DC3V	Suche komórki DC3V	Hydro Moc (AC6V)	Hydro Moc (AC6V)	Suche komórki DC3V
Ręka Pysznica	3-ustawienie	1-ustawienie	3-ustawienie	3-ustawienie	3-ustawienie	3-ustawienie
Skończyć	System prysznicowy ze szczotkowanego niklu pozbawiony odcisków palców					
Materiał	Stal nierdzewna, mosiądz, PCV, ABS					

LISTA CZĘŚCI

MODEL		8015FL 8039FL 8009FL	6002FL	8004FL	7009FL
M6 nut		4pcs	4pcs	0pcs	0pcs
M6 * 10 screw		4pcs	4pcs	0pcs	0pcs
Hose Clamp		2pcs	2pcs	2pcs	0pcs
M4 * 10 screw		0pcs	0pcs	2pcs	0pcs
Brass shower arm		0pcs	0pcs	0pcs	1pcs
Single function handheld shower		0pcs	1pcs	0pcs	0pcs
Panel cotton bag		1pcs	1pcs	1pcs	1pcs
Top spray cotton bag		1pcs	1pcs	1pcs	0pcs

MODEL		8015FL 8039FL 8009FL	6002FL	8004FL	7009FL
Three function handheld shower		1pcs	0pcs	1pcs	1pcs
1.5 meter hand spray hose		1pcs	1pcs	1pcs	1pcs
Hand spray seat		1pcs	1pcs	1pcs	1pcs
1/2 right angle adapter		2pcs	2pcs	2pcs	2pcs
4-point rubber		2pcs	2pcs	2pcs	2pcs
Self tapping screw		4pcs	4pcs	4pcs	4pcs
Fastener		2pcs	2pcs	2pcs	2pcs
Grommet		1pcs	1pcs	1pcs	1pcs
Hexagon nut		1pcs	1pcs	1pcs	1pcs

INSTRUKCJE SKŁADANIA

MODEL 8015FL/6002FL/8039FL/8009FL



1
Insert the PVC pipe from the top opening To pierce out



2
Route the LED light wire along the hole into the motherboard



3
Fix the motherboard and top spray with 4 pairs of M6 screws and nuts

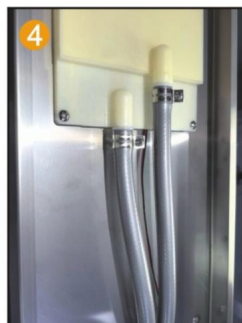

4
Fix the PVC pipe with a throat clamp On the top spray joint

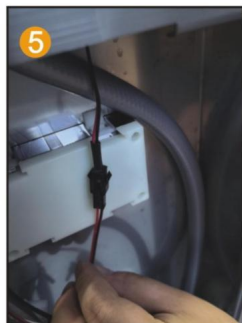

5
Connect the LED light cable and power supplyline

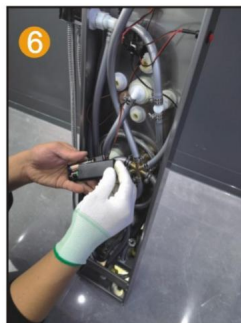

6
Install 2 No. 5 batteries to chargePool box



7
Point the switch of the battery box towards ON



8
Insert the hand spray nozzle into the panel And install the gasket

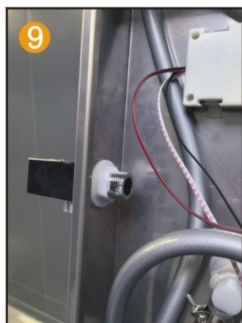

9
Spray socket with hexagonal nut handle Fixed on the panel

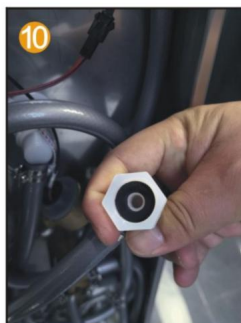

10
Put the 4-point rubber into the hand spray inside the joint of the seat

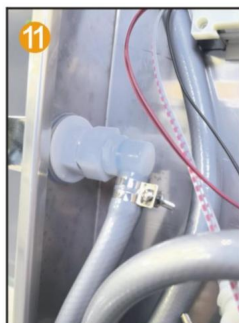

11
Connect the water outlet connector and hand spray Seat joint



12
Connect the hand spray hose to the handheld one shower head

Uwaga: 8015FL nie ma kroków 2, 5, 6 i 7. 8009FL nie ma kroków 6 i 7.

MODEL 8004FL

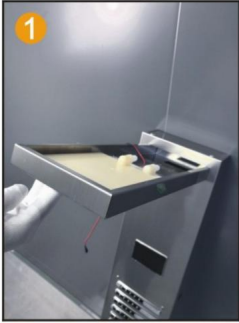

1
Insert the top spray into the motherboard inside the hole



2
Use 2 M4 screws to secure the main fixed plate and top spray



3
Connect PVC pipes and LED light wires through the hole



4
Fix the PVC pipe with a throat clamp on the top spray joint

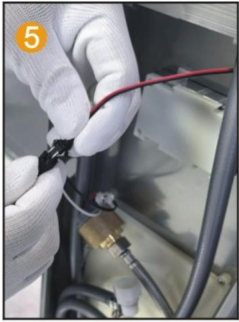

5
Connect the LED light cable and power supply line

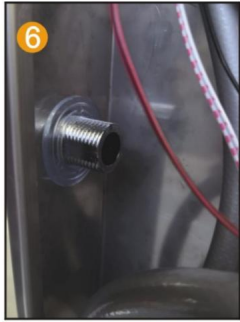

6
Insert the hand spray nozzle into the panel and install the gasket

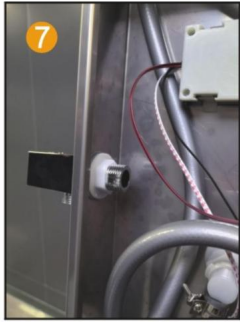

7
Spray socket with hexagonal nut handle fixed on the panel



8
Spray socket with hexagonal nut handle. Fix the 4-point rubber on the panel and spray it by hand inside the seat joint

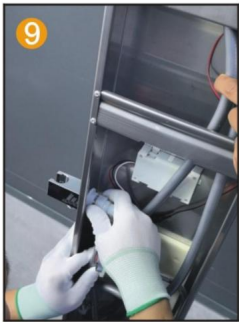

9
Connect the water outlet connector and hand spray nozzle joint

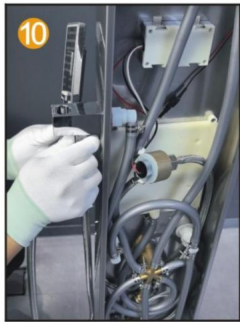

10
Connect the hand spray hose to the handheld shower head

MODEL 7009FL

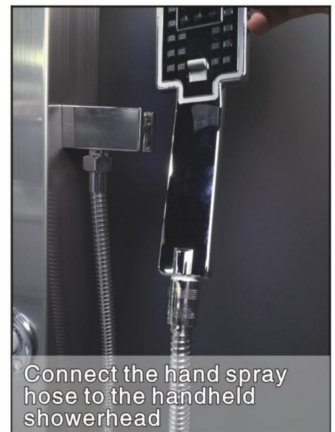
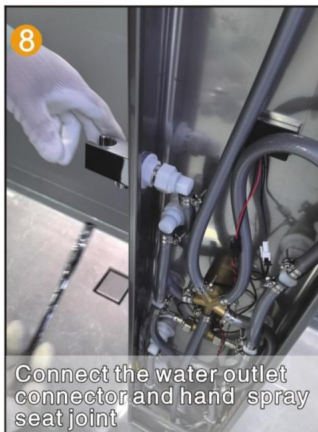
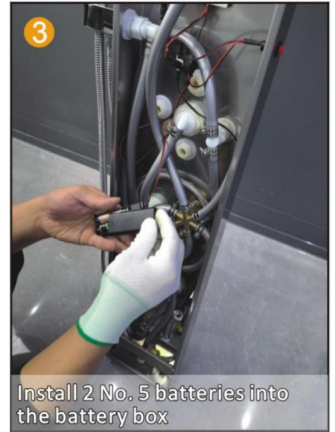

KROKI INSTALACJI (OGÓLNE)

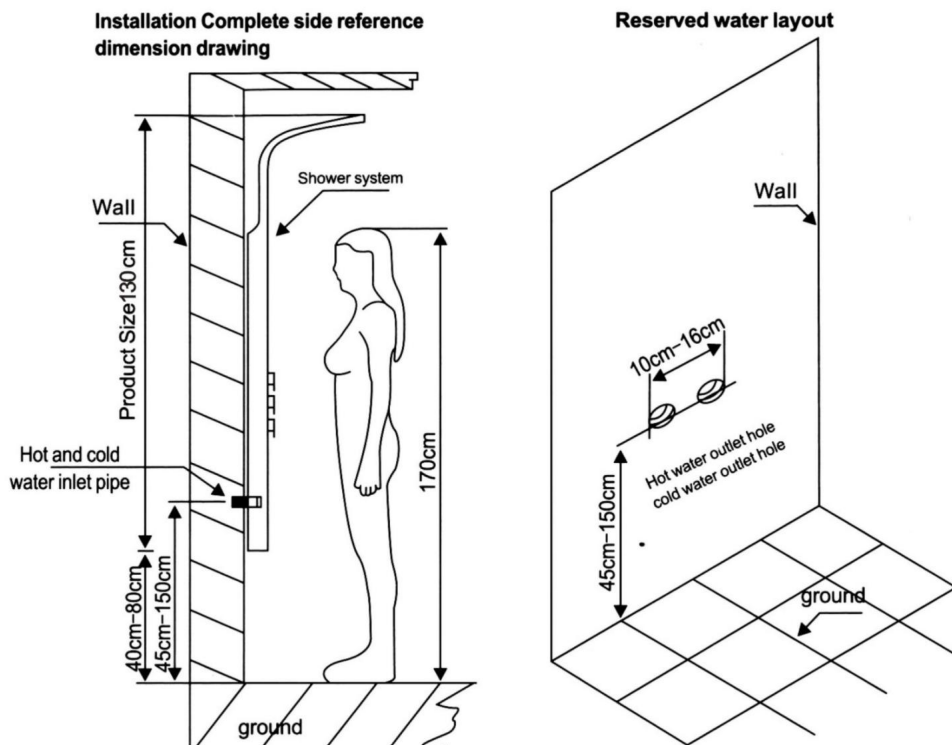

Uwagi dotyczące instalacji

1. W zależności od wysokości instalacji budżetowego systemu prysznicowego, zmierz system prysznicowy z tyłu drążka. Odległość, zaznacz na ścianie, w odpowiedniej pozycji zawieszki przymocowanej do wieszaka (każdy w górę i w dół).
2. Podłącz wąż ciepłej i zimnej wody (pamiętaj o oczyszczeniu magazynka i zabrudzeń w ścianie, aby nie blokować, nie wpływać na działanie wody).
3. System prysznicowy wiszący na ścianie, górna i dolna karta zostały zaciśnięte w dwóch pastach do zawieszania (Uwaga: prysznic Po zamontowaniu ściany systemowej głównej korpus blisko ściany nie drży, nie ma potrzeby stosowania innego kleju do szkła i inne narzędzia naprawiono).

Metody konserwacji systemów prysznicowych ze stali nierdzewnej:

1. Regularne czyszczenie produktu w celu utrzymania jego jasnego i jasnego wyglądu czysty;
2. Oczyszczyć powierzchnię wodą lub łagodnym detergentem i wytrzeć miękkim ręcznikiem.
3. Należy pamiętać, że czysty produkt w ukrytej pozycji może sprawić, że czyszczenie będzie możliwe w odpowiednim czasie produkty trwałe.

SCHEMAT MONTAŻU PANELÓW PRYSZNICOWYCH

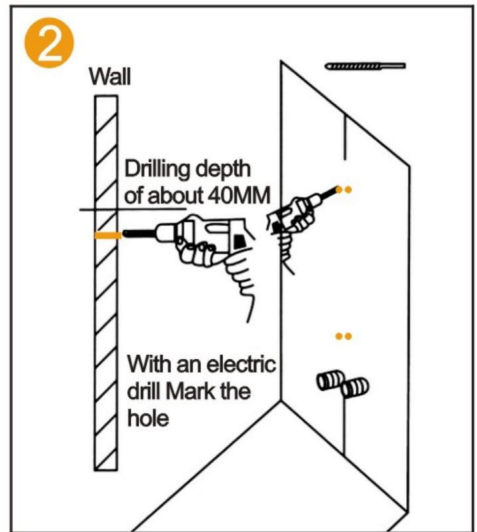
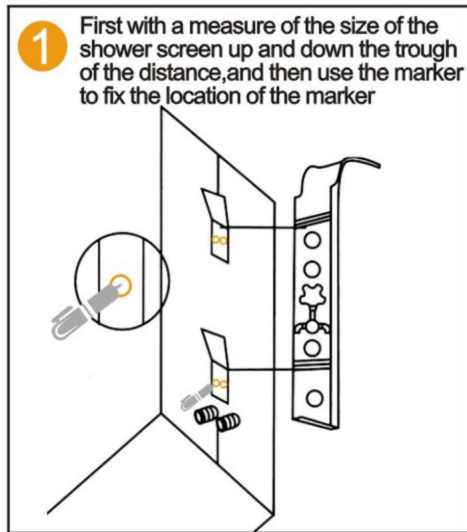

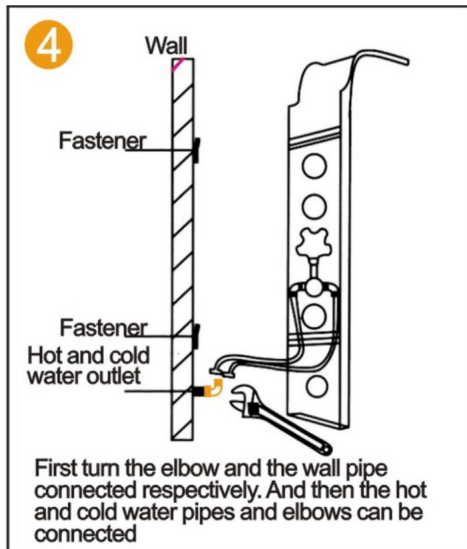
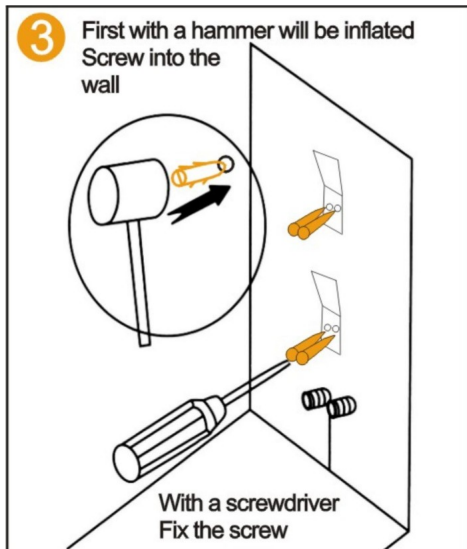

WSTĘP FUNKCJI

8015FL

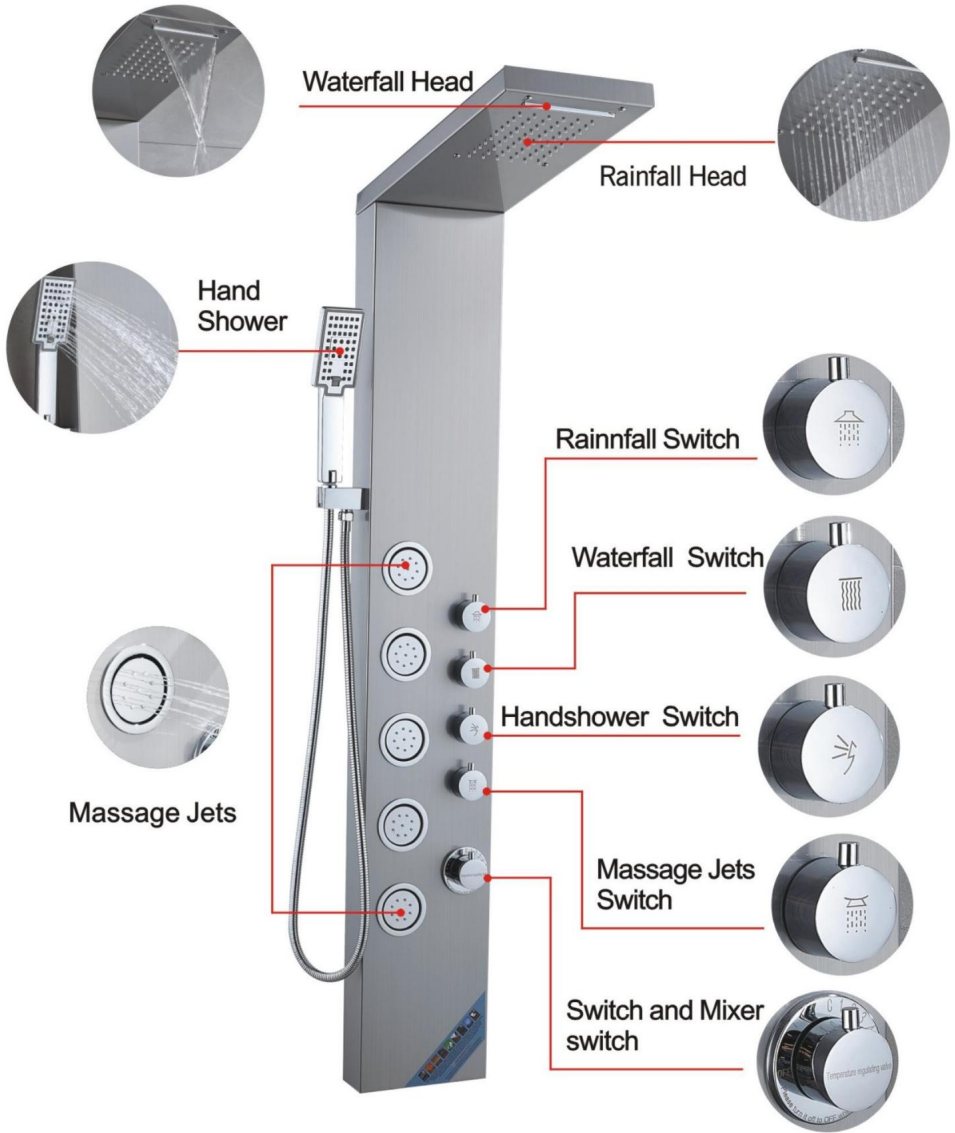

WSTĘP FUNKCJI

6002FL



WSTĘP FUNKCJI

8039FL

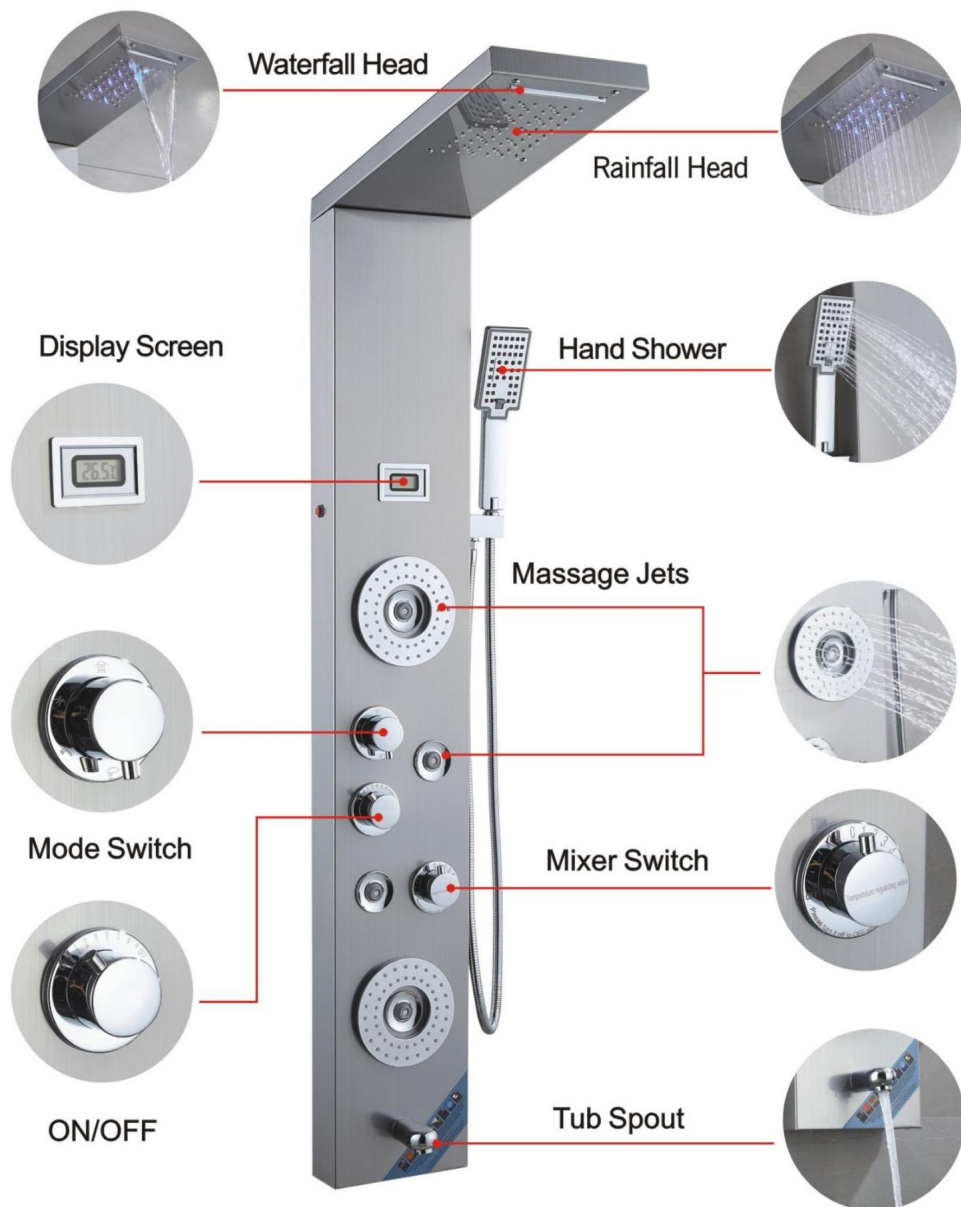

WSTĘP FUNKCJI

8009FL

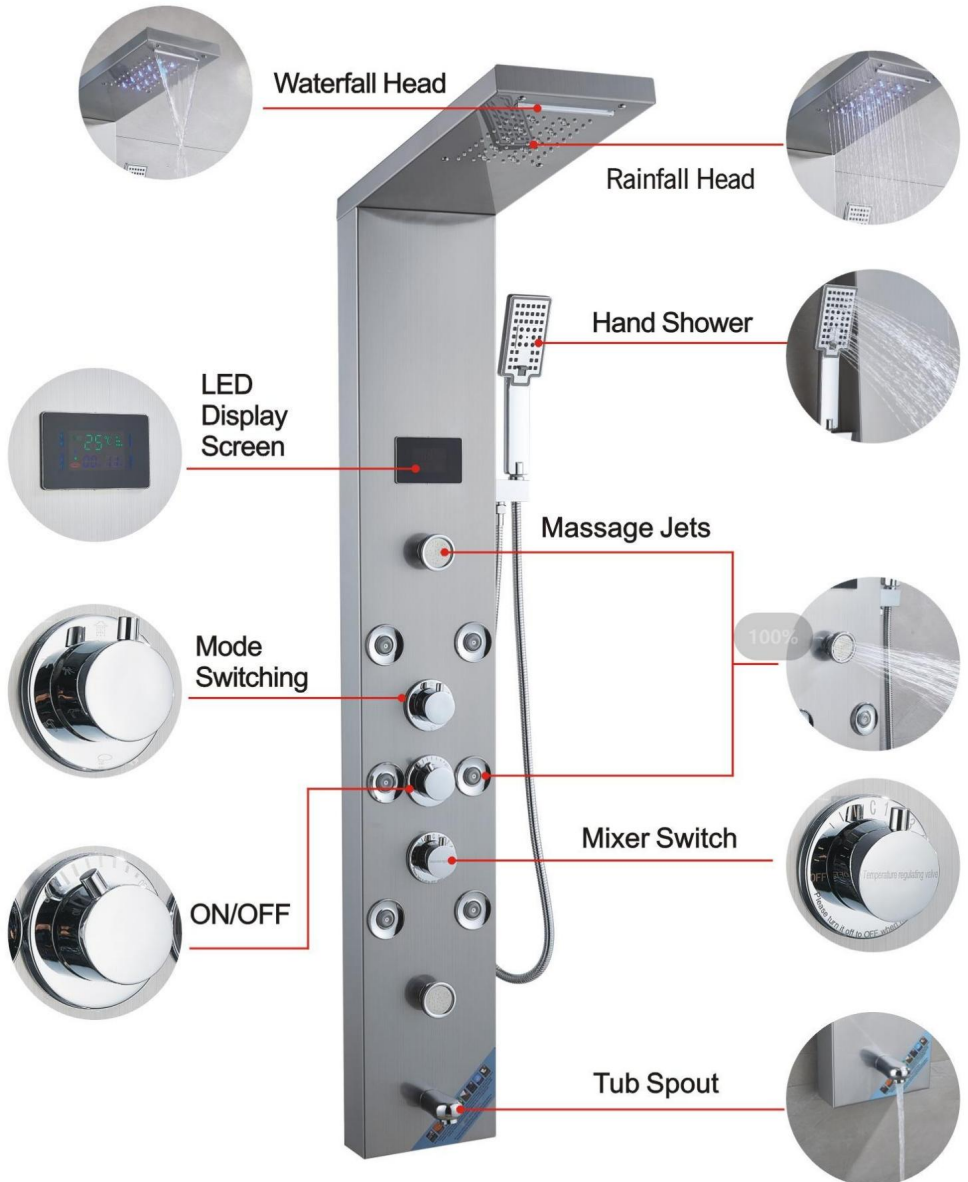

WSTĘP FUNKCJI

8004FL



WSTĘP FUNKCJI

7009FL

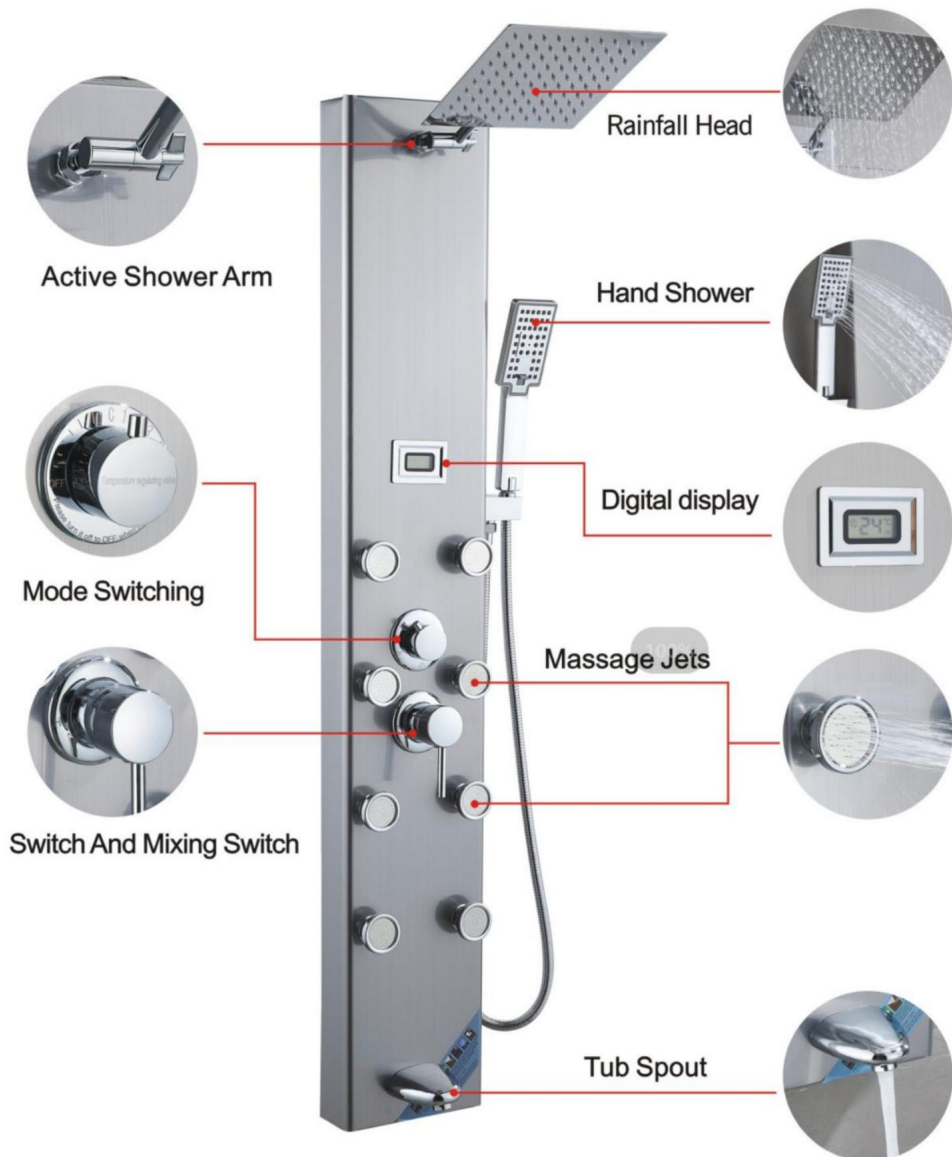

VEVOR[®]

TOUGH TOOLS, HALF PRICE

Wsparcie techniczne i certyfikat e-gwarancji

www.vevor.com/support

VEVOR[®]

TOUGH TOOLS, HALF PRICE

Technische ondersteuning en e-garantiecertificaat www.vevor.com/support

DOUCHE PANEEL TOREN

MODEL:8015FL/6002FL/8039FL/8009FL/8004FL/7009FL

We blijven ons inzetten om u gereedschap tegen een concurrerende prijs te bieden.

"Bespaar de helft", "Halve prijs" of andere soortgelijke uitdrukkingen die door ons worden gebruikt vertegenwoordigt slechts een schatting van de besparingen die u zou kunnen profiteren als u bepaalde gereedschappen bij ons koopt in vergelijking met de grote topmerken en betekent niet noodzakelijkerwijs dat deze alle categorieën van aangeboden gereedschappen omvatten door ons. Wij verzoeken u vriendelijk om bij het plaatsen van een bestelling bij ons goed na te gaan of u daadwerkelijk de helft bespaart in vergelijking met de grote topmerken.

VEVOR®

TOUGH TOOLS, HALF PRICE

DOUCHE PANEEL TOREN



8015FL

6002FL

8039FL

8009FL

8004FL

7009FL

HULP NODIG? NEEM CONTACT MET ONS OP!

Heeft u productvragen? Technische ondersteuning nodig? Voel je vrij om

Neem contact met ons op:

Technische ondersteuning en e-garantiecertificaat
www.vevor.com/support

Dit is de originele instructie, lees alle handleidingen zorgvuldig voordat u ermee aan de slag gaat. VEVOR behoudt zich een duidelijke interpretatie van onze handleiding. Het uiterlijk van het product is onderworpen aan de product dat u heeft ontvangen. Vergeef ons alstublieft dat wij u niet nogmaals informeren er zijn technologie- of software-updates voor ons product.

PRODUCT INTRODUCTIE

	<p>Waarschuwing-Om het risico op letsel te verminderen, moet de gebruiker de instructies lezen handleiding zorgvuldig.</p>
	<p>CORRECTE VERWIJDERING</p> <p>Dit product valt onder de bepalingen van de Europese richtlijn 2012/19/EG. Het symbool met een gekruiste klike through geeft aan dat het product gescheiden afval vereist collectie in de Europese Unie. Dit geldt voor het product en alle accessoires gemarkeerd met dit symbool. Producten gemarkeerd mag als zodanig niet bij het normale huisvuil worden weggegooid, maar moet naar een inzamelpunt worden gebracht voor recycling van elektrische en elektronische apparaten.</p>

Waarschuwingstips:

1. Tijdens het installatieproces kun je het beste handschoenen dragen om scherpte te voorkomen hoeken van het paneel tegen krassen op de handpalm.
2. Zorg er bij het installeren van de douche voor dat alle verbindingen volledig zijn vastgedraaid om waterlekage te voorkomen.
3. Zorg ervoor dat de rode en blauwe waterinlaatleidingen in het paneel zich in een niet-opening bevinden gevouwen staat om te voorkomen dat de waterdruk wordt beïnvloed.
4. Als de douche niet in gebruik is, sluit dan de omschakelkraan van de douche.



BEWAAR DEZE INSTRUCTIES

FCC-informatie

LET OP: Wijzigingen of aanpassingen die niet uitdrukkelijk door de partij zijn goedgekeurd die verantwoordelijk is voor naleving kan de bevoegdheid van de gebruiker om het apparaat te bedienen ongeldig maken apparatuur!

Dit apparaat voldoet aan Deel 15 van de FCC-regels. De werking is onderworpen aan de volgende twee voorwaarden:

- 1) Dit product kan schadelijke interferentie veroorzaken.
- 2) Dit product moet alle ontvangen interferentie accepteren, inclusief interferentie die kan een ongewenste werking veroorzaken.

WAARSCHUWING: Wijzigingen of aanpassingen aan dit product zijn niet uitdrukkelijk goedgekeurd door de partij. De verantwoordelijkheid voor naleving kan de bevoegdheid van de gebruiker daartoe ongeldig maken het product bedienen.

Opmerking: Dit product is getest en voldoet aan de limieten voor een klasse B digitaal apparaat overeenkomstig Deel 15 van de FCC-regels. Deze limieten zijn bedoeld om redelijke bescherming bieden tegen schadelijke interferentie in een woonomgeving installatie.



Dit product genereert, gebruikt en kan radiofrequentie-energie uitstralen, en zo niet geïnstalleerd en gebruikt in overeenstemming met de instructies, kan schadelijk zijn interferentie met radiocommunicatie. Er is echter geen garantie daarvoor. Er zal geen interferentie optreden in een bepaalde installatie. Als dit product dit veroorzaakt schadelijke interferentie voor radio- of televisieontvangst, die kan worden vastgesteld door Als u het product uit- en weer inschakelt, wordt de gebruiker aangemoedigd om te proberen het probleem te corrigeren interferentie door een of meer van de volgende maatregelen.









- Heroriënteer of verplaats de ontvangstantenne.
- Vergroot de afstand tussen het product en de ontvanger.
- Sluit het product aan op een stopcontact op een ander circuit dan dat waarop de ontvanger is aangesloten.
- Raadpleeg de dealer of een ervaren radio-/tv-technicus voor hulp.

INSTALLATIE INSTRUCTIES

Model	8015FL 6002	FL 8039FL 8009	FL 8004FL 7009	FL		
Montage Type	Muur Monteren	Muur Monteren	Muur Monteren	Muur Monteren	Muur Monteren	Muur Monteren
Verbinding Draad	G1/2"	G1/2"	G1/2"	G1/2"	G1/2"	G1/2"
Functies	Vier Modi	Vijf Modi	Zes Modi	Zes Modi	Zes Modi	Vijf Modi
Baduitloop	x	ÿ	ÿ	ÿ	ÿ	ÿ
Temperatuur e Weergave	x	x	ÿ	ÿ	ÿ	ÿ
LED lamp	x	ÿ	ÿ	ÿ	ÿ	x
Stroom	x	Droge cel (DC3V)	Droge cel (DC3V)	Hydro Stroom (AC6V)	Hydro Stroom (AC6V)	Droge cel (DC3V)
Hand Douche	3-instellingen	1-instellingen	3-instellingen	3-instellingen	3-instellingen	3-instellingen
Finish	Vingerafdrukvrij douchesysteem van geborsteld nikkel					
Materiaal	Roestvrij staal, messing, PVC, ABS					

ONDERDELEN LIJST

MODEL		8015FL 8039FL 8009FL	6002FL	8004FL	7009FL
M6 nut		4pcs	4pcs	0pcs	0pcs
M6 * 10 screw		4pcs	4pcs	0pcs	0pcs
Hose Clamp		2pcs	2pcs	2pcs	0pcs
M4 * 10 screw		0pcs	0pcs	2pcs	0pcs
Brass shower arm		0pcs	0pcs	0pcs	1pcs
Single function handheld shower		0pcs	1pcs	0pcs	0pcs
Panel cotton bag		1pcs	1pcs	1pcs	1pcs
Top spray cotton bag		1pcs	1pcs	1pcs	0pcs

MODEL		8015FL 8039FL 8009FL	6002FL	8004FL	7009FL
Three function handheld shower		1pcs	0pcs	1pcs	1pcs
1.5 meter hand spray hose		1pcs	1pcs	1pcs	1pcs
Hand spray seat		1pcs	1pcs	1pcs	1pcs
1/2 right angle adapter		2pcs	2pcs	2pcs	2pcs
4-point rubber		2pcs	2pcs	2pcs	2pcs
Self tapping screw		4pcs	4pcs	4pcs	4pcs
Fastener		2pcs	2pcs	2pcs	2pcs
Grommet		1pcs	1pcs	1pcs	1pcs
Hexagon nut		1pcs	1pcs	1pcs	1pcs

MONTAGE-INSTRUCTIES

MODEL8015FL/6002FL/8039FL/8009FL



1
Insert the PVC pipe from the top opening To pierce out



2
Route the LED light wire along the hole Insert into the motherboard



3
Fix the motherboard and top spray with 4 pairs of M6 screws and nuts

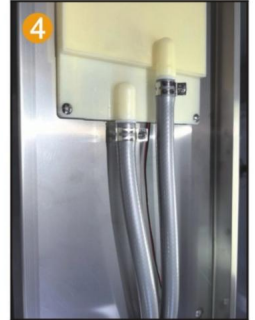

4
Fix the PVC pipe with a throat clamp On the top spray joint

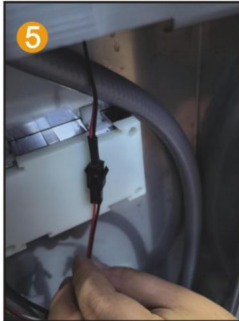

5
Connect the LED light cable and power supplyline



6
Install 2 No. 5 batteries to charge Pool box



7
Point the switch of the battery box towards ON



8
Insert the hand spray nozzle into the panel And install the gasket



9
Spray socket with hexagonal nut handle Fixed on the panel

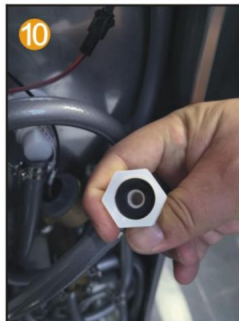

10
Put the 4-point rubber into the hand spray Inside the joint of the seat

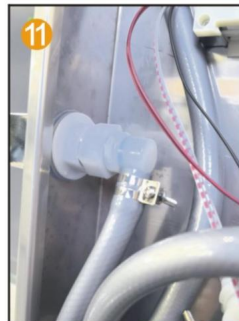

11
Connect the water outlet connector and hand spray Seat joint



12
Connect the hand spray hose to the handheld one shower head

Opmerking: de 8015FL heeft geen stappen 2, 5, 6 en 7. 8009FL heeft geen stappen 6 en 7.

MODEL 8004FL

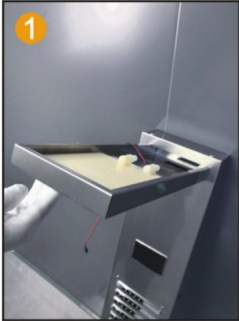

1
Insert the top spray into the motherboard inside the hole



2
Use 2 M4 screws to secure the main fixed plate and top spray

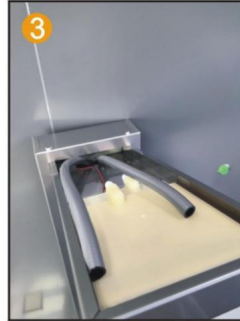

3
Connect PVC pipes and LED light wires through the hole



4
Fix the PVC pipe with a throat clamp on the top spray joint

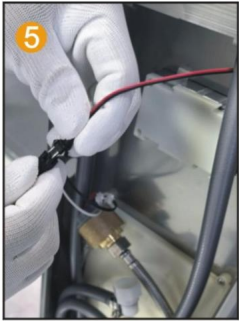

5
Connect the LED light cable and power supply line

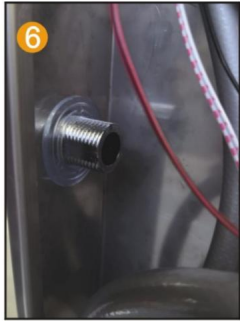

6
Insert the hand spray nozzle into the panel and install the gasket

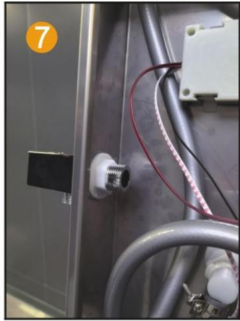

7
Spray socket with hexagonal nut handle fixed on the panel

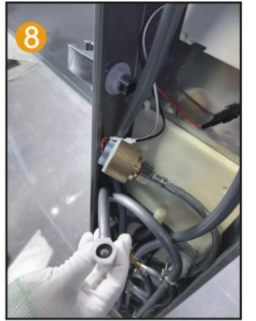

8
Spray socket with hexagonal nut handle. Fix the 4-point rubber on the panel and spray it by hand inside the seat joint

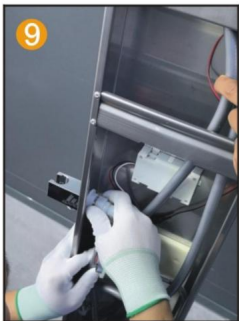

9
Connect the water outlet connector and hand spray seat joint

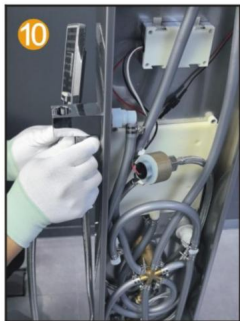

10
Connect the hand spray hose to the handheld shower head

MODEL 7009FL

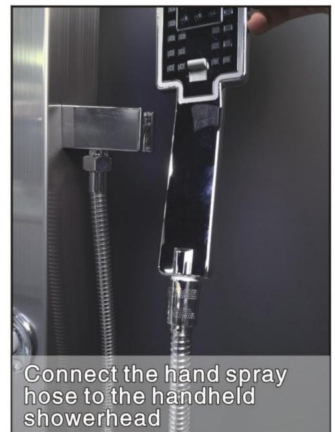
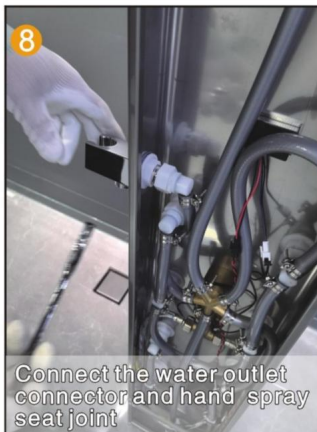
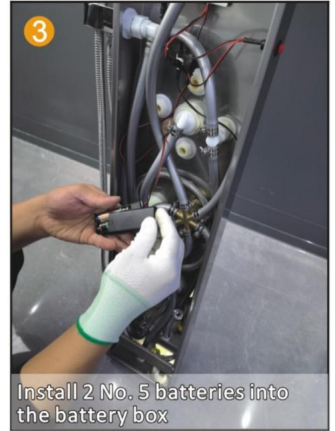
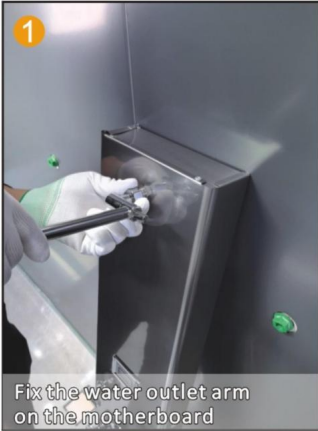

INSTALLATIESTAPPEN (ALGEMEEN)

Installation Complete side reference dimension drawing

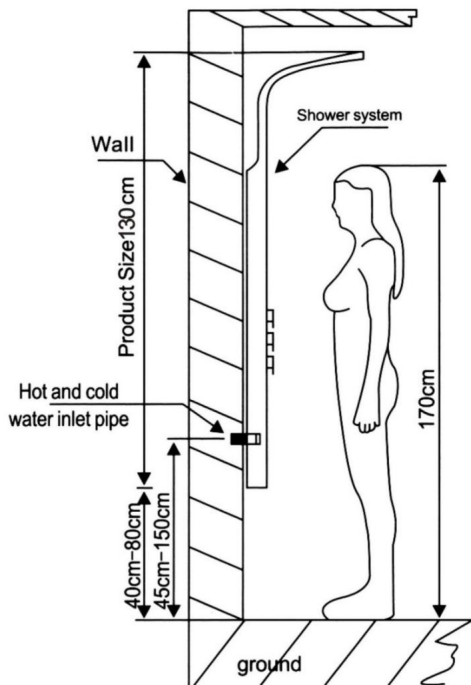

Reserved water layout

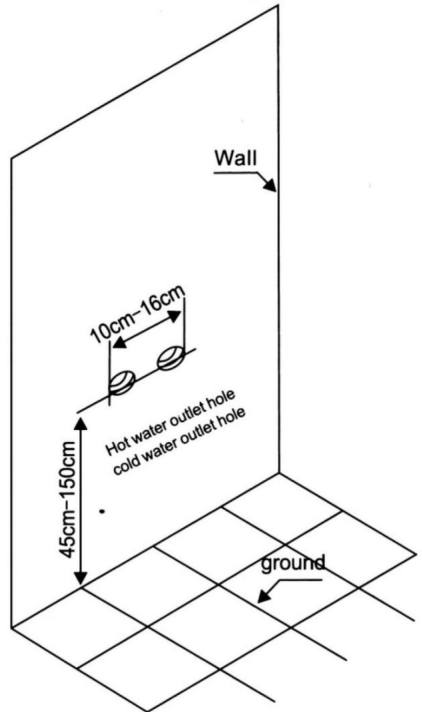

gebruikshandleiding

1. Meet, afhankelijk van de hoogte van de installatiehoogte van het budget-douchesysteem, het douchesysteem aan de achterkant van de bar. Afstand, markeer op de muur, in de overeenkomstige positie van het vaste hangijzer van het label (elk op en neer) .
2. Sluit de warm- en koudwaterslang aan (zorg ervoor dat u het magazijn en het vuil in de muur schoonmaakt, zodat het niet verstopt raakt en het watereffect wordt beïnvloed).
3. Douchesysteem hangt aan de muur, de bovenste en onderste twee kaarten zijn in twee ophangpasta's geklemd (Opmerking: douche Na de systeemmuur trilt het hoofdgedeelte dicht bij de muur niet, je hoeft geen andere glaslijm te gebruiken en ander gereedschap gerepareerd).

Onderhoudsmethoden voor roestvrijstalen douchesystemen:

1. Regelmatige reiniging van het product om het uiterlijk helder en helder te houden schoon;
2. Maak het oppervlak schoon met water of een mild schoonmaakmiddel en veeg het af met een zachte handdoek.
3. Houd er rekening mee dat het schone product van de verborgen positie tijdig kan worden schoongemaakt producten blijvend.

DOUCHE PANEEL SERIE INSTALLATIESHEMA

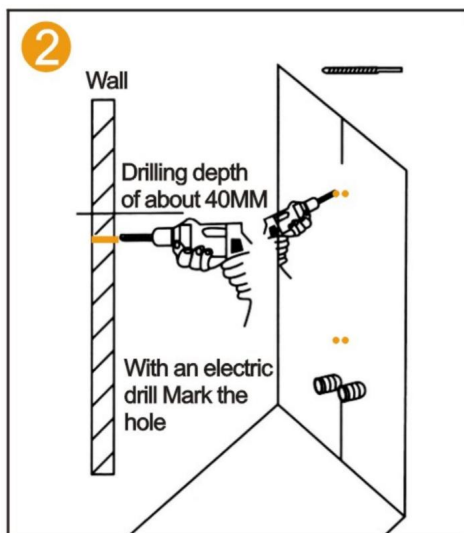
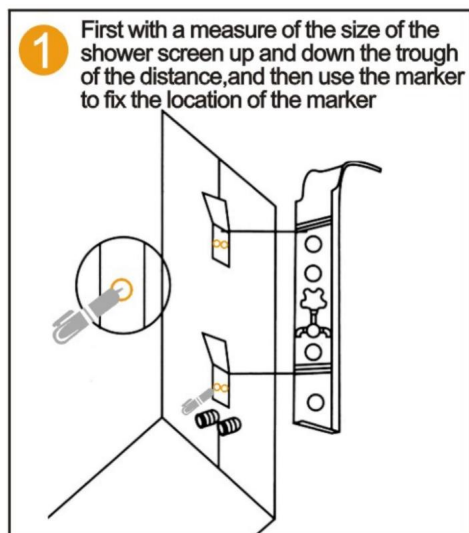

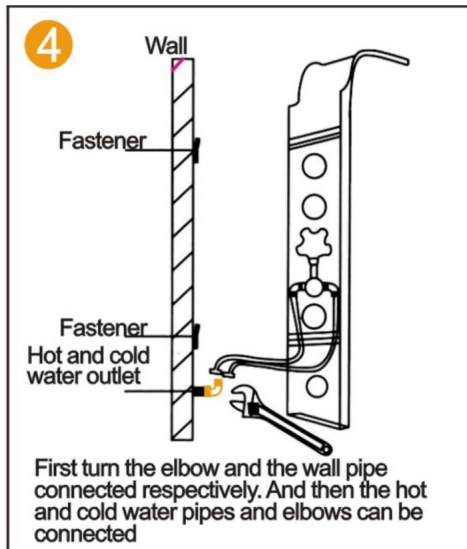
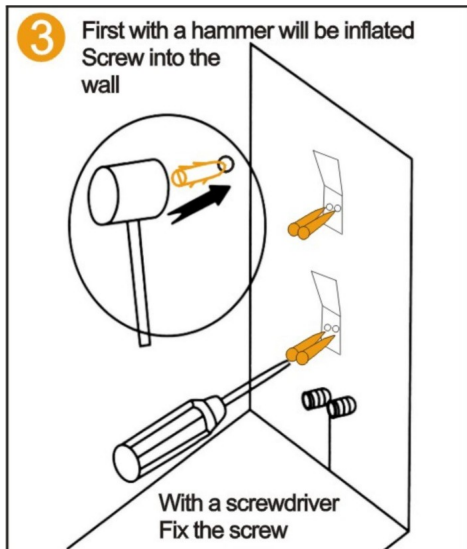

FUNCTIE INLEIDING

8015FL

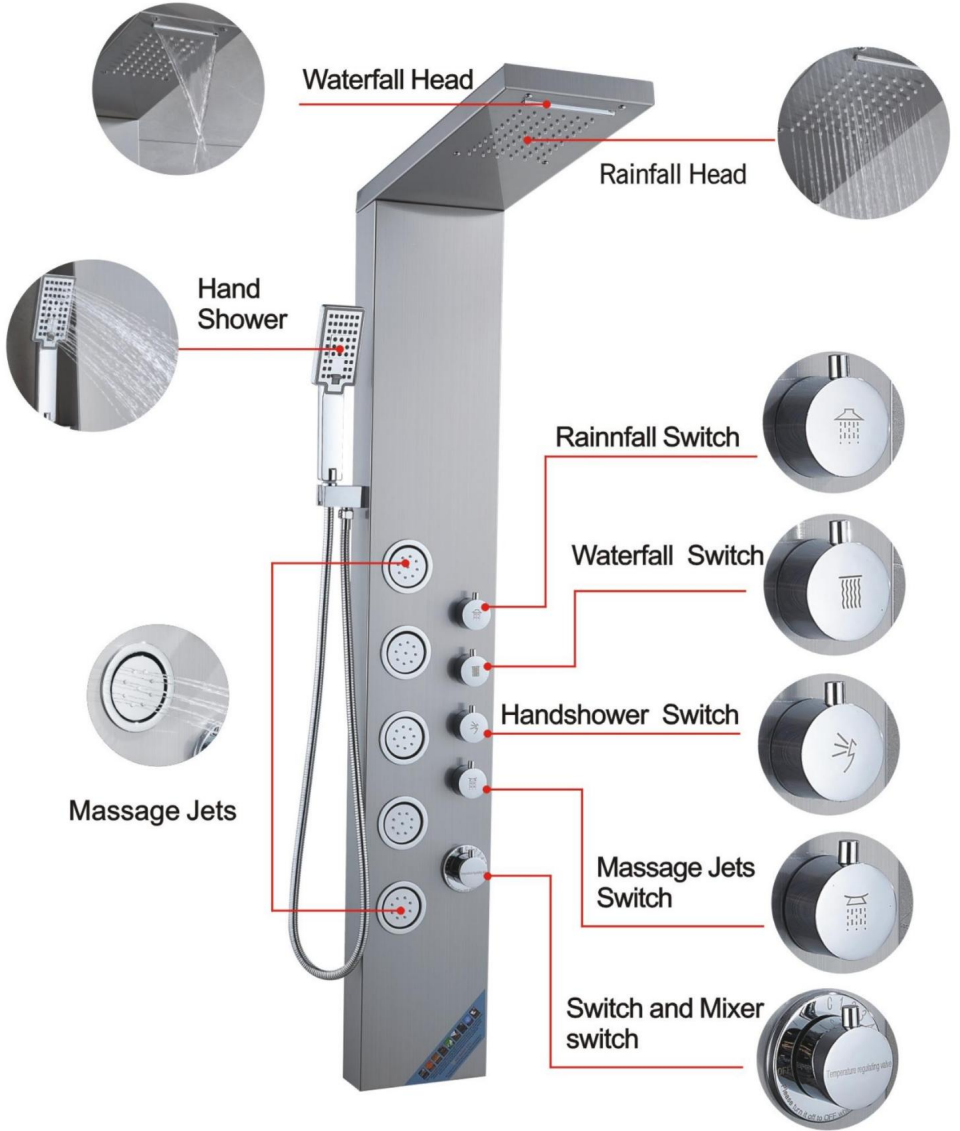

FUNCTIE INLEIDING

6002FL



FUNCTIE INLEIDING

8039FL

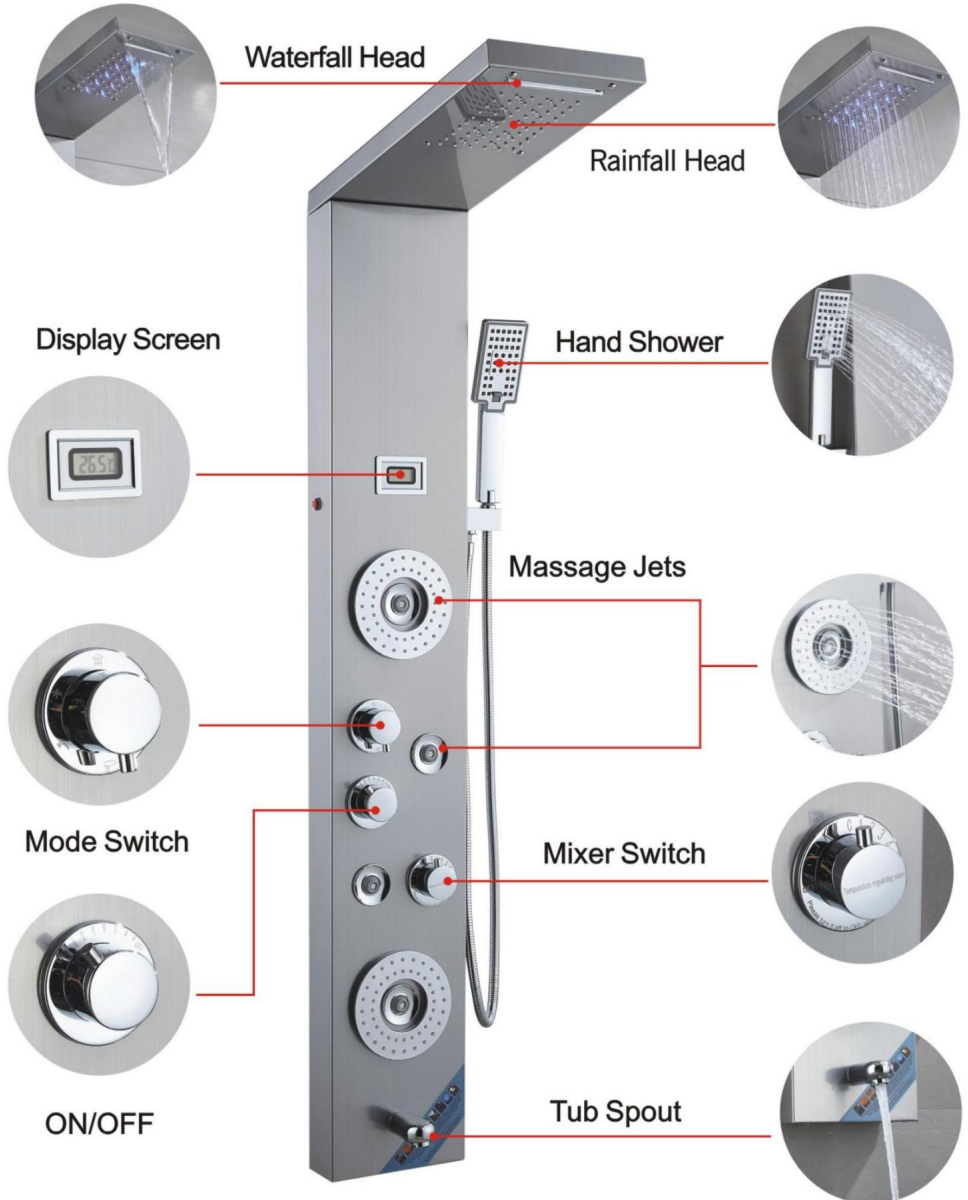

FUNCTIE INLEIDING

8009FL

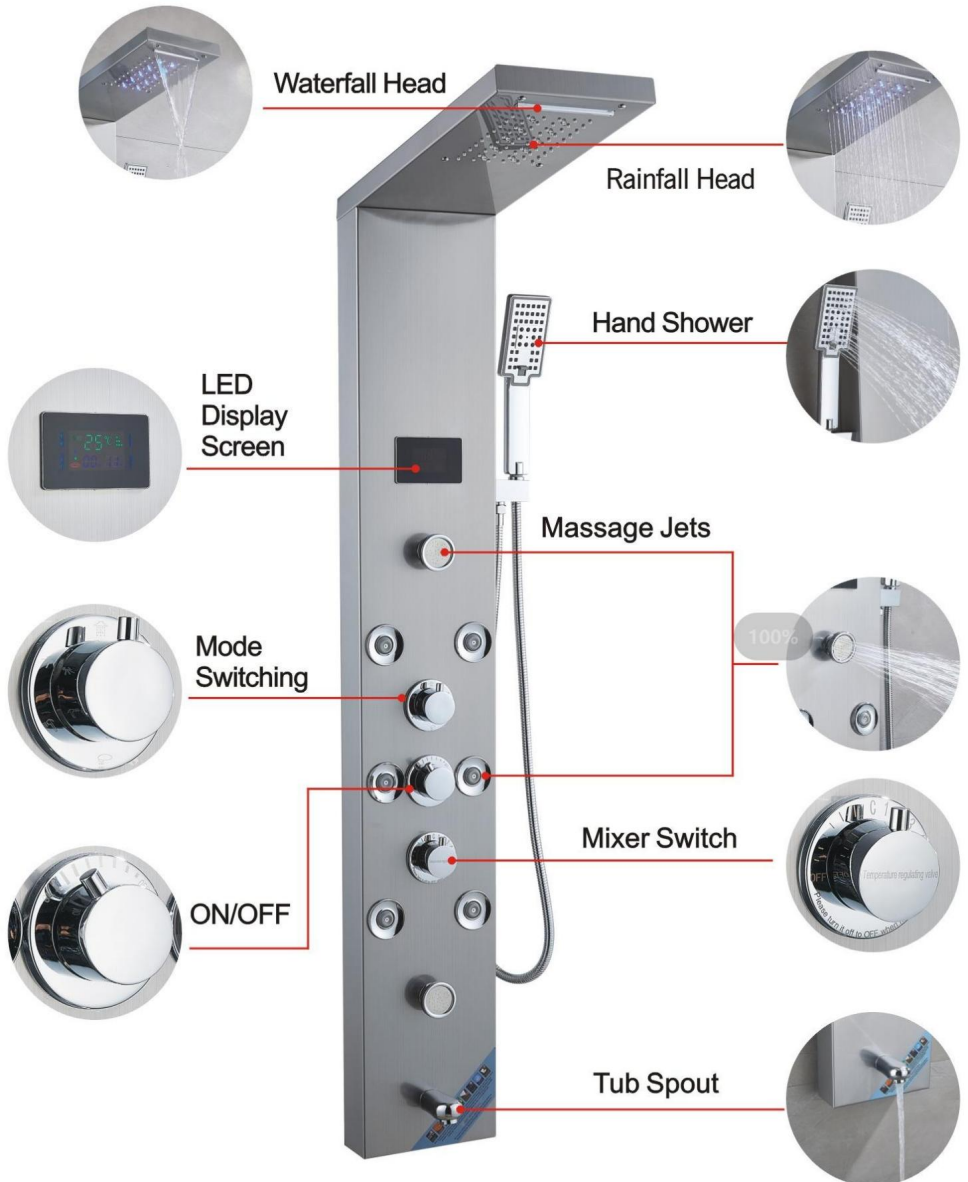

FUNCTIE INLEIDING

8004FL



FUNCTIE INLEIDING

7009FL

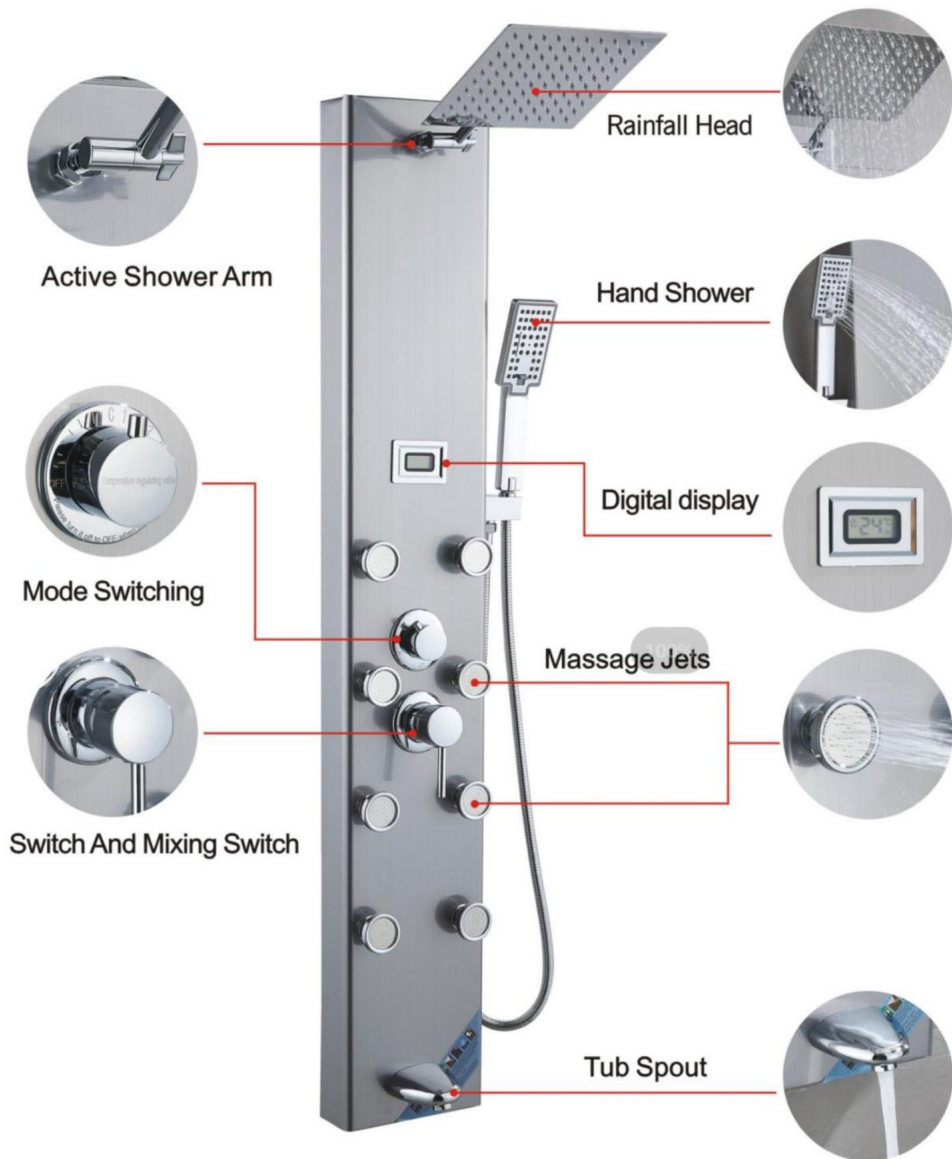

Gemaakt in China

VEVOR[®]

TOUGH TOOLS, HALF PRICE

Technische ondersteuning en e-
garantiecertificaat www.vevor.com/support

VEVOR[®]

TOUGH TOOLS, HALF PRICE

Teknisk support och e-garanticertifikat www.vevor.com/support

DUSHPANELTORN

MODELL:8015FL/6002FL/8039FL/8009FL/8004FL/7009FL

Vi fortsätter att vara engagerade i att ge dig verktyg till konkurrenskraftiga priser.

"Spara hälften", "halva priset" eller andra liknande uttryck som används av oss representerar bara en uppskattning av besparingar du kan dra nytta av att köpa vissa verktyg hos oss jämfört med de stora toppmärkena och betyder inte nödvändigtvis att täcka alla kategorier av verktyg som erbjuds av oss. Du påminns vänligen om att noggrant kontrollera när du gör en beställning hos oss om du faktiskt sparar hälften i jämförelse med de främsta stora varumärkena.

VEVOR®

TOUGH TOOLS, HALF PRICE

DUSCHPANELTORN



8015FL

6002FL

8039FL

8009FL

8004FL

7009FL



BEHÖVS HJÄLP? KONTAKTA OSS!

Har du produktfrågor? Behöver du teknisk support? Du får gärna kontakta oss:

Teknisk support och e-garanticertifikat
www.vevor.com/support

Detta är den ursprungliga instruktionen, läs alla manualer noggrant innan användning. VEVOR reserverar sig för en tydlig tolkning av vår användarmanual. Produktens utseende ska vara beroende av produkt du fått. Förlåt oss att vi inte kommer att informera dig igen om det finns någon teknik eller mjukvaruuppdateringar på vår produkt.

PRODUKT INTRODUKTION

	<p>Varning - För att minska risken för skada måste användaren läsa instruktionerna handbok noggrant.</p>
	<p>KORREKT AVFALLSHANTERING</p> <p>Denna produkt omfattas av bestämmelserna i det europeiska direktivet 2012/19/EG. Symbolen som visar en soptunna korsad genom indikerar att produkten kräver separat avfall insamling i Europeiska unionen. Detta gäller produkten och alla tillbehör märkta med denna symbol. Produkter märkta får som sådan inte slängas med vanligt hushållsavfall men måste lämnas till en samlingsplats för återvinning av elektriska och elektroniska apparater.</p>

Varningstips:

1. Under installationsprocessen är det bäst att bära handskar för att förhindra vassa hörn på panelen från att repa handflatan.
2. När du installerar duschen, se till att alla skarvar är helt åtdragna för att undvika vattenläckage.
3. Se till att de röda och blå vatteninloppsroren inuti panelen är i ett icke hopvikt tillstånd för att undvika att vattentrycket påverkas.
4. När duschen inte används, stäng duschens omkopplingsventil.



SPARA DESSA INSTRUKTIONER

FCC-information

VARNING: Ändringar eller modifieringar som inte uttryckligen godkänts av parten ansvarig för efterlevnad kan ogiltigförklara användarens behörighet att använda Utrustning!

Denna enhet uppfyller del 15 av FCC-reglerna. Driften är föremål för följande två villkor:

- 1) Denna produkt kan orsaka skadliga störningar.
- 2) Denna produkt måste acceptera alla mottagna störningar, inklusive störningar som kan orsaka oönskad funktion.

VARNING: Ändringar eller modifieringar av denna produkt är inte uttryckligen godkända av partiet. Ansvar för efterlevnad kan ogiltigförklara användarens behörighet att använda produkten.

Obs: Denna produkt har testats och befunnits överensstämma med gränserna för en klass B digital enhet i enlighet med del 15 av FCC-reglerna. Dessa gränser är utformade för att tillhandahålla rimligt skydd mot skadliga störningar i ett boende installation.

Denna produkt genererar, använder och kan utstråla radiofrekvensenergi, och om inte installeras och används i enlighet med instruktionerna, kan orsaka skadliga störningar på radiokommunikation. Det finns dock ingen garanti för det störningar kommer inte att inträffa i en viss installation. Om denna produkt orsakar skadliga störningar på radio- eller tv-mottagning, som kan fastställas av stänger av och sätter på produkten, uppmanas användaren att försöka korrigera störning av en eller flera av följande åtgärder.









- Rikta om eller flytta mottagningsantennen.
- Öka avståndet mellan produkten och mottagaren.
- Anslut produkten till ett uttag på en annan krets än den till vilken mottagaren är ansluten.
- Kontakta återförsäljaren eller en erfaren radio/TV-tekniker för hjälp.

INSTALLATIONS INSTRUKTIONER

Modell	8015FL 6002FL	8039FL 8009FL	8004FL 7009FL			
Montering Typ	Vägg Montera	Vägg Montera	Vägg Montera	Vägg Montera	Vägg Montera	Vägg Montera
Förbindelse Tråd	G1/2"	G1/2"	G1/2"	G1/2"	G1/2"	G1/2"
Funktioner	Fyra Lägen	Fem Lägen	Sex Lägen	Sex Lägen	Sex Lägen	Fem Lägen
Badkarspip	×	ÿ	ÿ	ÿ	ÿ	ÿ
Temperatur e Display	×	×	ÿ	ÿ	ÿ	ÿ
LED lampa	×	ÿ	ÿ	ÿ	ÿ	×
Kraft	×	Torr cell ÿDC3Vÿ	Torr cell ÿDC3Vÿ	Hydro Kraft ÿAC6Vÿ	Hydro Kraft ÿAC6Vÿ	Torr cell ÿDC3Vÿ
Hand Dusch	3-Setting 1-Setting	3-Setting	3-Setting	3-Setting		
Avsluta	Duschsystem av borstat nickel utan fingeravtryck					
Material	Rostfritt stål, mässing, PVC, ABS					

DELLISTA

MODEL		8015FL 8039FL 8009FL	6002FL	8004FL	7009FL
M6 nut		4pcs	4pcs	0pcs	0pcs
M6 * 10 screw		4pcs	4pcs	0pcs	0pcs
Hose Clamp		2pcs	2pcs	2pcs	0pcs
M4 * 10 screw		0pcs	0pcs	2pcs	0pcs
Brass shower arm		0pcs	0pcs	0pcs	1pcs
Single function handheld shower		0pcs	1pcs	0pcs	0pcs
Panel cotton bag		1pcs	1pcs	1pcs	1pcs
Top spray cotton bag		1pcs	1pcs	1pcs	0pcs

MODEL		8015FL 8039FL 8009FL	6002FL	8004FL	7009FL
Three function handheld shower		1pcs	0pcs	1pcs	1pcs
1.5 meter hand spray hose		1pcs	1pcs	1pcs	1pcs
Hand spray seat		1pcs	1pcs	1pcs	1pcs
1/2 right angle adapter		2pcs	2pcs	2pcs	2pcs
4-point rubber		2pcs	2pcs	2pcs	2pcs
Self tapping screw		4pcs	4pcs	4pcs	4pcs
Fastener		2pcs	2pcs	2pcs	2pcs
Grommet		1pcs	1pcs	1pcs	1pcs
Hexagon nut		1pcs	1pcs	1pcs	1pcs

MONTERINGSANVISNINGAR

MODELL 8015FL/6002FL/8039FL/8009FL



1
Insert the PVC pipe from the top opening To pierce out



2
Route the LED light wire along the hole Insert into the motherboard



3
Fix the motherboard and top spray with 4 pairs of M6 screws and nuts

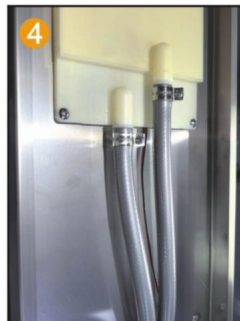

4
Fix the PVC pipe with a throat clamp On the top spray joint

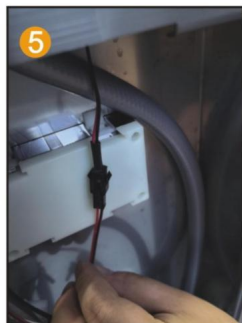

5
Connect the LED light cable and power supplyline

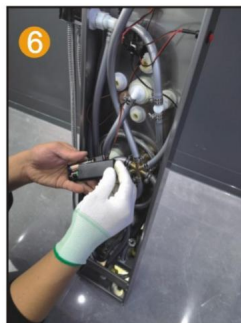

6
Install 2 No. 5 batteries to charge Pool box



7
Point the switch of the battery box towards ON



8
Insert the hand spray nozzle into the panel And install the gasket

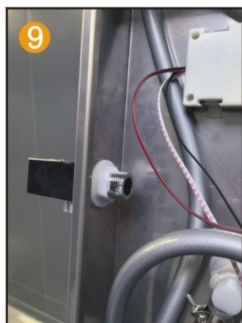

9
Spray socket with hexagonal nut handle Fixed on the panel

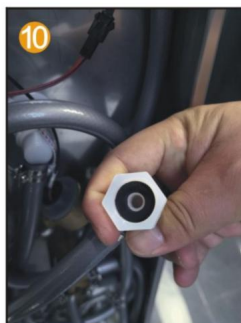

10
Put the 4-point rubber into the hand spray Inside the joint of the seat

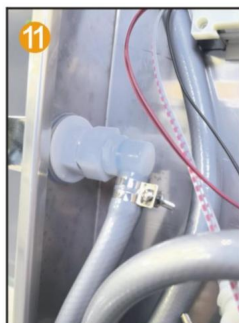

11
Connect the water outlet connector and hand spray Seat joint



12
Connect the hand spray hose to the handheld one shower head

Obs: 8015FL har inte steg 2, 5, 6 och 7. 8009FL har inte steg 6 och 7.

MODELL 8004FL

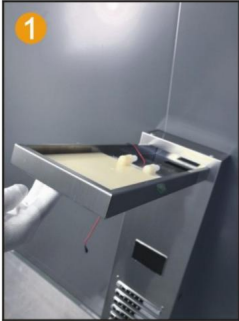

1
Insert the top spray into the motherboard inside the hole



2
Use 2 M4 screws to secure the main Fixed plate and top spray



3
Connect PVC pipes and LED light wires Thread through the hole



4
Fix the PVC pipe with a throat clamp On the top spray joint

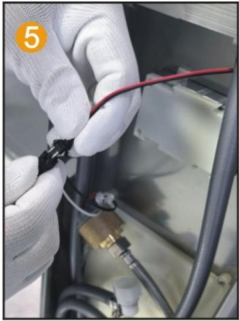

5
Connect the LED light cable and power supply line

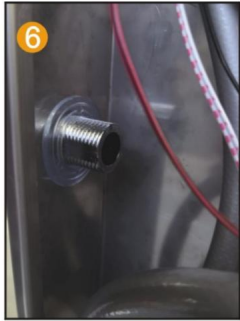

6
Insert the hand spray nozzle into the panel and install the gasket

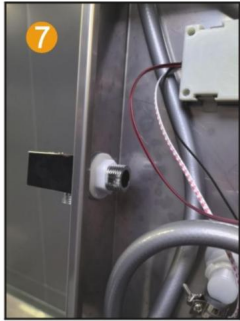

7
Spray socket with hexagonal nut handle Fixed on the panel

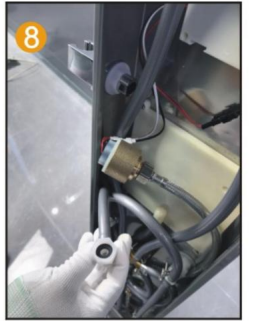

8
Spray socket with hexagonal nut handle Fix the 4-point rubber on the panel and spray it by hand Inside the seat joint

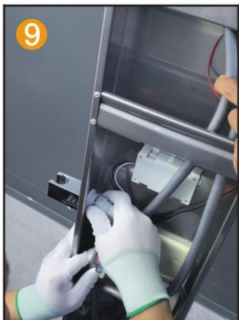

9
Connect the water outlet connector and hand spray Seat joint

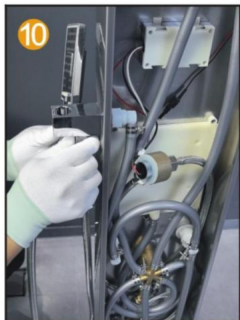

10
Connect the hand spray hose to the handheld one shower head

MODELL 7009FL

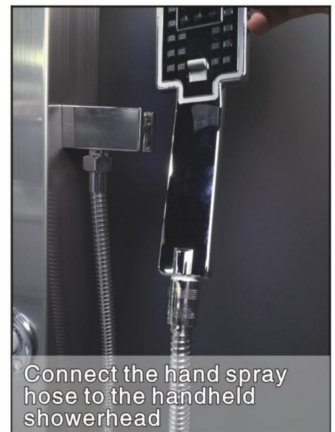
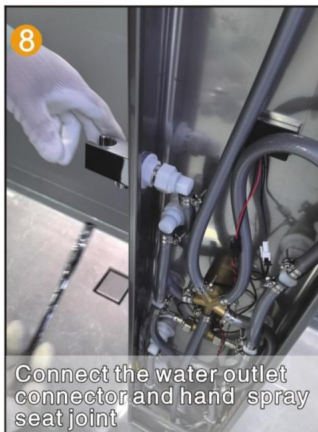
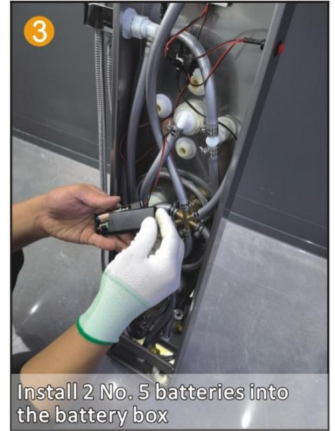
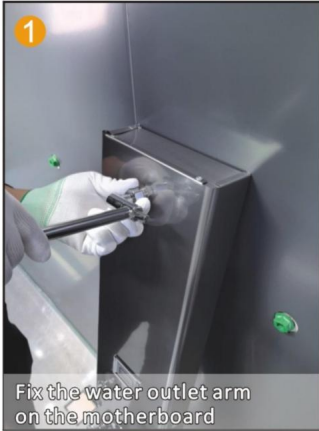

INSTALLATIONSSTEG (ALLMÄNT)

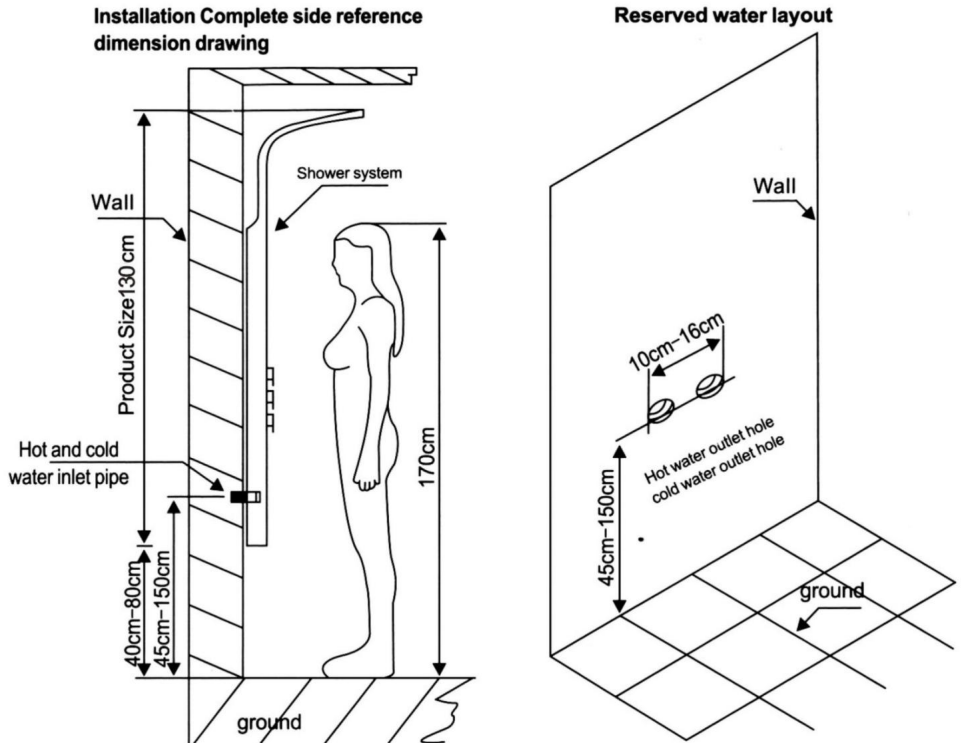

Installationsanmärkningar

1. Enligt höjden på familjens höjd budget duschsystem installationshöjd, mät duschsystemet på baksidan av ståndet. Avstånd, markera på väggen, i motsvarande position för taggen fast hängande järn (upp och ner var och en) .
2. Anslut varm- och kallvattenslangen (var noga med att rengöra magasinet och smutsen i väggen. Våg för att inte blockera, påverka vattneffekten).
3. Duschsystem hängande på väggen, de övre och nedre två korten klämdes fast i två hängpastor (Obs: dusch Efter systemväggen skakar inte huvudkroppen nära väggen, behöver inte använda ett annat glaslim och andra verktyg fixade).

Underhållsmetoder för duschsystem i rostfritt stål:

1. Regelbunden rengöring av produkten för att hålla dess utseende ljukt och rena;
2. Rengör ytan med vatten eller ett mildt rengöringsmedel och torka av den med en mjuk handduk.
3. Observera att den rena produkten av den dolda positionen, snabb rengöring kan göra produkter som håller.

DUSHPANEL SERIE INSTALLATIONSDIAGRAM

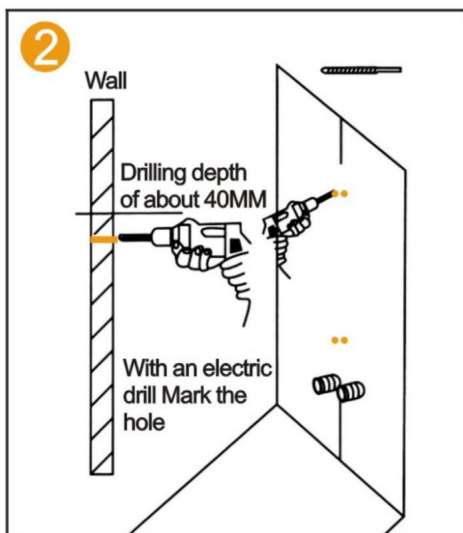
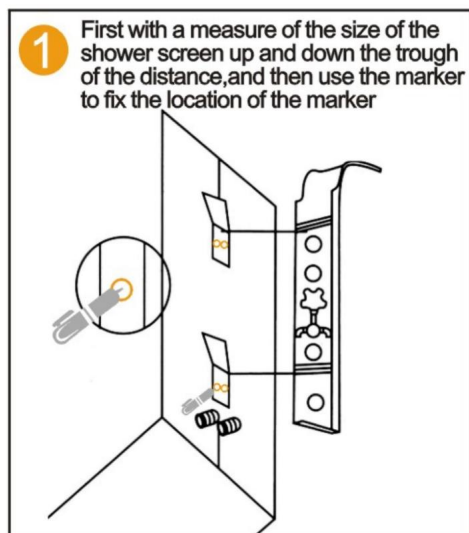

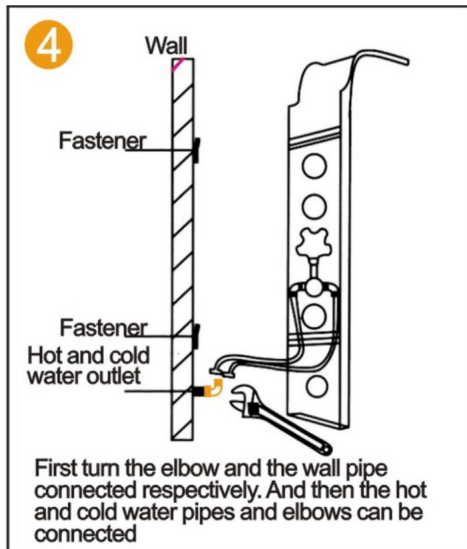
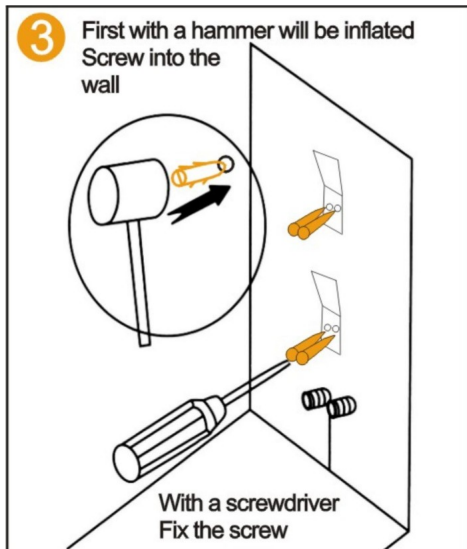

FUNKTION INTRODUKTION

8015FL

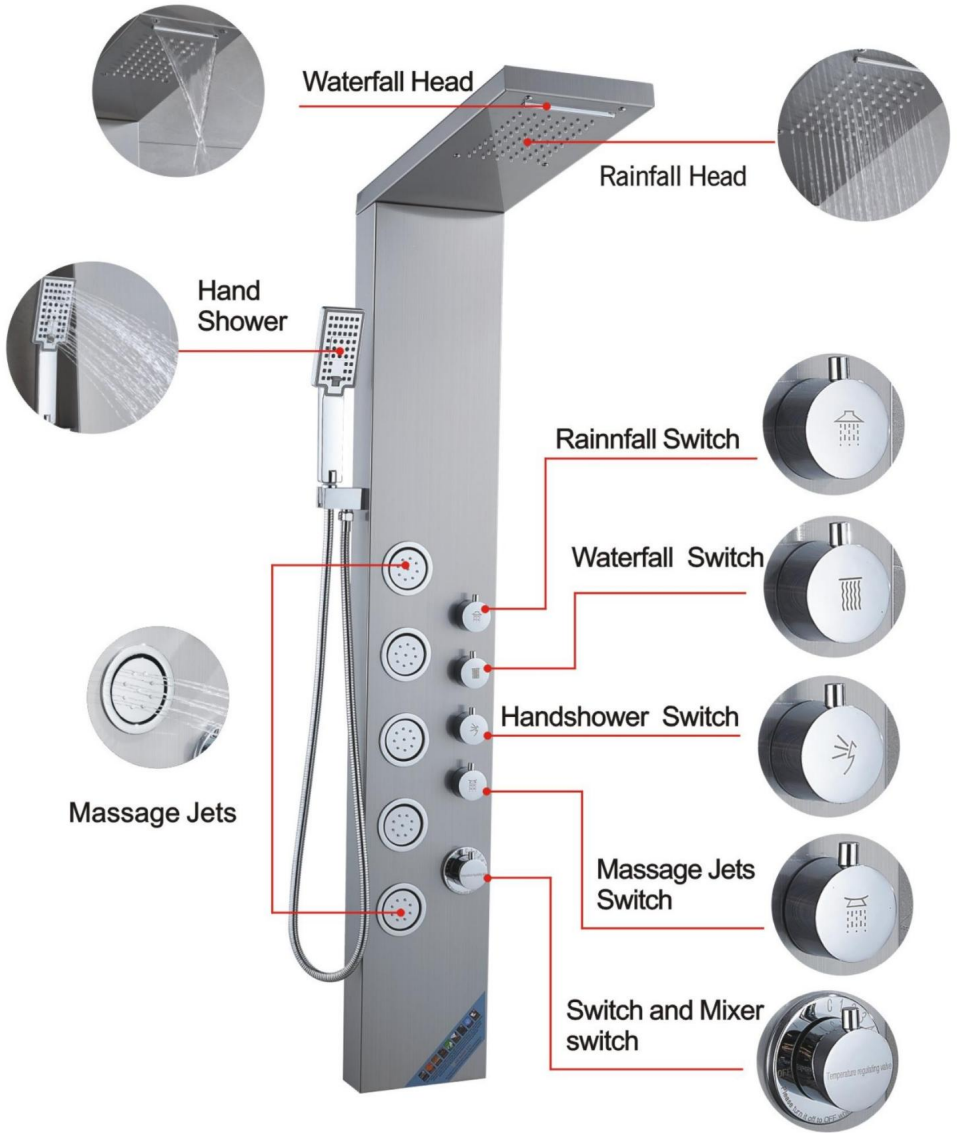

FUNKTION INTRODUKTION

6002FL



FUNKTION INTRODUKTION

8039FL

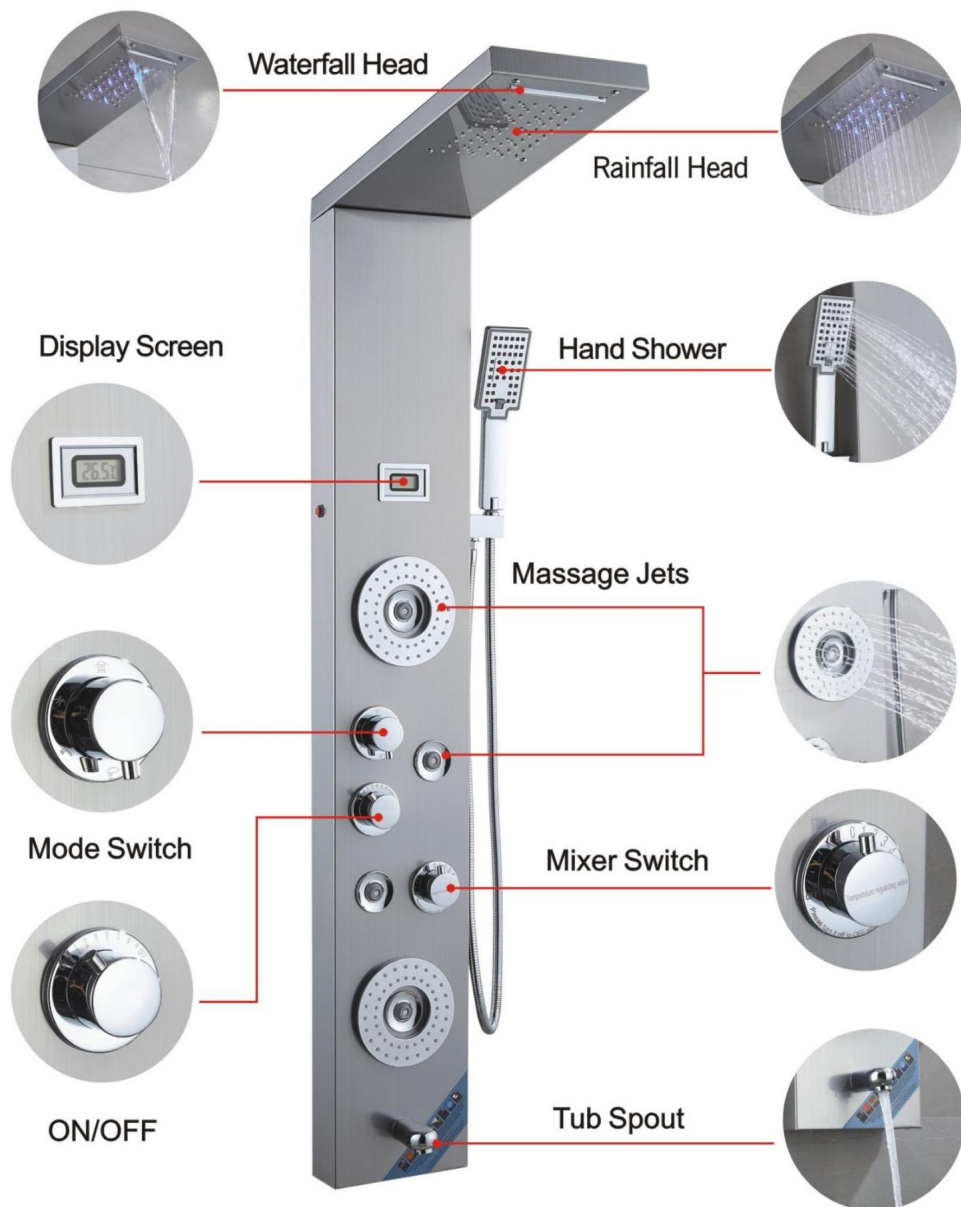

FUNKTION INTRODUKTION

8009FL

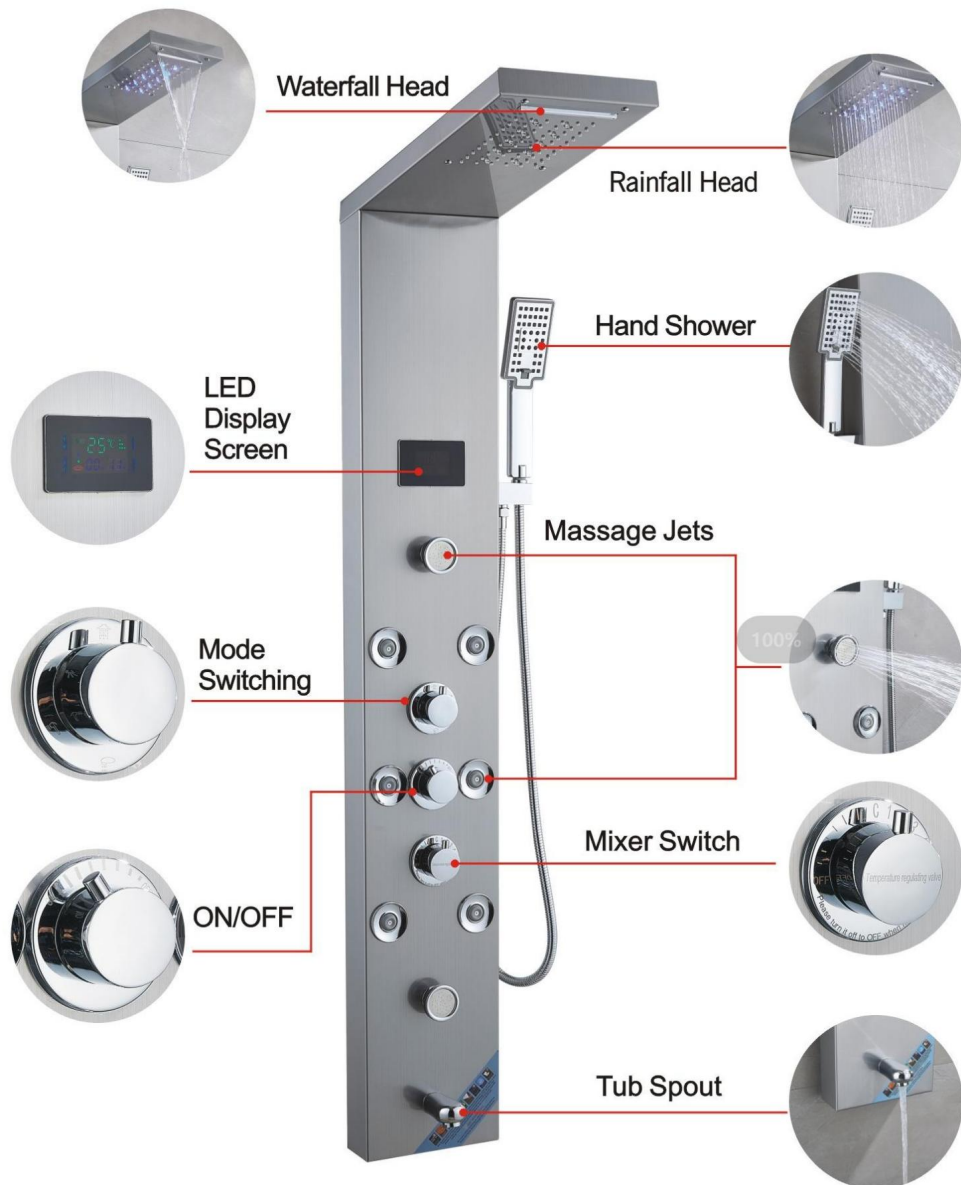

FUNKTION INTRODUKTION

8004FL

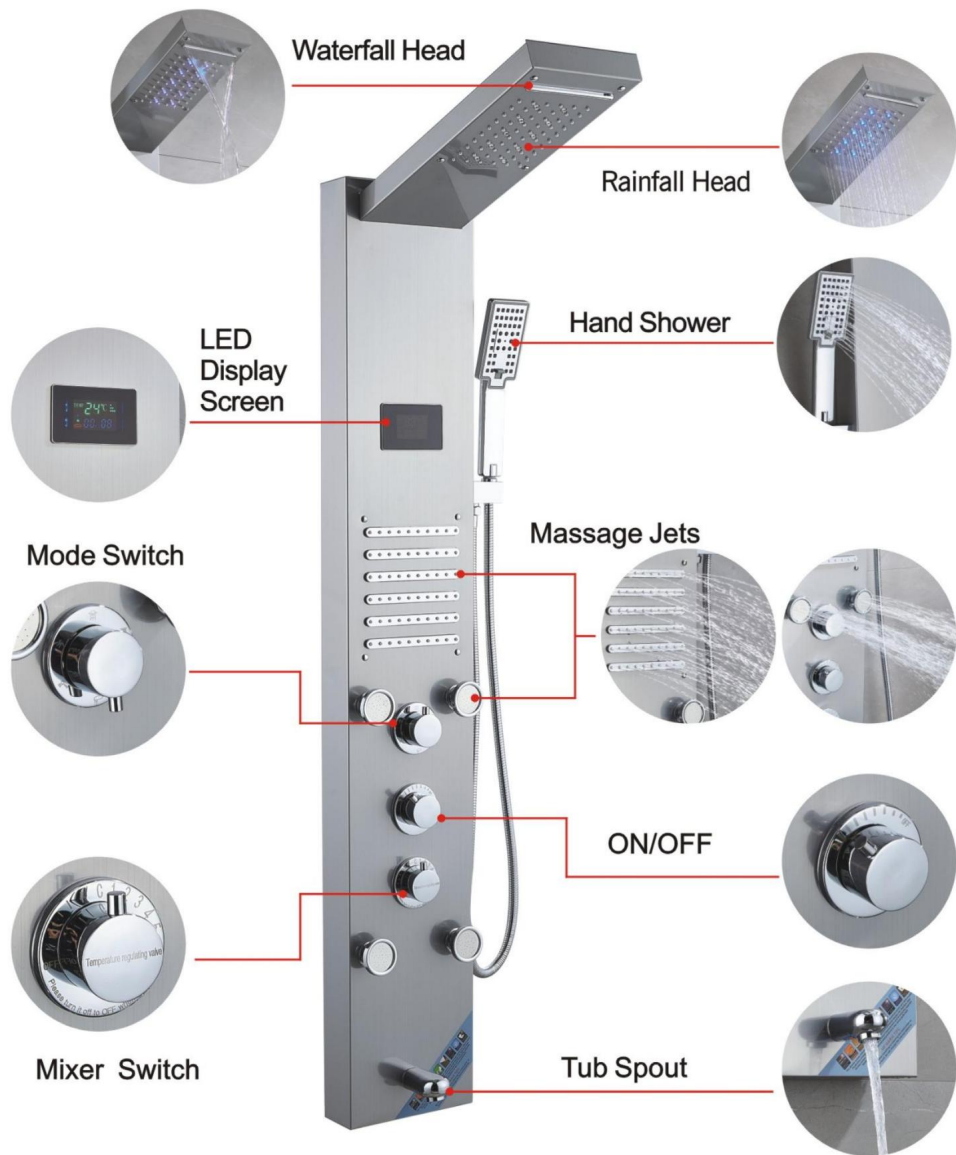

FUNKTION INTRODUKTION

7009FL

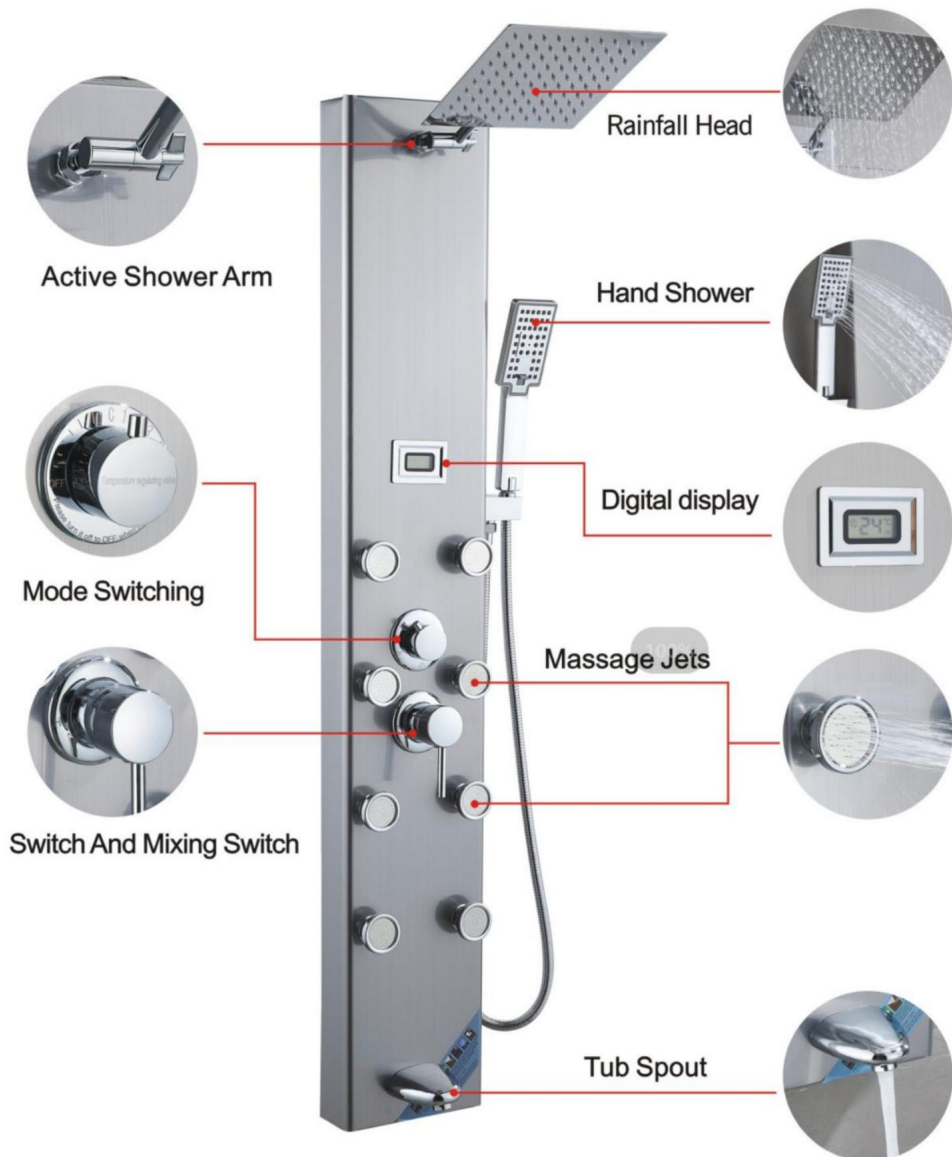

Tillverkad i Kina

VEVOR[®]

TOUGH TOOLS, HALF PRICE

Teknisk support och e-garanticertifikat

www.vevor.com/support