

VEVOR[®]

TOUGH TOOLS, HALF PRICE

Technical Support and E-Warranty Certificate www.vevor.com/support

GARMENT STEAMER USER MANUAL

MODEL:GS1119-BJ

We continue to be committed to provide you tools with competitive price.

"Save Half", "Half Price" or any other similar expressions used by us only represents an estimate of savings you might benefit from buying certain tools with us compared to the major top brands and does not necessarily mean to cover all categories of tools offered by us. You are kindly reminded to verify carefully when you are placing an order with us if you are actually saving half in comparison with the top major brands.

VEVOR[®]

TOUGH TOOLS, HALF PRICE

GARMENT STEAMER

MODEL:GS1119-BJ

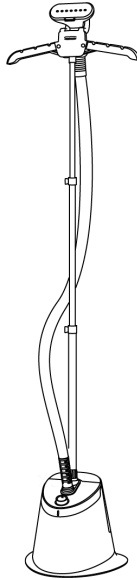



NEED HELP? CONTACT US!

Have product questions? Need technical support? Please feel free to contact us:

Technical Support and E-Warranty Certificate
www.vevor.com/support

This is the original instruction, please read all manual instructions carefully before operating. VEVOR reserves a clear interpretation of our user manual. The appearance of the product shall be subject to the product you received. Please forgive us that we won't inform you again if there are any technology or software updates on our product.

	<p>Warning-To reduce the risk of injury, user must read instructions manual carefully.</p>
	<p>This product is subject to the provision of European Directive 2012/19/EC. The symbol showing a wheeled bin crossed through indicates that the product requires separate refuse collection in the European Union. This applies to the product and all accessories marked with this symbol. Products marked as such may not be discarded with normal domestic waste, but must be taken to a collection point for recycling electrical and electronic devices</p>

IMPORTANT SAFETY INSTRUCTIONS

1. The voltage of your electrical source must correspond to that of the appliance . Connecting to the incorrect voltage may cause un-repairable damage to the appliance and will invalidate the warranty.
2. Do not share the power supply with other high-powered electric appliances.
3. To reduce the risk of electric shock, do not immerse the appliance, plug, or power cord in water or other liquids.
4. Do not leave this appliance unattended while it is in operation.
5. Fill water to "MAX" level before using and observe the water level during use.
6. Do not lay hose on the ground. Do not wind hose. Do not operate the appliance if cord is damaged.
7. Always keep the hose and nozzle elevated above the water tank. Never insert any object into any opening or hose.
8. Do not cut or attempt to extend the steaming hose or power cord.
9. Do not place the nozzle directly on any surface or the appliance power cord while it is hot or plugged in.
10. Be cautious about steam spraying out from the nozzle. Do not direct steam at people or animals, or use steamer on garments while they are being worn.
11. Steam only in a vertical motion. Never use steamer in horizontal position or tilt

backwards-doing so may result in hot water discharge.

12. Turn off, unplug, and allow the appliance to cool down completely for at least 30 minutes prior to draining the water tank and water reservoir before storing.

13. Always turn off and unplug unit before refilling, draining, cleaning, moving, or when not in use.

15. Keep the appliance away from flammable materials and chemicals.

16. Do not fill the water tank with hot water or corrosive cleaning agents which could cause damage. Distilled or filtered water is strongly recommended.

17. Only use accessories on your appliances. Use of accessories other than those provided by us may result in fire, electric shock or irreversible damage to the appliance.

18. This appliance is not intended for use by children or near children and other persons whose physical, sensory, or mental capabilities or lack of experience and knowledge prevents them from using the appliance safely without supervision or instruction by a responsible person.

PRODUCT SPECIFICATION

Model	GS1119-BJ	
District	North America	Europe
Voltage	AC120V, 60Hz	AC 220-240V, 50/60Hz
Power	1500W	1420-1800W
Water Tank Capacity	1700ml	
Steam Output Time	≤50 seconds	

COMPONENTS

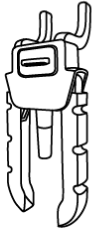

Folding Hanger

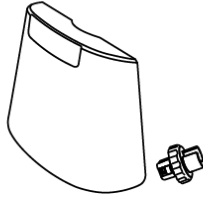

Water Tank with
Water Tank Cap



Steam Nozzle

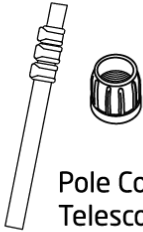

Pole Connector &
Telescopic Pole



Pants Press



Fabric Brush

Drain Plug

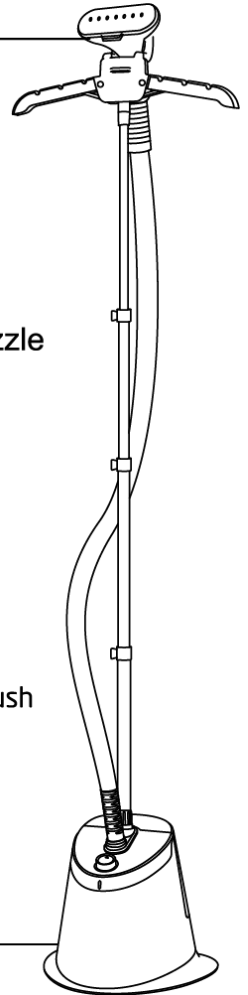
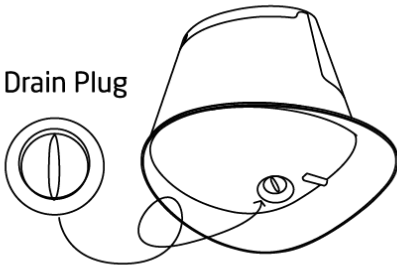

SETTING UP YOUR GARMENT STEAMER

STEP 1

Insert the Telescopic Pole and tighten the Pole Connector.

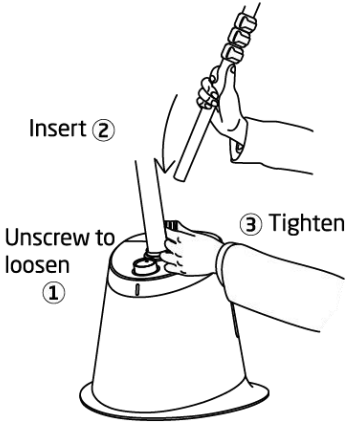

STEP 2

Attach the Folding Hanger to the top of the Telescopic Pole. Extend the Telescopic Pole to desired height and lock in place.

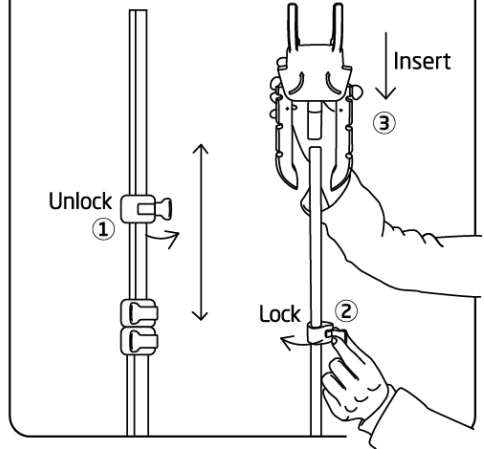

STEP 3

Slide the hose sleeve to the bottom of the hose.

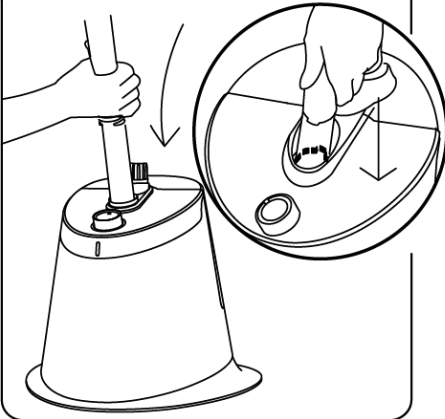

STEP 4

Fully extend Hanger Arms and hang the Steam Nozzle.

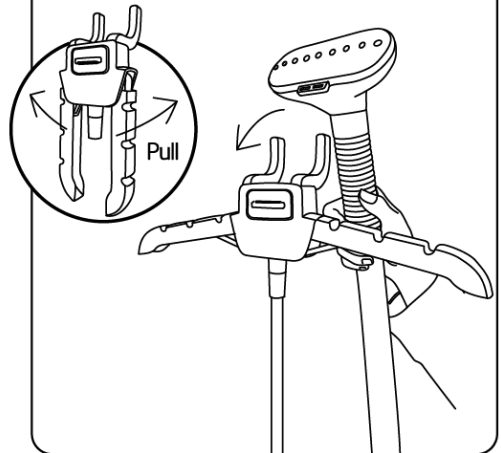

INSTRUCTIONS FOR USE

STEP 1

Remove the cap. Fill the Water Tank. Replace & tighten the Cap.

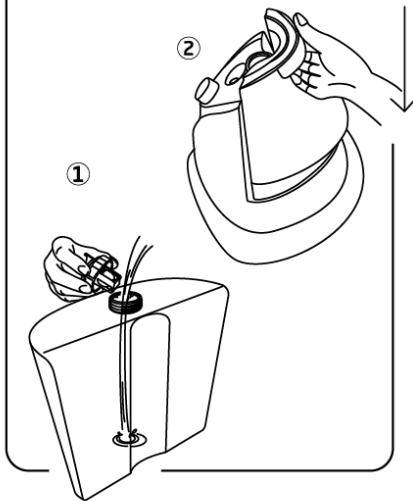

STEP 2

Plug in & Turn on.

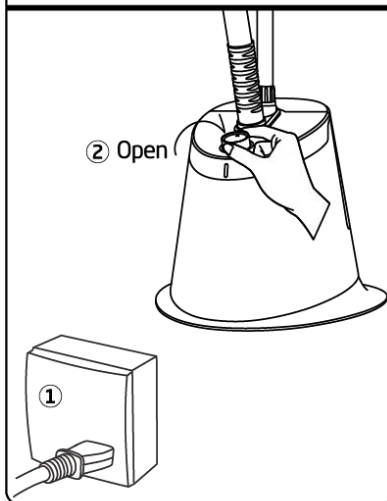

STEP 3

Heats up in 50s.

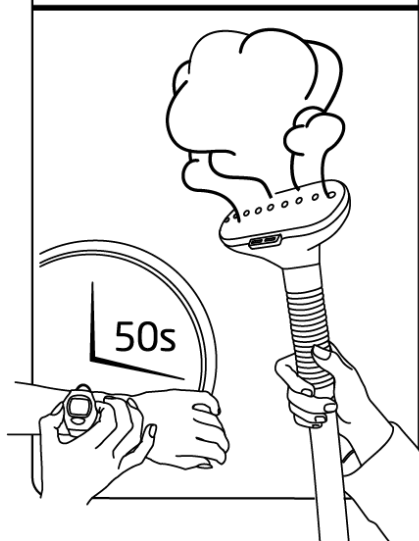

STEP 4

Ready for steaming.

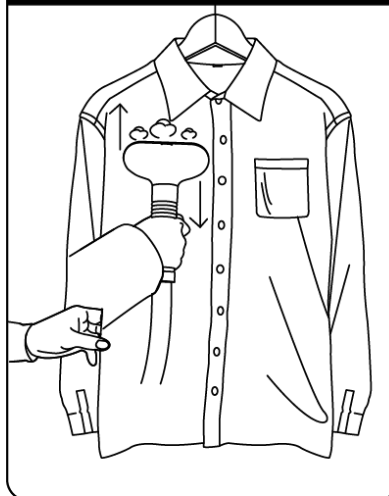

MAINTENANCE AND CLEANING

STEP 1

Turn off the unit and unplug it. Wait for at least 30mins until the unit cools down completely.

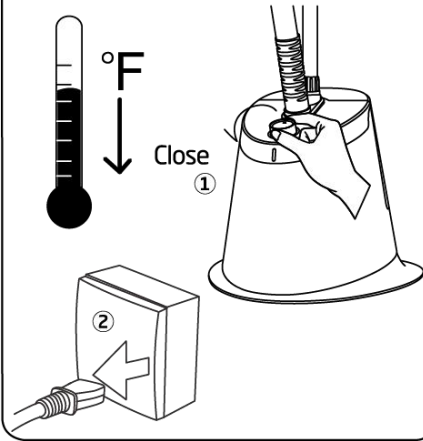

STEP 2

Unscrew the Drain Plug and empty the water reservoir.

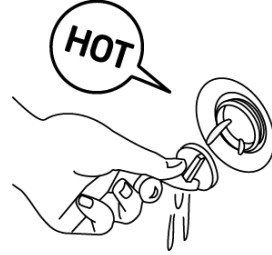

Attention: Tighten the Drain Plug back into place after water reservoir is emptied. Make sure Drain Plug is tightly secured each time before use.

REMOVING MINERAL BUILD-UP

STEP 1

Turn off and unplug the unit and let it cool for at least 30 mins. Remove water tank. Mix water & vinegar solution and pour into the water reservoir.

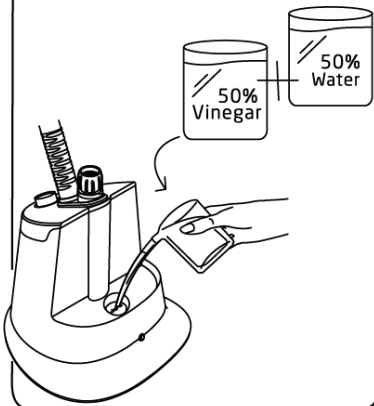

STEP 2

Wait for 40 mins, unscrew the Drain Plug and drain the water reservoir. Pour clean water into reservoir and let it drain. After the reservoir is empty, replace and tighten the Drain Plug.

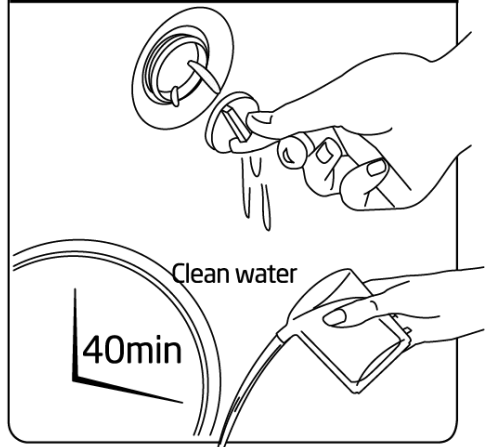

ACCESSORIES ASSEMBLY AND USE

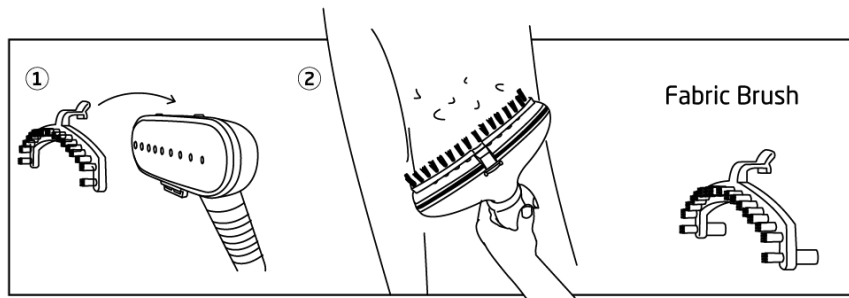
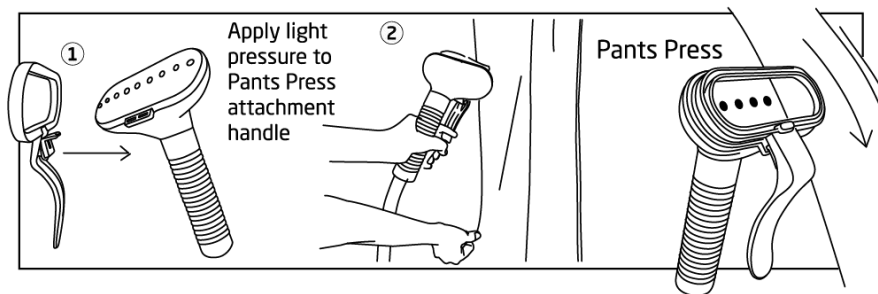
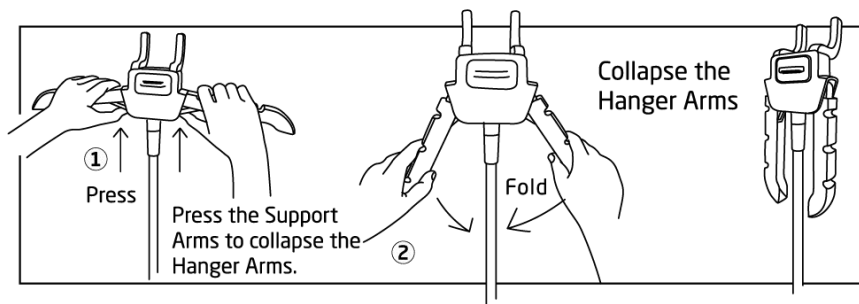
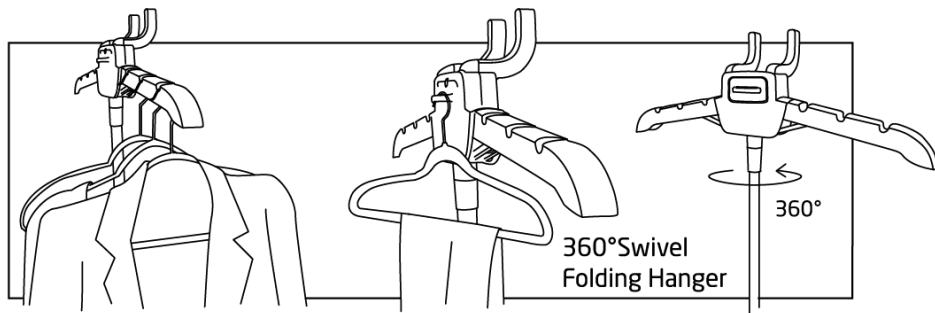

HOW TO STEAM

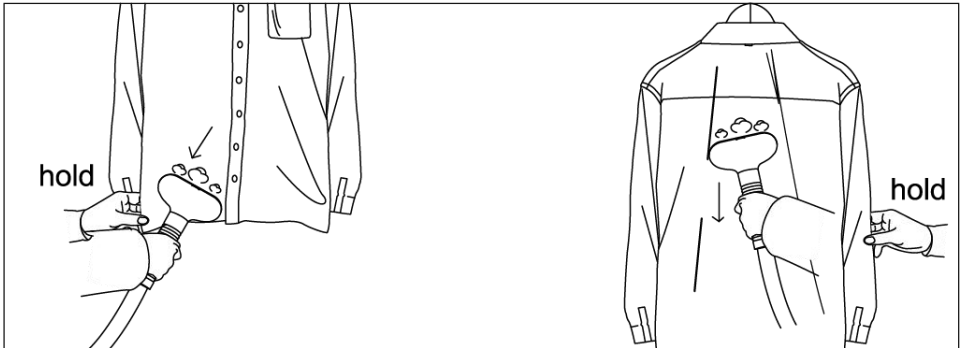
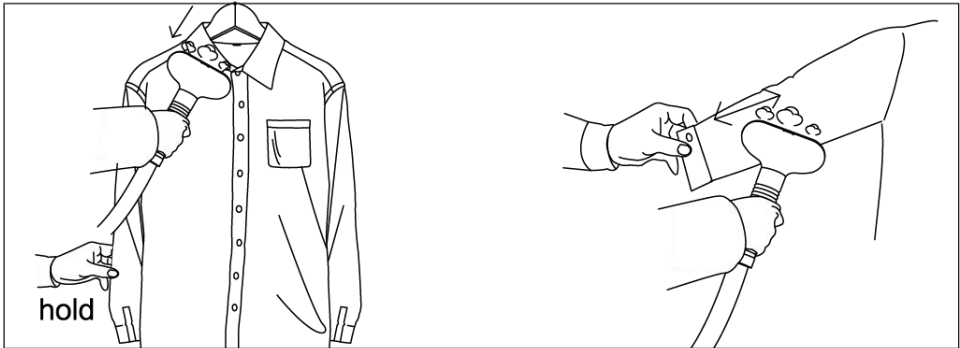
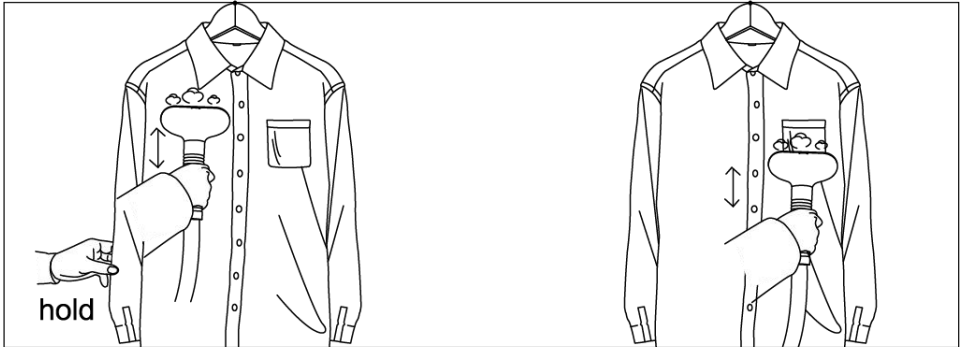

Made in China

VEVOR[®]

TOUGH TOOLS, HALF PRICE

Technical Support and E-Warranty Certificate

www.vevor.com/support