

# **VEVOR<sup>®</sup>**

## **TOUGH TOOLS, HALF PRICE**

Technical Support and E-Warranty Certificate

[www.vevor.com/support](http://www.vevor.com/support)

### **FIRE PIT BURNER/PAN**

**MODEL:1050262,1050263,1050264,1050266,1050267**

We continue to be committed to provide you tools with competitive price.

"Save Half", "Half Price" or any other similar expressions used by us only represents an estimate of savings you might benefit from buying certain tools with us compared to the major top brands and does not necessarily mean to cover all categories of tools offered by us. You are kindly reminded to verify carefully when you are placing an order with us if you are actually saving half in comparison with the top major brands.

# VEVOR<sup>®</sup>

TOUGH TOOLS, HALF PRICE

## FIRE PIT BURNER/PAN

MODEL:1050262,1050263,1050264,1050266,1050267

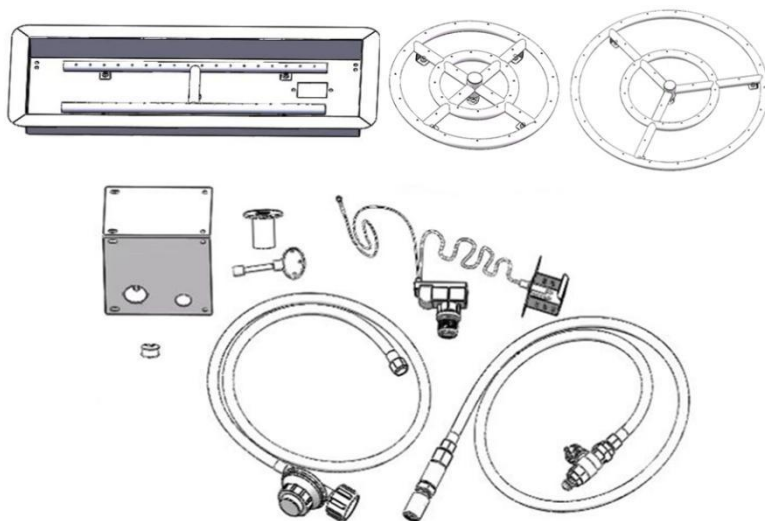

### NEED HELP? CONTACT US!

Have product questions? Need technical support? Please feel free to contact us:

✉ [CustomerService@vevor.com](mailto:CustomerService@vevor.com)

This is the original instruction, please read all manual instructions carefully before operating. VEVOR reserves a clear interpretation of our user manual. The appearance of the product shall be subject to the product you received. Please forgive us that we won't inform you again if there are any technology or software updates on our product.

# INSTALLATION PRECAUTION

PLEASE RETAIN THIS MANUAL FOR FUTURE REFERENCE



**Warning: For Outdoor Use Only**



**DANGER**

**CARBON MONOXIDE HAZZARD**



This appliance can produce carbon monoxide which has no odor.

Using it in an enclosed space can kill you.

Never use this appliance in an enclosed space such as a camper, tent, car or home.



**DANGER**

If you smell gas:

1. Shut off gas to the appliance.
2. Extinguish any open flame.
3. If odor continues, keep away from the appliance and immediately call your gas supplier or fire department.



**WARNING**

Improper installation, adjustment, alteration, service or maintenance can cause injury or property damage. Read the installation, operating and maintenance instructions thoroughly before installing or servicing this equipment.



**WARNING**

Do not store or use gasoline or other flammable vapors and liquids in the vicinity of this or other appliance.

An LP-cylinder not connected for use shall not be stored in the vicinity of this or any other appliance.



**WARNING**

Do not leave unattended during use. Do not use for cooking. Follow all gas leak procedures in this manual before operation.

**WARNING:** If the information in these instructions is not followed exactly, a fire or explosion may result causing property damage, personal injury or death.

## **INSTALLATION AND OPERATION SAFETY**

### **GUIDELINES**

**CAUTION:** It is NOT recommended outdoor fire features be operated when the wind exceeds 25 mph. Before turning the appliance on, visually inspect the fire feature to ensure debris such as leaves or other combustible material has not inside the element, which could burn and emit embers once the fire feature is turned. Also, provide any person standing close to the fire feature is aware you will be turning the fire feature on before actually turning it on.

**Installation and repair should be done by a qualified service person. The appliance should be inspected before use and at least annually by a qualified service person. More frequent cleaning may be required as necessary. It is imperative that control compartment, burners and circulating air passageways of the appliance be kept clean.**

- Do NOT install damaged components.
- Do NOT install incomplete components.
- Do NOT install substitute components.

Ensure the appliance is installed so the vent opening at the unit's base remains obstacle-free at all times and during all weather conditions.

Due to high temperatures, the unit must be located out of traffic areas and away from combustibles.

**Children and adults should be alerted to the hazard of high surface temperatures and should stay away to avoid burns or clothing ignition.**

Young children MUST be carefully supervised when they are in the area of this appliance.

Clothing or other flammable materials should not be hung from the appliance or placed on or near the appliance.

**WARNING:** HOT WHILE IN OPERATION AND FOLLOWING OPERATION. Serious injury can occur!

DO NOT leave in operation when unattended.

**WARNING:** DO NOT operate this appliance in the rain.

**SOLID FUEL MUST NOT BE BURNED** in the appliance.

DO NOT continue using if you smell unusual odors, or have headaches, nausea, or dizziness.

DO NOT store any combustible materials, gasoline, and any other flammable vapors/liquids in the vicinity of the unit. Provide adequate clearance for servicing and operation.

DO NOT throw matches, paper, garbage, or any other material onto the appliance or flame.

DO NOT use the appliance if any part has been underwater. Immediately call a qualified professional service technician to inspect the appliance and to replace any part of the control system and any gas control that has been underwater.

Inspect the fuel supply connection before each use of the appliance. Temporary storage of this appliance indoors is permissible only if it has been disconnected from its fuel supply (Natural or L.P. gas line).

## **SPECIFICATIONS**

**Parameter table- Model#1050262 1050263 1050264**

Model#	Installation Size	L1	L2	L3	W1	W2
1050262	24"x8"	26 1/2"	24"	19"	10 1/2"	8"
1050263	30"x10"	32 1/2"	30"	25"	12 1/2"	10"
1050264	36"x12"	38 1/2"	36"	31"	14 1/2"	12"

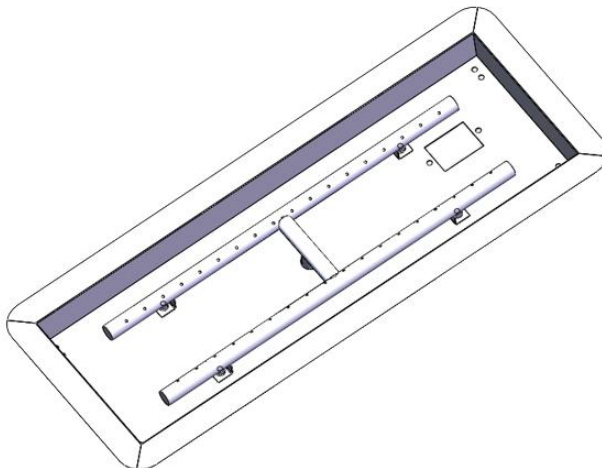
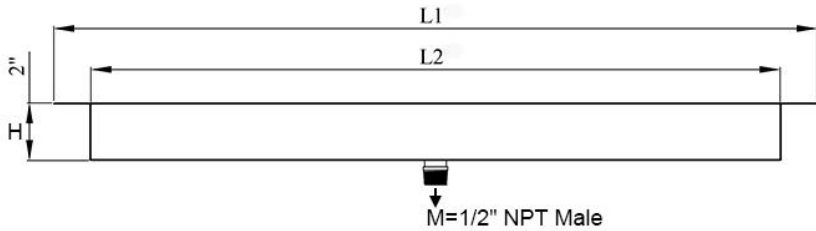
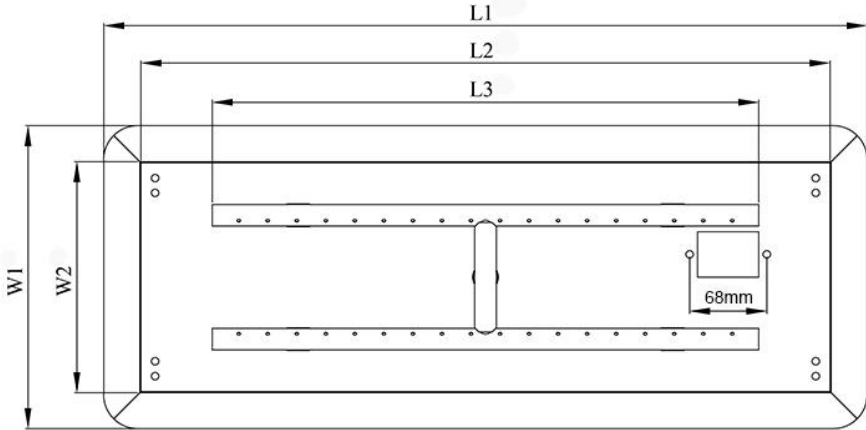

## Parameter Table- Model#1050266 1050267

Model#	Installation Size	R	H
1050266	12"	12"	1 16/25"
1050267	18"	18"	1 16/25"

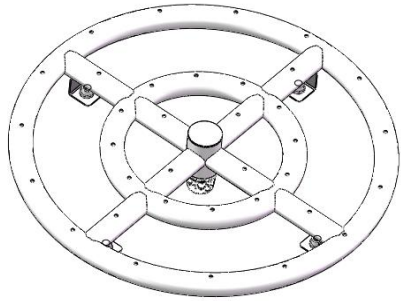
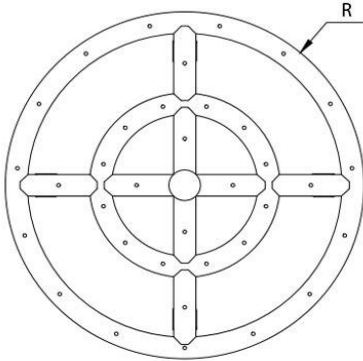



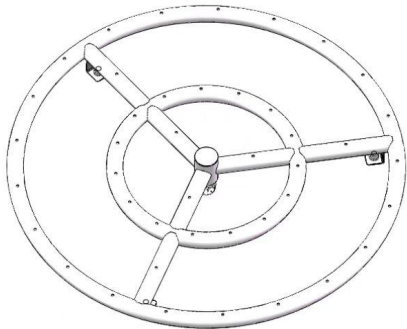
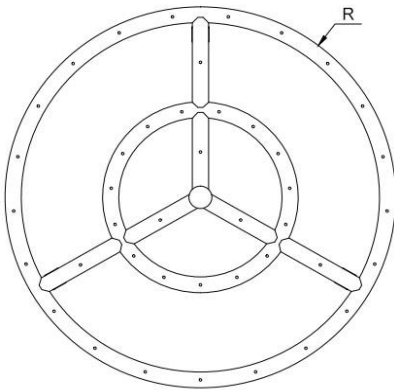
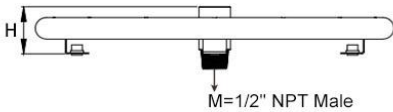



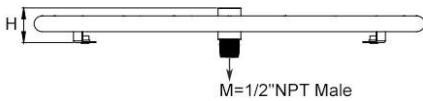



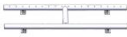

Model#: 1050266





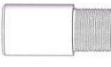
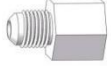







Model#: 1050267



## PACKAGE INCLUDE

No	Components	Q'ty	Picture	Fits Model#				
				1050 262	1050 263	1050 264	10502 66	1050 267
1	Fire Pit Burner	1		Y	Y	Y	/	/
				/	/	/	Y	/
				/	/	/	/	Y
2	Fire Pit Pan	1		Y	Y	Y	/	/
3	4.4ft Propane Regulator Hose	1		Y	Y	Y	Y	Y
4	4ft Connect Hose	1		Y	Y	Y	Y	Y
5	1/2" Shut-off Ball Valve	1		Y	Y	Y	Y	Y
6	1/2" Air Mixer Valve	1		Y	Y	Y	Y	Y
7	1/2" Brass Adapter	1		Y	Y	Y	Y	Y
8	1/2" SS Connector	1		Y	Y	Y	Y	Y
9	5/8-18UNF Brass Connector	1		Y	Y	Y	Y	Y
10	1/4 Chrome Qtr-Turn Key Valve	1		Y	Y	Y	Y	Y
11	3"Chrome Valve Key	1		Y	Y	Y	Y	Y
12	SS Mounting Plate	1		Y	Y	Y	Y	Y



No	Components	Q'ty	Picture	Fits Model#				
				10502 62	10502 63	10502 64	1050 266	1050 267
13	Spark Ignitor	1		Y	Y	Y	Y	Y
14	Lgnition box	1		Y	Y	Y	/	/
15	Spark Ignitor wire	1		Y	Y	Y	Y	Y
16	Ground wire	1		Y	Y	Y	Y	Y
17	Removable mounting plate for optional spark Ignitor	1		/	/	/	Y	Y
18	Seal Tape	1		Y	Y	Y	Y	Y
19	Screw(M5x10)	3		Y	Y	Y	Y	Y
20	Screw(M6x20)	1		Y	Y	Y	Y	Y
21	Self-tapping Screw	4		Y	Y	Y	Y	Y
22	M5 Nut	3		Y	Y	Y	Y	Y
23	Battery(1.5V)	1		Y	Y	Y	Y	Y

Remark: "Y" =Yes

## DIY YOUR FIRE BURNER/PAN

This screw cap allows installing the Fire Pit Burner with the gas exit holes facing up or down depending on the fuel type, region, and fire feature the Fire Pit Burner uses. Install the screw cap into the center hub opposite the gas inlet. Before installing Fire Pit Burner to the gas fitting or screw cap, be sure gas tape or pipe dope is applied to assure of no gas leaks with the

## Fire Pit Burner installation.

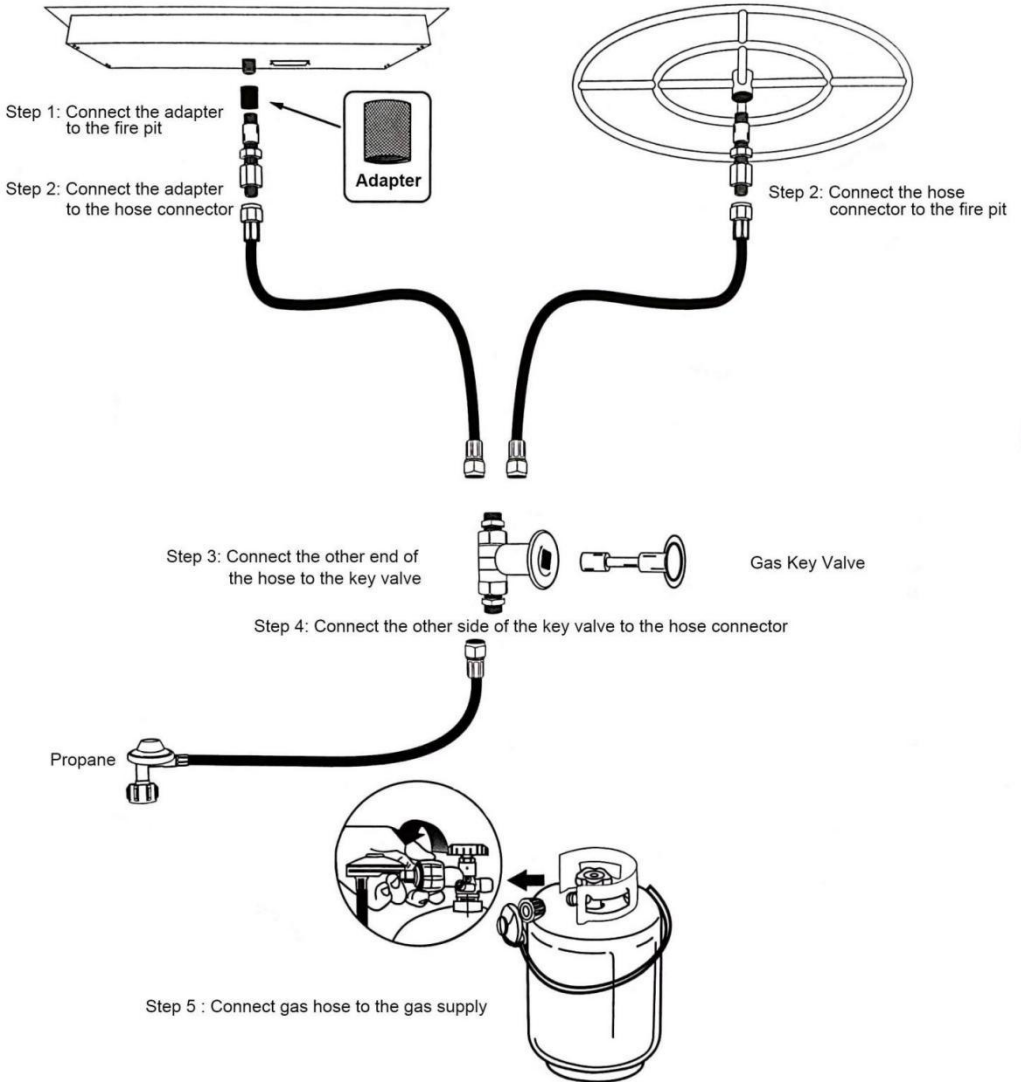

## Gas Information

Fuel - Before making gas connections ensure appliance being installed is compatible with the available gas type.

Gas Pressure - Proper Input Pressures are required for optimum appliance performance. Gas line sizing requirements need to be made following NFPA51.

Gas Connection -Have the gas supply line installed following local building codes, if any. If not, follow ANSI (Z)223.1. Installation should be done by a qualified installer approved and/or licensed as required by the locality.

**Note:** A listed manual gas shutoff device must be installed prior to the location of the appliance Startup - A small amount of air will be in the gas supply lines. When first lighting appliance it will take a short time for air to purge from lines. Subsequent lighting of the appliance will not require such purging.

## **LP Gas Installation Considerations**

Due to the fact LP (Propane) Gas is different from natural gas there are some slight differences in the installation procedures. These differences are listed here:

1. Installation of an Air Mixer. Propane is a much more volatile fuel when compared to natural gas. For this reason, an Air Mixer is installed in the inlet of the burner element to lean out the gas, which also minimizes propane soot.
2. Drainage/Venting of the bottom of the Fire Feature. Unlike natural gas, LP gas is heavier than air. Because it is heavier than air any "unburned" LP gas will likely go to the bottom of the fire feature. Without proper drainage/venting at the bottom of the fire feature LP gas will collect in the bottom of the fire feature and WILL cause a very hazardous situation. For this reason, venting at the bottom of the fire feature MUST be installed to allow any unburned LP gas to escape from the bottom, thereby eliminating the hazard. Be sure to install two vents on opposing sides, each with 18 Square inches of ventilation per side.
3. Fire glass media on top of the Fire Pit Ring. Using no more than a 2" thick layer of fire glass media ON TOP of the Burner Element in an LP gas fire feature is recommended. The less media there is on top of the burner element the less obstructions there are which could prevent LP gas from

being ignited at the top of the fire feature. By reducing the depth of the media you have reduced the chance of unburned LP gas from going to the bottom of the fire feature.

## **Typical Configuration for Propane (LP) Gas Fire Pit**

### **Installation**

1. Seal Tape - Use Seal tape to seal all threaded pipe joints.
2. LP Air Mixer Required - Propane requires additional air mixed with the gas to burn cleanly. Install air mixer with holes facing away from burner. The propane air mixer should be equal or greater in BTU rating than the burner.
3. Proper Ventilation - Propane gas is heavier than air. Ensure ventilation holes in the lowest portion of your fire feature allow excess gas to drain.
4. Gas Pressure - Between 7"WC and 11" WC (0.25 psi to 0.4 psi). We recommend a 0-20 psi high pressure regulator when connecting to a propane tank.

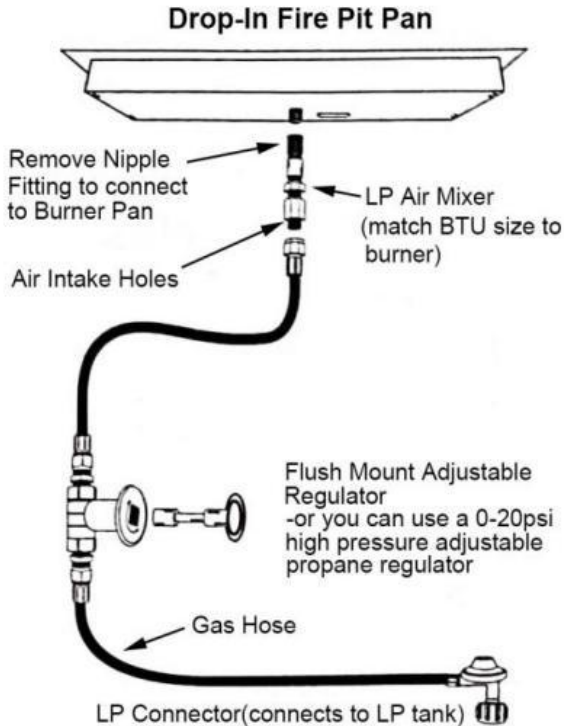

5. Clearances - Maintain a minimum of 36" clearance on all sides and 8' above your burner. Burners that are greater than 150k BTU should not be installed under any structure.

6. Fire Glass Depth-Fire glass should cover the top of the burner at a depth of 1" to 2".

**CAUTION:**

Propane is heavier than air and will accumulate in unvented enclosures causing a combustion hazard. A minimum of 20 square inches of ventilation is required at the lowest point of an enclosed fire feature to ensure proper drainage of unburned propane gas.

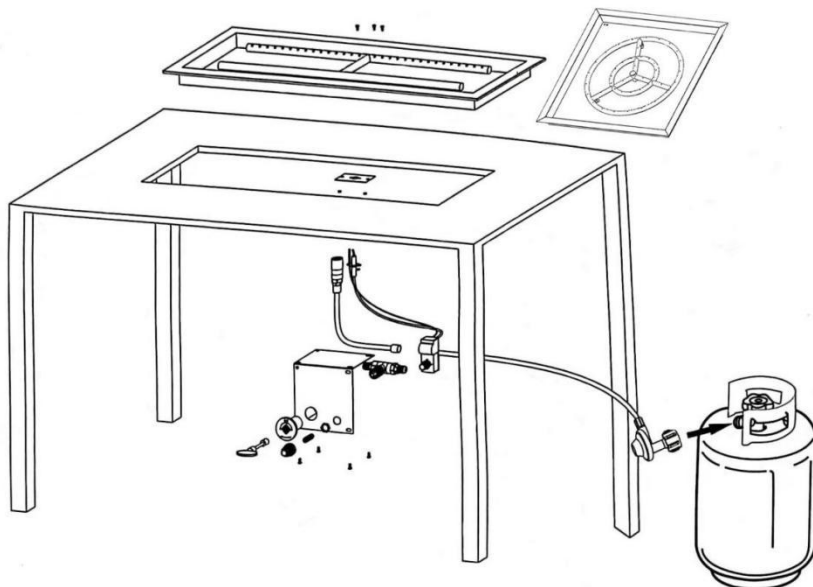

## INSTALLATION-Ignition & Gas Valve Key Connect with Control Panel

1. Clamp part 1 into part 2
2. Screw together part 3 and part 1
3. Then you have the combination-module A

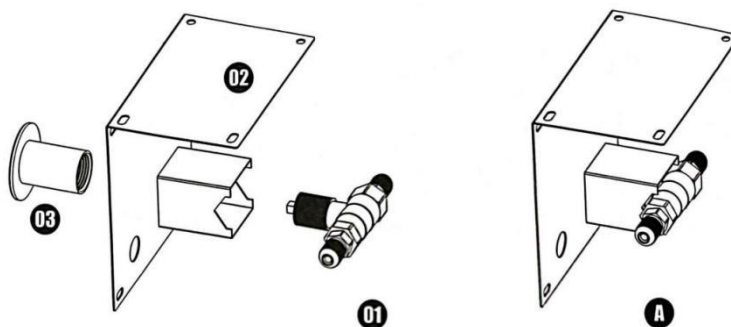

4. Screw off part 5, part 6 and part 7 from part 4
5. Part 4 goes through part 2 and connects with part 5, 6 and 7 (screw them together)
6. Then you have the combination-module B

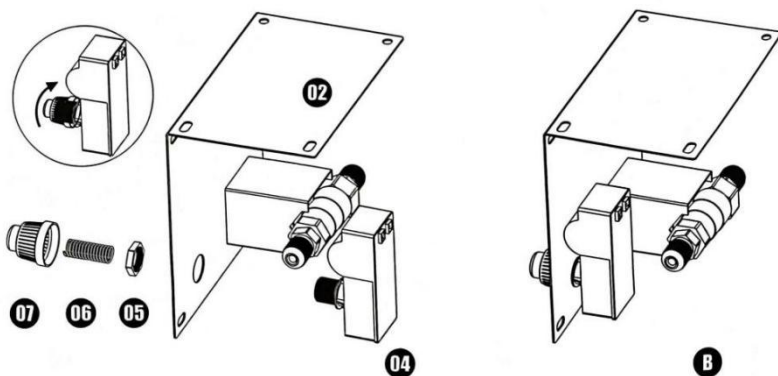

8. Connect Part 8 (igniter wire) to part 4 (proper hole with Igniton)

9. Then you have the combination-module C

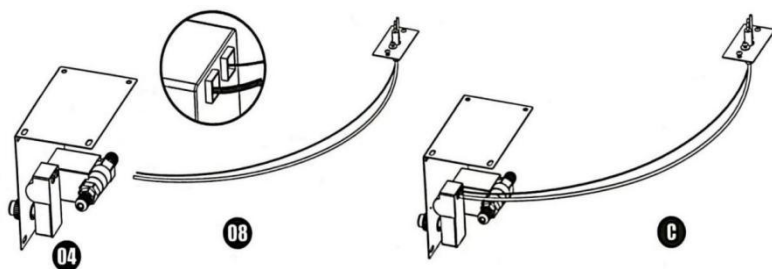

10. Fix Part 9 and Igniter Head to Fire Pan with 3 screws

11. Fix module C on your table or somewhere else

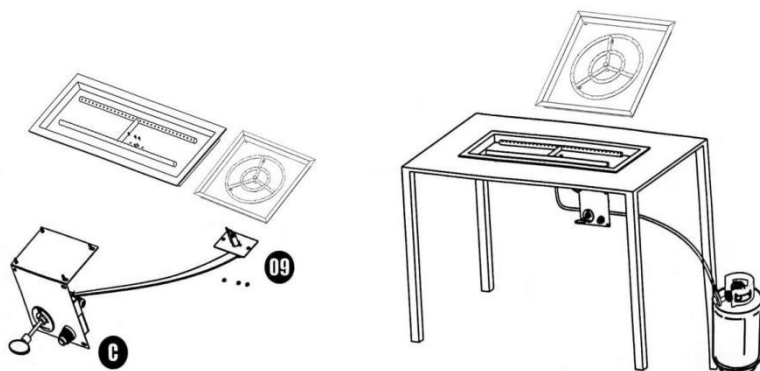

# **SAFE USE OR MAINTANANCE OF GAS CYLINDERS**

This appliance shall be used with NATURAL or LP inlet gas supply only. The LP or CNG gas supply cylinder must be constructed and marked in accordance with the specifications for LP-gas cylinders or CNG-gas cylinders of the U.S. Department of Transportation (DOT).

The use or storage of the LP or CNG cylinder may not be used in a building, garage or any other enclosed area. Cylinders must be stored outdoors in a well-ventilated area out of the reach of children. Disconnected cylinders must have threaded valve plugs tightly installed.

The gas must be turned off at the supply cylinder if the appliance is not in use.

Inspect the hose before each use of the appliance. The hose assembly must be replaced prior to the appliance being put into operation if there is evidence of excessive abrasion or wear, or if hose is damaged. The hose assembly must be replaced with a replacement hose assembly equivalent to, or greater than, rating specified on the original hose.

The gas hose shall be located out of pathways where people may trip over it or in areas where the hose may be subject to accidental damage.

Do not store or use a LP-gas supply cylinder around excessive heat; the cylinder may get too hot or cause the pressure to rise. Store the cylinder in a secure upright position.

Cylinders must be fully opened and the pressure controlled by a reducing pressure regulator to operate properly.

## **Checking for Gas Leaks**

- Check all fittings and connections.
- Do not use open flame to check for leaks.
- Never use matches or open flame to test for leaks. Use soapy water or a leak detector.
- Turn Valve turn cylinder valve anti-clockwise, Move leaver move regulator



lever to the on position

To check for leaks, wet fittings with the soap-and-water solution, using a spray bottle, brush or rag. If bubbles form, or if the bubble grows, there is a leak. Apply the soap-and-water solution to the following connections:

- a. Valve-to-regulator hose connection.
- b. Regulator hose-to-regulator connection.
- c. Regulator-to-cylinder connection.

When leak checking is complete, turn gas supply off at the source and rinse connections with water.

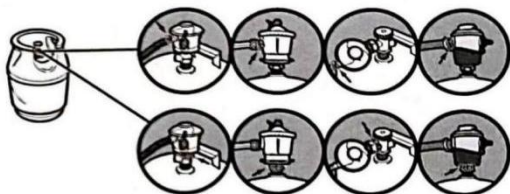
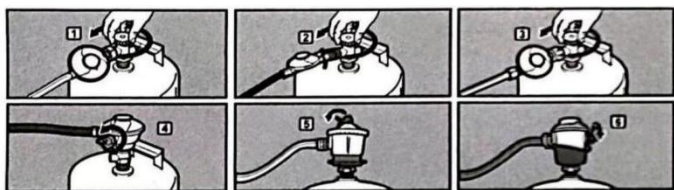

## LIGHTING INSTRUCTIONS

**PLEASE CHECK THE AIR TIGHTNESS OF THE ALVE BEFORE USE !**

1. STOP! Before lighting this appliance, read the Gas Cylinder, Important Information, and Enclosures sections.
2. BEFORE LIGHTING: Smell all around the appliance area for gas. Be sure to smell next to the floor of the fire-pit because some gas is heavier than air and will settle in the base of the fire-pit.
3. Light a match and place it on the top and outside of the Top Burner Plate.
4. Slowly turn the manual gas valve to the "OPEN" position. The fire-pit burner should ignite between 0 to 3 seconds.

## COMMON TROUBLESHOOTING

No	Symptom	Corrective Action
1	Air in gas line	If new install, may take several attempts to purge air.
2	Debris in gas line	Confirm gas line is clear (insulation, dirt, plastic, excessive pipe sealer etc.)
3	Spark igniter needs adjusted	Spark igniter must be correctly aligned with burner holes.
4	Low flame height	Gas pressure is too low, have a gas specialist check for proper gas pressure.
5	Fire glass turning black	Propane isn't burning cleanly resulting in soot deposits. Add a propane air mixer then rinse the fire glass with a 50/50 water vinegar mixture.
6	Flame not evenly distributed	Check for even distribution and depth of fire glass. Reduce fire glass depth to 1" over the burner.

**CAUTION:** Installing gas appliances can be dangerous. A professional gas installer must make installation to ensure the safe operation of your burner. We advise working with a certified NFI Gas Specialist.

## RECOMMENDED ACCESSORIES

Glass Flame Guard-Protects flame in breezy conditions for cleaner burning of the gas and better visual presentation of the flame.

Stainless Steel Fire Pit Cover-keeps leaves, bird droppings and other debris out of the fire pit.

**This product has passed strict factory testing. If any leakage is found, please stop using it immediately and contact us for a replacement.**

Sanven Technology Ltd.

Address: Suite 250, 9166 Anaheim Place, Rancho Cucamonga, CA 91730

**Made In China**

**VEVOR<sup>®</sup>**

**TOUGH TOOLS, HALF PRICE**

**Technical Support and E-Warranty Certificate**

**[www.vevor.com/support](http://www.vevor.com/support)**