

VEVOR[®]

TOUGH TOOLS, HALF PRICE

Technical Support and E-Warranty Certificate www.vevor.com/support

HITCH ADAPTER

MODEL: LFYC05

We continue to be committed to provide you tools with competitive price.

"Save Half", "Half Price" or any other similar expressions used by us only represents an estimate of savings you might benefit from buying certain tools with us compared to the major top brands and does not necessarily mean to cover all categories of tools offered by us. You are kindly reminded to verify carefully when you are placing an order with us if you are actually saving half in comparison with the top major brands.

VEVOR[®]

TOUGH TOOLS, HALF PRICE

HITCH ADAPTER

MODEL: LFYC05



NEED HELP? CONTACT US!

Have product questions? Need technical support? Please feel free to contact us:

Technical Support and E-Warranty Certificate
www.vevor.com/support

This is the original instruction, please read all manual instructions carefully before operating. VEVOR reserves a clear interpretation of our user manual. The appearance of the product shall be subject to the product you received. Please forgive us that we won't inform you again if there are any technology or software updates on our product.

SAFETY INSTRUCTIONS

WARNING

1. Too much tongue weight can lower the tow vehicle in the back, resulting in traction, steering, and braking problems.
2. Using an extender will reduce your hitch's weight capacity by 50%.
3. Do not modify or use the product outside its intended use and application.
4. When a product is not in use, store it in a secure location out of the reach of children.
5. Do not exceed the maximum weight ratings in the Specifications table.
6. Do not exceed the rating of the lowest rated component in the vehicle/trailer towing set-up.
7. Use common sense when working. Stay alert and concentrate when setting up and using this Hitch Adapter. Never operate while under the influence of alcohol, drugs, or medications.
8. Always ensure the tow vehicle's engine is turned off, with the emergency brake on, before installing this product. Take safety precautions to prevent unsafe movement of the accessory as it is being connected to the vehicle. Ensure the vehicle's wheels are chocked before attaching the accessory to the tow vehicle.
9. Ensure the Hitch Adapter is securely connected to the vehicle's receiver. A steel hitch pin and R-Shaped safety clip are required for this connection. Make sure the safety clip is fully engaged.
10. The upper receiver (with collar) attaches accessories such as a bike rack or cargo carrier. The upper receiver is not for towing.
11. Read and adhere to all instructions and safety warnings provided by the manufacturer of the receiver used on the vehicle.
12. It is critical that the connection between the vehicle's receiver, this Hitch Adapter, and the attached accessory be made correctly. This connection must be solid and include both sets of hitch pins/B-Shaped safety clips. An improper connection could loosen while the vehicle/accessory is on the road, resulting in serious property damage, personal injury, or death.

13. Safety chains between the vehicle and the attached accessory are recommended.
14. Always keep arms, feet, and legs away from under the vehicle and the accessory to be attached when the accessory is being connected or loaded with cargo. Keep spectators away when setting up and using this product.
15. Be aware of the danger of “dynamic loading.” This situation arises when a load is dropped onto the Hitch Adapter, resulting in an excessive short-term load. Dynamic loading can damage and fail the Hitch Adapter and/or the attached accessory and cause personal injury to people nearby.
16. Before each use, check the Hitch Adapter, the vehicle’s receiver, and the attached accessory to ensure all hardware is tightly secured. Check for damaged or worn parts; never use the Hitch Adapter if damaged.
17. Remember that the previously discussed warnings cannot cover all possible events and circumstances. The person setting up and using this product must always use common sense.

MODEL AND PARAMETERS

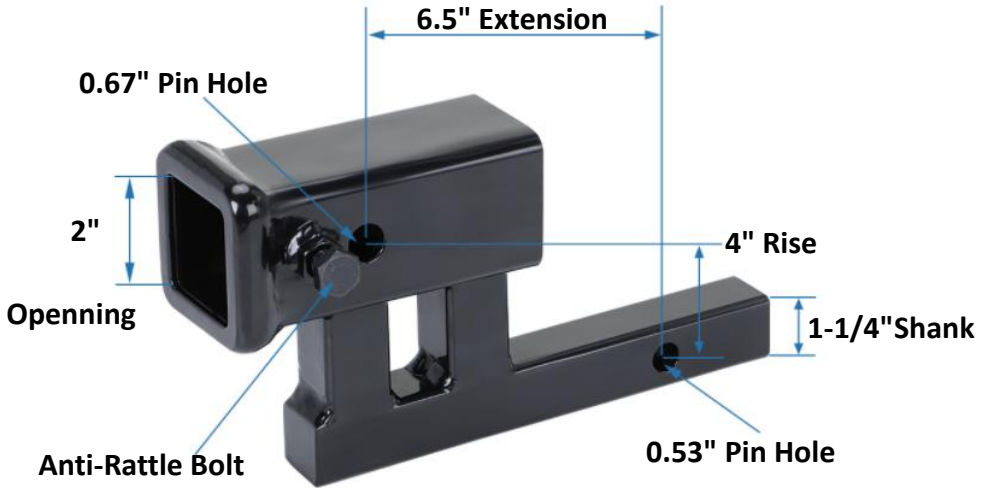

Model	LFYC05
Cross trailer WT	4000lbs
Tongue WT	350lbs

STRUCTURE DIAGRAM AND COMPONENTS



No.	Name	Qty
1	Hitch Adapter	1
2	B-Shaped Safety Clip	2
3	Hitch Pin	2
4	Lock Nut A	1
5	Lock Bolt B	1
6	User Manual	1

APPLICATION SCENARIOS

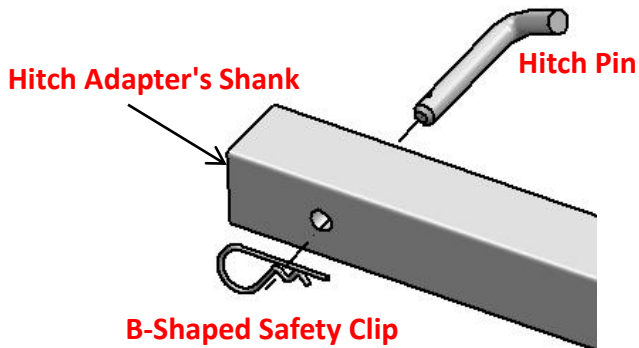



All accessories (bike rack, cargo carrier, etc.) must be secured to the top receiver (with collar) with a steel hitch pin and B-Shaped safety clip. Make sure safety clips are always fully engaged.



Shock-proof design: Keep nut A loose, tighten bolt B, and then tighten nut A. This can strengthen the shelves and so on, effectively prevent shaking during use.

MAINTENANCE

1. Check bolts and safety pins regularly .
2. Do not overload.

MADE IN CHINA

VEVOR[®]

TOUGH TOOLS, HALF PRICE

Technical Support and E-Warranty Certificate

www.vevor.com/support