

VEVOR[®]

TOUGH TOOLS, HALF PRICE

Technical Support and E-Warranty Certificate www.vevor.com/support

PATIO DINING SETS (LONG TABLE) USER MANUAL

We continue to be committed to provide you tools with competitive price. "Save Half", "Half Price" or any other similar expressions used by us only represents an estimate of savings you might benefit from buying certain tools with us compared to the major top brands and does not necessarily mean to cover all categories of tools offered by us. You are kindly reminded to verify carefully when you are placing an order with us if you are actually saving half in comparison with the top major brand

VEVOR®

TOUGH TOOLS, HALF PRICE

PATIO DINING SETS
(LONG TABLE)

Model: FTS556

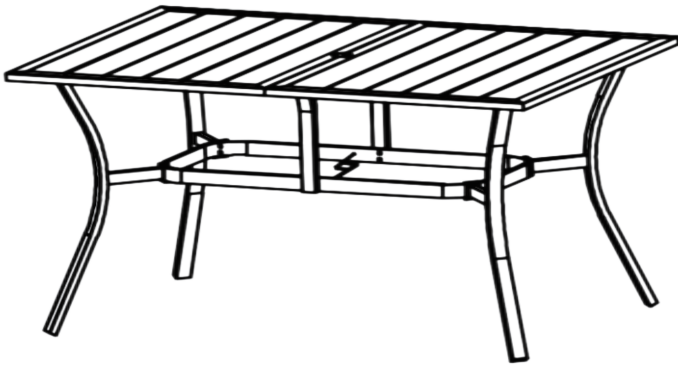

Note: Please be patient that the other items are on the way if you buy more than one product.

NEED HELP? CONTACT US!

Have product questions? Need technical support? Please feel free to contact us:

Technical Support and E-Warranty Certificate
www.vevor.com/support

This is the original instruction, please read all manual instructions carefully before operating. VEVOR reserves a clear interpretation of our user manual. The appearance of the product shall be subject to the product you received. Please forgive us that we won't inform you again if there are any technology or software updates on our product.

PRODUCT PARAMETERS

Model	Product Size(LxWxH)	Loading Capacity	material	Color
FTS556	L59" xW37.8"xH78.3" (1500x960x720mm)	264.5 lbs (Max) (about 120KG)	Metal	Black

ASSEMBLY PRECAUTIONS

1. Assemble needs to follow these instructions. Incorrect assembly can be a hazard.
2. Wear safety goggles and heavy-duty work gloves during assembly.
3. Do not assemble when tired or when under the influence of alcohol, drugs or medication.
4. Weight and other product properties are only applicable to correctly and completely assembled products.
5. Keep the assembly area clean and well-lit.
6. Keep bystanders out of the area during assembly.

USE PRECAUTIONS











WARNING: TO PREVENT SERIOUS INJURY AND DEATH FROM TIPPING:

1. This product is not a toy. Please keep the product away from children while assembling.
2. Use as intended only. Do not let children play or jump on the product. Do not stand on the item or use as a step ladder.
3. Inspect before every use. Do not use it if parts are loose or damaged.
4. Tighten the lower screws every three months to prevent loosening of the legs.
5. Do not exceed the listed weight capacity. Tighten all knobs securely before applying load. Be aware of dynamic loading! The sudden load movement may briefly create an excess load, causing product failure.

SAVE THESE INSTRUCTIONS

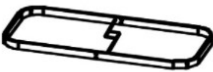
PARTS LIST

A		2	F	 M6*20	4
B		4	G	 M6*25	12
C		2	H	 M6	16
D		1	I	 M6	1
E	 M6*12	8			

ASSEMBLY STEPS

STEP1

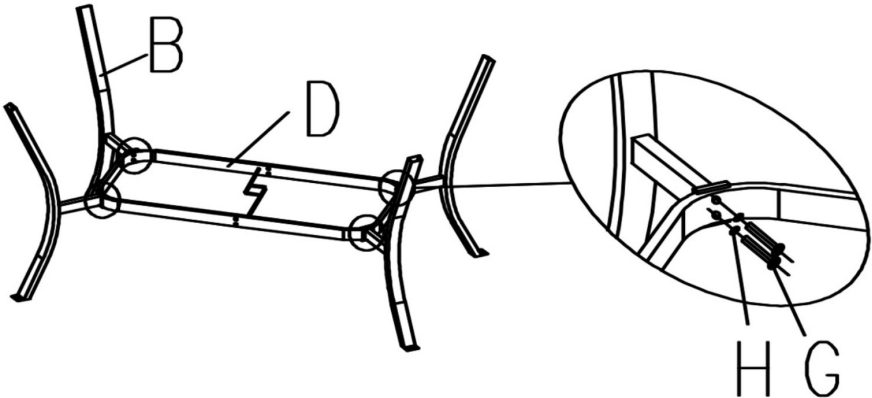

STEP2

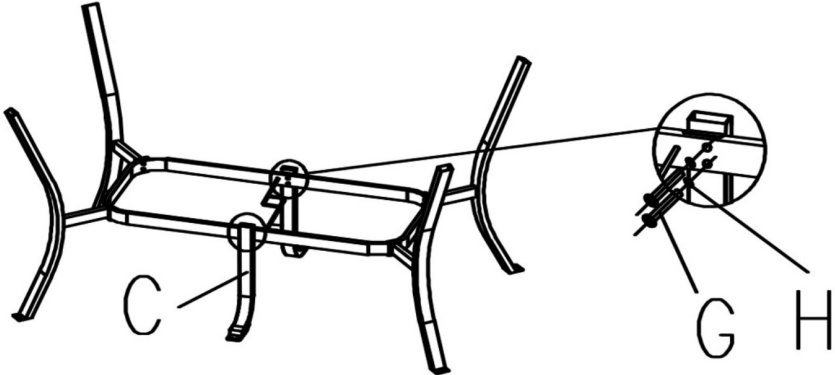

STEP3

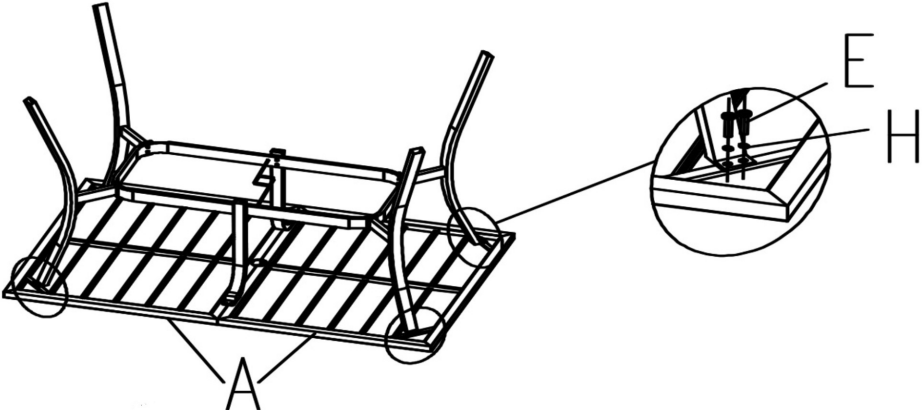

STEP4

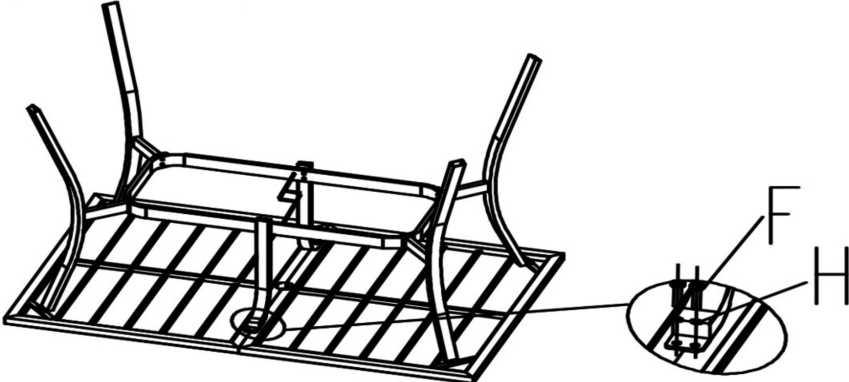

COMPLETION

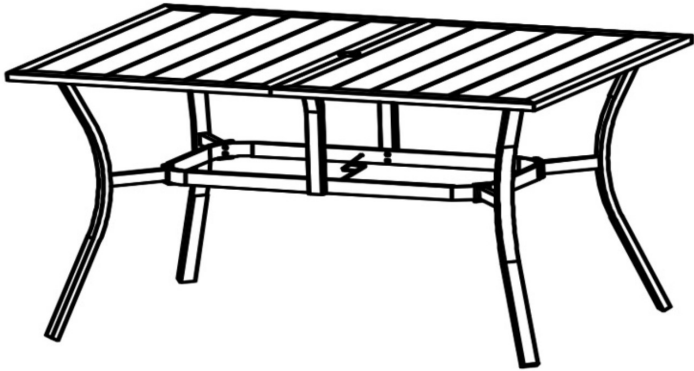

Cleaning and Maintenance

- Use a soft, clean cloth that will not scratch the surface when dusting.
- This item could be cleaned with soap and water. Be sure to avoid harsh solvents and abrasives.
- Periodically (every 90 days) make sure the screws are fully tightened.

Sanven Technology Ltd.

**Address: Suite 250, 9166 Anaheim Place, Rancho Cucamonga, CA
91730**

VEVOR[®]

TOUGH TOOLS, HALF PRICE
Technical Support and E-Warranty Certificate
www.vevor.com/support

VEVOR[®]

TOUGH TOOLS, HALF PRICE

Technical Support and E-Warranty Certificate www.vevor.com/support

PATIO DINING SETS (SWIVEL CHAIR) USER MANUAL

We continue to be committed to provide you tools with competitive price. "Save Half", "Half Price" or any other similar expressions used by us only represents an estimate of savings you might benefit from buying certain tools with us compared to the major top brands and does not necessarily mean to cover all categories of tools offered by us. You are kindly reminded to verify carefully when you are placing an order with us if you are actually saving half in comparison with the top major brand

VEVOR®

TOUGH TOOLS, HALF PRICE

PATIO DINING SETS
(SWIVEL CHAIR)

Model: FCS3319

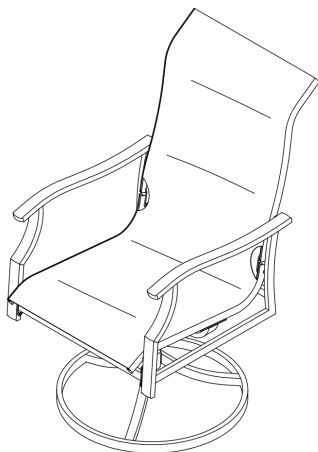

Note: Please be patient that the other items are on the way if you buy more than one product.

NEED HELP? CONTACT US!

Have product questions? Need technical support? Please feel free to contact us:

Technical Support and E-Warranty Certificate

www.vevor.com/support

This is the original instruction, please read all manual instructions carefully before operating. VEVOR reserves a clear interpretation of our user manual. The appearance of the product shall be subject to the product you received. Please forgive us that we won't inform you again if there are any technology or software updates on our product.

PRODUCT PARAMETERS

Model	Product Size(WxDxH)	Loading Capacity	material	Color
FCS3319	W 20 " x D 24 "x H 34.8 " (510x610x885mm)	300 lbs (Max) (about 150KG)	Teslin cushion + metal frame	Black

ASSEMBLY PRECAUTIONS

1. Assemble needs to follow these instructions. Incorrect assembly can be a hazard.
2. Wear safety goggles and heavy-duty work gloves during assembly.
3. Do not assemble when tired or when under the influence of alcohol, drugs or medication.
4. Weight and other product properties are only applicable to correctly and completely assembled products.
5. Keep the assembly area clean and well-lit.
6. Keep bystanders out of the area during assembly.

USE PRECAUTIONS











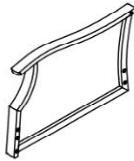





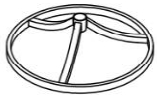

WARNING: TO PREVENT SERIOUS INJURY AND DEATH FROM TIPPING:

1. This product is not a toy. Please keep the product away from children while assembling.
2. Use as intended only. Do not let children play or jump on the product. Do not stand on the item or use as a step ladder.
3. Inspect before every use. Do not use it if parts are loose or damaged.
4. Tighten the lower screws every three months to prevent loosening of the legs.
5. Do not exceed the listed weight capacity. Tighten all knobs secure before applying load. Be aware of dynamic loading! The sudden movement may briefly create an excess load, causing product failure.

SAVE THESE INSTRUCTIONS

PARTS LIST

A		2		H	 M8*35	8+2
B		2		I	 M8	8+2
C		2		J	 M8	8+2
D		4		K	 M8	8+2
E		2		L	 M6*15	16+2
F		2		M	 M6*30	8+2
G		4+2		N	 M6	24+2
				O	 M6	1
				P	 M8	2

ASSEMBLY STEPS

STEP1

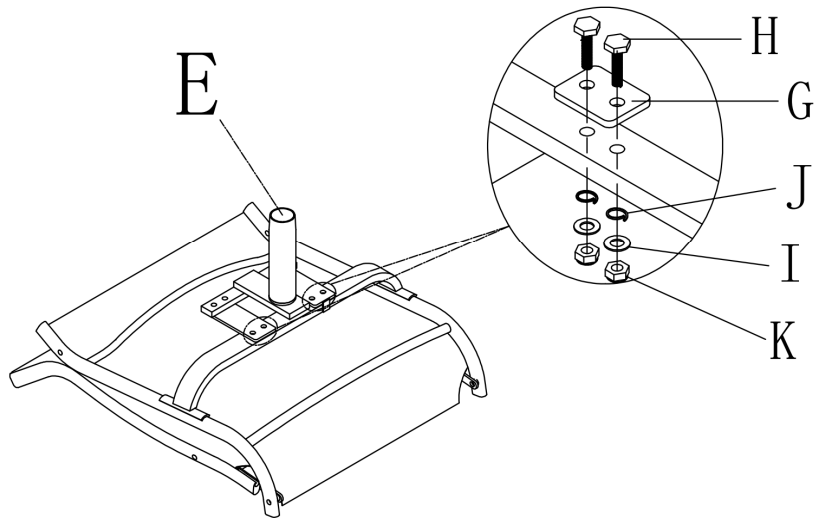

STEP2

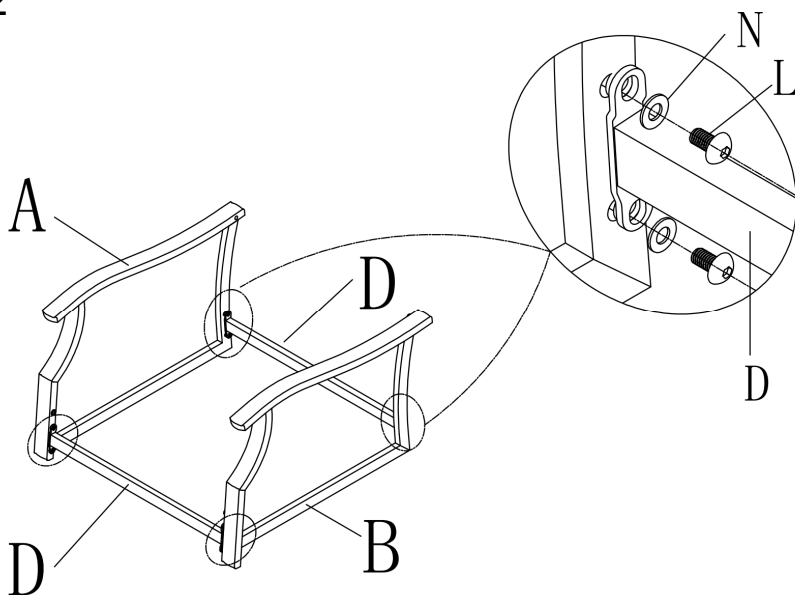

STEP3

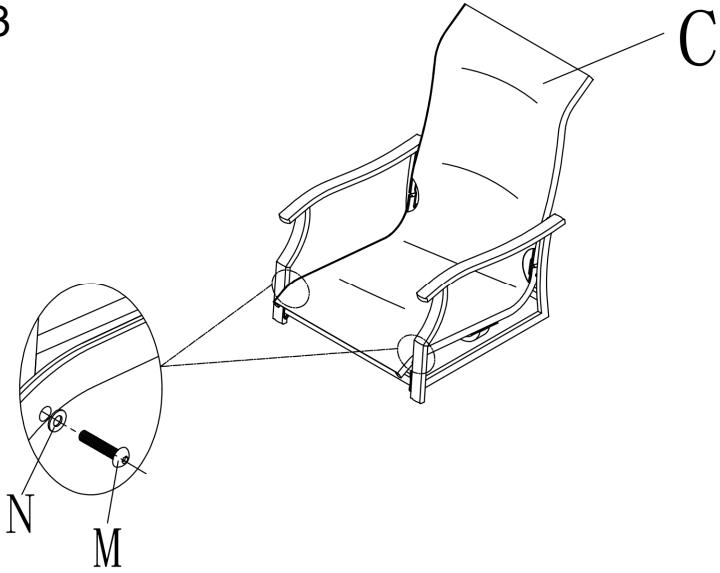

STEP4

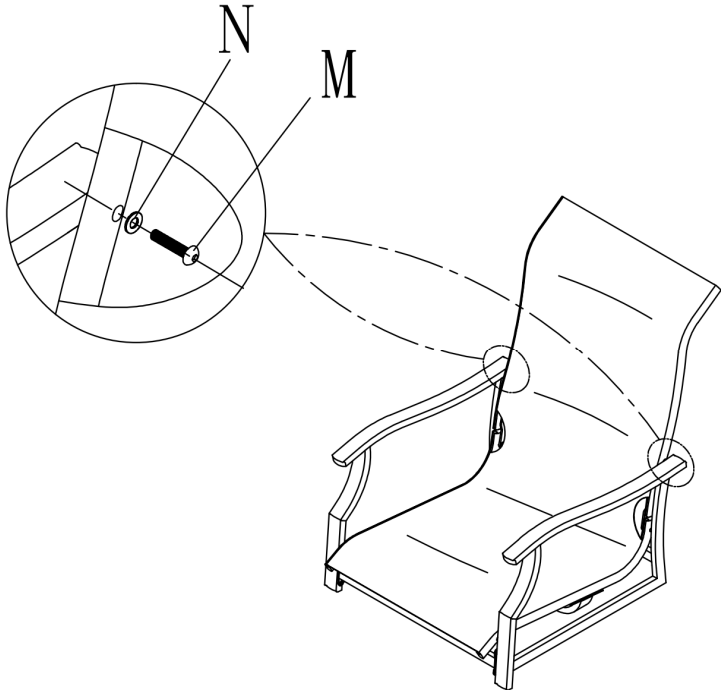

STEP5

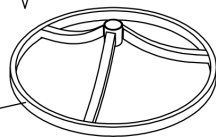
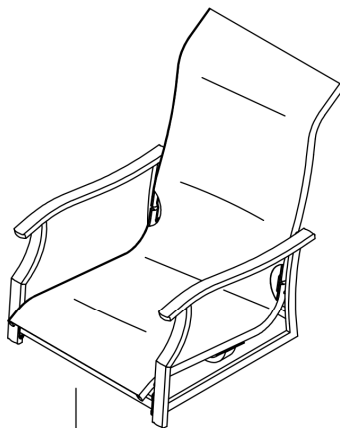

F

COMPLETION

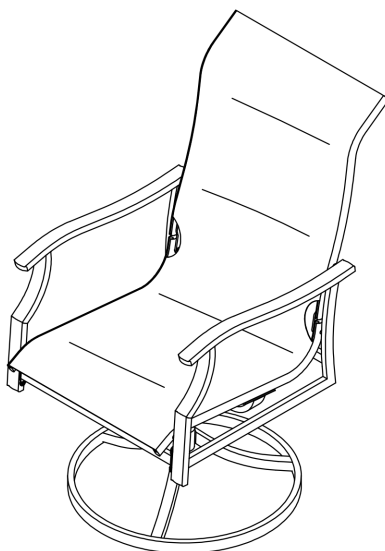

Cleaning and Maintenance

- Use a soft, clean cloth that will not scratch the surface when dusting.
- This item could be cleaned with soap and water. Be sure to avoid harsh solvents and abrasives (Except for seat cushions) .
- Periodically (every 90 days) make sure the screws are fully tightened.

Sanven Technology Ltd.

**Address: Suite 250, 9166 Anaheim Place, Rancho Cucamonga, CA
91730**

VEVOR[®]

TOUGH TOOLS, HALF PRICE
Technical Support and E-Warranty Certificate
www.vevor.com/support