

# VEVOR

**Affordable. Reliable. Home Improvement.**

**Rattan Dresser**

**Model:ZD-25TB01**



# VEVOR

Affordable. Reliable. Home Improvement.

## RATTAN DRESSER

MODEL:ZD-25TB01

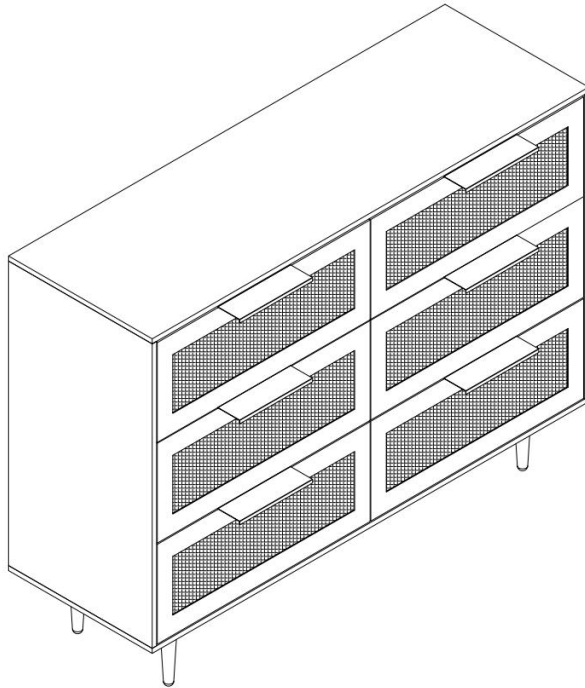

This is the original instruction, please read all manual instructions carefully before operating. VEVOR reserves a clear interpretation of our user manual. The appearance of the product shall be subject to the product you received. Please forgive us that we won't inform you again if there are any technology or software updates on our product.

## **SAFETY INSTRUCTIONS**

### **INTRODUCTION**

**Thank you for purchasing our products. Committed to providing customers with the best quality products and service has always been our lifelong goal. Before using the product, please read this instruction manual carefully to ensure correct use. Keep the instruction manual in a place where the user can find it at any time.**

### **ASSEMBLY PRECAUTIONS**

**There are many components and accessories in the package. Each component and accessory is labeled with a letter or a number, check carefully before using any of them. Keep them away from children to prevent accidents.**

1. Assemble only according to these instructions. Improper assembly may create hazards.
2. Wear ANSI-approved safety goggles and heavy-duty work gloves during assembly.
3. Keep the assembly area clean and well-lit.
4. Keep bystanders out of the area during assembly.
5. Do not assemble if tired or when under the influence of alcohol, drugs or medication.
6. The product capabilities apply to properly and completely assembled products only.
7. Please install the product on a clean and soft underlay (such as carpet or cardboard) to avoid scratching or damaging the surface of the product.
8. If possible, you can use power tools to make assembly easier.
9. The main components of the product is relatively heavy. Please pay attention to safety during installation.
10. The product is not stable during installation, Please do not move it randomly before it is completely installed.
11. For additional information regarding the parts listed in the following.

pages, please refer to the Assembly Diagram of this manual. Unwrap and separate all parts in a clean work area.

**\*PLEASE BE SURE TO FOLLOW THE INSTALLATION STEPS IN THE MANUAL TO AVOID UNNECESSARY LOSSES CAUSED BY IMPROPER INSTALLATION.**

### **USE PRECAUTIONS**

- 1) Do not exceed specified weight capacities.
- 2) Use only on a flat, level, hard, and smooth surface that can safely support a fully loaded Rattan Dresser.
- 3) Use as intended only.
- 4) Inspect before every use; do not use if parts are loose or damaged.

### **WARNING**

**Children have died from furniture tipover. To reduce the risk of furniture tipover:**







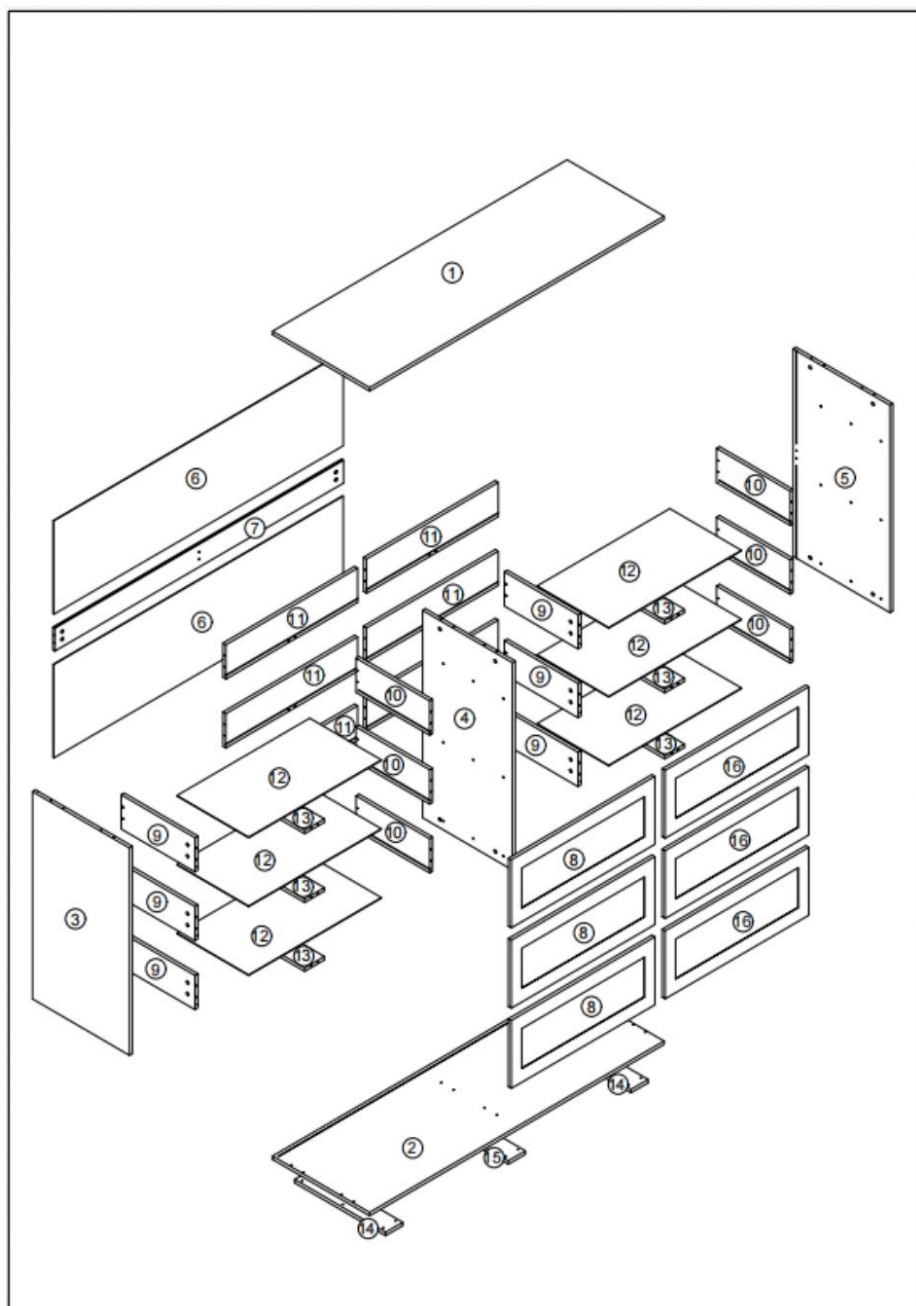

- **ALWAYS** install Anti-tip device provided.
- **NEVER** put a TV on this product.
- **NEVER** allow children to stand, climb or hang on drawers, doors, or shelves.
- **NEVER** open more than one drawer at a time.
- **Place heaviest items in the lowest drawers.**

**SAVE THIS MANUAL**



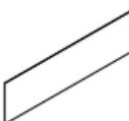

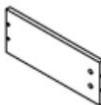
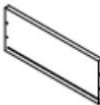

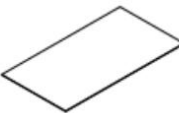
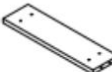
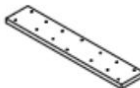
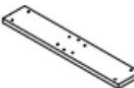
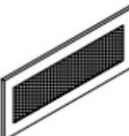





# EXPLODED VIEW

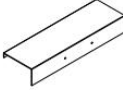

## PARTS LIST

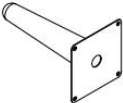
<p>①</p>  <p style="text-align: right;">x1</p>	<p>②</p>  <p style="text-align: right;">x1</p>	<p>③</p>  <p style="text-align: right;">x1</p>	<p>④</p>  <p style="text-align: right;">x1</p>
<p>⑤</p>  <p style="text-align: right;">x1</p>	<p>⑥</p>  <p style="text-align: right;">x2</p>	<p>⑦</p>  <p style="text-align: right;">x1</p>	<p>⑧</p>  <p style="text-align: right;">x3</p>
<p>⑨</p>  <p style="text-align: right;">x6</p>	<p>⑩</p>  <p style="text-align: right;">x6</p>	<p>⑪</p>  <p style="text-align: right;">x6</p>	<p>⑫</p>  <p style="text-align: right;">x6</p>
<p>⑬</p>  <p style="text-align: right;">x6</p>	<p>⑭</p>  <p style="text-align: right;">x2</p>	<p>⑮</p>  <p style="text-align: right;">x1</p>	<p>⑯</p>  <p style="text-align: right;">x3</p>

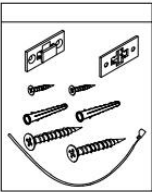
## PARTS LIST

<p style="text-align: center;">A</p>  <p style="text-align: center;">x66+2</p>	<p style="text-align: center;">B</p>  <p style="text-align: center;">x66+2</p>	<p style="text-align: center;">C</p>  <p style="text-align: center;">x12</p>	<p style="text-align: center;">D</p>  <p style="text-align: center;">x104+2</p>
<p style="text-align: center;">E</p>  <p style="text-align: center;">x18</p>	<p style="text-align: center;">F</p>  <p style="text-align: center;">x24</p>	<p style="text-align: center;">G</p>  <p style="text-align: center;">x6</p>	<p style="text-align: center;">H</p>  <p style="text-align: center;">x12</p>
<p style="text-align: center;">I</p>  <p style="text-align: center;">x5</p>	<p style="text-align: center;">J</p>  <p style="text-align: center;">x16</p>	<p style="text-align: center;">K</p>  <p style="text-align: center;">x16</p>	<p style="text-align: center;">L</p>  <p style="text-align: center;">x1</p>
 <p style="text-align: center;">x1</p>			

## ASSEMBLY STEP

### Installation of Cams and Pins

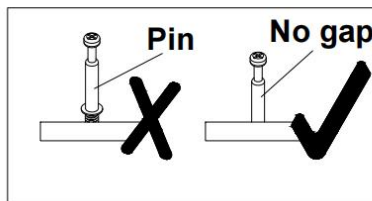
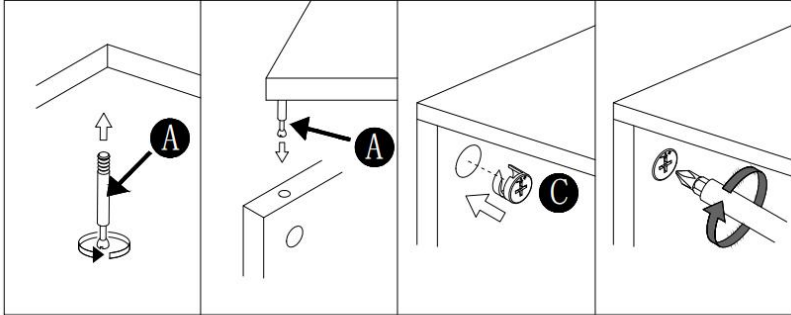

## ASSEMBLY STEP

### Step 1

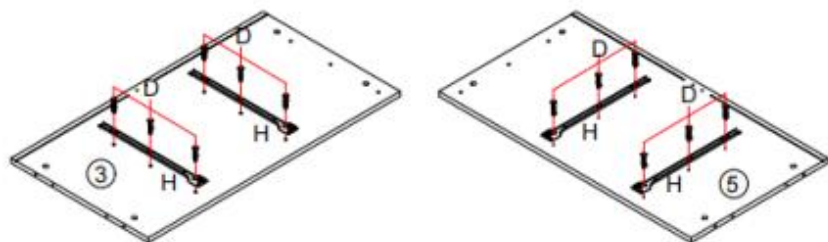

### Step 2

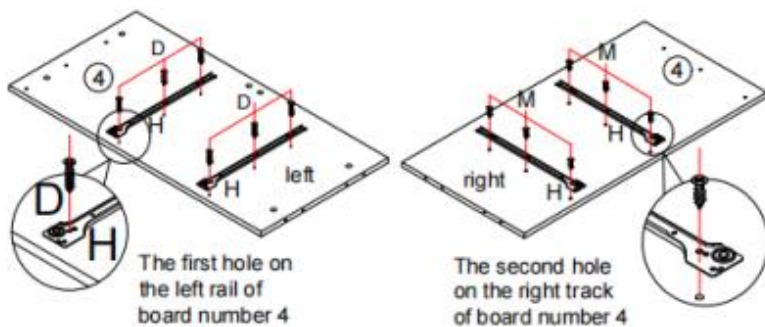

## ASSEMBLY STEP

### Step 3

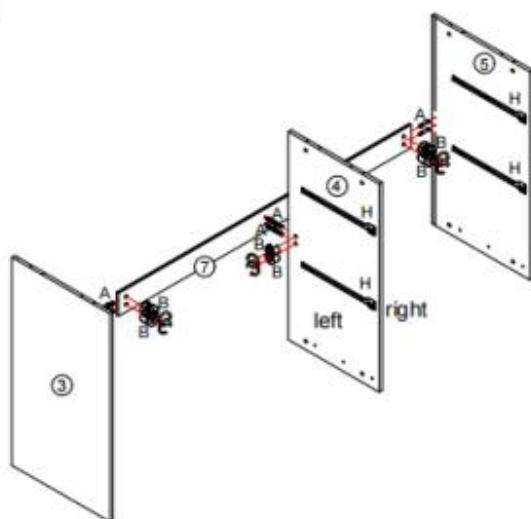

### Step 4

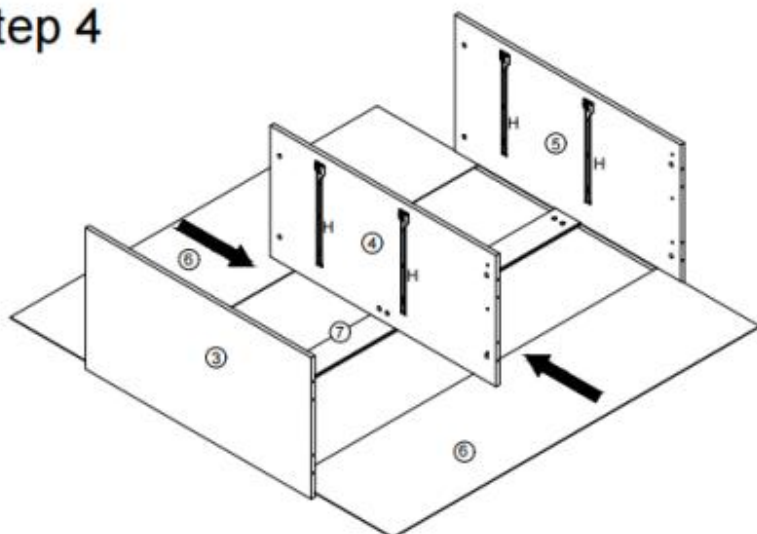

## ASSEMBLY STEP

### Step 5

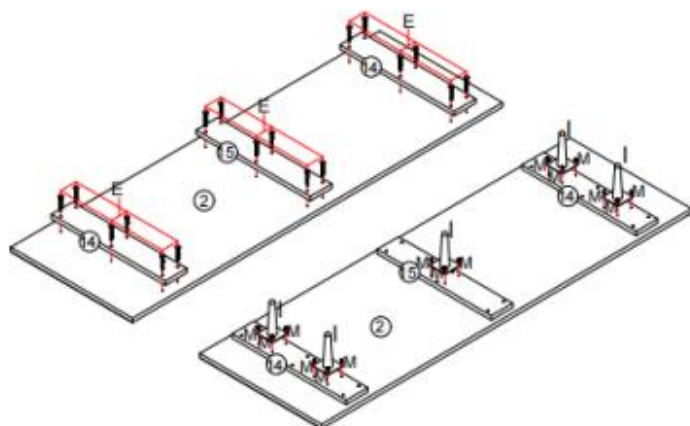

### Step 6

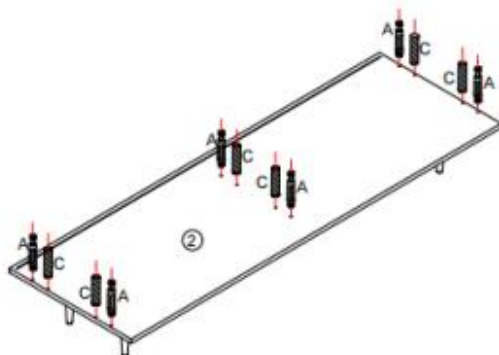

## ASSEMBLY STEP

### Step 7

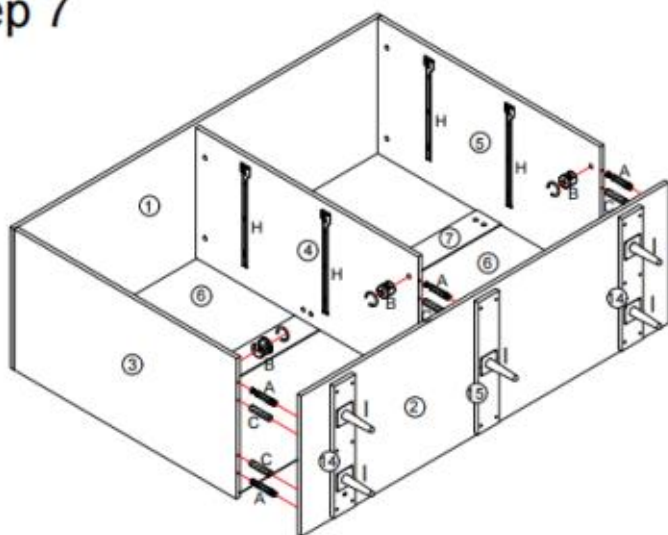

### Step 8

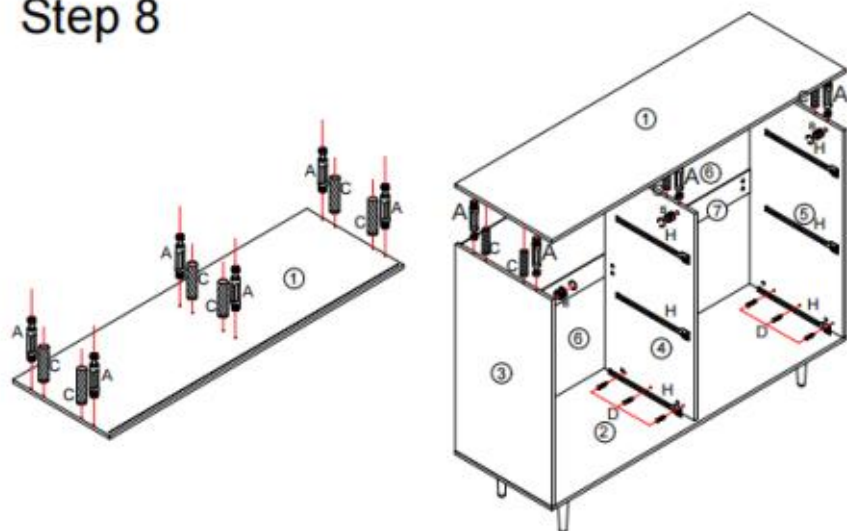

## ASSEMBLY STEP

### Step 9

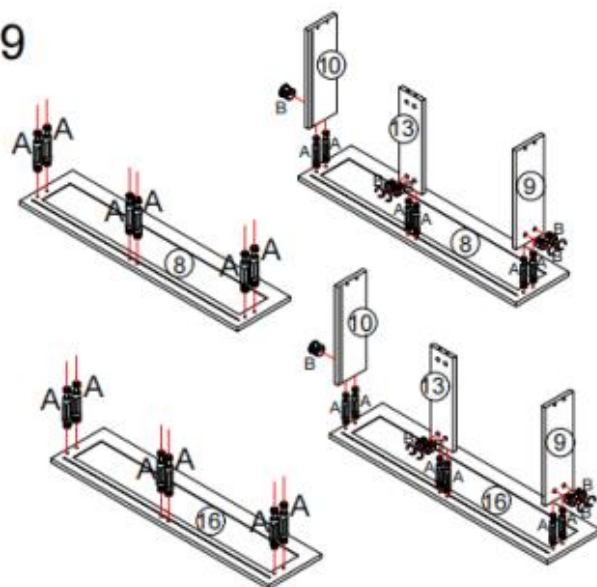

### Step 10

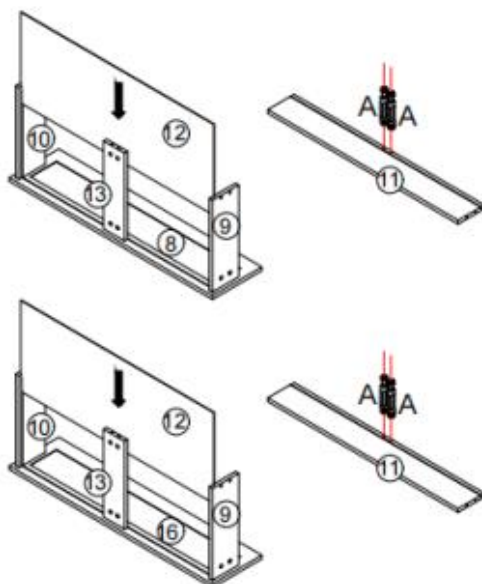

## ASSEMBLY STEP

### Step 11

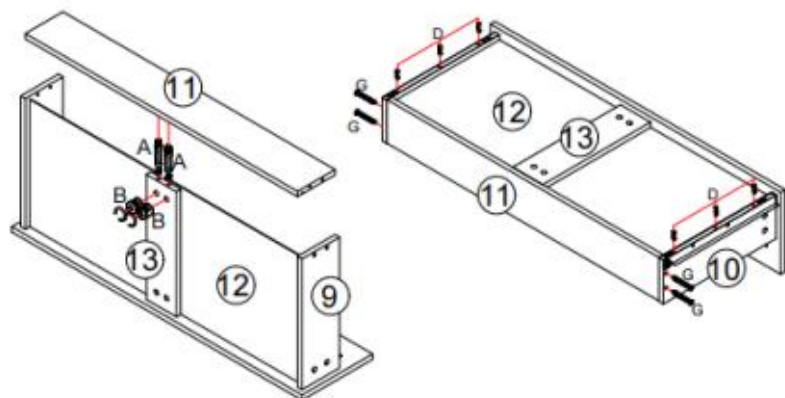

### Step 12

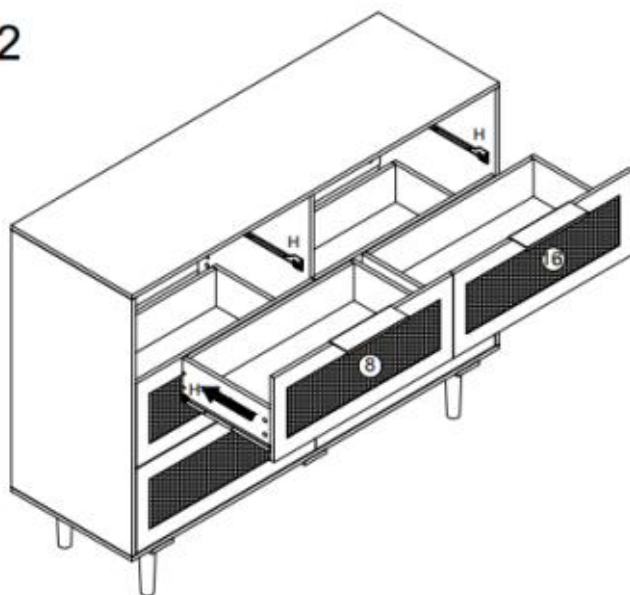

## ASSEMBLY STEP

Step 13

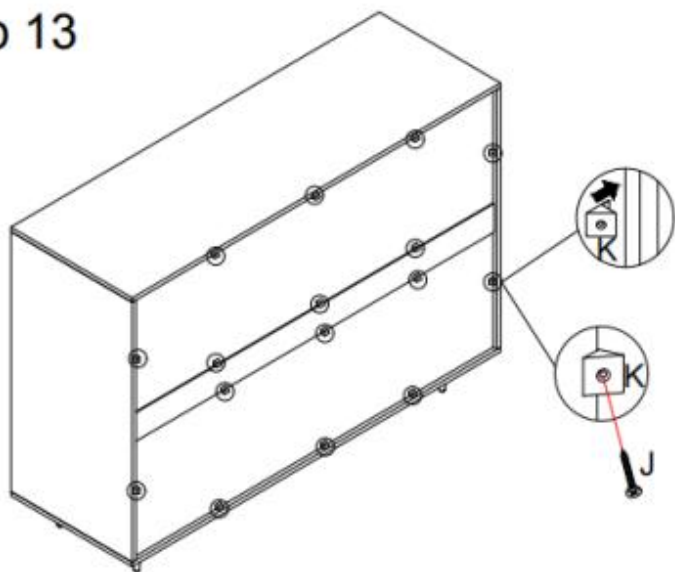

Step 14

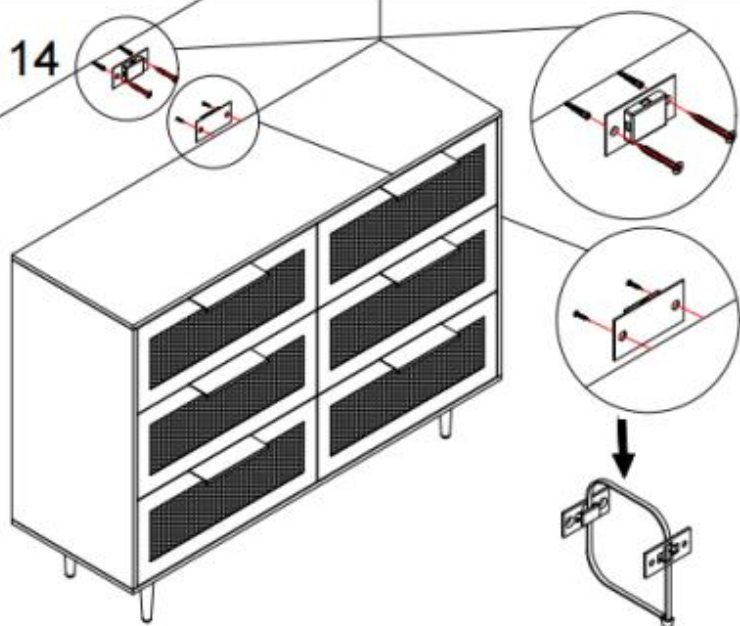

## PRODUCT PARAMETER

<b>Model</b>	<b>ZD-25TB01</b>
<b>Safe Loading Weight</b>	Drawer:22 lbs/desktop:66lbs
<b>Product Size(D*W*H)</b>	1200*395*854mm

\* Products such as specifications, appearance, and design are subject to modification without prior notice.

**Manufacturer:** Caoxian Zhengda Arts&Crafts Co.,LTD

**Address:** Guyingji Development Zone, Cao County, Shandong Province, China 274418

**Imported to AUS:** SIHAO PTY LTD. 1 ROKEVA STREETEASTWOOD NSW 2122 Australia

**Imported to USA:** Sanven Technology Ltd. Suite 250, 9166 Anaheim Place, Rancho Cucamonga, CA 91730

<b>EC</b>	<b>REP</b>
-----------	------------

E-CrossStu GmbH  
Mainzer Landstr.69, 60329 Frankfurt am Main.

<b>UK</b>	<b>REP</b>
-----------	------------

YH CONSULTING LIMITED.  
C/O YH Consulting Limited Office 147, Centurion House, London Road, Staines-upon-Thames, Surrey, TW18 4AX





# **VEVOR**

**Affordable. Reliable. Home Improvement.**

**Commode en rotin**

**Modèle : ZD-25TB01**



# VEVOR

Affordable. Reliable. Home Improvement.

## RATTAN DRESSER

MODÈLE : ZD-25TB01

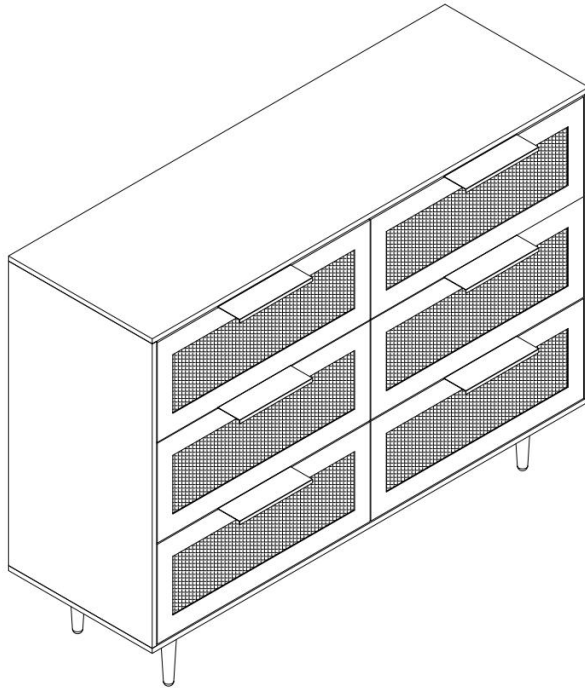

Ceci est le mode d'emploi d'origine. Veuillez lire attentivement l'intégralité du manuel avant utilisation. VEVOR se réserve le droit d'interpréter clairement ce manuel d'utilisation. L'apparence du produit dépend du produit que vous avez reçu. Veuillez nous excuser de ne pas vous informer ultérieurement des mises à jour technologiques ou logicielles de notre produit.

## SAFETY INSTRUCTIONS

### INTRODUCTION

**Merci d'avoir acheté nos produits. Notre engagement à fournir à nos clients des produits et un service de la meilleure qualité a toujours été notre priorité. Avant d'utiliser ce produit, veuillez lire ceci. manuel d'instructions soigneusement pour garantir une utilisation correcte. Conservez le manuel d'instructions dans un endroit où l'utilisateur peut le retrouver à tout moment.**

### ASSEMBLÉE PRÉCAUTIONS

**Il y en a beaucoup composants et accessoires dans l'emballage. Chaque le composant et l'accessoire sont étiquetés avec une lettre ou un numéro, vérifiez soigneusement avant d'utiliser l'un d'entre eux. Gardez-les hors de portée des enfants pour prévenir les accidents.**

1. Assembler uniquement conformément à ces instructions. Un assemblage incorrect peut créer des dangers.
2. Portez des lunettes de sécurité approuvées ANSI et des gants de travail robustes pendant l' assemblage.
3. Gardez la zone de montage propre et bien éclairée.
4. Gardez les spectateurs hors de la zone pendant le montage.
5. Ne montez pas si vous êtes fatigué ou sous l'influence de l'alcool, de drogues ou de médicaments.
6. Les capacités du produit s'appliquent uniquement aux produits correctement et entièrement assemblés.
7. Veuillez installer le produit sur une sous-couche propre et douce (comme de la moquette) ou carton) pour éviter de rayer ou d'endommager la surface du produit .
8. Si possible, vous pouvez utiliser des outils électriques pour faciliter le montage.
9. Les principaux composants du produit sont relativement lourds. Veuillez payer attention à la sécurité lors de l'installation .

10. Le produit n'est pas stable lors de l'installation, veuillez ne pas le déplacer au hasard avant qu'il ne soit complètement installé .
11. Pour plus d'informations sur les pièces répertoriées ci-dessous. Pour les pages suivantes, veuillez vous référer au schéma d'assemblage de ce manuel. Déballez et séparez toutes les pièces dans un espace de travail propre.

**\*ASSUREZ-VOUS DE SUIVRE LES ÉTAPES D'INSTALLATION DANS LE MANUEL POUR ÉVITEZ LES PERTES INUTILES CAUSÉES PAR UNE MAUVAISE INSTALLATION.**

### **UTILISER PRÉCAUTIONS**

- 1) Ne pas dépasser la dose spécifiée capacités de poids.
- 2) Utiliser uniquement sur une surface plane, de niveau, dure et lisse pouvant supporter en toute sécurité une commode en rotin entièrement chargée.
- 3) Utiliser uniquement comme prévu.
- 4) Inspectez avant chaque utilisation ; ne pas utiliser si des pièces sont desserrées ou endommagées.

### **AVERTISSEMENT**

**Des enfants sont morts à cause de meubles basculement. Pour réduire le risque de renversement des meubles basculement:**







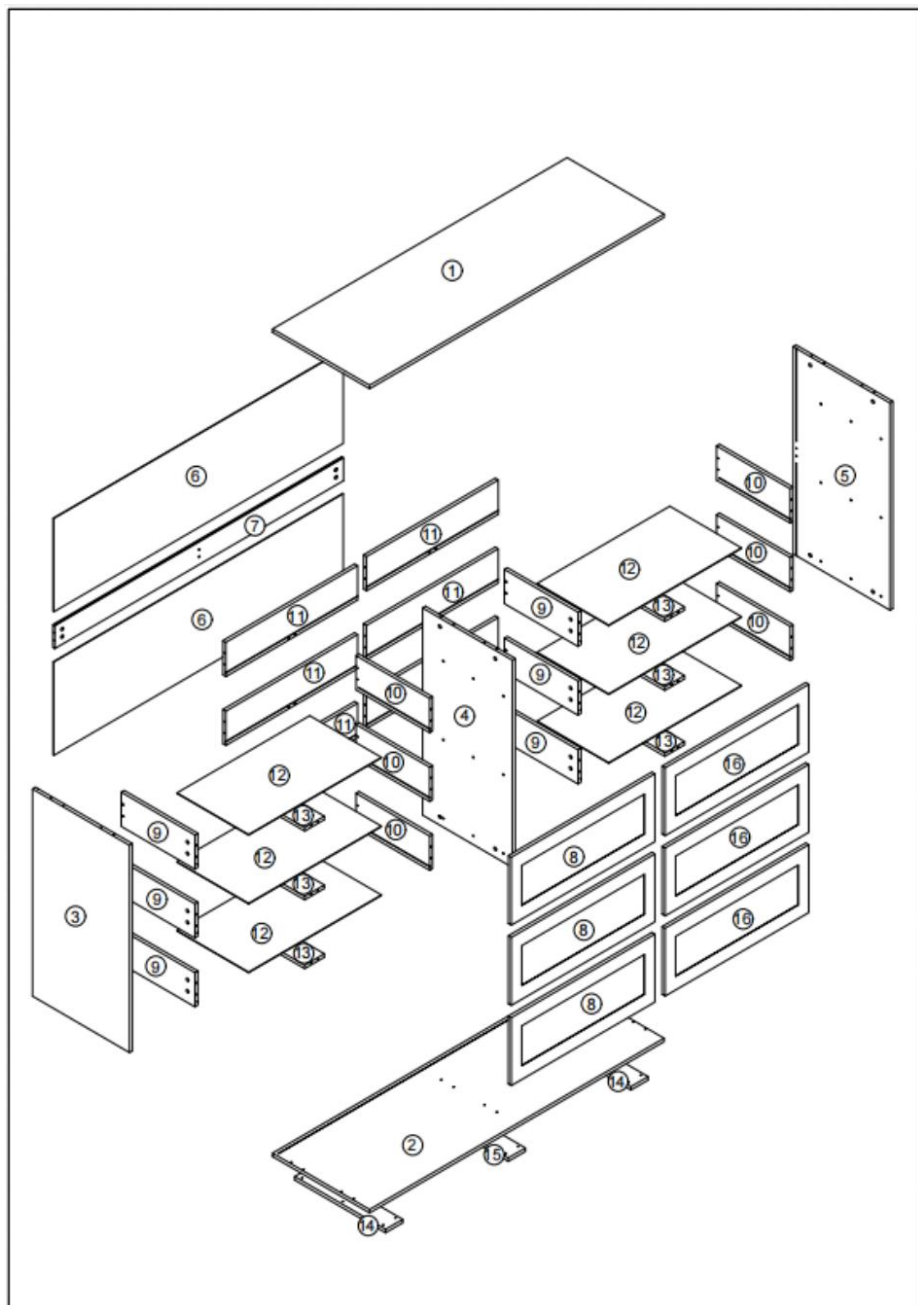



- **Installez TOUJOURS le dispositif anti-basculement fourni.**
- **NE JAMAIS placer un téléviseur sur ce produit.**
- **NE JAMAIS laisser les enfants se tenir debout, grimper ou se suspendre sur les tiroirs, les portes ou les étagères.**
- **N'ouvrez JAMAIS plus d'un tiroir à la fois .**
- **Placez les articles les plus lourds dans les tiroirs les plus bas .**

### **CONSERVEZ CE MANUEL**

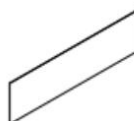

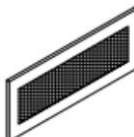
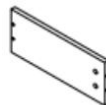

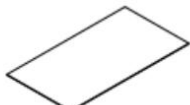
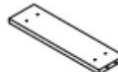
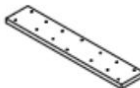







## EXPLODED VIEW

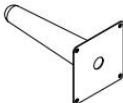

## PARTS LIST

<p>①</p>  <p style="text-align: right;">x1</p>	<p>②</p>  <p style="text-align: right;">x1</p>	<p>③</p>  <p style="text-align: right;">x1</p>	<p>④</p>  <p style="text-align: right;">x1</p>
<p>⑤</p>  <p style="text-align: right;">x1</p>	<p>⑥</p>  <p style="text-align: right;">x2</p>	<p>⑦</p>  <p style="text-align: right;">x1</p>	<p>⑧</p>  <p style="text-align: right;">x3</p>
<p>⑨</p>  <p style="text-align: right;">x6</p>	<p>⑩</p>  <p style="text-align: right;">x6</p>	<p>⑪</p>  <p style="text-align: right;">x6</p>	<p>⑫</p>  <p style="text-align: right;">x6</p>
<p>⑬</p>  <p style="text-align: right;">x6</p>	<p>⑭</p>  <p style="text-align: right;">x2</p>	<p>⑮</p>  <p style="text-align: right;">x1</p>	<p>⑯</p>  <p style="text-align: right;">x3</p>

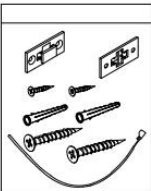
## PARTS LIST

<p style="text-align: center;">A</p>  <p style="text-align: center;">x66+2</p>	<p style="text-align: center;">B</p>  <p style="text-align: center;">x66+2</p>	<p style="text-align: center;">C</p>  <p style="text-align: center;">x12</p>	<p style="text-align: center;">D</p>  <p style="text-align: center;">x104+2</p>
<p style="text-align: center;">E</p>  <p style="text-align: center;">x18</p>	<p style="text-align: center;">F</p>  <p style="text-align: center;">x24</p>	<p style="text-align: center;">G</p>  <p style="text-align: center;">x6</p>	<p style="text-align: center;">H</p>  <p style="text-align: center;">x12</p>
<p style="text-align: center;">I</p>  <p style="text-align: center;">x5</p>	<p style="text-align: center;">J</p>  <p style="text-align: center;">x16</p>	<p style="text-align: center;">K</p>  <p style="text-align: center;">x16</p>	<p style="text-align: center;">L</p>  <p style="text-align: center;">x1</p>
 <p style="text-align: center;">x1</p>			

## ASSEMBLY STEP

### Installation of Cams and Pins

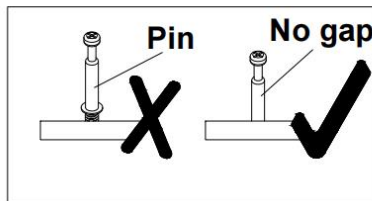
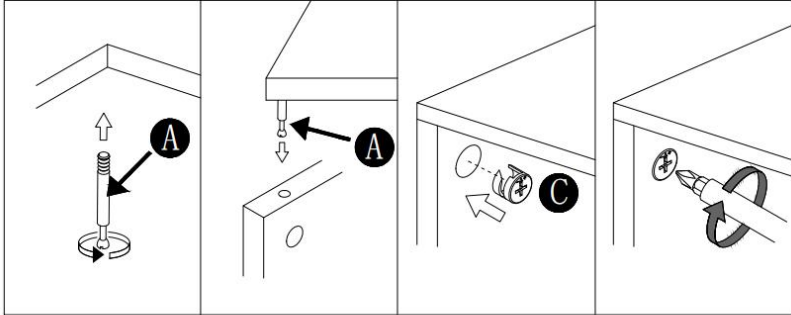

## ASSEMBLY STEP

### Step 1

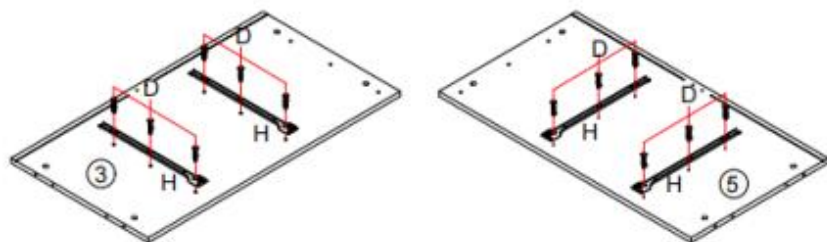

### Step 2

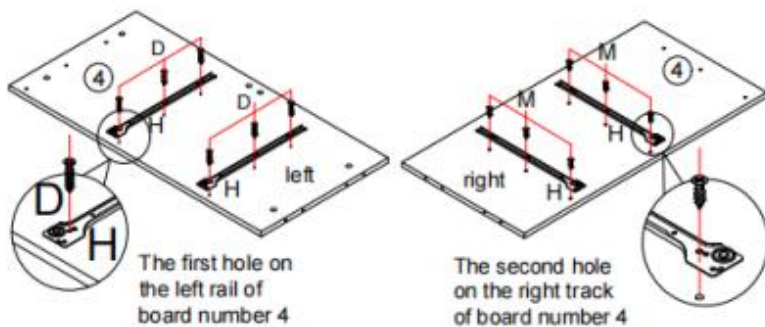

## ASSEMBLY STEP

### Step 3

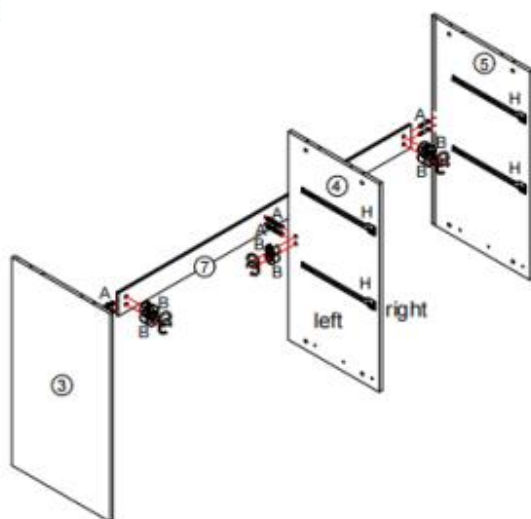

### Step 4

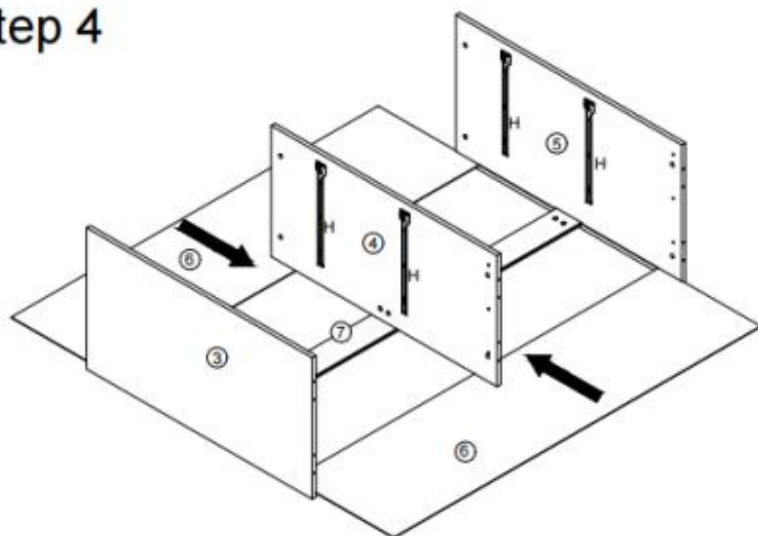

## ASSEMBLY STEP

### Step 5

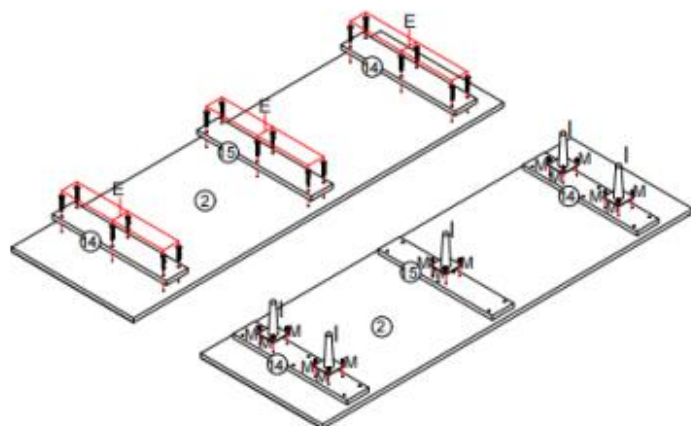

### Step 6

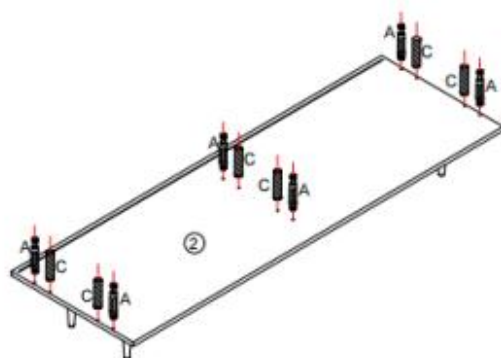

## ASSEMBLY STEP

### Step 7

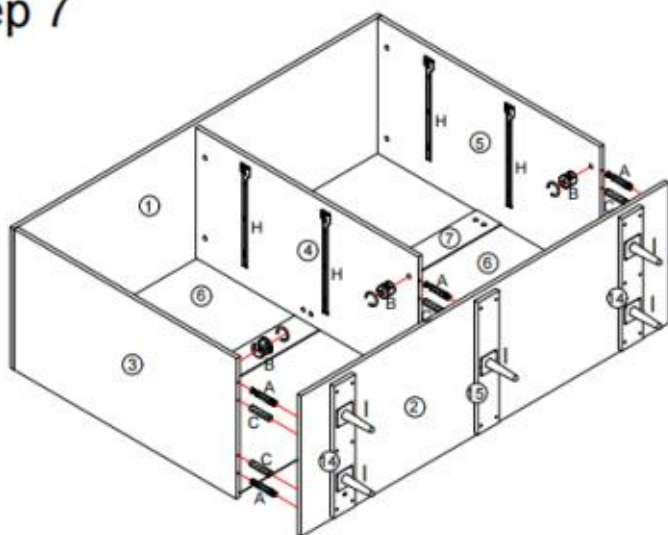

### Step 8

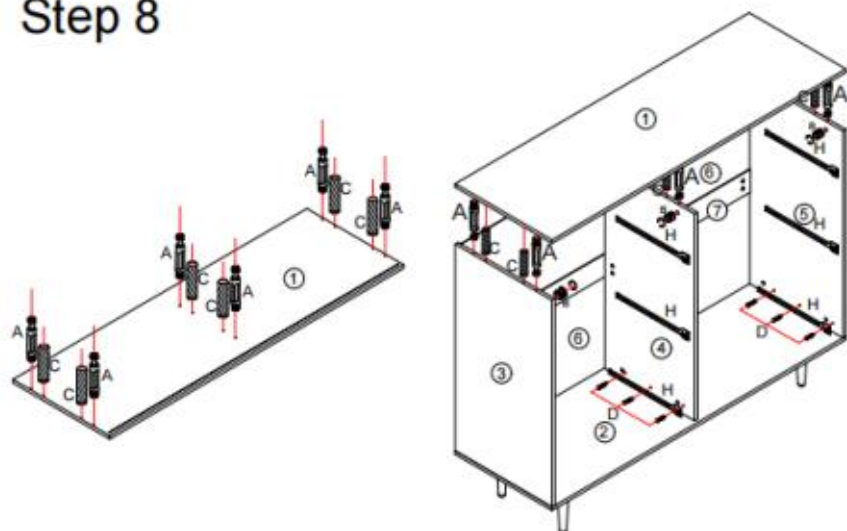

## ASSEMBLY STEP

### Step 9

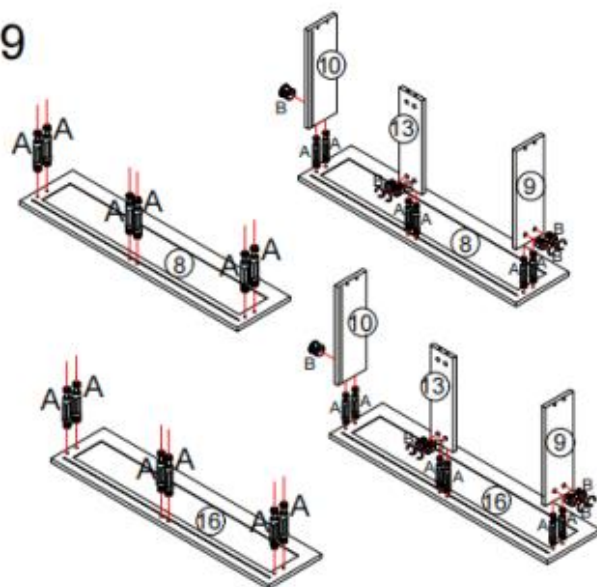

### Step 10

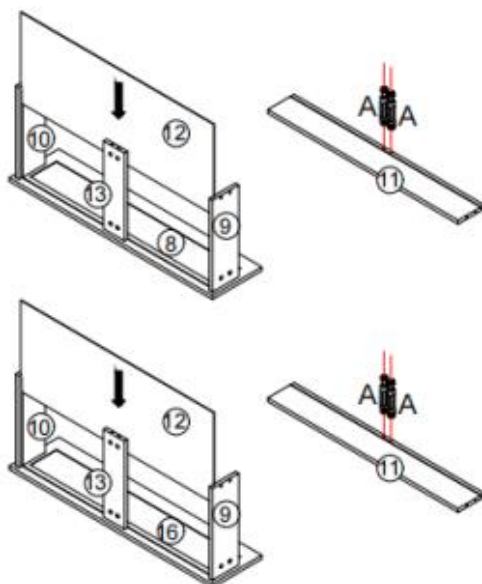

## ASSEMBLY STEP

### Step 11

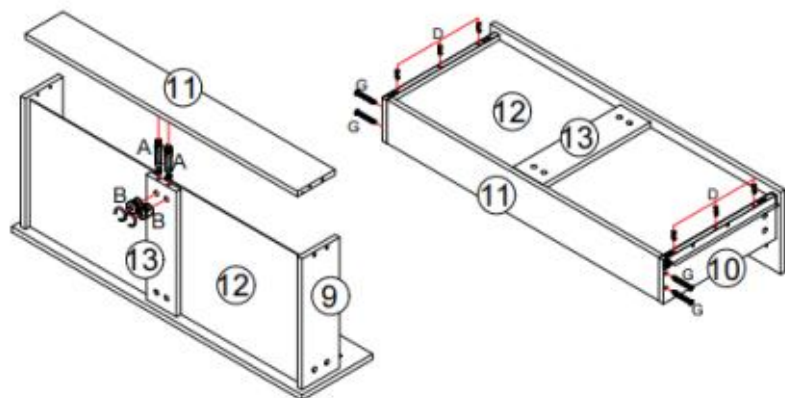

### Step 12

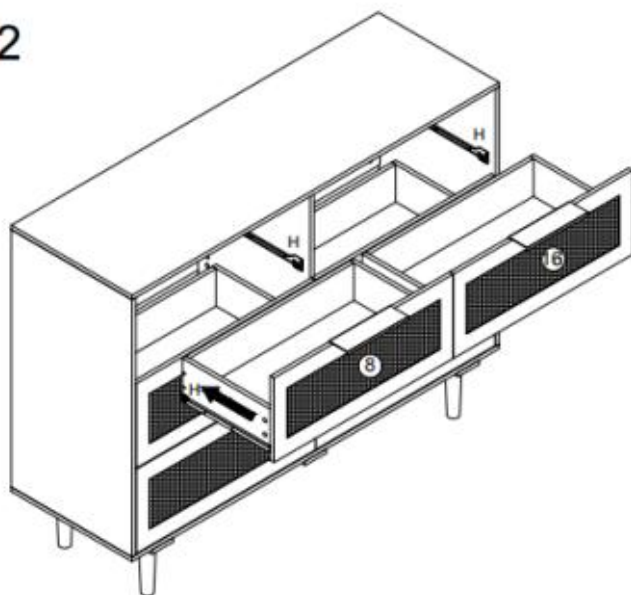

## ASSEMBLY STEP

Step 13

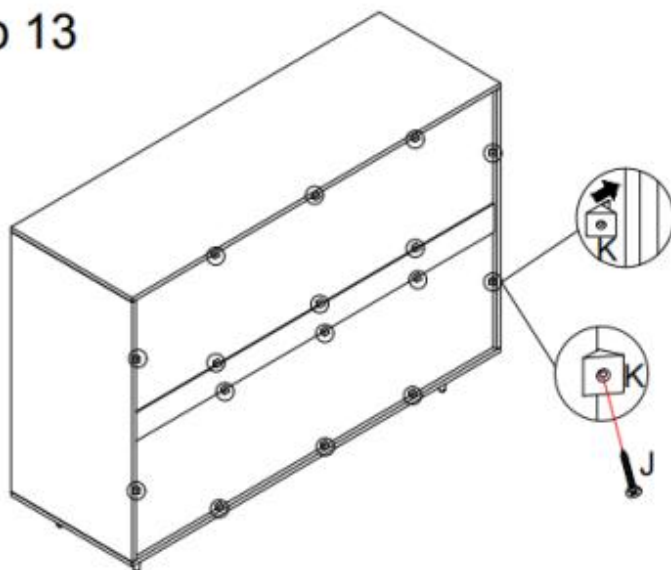

Step 14

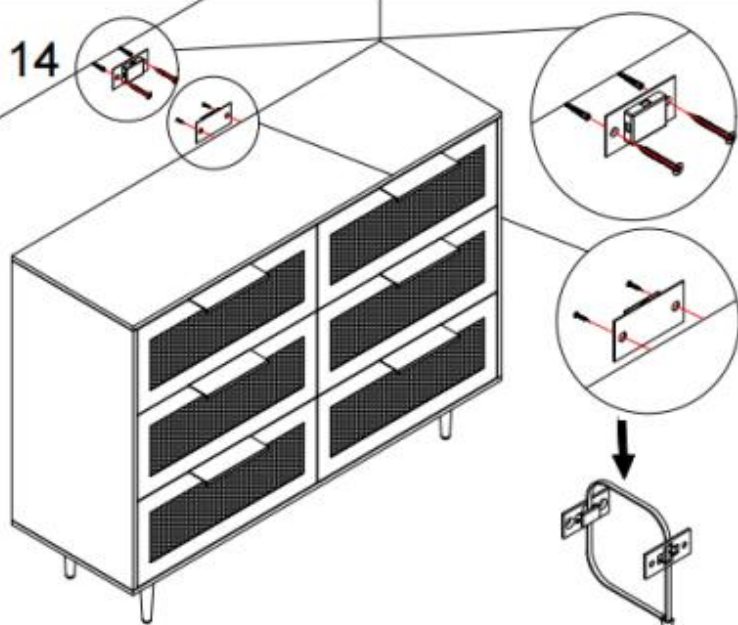

## PRODUCT PARAMETER

<b>Modèle</b>	<b>ZD-25TB01</b>
<b>Poids de chargement sécuritaire</b>	Tiroir:22 lb/bureau : 66 lb
<b>Dimensions du produit (P*L*H)</b>	1 2 00* 395 * 854 mm

\* Les produits tels que les spécifications, l'apparence et la conception sont sujets à modification sans préavis.

**Fabricant** : Caoxian Zhengda Arts&Crafts Co., LTD

**Adresse** : Zone de développement de Guyingji, comté de Cao, province du Shandong, Chine 274418

**Importé en Australie** : SIHAO PTY LTD. 1 ROKEVA STREET, ASTWOOD, NSW 2122, Australie

**Importé aux États-Unis** : Sanven Technology Ltd. Suite 250, 9166 Anaheim Place, Rancho Cucamonga, CA 91730

<b>EC</b>	<b>REP</b>
-----------	------------

E-CrossStu GmbH  
Mainzer Landstr.69, 60329 Frankfurt am Main.

<b>UK</b>	<b>REP</b>
-----------	------------

YH CONSULTING LIMITED.  
C/O YH Consulting Limited Office 147, Centurion House, London Road, Staines-upon-Thames, Surrey, TW18 4AX





# **VEVOR**

**Affordable. Reliable. Home Improvement.**

**Rattan Kommode**

**Modell: ZD-25TB01**



# VEVOR

Affordable. Reliable. Home Improvement.

## RATTAN DRESSER

**MODELL: ZD-25TB01**

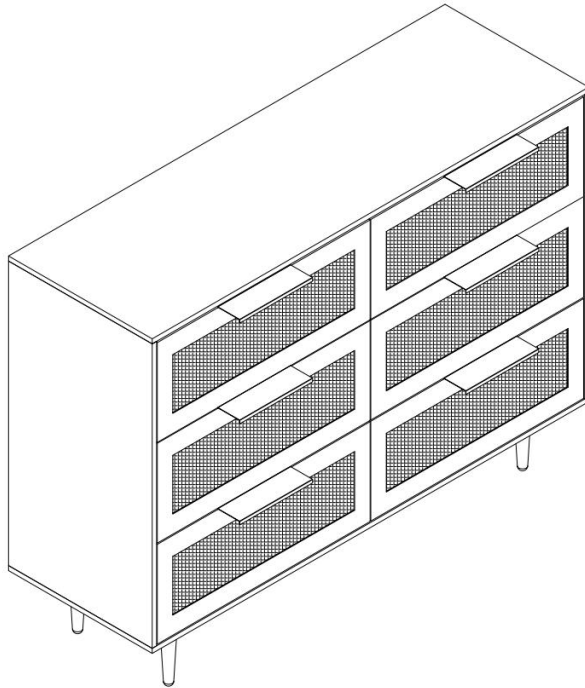

Dies ist die Originalanleitung. Bitte lesen Sie alle Anweisungen sorgfältig durch, bevor Sie das Gerät in Betrieb nehmen. VEVOR behält sich eine klare Auslegung unserer Bedienungsanleitung vor. Das Aussehen des Produkts hängt vom gelieferten Produkt ab. Bitte haben Sie Verständnis dafür, dass wir Sie nicht erneut über Technologie- oder Software-Updates informieren.

## **SAFETY INSTRUCTIONS**

### **EINFÜHRUNG**

**Vielen Dank für den Kauf unserer Produkte. Unser Ziel ist es, unseren Kunden Produkte und Dienstleistungen von höchster Qualität zu bieten. Bitte lesen Sie vor der Verwendung des Produkts diese Bedienungsanleitung sorgfältig, um eine korrekte Verwendung zu gewährleisten. Bewahren Sie die Bedienungsanleitung an einem wo der Benutzer es jederzeit finden kann.**

### **MONTAGE VORSICHTSMASSNAHMEN**

**Es gibt viele Komponenten und Zubehör im Paket. Jeder Komponente und Zubehör mit einem Buchstaben oder einer Zahl gekennzeichnet ist, überprüfen Lesen Sie diese sorgfältig durch, bevor Sie sie verwenden. Bewahren Sie sie außerhalb der Reichweite von Kindern auf, Unfälle verhindern.**

1. Führen Sie die Montage ausschließlich gemäß dieser Anleitung durch. Eine unsachgemäße Montage kann zu Gefahren führen.
2. Tragen Sie während der Montage eine ANSI-zugelassene Schutzbrille und strapazierfähige Arbeitshandschuhe.
3. Halten Sie den Versammlungsbereich sauber und gut beleuchtet.
4. Halten Sie während der Montage unbeteiligte Personen vom Bereich fern.
5. Nicht zusammenbauen, wenn Sie müde sind oder unter dem Einfluss von Alkohol, Drogen oder Medikamenten stehen.
6. Die Produkteigenschaften gelten nur für ordnungsgemäß und vollständig montierte Produkte.
7. Bitte installieren Sie das Produkt auf einer sauberen und weichen Unterlage (z. B. Teppich oder Pappe), um Kratzer oder Beschädigungen der Oberfläche des Produkt .
8. Um die Montage zu erleichtern, können Sie nach Möglichkeit Elektrowerkzeuge verwenden.
9. Die Hauptkomponenten des Produkts sind relativ schwer. Bitte zahlen

Sie Achten Sie bei der Installation auf die Sicherheit .

10. Das Produkt ist während der Installation nicht stabil. Bitte bewegen Sie es nicht willkürlich. bevor es vollständig installiert ist .
11. Weitere Informationen zu den im Folgenden aufgeführten Teilen finden Sie unter:  
Seiten finden Sie im Montagediagramm dieses Handbuchs. Packen Sie alle Teile in einem sauberen Arbeitsbereich aus und trennen Sie sie.

**\*BITTE BEFOLGEN SIE DIE INSTALLATIONSSCHRITTE IM HANDBUCH, UM VERMEIDEN SIE UNNÖTIGE VERLUSTE DURCH UNSACHGEMÄSSE INSTALLATION.**

#### **VERWENDEN VORSICHTSMASSNAHMEN**

- 1) Überschreiten Sie nicht die angegebene Gewichtskapazitäten.
- 2) Nur auf einer flachen, ebenen, harten und glatten Oberfläche verwenden, die eine voll beladene Rattankommode sicher tragen kann.
- 3) Nur bestimmungsgemäß verwenden.
- 4) Vor jedem Gebrauch prüfen; nicht verwenden, wenn Teile lose oder beschädigt sind.

#### **WARNUNG**

**Kinder sind durch Möbel gestorben Um das Risiko zu verringern, dass Möbel Umkippen:**







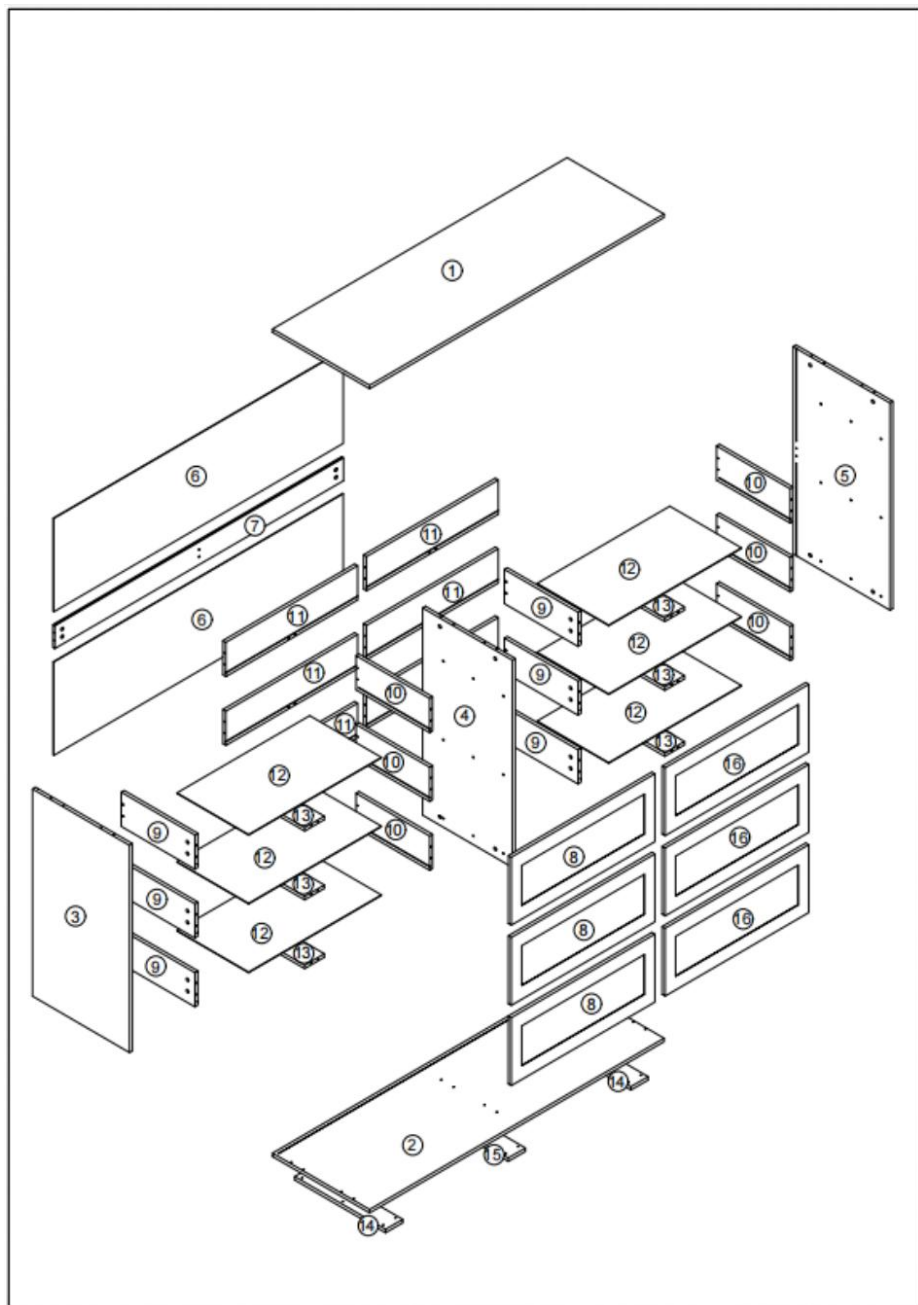



- Installieren Sie **IMMER** die mitgelieferte Kippschutzvorrichtung.
- Stellen Sie **NIEMALS** einen Fernseher auf dieses Produkt.
- Lassen Sie Kinder **NIEMALS** stehen, klettern oder hängen an Schubladen, Türen oder Regalen.
- Öffnen Sie **NIEMALS** mehr als eine Schublade gleichzeitig .
- Legen Sie die schwersten Gegenstände in die untersten Schubladen .

**BEWAHREN SIE DIESES HANDBUCH AUF**

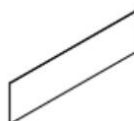

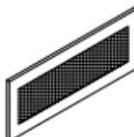
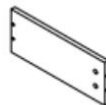

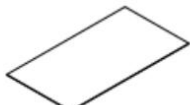
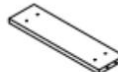
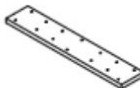







**EXPLODED VIEW**

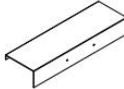

## PARTS LIST

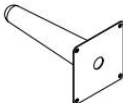
<p>①</p>  <p style="text-align: right;">x1</p>	<p>②</p>  <p style="text-align: right;">x1</p>	<p>③</p>  <p style="text-align: right;">x1</p>	<p>④</p>  <p style="text-align: right;">x1</p>
<p>⑤</p>  <p style="text-align: right;">x1</p>	<p>⑥</p>  <p style="text-align: right;">x2</p>	<p>⑦</p>  <p style="text-align: right;">x1</p>	<p>⑧</p>  <p style="text-align: right;">x3</p>
<p>⑨</p>  <p style="text-align: right;">x6</p>	<p>⑩</p>  <p style="text-align: right;">x6</p>	<p>⑪</p>  <p style="text-align: right;">x6</p>	<p>⑫</p>  <p style="text-align: right;">x6</p>
<p>⑬</p>  <p style="text-align: right;">x6</p>	<p>⑭</p>  <p style="text-align: right;">x2</p>	<p>⑮</p>  <p style="text-align: right;">x1</p>	<p>⑯</p>  <p style="text-align: right;">x3</p>

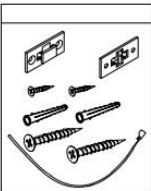
## PARTS LIST

<p style="text-align: center;">A</p>  <p style="text-align: center;">x66+2</p>	<p style="text-align: center;">B</p>  <p style="text-align: center;">x66+2</p>	<p style="text-align: center;">C</p>  <p style="text-align: center;">x12</p>	<p style="text-align: center;">D</p>  <p style="text-align: center;">x104+2</p>
<p style="text-align: center;">E</p>  <p style="text-align: center;">x18</p>	<p style="text-align: center;">F</p>  <p style="text-align: center;">x24</p>	<p style="text-align: center;">G</p>  <p style="text-align: center;">x6</p>	<p style="text-align: center;">H</p>  <p style="text-align: center;">x12</p>
<p style="text-align: center;">I</p>  <p style="text-align: center;">x5</p>	<p style="text-align: center;">J</p>  <p style="text-align: center;">x16</p>	<p style="text-align: center;">K</p>  <p style="text-align: center;">x16</p>	<p style="text-align: center;">L</p>  <p style="text-align: center;">x1</p>
 <p style="text-align: center;">x1</p>			

## ASSEMBLY STEP

### Installation of Cams and Pins

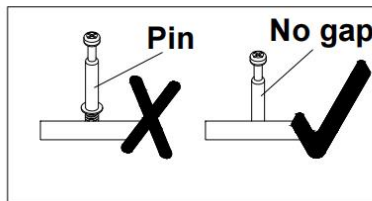
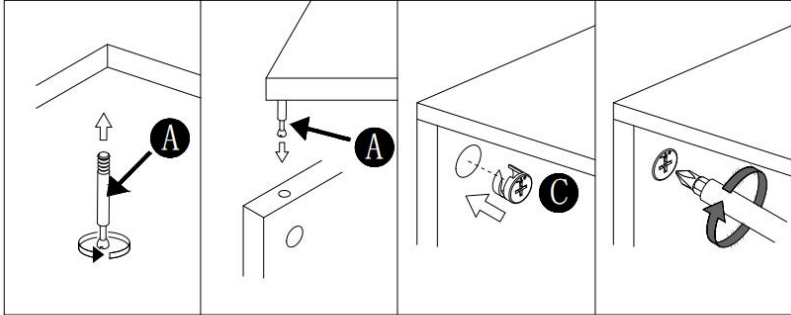

## ASSEMBLY STEP

### Step 1

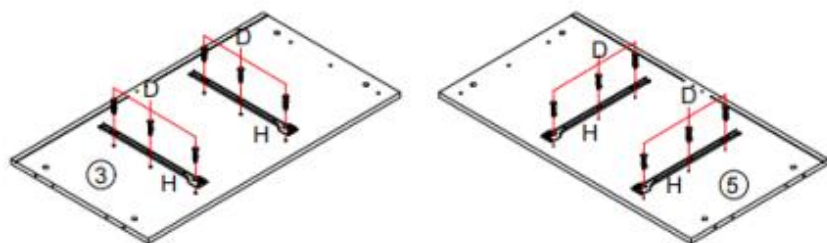

### Step 2

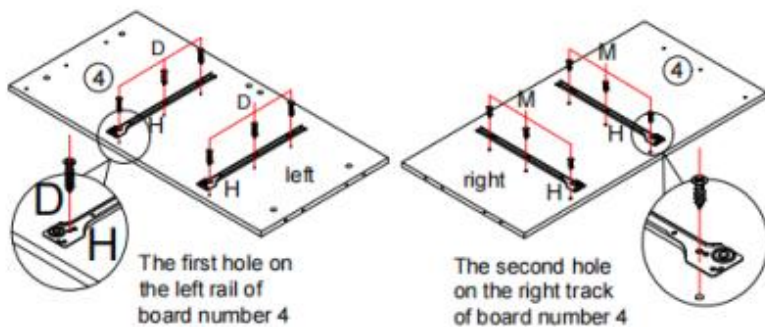

## ASSEMBLY STEP

### Step 3

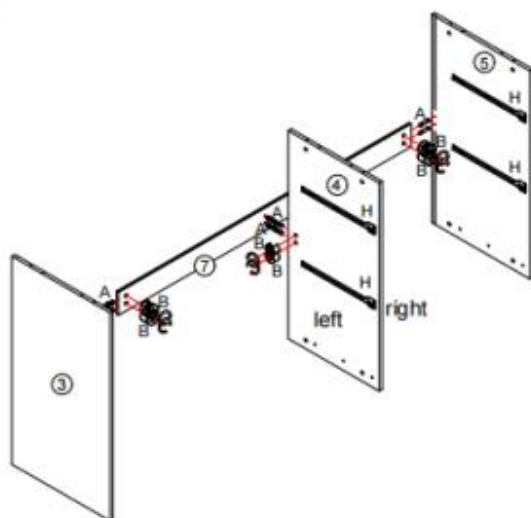

### Step 4

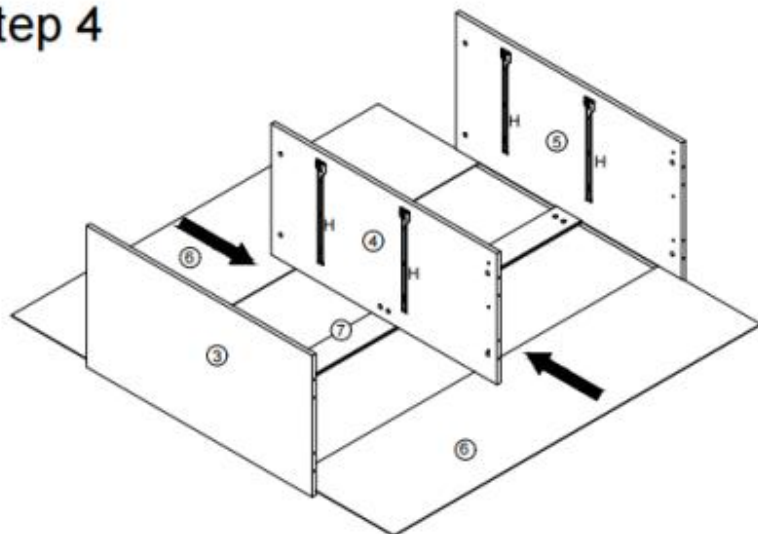

## ASSEMBLY STEP

### Step 5

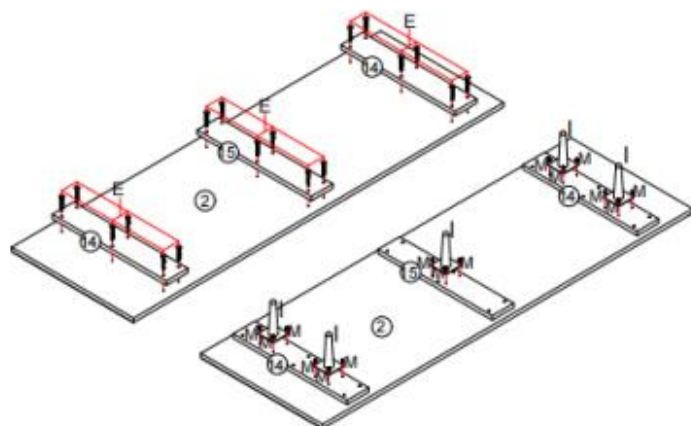

### Step 6

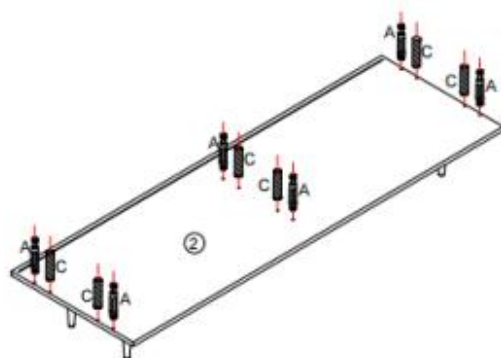

## ASSEMBLY STEP

### Step 7

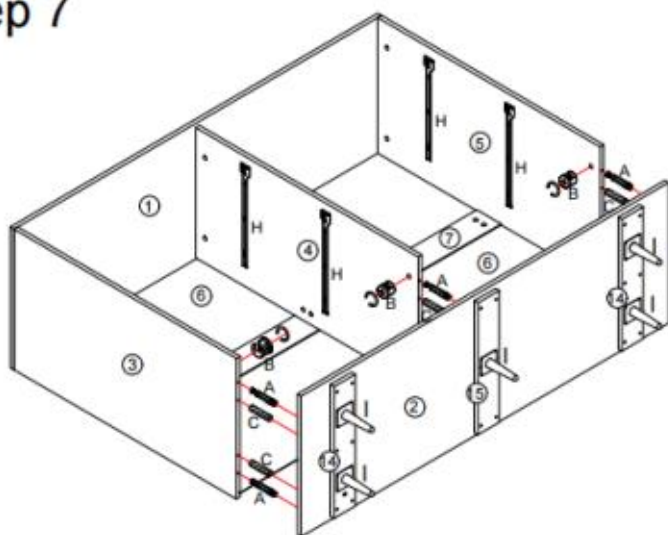

### Step 8

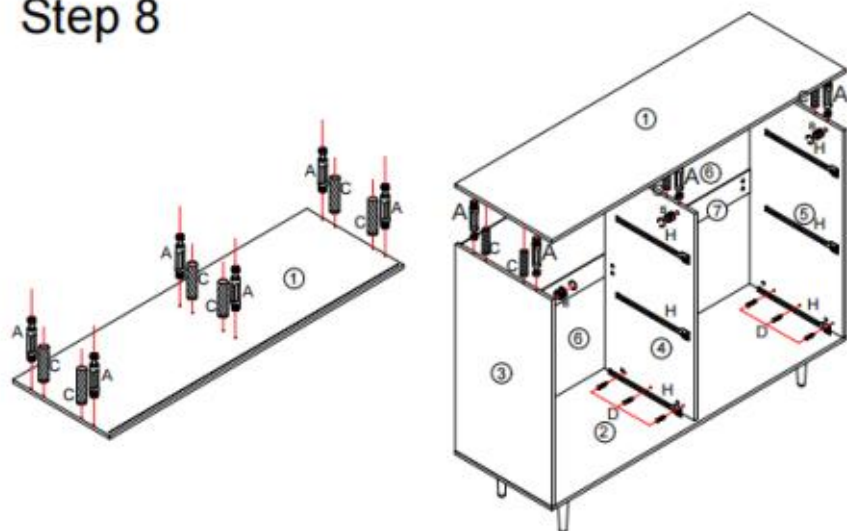

## ASSEMBLY STEP

### Step 9

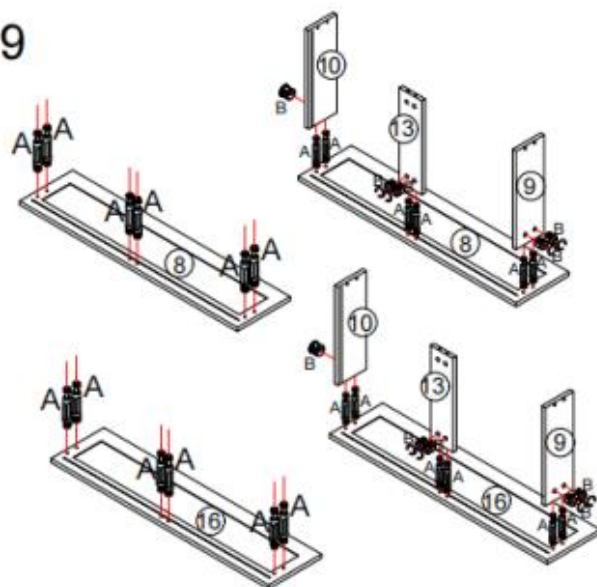

### Step 10

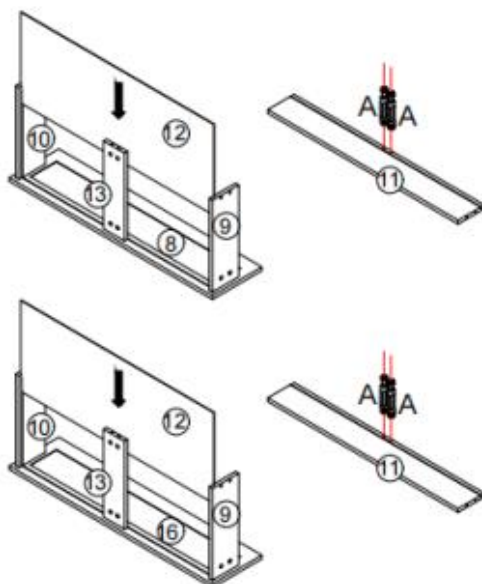

## ASSEMBLY STEP

### Step 11

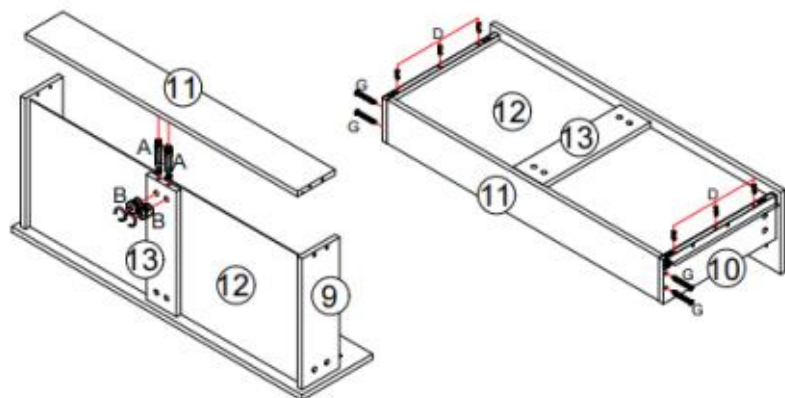

### Step 12

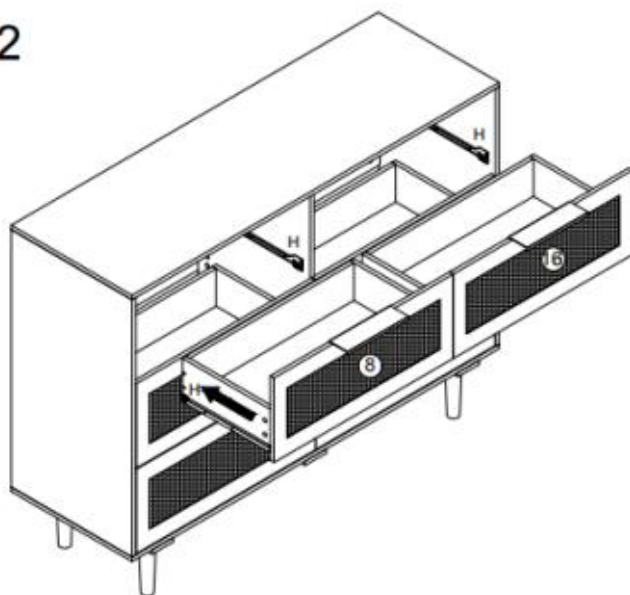

## ASSEMBLY STEP

Step 13

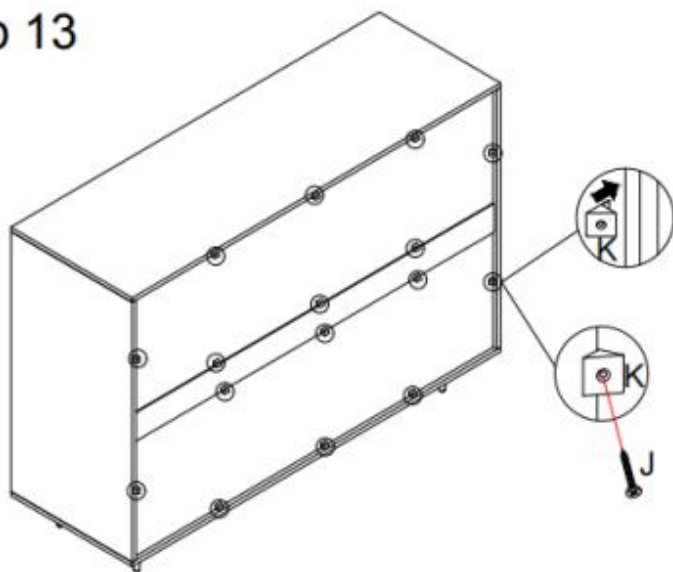

Step 14

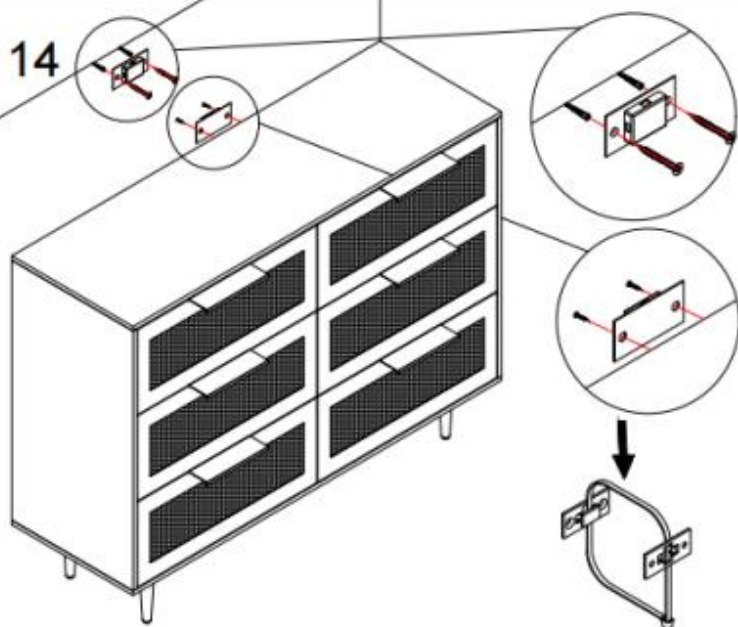

## PRODUCT PARAMETER

<b>Modell</b>	<b>ZD-25TB01</b>
<b>Sicheres Ladegewicht</b>	Schublade:22 lbs/Desktop: 66lbs
<b>Produktgröße (T*B*H)</b>	1 2 00* 395 * 854 mm

\* Produktspezifikationen, Aussehen und Design können ohne vorherige Ankündigung geändert werden.

**Hersteller:** Caoxian Zhengda Arts&Crafts Co.,LTD

**Adresse:** Guyingji-Entwicklungszone, Kreis Cao, Provinz Shandong, China 274418

**Importiert nach AUS:** SIHAO PTY LTD. 1 ROKEVA STREETEASTWOOD NSW 2122 Australien

**Importiert in die USA:** Sanven Technology Ltd. Suite 250, 9166 Anaheim Place, Rancho Cucamonga, CA 91730

<b>EC</b>	<b>REP</b>
-----------	------------

E-CrossStu GmbH  
Mainzer Landstr.69, 60329 Frankfurt am Main.

<b>UK</b>	<b>REP</b>
-----------	------------

YH CONSULTING LIMITED.  
C/O YH Consulting Limited Office 147, Centurion House, London Road, Staines-upon-Thames, Surrey, TW18 4AX





# VEVOR

**Affordable. Reliable. Home Improvement.**

**Komoda rattanowa**

**Model: ZD-25TB01**



# VEVOR

Affordable. Reliable. Home Improvement.

## RATTAN DRESSER

**MODEL: ZD-25TB01**

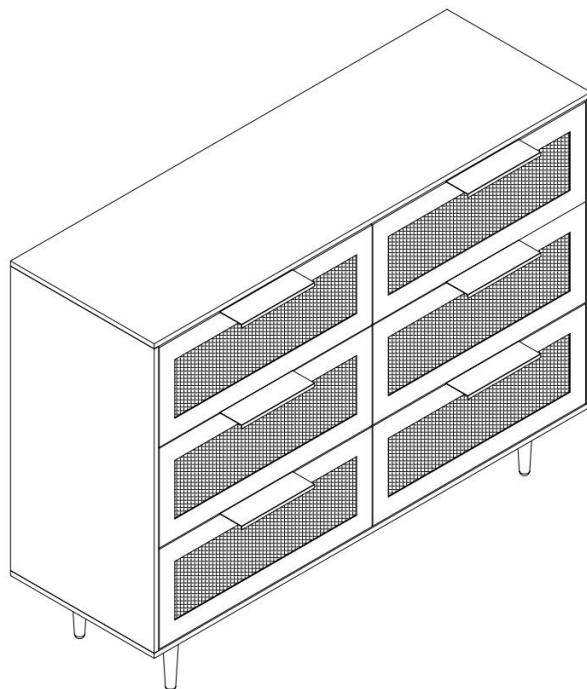

To jest oryginalna instrukcja obsługi. Przed użyciem prosimy o dokładne zapoznanie się z treścią instrukcji. Firma VEVOR zastrzega sobie prawo do jednoznacznej interpretacji niniejszej instrukcji obsługi. Wygląd produktu zależy od stanu, w jakim go otrzymali Państwo. Prosimy o wyrozumiałość, ale nie będziemy Państwa ponownie informować o aktualizacjach technologicznych lub oprogramowania naszego produktu.

## SAFETY INSTRUCTIONS

### WSTĘP

Dziękujemy za zakup naszych produktów. Naszym życiowym celem zawsze było zapewnienie klientom produktów i usług najwyższej jakości. Przed użyciem produktu prosimy o zapoznanie się z treścią instrukcja obsługi ostrożnie, aby zapewnić prawidłowe użytkowanie. Przechowuj instrukcję obsługi w miejscu gdzie użytkownik może je znaleźć w dowolnym momencie.

### MONTAŻ ŚRODKI OSTROŻNOŚCI

Jest ich wiele elementy i akcesoria w opakowaniu. Każdy element i akcesorium są oznaczone literą lub cyfrą, sprawdź Przed użyciem któregokolwiek z nich należy zachować ostrożność. Trzymaj je z dala od dzieci zapobiegać wypadkom.

1. Montaż należy wykonywać wyłącznie zgodnie z niniejszą instrukcją. Nieprawidłowy montaż może stwarzać zagrożenie.
2. Podczas montażu należy nosić okulary ochronne zatwierdzone przez ANSI oraz wytrzymałe rękawice robocze.
3. Utrzymuj miejsce zgromadzenia w czystości i zapewnij dobre oświetlenie.
4. Nie dopuszczać osób postronnych na teren montażu w trakcie jego trwania.
5. Nie przychodź na zgromadzenie, jeśli jesteś zmęczony lub pod wpływem alkoholu, narkotyków lub leków.
6. Możliwości produktu odnoszą się wyłącznie do produktów prawidłowo i całkowicie zmontowanych.
7. Proszę zainstalować produkt na czystym i miękkim podkładzie (np. dywanie) lub tektury), aby uniknąć zarysowania lub uszkodzenia powierzchni produkt .
8. Jeżeli to możliwe, możesz użyć elektronarzędzi, aby ułatwić sobie montaż.
9. Główne elementy produktu są stosunkowo ciężkie. Proszę o zapłatę

należy zachować szczególną ostrożność podczas instalacji .

10. Produkt nie jest stabilny podczas montażu. Nie należy go przenosić losowo. przed całkowitym zainstalowaniem .
11. Aby uzyskać dodatkowe informacje dotyczące części wymienionych poniżej.

Proszę zapoznać się ze schematem montażu w niniejszej instrukcji.

Rozpakuj i oddziel wszystkie części w czystym miejscu pracy.

**\*PAMIĘTAJ O POSTĘPOWANIU ZGODNIE Z INSTRUKCJĄ  
INSTRUKCJI INSTALACJI, UNIKNIJ NIEPOTRZEBNYCH STRAT  
SPOWODOWANYCH NIEWŁAŚCIWĄ INSTALACJĄ.**

**UŻYWAĆ ŚRODKI OSTROŻNOŚCI**

- 1) Nie przekraczać określonej wartości nośności.
- 2) Używaj wyłącznie na płaskiej, równej, twardej i gładkiej powierzchni, która może bezpiecznie utrzymać w pełni załadowaną komodę rattanową.
- 3) Stosować wyłącznie zgodnie z przeznaczeniem.
- 4) Przed każdym użyciem należy przeprowadzić kontrolę. Nie używać produktu, jeśli części są luźne lub uszkodzone.

## **OSTRZEŻENIE**

**Dzieci umierały z powodu mebli przewrócenia. Aby zmniejszyć ryzyko przewrócenia mebli przewrócenie:**







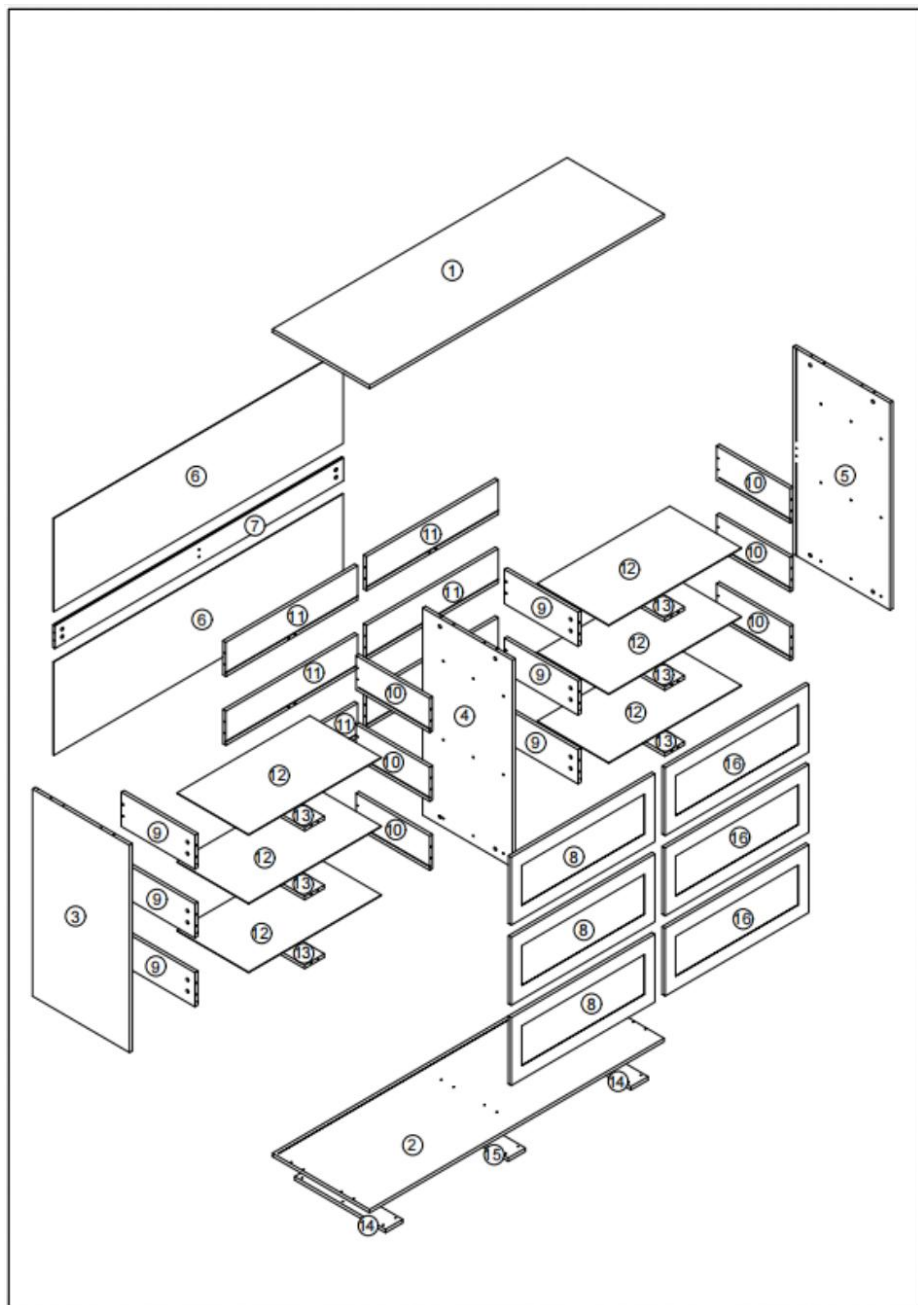



- **ZAWSZE** należy instalować dostarczone urządzenie zabezpieczające przed wywróceniem.
- **NIGDY** nie umieszczaj telewizora na tym produkcie.
- **NIGDY** nie pozwalaj dzieciom stać, wspinać się lub wisieć na szufladach, drzwiach lub półkach.
- **NIGDY** nie otwieraj więcej niż jednej szuflady na raz .
- **Najcięższe przedmioty** umieszczaj w najniższych szufladach .

**ZAPISZ TĘ INSTRUKCJĘ**

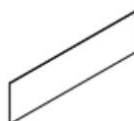

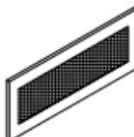
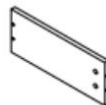

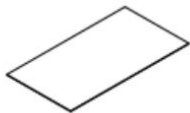
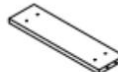
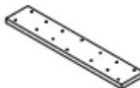







## **EXPLODED VIEW**

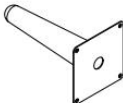

## PARTS LIST

<p>①</p>  <p style="text-align: right;">x1</p>	<p>②</p>  <p style="text-align: right;">x1</p>	<p>③</p>  <p style="text-align: right;">x1</p>	<p>④</p>  <p style="text-align: right;">x1</p>
<p>⑤</p>  <p style="text-align: right;">x1</p>	<p>⑥</p>  <p style="text-align: right;">x2</p>	<p>⑦</p>  <p style="text-align: right;">x1</p>	<p>⑧</p>  <p style="text-align: right;">x3</p>
<p>⑨</p>  <p style="text-align: right;">x6</p>	<p>⑩</p>  <p style="text-align: right;">x6</p>	<p>⑪</p>  <p style="text-align: right;">x6</p>	<p>⑫</p>  <p style="text-align: right;">x6</p>
<p>⑬</p>  <p style="text-align: right;">x6</p>	<p>⑭</p>  <p style="text-align: right;">x2</p>	<p>⑮</p>  <p style="text-align: right;">x1</p>	<p>⑯</p>  <p style="text-align: right;">x3</p>

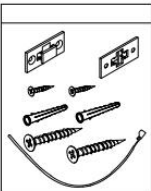
## PARTS LIST

<p style="text-align: center;">A</p>  <p style="text-align: center;">x66+2</p>	<p style="text-align: center;">B</p>  <p style="text-align: center;">x66+2</p>	<p style="text-align: center;">C</p>  <p style="text-align: center;">x12</p>	<p style="text-align: center;">D</p>  <p style="text-align: center;">x104+2</p>
<p style="text-align: center;">E</p>  <p style="text-align: center;">x18</p>	<p style="text-align: center;">F</p>  <p style="text-align: center;">x24</p>	<p style="text-align: center;">G</p>  <p style="text-align: center;">x6</p>	<p style="text-align: center;">H</p>  <p style="text-align: center;">x12</p>
<p style="text-align: center;">I</p>  <p style="text-align: center;">x5</p>	<p style="text-align: center;">J</p>  <p style="text-align: center;">x16</p>	<p style="text-align: center;">K</p>  <p style="text-align: center;">x16</p>	<p style="text-align: center;">L</p>  <p style="text-align: center;">x1</p>
 <p style="text-align: center;">x1</p>			

## ASSEMBLY STEP

### Installation of Cams and Pins

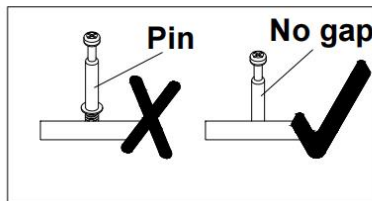
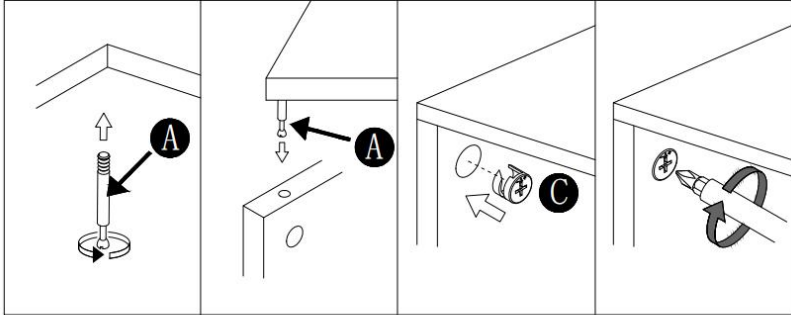

## ASSEMBLY STEP

### Step 1

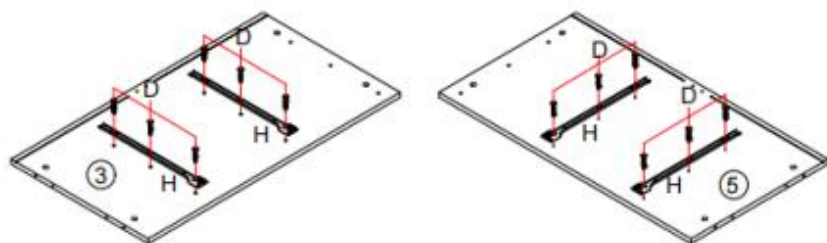

### Step 2

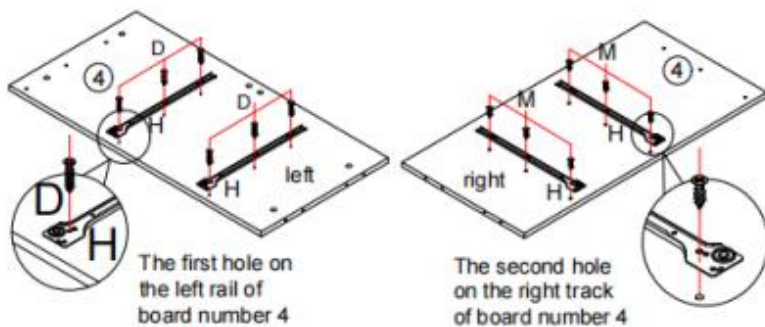

## ASSEMBLY STEP

### Step 3

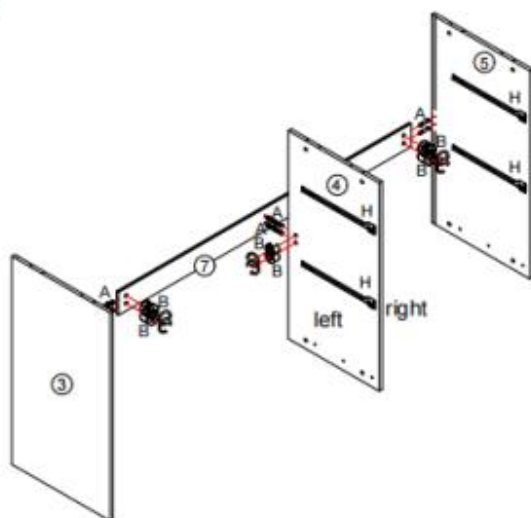

### Step 4

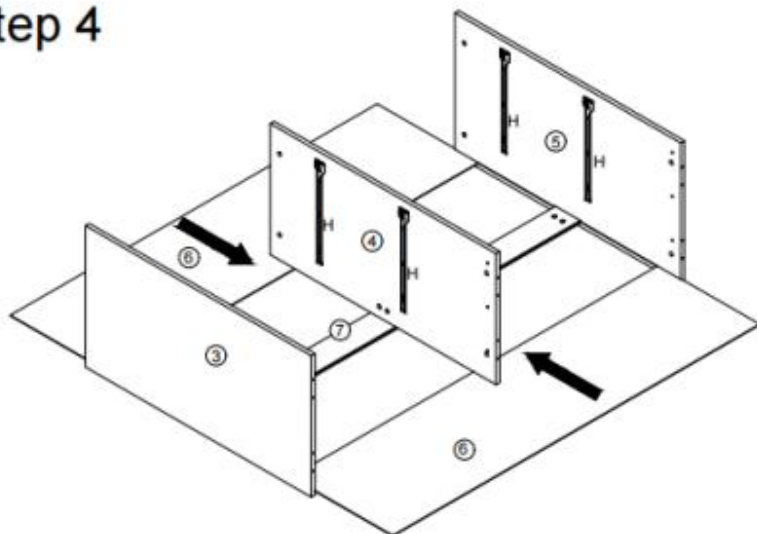

## ASSEMBLY STEP

### Step 5

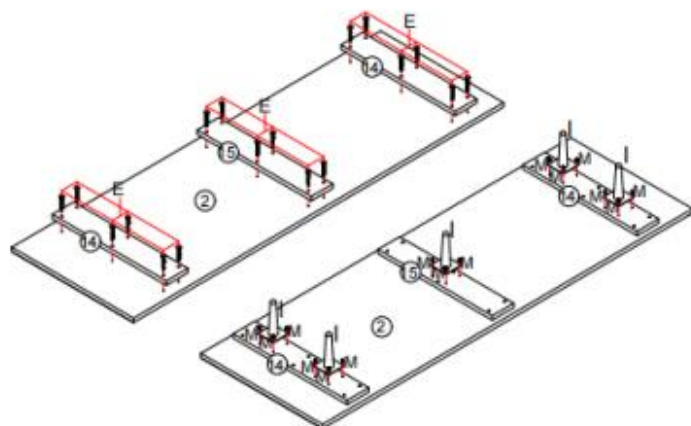

### Step 6

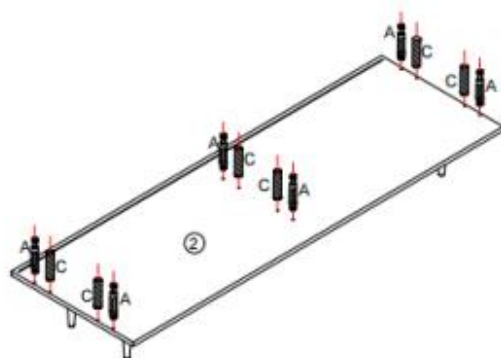

## ASSEMBLY STEP

### Step 7

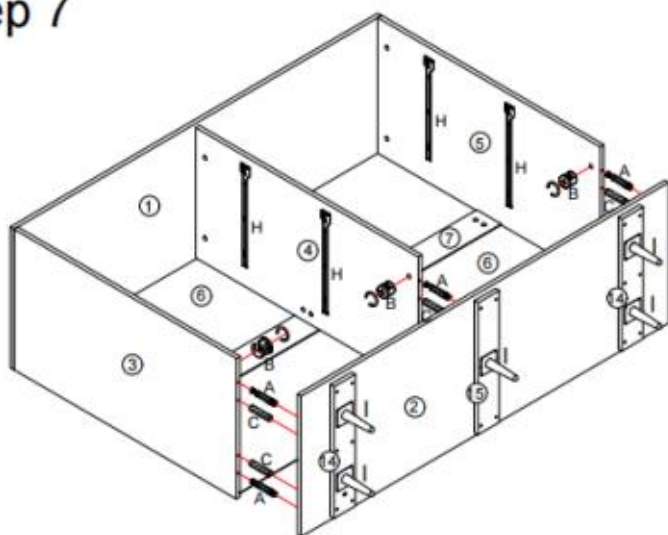

### Step 8

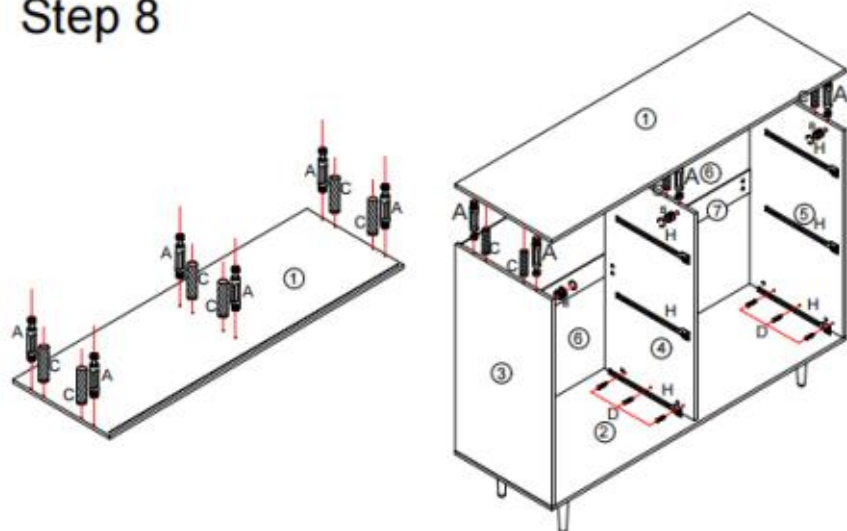

## ASSEMBLY STEP

### Step 9

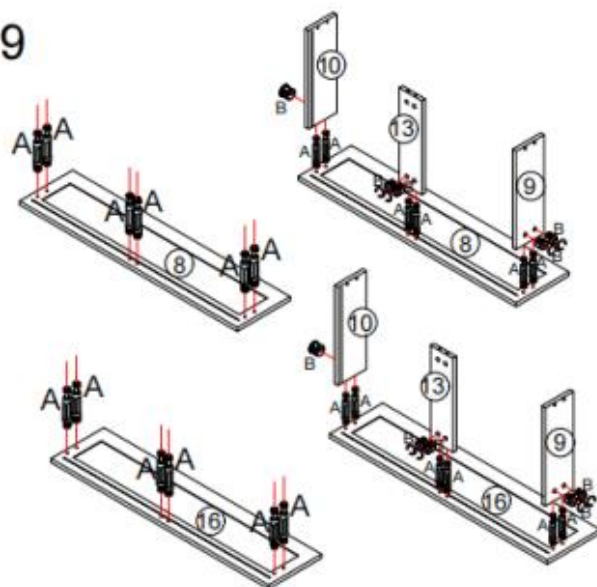

### Step 10

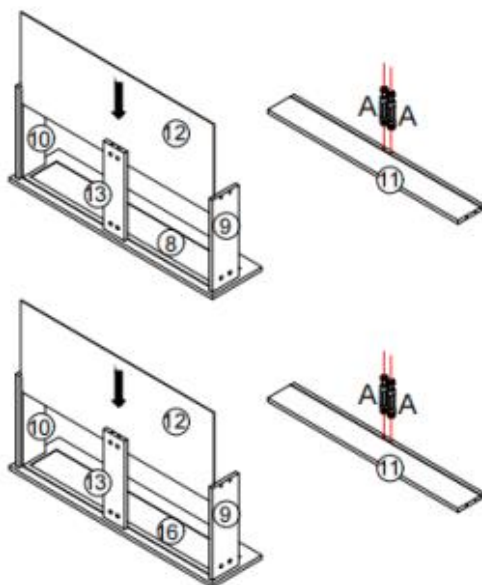

## ASSEMBLY STEP

### Step 11

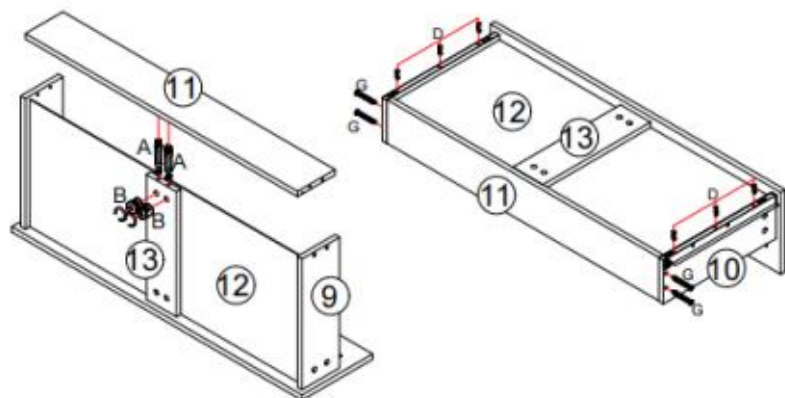

### Step 12

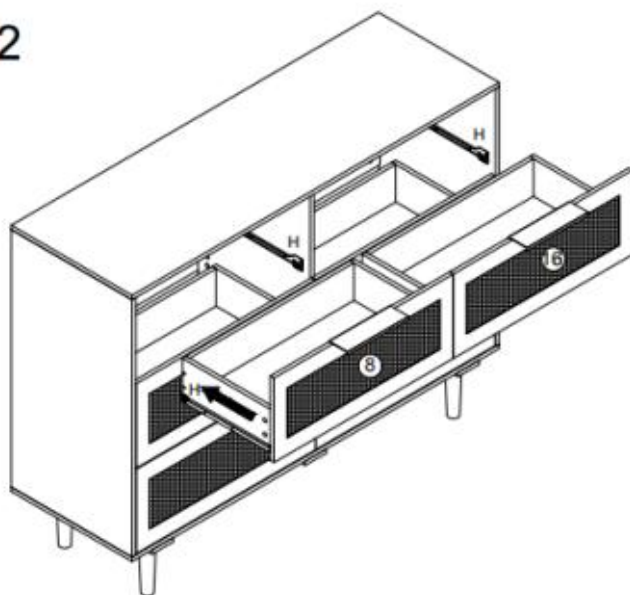

## ASSEMBLY STEP

Step 13

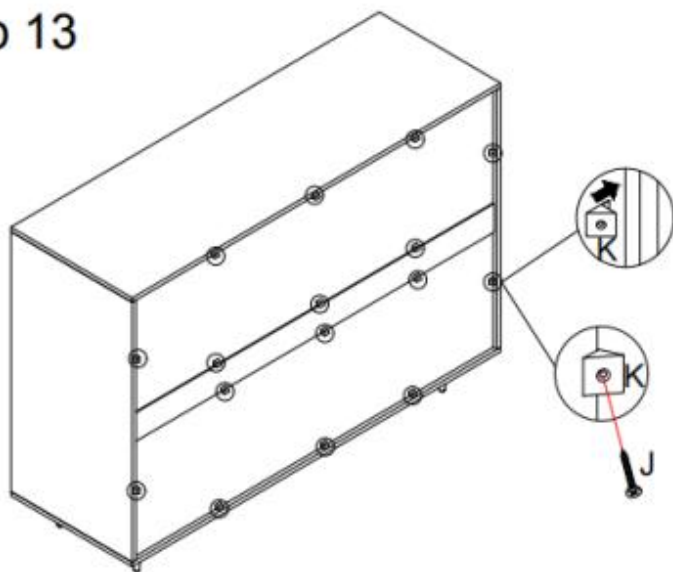

Step 14

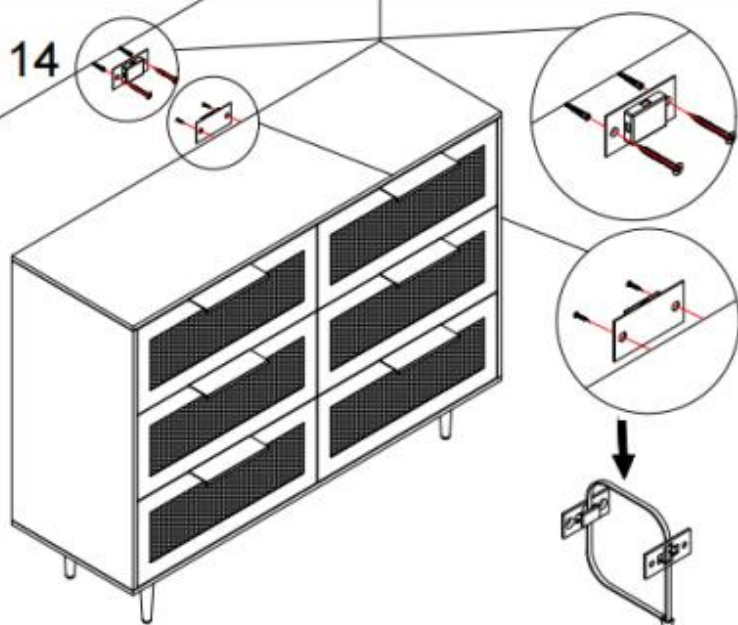

## PRODUCT PARAMETER

<b>Model</b>	<b>ZD-25TB01</b>
<b>Bezpieczna waga załadunku</b>	Szuflada: 22 funty/komputer stacjonarny: 66 funtów
<b>Wymiary produktu (gł.*szer.*wys.)</b>	1 2 00* 395 * 854 mm

\* Produkty mogą podlegać zmianom dotyczącym specyfikacji, wyglądu i konstrukcji bez wcześniejszego powiadomienia.

**Producent:** Caoxian Zhengda Arts&Crafts Co.,LTD

**Adres:** Strefa Rozwoju Guyingji, powiat Cao, prowincja Shandong, Chiny  
274418

**Importowane do Australii:** SIHAO PTY LTD. 1 ROKEVA  
STREETEASTWOOD NSW 2122 Australia

**Importowane do USA:** Sanven Technology Ltd. Suite 250, 9166 Anaheim  
Place, Rancho Cucamonga, CA 91730

<b>EC</b>	<b>REP</b>
-----------	------------

E-CrossStu GmbH  
Mainzer Landstr.69, 60329 Frankfurt am Main.

<b>UK</b>	<b>REP</b>
-----------	------------

YH CONSULTING LIMITED.  
C/O YH Consulting Limited Office 147, Centurion  
House, London Road, Staines-upon-Thames, Surrey,  
TW18 4AX





# **VEVOR**

**Affordable. Reliable. Home Improvement.**

**Cassettiera in rattan**

**Modello: ZD-25TB01**



# VEVOR

Affordable. Reliable. Home Improvement.

## RATTAN DRESSER

**MODELLO: ZD-25TB01**

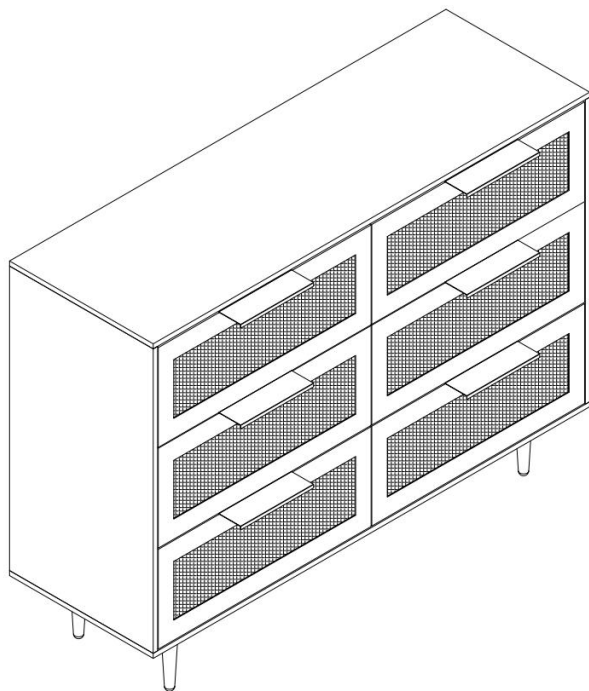

Queste sono le istruzioni originali, si prega di leggere attentamente tutte le istruzioni del manuale prima dell'uso. VEVOR si riserva la piena interpretazione del proprio manuale utente. L'aspetto del prodotto dipenderà dal prodotto ricevuto. Vi preghiamo di scusarci se non vi informeremo più in caso di aggiornamenti tecnologici o software sul nostro prodotto.

## SAFETY INSTRUCTIONS

### INTRODUZIONE

**Grazie per aver acquistato i nostri prodotti. Il nostro obiettivo principale è sempre stato quello di fornire ai clienti prodotti e servizi della migliore qualità. Prima di utilizzare il prodotto, leggere attentamente questo documento.**

**manuale di istruzioni attentamente per garantirne il corretto utilizzo. Conservare il manuale di istruzioni in un luogo dove l'utente può trovarlo in qualsiasi momento.**

### ASSEMBLEA PRECAUZIONI

**Ce ne sono molti componenti e accessori nella confezione. Ogni il componente e l'accessorio sono etichettati con una lettera o un numero, controllare attentamente prima di utilizzarli. Tenerli lontano dalla portata dei bambini prevenire gli incidenti.**

1. Montare solo secondo queste istruzioni. Un montaggio improprio può comportare pericoli.
2. Durante il montaggio, indossare occhiali di sicurezza omologati ANSI e guanti da lavoro resistenti.
3. Mantenere l'area di assemblaggio pulita e ben illuminata.
4. Durante l'assemblea, tenere gli astanti lontani dall'area.
5. Non montare se si è stanchi o sotto l'effetto di alcol, droghe o medicinali.
6. Le capacità del prodotto si applicano solo ai prodotti correttamente e completamente assemblati.
7. Si prega di installare il prodotto su un sottofondo pulito e morbido (ad esempio un tappeto) o cartone) per evitare di graffiare o danneggiare la superficie del prodotto .
8. Se possibile, è possibile utilizzare utensili elettrici per facilitare il montaggio.
9. I componenti principali del prodotto sono relativamente pesanti. Si prega di pagare attenzione alla sicurezza durante l'installazione .

10. Il prodotto non è stabile durante l'installazione. Non spostarlo in modo casuale. prima che sia completamente installato .
11. Per ulteriori informazioni sulle parti elencate di seguito. pagine, fare riferimento allo schema di montaggio di questo manuale. Disimballare e separare tutti i componenti in un'area di lavoro pulita.

**\*ASSICURATI DI SEGUIRE I PASSAGGI DI INSTALLAZIONE NEL MANUALE PER EVITARE PERDITE INUTILI CAUSATE DA UN'INSTALLAZIONE NON CORRETTA.**

#### **UTILIZZO    PRECAUZIONI**

- 1) Non superare i valori specificati capacità di peso.
- 2) Utilizzare solo su una superficie piana, livellata, dura e liscia, in grado di sostenere in sicurezza una cassettera in rattan completamente carica.
- 3) Utilizzare solo come previsto.
- 4) Ispezionare prima di ogni utilizzo; non utilizzare se alcune parti sono allentate o danneggiate.

#### **AVVERTIMENTO**

**I bambini sono morti a causa dei mobili ribaltamento. Per ridurre il rischio di ribaltamento dei mobili ribaltamento:**







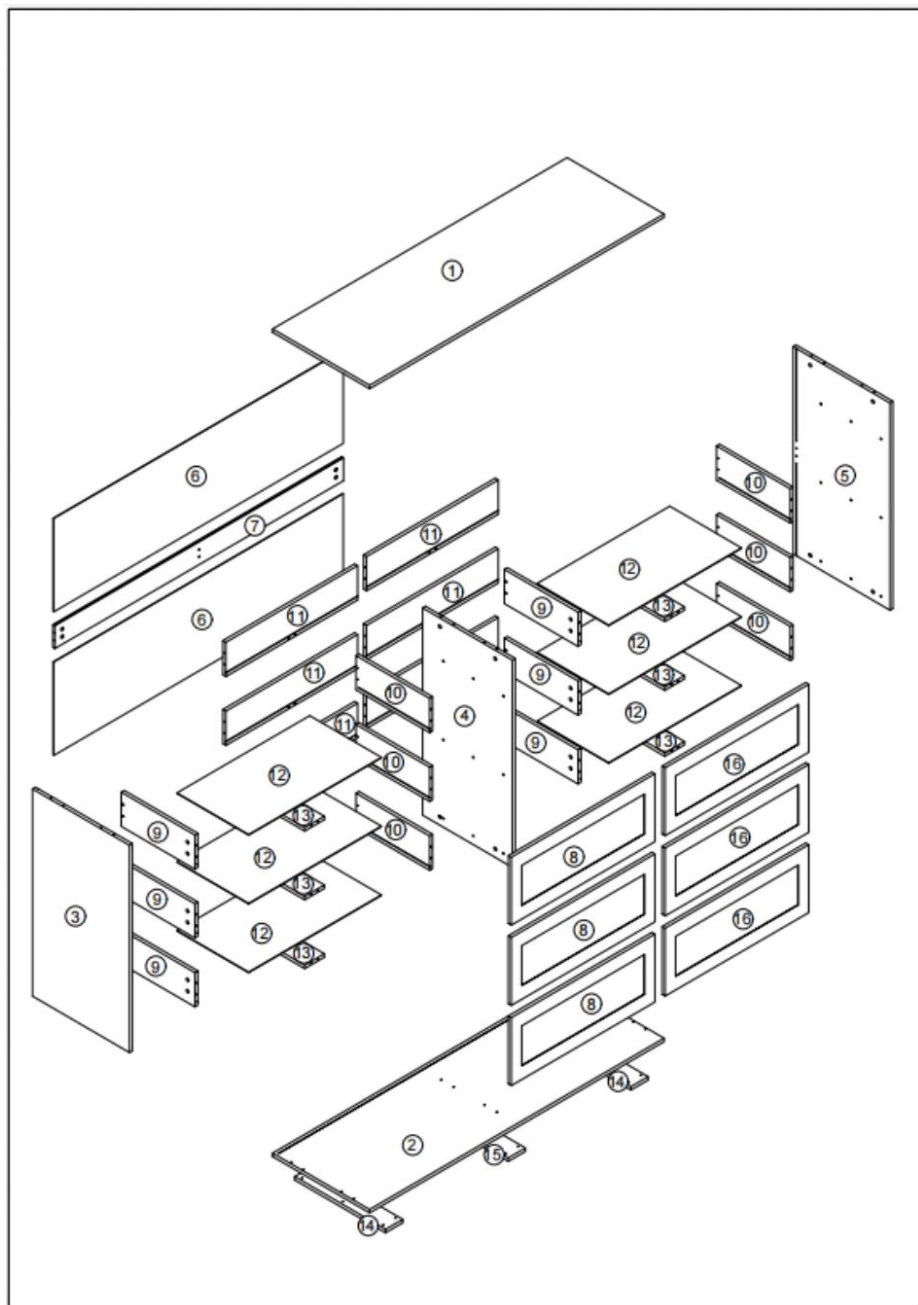



- **Installare SEMPRE il dispositivo antiribaltamento fornito.**
- **NON posizionare MAI un televisore su questo prodotto.**
- **NON permettere MAI ai bambini di stare in piedi, arrampicarsi o appendersi su cassetti, porte o scaffali.**
- **NON aprire MAI più di un cassetto alla volta .**
- **Posizionare gli oggetti più pesanti nei cassetti più bassi .**

**CONSERVARE QUESTO MANUALE**

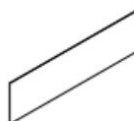

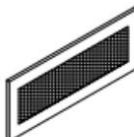
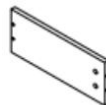

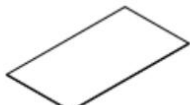
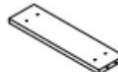
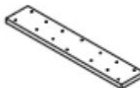







## EXPLODED VIEW

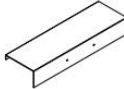

## PARTS LIST

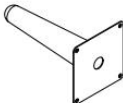
<p>①</p>  <p style="text-align: right;">x1</p>	<p>②</p>  <p style="text-align: right;">x1</p>	<p>③</p>  <p style="text-align: right;">x1</p>	<p>④</p>  <p style="text-align: right;">x1</p>
<p>⑤</p>  <p style="text-align: right;">x1</p>	<p>⑥</p>  <p style="text-align: right;">x2</p>	<p>⑦</p>  <p style="text-align: right;">x1</p>	<p>⑧</p>  <p style="text-align: right;">x3</p>
<p>⑨</p>  <p style="text-align: right;">x6</p>	<p>⑩</p>  <p style="text-align: right;">x6</p>	<p>⑪</p>  <p style="text-align: right;">x6</p>	<p>⑫</p>  <p style="text-align: right;">x6</p>
<p>⑬</p>  <p style="text-align: right;">x6</p>	<p>⑭</p>  <p style="text-align: right;">x2</p>	<p>⑮</p>  <p style="text-align: right;">x1</p>	<p>⑯</p>  <p style="text-align: right;">x3</p>

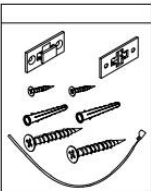
## PARTS LIST

<p style="text-align: center;">A</p>  <p style="text-align: center;">x66+2</p>	<p style="text-align: center;">B</p>  <p style="text-align: center;">x66+2</p>	<p style="text-align: center;">C</p>  <p style="text-align: center;">x12</p>	<p style="text-align: center;">D</p>  <p style="text-align: center;">x104+2</p>
<p style="text-align: center;">E</p>  <p style="text-align: center;">x18</p>	<p style="text-align: center;">F</p>  <p style="text-align: center;">x24</p>	<p style="text-align: center;">G</p>  <p style="text-align: center;">x6</p>	<p style="text-align: center;">H</p>  <p style="text-align: center;">x12</p>
<p style="text-align: center;">I</p>  <p style="text-align: center;">x5</p>	<p style="text-align: center;">J</p>  <p style="text-align: center;">x16</p>	<p style="text-align: center;">K</p>  <p style="text-align: center;">x16</p>	<p style="text-align: center;">L</p>  <p style="text-align: center;">x1</p>
 <p style="text-align: center;">x1</p>			

## ASSEMBLY STEP

### Installation of Cams and Pins

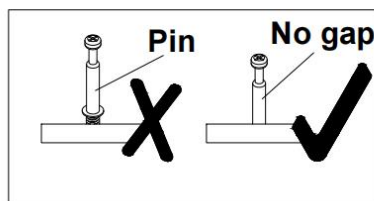
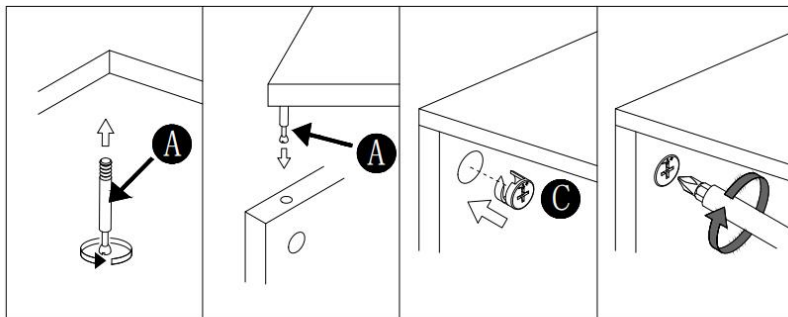

## ASSEMBLY STEP

### Step 1

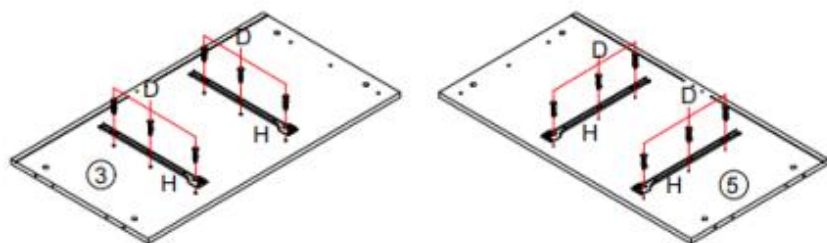

### Step 2

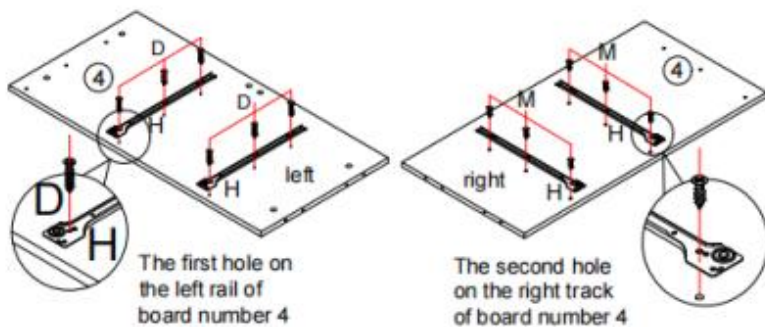

## ASSEMBLY STEP

### Step 3

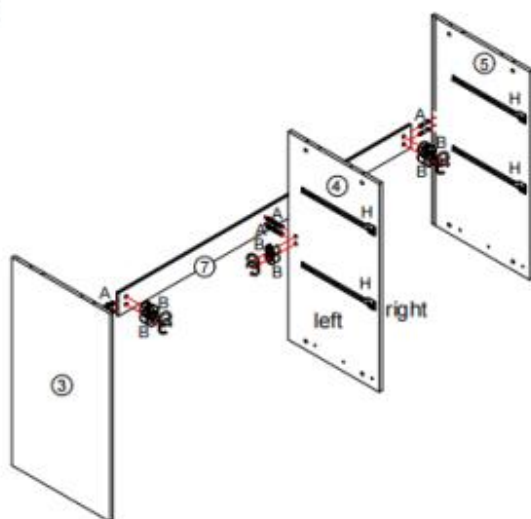

### Step 4

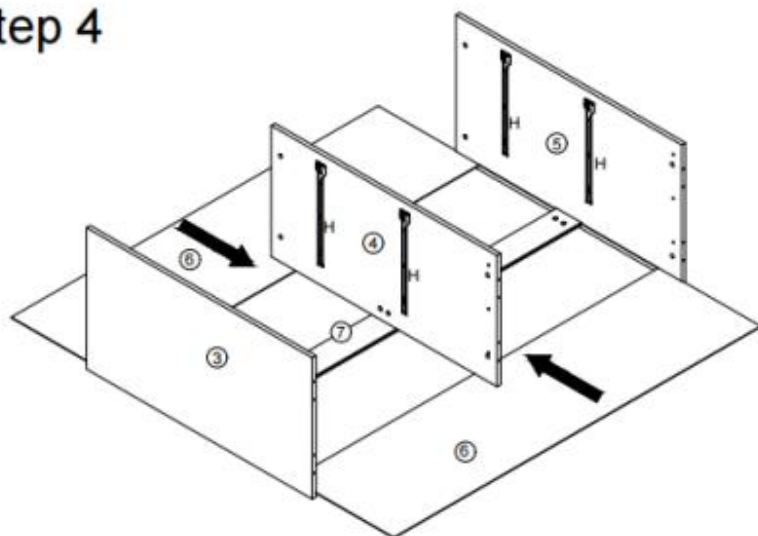

## ASSEMBLY STEP

### Step 5

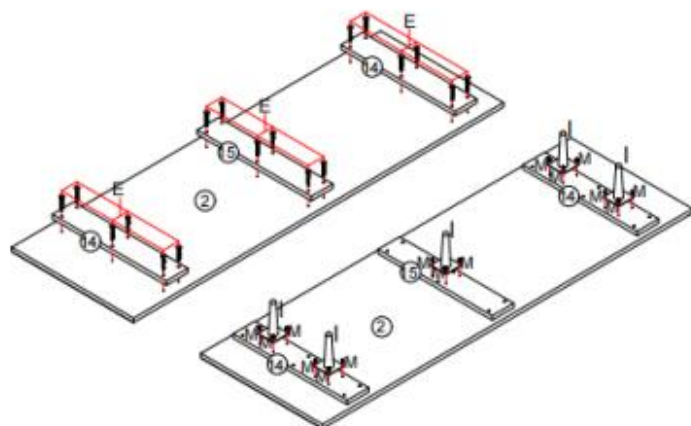

### Step 6

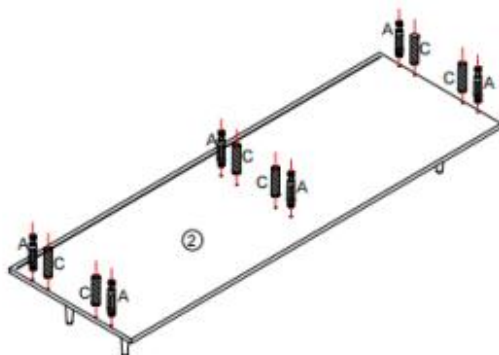

## ASSEMBLY STEP

### Step 7

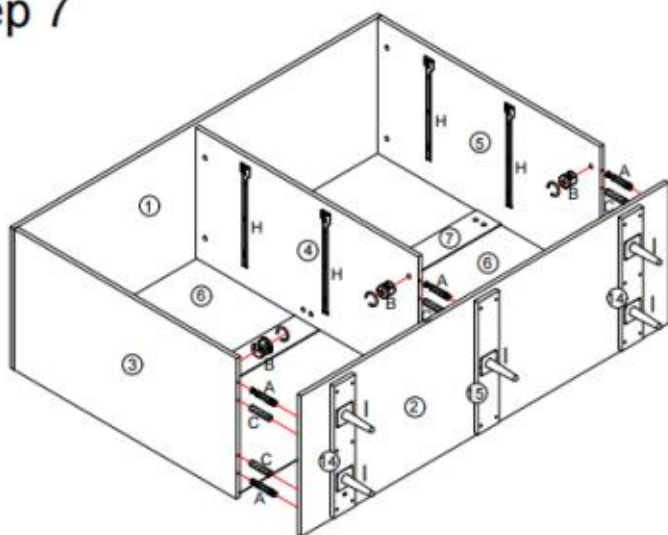

### Step 8

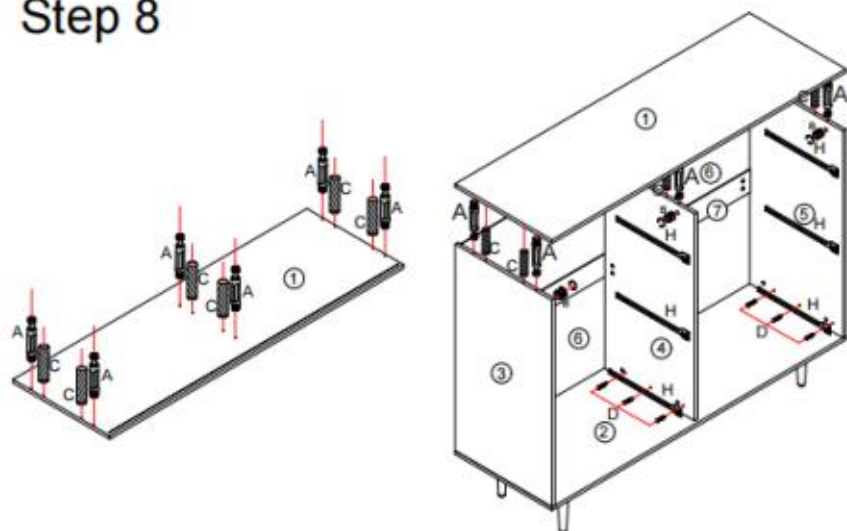

## ASSEMBLY STEP

### Step 9

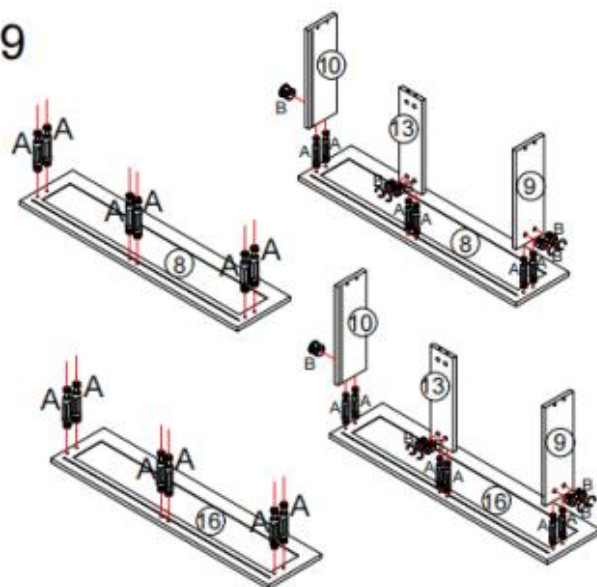

### Step 10

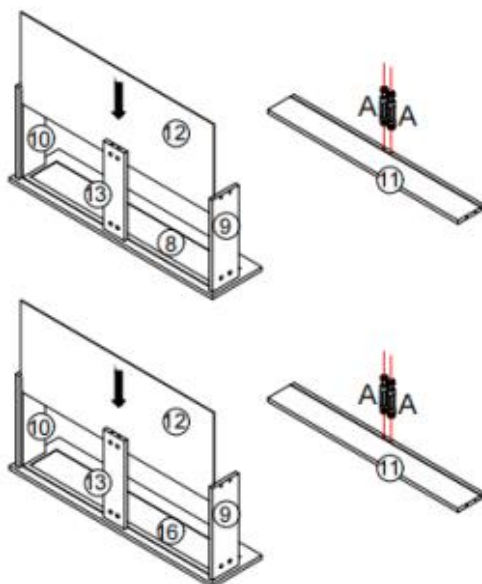

## ASSEMBLY STEP

### Step 11

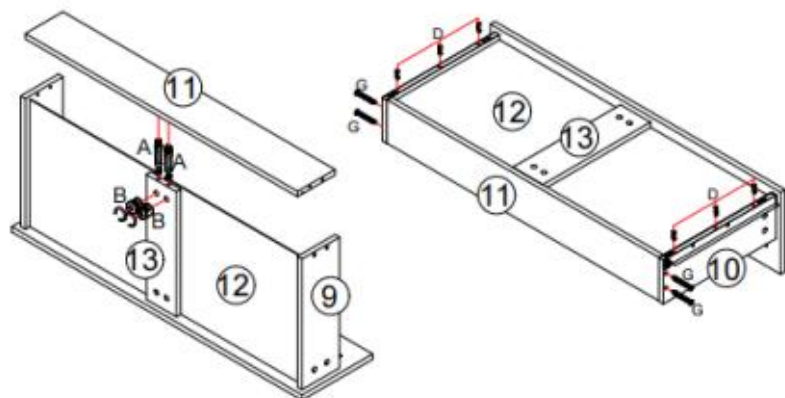

### Step 12

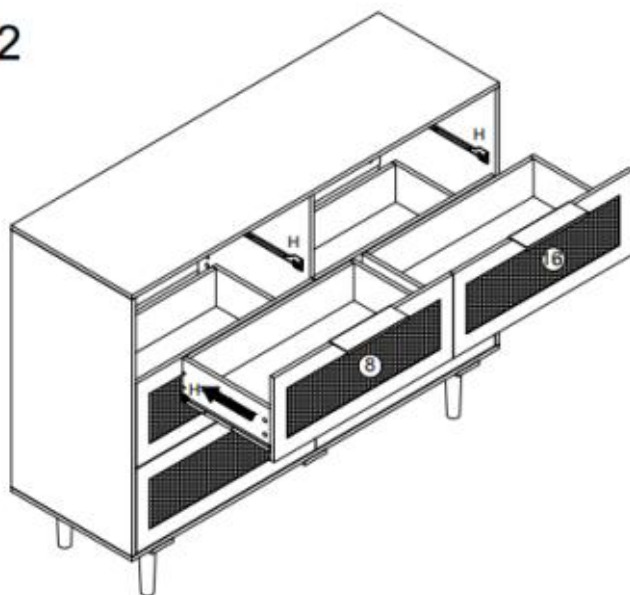

## ASSEMBLY STEP

Step 13

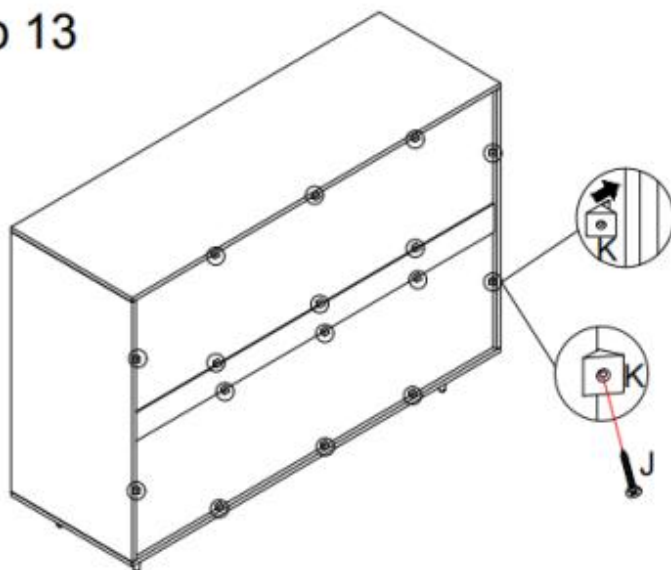

Step 14

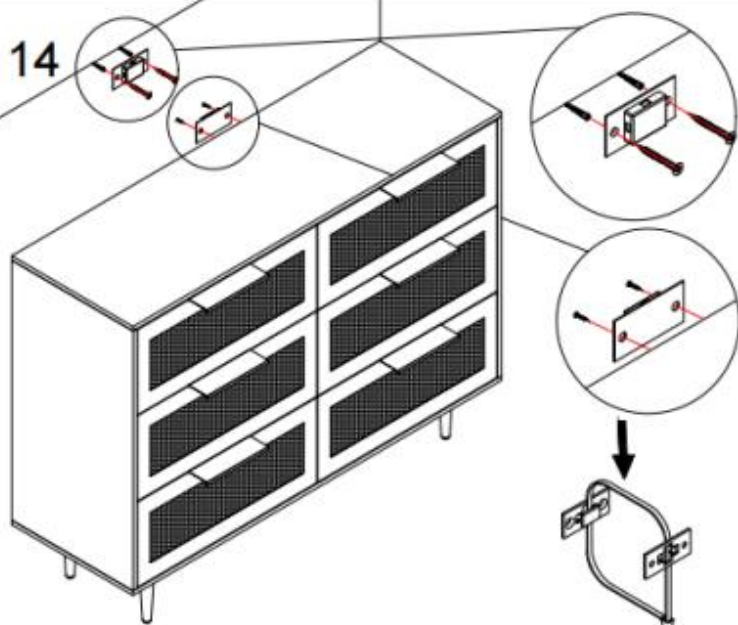

## PRODUCT PARAMETER

<b>Modello</b>	<b>ZD-25TB01</b>
<b>Peso di carico sicuro</b>	Cassetto:22 libbre/desktop: 66 libbre
<b>Dimensioni del prodotto (P*L*A)</b>	1 2 00* 395 * 854 millimetri

\* Le specifiche, l'aspetto e il design dei prodotti sono soggetti a modifiche senza preavviso.

**Produttore:** Caoxian Zhengda Arts&Crafts Co.,LTD

**Indirizzo:** Zona di sviluppo di Guyingji, Contea di Cao, Provincia di Shandong, Cina 274418

**Importato in AUS:** SIHAO PTY LTD. 1 ROKEVA STREETEASTWOOD NSW 2122 Australia

**Importato negli USA:** Sanven Technology Ltd. Suite 250, 9166 Anaheim Place, Rancho Cucamonga, CA 91730

<b>EC</b>	<b>REP</b>
-----------	------------

E-CrossStu GmbH  
Mainzer Landstr.69, 60329 Frankfurt am Main.

<b>UK</b>	<b>REP</b>
-----------	------------

YH CONSULTING LIMITED.  
C/O YH Consulting Limited Office 147, Centurion House, London Road, Staines-upon-Thames, Surrey, TW18 4AX





# **VEVOR**

**Affordable. Reliable. Home Improvement.**

**Cómoda de ratán**

**Modelo: ZD-25TB01**



# VEVOR

Affordable. Reliable. Home Improvement.

## RATTAN DRESSER

**MODELO: ZD-25TB01**

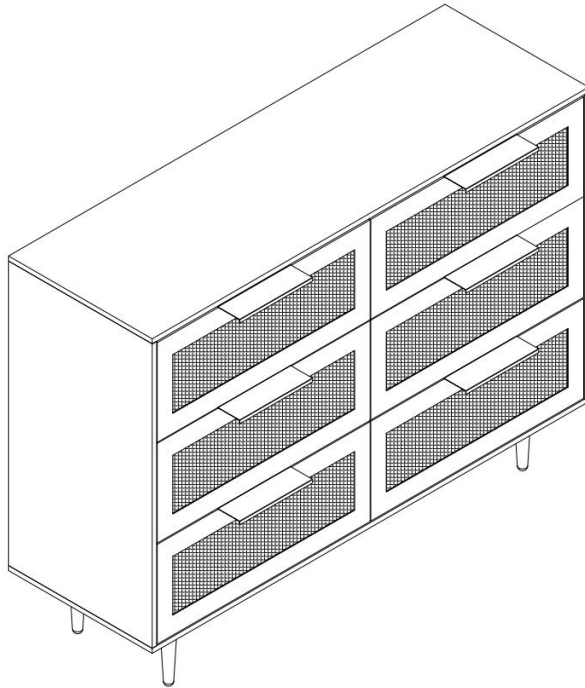

Estas son las instrucciones originales; lea atentamente todas las instrucciones del manual antes de utilizarlo. VEVOR se reserva el derecho de interpretar este manual de usuario. La apariencia del producto dependerá del producto que haya recibido. Le rogamos que nos disculpe si no le informamos de nuevo si hay actualizaciones tecnológicas o de software en nuestro producto.

## SAFETY INSTRUCTIONS

### INTRODUCCIÓN

**Gracias por adquirir nuestros productos. Nuestro compromiso con la mejor calidad y el mejor servicio siempre ha sido nuestro objetivo. Antes de usar el producto, lea esto. manual de instrucciones con cuidado para garantizar un uso correcto. Conserve el manual de instrucciones en un lugar donde el usuario puede encontrarlo en cualquier momento.**

### ASAMBLEA PRECAUCIONES

**Hay muchos Componentes y accesorios incluidos en el paquete. Cada uno El componente y el accesorio están etiquetados con una letra o un número, verifique cuidadosamente antes de utilizar cualquiera de ellos. Manténgalos fuera del alcance de los niños. Prevenir accidentes.**

1. Ensamble únicamente según estas instrucciones. Un montaje incorrecto puede causar peligros.
2. Use gafas de seguridad aprobadas por ANSI y guantes de trabajo resistentes durante el montaje.
3. Mantenga el área de reunión limpia y bien iluminada.
4. Mantenga a los transeúntes fuera del área durante el montaje.
5. No se reúna si está cansado o bajo la influencia del alcohol, drogas o medicamentos.
6. Las capacidades del producto se aplican únicamente a productos ensamblados de forma correcta y completa.
7. Instale el producto sobre una base limpia y suave (como una alfombra). o cartón) para evitar rayar o dañar la superficie del producto .
8. Si es posible, puedes utilizar herramientas eléctricas para facilitar el montaje.
9. Los componentes principales del producto son relativamente pesados. Por favor, preste atención. Atención a la seguridad durante la

instalación .

10. El producto no es estable durante la instalación. No lo mueva de forma aleatoria. antes de que esté completamente instalado .
11. Para obtener información adicional sobre las piezas enumeradas a continuación.

Para obtener más información sobre las páginas, consulte el diagrama de montaje de este manual. Desembale y separe todas las piezas en un área de trabajo limpia.

**\*ASEGÚRESE DE SEGUIR LOS PASOS DE INSTALACIÓN DEL MANUAL PARA EVITE PÉRDIDAS INNECESARIAS CAUSADAS POR UNA INSTALACIÓN INCORRECTA.**

### **USAR PRECAUCIONES**

- 1) No exceda lo especificado capacidades de peso.
- 2) Úselo únicamente sobre una superficie plana, nivelada, dura y lisa que pueda soportar de manera segura una cómoda de ratán completamente cargada.
- 3) Úselo únicamente según lo previsto.
- 4) Inspeccione antes de cada uso; no lo utilice si las piezas están sueltas o dañadas.

### **ADVERTENCIA**

**Los niños han muerto a causa de los muebles. vuelco. Para reducir el riesgo de vuelco de los muebles vuelco:**







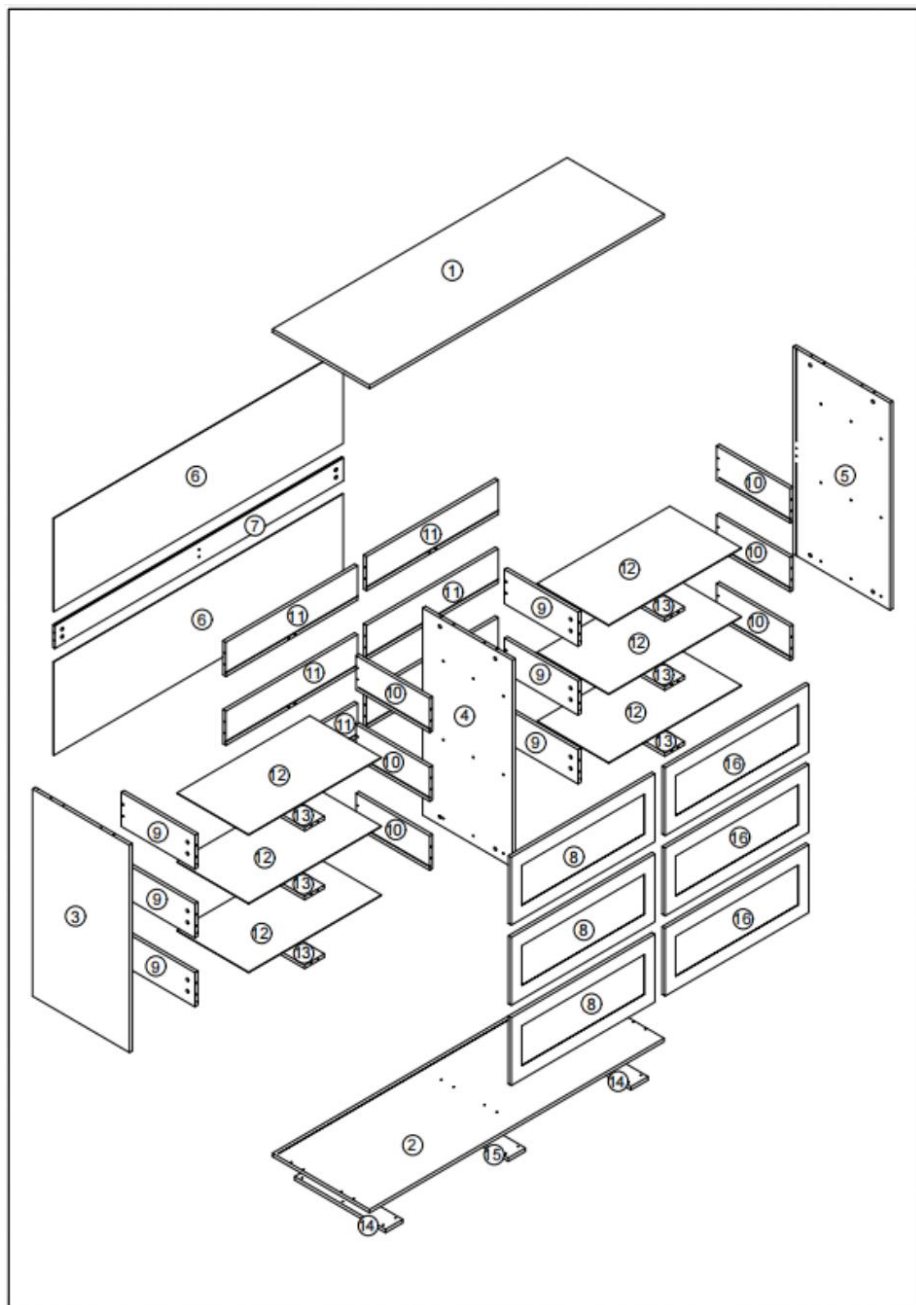



- **SIEMPRE** instale el dispositivo antivuelco provisto.
- **NUNCA** coloque un televisor sobre este producto.
- **NUNCA** permita que los niños se paren, trepen o se cuelguen en cajones, puertas o estantes.
- **NUNCA** abra más de un cajón a la vez .
- **Coloque** los artículos más pesados en los cajones más bajos .

**GUARDE ESTE MANUAL**

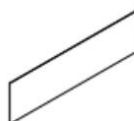

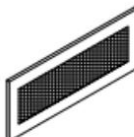
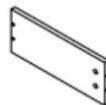

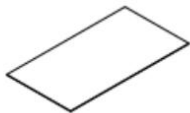
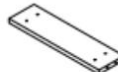
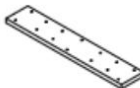







## **EXPLODED VIEW**

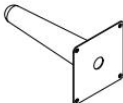

## PARTS LIST

<p>①</p>  <p style="text-align: right;">x1</p>	<p>②</p>  <p style="text-align: right;">x1</p>	<p>③</p>  <p style="text-align: right;">x1</p>	<p>④</p>  <p style="text-align: right;">x1</p>
<p>⑤</p>  <p style="text-align: right;">x1</p>	<p>⑥</p>  <p style="text-align: right;">x2</p>	<p>⑦</p>  <p style="text-align: right;">x1</p>	<p>⑧</p>  <p style="text-align: right;">x3</p>
<p>⑨</p>  <p style="text-align: right;">x6</p>	<p>⑩</p>  <p style="text-align: right;">x6</p>	<p>⑪</p>  <p style="text-align: right;">x6</p>	<p>⑫</p>  <p style="text-align: right;">x6</p>
<p>⑬</p>  <p style="text-align: right;">x6</p>	<p>⑭</p>  <p style="text-align: right;">x2</p>	<p>⑮</p>  <p style="text-align: right;">x1</p>	<p>⑯</p>  <p style="text-align: right;">x3</p>

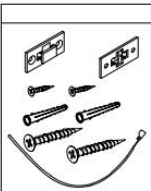
## PARTS LIST

<p style="text-align: center;">A</p>  <p style="text-align: center;">x66+2</p>	<p style="text-align: center;">B</p>  <p style="text-align: center;">x66+2</p>	<p style="text-align: center;">C</p>  <p style="text-align: center;">x12</p>	<p style="text-align: center;">D</p>  <p style="text-align: center;">x104+2</p>
<p style="text-align: center;">E</p>  <p style="text-align: center;">x18</p>	<p style="text-align: center;">F</p>  <p style="text-align: center;">x24</p>	<p style="text-align: center;">G</p>  <p style="text-align: center;">x6</p>	<p style="text-align: center;">H</p>  <p style="text-align: center;">x12</p>
<p style="text-align: center;">I</p>  <p style="text-align: center;">x5</p>	<p style="text-align: center;">J</p>  <p style="text-align: center;">x16</p>	<p style="text-align: center;">K</p>  <p style="text-align: center;">x16</p>	<p style="text-align: center;">L</p>  <p style="text-align: center;">x1</p>
 <p style="text-align: center;">x1</p>			

## ASSEMBLY STEP

### Installation of Cams and Pins

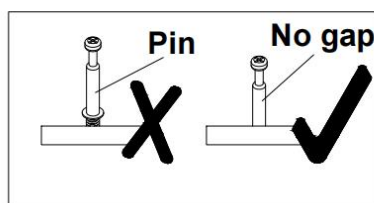
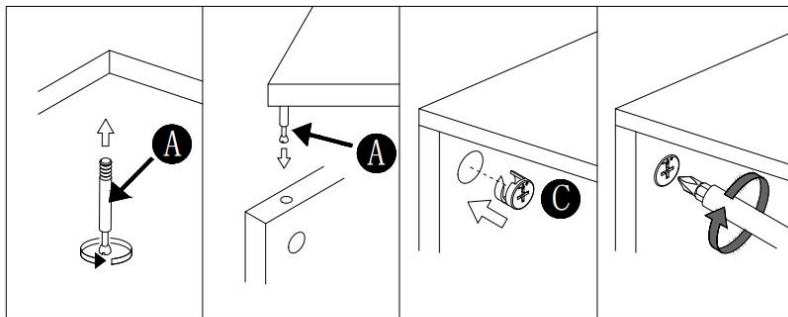

## ASSEMBLY STEP

### Step 1

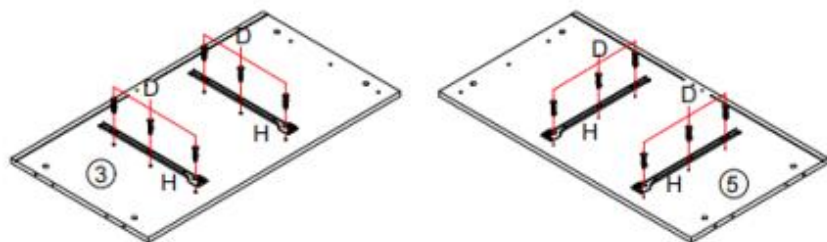

### Step 2

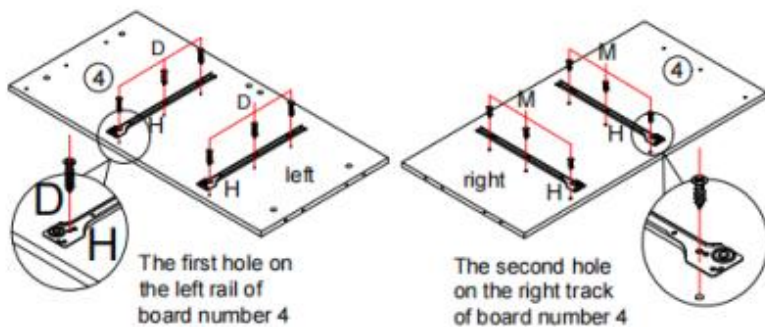

## ASSEMBLY STEP

### Step 3

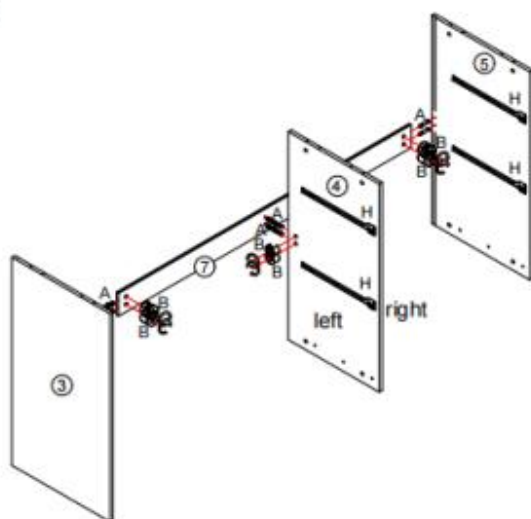

### Step 4

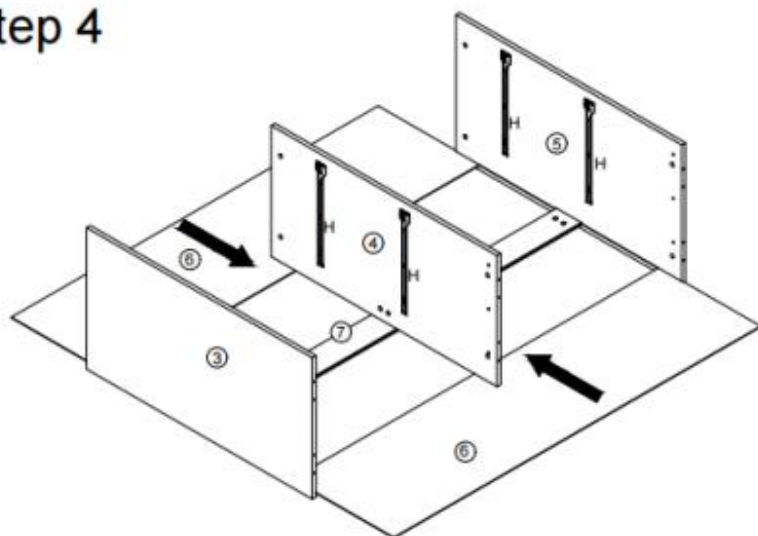

## ASSEMBLY STEP

### Step 5

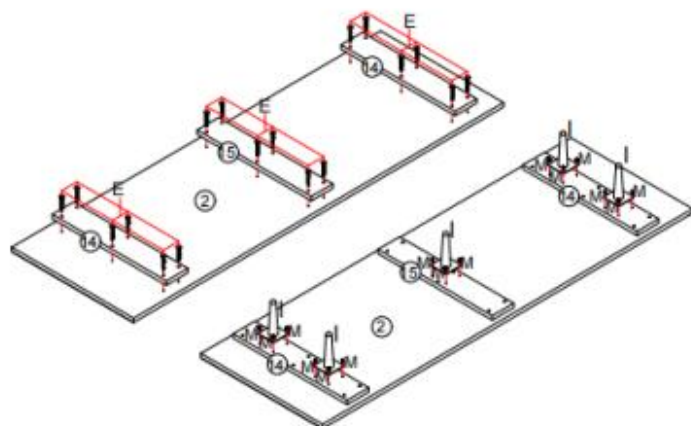

### Step 6

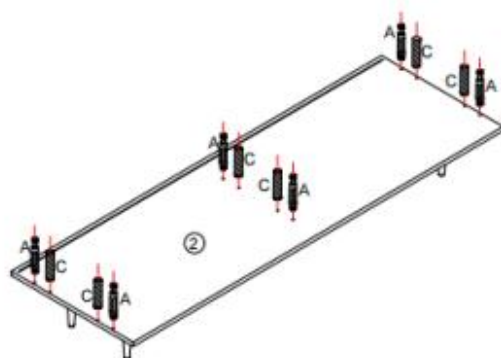

## ASSEMBLY STEP

### Step 7

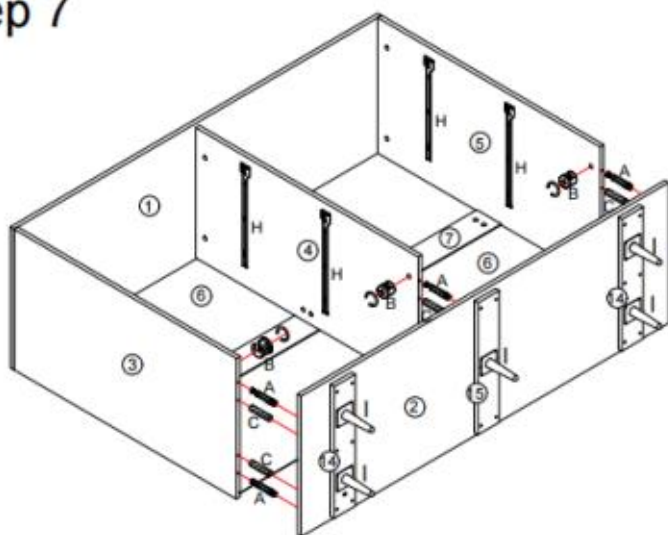

### Step 8

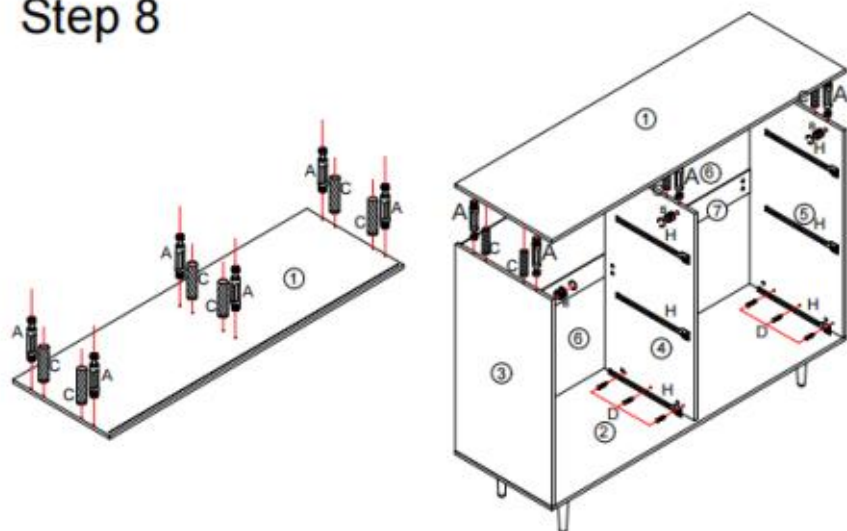

## ASSEMBLY STEP

### Step 9

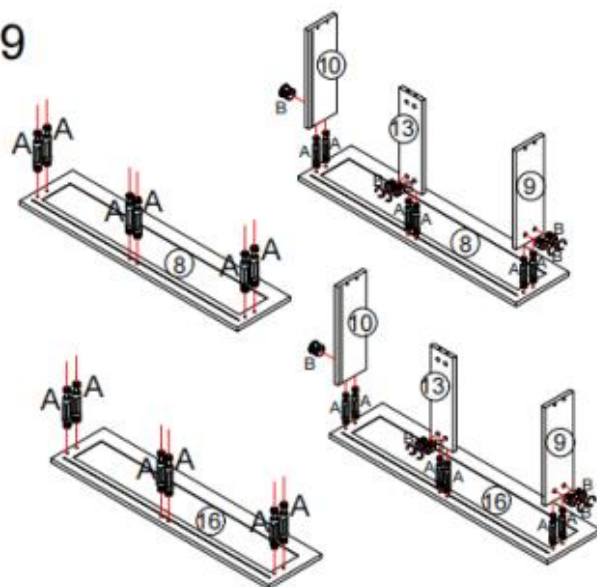

### Step 10

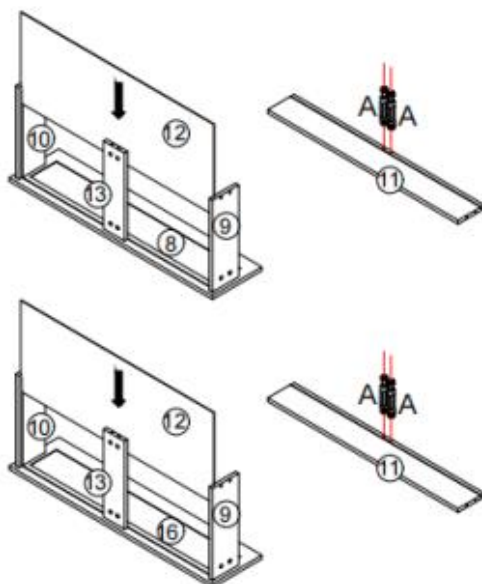

## ASSEMBLY STEP

### Step 11

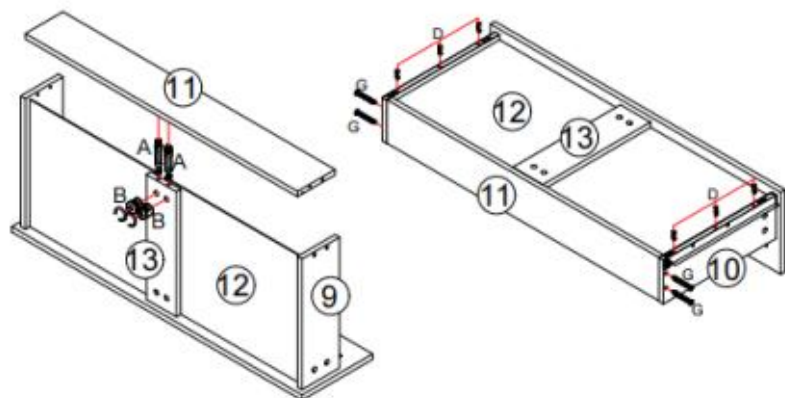

### Step 12

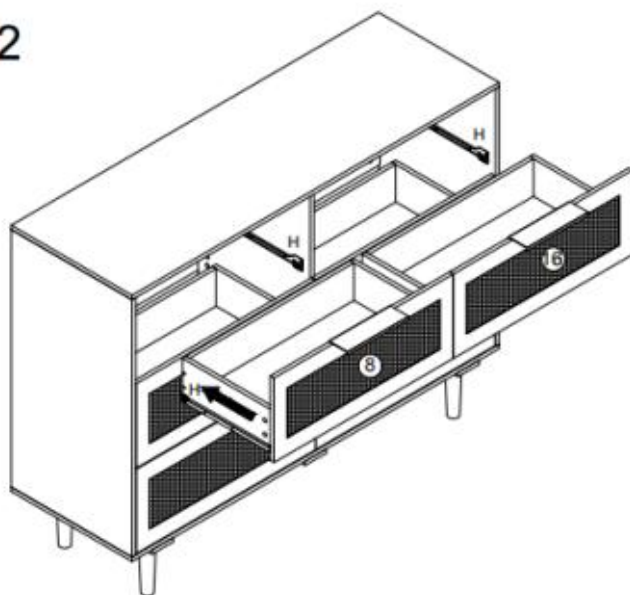

## ASSEMBLY STEP

Step 13

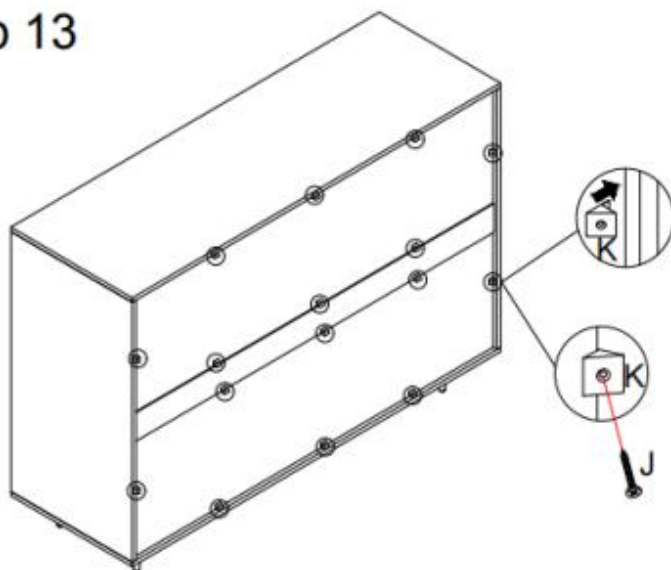

Step 14

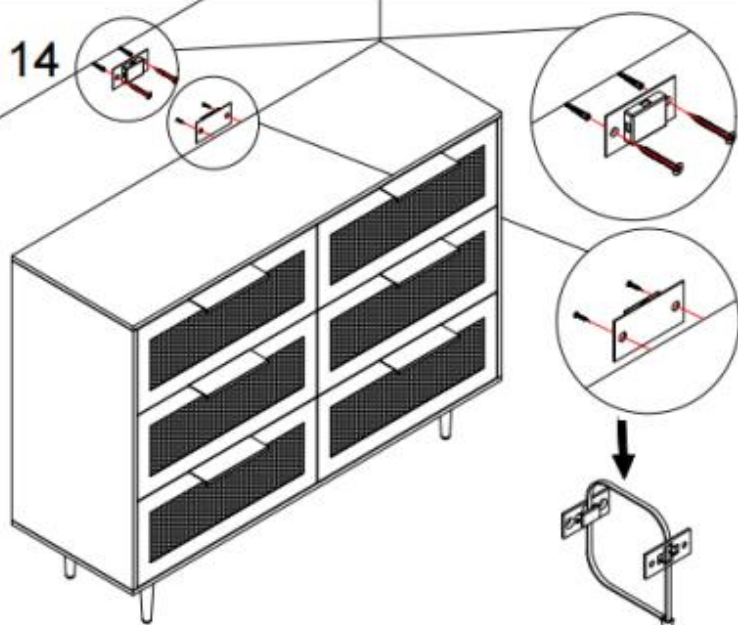

## PRODUCT PARAMETER

<b>Modelo</b>	<b>ZD-25TB01</b>
<b>Peso de carga seguro</b>	Cajón:22 libras/escritorio: 66 libras
<b>Tamaño del producto (D*An*Al)</b>	1200 * 395 * 854 milímetros

\* Los productos como las especificaciones, la apariencia y el diseño están sujetos a modificaciones sin previo aviso.

**Fabricante:** Caoxian Zhengda Arts&Crafts Co.,LTD

**Dirección:** Zona de desarrollo de Guyingji, condado de Cao, provincia de Shandong, China 274418

**Importado a AUS:** SIHAO PTY LTD. 1 ROKEVA STREET, EASTWOOD, NSW 2122, Australia

**Importado a EE. UU.:** Sanven Technology Ltd. Suite 250, 9166 Anaheim Place, Rancho Cucamonga, CA 91730

<b>EC</b>	<b>REP</b>
-----------	------------

E-CrossStu GmbH  
Mainzer Landstr.69, 60329 Frankfurt am Main.

<b>UK</b>	<b>REP</b>
-----------	------------

YH CONSULTING LIMITED.  
C/O YH Consulting Limited Office 147, Centurion House, London Road, Staines-upon-Thames, Surrey, TW18 4AX





# **VEVOR**

**Affordable. Reliable. Home Improvement.**

**Rotan DRESSOIR**

**Model: ZD-25TB01**



# VEVOR

Affordable. Reliable. Home Improvement.

## RATTAN DRESSER

**MODEL: ZD-25TB01**

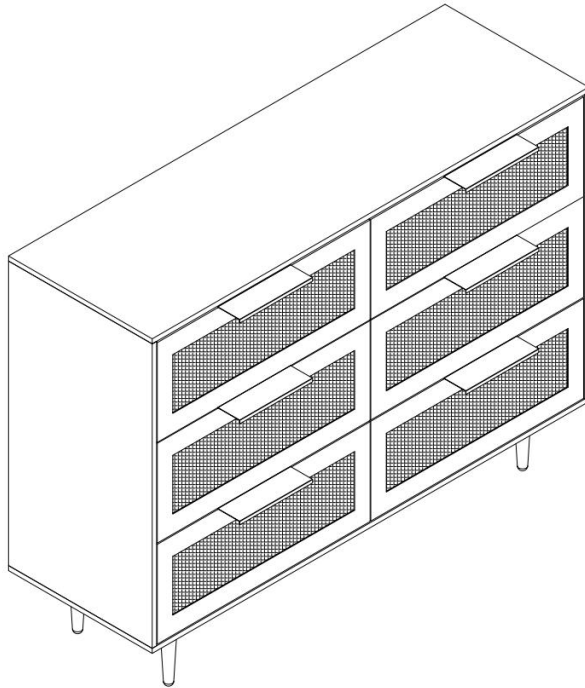

Dit is de originele handleiding. Lees alle instructies zorgvuldig door voordat u het product gebruikt. VEVOR behoudt zich het recht voor om de gebruiksaanwijzing duidelijk te interpreteren. Het uiterlijk van het product is afhankelijk van het product dat u hebt ontvangen. Neemt u het ons niet kwalijk dat we u niet meer op de hoogte stellen van eventuele technologische of software-updates voor ons product.

## SAFETY INSTRUCTIONS

### INVOERING

**Bedankt voor uw aankoop van onze producten. Ons doel is altijd geweest om onze klanten de beste kwaliteit producten en service te bieden. Lees dit aandachtig door voordat u het product gebruikt. Gebruiksaanwijzing zorgvuldig door om correct gebruik te garanderen. Bewaar de gebruiksaanwijzing op een plaats waar de gebruiker deze op elk gewenst moment kan vinden.**

### MONTAGE VOORZORGSMAATREGELEN

**Er zijn er veel componenten en accessoires in het pakket. Elk Als een onderdeel of accessoire is gemarkeerd met een letter of een cijfer, controleer dan zorgvuldig door voordat u ze gebruikt. Houd ze buiten bereik van kinderen. ongelukken voorkomen.**

1. Monteer het product uitsluitend volgens deze instructies. Onjuiste montage kan gevaarlijk zijn.
2. Draag tijdens de montage een ANSI-goedgekeurde veiligheidsbril en stevige werkhandschoenen.
3. Houd de verzamelplaats schoon en goed verlicht.
4. Houd omstanders tijdens de montage uit de buurt.
5. Kom niet in actie als u moe bent of onder invloed van alcohol, drugs of medicijnen.
6. De producteigenschappen gelden uitsluitend voor correct en volledig gemonteerde producten.
7. Installeer het product op een schone en zachte ondervloer (zoals tapijt). of karton) om krassen of beschadigingen aan het oppervlak van de product .
8. Indien mogelijk kunt u elektrisch gereedschap gebruiken om de montage te vergemakkelijken.
9. De hoofdcomponenten van het product zijn relatief zwaar. Betaal alstublieft aandacht voor veiligheid tijdens de installatie .
10. Het product is niet stabiel tijdens de installatie. Verplaats het niet

willekeurig. voordat het volledig is geïnstalleerd .

11. Voor aanvullende informatie over de hieronder vermelde onderdelen. Raadpleeg voor meer informatie het montageschema in deze handleiding. Pak alle onderdelen uit en scheid ze van elkaar op een schone werkplek.

**\*VOLG DE INSTALLATIESTAPPEN IN DE HANDLEIDING OM VOORKOM ONNODIGE VERLIEZEN ALS GEVOLG VAN ONJUISTE INSTALLATIE.**

**GEBRUIK VOORZORGSMAATREGELEN**

- 1) Niet overschrijden aangegeven gewichtscapaciteiten.
- 2) Gebruik het product alleen op een vlak, egaal, hard en glad oppervlak dat een volledig gevulde rieten ladekast veilig kan dragen.
- 3) Alleen gebruiken zoals bedoeld.
- 4) Controleer het product voor elk gebruik. Niet gebruiken als er onderdelen loszitten of beschadigd zijn.

**WAARSCHUWING**

**Kinderen zijn gestorven door meubels Om het risico op kantelen van meubels te verminderen kantelen:**







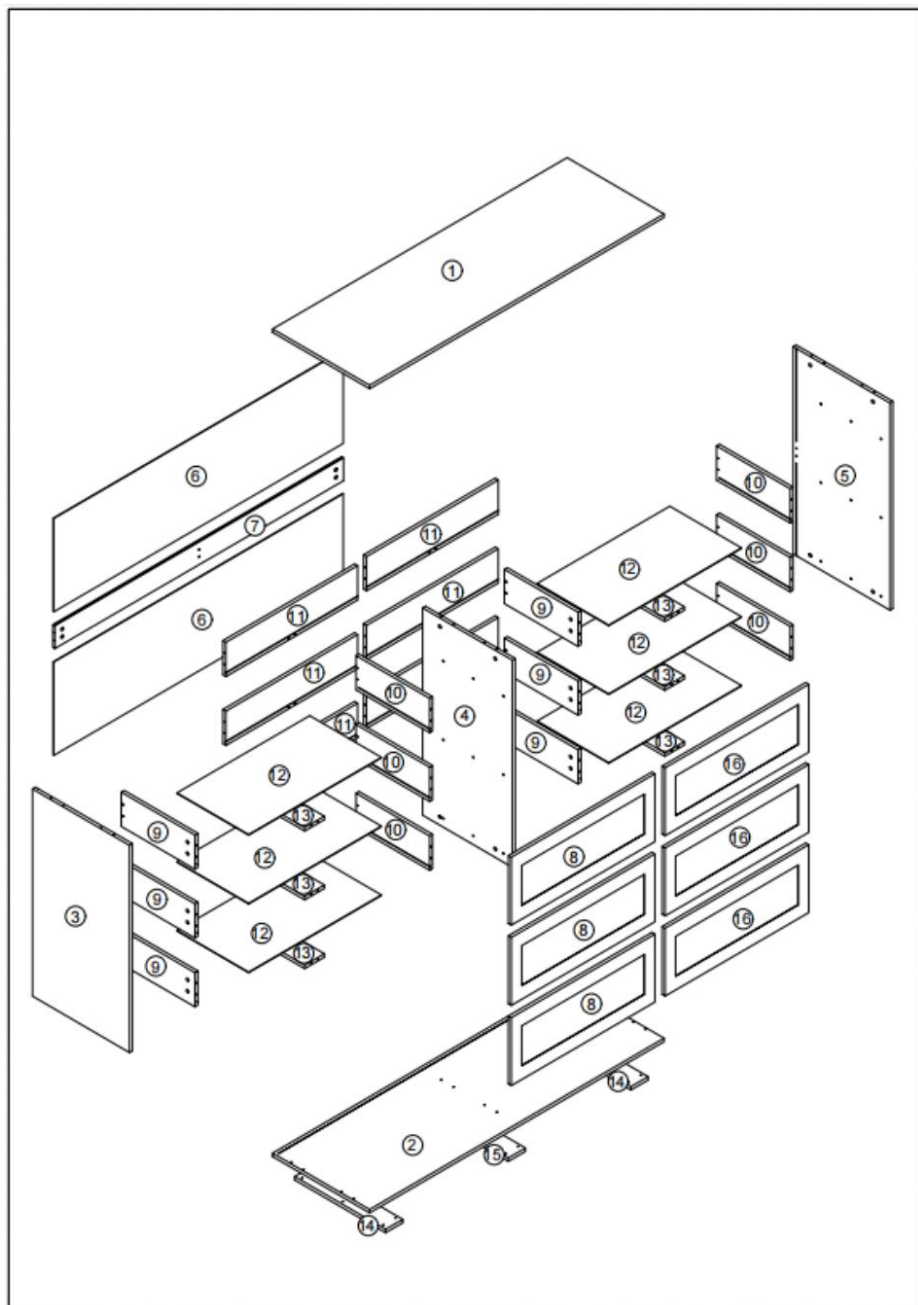



- **Installeer ALTIJD de meegeleverde anti-kantelvoorziening.**
- **Sluit NOOIT een tv aan op dit product.**
- **Laat kinderen NOOIT staan, klimmen of hangen op laden, deuren of planken.**
- **Open NOOIT meer dan één lade tegelijk .**
- **Plaats de zwaarste spullen in de onderste lades .**

**BEWAAR DEZE HANDLEIDING**





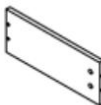
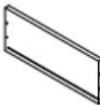

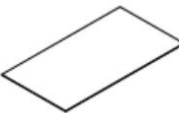
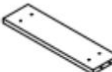
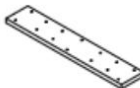
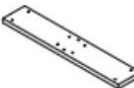
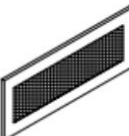





## EXPLODED VIEW

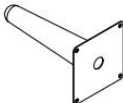

## PARTS LIST

①  x1	②  x1	③  x1	④  x1
⑤  x1	⑥  x2	⑦  x1	⑧  x3
⑨  x6	⑩  x6	⑪  x6	⑫  x6
⑬  x6	⑭  x2	⑮  x1	⑯  x3

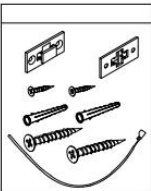
## PARTS LIST

<p style="text-align: center;">A</p>  <p style="text-align: center;">x66+2</p>	<p style="text-align: center;">B</p>  <p style="text-align: center;">x66+2</p>	<p style="text-align: center;">C</p>  <p style="text-align: center;">x12</p>	<p style="text-align: center;">D</p>  <p style="text-align: center;">x104+2</p>
<p style="text-align: center;">E</p>  <p style="text-align: center;">x18</p>	<p style="text-align: center;">F</p>  <p style="text-align: center;">x24</p>	<p style="text-align: center;">G</p>  <p style="text-align: center;">x6</p>	<p style="text-align: center;">H</p>  <p style="text-align: center;">x12</p>
<p style="text-align: center;">I</p>  <p style="text-align: center;">x5</p>	<p style="text-align: center;">J</p>  <p style="text-align: center;">x16</p>	<p style="text-align: center;">K</p>  <p style="text-align: center;">x16</p>	<p style="text-align: center;">L</p>  <p style="text-align: center;">x1</p>
 <p style="text-align: center;">x1</p>			

## ASSEMBLY STEP

### Installation of Cams and Pins

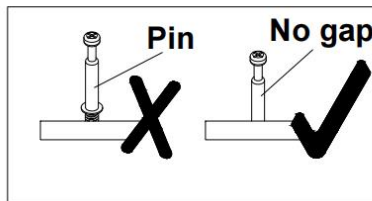
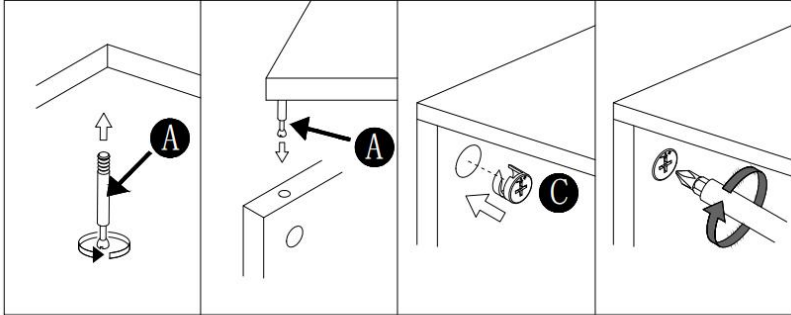

## ASSEMBLY STEP

### Step 1

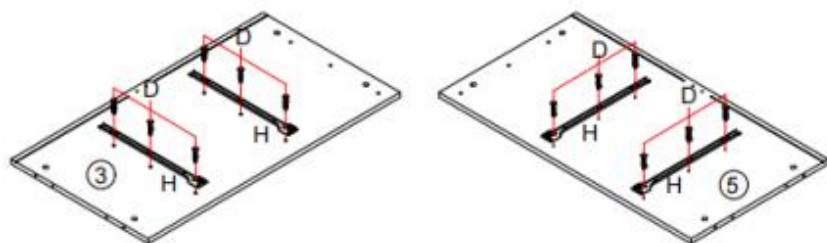

### Step 2

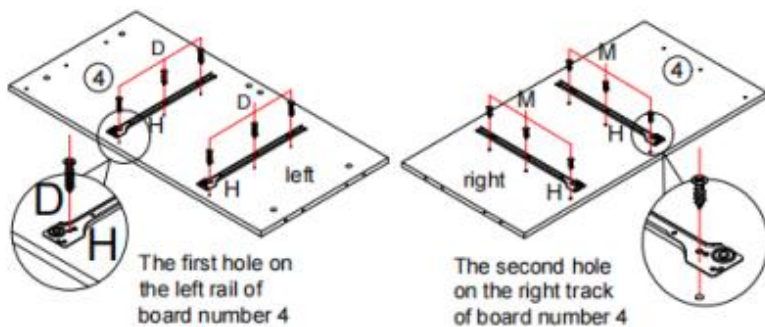

## ASSEMBLY STEP

### Step 3

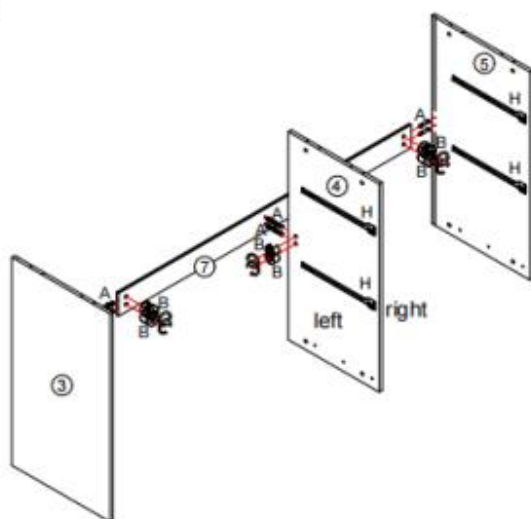

### Step 4

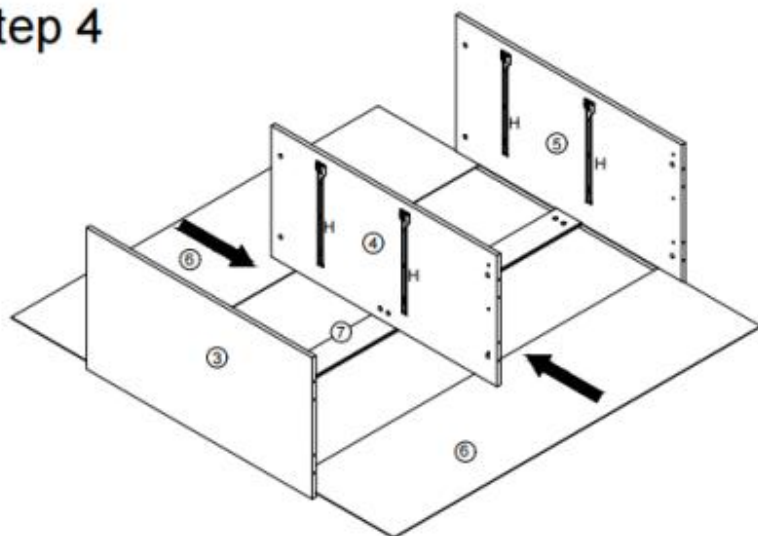

## ASSEMBLY STEP

### Step 5

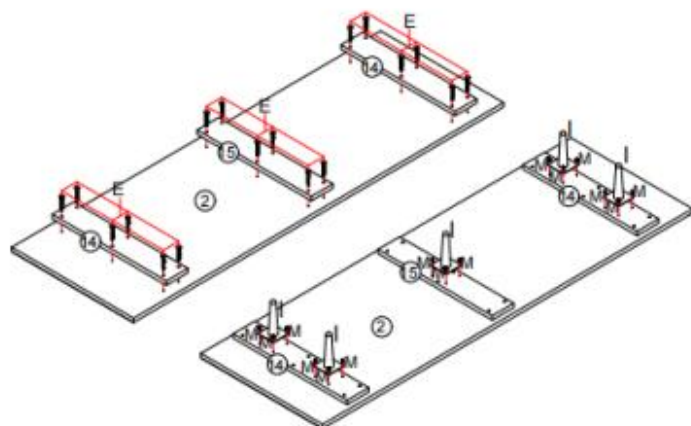

### Step 6

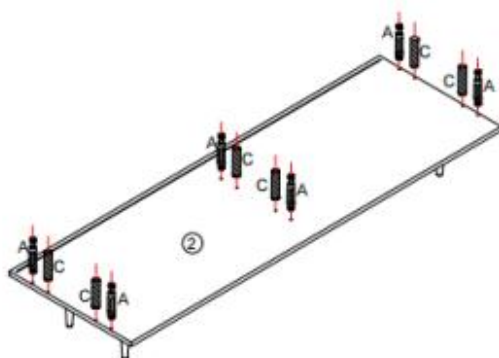

## ASSEMBLY STEP

### Step 7

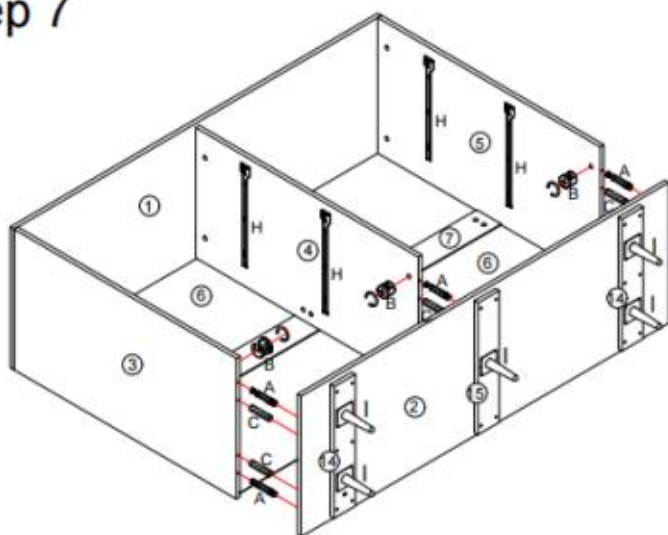

### Step 8

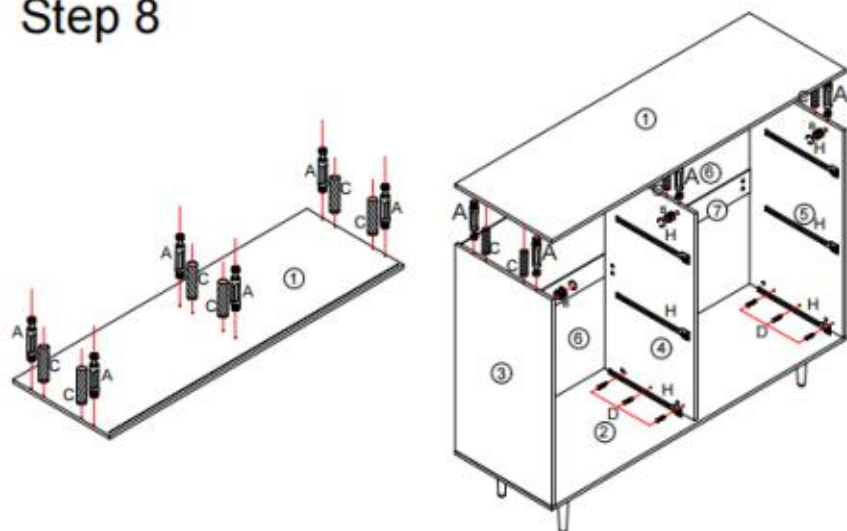

## ASSEMBLY STEP

### Step 9

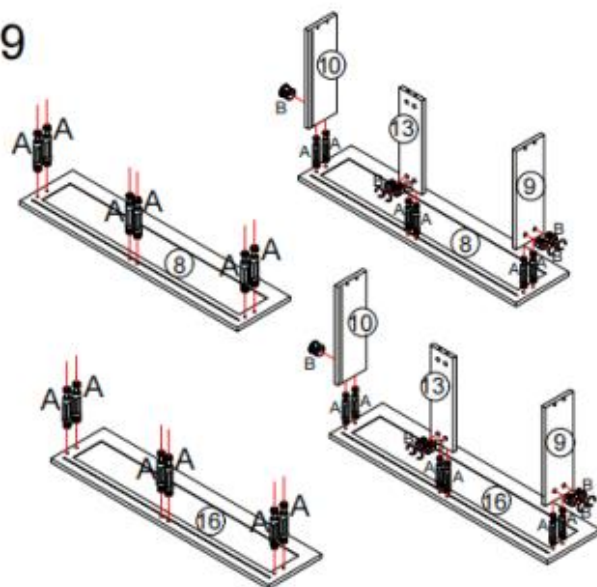

### Step 10

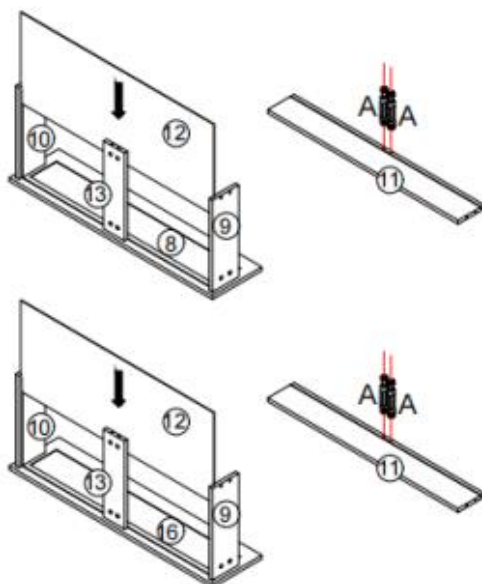

## ASSEMBLY STEP

### Step 11

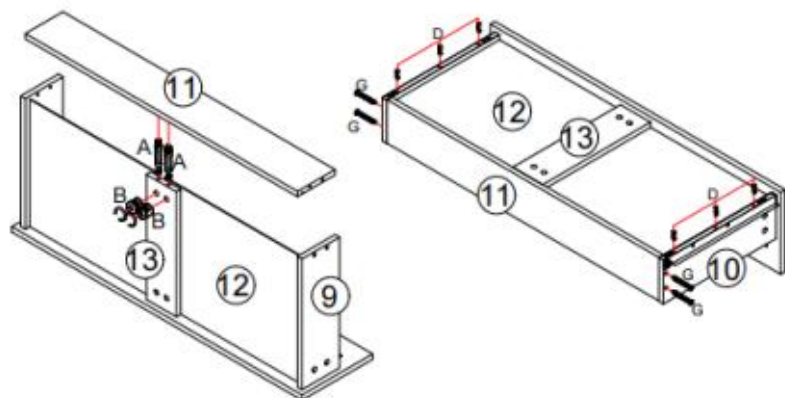

### Step 12

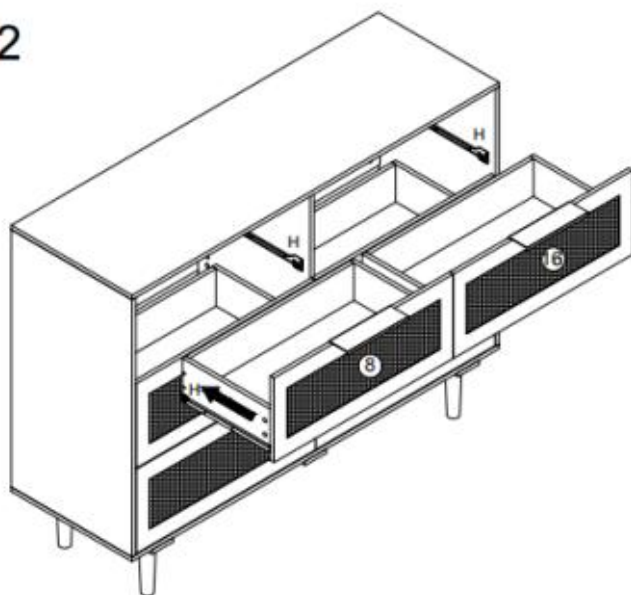

## ASSEMBLY STEP

Step 13

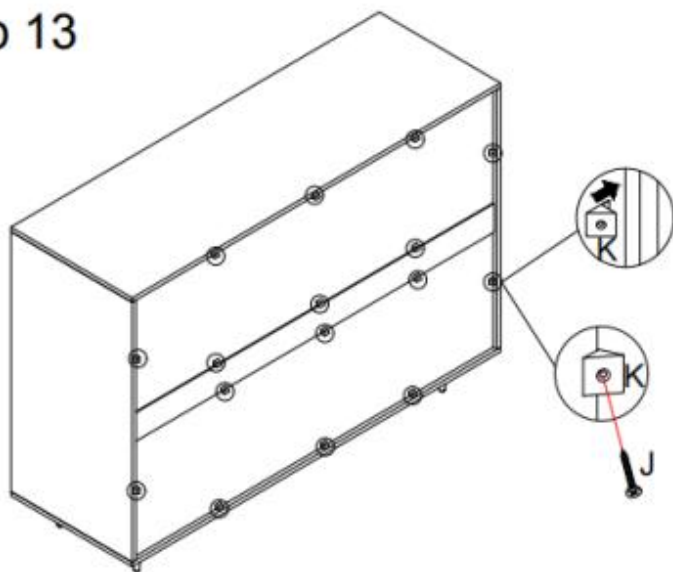

Step 14

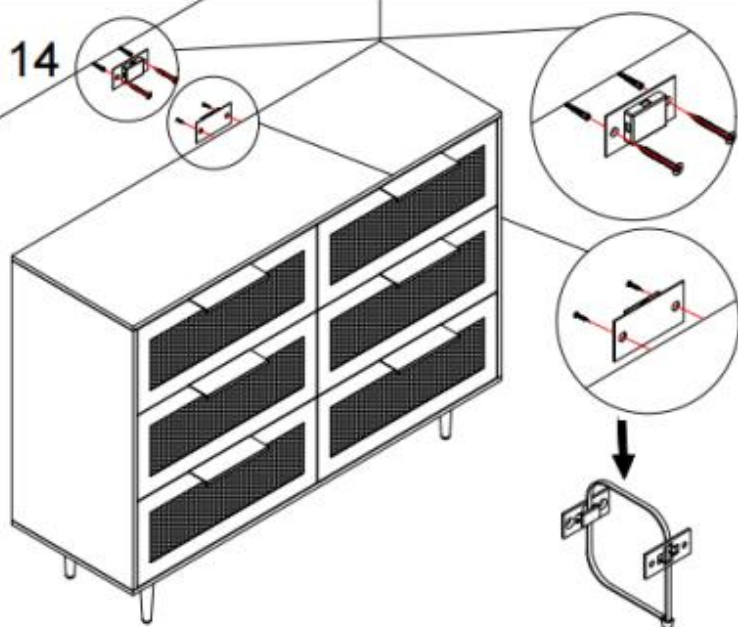

## PRODUCT PARAMETER

<b>Model</b>	<b>ZD-25TB01</b>
<b>Veilig laadgewicht</b>	Lade: 22 lbs/desktop: 66 lbs
<b>Productafmetingen (D*B*H)</b>	1 2 00 * 395 * 854 mm

\* Productspecificaties, zoals het uiterlijk en het ontwerp, kunnen zonder voorafgaande kennisgeving worden gewijzigd.

**Fabrikant:** Caoxian Zhengda Arts&Crafts Co.,LTD

**Adres:** Guyingji Development Zone, Cao County, provincie Shandong, China 274418

**Geïmporteerd naar AUS:** SIHAO PTY LTD. 1 ROKEVA  
STREETEASTWOOD NSW 2122 Australië

**Geïmporteerd naar de VS:** Sanven Technology Ltd. Suite 250, 9166  
Anaheim Place, Rancho Cucamonga, CA 91730

<b>EC</b>	<b>REP</b>
-----------	------------

E-CrossStu GmbH  
Mainzer Landstr.69, 60329 Frankfurt am Main.

<b>UK</b>	<b>REP</b>
-----------	------------

YH CONSULTING LIMITED.  
C/O YH Consulting Limited Office 147, Centurion  
House, London Road, Staines-upon-Thames, Surrey,  
TW18 4AX





# VEVOR

**Affordable. Reliable. Home Improvement.**

**Rottingbyrå**

**Modell: ZD-25TB01**



# VEVOR

Affordable. Reliable. Home Improvement.

## RATTAN DRESSER

**MODELL: ZD-25TB01**

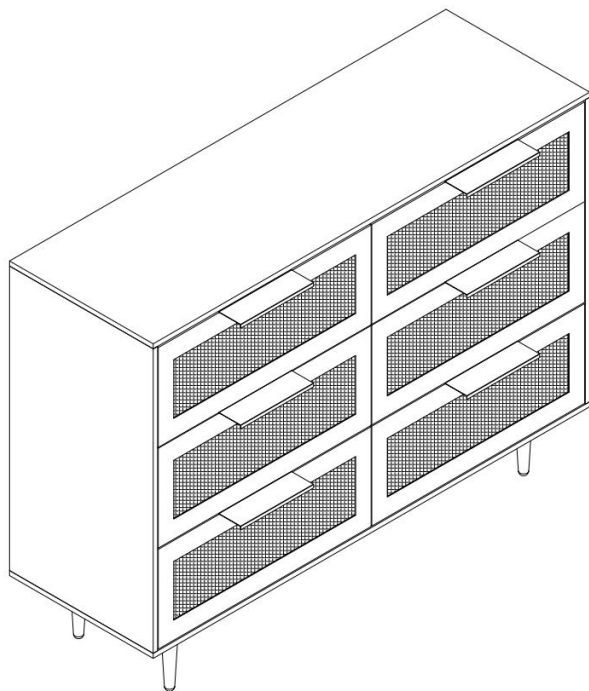

Detta är originalinstruktionerna, vänligen läs alla instruktioner noggrant innan du använder produkten. VEVOR förbehåller sig en tydlig tolkning av vår användarmanual. Produktens utseende ska vara beroende av den produkt du mottagit. Vi ber om ursäkt för att vi inte kommer att informera dig igen om det finns några teknik- eller programuppdateringar för vår produkt.

## SAFETY INSTRUCTIONS

### INTRODUKTION

Tack för att du köpt våra produkter. Vårt livslånga mål är att förse våra kunder med produkter och service av bästa kvalitet. Läs detta innan du använder produkten.

instruktionsmanual noggrant för att säkerställa korrekt användning. Förvara bruksanvisningen på en plats där användaren kan hitta den när som helst.

### MONTERING FÖRSIKTIGHETSÅTGÄRDER

Det finns många komponenter och tillbehör i paketet. Varje en komponent och tillbehör är märkt med en bokstav eller siffra, kontrollera noggrant innan du använder någon av dem. Håll dem utom räckhåll för barn förhindra olyckor.

1. Montera endast enligt dessa instruktioner. Felaktig montering kan orsaka risker.
2. Använd ANSI-godkända skyddsglasögon och kraftiga arbetshandskar under monteringen.
3. Håll samlingsområdet rent och väl upplyst.
4. Håll åskådare borta från området under monteringen.
5. Montera inte om du är trött eller påverkad av alkohol, droger eller mediciner.
6. Produktens egenskaper gäller endast korrekt och fullständigt monterade produkter.
7. Installera produkten på ett rent och mjukt underlag (t.ex. en matta eller kartong) för att undvika repor eller skador på ytan på produkt .
8. Om möjligt kan du använda elverktyg för att underlätta monteringen.
9. Produktens huvudkomponenter är relativt tunga. Vänligen betala uppmärksamhet på säkerheten under installationen .
10. Produkten är inte stabil under installationen. Flytta den inte slumpmässigt. innan den är helt installerad .
11. För ytterligare information om de delar som anges nedan.

sidorna, se monterings-schemat i denna manual. Packa upp och separera alla delar på en ren arbetsyta.

**\*VÄNLIGEN FÖLJ INSTALLATIONSSTEGEN I HANDBOKEN FÖR ATT UNDVIK ONÖDIGA FÖRLUSTER ORSAKAD AV FELAKTIG INSTALLATION.**

**ANVÄND FÖRSIKTIGHETSÅTGÄRDER**

- 1) Överskrid inte angivna viktkapacitet.
- 2) Använd endast på en plan, jämn, hård och slät yta som säkert kan bära en fullastad rottingbyrå.
- 3) Använd endast som avsett.
- 4) Kontrollera före varje användning; använd inte om delar är lösa eller skadade.

**VARNING**

**Barn har dött av möbler För att minska risken för att möbler välter vältning:**







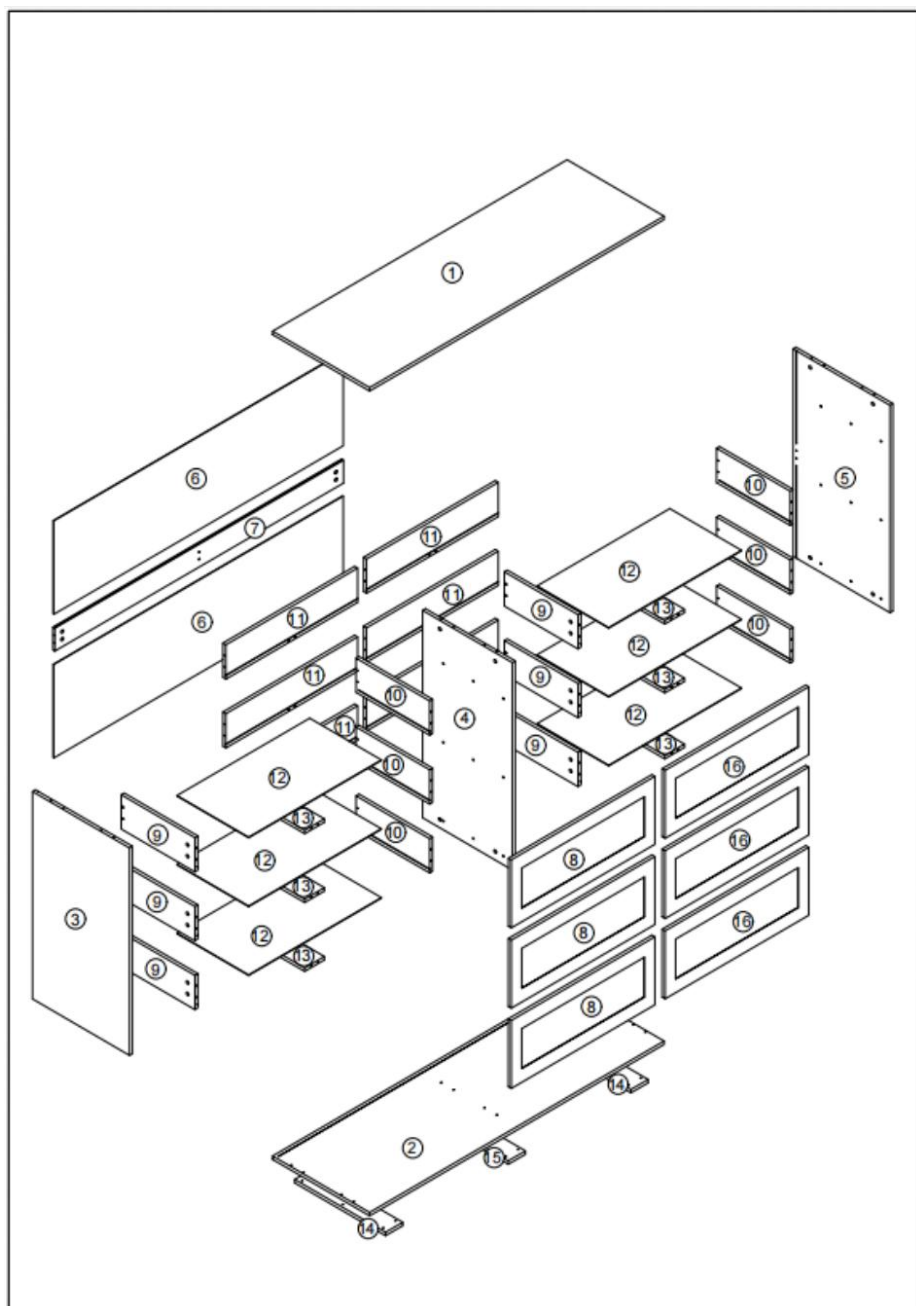



- Installera ALLTID det medföljande tippskyddet.
- Placera ALDRIG en TV på den här produkten.
- Låt ALDRIG barn stå, klättra eller hänga på lådor, dörrar eller hyllor.
- Öppna ALDRIG mer än en låda åt gången .
- Placera de tyngsta föremålen i de nedersta lådorna .

**SPARA DENNA HANDBOK**





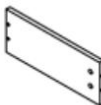
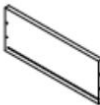

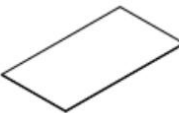
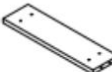
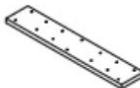
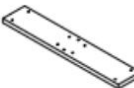
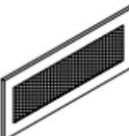





## EXPLODED VIEW

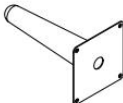

## PARTS LIST

①  x1	②  x1	③  x1	④  x1
⑤  x1	⑥  x2	⑦  x1	⑧  x3
⑨  x6	⑩  x6	⑪  x6	⑫  x6
⑬  x6	⑭  x2	⑮  x1	⑯  x3

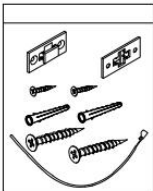
## PARTS LIST

<p style="text-align: center;">A</p>  <p style="text-align: center;">x66+2</p>	<p style="text-align: center;">B</p>  <p style="text-align: center;">x66+2</p>	<p style="text-align: center;">C</p>  <p style="text-align: center;">x12</p>	<p style="text-align: center;">D</p>  <p style="text-align: center;">x104+2</p>
<p style="text-align: center;">E</p>  <p style="text-align: center;">x18</p>	<p style="text-align: center;">F</p>  <p style="text-align: center;">x24</p>	<p style="text-align: center;">G</p>  <p style="text-align: center;">x6</p>	<p style="text-align: center;">H</p>  <p style="text-align: center;">x12</p>
<p style="text-align: center;">I</p>  <p style="text-align: center;">x5</p>	<p style="text-align: center;">J</p>  <p style="text-align: center;">x16</p>	<p style="text-align: center;">K</p>  <p style="text-align: center;">x16</p>	<p style="text-align: center;">L</p>  <p style="text-align: center;">x1</p>
 <p style="text-align: center;">x1</p>			

## ASSEMBLY STEP

### Installation of Cams and Pins

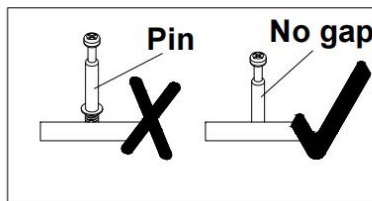
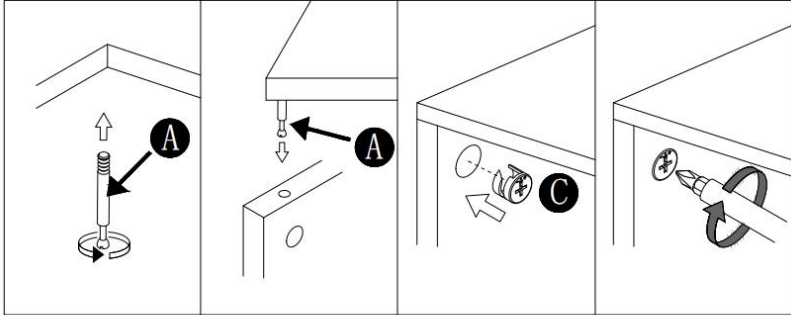

## ASSEMBLY STEP

### Step 1

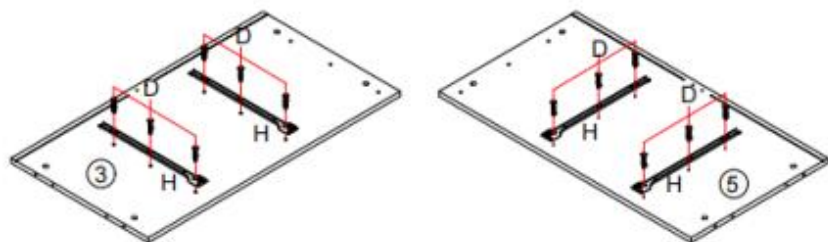

### Step 2

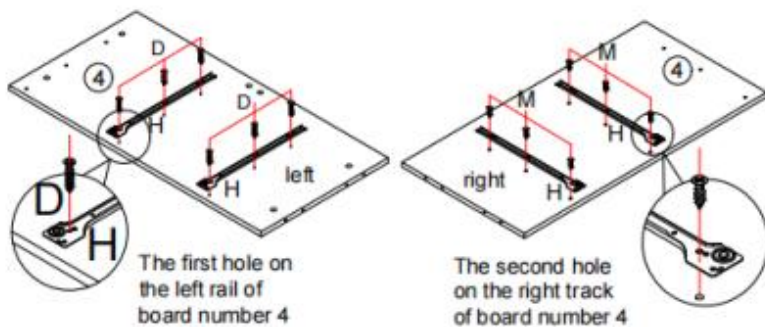

## ASSEMBLY STEP

### Step 3

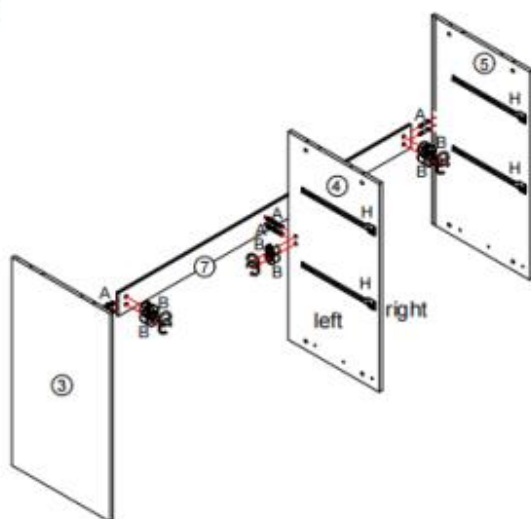

### Step 4

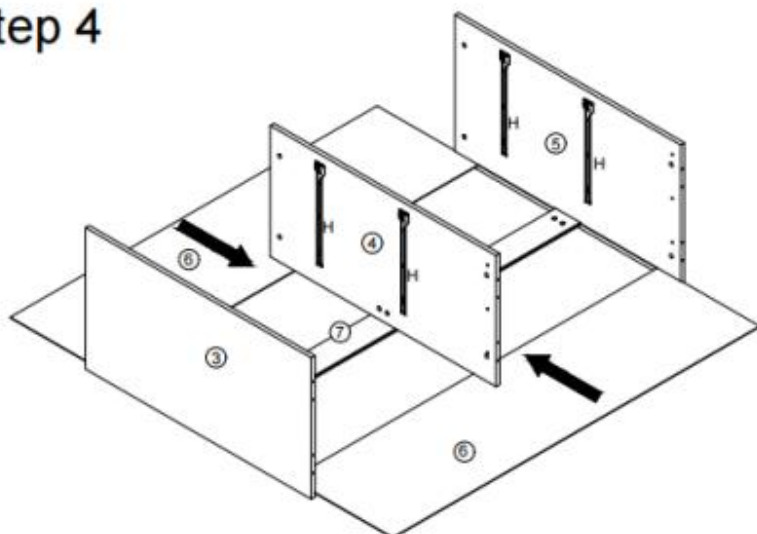

## ASSEMBLY STEP

### Step 5

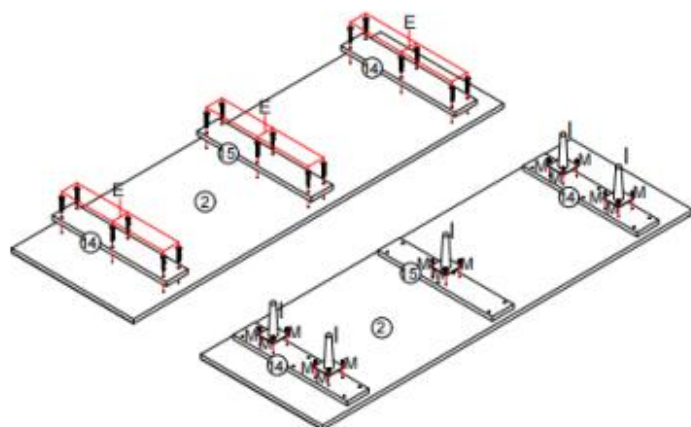

### Step 6

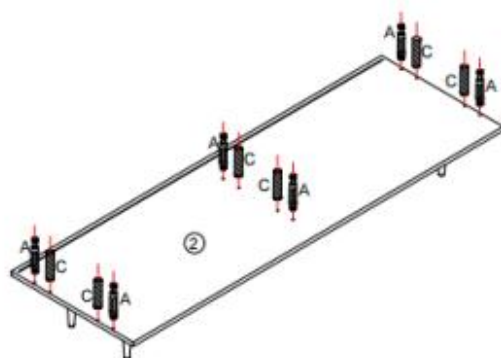

## ASSEMBLY STEP

### Step 7

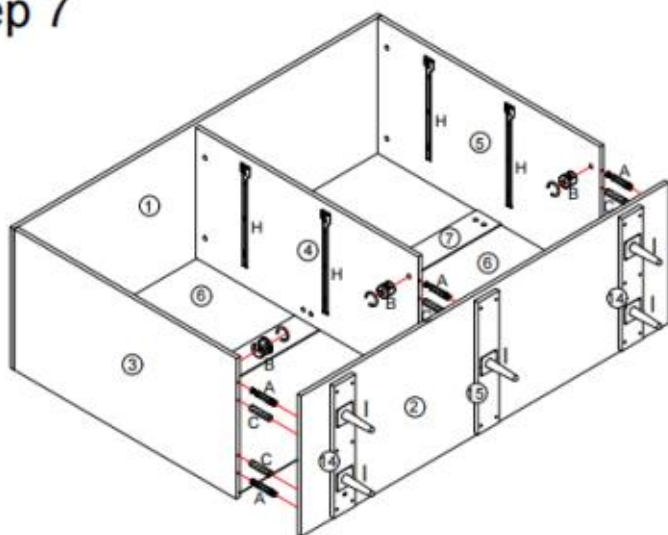

### Step 8

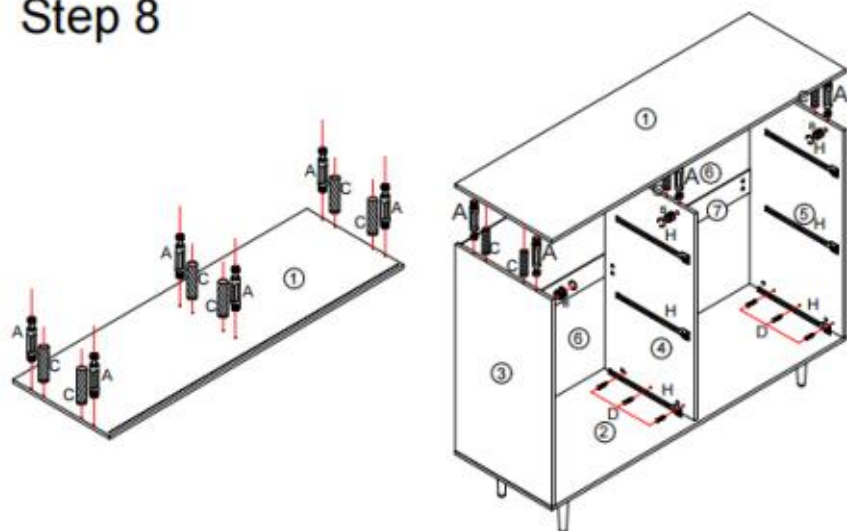

## ASSEMBLY STEP

### Step 9

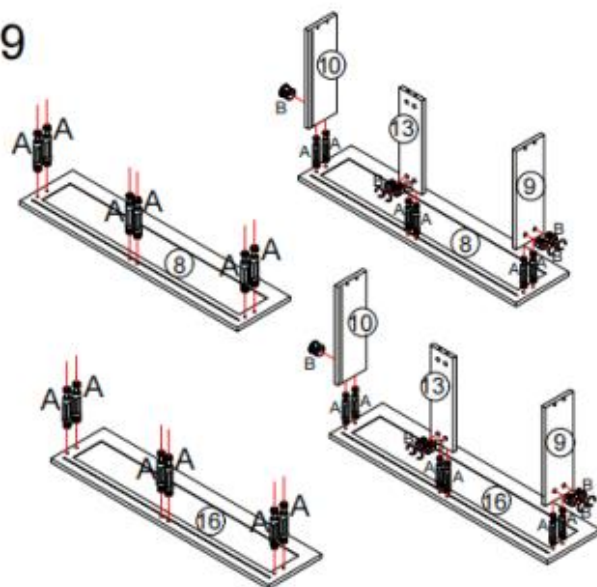

### Step 10

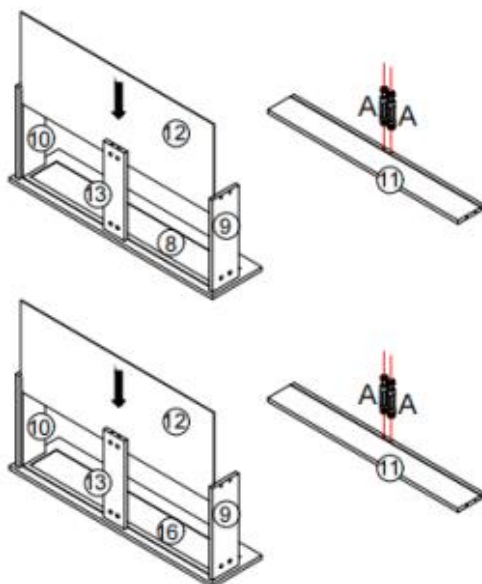

## ASSEMBLY STEP

### Step 11

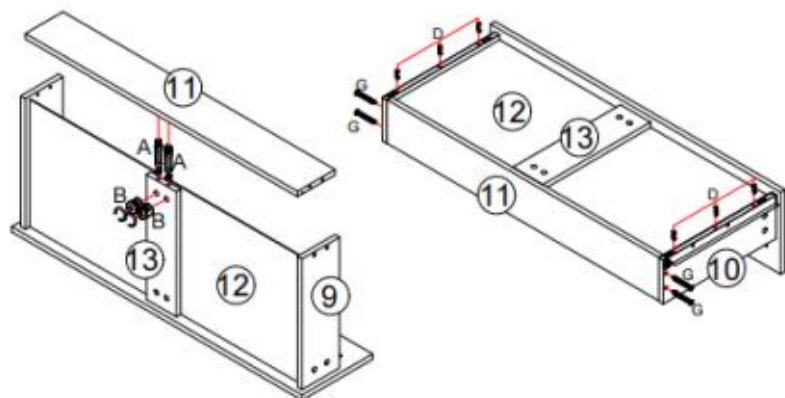

### Step 12

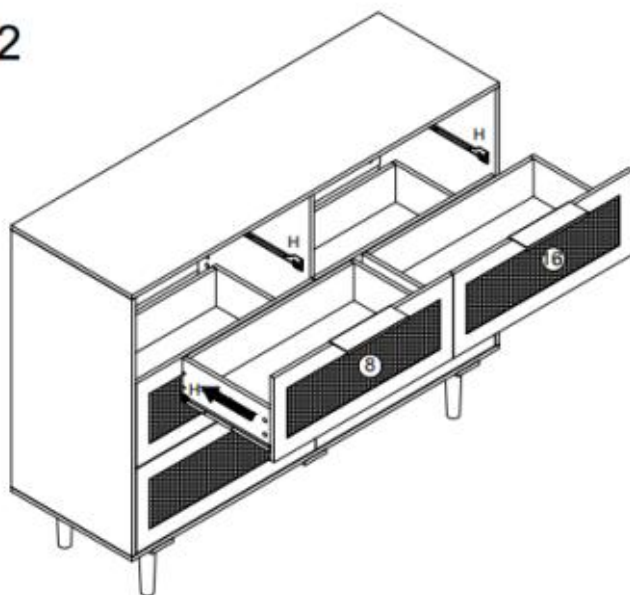

## ASSEMBLY STEP

Step 13

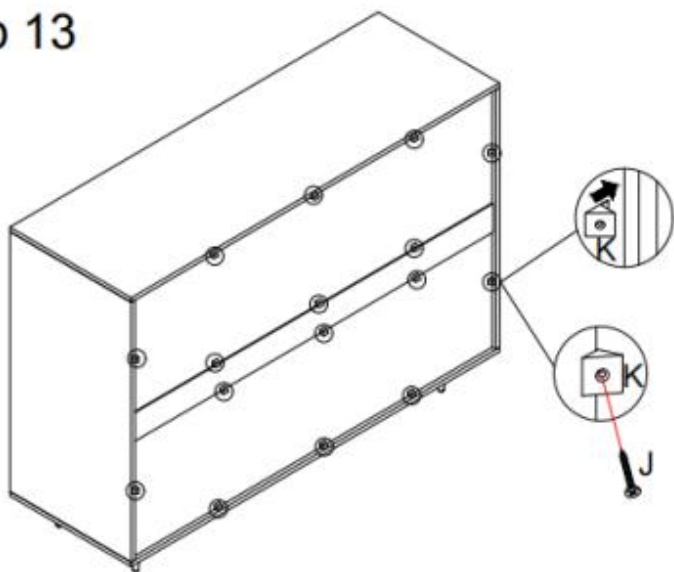

Step 14

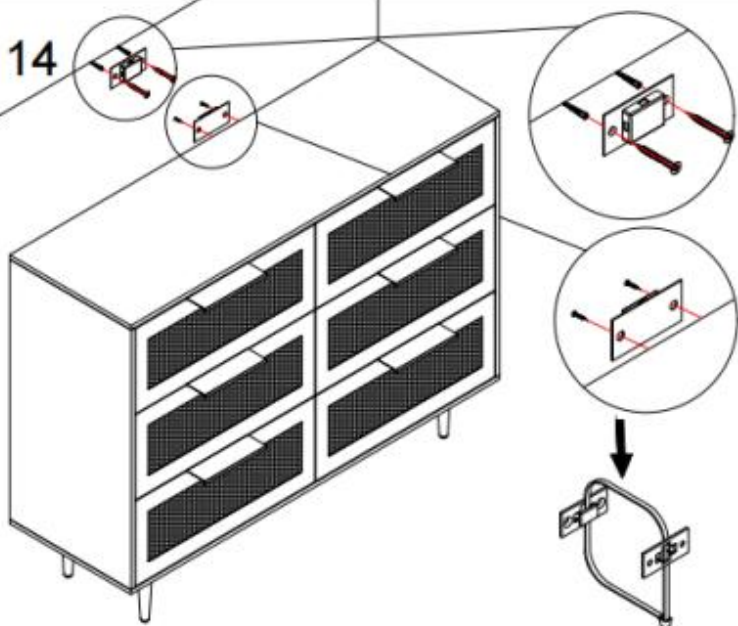

## PRODUCT PARAMETER

<b>Modell</b>	<b>ZD-25TB01</b>
<b>Säker lastvikt</b>	Låda: 22 pund/stationär dator: 66 pund
<b>Produktstorlek (D*B*H)</b>	1200 * 395 * 854 mm

\* Produkters specifikationer, utseende och design kan komma att ändras utan föregående meddelande.

**Tillverkare:** Caoxian Zhengda Arts&Crafts Co., LTD

**Address:** Guyingji utvecklingszon, Cao län, Shandongprovinsen, Kina  
274418

**Importerad till Australien:** SIHAO PTY LTD. 1 ROKEVA  
STREETEASTWOOD NSW 2122 Australien

**Importerad till USA:** Sanven Technology Ltd. Suite 250, 9166 Anaheim  
Place, Rancho Cucamonga, CA 91730

<b>EC</b>	<b>REP</b>
-----------	------------

E-CrossStu GmbH  
Mainzer Landstr.69, 60329 Frankfurt am Main.

<b>UK</b>	<b>REP</b>
-----------	------------

YH CONSULTING LIMITED.  
C/O YH Consulting Limited Office 147, Centurion  
House, London Road, Staines-upon-Thames, Surrey,  
TW18 4AX



