

VEVOR[®]

TOUGH TOOLS, HALF PRICE

Technical Support and E-Warranty Certificate

www.vevor.com/support

WET & DRY VACUUM CLEANER

MODEL: YLW6342-30L

We continue to be committed to provide you tools with competitive price.

"Save Half", "Half Price" or any other similar expressions used by us only represents an estimate of savings you might benefit from buying certain tools with us compared to the major top brands and does not necessarily mean to cover all categories of tools offered by us. You are kindly reminded to verify carefully when you are placing an order with us if you are actually saving half in comparison with the top major brands.

VEVOR®

TOUGH TOOLS, HALF PRICE

WET & DRY VACUUM
CLEANER

MODEL: YLW6342-30L

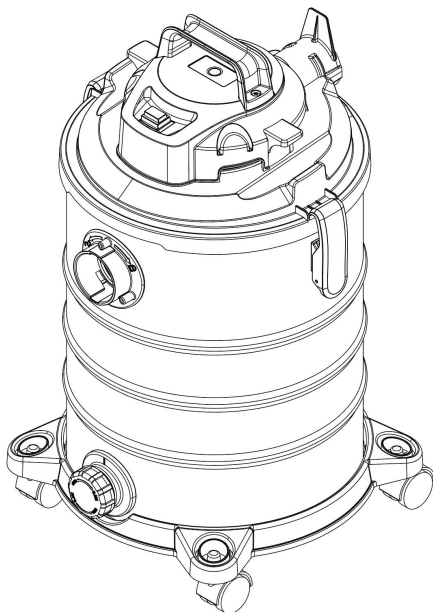

NEED HELP? CONTACT US!

Have product questions? Need technical support? Please feel free to contact us:

Technical Support and E-Warranty Certificate
www.vevor.com/support

This is the original instruction, please read all manual instructions carefully before operating. VEVOR reserves a clear interpretation of our user manual. The appearance of the product shall be subject to the product you received. Please forgive us that we won't inform you again if there are any technology or software updates on our product.



Warning-To reduce the risk of injury, user must read instructions manual carefully.



This product is subject to the provision of European Directive 2012/19/EC. The symbol showing a wheellie bin crossed through indicates that the product requires separate refuse collection in the European Union. This applies to the product and all accessories marked with this symbol. Products marked as such may not be discarded with normal domestic waste, but must be taken to a collection point for recycling electrical and electronic devices

Warning:

- This appliance can be used by children aged from 8 years and above and persons with reduced physical, sensory or mental capabilities or lack of experience and knowledge if they have been given supervision or instruction concerning use of the appliance in a safe way and understand the hazards involved.
- Children shall not play with the appliance.
- Cleaning and user maintenance shall not be made by children without supervision.
- This appliance shall state that the plug must be removed from the socket-outlet before cleaning or maintaining the appliance.
- If the supply cord is damaged, it must be replaced by the manufacturer, its service agent or similarly qualified persons in order to avoid a hazard.
- The plug must be removed from the socket-outlet before cleaning or maintaining the appliance.

INSTRUCTIONS

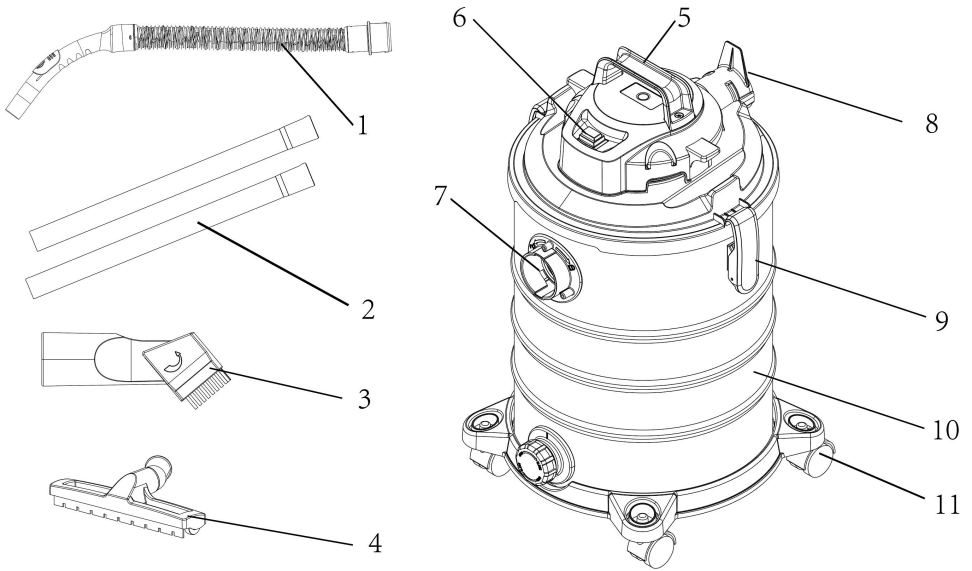

- | | | | | | |
|----|---------------|----|-----------------|---|-------------|
| 1 | Hose assembly | 2 | Connected tube | 3 | 2in1 nozzle |
| 4 | Floor brush | 5 | Handle | 6 | Switch |
| 7 | Suction seat | 8 | Blowing outlet | 9 | Lock |
| 10 | Barrel | 11 | Universal wheel | | |

SAVE THIS MANUAL

Model	YLW6342-30L
Rating	AC120 V 60 Hz
Power Suppler	1200 W
Protection Against Electric Shock:	Class II
Degree Of Protection:	IPX4
Capacity	30L

ATTENTION

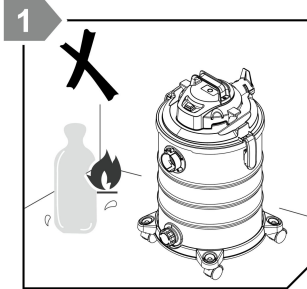

1. Do not use the vacuum cleaner near flammable and explosive liquids or gases to avoid fires.

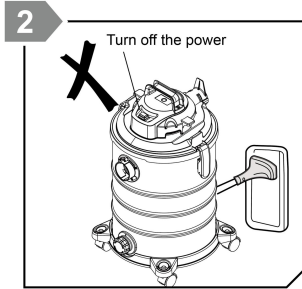

2. When plugging and unplugging the power plug, please turn off the power switch first to avoid risks of fires or electric shocks.

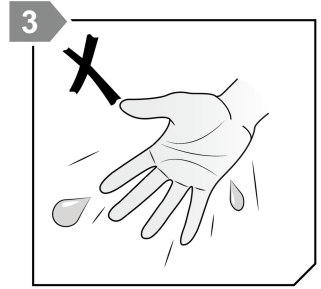

3. Do not touch the power plug with wet hands to prevent against electric shocks.

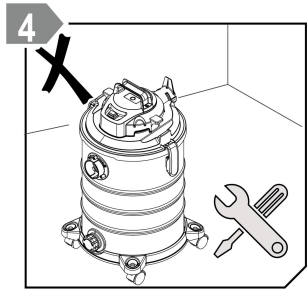

4. Non-professionals are not allowed to start the repair of this appliance. If its electronic components are damaged, they must be replaced by professionals from the manufacturer, the maintenance department or similar departments in order to avoid risks.

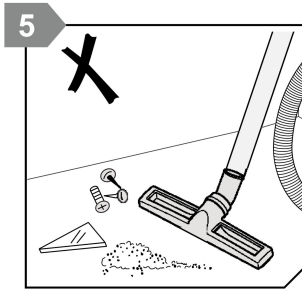

5. In order to avoid fires or electric shocks, in the cleaning of this appliance, be careful not to let the body inhale blades, tinder, metal powder, etc., which will damage the filter assembly and short-circuit of the motor.

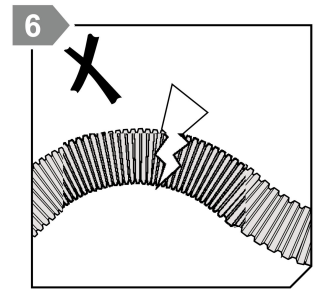

6. Do not bend, trample, or pull the hose. If the hose is damaged, do not continue to use it.

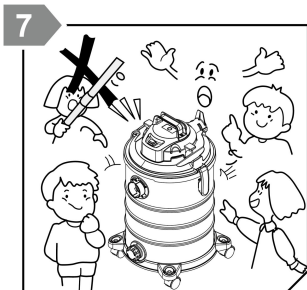

7. Do not allow children to play the vacuum cleaner and its components, such as extension tubes, as toys to prevent against accidents.

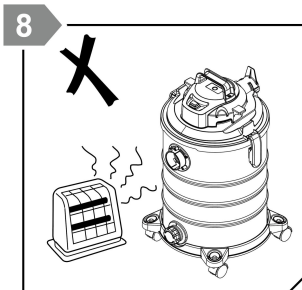

8. Do not allow the power cord and the vacuum cleaner to be close to the heat source, so as to avoid deformation of the body or fires.

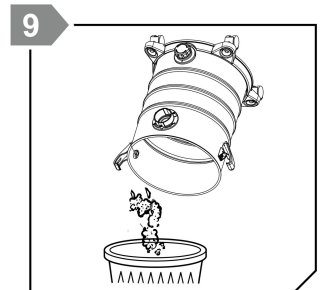

9. When the dust collector is full, please open it correctly for cleaning. Do not use the vacuum cleaner when the dust collector or HEPA is not installed.

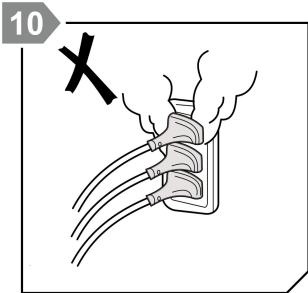

10. Please use the power strip for currents above 15A. Using multiple electrical appliances on one power strip at the same time may cause fires.

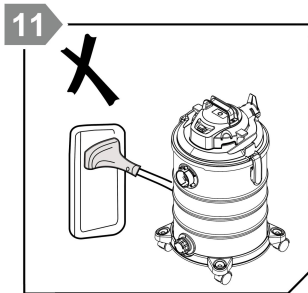

11. Please remember to unplug the power plug when you do not use the appliance for a long time. Please do not leave it when the power is on.

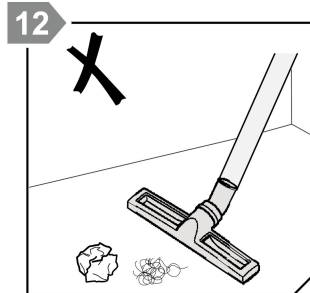

12. Please do not inhale hair balls, large paper balls and other items, otherwise it is easy to block the hose. If there is a blockage, please clean it up in time.

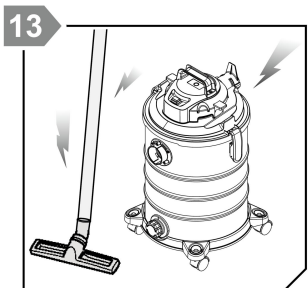

13. As the extension tube and the body may generate static electricity in the course of use of the appliance, please pay attention to it when using it.

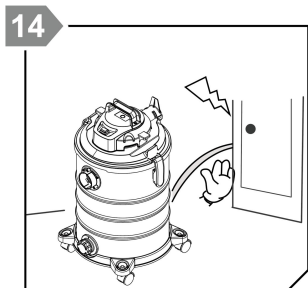

14. Do not allow the power cord to be caught in the door crack or to pull the vacuum cleaner by using the power cord to prevent damage to the power supply.

INSTALLATION PROCESS

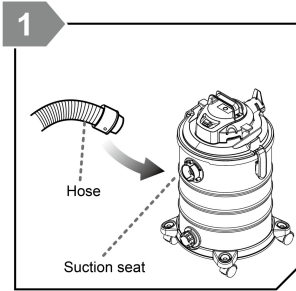

- (1) Insertion: Insert the main suction tube into the suction port until it locks.
 (2) Take out: Press the suction port seat button and pull out the main suction tube body.

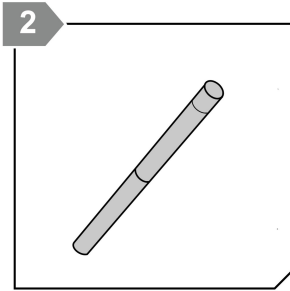

- Use of connected tube**
 (1) Butt joint: Insert one section of the connector into the inner diameter of the other port and tighten it.
 (2) Pull out: Hold the connector at the interface with both hands and pull it out.

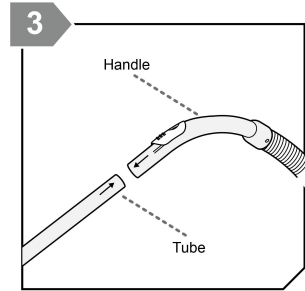

- Hose handle and connected tube**
 (1) Butt joint: Insert the handle at one end of the hose into the extension pipe and tighten it.
 (2) Pull out: Hold the extension tube and handle at the interface with both hands and pull out them.

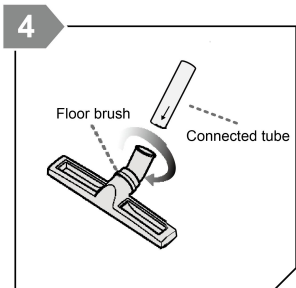

- Floor brush and connected tube connection**
 (1) Butt joint: Insert the other end of the connected tube into the inner diameter of the interface of the floor brush assembly and tighten it.
 (2) Pull out: Hold the floor brush assembly and the interface of the connected tube with both hands and pull out them.

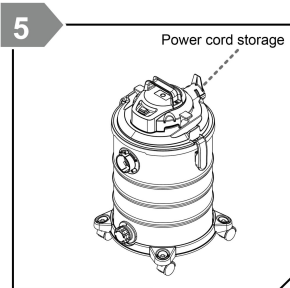

- Power cord storage**
 (1) When storing the power cord: wrap the power cord regularly around the hub.
 (2) When using the power cord: Lift the hook of the power cord upward and rotate it 90° to quickly remove the power cord.

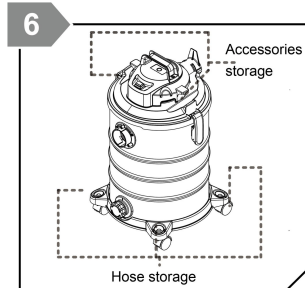

- Storage of accessories**
 (1) All accessories can be inserted into the accessory rack (4 accessory positions)
 (2) The hose can be placed in the hose receptacle.

INSTRUCTIONS FOR USE OF FUNCTIONAL COMPONENTS

Switch button

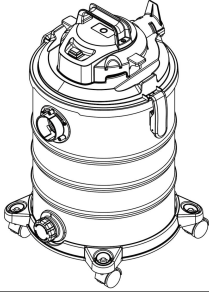

Switch button

After the plug of power cord is inserted into the socket, press the switch button to start the vacuum cleaner;

After vacuuming, press the switch button to turn off the vacuum cleaner.

Airflow adjustment

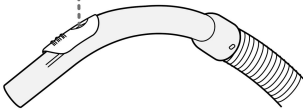

Airflow adjustment

Used for the suction adjustment, suction will decrease when the block is open, suction will reach max when the block is closed.

Handle

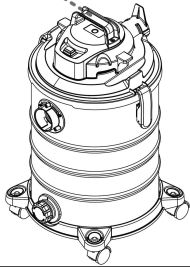

Handle Assemble

Handle can be fixed by users.

Blowing outlet

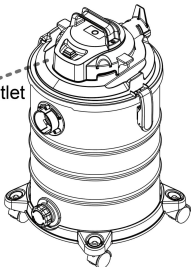

Blowing feature

For the suction adjustment device, the suction power can be adjusted by controlling the speed of motor, which can be adjusted and converted freely, and all vacuuming environments can be easily coped with.

INSTRUCTIONS FOR USE OF CLEANING

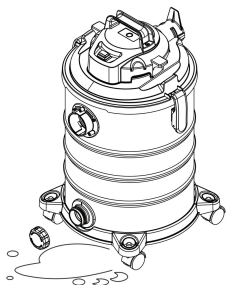

Liquid Cleaning

Open the knob on barre.

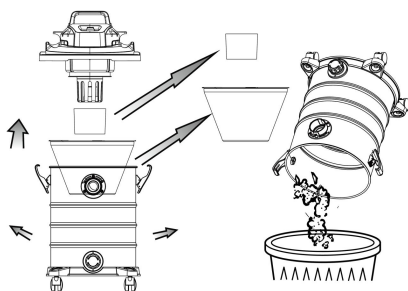

Trash cleaning

1. Open both sides of the barrel by hand, and lift up the entire head and filter.
2. Tilt the barrel and pour out trash inside the barrel.
3. Put the head back to the barrel and lock it.

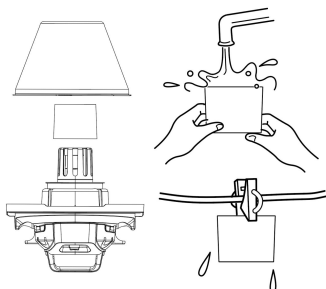

Clean sponge filter and cloth bag

After removing the filter and cloth bag from components of the appliance, wash and dry them.

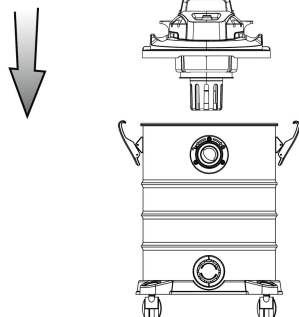

Reuse

After cleaning and drying them, they can be installed and used again.

INSTRUCTIONS FOR USE OF ACCESSORIES

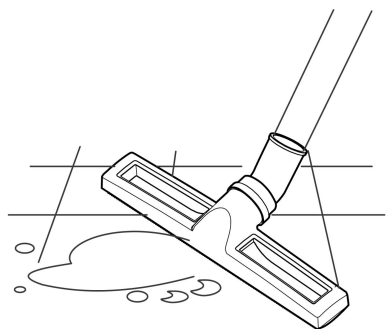

Floor brush

Mainly used to absorb water stains on the ground.

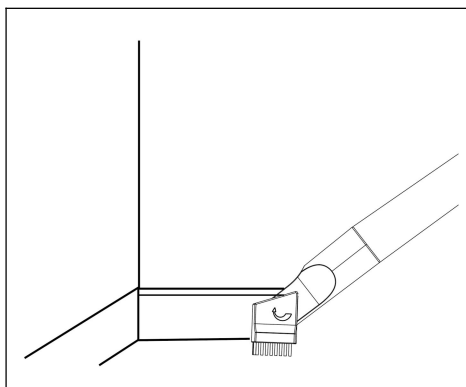

2in1 Nozzle

Mainly used for vacuuming corners, narrow gaps, etc.

Scientific Use, Maintain and Cleaning of the Vacuum Cleaner

1. In order to prolong the service life of the vacuum cleaner, it is recommended that the continuous use time shall not exceed 20 minutes.
2. In order to prolong the service life of the dust collector, it is recommended to clean up the trash in the dust collector in time after each use, rinse it with clean water, and then dry it.
3. It is recommended to rinse the filter with clean water once a month, and then dry it;
4. Please wipe the surface of the vacuum cleaner with a dry cloth, do not wipe it with a damp cloth to prevent water from entering the vacuum cleaner, otherwise it will cause a short circuit or even burn the vacuum cleaner.

FAQ

In order to avoid unnecessary losses, you shall read the following table carefully before contacting vacuum cleaner maintenance.



Fault	Possible Cause	Solution
The motor does not functioning	<ul style="list-style-type: none"> • Check if the plug of power supply is plugged in properly? • Check if the outlet of power supply is powered on? • Check if the power switch of the vacuum cleaner is turned on? • Check whether the brushes are burnt or worn, whether the switch of the vacuum cleaner is damaged or not, etc. 	<p>Reinsert the plug into the socket. Turn on the switch of socket or replace the socket of power supply. Turn on the switch. Please contact the after-sales maintenance in time.</p>
Reduced suction	<ul style="list-style-type: none"> • Check if accessories such as suction tube or dust bags are blocked? • Check if the dust collector is full? • Is the filter clogged or not? 	<p>Remove the blockage and clean it in time. Clean the dust collector. Clean the dust filter.</p>
Motor overheating	<p>The continuous operating time is too long, the brushes and commutators are worn, causing to generate too large sparks, too much dust to stick to the dust filter, and the dust collector is full of dust, etc.</p>	<p>You can take a rest and then use it. If the appliance also heats up after a short time, you need to open the dust collector to clean up the trash inside.</p>
Suction drop	<p>Check whether the motor is faulty, the brush is worn, the dust filter is damp, the dust chamber is full of dust, the hose and the suction nozzle or exhaust port are blocked, the pipeline is leaking, the interface is poorly sealed, etc.</p>	<p>Confirm whether the motor operates normally, clean the filter, dust cup, and hose, and re-tighten accessories at the interface seal.</p>
Body overheating or excluded gas overheating	<ul style="list-style-type: none"> • Is the suction normal? • Has it been used for more than 30 minutes? 	<p>The heat exhausted from the body is caused by the heat generated by the heat conduction of motor. It is a normal temperature, please continue to use it. Please stop and rest for 5 minutes before using it.</p>

Made In China

VEVOR[®]

TOUGH TOOLS, HALF PRICE

Technical Support and E-Warranty Certificate

www.vevor.com/support