

VEVOR[®]

TOUGH TOOLS, HALF PRICE

Technical Support and E-Warranty Certificate

www.vevor.com/support

INFLATABLE BOUNCER

We continue to be committed to provide you tools with competitive price.

"Save Half", "Half Price" or any other similar expressions used by us only represents an estimate of savings you might benefit from buying certain tools with us compared to the major top brands and does not necessarily mean to cover all categories of tools offered by us. You are kindly reminded to verify carefully when you are placing an order with us if you are actually saving half in comparison with the top major brands.

VEVOR[®]

TOUGH TOOLS, HALF PRICE

INFLATABLE BOUNCER

MODEL:PL2464

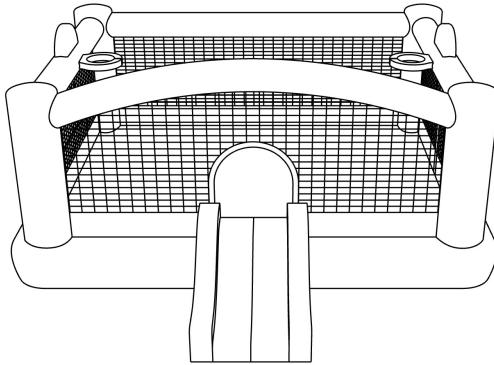

NEED HELP? CONTACT US!

Have product questions? Need technical support? Please feel free to contact us:

Technical Support and E-Warranty Certificate
www.vevor.com/support

This is the original instruction, please read all manual instructions carefully before operating. VEVOR reserves a clear interpretation of our user manual. The appearance of the product shall be subject to the product you received. Please forgive us that we won't inform you again if there are any technology or software updates on our product.

Inflatable Bouncer

Owner's manual
Ages: 3-10 years

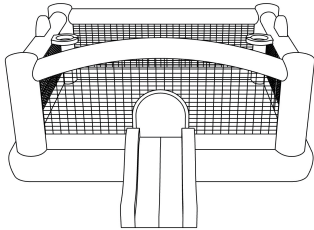

457*447*205CM
Approximate Size Inflated

⚠ WARNING: FAILURE TO FOLLOW THESE INSTRUCTIONS COULD RESULT IN SERIOUS INJURY OR DEATH.

Do not use extension cords with this product. Outdoor use only.
Read all instructions before assembling this inflatable device. Keep instructions for future use.

⚠ WARNING: USERS MUST BE CAREFUL A BOUNCY ORIENTATION WITH REGARD TO THE SUN. The sliding surface should not be located facing the sun as it can dazzle children when using the bouncy.

PART LIST FOR USA

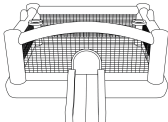

A). 1 Inflatable Bouncer



B). 1 Carry Bag



C). 8 Bouncer Stakes

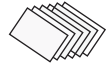

D). 6 Repair Patches



E). 2 Inflatable Balls



F). 6 Dart target balls



G). 1 Blower



H). 2 Blower Stakes

PART LIST FOR EU OR AUS

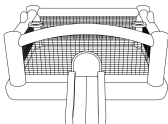

A). 1 Inflatable Bouncer



B). 1 Carry Bag



C). 8 Bouncer Stakes



D). 6 Repair Patches



E). 2 Inflatable Balls



F). 6 Dart target balls



G). 1 Blower



H). 4 Blower Stakes

⚠️ SAFETY WARNINGS: SET UP

ADULT SUPERVISION AND SETUP REQUIRED. This product should be inflated or deflated only by a competent adult. Follow all instructions provided.

WARNING! Falls onto hard surfaces can result in head or other serious injuries. Never place on concrete, asphalt, wood, packed earth, or other hard surfaces. Carpet over hard floors may not prevent injury.

- ⚠️ **WARNING! Only for domestic use.** Intended for outdoor domestic family use only. Not for use in public areas or as a rental.
- Product is heavy. Use caution when lifting.
- Product should never be dragged across concrete, pavement or other rough surfaces.
- **WARNING!** Keep away from fire. Keep fabric clear of all flame and ignition sources.
- Do not set up in windy or rainy conditions: sudden gusts of wind may lift the product off the ground.
- Product can be installed in any orientation in relation to the sun, since there are no metal components or surfaces that can absorb excessive solar radiation.
- Set-up in outdoor location only that meets the following criteria:
 - Place on level ground and firm grass or soil to allow proper use of stakes.
 - Placing on slanted or uneven surfaces may cause the product to tip.
 - Stakes should be placed at an angle for better anchorage, should be driven under the ground to prevent tripping.
 - Minimum clearance zones: Place at least 2m away from any other objects.
 - Objects to be avoided include but are not limited to fences, buildings, trees, overhead branches, laundry lines, electrical wires, walls, or bodies or sources of water.
 - Make sure the area around the product is secure by adding safety barriers, if necessary, to keep young children and pets from gaining access.
 - Electrical cord must not be passed under the air filled devices (Inflatable Bouncer with Slide) and interfere with its operation.
- The Bouncer with Slide uses a main powered blower (air pump) to maintain pressure, only to be used by an adult.
- Do not use extension cords with this product. Set up as close to power source as possible. The blower should be securely anchored to the ground before use.
- **CAUTION:** the blower is capable of moving large volumes of air very quickly. Place the blower in an area where it will not draw in dirt or leaves. Keep blower and power cord away from children, water and traffic.
- **ATTENTION:** Blower should remain on and continuously inflate Water Park during use. Airflow through seams is normal
- Do not use the product if wind speed exceeds 30km/h.
- Do not consume food, drink and gum on this product.

Minimum Clearance Zones

MINIMUM CLEARANCE ZONES

Make sure that there is a 2m obstacle-free zone around the product, including a fence, garage, house, overhanging branches, laundry lines or electrical wires.

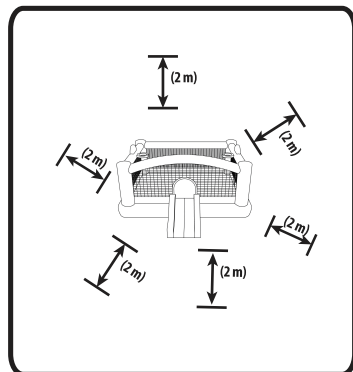

Bouncer Placement

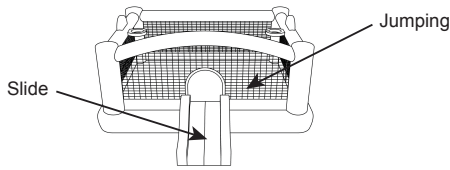

Designate a flat, level surface that allows for 2m of minimum clearance around the Bouncer .

NOTE: DO NOT place the Bouncer with slide on a hard surface like asphalt, concrete or packed earth as both serious bodily injury and damage to the Bounce could result.

ASSEMBLY AREAS

- Make sure the assembly area is flat and level and is free of rocks, sharp objects or other obstructions.
- Do not set up the Bounce on a slope or incline.
- Do not set up the Bounce on hard-packed earth, asphalt, decking or any hard surface as doing so may result in physical injury and/or damage to the Bouncer .
- Once the Bounce inflated or filled with water, do not attempt to drag it to another location.
- Check your local county or city regulations for requirements on securing the pool.
- Secure the pool from unauthorized use.

SAFETY WARNINGS: FAILURE TO FOLLOW THESE INSTRUCTIONS COULD RESULT IN SERIOUS INJURY OR DEATH.



Maximum number of children: 5



Age Limit: 3-10



Total weight limit on slide and pool: 225 kg



Maximum individual height: 5 Ft. (152 cm)



Adult supervision required. Do not leave children unattended.



No sharp objects.



No shoes, no glasses.



No flipping.



Do not slide head first.



No wrestling.



Individual weight limit: 45 kg.



No hands or feet on net.



Do not use in windy conditions.



Do not leave out in rain.



Stay away from blowers and electrical cords.



Must be anchored using stakes.

• Constant, competent adult supervision of children and other young users is required at all times.

- Keep the area around the product clean, and clear of objects, to prevent slips and falls.
- Do not allow children to play in the product until it is fully inflated.
- Do not allow children to play on if wet. Thoroughly dry before use.
- This is not an aquatic toy. It is not to be used in water.
- Instruct children on proper use of this product:
 - Children should not wear loose or baggy clothing, scarves, hoods or clothing with drawstrings or long cords while playing on this product.
 - Children must remove helmets, headgear, shoes and glasses, as well as any sharp objects from their pockets, as they may puncture the bouncing surface.
 - Toys and other objects should never be allowed inside the bouncer.
- Instruct children not to attach items to the product that are not specifically designed for use with the equipment, such as but not limited to, jump ropes, clothesline, pet leashes, cables and chains as they may cause a strangulation hazard.
- Keep pets away from product.
- Children should bounce away from others, and stay away from openings and side walls.

- Children should not jump onto or off the product.
 - Total weight of children must not exceed 500 lbs. (225 kg) No more than 5 children should play on the Bouncer at the same time.
 - Do not allow children to play together who are unevenly matched in weight and height.
 - Before and during use, check for air loss. Check blower is properly connected.
 - Always check the product and all its anchorage points before and during use, and to re-secure as appropriate.
 - After inflation, the blower should run continuously while children are playing.
 - Check to ensure no user is on the product before deflating.
 - Always deflate product after use, and store indoors.
 - To be used on soft ground only.
 - Users must be discouraged from attempting any unauthorized modification.
- The product should be periodically examined for potentially unsafe conditions such as: damaged cord, plug, housing, or parts, and that in the event such damage is found, the product should not be used until properly repaired. Never leave the fan outside in the rain or elements when not in use. Refer to the instructions for set-up, storage, maintenance and care.

Staking the Bouncer

△CAUTIONS: **The Bouncer and all its anchorage points should be checked before and during use. Reinflate or re-secure as appropriate. DO NOT let children play on the bouncer until it is fully inflated!**

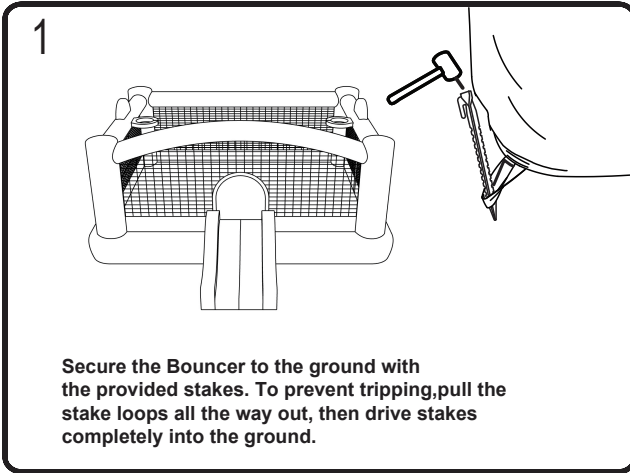

△ BOUNCER CAUTIONS:

- Drive ground stakes completely into the ground to avoid tripping hazard.
- Please do not use the Bouncer until it is properly assembled, anchored into the ground, and fully inflated. Competent adults should finish all assembly steps.
- Do not set up or inflate the Bouncer with SLide in windy and/or rainy conditions as wind gusts may cause the park to become unstable and possibly be lifted from the ground.

Set Up

- 1 Remove Water park from its packaging



2



Unroll and unfold the Water park in the center of the designated area.

3

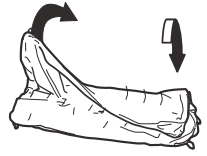

4

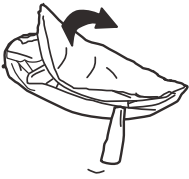

5



6

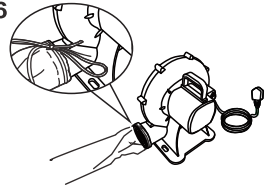

7

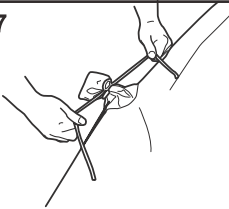

Tie off the short Air Outlet Tube tightly to make a good seal.

8

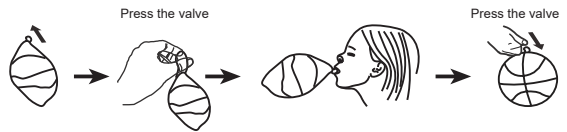

Inflate the inflatable basketball and inflatable football by mouth and then press the blow hole flat.

INFLATION & STAKING

Secure the bouncer to the ground with the provided stakes. To prevent tripping, pull the stake loops all the way out, then drive stakes completely into the ground.

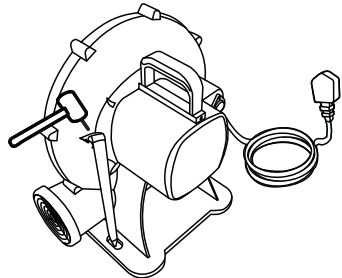
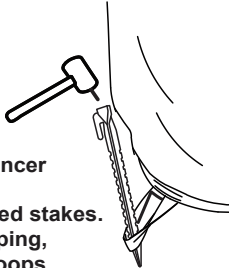

STORAGE

- 1 Turn off the air pump and motor, then unplug it from the outlet.

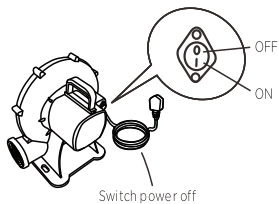

- 2 Untie the drawstring from the short Outlet Tube and allow the bouncer with slide to fully deflate. Remove the Hose Assembly and wrap it up with no kinks.



3

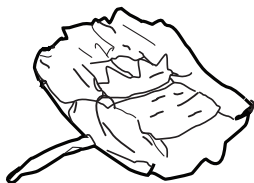

4

Fold over only



5

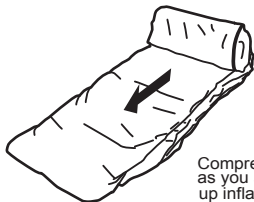

Compress air out
as you are rolling
up inflatable

6

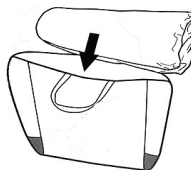

REPAIR PATCH INSTRUCTIONS



**WARNING: Repair patches must be applied by adults only.
KEEP OUT OF REACH OF CHILDREN.**

INSTRUCTION:

1. Deflate the item, clean the area and allow to dry thoroughly.
2. Cut a portion of the patch to the size needed and round the corners. (See Fig).
3. Remove the adhesive backing from the patch material, position the patch over the damaged area and smooth out any bubbles.
4. Allow to sit for 30 minutes before re-inflating.

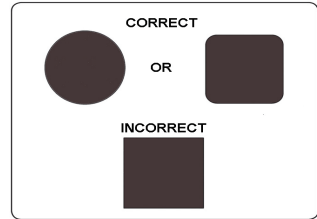

INSTRUCTIONS FOR BLOWER MAINTENANCE

INSTRUCTIONS FOR BOUNCER MAINTENANCE

- As an outdoor product, the bouncer is subject to wear and deterioration. Inspect for signs of fabric failure; weak or torn surfaces must be repaired promptly.
- To keep the product clean: wipe the bouncer or blower using a dry cloth or a cloth dampened with a neutral, non-inflammable, nontoxic cleaning and sanitizing solution or pure water.
- Product should never be stored wet. Allow to dry before rolling up.

- Blower must be unplugged before servicing.
- If the supply cord is damaged, it must be replaced by qualified persons in order to avoid a hazard.
- Product should be periodically examined for potentially unsafe conditions such as damaged cord, plug, housing, or parts, and that in the event such damage is found, the product should not be used until properly repaired. If these checks are not carried out, the product could overturn or otherwise become a hazard.
- The blower does not require any lubrication and has no user serviceable parts. Do not attempt to service the blower.
- Do not immerse the fan in water. To clean, wipe with a damp cloth.
- Regularly check the intake and output openings and keep free of dirt, leaves, etc.
- When not in use, store the blower indoors in a dry place.
- Store the blower upright on a stable surface.
- Loosely coil the cord and place it beside the blower.
- When in use, do not place the cord across traffic areas, water or damp areas.
- The blower is a high volume blower, and is capable of moving large volumes of air very quickly. Place the blower in an area where it will not draw in dirt or leaves.

CORRECT DISPOSAL



'Let's care for the environment!'

The wheeled bin symbol indicates that the product must not be disposed of with other household waste. Please use designated collection points or recycling facilities when disposing of the item.

Please keep this manual as it contains important information.

Address: Baoshanqu Shuangchenglu 803long 11hao 1602A-1609shi
Shanghai

Imported to AUS: SIHAO PTY LTD, 1 ROKEVA STREETEASTWOOD
NSW 2122 Australia

Imported to USA: Sanven Technology Ltd, Suite 250, 9166 Anaheim
Place, Rancho Cucamonga, CA 91730



SHUNSHUN GmbH
Römeräcker 9 Z2021, 76351
Linkenheim-Hochstetten, Germany



Pooledas Group Ltd
Unit 5 Albert Edward House, The
Pavilions Preston, United Kingdom

VEVOR[®]

TOUGH TOOLS, HALF PRICE

Technical Support and E-Warranty Certificate

www.vevor.com/support

VEVOR®

TOUGH TOOLS, HALF PRICE

Wsparcie techniczne i certyfikat e-gwarancji

www.vevor.com/support

Dmuchany bramkarz

MODEL:PL2464

Nadal dokładamy wszelkich starań, aby zapewnić Państwu narzędzia w konkurencyjnej cenie.

„Zaoszczędź o połowę”, „o połowę ceny” lub inne podobne wyrażenia używane przez nas przedstawiają jedynie szacunkową oszczędność, jaką możesz zyskać kupując u nas określone narzędzia w porównaniu z głównymi najlepszymi markami i niekoniecznie oznaczają uwzględnienie wszystkich kategorii oferowanych narzędzi przez nas. Przypominamy, aby podczas składania zamówienia u nas dokładnie sprawdzić, czy faktycznie oszczędzasz połowę w porównaniu z czołowymi markami.

VEVOR[®]
TOUGH TOOLS, HALF PRICE

Dmuchany bramkarz

MODEL:PL2464

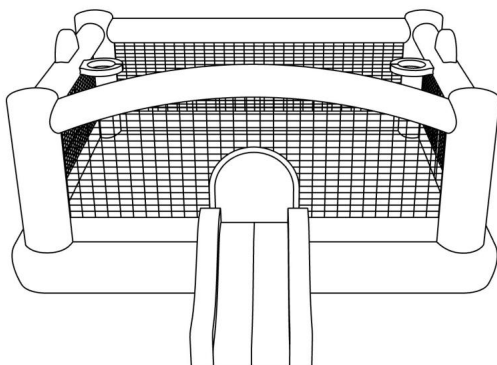

POTRZEBUJĘ POMOCY? SKONTAKTUJ SIĘ Z NAMI!

Masz pytania dotyczące produktu? Potrzebujesz wsparcia technicznego? Prosimy o kontakt:
Wsparcie

techniczne i certyfikat e-gwarancji www.vevor.com/support

To jest oryginalna instrukcja. Przed przystąpieniem do obsługi prosimy o dokładne zapoznanie się ze wszystkimi instrukcjami. VEVOR zastrzega sobie jasną interpretację naszej instrukcji obsługi. Wygląd produktu zależy od produktu, który otrzymałeś. Proszę wybaczyć nam, że nie będziemy ponownie informować Państwa, jeśli pojawią się jakieś aktualizacje technologii lub oprogramowania naszego produktu.

Nadmuchiwany bramkarz

Instrukcja obsługi

Wiek: 3-10 lat

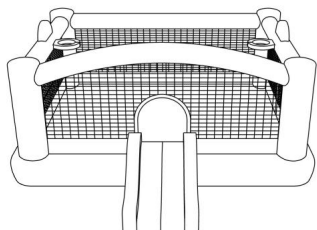

457*447*205CM

Przybliżony rozmiar napompowany



OSTRZEŻENIE: NIEPRZESTRZEGANIE TYCH INSTRUKCJI MOŻE SPOWODOWAĆ POWAŻNE OBRAŻENIA LUB ŚMIERĆ.

Nie używaj przedłużaczy z tym produktem. Tylko do użytku na zewnątrz.

Przed montażem tego nadmuchiwanego urządzenia przeczytaj wszystkie instrukcje. Zachowaj instrukcję do wykorzystania w przyszłości.



OSTRZEŻENIE: UŻYTKOWNICY MUSZĄ ZACHOWAĆ OSTROŻNĄ ORIENTACJĘ BUTELKI W ODNIESIENIU DO SŁOŃCA. Powierzchnia ślizgowa nie powinna być skierowana w stronę słońca, gdyż może to oślepić dzieci podczas korzystania ze skakanki.

LISTA CZĘŚCI DLA USA

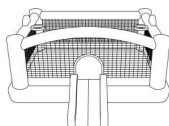

A). 1 nadmuchiwany bramkarz



B). 1 torba transportowa



C). 8 wkł bramkarzy



D). 6 latek naprawczych



M). 2 nadmuchiwane piłki



F). 6 piłek do rzutek



G). 1 dmuchawa



H). 2 kolki dmuchawy

LISTA CZĘŚCI DLA UE LUB AUS

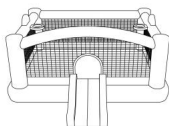

A). 1 nadmuchiwany bramkarz



B). 1 torba transportowa



C). 8 wkł bramkarzy

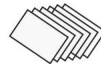

D). 6 latek naprawczych



M). 2 nadmuchiwane piłki



F). 6 piłek do rzutek



G). 1 dmuchawa



H). 4 kolki dmuchawy

⚠ SAFETY WARNINGS: SET UP

ADULT SUPERVISION AND SETUP REQUIRED. This product should be inflated or deflated only by a competent adult. Follow all instructions provided.

WARNING! Falls onto hard surfaces can result in head or other serious injuries. Never place on concrete, asphalt, wood, packed earth, or other hard surfaces. Carpet over hard floors may not prevent injury.

- ⚠ **WARNING! Only for domestic use.** Intended for outdoor domestic family use only. Not for use in public areas or as a rental.
- Product is heavy. Use caution when lifting.
- Product should never be dragged across concrete, pavement or other rough surfaces.
- **WARNING!** Keep away from fire. Keep fabric clear of all flame and ignition sources.
- Do not set up in windy or rainy conditions: sudden gusts of wind may lift the product off the ground.
- Product can be installed in any orientation in relation to the sun, since there are no metal components or surfaces that can absorb excessive solar radiation.
- Set-up in outdoor location only that meets the following criteria:
 - Place on level ground and firm grass or soil to allow proper use of stakes.
 - Placing on slanted or uneven surfaces may cause the product to tip.
 - Stakes should be placed at an angle for better anchorage, should be driven under the ground to prevent tripping.
 - Minimum clearance zones: Place at least 2m away from any other objects.
 - Objects to be avoided include but are not limited to fences, buildings, trees, overhead branches, laundry lines, electrical wires, walls, or bodies or sources of water.
 - Make sure the area around the product is secure by adding safety barriers, if necessary, to keep young children and pets from gaining access.
 - Electrical cord must not be passed under the air filled devices (Inflatable Bouncer with Slide) and interfere with its operation.
- The Bouncer with Slide uses a main powered blower (air pump) to maintain pressure, only to be used by an adult.
- Do not use extension cords with this product. Set up as close to power source as possible. The blower should be securely anchored to the ground before use.
- **CAUTION:** the blower is capable of moving large volumes of air very quickly. Place the blower in an area where it will not draw in dirt or leaves. Keep blower and power cord away from children, water and traffic.
- **ATTENTION:** Blower should remain on and continuously inflate Water Park during use. Airflow through seams is normal
- Do not use the product if wind speed exceeds 30km/h.
- Do not consume food, drink and gum on this product.

Minimum Clearance Zones

MINIMUM CLEARANCE ZONES

Make sure that there is a 2m obstacle-free zone around the product, including a fence, garage, house, overhanging branches, laundry lines or electrical wires.

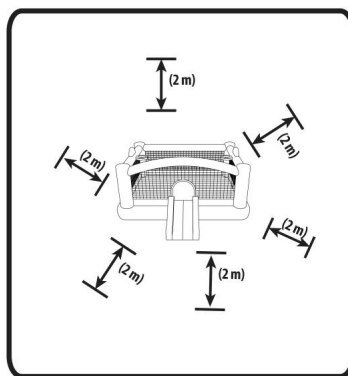

Umieszczenie bramkarza

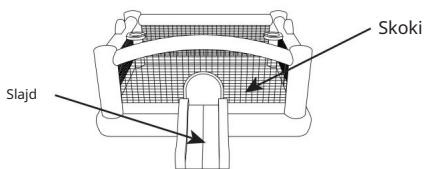

Designate a flat, level surface that allows for 2m of minimum clearance around the Bouncer .

NOTE: DO NOT place the Bouncer with slide on a hard surface like asphalt, concrete or packed earth as both serious bodily injury and damage to the Bounce could result.

ASSEMBLY AREAS

- Make sure the assembly area is flat and level and is free of rocks, sharp objects or other obstructions.
- Do not set up the Bounce on a slope or incline.
- Do not set up the Bounce on hard-packed earth, asphalt, decking or any hard surface as doing so may result in physical injury and/or damage to the Bouncer .
- Once the Bounce inflated or filled with water, do not attempt to drag it to another location.
- Check your local county or city regulations for requirements on securing the pool.
- Secure the pool from unauthorized use.

OSTRZEŻENIA DOTYCZĄCE BEZPIECZEŃSTWA: NIEPRZESTRZEGANIE TYCH INSTRUKCJI MOŻE SPÓWODOWAĆ POWAŻNE OBRAŻENIA LUB ŚMIERĆ.



Maksymalna liczba dzieci: 5



Limit wieku: 3-10



Całkowita waga osoby na zjeździe i basenie: 225 kg



Maksymalna wysokość osób nadzorujących wyjeżdżających. Nie pozostawiaj dzieci o długości 152 cm bez opieki.



Zadnych ostrych przedmiotów. Zadnych butów, zadnych okularów.

Zabiega przemieszczenia.



Nie przesuwaj głowy w kierunku najbliższych. Zadnych zapadów.



Indywidualny limit wagi: 45 kg



Zadnych rąk i nóg na siatce. Nie używaj przy wietrznej pogodzie.



Nie zostawiaj na deszczu.



Trzymaj się z daleka od dmuchaw i przewodów elektrycznych.



Należy zakończyć za pomocą pałków.

• Przez cały czas wymagany jest stały, kompetentny nadzór osoby dorosłej nad dziećmi i innymi młodymi użytkownikami. • Utrzymuj obszar

wokół produktu w czystości i wolny od przedmiotów, aby zapobiec poślizgnięciom i upadkom.

• Nie pozwalaj dzieciom bawić się produktem, dopóki nie zostanie on całkowicie napompowany. • Nie pozwalaj dzieciom bawić się, jeśli są mokre. Przed użyciem dokładnie wysusz. • To nie jest zabawka wodna. Nie należy go używać w wodzie. • Poinstruj dzieci na temat

prawidłowego korzystania z tego produktu: - Dzieci nie powinny nosić luźnej lub

luźnej odzieży, szali, kapturów ani odzieży ze sznurkami lub długimi sznurkami podczas zabawy na tym produkcie.

- Dzieci muszą wyjąć z kieszeni kaski, nakrycia głowy, buty i okulary, a także wszelkie ostre przedmioty, ponieważ mogą przebić obijającą się powierzchnię.

- Nigdy nie należy wpuszczać zabawek i innych przedmiotów do leżaczka.

- Poinstruj dzieci, aby nie mocowały do produktu przedmiotów, które nie są specjalnie przeznaczone do użytku z tym sprzętem, takich jak między innymi skakaniki, sznury do bielizny, smycze dla zwierząt, kable i łańcuchy, ponieważ mogą one powodować ryzyko uderzenia.

- Trzymać zwierzęta z dala od produktu.

- Dzieci powinny odbić się od innych i trzymać się z daleka od otworów i ścian bocznych.

- Dzieci nie powinny wskakiwać na produkt ani z niego schodzić.

- Całkowita waga dzieci nie może przekraczać 500 funtów. (225 kg) Na leżaczku nie powinno bawić się jednocześnie więcej niż 5 dzieci.

- Nie pozwalaj na wspólną zabawę dzieciom, które mają różną wagę i wzrost. • Przed i w trakcie użytkowania należy

sprawdzić, czy nie ulatnia się powietrze. Sprawdź, czy dmuchawa jest prawidłowo podłączona. • Zawsze

sprawdzaj produkt i wszystkie jego punkty mocowania przed i w trakcie użytkowania oraz

w razie potrzeby ponownie je zabezpiecz. • Po

napompieniu dmuchawa powinna pracować nieprzerwanie podczas zabawy dzieci. • Przed

produkcie. spuszczeniem powietrza upewnij się, że na produkcie nie przebywa żaden

użytkownik. • Po użyciu zawsze spuść powietrze z produktu i przechowuj

go w pomieszczeniu. • Do użytku wyłącznie

na miękkim podłożu. • Należy odradzać użytkownikom podejmowanie prób nieautoryzowanych modyfikacji.

Produkt należy okresowo sprawdzać pod kątem potencjalnie niebezpiecznych warunków,

takich jak uszkodzony przewód, wtyczka, obudowa lub części i w przypadku stwierdzenia

takich uszkodzeń produktu nie należy używać do czasu odpowiedniej naprawy. Nigdy nie

zostawiaj wentylatora na zewnątrz, na deszczu lub w trudnych warunkach

atmosferycznych, gdy nie jest używany. Zapoznaj się z instrukcjami dotyczącymi konfiguracji,

przechowywania, konserwacji i pielęgnacji.

Stawianie bramkarza

⚠ PRZESTROGI: Leżaczek i wszystkie jego punkty mocowania należy sprawdzać przed i w trakcie użytkowania.

W razie potrzeby ponownie napompuj lub zabezpiecz. NIE pozwalaj dzieciom bawić się na leżaczkach, dopóki nie zostanie on całkowicie napompowany!

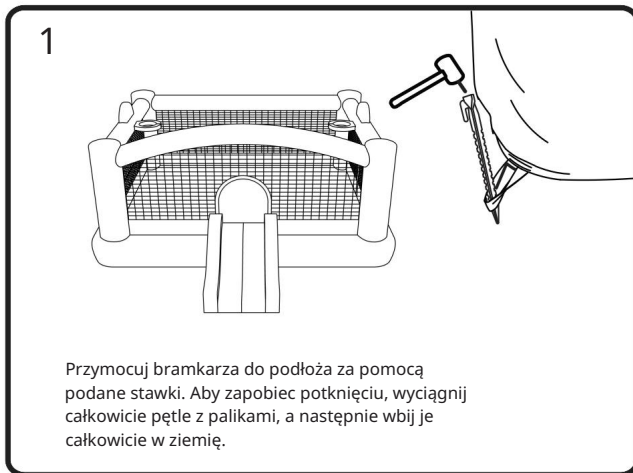

⚠ OSTRZEŻENIA BUNDERÓW:

- Wbij całkowicie kołki uziemiające uziemić, aby uniknąć ryzyka potknięcia się.
- Nie używaj leżaczka, dopóki nie zostanie on prawidłowo zmontowany, zakotwiczony w podłożu i całkowicie napompowany. Kompetentni dorośli powinni zakończyć wszystkie etapy montażu.
- Nie ustawiaj ani nie nadmuchuj leżaczka z SLide w wietrzną i/lub deszczową pogodę podmuchy wiatru mogą spowodować, że park stanie się niestabilny i prawdopodobnie uniesie się nad ziemię.

1 Remove Water park from its packaging



2



Unroll and unfold the Water park in the center of the designated area.

3

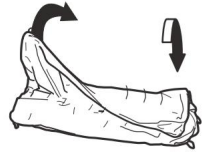

4

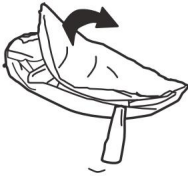

5



6

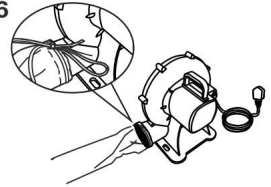

7

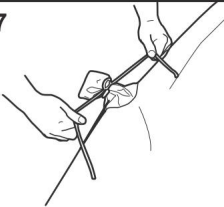

Tie off the short Air Outlet Tube tightly to make a good seal.

8

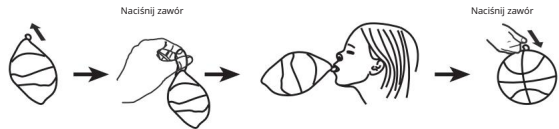

Napompuj nadmuchiwaną koszykówkę i nadmuchiwaną piłkę nożną ustami, a następnie naciśnij płasko otwór wydmuchowy.

INFLACJA I STAWKI

Przymocuj bramkarza do podłoża za pomocą dostarczonych kołków. Aby zapobiec potknięciom, następnie całkowicie wyciągnij pętlę palików całkowicie kierować stawkami w ziemię.

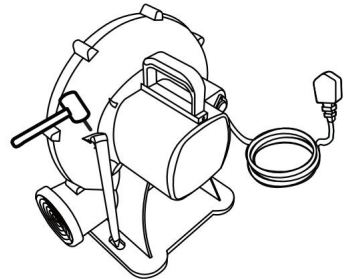
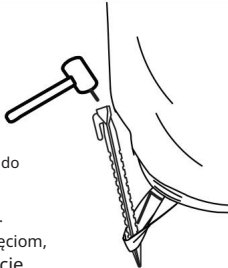

SKŁADOWANIE

- 1 Turn off the air pump and motor, then unplug it from the outlet.

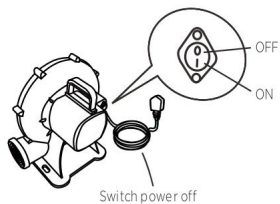

- 2 Untie the drawstring from the short Outlet Tube and allow the bouncer with slide to fully deflate. Remove the Hose Assembly and wrap it up with no kinks.



3

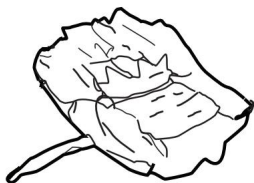

4

Tylko złoż



5



Sprężaj powietrze podczas zwijania nadmuchiwanego materaca

6

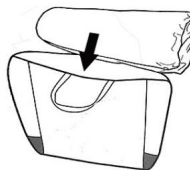

INSTRUKCJE NAPRAWY



OSTRZEŻENIE: Łatki naprawcze mogą nakładać wyłącznie osoby dorosłe.

TRZYMAĆ POZA ZASIĘGIEM DZIECI.

INSTRUKCJA:

1. Opróżnij przedmiot, wyczyść obszar i pozostaw do całkowitego wyschnięcia.
2. Przytnij fragment plastra do wymaganego rozmiaru i zaokrąglij rogi. (Patrz rys.).
3. Usuń warstwę samoprzylepną z materiał łatki, umieść plaster na uszkodzonym obszarze i wygładź ewentualne pęcherzyki.
4. Pozostaw na 30 minut przed ponownym nadmuchianiem.

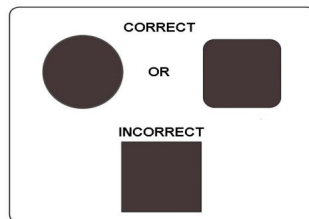

INSTRUKCJE DLA BUNCERA KONSERWACJA

- Leżacek, jako produkt przeznaczony do użytku na zewnątrz, podlega zużyciu i zniszczeniu. Sprawdź pod kątem oznak uszkodzenia tkaniny; słabe lub podarte powierzchnie należy natychmiast naprawić.
- Aby utrzymać produkt w czystości: wytrzyj leżacek lub dmuchawę suchą szmatką lub szmatką zwilżoną neutralnym, niepalnym, nietoksycznym roztworem czyszczącym i odkażającym lub czystą wodą.
- Produktu nigdy nie należy przechowywać w stanie mokrym. Pozostawić do wyschnięcia przed zwinięciem.

INSTRUKCJE DLA KONSERWACJA DMUCHAWY

- Przed przystąpieniem do serwisowania dmuchawę należy odłączyć od prądu.
- Jeśli przewód zasilający jest uszkodzony, musi on zostać wymieniony przez wykwalifikowaną osobę, aby uniknąć zagrożenia
- Produkt należy okresowo sprawdzać pod kątem potencjalnie niebezpiecznych warunków, takich jak uszkodzony przewód, wtyczka, obudowa lub części, a w przypadku wykrycia takich uszkodzeń, produktu nie należy używać do czasu odpowiedniej naprawy. Jeśli te kontrole nie zostaną przeprowadzone, produkt może się przewrócić lub w inny sposób stać się zagrożeniem.
- Dmuchawa nie wymaga smarowania i nie posiada części przeznaczone do serwisowania przez użytkownika. Nie próbuj serwisować dmuchawy.
- Nie zanurzaj wentylatora w wodzie. Aby wyczyścić, przetrzyj wilgotną szmatką.
- Regularnie sprawdzaj otwory wlotowe i wylotowe i usuwaj brud, liście itp.
- Gdy nie używasz dmuchawy, przechowuj ją w suchym miejscu.
- Przechowuj dmuchawę w pozycji pionowej, na stabilnej powierzchni.
- Luźno zwin przewód i umieść go obok dmuchawy.
- Podczas użytkowania nie należy umieszczać przewodu w miejscach o ruchu kołowym, wodzie lub wilgotnych miejscach.
- Dmuchawa jest dmuchawą o dużej wydajności i ma takie możliwości bardzo szybko przemieszcza duże ilości powietrza. Umieść dmuchawę w miejscu, w którym nie będzie wciągać brudu ani liści.

PROWREOWAUSPZSQA



„Dbajmy o środowisko!” Symbol kosza na kółkach wskazuje, że produktu nie wolno wyrzucać razem z innymi odpadami domowymi. Podczas utylizacji produktu należy korzystać z wyznaczonych punktów zbiórki lub zakładów zajmujących się recyklingiem.

Prosimy o zachowanie niniejszej instrukcji, ponieważ zawiera ona ważne informacje.

Adres: Baoshanqu Shuangchenglu 803long 11hao 1602A-1609shi
Szanghaj

Import do AUS: SIHAO PTY LTD, 1 ROKEVA STREETEASTWOOD

Nowa Południowa Walia 2122 Australia

Import do USA: Sanven Technology Ltd, Suite 250, 9166 Anaheim
Place, Rancho Cucamonga, Kalifornia 91730

REPREZENT KE	
--------------	--

SHUNSHUN GmbH

Römeräcker 9 Z2021, 76351

Linkenheim-Hochstetten, Niemcy

REPUBLIKA Wielkiej Brytanii	
-----------------------------	--

Pooledas Group Ltd

Jednostka 5 Albert Edward House, The

Pawilony Preston, Wielka Brytania

VEVOR[®]

TOUGH TOOLS, HALF PRICE

Wsparcie techniczne i certyfikat e-gwarancji

www.vevor.com/support

VEVOR[®]

TOUGH TOOLS, HALF PRICE

Technischer Support und E-Garantiezertifikat

www.vevor.com/support

AUFBLASBARER Hüpfer

MODELL:PL2464

Wir sind weiterhin bestrebt, Ihnen Werkzeuge zu wettbewerbsfähigen Preisen anzubieten.

„Sparen Sie die Hälfte“, „Halber Preis“ oder andere ähnliche von uns verwendete Ausdrücke stellen lediglich eine Schätzung der Einsparungen dar, die Sie durch den Kauf bestimmter Werkzeuge bei uns im Vergleich zu den großen Top-Marken erzielen könnten, und bedeuten nicht unbedingt, dass alle angebotenen Werkzeugkategorien abgedeckt werden von uns. Bitte prüfen Sie bei Ihrer Bestellung sorgfältig, ob Sie im Vergleich zu den Top-Marken tatsächlich die Hälfte sparen.

VEVOR[®]
TOUGH TOOLS, HALF PRICE

AUFBLASBARER Hüpfper

MODELL:PL2464

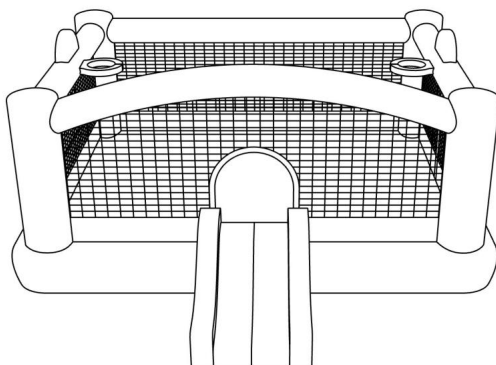

BRAUCHEN SIE HILFE? KONTAKTIERE UNS!

Haben Sie Fragen zum Produkt? Benötigen Sie technische Unterstützung? Bitte kontaktieren Sie uns:

Technischer Support und E-Garanzertifikat www.vevor.com/support

Dies ist die Originalanleitung. Bitte lesen Sie alle Bedienungsanleitungen sorgfältig durch, bevor Sie das Gerät in Betrieb nehmen. VEVOR behält sich eine klare Auslegung unserer Bedienungsanleitung vor. Das Aussehen des Produkts hängt von dem Produkt ab, das Sie erhalten haben. Bitte entschuldigen Sie, dass wir Sie nicht erneut informieren, wenn es zu unserem Produkt technische oder Software-Updates gibt.

Aufblasbarer Türstehler

Bedienungsanleitung

Alter: 3–10 Jahre

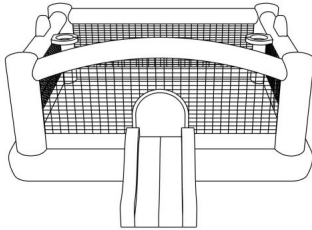

457*447*205CM
Ungefähre Größe aufgeblasen



WARNUNG: DIE NICHTBEACHTUNG DIESER ANWEISUNGEN KANN ZU SCHWEREN VERLETZUNGEN ODER ZUM TOD FÜHREN.

Verwenden Sie für dieses Produkt keine Verlängerungskabel. Nur zur Verwendung im Freien.

Lesen Sie alle Anweisungen, bevor Sie dieses aufblasbare Gerät zusammenbauen. Bewahren Sie die Anleitung für den späteren Gebrauch auf.



WARNUNG: BENUTZER MÜSSEN AUF EINE AUSRICHTUNG DES Hüpfkissens IN BEZUG AUF DIE SONNE achten. Die Rutschfläche sollte nicht der Sonne zugewandt sein, da sie Kinder bei der Verwendung des Hüpfkissens blenden kann.

TEILELISTE FÜR USA

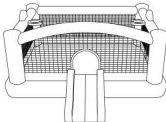

A). 1 aufblasbarer Hüpfel



B). 1 Tragetasche



C). Bürsthereinsätze



D). 6 Reparaturflücken



E). 2 aufblasbare Bälle



F). 6 Dart-Zielbälle



G). 1 Gebläse



H). 2 Gebläseeinsätze

TEILELISTE FÜR EU ODER AUS

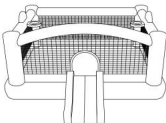

A). 1 aufblasbarer Hüpfel



B). 1 Tragetasche



C). Bürsthereinsätze



D). 6 Reparaturflücken



E). 2 aufblasbare Bälle



F). 6 Dart-Zielbälle



G). 1 Gebläse



H). 4 Gebläseeinsätze

⚠️ SAFETY WARNINGS: SET UP

ADULT SUPERVISION AND SETUP REQUIRED. This product should be inflated or deflated only by a competent adult. Follow all instructions provided.

WARNING! Falls onto hard surfaces can result in head or other serious injuries. Never place on concrete, asphalt, wood, packed earth, or other hard surfaces. Carpet over hard floors may not prevent injury.

- ⚠️ **WARNING! Only for domestic use.** Intended for outdoor domestic family use only. Not for use in public areas or as a rental.
- Product is heavy. Use caution when lifting.
- Product should never be dragged across concrete, pavement or other rough surfaces.
- **WARNING!** Keep away from fire. Keep fabric clear of all flame and ignition sources.
- Do not set up in windy or rainy conditions: sudden gusts of wind may lift the product off the ground.
- Product can be installed in any orientation in relation to the sun, since there are no metal components or surfaces that can absorb excessive solar radiation.
- Set-up in outdoor location only that meets the following criteria:
 - Place on level ground and firm grass or soil to allow proper use of stakes.
 - Placing on slanted or uneven surfaces may cause the product to tip.
 - Stakes should be placed at an angle for better anchorage, should be driven under the ground to prevent tripping.
 - Minimum clearance zones: Place at least 2m away from any other objects.
 - Objects to be avoided include but are not limited to fences, buildings, trees, overhead branches, laundry lines, electrical wires, walls, or bodies or sources of water.
 - Make sure the area around the product is secure by adding safety barriers, if necessary, to keep young children and pets from gaining access.
 - Electrical cord must not be passed under the air filled devices (Inflatable Bouncer with Slide) and interfere with its operation.
- The Bouncer with Slide uses a main powered blower (air pump) to maintain pressure, only to be used by an adult.
- Do not use extension cords with this product. Set up as close to power source as possible. The blower should be securely anchored to the ground before use.
- **CAUTION:** the blower is capable of moving large volumes of air very quickly. Place the blower in an area where it will not draw in dirt or leaves. Keep blower and power cord away from children, water and traffic.
- **ATTENTION:** Blower should remain on and continuously inflate Water Park during use. Airflow through seams is normal
- Do not use the product if wind speed exceeds 30km/h.
- Do not consume food, drink and gum on this product.

Minimum Clearance Zones

MINIMUM CLEARANCE ZONES

Make sure that there is a 2m obstacle-free zone around the product, including a fence, garage, house, overhanging branches, laundry lines or electrical wires.

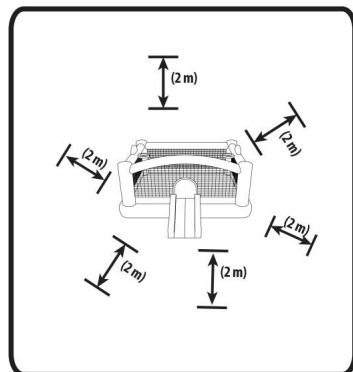

Platzierung des Türstehers

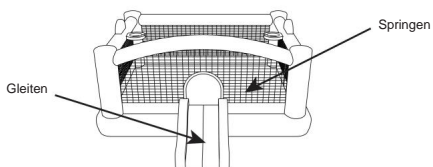

Designate a flat, level surface that allows for 2m of minimum clearance around the Bouncer .

NOTE: DO NOT place the Bouncer with slide on a hard surface like asphalt, concrete or packed earth as both serious bodily injury and damage to the Bounce could result.

ASSEMBLY AREAS

- Make sure the assembly area is flat and level and is free of rocks, sharp objects or other obstructions.
- Do not set up the Bounce on a slope or incline.
- Do not set up the Bounce on hard-packed earth, asphalt, decking or any hard surface as doing so may result in physical injury and/or damage to the Bouncer .
- Once the Bounce inflated or filled with water, do not attempt to drag it to another location.
- Check your local county or city regulations for requirements on securing the pool.
- Secure the pool from unauthorized use.

SICHERHEITSHINWEISE: DIE NICHTBEACHTUNG DIESER ANWEISUNGEN KANN ZU SCHWEREN VERLETZUNGEN ODER ZUM TOD FÜHREN.



Maximale Anzahl Kinder: 5



Altersgrenzen: 3-10



Gesamtgewichtsbeschränkung
für Rutsche und Becken:
225 kg



Maximale individuelle Körpergröße¹⁾ unter Aufsicht eines
Erwachsenen: erforderlich. Lassen Sie Kinder mit einer
Körpergröße von 5 Fuß (152 cm) nicht unbeaufsichtigt.



Keine scharfen Gegenstände. Keine Schuhe, keine Brillen.



Kein Landstehen.



Nicht mit dem Kopf voran schieben. Kein Ringen.



Individuelle
Gewichtsbeschränkung: 45 kg.



Keine Hände oder Füße im Netz. Nicht bei Wind verwenden.



Nicht im Regen
stehen lassen.



Halten Sie sich von Gebälgen
und Stromkabeln fern



Muss mit Pfählen verankert
werden.

• Eine ständige und kompetente Beaufsichtigung von Kindern und anderen jugendlichen

Benutzern durch Erwachsene ist jederzeit erforderlich.

- Halten Sie den Bereich um das Produkt herum sauber und frei von Gegenständen, um ein Ausrutschen und

Herunterfallen zu verhindern. • Erlauben Sie Kindern nicht, mit dem Produkt zu spielen, bis es vollständig aufgeblasen ist. • Lassen Sie Kinder nicht darauf spielen, wenn es nass ist. Vor Gebrauch gründlich trocknen. • Dies ist kein Wasserspielzeug. Es

darf nicht im Wasser verwendet werden. • Weisen Sie Kinder in

die ordnungsgemäße Verwendung dieses Produkts an: - Kinder sollten beim Spielen mit diesem Produkt keine weite oder weite Kleidung, Schals, Kapuzen oder Kleidung mit Kordelzug oder langen

Kordeln tragen. - Kinder müssen Helme, Kopfbedeckungen, Schuhe und Brillen sowie alle scharfen Gegenstände aus ihren Taschen entfernen, da diese die Sprungfläche beschädigen könnten.

- Spielzeug und andere Gegenstände sollten niemals in der Babywippe gelassen werden.

- Weisen Sie Kinder an, keine Gegenstände am Produkt zu befestigen, die nicht speziell für die Verwendung mit dem Gerät vorgesehen sind, wie z. B. Springselle, Wäscheleinen, Haustierleinen, Kabel und Ketten, da diese eine Strangulationsgefahr darstellen können.

- Halten Sie Haustiere vom Produkt fern.

- Kinder sollten von anderen wegspringen und sich von Öffnungen und Seitenwänden fernhalten.

• Kinder sollten nicht auf das Produkt springen oder davon herunterspringen.

- Das Gesamtgewicht der Kinder darf 500 Pfund nicht überschreiten. (225 kg) Es sollten nicht mehr als 5 Kinder gleichzeitig auf der Babywippe spielen.

- Erlauben Sie nicht, dass Kinder mit unterschiedlichem Gewicht und unterschiedlicher Größe zusammen spielen. • Überprüfen

Sie vor und während des Gebrauchs den Luftverlust. Überprüfen Sie, ob das Gebälge richtig angeschlossen ist. •

Überprüfen Sie das Produkt und alle seine Befestigungspunkte stets vor und während des Gebrauchs

und befestigen Sie es ggf. erneut. • Nach dem Aufblasen sollte das

Gebälge kontinuierlich laufen, während die Kinder spielen. • Stellen Sie sicher, dass sich kein Benutzer auf dem Produkt befindet, bevor Sie die Luft ablassen. • Lassen Sie nach Gebrauch immer die Luft aus dem

Produkt ab und lagern Sie es im Innenbereich. • Nur auf weichem Untergrund

verwenden. • Benutzer müssen davon abgehalten

werden, unbefugte Änderungen vorzunehmen.

Das Produkt sollte regelmäßig auf potenziell unsichere Zustände wie beschädigtes Kabel, Stecker,

Gehäuse oder Teile untersucht werden. Falls ein solcher Schaden festgestellt wird, sollte das Produkt erst nach ordnungsgemäßer Reparatur verwendet werden. Lassen Sie den Ventilator niemals draußen

im Regen oder bei Witterungseinflüssen stehen, wenn er nicht verwendet wird. Beachten Sie die

Anweisungen zur Aufstellung, Lagerung, Wartung und Pflege.

Den Türsteher abstecken

⚠ VORSICHTSHINWEISE: Der Bouncer und alle seine Verankerungspunkte sollten vor und während des Gebrauchs überprüft werden.

Je nach Bedarf erneut aufpumpen oder sichern. Lassen Sie Kinder NICHT auf der Babywippe spielen, bis sie vollständig aufgeblasen ist!

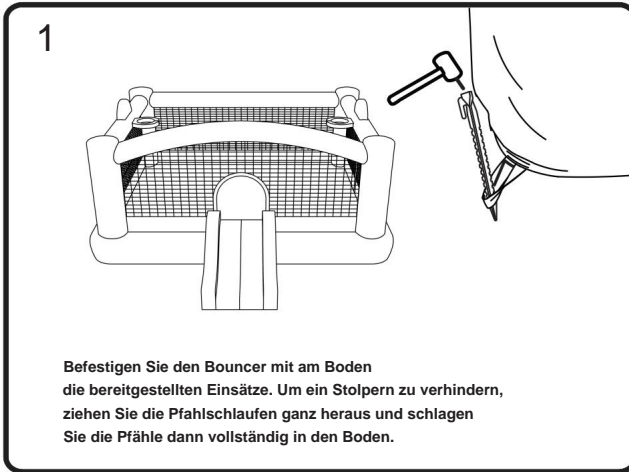

⚠ VORSICHTSHINWEISE FÜR BOUNCER:

- Schlagen Sie die Erdspieße vollständig in das Erdreich ein Boden, um Stolperfallen zu vermeiden.
- Bitte verwenden Sie den Hüpferr erst, wenn er ordnungsgemäß zusammengebaut, im Boden verankert und vollständig aufgeblasen ist. Kompetente Erwachsene sollten alle Montageschritte durchführen.
- Stellen Sie den Bouncer mit SLide nicht bei windigen und/oder regnerischen Bedingungen auf oder blasen Sie ihn nicht auf. Windböen können dazu führen, dass der Park instabil wird und möglicherweise vom Boden abgehoben wird.

Aufstellen

- 1 Remove Water park from its packaging



2



Unroll and unfold the Water park in the center of the designated area.

3

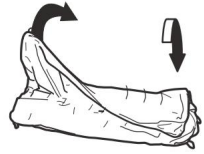

4

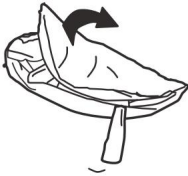

5



6

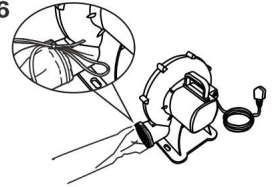

7

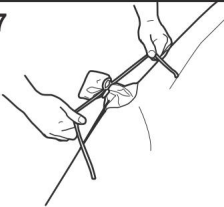

Tie off the short Air Outlet Tube tightly to make a good seal.

8

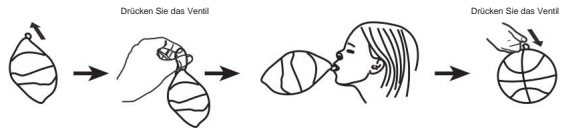

Blasen Sie den aufblasbaren Basketball und den aufblasbaren Fußball mit dem Mund auf und drücken Sie dann das Blasloch flach.

INFLATION & STECKEN

Befestigen Sie den Türsteher mit den mitgelieferten Pflocken am Boden. Um ein Stolpern zu verhindern, Ziehen Sie dann die Pflockschlaufen ganz heraus Treiben Sie die Pfähle vollständig in den Boden.

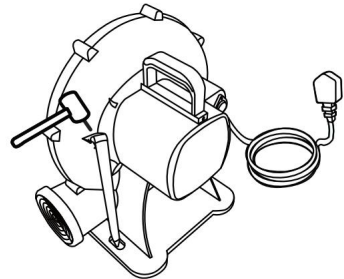
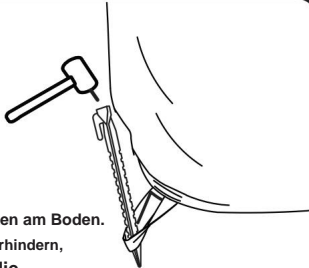

LAGERUNG

- 1 Turn off the air pump and motor, then unplug it from the outlet.

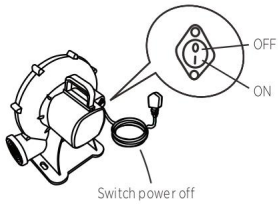

- 2 Untie the drawstring from the short Outlet Tube and allow the bouncer with slide to fully deflate. Remove the Hose Assembly and wrap it up with no kinks.



3



4

Nur umklappen



5



Komprimieren Sie die Luft, während Sie das Schlauchboot aufrollen

6

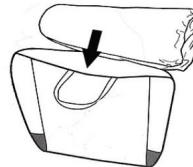

REPARATUR-PATCH-ANLEITUNG



WARNUNG: Reparaturflicken dürfen nur von Erwachsenen angebracht werden. Außerhalb der Reichweite von Kindern aufbewahren.

ANWEISUNG:

1. Lassen Sie die Luft aus dem Gegenstand ab, reinigen Sie den Bereich und lassen Sie ihn gründlich trocknen.
2. Schneiden Sie einen Teil des Flickens auf die benötigte Größe zu und runden Sie die Ecken ab. (Siehe Abbildung).
3. Entfernen Sie die Klebefolie vom Tragen Sie das Flickenmaterial auf, positionieren Sie das Flicken über der beschädigten Stelle und glätten Sie eventuelle Blasen.
4. Vor dem erneuten Aufpumpen 30 Minuten ruhen lassen.

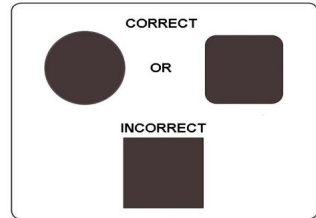

ANLEITUNG FÜR BUNCER WARTUNG

- Da es sich um ein Outdoor-Produkt handelt, unterliegt die Babywippe Verschleiß und Verschleiß. Auf Anzeichen von Stoffversagen prüfen; Schwache oder eingerissene Oberflächen müssen umgehend repariert werden.
- Um das Produkt sauber zu halten: Wischen Sie den Hüpfen oder das Gebläse mit einem trockenen Tuch oder einem Tuch ab, das mit einer neutralen, nicht brennbaren, ungiftigen Reinigungs- und Desinfektionslösung angefeuchtet ist oder reines Wasser.
- Das Produkt sollte niemals nass gelagert werden. Vor dem Aufrollen trocken lassen.

ANWEISUNGEN FÜR GEBLÄSEWARTUNG

- Das Gebläse muss vor Wartungsarbeiten vom Stromnetz getrennt werden.
- Wenn das Netzkabel beschädigt ist, muss es von qualifiziertem Personal ausgetauscht werden, um Gefahren zu vermeiden
- Das Produkt sollte regelmäßig auf potenziell unsichere Zustände wie beschädigtes Kabel, Stecker, Gehäuse oder Teile untersucht werden, und selbst wenn ein solcher Schaden festgestellt wird, muss das Produkt überprüft werden
Das Produkt sollte erst nach ordnungsgemäßer Reparatur verwendet werden. Wenn diese Wenden keine Kontrollen durchgeführt, könnte das Produkt umkippen oder anderweitig zu einer Gefahr werden.
- Das Gebläse benötigt keine Schmierung und hat keine Schmierung
Vor Benutzer zu wartende Teile. Versuchen Sie nicht, das Gebläse zu warten.
- Tauchen Sie den Ventilator nicht in Wasser. Zum Reinigen mit einem feuchten Tuch abwischen.
- Überprüfen Sie regelmäßig die Einlass- und Auslassöffnungen und halten Sie sie frei von Schmutz, Blättern usw.
- Bewahren Sie das Gebläse bei Nichtgebrauch drinnen an einem trockenen Ort auf.
- Lagern Sie das Gebläse aufrecht auf einer stabilen Oberfläche.
- Wickeln Sie das Kabel locker auf und legen Sie es neben das Gebläse.
- Verlegen Sie das Kabel während des Gebrauchs nicht über Verkehrsflächen, Wasser oder feuchte Bereiche.
- Das Gebläse ist ein Hochleistungsgebläse und in der Lage große Luftmengen sehr schnell bewegen. Stellen Sie das Gebläse an einem Ort auf, an dem es keinen Schmutz oder Blätter ansaugt.

RIORREENTSORGUNG



„Lasst uns auf die Umwelt achten!“ Das

Mülltonnensymbol weist darauf hin, dass das Produkt nicht mit dem anderen Hausmüll entsorgt werden darf. Bitte nutzen Sie zur Entsorgung des Artikels die ausgewiesenen Sammelstellen oder Recyclingeinrichtungen.

Bitte bewahren Sie dieses Handbuch auf, da es wichtige Informationen enthält.

Adresse: Baoshanqu Shuangchenglu 803long 11hao 1602A-1609shi
Shanghai

Importiert nach AUS: SIHAO PTY LTD, 1 ROKEVA STREETEASTWOOD
NSW 2122 Australien

In die USA importiert: Sanven Technology Ltd, Suite 250, 9166 Anaheim
Place, Rancho Cucamonga, CA 91730



SHUNSHUN GmbH
Römeräcker 9 Z2021, 76351
Linkenheim-Hochstetten, Deutschland



Pooledas Group Ltd
Einheit 5 Albert Edward House, The
Pavillons Preston, Vereinigtes Königreich

VEVOR[®]

TOUGH TOOLS, HALF PRICE

Technischer Support und E-Garantiezertifikat

www.vevor.com/support

VEVOR[®]

TOUGH TOOLS, HALF PRICE

Assistance technique et certificat de garantie

électronique www.vevor.com/support

SAUTEUR GONFLABLE

MODÈLE:PL2464

Nous continuons à nous engager à vous fournir des outils à des prix compétitifs.

"Économisez la moitié", "Moitié prix" ou toute autre expression similaire que nous utilisons ne représente qu'une estimation des économies dont vous pourriez bénéficier en achetant certains outils chez nous par rapport aux grandes marques et ne signifie pas nécessairement couvrir toutes les catégories d'outils proposés. par nous.

Nous vous rappelons de bien vouloir vérifier attentivement lorsque vous passez une commande chez nous si vous économisez réellement la moitié par rapport aux grandes marques.

MODÈLE:PL2464

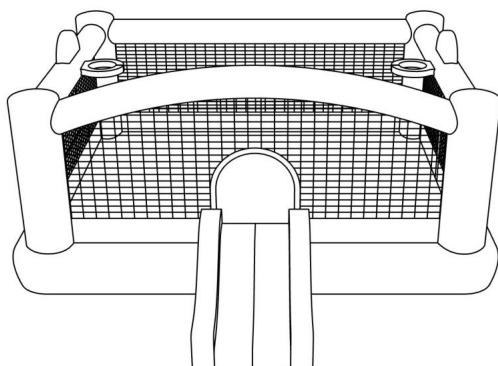

BESOIN D'AIDE? CONTACTEZ-NOUS!

Vous avez des questions sur les produits ? Besoin d'une assistance technique ? N'hésitez pas à nous

contacter : Support technique et certificat de garantie électronique
www.vevor.com/support

Il s'agit des instructions originales, veuillez lire attentivement toutes les instructions du manuel avant de l'utiliser. VEVOR se réserve une interprétation claire de notre manuel d'utilisation. L'apparence du produit dépend du produit que vous avez reçu. Veuillez nous pardonner que nous ne vous informerons plus s'il y a des mises à jour technologiques ou logicielles sur notre produit.

Videur gonflable

Le manuel du propriétaire

Âges : 3-10 ans

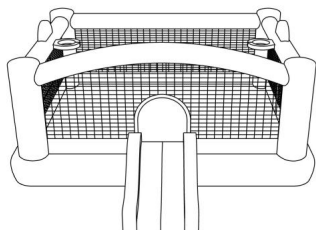

457*447*205CM
Taille approximative gonflée

 **AVERTISSEMENT : LE NON-RESPECT DE CES INSTRUCTIONS PEUT ENTRAÎNER DES BLESSURES GRAVES OU LA MORT.**

N'utilisez pas de rallonges avec ce produit. Utilisation en extérieur uniquement.
Lisez toutes les instructions avant d'assembler cet appareil gonflable. Conservez les instructions pour une utilisation future.

 **ATTENTION : LES UTILISATEURS DOIVENT FAIRE ATTENTION À L'ORIENTATION DU REBONDISSANT PAR RAPPORT AU SOLEIL.** La surface de glissement ne doit pas être située face au soleil car elle pourrait éblouir les enfants lors de l'utilisation du gonflable.

LISTE DES PIÈCES POUR LES ÉTATS-UNIS

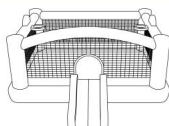

UN). 1 videur gonflable



B). 1 sac de transport



C). 6 ~~piquets~~ ^{piquets} de videur

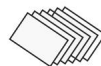

D). 6 correctifs de réparation



E). 2 ballons gonflables



F). 6 balles cibles Dart



G). 1 souffleur



H). 2 piquets de soufflerie

LISTE DE PIÈCES POUR L'UE OU AUS

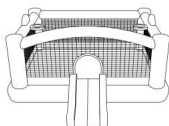

UN). 1 videur gonflable



B). 1 sac de transport



C). 6 ~~piquets~~ ^{piquets} de videur



D). 6 correctifs de réparation



E). 2 ballons gonflables



F). 6 balles cibles Dart



G). 1 souffleur



H). 4 piquets de soufflerie

⚠ SAFETY WARNINGS: SET UP

ADULT SUPERVISION AND SETUP REQUIRED. This product should be inflated or deflated only by a competent adult. Follow all instructions provided.

WARNING! Falls onto hard surfaces can result in head or other serious injuries. Never place on concrete, asphalt, wood, packed earth, or other hard surfaces. Carpet over hard floors may not prevent injury.

- ⚠ **WARNING! Only for domestic use.** Intended for outdoor domestic family use only. Not for use in public areas or as a rental.
- Product is heavy. Use caution when lifting.
- Product should never be dragged across concrete, pavement or other rough surfaces.
- **WARNING!** Keep away from fire. Keep fabric clear of all flame and ignition sources.
- Do not set up in windy or rainy conditions: sudden gusts of wind may lift the product off the ground.
- Product can be installed in any orientation in relation to the sun, since there are no metal components or surfaces that can absorb excessive solar radiation.
- Set-up in outdoor location only that meets the following criteria:
 - Place on level ground and firm grass or soil to allow proper use of stakes.
 - Placing on slanted or uneven surfaces may cause the product to tip.
 - Stakes should be placed at an angle for better anchorage, should be driven under the ground to prevent tripping.
 - Minimum clearance zones: Place at least 2m away from any other objects.
 - Objects to be avoided include but are not limited to fences, buildings, trees, overhead branches, laundry lines, electrical wires, walls, or bodies or sources of water.
 - Make sure the area around the product is secure by adding safety barriers, if necessary, to keep young children and pets from gaining access.
 - Electrical cord must not be passed under the air filled devices (Inflatable Bouncer with Slide) and interfere with its operation.
- The Bouncer with Slide uses a main powered blower (air pump) to maintain pressure, only to be used by an adult.
- Do not use extension cords with this product. Set up as close to power source as possible. The blower should be securely anchored to the ground before use.
- **CAUTION:** the blower is capable of moving large volumes of air very quickly. Place the blower in an area where it will not draw in dirt or leaves. Keep blower and power cord away from children, water and traffic.
- **ATTENTION:** Blower should remain on and continuously inflate Water Park during use. Airflow through seams is normal
- Do not use the product if wind speed exceeds 30km/h.
- Do not consume food, drink and gum on this product.

Minimum Clearance Zones

MINIMUM CLEARANCE ZONES

Make sure that there is a 2m obstacle-free zone around the product, including a fence, garage, house, overhanging branches, laundry lines or electrical wires.

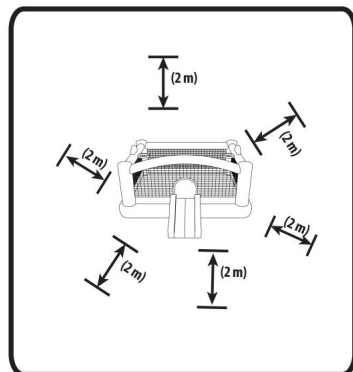

Placement du videur

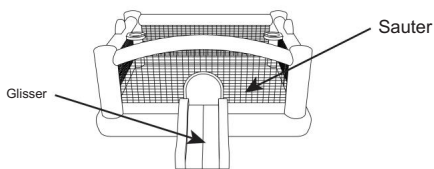

Designate a flat, level surface that allows for 2m of minimum clearance around the Bouncer .

NOTE: DO NOT place the Bouncer with slide on a hard surface like asphalt, concrete or packed earth as both serious bodily injury and damage to the Bounce could result.

ASSEMBLY AREAS

- Make sure the assembly area is flat and level and is free of rocks, sharp objects or other obstructions.
- Do not set up the Bounce on a slope or incline.
- Do not set up the Bounce on hard-packed earth, asphalt, decking or any hard surface as doing so may result in physical injury and/or damage to the Bouncer .
- Once the Bounce inflated or filled with water, do not attempt to drag it to another location.
- Check your local county or city regulations for requirements on securing the pool.
- Secure the pool from unauthorized use.

AVERTISSEMENTS DE SÉCURITÉ : LE NON-RESPECT DE CES INSTRUCTIONS PEUT ENTRAÎNER DES BLESSURES GRAVES OU LA MORT.



Nombre maximum d'enfants : 5



Limite d'âge : 3-10



Limite de poids total sur toboggan et piscine : 225 kg



Hauteur maximale de surveillance individuelle par un adulte : obligatoire. Ne laissez pas les enfants de 5 pieds (152 cm) sans surveillance.



Pas d'objets pointus. Pas de chaussures, pas de lunettes.



Pas de racourcement.



Ne glissez pas la tête la première. Pas de lutte.



Limite de poids individuelle : 45 kg



Pas de mains ni de pieds sur le filet. Ne pas utiliser dans des conditions venteuses.



Ne laissez pas dehors sous la pluie.



Éloignez-vous des ventilateurs et des cordons électriques



Doit être ancré à l'aide de piquets.

• La surveillance constante et compétente d'un adulte sur les enfants et autres jeunes utilisateurs

est requise à tout moment. • Gardez la zone autour du

produit propre et exempt d'objets pour éviter les glissades et les chutes. • Ne

laissez pas les enfants jouer

dans le produit tant qu'il n'est pas complètement gonflé. • Ne laissez pas les enfants

jouer dessus s'ils sont mouillés. Séchez soigneusement avant utilisation. • Ceci n'est

pas un jouet aquatique. Il ne doit pas être utilisé dans l'eau. •

Instruisez les enfants sur l'utilisation appropriée de ce

produit : - Les enfants ne doivent pas porter de vêtements amples ou amples,

d'écharpes, de capuches ou de vêtements avec des cordons ou de longs cordons lorsqu'ils jouent avec ce produit.

- Les enfants doivent retirer de leurs poches casques, couvre-chefs, chaussures et

lunettes, ainsi que tout objet pointu, car ils pourraient percer la surface rebondissante.

- Les jouets et autres objets ne doivent jamais être autorisés à l'intérieur du transat.

- Demandez aux enfants de ne pas attacher au produit des objets qui ne sont pas

spécifiquement conçus pour être utilisés avec l'équipement, tels que, mais sans s'y limiter,

des cordes à sauter, des cordes à linge, des laissez pour animaux de compagnie, des câbles

et des chaînes, car ils peuvent présenter un risque d'étranglement.

- Tenir les animaux éloignés du produit.

- Les enfants doivent rebondir loin des autres et rester à l'écart des ouvertures

et des parois latérales.

- Les enfants ne doivent pas sauter sur ou hors du produit.

- Le poids total des enfants ne doit pas dépasser 500 lbs. (225 kg) Pas plus de 5

enfants ne doivent jouer sur le transat en même temps.

- Ne laissez pas jouer ensemble des enfants dont le poids et la taille sont inégaux. • Avant

et pendant l'utilisation,

vérifiez la perte d'air. Vérifiez que le ventilateur est correctement connecté. • Vérifiez toujours le produit et

tous ses points d'ancrage avant et pendant l'utilisation, et fixez-les à nouveau si nécessaire.

• Après le gonflage, le souffleur doit fonctionner en continu

pendant que les enfants jouent. • Vérifiez qu'aucun utilisateur n'est sur le produit avant de le dégonfler. •

Dégonfliez toujours le produit après utilisation et rangez-le à l'intérieur. • A utiliser

uniquement sur sol meuble. • Les utilisateurs doivent être découragés

de tenter toute modification non autorisée.

Le produit doit être examiné périodiquement pour déceler des conditions potentiellement

dangereuses telles que : un cordon, une fiche, un boîtier ou des pièces endommagés, et

dans le cas où de tels dommages sont constatés, le produit ne doit pas être utilisé jusqu'à

ce qu'il soit correctement réparé. Ne laissez jamais le ventilateur dehors sous la pluie

ou sous les éléments lorsqu'il n'est pas utilisé. Reportez-vous aux instructions pour l'installation,

le stockage, l'entretien et l'entretien.

Jalonner le videur

⚠ ATTENTION : Le videur et tous ses points d'ancrage doivent être vérifiés avant et pendant l'utilisation.

Regonflez ou sécurisez à nouveau selon le cas. NE laissez PAS les enfants jouer sur le transat jusqu'à ce qu'il soit complètement gonflé !

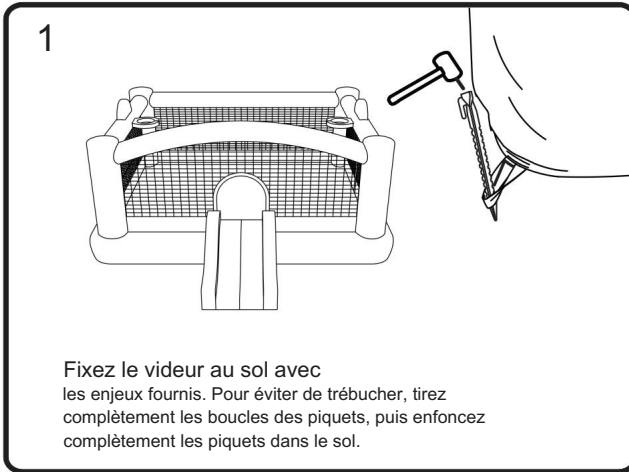

⚠ PRÉCAUTIONS RELATIVES AU SAUTEUR :

- Enfoncez complètement les piquets dans le terre pour éviter tout risque de trébuchement.
- Veuillez ne pas utiliser le videur tant qu'il n'est pas correctement assemblé, ancré dans le sol et entièrement gonflé. Des adultes compétents doivent terminer toutes les étapes d'assemblage.
- N'installez pas et ne gonflez pas le transat avec SLide dans des conditions venteuses et/ou pluvieuses, car les rafales de vent peuvent rendre le parc instable et éventuellement le soulever du sol.

Installation

1 Remove Water park from its packaging



2



Unroll and unfold the Water park in the center of the designated area.

3

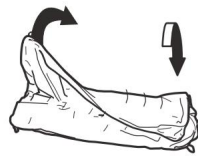

4

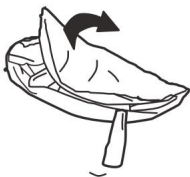

5



6

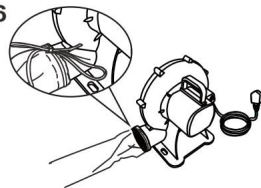

7

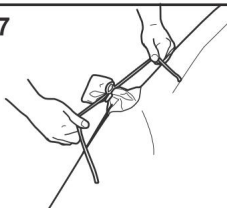

Tie off the short Air Outlet Tube tightly to make a good seal.

8

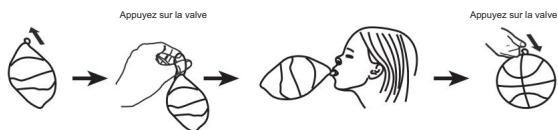

Gonflez le ballon de basket gonflable et le ballon de football gonflable avec la bouche, puis appuyez sur le trou de soufflage à plat.

INFLATION ET MISE EN JEU

Fixez le videur au sol avec les piquets fournis.

Pour éviter de trébucher, tirez complètement les boucles du piquet, puis conduire complètement les enjeux dans le sol.

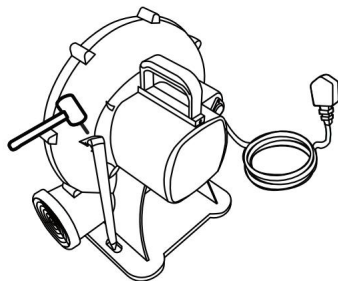
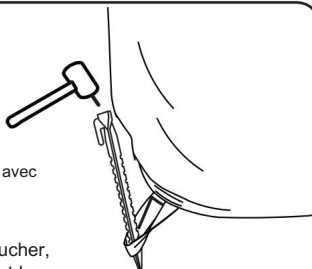

STOCKAGE

- 1 Turn off the air pump and motor, then unplug it from the outlet.

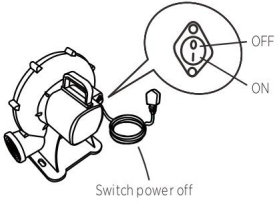

- 2 Untie the drawstring from the short Outlet Tube and allow the bouncer with slide to fully deflate. Remove the Hose Assembly and wrap it up with no kinks.

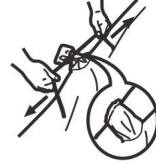

3



4

Plier uniquement



5

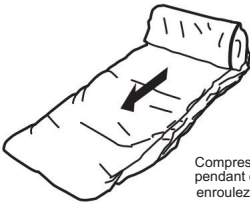

Compressez l'air pendant que vous enrroulez le gonflable.

6

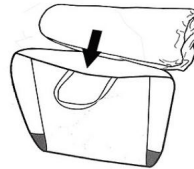

INSTRUCTIONS SUR LE PATCH DE RÉPARATION



AVERTISSEMENT : les patches de réparation doivent être appliqués uniquement par des adultes.
GARDER HORS DE PORTÉE DES ENFANTS.

INSTRUCTION:

1. Dégonflez l'article, nettoyez la zone et laissez sécher complètement.
2. Coupez une partie du patch à la taille nécessaire et arrondissez les coins. (Voir fig).
3. Retirez le support adhésif du matériel de patch, positionnez le patch sur la zone endommagée et lissez les bulles.
4. Laissez reposer 30 minutes avant de regonfler.

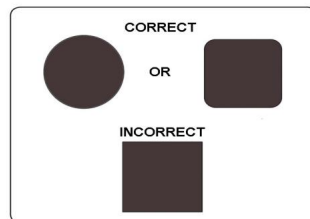

INSTRUCTIONS POUR ENTRETIEN DU VENTILATEUR

- En tant que produit d'extérieur, le transat est sujet à l'usure et à la détérioration. Inspecter les signes de défaillance du tissu ; les surfaces faibles ou déchirées doivent être réparées rapidement.
- Pour garder le produit propre : essuyez le videur ou le souffleur à l'aide d'un chiffon sec ou d'un chiffon imbibé d'une solution nettoyante et désinfectante neutre, non inflammable et non toxique, ou de l'eau pure.
- Le produit ne doit jamais être stocké humide. Laisser sécher avant de rouler.

- Le ventilateur doit être débranché avant l'entretien.
- Si le cordon d'alimentation est endommagé, il doit être remplacé par des personnes qualifiées afin d'éviter tout danger.
- Le produit doit être examiné périodiquement pour détecter des conditions potentiellement dangereuses telles qu'un cordon, une fiche, un boîtier ou des pièces endommagés, et que même si de tels dommages sont découverts, le produit ne doit pas être utilisé tant qu'il n'a pas été correctement réparé. Si ces Si aucun contrôle n'est effectué, le produit pourrait se renverser ou constituer un danger.
- Le souffleur ne nécessite aucune lubrification et n'a aucun pièces réparables par l'utilisateur. N'essayez pas de réparer le ventilateur.
- Ne plongez pas le ventilateur dans l'eau. Pour nettoyer, essayez avec un chiffon humide.
- Vérifiez régulièrement les ouvertures d'admission et de sortie et maintenez-les exempts de saletés, de feuilles, etc.
- Lorsqu'il n'est pas utilisé, rangez le souffleur à l'intérieur dans un endroit sec.
- Rangez le souffleur à la verticale sur une surface stable.
- Enroulez le cordon sans serrer et placez-le à côté du ventilateur.
- Lors de l'utilisation, ne placez pas le cordon au-dessus des zones de circulation, de l'eau ou des zones humides.
- Le ventilateur est un ventilateur à volume élevé et est capable de déplacer très rapidement de grands volumes d'air. Placez le souffleur dans un endroit où il n'aspire pas de saleté ou de feuilles.

ÉCO-RECYCLAGE



« Prenons soin de l'environnement ! » Le

symbole de la poubelle sur roulettes indique que le produit ne doit pas être jeté avec les autres déchets ménagers. Veuillez utiliser les points de collecte ou les installations de recyclage désignés lors de la mise au rebut de l'article.

Veuillez conserver ce manuel car il contient des informations importantes.

Adresse : Baoshanqu Shuangchenglu 803long 11hao 1602A-1609shi
Shanghai

Importé en Australie : SIHAO PTY LTD, 1 ROKEVA STREETESTWOOD
NSW 2122 Australie

Importé aux États-Unis : Sanven Technology Ltd, Suite 250, 9166 Anaheim
Lieu, Rancho Cucamonga, CA 91730

REPRÉSENTANT CE	
-----------------	--

SHUNSHUN GmbH
Römeräcker 9 Z2021, 76351
Linkenheim-Hochstetten, Allemagne

REPRÉSENTANT DU ROYAUME-UNI	
-----------------------------	--

Groupe Pooledas Ltd
Unité 5 Maison Albert Edward, La
Pavillons Preston, Royaume-Uni

VEVOR[®]

TOUGH TOOLS, HALF PRICE

Assistance technique et certificat de garantie
électronique www.vevor.com/support

VEVOR[®]

TOUGH TOOLS, HALF PRICE

Technische ondersteuning en e-garantiecertificaat

www.vevor.com/support

OPBLAASBARE WISSELAAR

MODEL:PL2464

We blijven ons inzetten om u gereedschap tegen een concurrerende prijs te bieden.

'Bespaar de helft', 'Halve prijs' of andere soortgelijke uitdrukkingen die door ons worden gebruikt vertegenwoordigen slechts een schatting van de besparingen die u zou kunnen profiteren als u bepaalde gereedschappen bij ons koopt in vergelijking met de grote topmerken en betekenen niet noodzakelijkerwijs dat ze alle categorieën van aangeboden gereedschappen dekken. door ons. Wij verzoeken u vriendelijk om bij het plaatsen van een bestelling bij ons goed na te gaan of u daadwerkelijk de helft bespaart in vergelijking met de grote topmerken.

VEVOR®

TOUGH TOOLS, HALF PRICE

OPBLAASBARE WISSELAAR

MODEL:PL2464

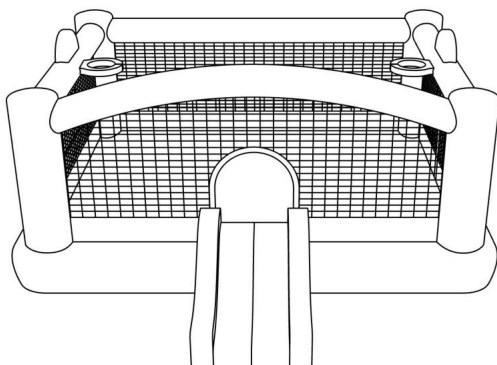

HULP NODIG? NEEM CONTACT MET ONS OP!

Heeft u productvragen? Technische ondersteuning nodig? Neem gerust contact met ons op:

Technische

ondersteuning en e-garantiecertificaat www.vevor.com/support

Dit is de originele instructie. Lees alle instructies in de handleiding zorgvuldig door voordat u ermee aan de slag gaat. VEVOR behoudt zich een duidelijke interpretatie van onze gebruikershandleiding voor. Het uiterlijk van het product is afhankelijk van het product dat u heeft ontvangen. Vergeef ons alstublieft dat we u niet opnieuw zullen informeren als er technologie- of software-updates zijn voor ons product.

Opblaasbare uitsmijter

Gebruikershandleiding

Leeftijden: 3-10 jaar

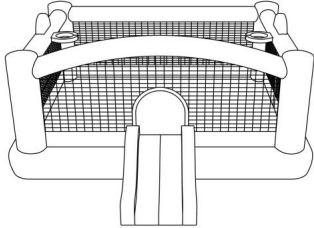

457*447*205 CM
Geschatte maat opgeblazen



WAARSCHUWING: HET NIET VOLGEN VAN DEZE INSTRUCTIES KAN LEIDEN TOT ERNSTIG LETSEL OF DE DOOD.

Gebruik geen verlengsnoeren bij dit product. Alleen gebruik buitenshuis.
Lees alle instructies voordat u dit opblaasbare apparaat monteert. Bewaar de instructies voor toekomstig gebruik.



WAARSCHUWING: GEBRUIKERS MOETEN ZORGVULDIG ZIJN VOOR EEN BOUNCY-ORIËNTATIE MET BETREKKING TOT DE ZON. Het glijoppervlak mag niet in de richting van de zon worden geplaatst, omdat dit kinderen kan verblinden tijdens het gebruik van het springkussen.

ONDERDELENLIJST VOOR DE VS

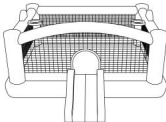

A). 1 springkussen



E). 2 opblaasbare ballen



B). 1 draagtas



F). 6 Dartdoelballen



C). Uitsmijter inzet



G). 1 blazer



D). 6 reparatiepatches



H). 2 ventilatorstokken

ONDERDELENLIJST VOOR EU OF AUS

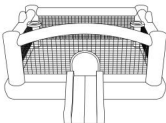

A). 1 springkussen



E). 2 opblaasbare ballen



B). 1 draagtas



F). 6 Dartdoelballen



C). Uitsmijter inzet



G). 1 blazer



D). 4 reparatiepatches



H). 4 ventilatorstokken

⚠️ SAFETY WARNINGS: SET UP

ADULT SUPERVISION AND SETUP REQUIRED. This product should be inflated or deflated only by a competent adult. Follow all instructions provided.

WARNING! Falls onto hard surfaces can result in head or other serious injuries. Never place on concrete, asphalt, wood, packed earth, or other hard surfaces. Carpet over hard floors may not prevent injury.

- ⚠️ **WARNING! Only for domestic use.** Intended for outdoor domestic family use only. Not for use in public areas or as a rental.
- Product is heavy. Use caution when lifting.
- Product should never be dragged across concrete, pavement or other rough surfaces.
- **WARNING!** Keep away from fire. Keep fabric clear of all flame and ignition sources.
- Do not set up in windy or rainy conditions: sudden gusts of wind may lift the product off the ground.
- Product can be installed in any orientation in relation to the sun, since there are no metal components or surfaces that can absorb excessive solar radiation.
- Set-up in outdoor location only that meets the following criteria:
 - Place on level ground and firm grass or soil to allow proper use of stakes.
 - Placing on slanted or uneven surfaces may cause the product to tip.
 - Stakes should be placed at an angle for better anchorage, should be driven under the ground to prevent tripping.
 - Minimum clearance zones: Place at least 2m away from any other objects.
 - Objects to be avoided include but are not limited to fences, buildings, trees, overhead branches, laundry lines, electrical wires, walls, or bodies or sources of water.
 - Make sure the area around the product is secure by adding safety barriers, if necessary, to keep young children and pets from gaining access.
 - Electrical cord must not be passed under the air filled devices (Inflatable Bouncer with Slide) and interfere with its operation.
- The Bouncer with Slide uses a main powered blower (air pump) to maintain pressure, only to be used by an adult.
- Do not use extension cords with this product. Set up as close to power source as possible. The blower should be securely anchored to the ground before use.
- **CAUTION:** the blower is capable of moving large volumes of air very quickly. Place the blower in an area where it will not draw in dirt or leaves. Keep blower and power cord away from children, water and traffic.
- **ATTENTION:** Blower should remain on and continuously inflate Water Park during use. Airflow through seams is normal
- Do not use the product if wind speed exceeds 30km/h.
- Do not consume food, drink and gum on this product.

Minimum Clearance Zones

MINIMUM CLEARANCE ZONES

Make sure that there is a 2m obstacle-free zone around the product, including a fence, garage, house, overhanging branches, laundry lines or electrical wires.

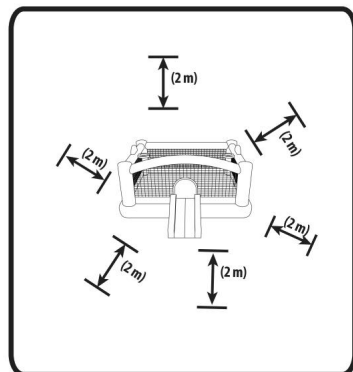

Uitsmijter plaatsing

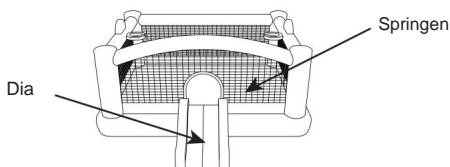

Designate a flat, level surface that allows for 2m of minimum clearance around the Bouncer .

NOTE: DO NOT place the Bouncer with slide on a hard surface like asphalt, concrete or packed earth as both serious bodily injury and damage to the Bounce could result.

ASSEMBLY AREAS

- Make sure the assembly area is flat and level and is free of rocks, sharp objects or other obstructions.
- Do not set up the Bounce on a slope or incline.
- Do not set up the Bounce on hard-packed earth, asphalt, decking or any hard surface as doing so may result in physical injury and/or damage to the Bouncer .
- Once the Bounce inflated or filled with water, do not attempt to drag it to another location.
- Check your local county or city regulations for requirements on securing the pool.
- Secure the pool from unauthorized use.

VEILIGHEIDSWAARSCHUWINGEN: HET NIET VOLGEN VAN DEZE INSTRUCTIES KAN LEIDEN TOT ERNSTIG LETSEL OF DE DOOD.



Maximaal aantal kinderen:
5



Leeftijdsgrens: 3-10



Totaalgewicht op
glijbaan en zweembad:
225 kg



Maximale individuele
toezichtshoogte volwassenen:
vereist. Laat kinderen van 152 cm (5 ft.) niet zonder
toezicht achter.



Geen scherpe voorwerpen. Geen schoenen, geen bril.



Geen ondraaien.



Schud het hoofd niet eerst. Geen worstelen.



Individuele
gewichtslimit:
45 kg.



Geen handen of voeten aan het net. Niet gebruiken in
windige omstandigheden.



Laat het net buiten
staan als het regent.



Blijf uit de buurt van ventilatoren
en elektrische snoeren



Moet verankerd worden
met palen.

• Er is te allen tijde constant, competent toezicht van volwassenen op kinderen

en andere jonge gebruikers vereist. • Houd het

gebied rondom het product schoon en vrij van voorwerpen, om uitglijden en vallen te voorkomen.

• Laat kinderen niet in het product spelen voordat het volledig is opgeblazen. • Laat kinderen niet spelen als het nat is. Grondig drogen voor gebruik. • Dit is geen waterspeelgoed. Het mag niet in water

worden gebruikt. • Instrueer kinderen over het juiste

gebruik van dit product: - Kinderen mogen geen losse of wijde kleding,

sjaals, kappen of kleding met trekkoorden of lange koorden dragen tijdens het spelen op dit product.

- Kinderen moeten helmen, hoofddeksels, schoenen en brillen verwijderen, evenals eventuele scherpe voorwerpen uit hun zakken, omdat deze het sluitende oppervlak kunnen doorboren.

- Speelgoed en andere voorwerpen mogen nooit in het wipstoeltje worden toegelaten.

- Instrueer kinderen om geen voorwerpen aan het product te bevestigen die niet specifiek zijn ontworpen voor gebruik met de apparatuur, zoals maar niet beperkt tot springtouwen, waslijnen, hondendiemen, kabels en kettingen, aangezien deze een wurgingsgevaar kunnen veroorzaken.

- Houd huisdieren uit de buurt van het product.

- Kinderen moeten wegspringen van anderen en uit de buurt blijven van openingen en zijwanden.

- Kinderen mogen niet op of van het product springen.

- Het totale gewicht van kinderen mag niet hoger zijn dan 500 lbs. (225 kg) Er mogen niet meer dan 5 kinderen tegelijk op het wipstoeltje spelen.

- Laat kinderen die qua gewicht en lengte niet bij elkaar passen niet samen spelen. •

Controleer voor en tijdens

gebruik op luchtverlies. Controleer of de ventilator goed is aangesloten. • Controleer altijd het product

en alle verankeringspunten voor en tijdens gebruik en zet het indien nodig opnieuw

vast. • Na het opblazen moet de blazer continu draaien

terwijl de kinderen spelen. • Controleer of er geen gebruiker op het product zit voordat u het laat

leeglopen. • Laat het product na gebruik altijd leeglopen en bewaar het

binnenshuis. • Alleen te gebruiken op zachte ondergrond. • Gebruikers

moeten worden ontmoedigd om

ongeoorloofde wijzigingen aan te brengen.

Het product moet periodiek worden onderzocht op potentiële onveilige omstandigheden,

zoals: beschadigd snoer, stekker, behuizing of onderdelen, en dat in het geval dergelijke

schade wordt geconstateerd, het product niet mag worden gebruikt totdat het op de

juiste manier is gerepareerd. Laat de ventilator nooit buiten in de regen of in de

elementen staan wanneer hij niet in gebruik is. Raadpleeg de instructies voor opstelling,

opslag, onderhoud en verzorging.

De uitsmijter uitzetten

⚠ WAARSCHUWINGEN: Het wipstoeltje en alle verankeringspunten moeten vóór en tijdens gebruik worden gecontroleerd. Indien nodig opnieuw opblazen of opnieuw vastzetten. Laat kinderen NIET op het wipstoeltje spelen voordat het volledig is opgeblazen!

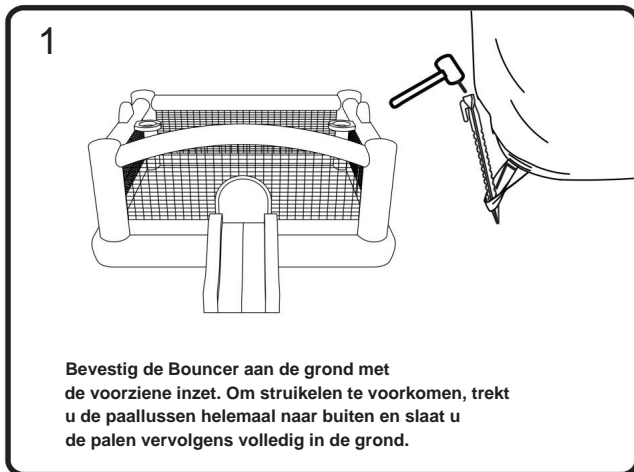

⚠ WAARSCHUWINGEN VOOR BUINCERS:

- Grondpennen volledig in de grond slaan grond om struikelgevaar te voorkomen.
- Gebruik het wipstoeltje pas als het correct is gemonteerd, in de grond is verankerd en volledig is opgeblazen. Bevoegde volwassenen moeten alle montageschappen voltooiën.
- Zet het wipstoeltje met SLide niet op en blaas het niet op in winderige en/of regenachtige omstandigheden windstoten kunnen ervoor zorgen dat het park instabiel wordt en mogelijk van de grond wordt getild.

Oppericht

1 Remove Water park from its packaging



2



Unroll and unfold the Water park in the center of the designated area.

3

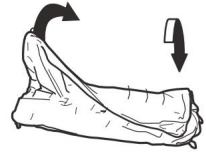

4

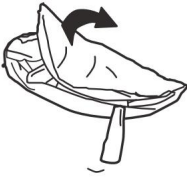

5



6

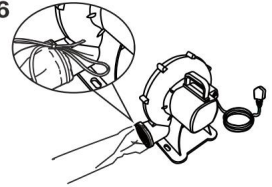

7

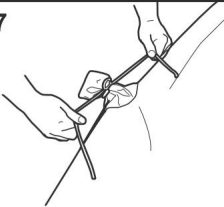

Tie off the short Air Outlet Tube tightly to make a good seal.

8

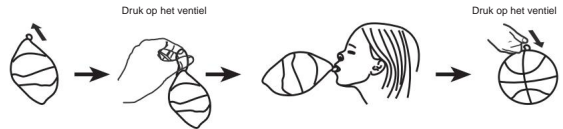

Blaas de opblaasbare basketbal en de opblaasbare voetbal met de mond op en druk vervolgens het blaasgat plat.

INFLATIE & STAKING

Bevestig het uitsmijtertje aan de grond met de meegeleverde palen. Om struikelen te voorkomen, trek dan de paallussen helemaal naar buiten drijf de inzet volledig in de grond.

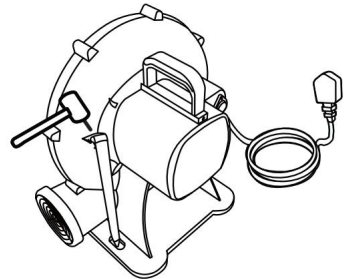
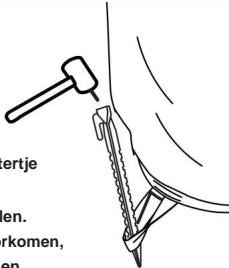

OPSLAG

- 1 Turn off the air pump and motor, then unplug it from the outlet.

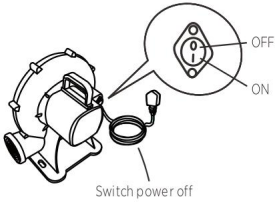

- 2 Untie the drawstring from the short Outlet Tube and allow the bouncer with slide to fully deflate. Remove the Hose Assembly and wrap it up with no kinks.

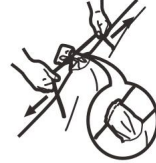

3

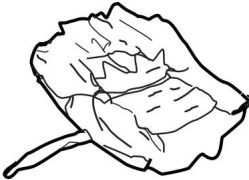

4

Alleen omvouden



5

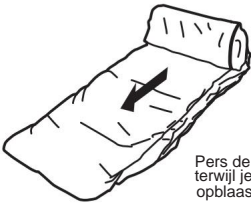

Pers de lucht eruit terwijl je het opblaasbaar oprolt

6

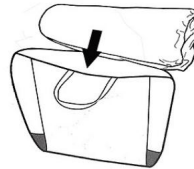

REPARATIEPATCHINSTRUCTIES



WAARSCHUWING: Reparatiepleisters mogen alleen door volwassenen worden aangebracht. **BUITEN BEREIK VAN KINDEREN HOUDEN.**

INSTRUCTIE:

1. Laat het artikel leeglopen, maak het gebied schoon en laat het grondig drogen.
2. Knip een deel van de pleister op de gewenste maat en rond de hoeken af. (Zie afbeelding).
3. Verwijder de zelfklevende achterkant van de patchmateriaal, plaats de patch op het beschadigde gebied en strijk eventuele luchtballen glad.
4. Laat het 30 minuten zitten voordat u het opnieuw opblaast.

INSTRUCTIES VOOR BUINCER ONDERHOUD

- Omdat het een buitenproduct is, is het wipstoeltje onderhevig aan slijtage en slijtage. Inspecteer op tekenen van falen van de stof; zwakke of gescheurde oppervlakken moeten onmiddellijk worden gerepareerd.
- Om het product schoon te houden: veeg het wipstoeltje of de blazer af met een droge doek of een doek bevochtigd met een neutrale, niet-ontvlambare, niet-giftige reinigings- en ontsmettingsoplossing of zuiver water.
- Product mag nooit nat worden opgeslagen. Laten drogen alvorens op te rollen.

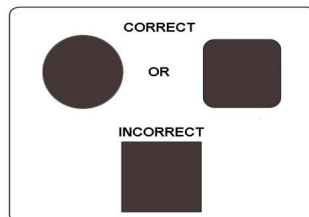

INSTRUCTIES VOOR ONDERHOUD VAN DE BLAZER

- De ventilator moet vóór onderhoud worden losgekoppeld.
- Als het netsnoer beschadigd is, moet het door gekwalificeerd personeel worden vervangen om gevaar te voorkomen
- Het product moet periodiek worden onderzocht op mogelijk onveilige omstandigheden, zoals beschadigde snoeren, stekkers, behuizing of onderdelen, en dat zelfs als dergelijke schade wordt geconstateerd, de product mag niet worden gebruikt totdat het correct is gerepareerd. Als deze Als er geen controles worden uitgevoerd, kan het product omvallen of op een andere manier gevaarlijk worden.
- De ventilator heeft geen smering nodig en heeft geen smering door de gebruiker te onderhouden onderdelen. Probeer geen onderhoud aan de ventilator uit te voeren.
- Dompel de ventilator niet onder in water. Om schoon te maken, veegt u af met een vochtige doek.
- Controleer regelmatig de in- en uitvoeropeningen en houd ze vrij van vuil, bladeren etc.
- Wanneer u de bladblazer niet gebruikt, bewaar deze dan binnenshuis op een droge plaats.
- Bewaar de bladblazer rechtop op een stabiele ondergrond.
- Rol het snoer losjes op en plaats het naast de ventilator.
- Plaats het snoer tijdens gebruik niet op verkeersgebieden, water of vochtige plaatsen.
- De ventilator is een ventilator met hoog volume en is daartoe in staat grote hoeveelheden lucht zeer snel verplaatsen. Plaats de bladblazer op een plek waar hij geen vuil of bladeren aanzuigt.

CORRECTE VERWERPING



'Laten we zorg dragen voor het milieu!' Het

symbool van de afvalcontainer geeft aan dat het product niet samen met ander huishoudelijk afval mag worden weggegooid. Maak gebruik van aangewezen inzamelpunten of recyclingfaciliteiten als u het artikel weggooit.

Bewaar deze handleiding, want deze bevat belangrijke informatie.

Adres: Baoshanqu Shuangchenglu 803long 11hao 1602A-1609shi
Sjanghai

Geïmporteerd naar AUS: SIHAO PTY LTD, 1 ROKEVA STREETEASTWOOD
NSW 2122 Australië

Geïmporteerd in de VS: Sanven Technology Ltd, Suite 250, 9166 Anaheim
Plaats, Rancho Cucamonga, CA 91730



SHUNSHUN GmbH
Römeräcker 9 Z2021, 76351
Linkenheim-Hochstetten, Duitsland



Pooledas Group Ltd
Eenheid 5 Albert Edward House, The
Paviljoens Preston, Verenigd Koninkrijk

VEVOR[®]

TOUGH TOOLS, HALF PRICE

Technische ondersteuning en e-
garantiecertificaat www.vevor.com/support

VEVOR[®]

TOUGH TOOLS, HALF PRICE

Teknisk support och e-garanticertifikat

www.vevor.com/support

UPPBLASBAR TUTTARE

MODELL: PL2464

Vi fortsätter att vara engagerade i att ge dig verktyg till konkurrenskraftiga priser.

"Spara hälften", "halva priset" eller andra liknande uttryck som används av oss representerar bara en uppskattning av besparingar du kan dra nytta av att köpa vissa verktyg hos oss jämfört med de stora toppmärkena och betyder inte nödvändigtvis att täcka alla kategorier av verktyg som erbjuds av oss. Du påminns vänligen om att noggrant kontrollera när du gör en beställning hos oss om du faktiskt sparar hälften i jämförelse med de främsta stora varumärkena.

VEVOR®

TOUGH TOOLS, HALF PRICE

UPPBLASBAR TUTTARE

MODELL: PL2464

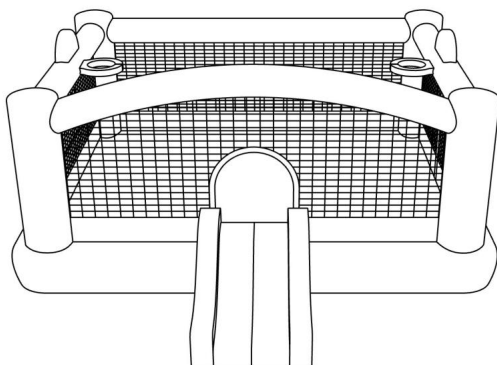

BEHÖVS HJÄLP? KONTAKTA OSS!

Har du produktfrågor? Behöver du teknisk support? Kontakta oss gärna: **Teknisk support och e-garanticertifikat www.vevor.com/support**

Detta är den ursprungliga instruktionen, läs alla instruktioner noggrant innan du använder den. VEVOR reserverar sig för en tydlig tolkning av vår användarmanual. Utseendet på produkten är beroende av den produkt du fått. Ursäkta oss att vi inte kommer att informera dig igen om det finns någon teknik eller mjukvaruuppdateringar på vår produkt.

Uppblåsbar Bouncer

Ägarmanual

Ålder: 3-10 år

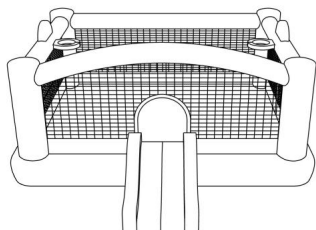

457*447*205cm
Ungefärlig storlek uppblåst



VARNING: OM DESSA INSTRUKTIONER INTE FÖLJS KAN RESULTAT TILL ALLVARLIG SKADA ELLER DÖDSFALL.

Använd inte förlängningssladdar med denna produkt. Endast utomhusbruk.
Läs alla instruktioner innan du sätter ihop den här uppblåsbara enheten. Spara instruktionerna för framtida bruk.



VARNING: ANVÄNDARE MÅSTE VARA FÖRSIKTIGA EN STRUPPORENERING MED AVSEENDE PÅ SOLEN. Glidytan bör inte vara vänd mot solen eftersom den kan blända barn när de använder studsden.

DELLISTA FÖR USA

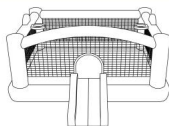

A). 1 uppblåsbar studsare



B). 1 Bärväska



C). 6 Bouncer Stakes



D). 6 Reparera patchar



E). 2 uppblåsbara bollar



F). 6 pilmålbollar



G). 1 Fläkt



H). 2 fläktinsatser

DELLISTA FÖR EU ELLER AUS

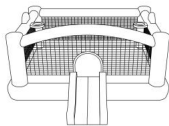

A). 1 uppblåsbar studsare



B). 1 Bärväska



C). 6 Bouncer Stakes



D). 6 Reparera patchar



E). 2 uppblåsbara bollar



F). 6 pilmålbollar



G). 1 Fläkt



H). 4 fläktinsatser

⚠️ SAFETY WARNINGS: SET UP

ADULT SUPERVISION AND SETUP REQUIRED. This product should be inflated or deflated only by a competent adult. Follow all instructions provided.

WARNING! Falls onto hard surfaces can result in head or other serious injuries. Never place on concrete, asphalt, wood, packed earth, or other hard surfaces. Carpet over hard floors may not prevent injury.

- ⚠️ **WARNING! Only for domestic use.** Intended for outdoor domestic family use only. Not for use in public areas or as a rental.
- Product is heavy. Use caution when lifting.
- Product should never be dragged across concrete, pavement or other rough surfaces.
- **WARNING!** Keep away from fire. Keep fabric clear of all flame and ignition sources.
- Do not set up in windy or rainy conditions: sudden gusts of wind may lift the product off the ground.
- Product can be installed in any orientation in relation to the sun, since there are no metal components or surfaces that can absorb excessive solar radiation.
- Set-up in outdoor location only that meets the following criteria:
 - Place on level ground and firm grass or soil to allow proper use of stakes.
 - Placing on slanted or uneven surfaces may cause the product to tip.
 - Stakes should be placed at an angle for better anchorage, should be driven under the ground to prevent tripping.
 - Minimum clearance zones: Place at least 2m away from any other objects.
 - Objects to be avoided include but are not limited to fences, buildings, trees, overhead branches, laundry lines, electrical wires, walls, or bodies or sources of water.
 - Make sure the area around the product is secure by adding safety barriers, if necessary, to keep young children and pets from gaining access.
 - Electrical cord must not be passed under the air filled devices (Inflatable Bouncer with Slide) and interfere with its operation.
- The Bouncer with Slide uses a main powered blower (air pump) to maintain pressure, only to be used by an adult.
- Do not use extension cords with this product. Set up as close to power source as possible. The blower should be securely anchored to the ground before use.
- **CAUTION:** the blower is capable of moving large volumes of air very quickly. Place the blower in an area where it will not draw in dirt or leaves. Keep blower and power cord away from children, water and traffic.
- **ATTENTION:** Blower should remain on and continuously inflate Water Park during use. Airflow through seams is normal
- Do not use the product if wind speed exceeds 30km/h.
- Do not consume food, drink and gum on this product.

Minimum Clearance Zones

MINIMUM CLEARANCE ZONES

Make sure that there is a 2m obstacle-free zone around the product, including a fence, garage, house, overhanging branches, laundry lines or electrical wires.

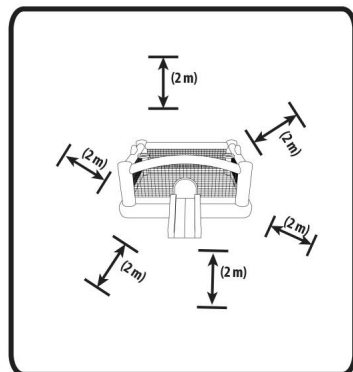

Bouncer Placing

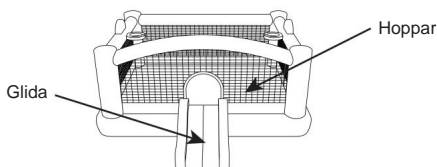

Designate a flat, level surface that allows for 2m of minimum clearance around the Bouncer .

NOTE: DO NOT place the Bouncer with slide on a hard surface like asphalt, concrete or packed earth as both serious bodily injury and damage to the Bounce could result.

ASSEMBLY AREAS

- Make sure the assembly area is flat and level and is free of rocks, sharp objects or other obstructions.
- Do not set up the Bounce on a slope or incline.
- Do not set up the Bounce on hard-packed earth, asphalt, decking or any hard surface as doing so may result in physical injury and/or damage to the Bouncer .
- Once the Bounce inflated or filled with water, do not attempt to drag it to another location.
- Check your local county or city regulations for requirements on securing the pool.
- Secure the pool from unauthorized use.

SÄKERHETSVARNINGAR: UNDERLÅTENHET ATT FÖLJA DESSA INSTRUKTIONER KAN RESULTERA TILL ALLVARLIG SKADA ELLER DÖDSFALL.



Max antal barn: 5



Åldersgräns: 3-10



Totalviktsgräns på rutschkana och pool: 225 kg



Maximal individuell övervakningshöjd för vuxen: krävs. Lämnas inte barn på 152 cm utan uppsikt.



Inga vassa föremål. Inga skor, inga glasögon.



Ingen vändring.



Skjut inte huvudet först. Ingen brottning.



Individuell viktgräns: 45 kg.



Inga händer eller fötter på nätet. Använd inte i blåsiga förhållanden.



Lämnas inte ut i regn.



Håll dig borta från fläktar och ekablar



Måste förankras med pälår.

• Konstant, kompetent vuxenövervakning av barn och andra unga

användare krävs hela tiden. • Håll

området runt produkten rent och fritt från föremål för att förhindra halkar och fall. • Låt

inte barn leka i produkten förrän den är helt uppblåst. • Låt inte barn leka om de är våta. Torka noggrant före användning. • Detta är inte en vattenleksak. Den ska inte användas i vatten. • Instruera barn om korrekt användning

av denna produkt: - Barn bör inte bära lösa eller påsiga kläder, halsdukar, huvor eller kläder med dragsko eller långa snören när de leker på denna produkt.

- Barn måste ta av sig hjälmar, huvudbonader, skor och glasögon samt eventuella vassa föremål ur sina fickor, eftersom de kan punktera den studsande ytan.

- Leksaker och andra föremål ska aldrig tillåtas inne i dörrvakt.

- Instruera barn att inte fästa föremål på produkten som inte är specifikt designade för användning med utrustningen, såsom men inte begränsat till, hopprep, klädstretch, hudsjurskoppel, kablar och kedjor eftersom de kan orsaka stryplingsrisk.

- Håll husdjur borta från produkten.

- Barn ska studsas bort från andra, och hålla sig borta från öppningar och sidoväggar.

- Barn ska inte hoppa på eller av produkten.

- Barnens totala vikt får inte överstiga 500 lbs. (225 kg) Högst 5 barn får leka på Bouncer samtidigt.

- Låt inte barn leka tillsammans som är ojämnt matchade i vikt och längd. • Kontrollera

före och under användning för luftförlust. Kontrollera att fläkten är korrekt ansluten. •

Kontrollera alltid produkten och alla dess förankringspunkter före och

under användning, och för att återsäkra den vid

behov. • Efter uppblåsning ska fläkten gå kontinuerligt medan barn leker. • Kontrollera att ingen användare befinner sig på produkten innan luft töms. •

Töm alltid produkten efter användning och förvara den

inomhus. • Får endast användas

på mjukt underlag. • Användare måste avkräckas från att försöka göra någon otillåten modifiering.

Produkten bör regelbundet undersökas med avseende på potentiellt osäkra förhållanden såsom: skadad sladd, kontakt, hölje eller delar, och att produkten inte ska användas förrän den har reparerats på rätt sätt,

om sådan skada upptäcks. Lämnas aldrig fläkten utomhus i regn eller väderlek när den inte används. Se instruktionerna för installation, förvaring, underhåll och skötsel.

Utsätter utkastaren

⚠ FÖRSIKTIGHET: Bouncern och alla dess förankringspunkter bör kontrolleras före och under användning.

Blås upp igen eller säkra på nytt efter behov. LÅT INTE barn leka på dörrvakten förrän den är helt uppbläst!

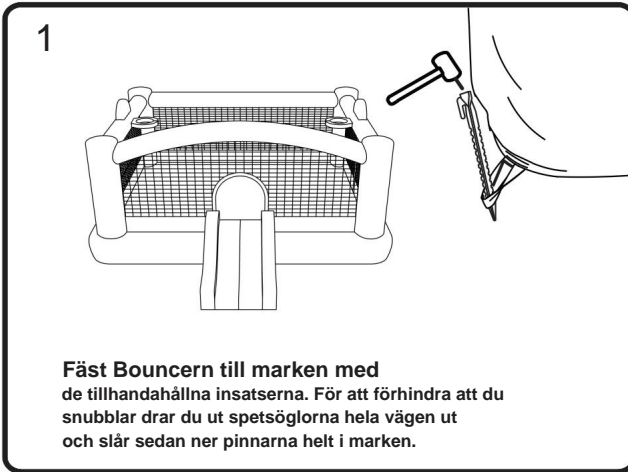

⚠ VARNINGAR FÖR UTVISARE:

- Slå in markpälarna helt i marken för att undvika snubbelrisk.
- Använd inte Bouncern förrän den är ordentligt monterad, förankrad i marken och helt uppbläst. Kompetenta vuxna bör avsluta alla monteringssteg.

- Ställ inte upp eller blås upp Bouncer med SLide i blåsiga och/eller regniga förhållanden som vindbyar kan göra att parken blir instabil och eventuellt lyfts från marken.

Uppstart

- 1 Remove Water park from its packaging



2



Unroll and unfold the Water park in the center of the designated area.

3



4

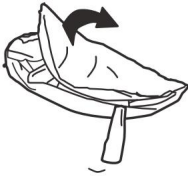

5



6

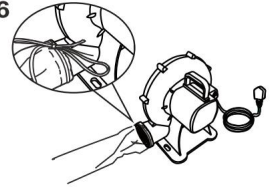

7

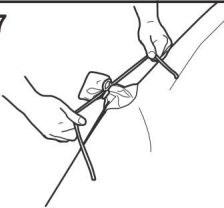

Tie off the short Air Outlet Tube tightly to make a good seal.

8

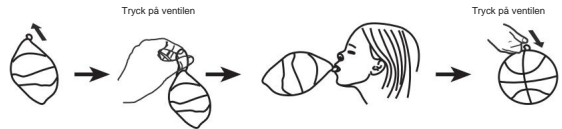

Tryck på ventilen

Tryck på ventilen

Blås upp den uppblåsbara basketbollen och den uppblåsbara fotbollen genom munnen och tryck sedan blåshålet platt.

INFLATION & INSATSNING

Fäst dörrvakt till marken med de medföljande insatserna. För att förhindra snubbling, dra sedan ut staköglorna hela vägen driva insatser helt ner i marken.

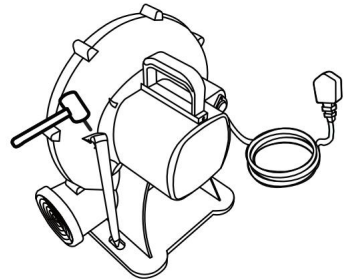
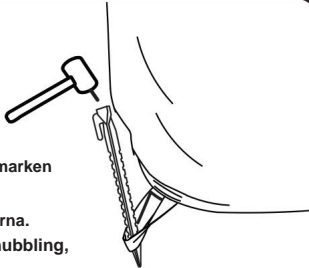

LAGRING

- 1 Turn off the air pump and motor, then unplug it from the outlet.

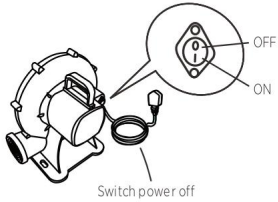

- 2 Untie the drawstring from the short Outlet Tube and allow the bouncer with slide to fully deflate. Remove the Hose Assembly and wrap it up with no kinks.



3



4

Vik endast över



5

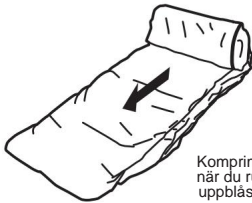

Komprimera ut luft när du rullar upp uppblåsbara

6

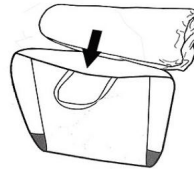

INSTRUKTIONER FÖR REPARATION PATCH



VARNING: Reparationsplåster får endast appliceras av vuxna.

FÖRVARA UTOM RÄCKHÅLL FÖR BARN.

INSTRUKTION:

1. Töm föremålet, rengör området och låt det torka ordentligt.
2. Klipp en del av plåstret till den storlek som behövs och runda hörnen. (Se fig).
3. Ta bort den självhäftande baksidan från lappmaterial, placera plåstret över det skadade området och jämna ut eventuella bubblor.
4. Låt stå i 30 minuter innan du blåser upp igen.

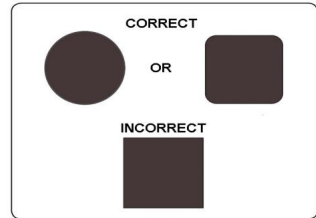

INSTRUKTIONER FÖR BOUNCER UNDERHÅLL

- Som en utomhusprodukt utsätts studsaren för slitage och försämring. Inspektera för tecken på tygfel; svaga eller trasiga ytor måste repareras omgående.
- För att hålla produkten ren: torka av dörrvakten eller fläkten med en torr trasa eller en trasa fuktad med en neutral, icke brandfarlig, giftfri rengörings- och desinfektionslösning eller rent vatten.
- Produkten får aldrig förvaras våt. Låt torka innan du rullar ihop.

INSTRUKTIONER FÖR UNDERHÅLL AV BLÅSAR

- Fläkten måste kopplas ur innan service.
- Om nätsladden är skadad måste den bytas ut av kvalificerade personer för att undvika fara
- Produkten bör regelbundet undersökas för potentiellt osäkra förhållanden såsom skadad sladd, kontakt, hölje eller delar, och att även om en sådan skada upptäcks, produkten ska inte användas förrän den är korrekt reparerad. Om dessa kontroller inte utförs, kan produkten välta eller på annat sätt bli en fara.
- Fläkten kräver ingen smörjning och har nr delar som användaren kan reparera. Försök inte att serva fläkten.
- Sänk inte ned fläkten i vatten. För att rengöra, torka av med en fuktig trasa.
- Kontrollera regelbundet insugnings- och utloppsöppningarna och håll dem fria från smuts, löv etc.
- När den inte används, förvara fläkten inomhus på en torr plats.
- Förvara fläkten upprätt på ett stabilt underlag.
- Rulla ihop sladden löst och placera den bredvid fläkten.
- Placera inte sladden över trafikområden, vatten eller fuktiga områden när den används.
- Fläkten är en fläkt med hög volym och kan flytta stora volymer luft mycket snabbt. Placera fläkten på ett område där den inte drar in smuts eller löv.

KÖRREKT FÖRSLÄPPNING



"Låt oss ta hand om miljön!" Symbolen för sopstunor anger att produkten inte får slängas med annat hushållsavfall. Använd avsedda samlingsställen eller återvinningsanläggningar när du kasserar föremålet.

Behåll denna manual eftersom den innehåller viktig information.

Adress: Baoshanqu Shuangchenglu 803long 11hao 1602A-1609shi
Shanghai

Importerad till AUS: SIHAO PTY LTD, 1 ROKEVA STREET EASTWOOD
NSW 2122 Australien

Importerad till USA: Sanven Technology Ltd, Suite 250, 9166 Anaheim
Place, Rancho Cucamonga, CA 91730



SHUNSHUN GmbH
Römeräcker 9 Z2021, 76351
Linkenheim-Hochstetten, Tyskland



Pooledas Group Ltd
Enhet 5 Albert Edward House, The
Pavilions Preston, Storbritannien

VEVOR[®]

TOUGH TOOLS, HALF PRICE

Teknisk support och e-garanticertifikat

www.vevor.com/support

VEVOR[®]

TOUGH TOOLS, HALF PRICE

Soporte técnico y certificado de garantía

electrónica www.vevor.com/support

HACIENDA INFLABLE

MODELO:PL2464

Seguimos comprometidos a proporcionarle herramientas a precios competitivos.

"Ahorre a mitad de precio", "A mitad de precio" o cualquier otra expresión similar utilizada por nosotros solo representa una estimación de los ahorros que podría beneficiarse al comprar ciertas herramientas con nosotros en comparación con las principales marcas y no significa necesariamente cubrir todas las categorías de herramientas ofrecidas por nosotros. Le recordamos que, cuando realice un pedido con nosotros, verifique cuidadosamente si realmente está ahorrando la mitad en comparación con las principales marcas.

MODELO:PL2464

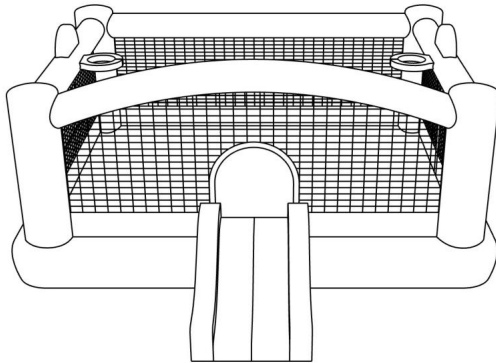

¿NECESITAS AYUDA? ¡CONTÁCTENOS!

¿Tiene preguntas sobre el producto? ¿Necesita soporte técnico? No dude en contactarnos:
Soporte

técnico y certificado de garantía electrónica www.vevor.com/support

Estas son las instrucciones originales; lea atentamente todas las instrucciones del manual antes de operar. VEVOR se reserva una interpretación clara de nuestro manual de usuario. La apariencia del producto estará sujeta al producto que recibió. Perdone que no le informaremos nuevamente si hay actualizaciones de tecnología o software en nuestro producto.

Gorila inflable

El manual del propietario
Edades: 3-10 años

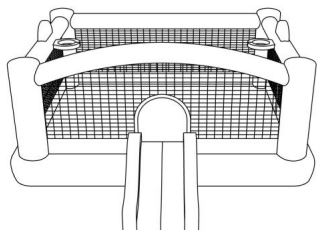

457*447*205 CM
Tamaño aproximado inflado.

⚠ ADVERTENCIA: EL NO SEGUIR ESTAS INSTRUCCIONES PODRÍA RESULTAR EN LESIONES GRAVES O LA MUERTE.

No utilice cables de extensión con este producto. Uso exclusivo en exteriores.
Lea todas las instrucciones antes de ensamblar este dispositivo inflable. Guarde las instrucciones para uso futuro.

⚠ ADVERTENCIA: LOS USUARIOS DEBEN TENER CUIDADO CON LA ORIENTACIÓN DEL HINCHANTE CON RESPECTO

AL SOL. La superficie deslizante no debe ubicarse de cara al sol ya que puede deslumbrar a los niños al utilizar el Hinchable.

LISTA DE PIEZAS PARA EE.UU.

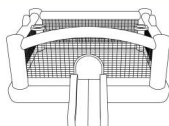

A). 1 gorila inflable



MI). 2 pelotas inflables



B). 1 bolsa de transporte



F). 6 bolas de dardo



C). 6 estacas de gorila



GRAMO). 1 soplador



D). 6 parches de reparación



H). 2 estacas de soplador

LISTA DE PIEZAS PARA UE O AUS

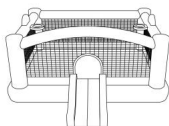

A). 1 gorila inflable



MI). 2 pelotas inflables



B). 1 bolsa de transporte



F). 6 bolas de dardo



C). 6 estacas de gorila



GRAMO). 1 soplador



D). 6 parches de reparación



H). 4 estacas de soplador

⚠ SAFETY WARNINGS: SET UP

ADULT SUPERVISION AND SETUP REQUIRED. This product should be inflated or deflated only by a competent adult. Follow all instructions provided.

WARNING! Falls onto hard surfaces can result in head or other serious injuries. Never place on concrete, asphalt, wood, packed earth, or other hard surfaces. Carpet over hard floors may not prevent injury.

- ⚠ **WARNING! Only for domestic use.** Intended for outdoor domestic family use only. Not for use in public areas or as a rental.
- Product is heavy. Use caution when lifting.
- Product should never be dragged across concrete, pavement or other rough surfaces.
- **WARNING!** Keep away from fire. Keep fabric clear of all flame and ignition sources.
- Do not set up in windy or rainy conditions: sudden gusts of wind may lift the product off the ground.
- Product can be installed in any orientation in relation to the sun, since there are no metal components or surfaces that can absorb excessive solar radiation.
- Set-up in outdoor location only that meets the following criteria:
 - Place on level ground and firm grass or soil to allow proper use of stakes.
 - Placing on slanted or uneven surfaces may cause the product to tip.
 - Stakes should be placed at an angle for better anchorage, should be driven under the ground to prevent tripping.
 - Minimum clearance zones: Place at least 2m away from any other objects.
 - Objects to be avoided include but are not limited to fences, buildings, trees, overhead branches, laundry lines, electrical wires, walls, or bodies or sources of water.
 - Make sure the area around the product is secure by adding safety barriers, if necessary, to keep young children and pets from gaining access.
 - Electrical cord must not be passed under the air filled devices (Inflatable Bouncer with Slide) and interfere with its operation.
- The Bouncer with Slide uses a main powered blower (air pump) to maintain pressure, only to be used by an adult.
- Do not use extension cords with this product. Set up as close to power source as possible. The blower should be securely anchored to the ground before use.
- **CAUTION:** the blower is capable of moving large volumes of air very quickly. Place the blower in an area where it will not draw in dirt or leaves. Keep blower and power cord away from children, water and traffic.
- **ATTENTION:** Blower should remain on and continuously inflate Water Park during use. Airflow through seams is normal
- Do not use the product if wind speed exceeds 30km/h.
- Do not consume food, drink and gum on this product.

Minimum Clearance Zones

MINIMUM CLEARANCE ZONES

Make sure that there is a 2m obstacle-free zone around the product, including a fence, garage, house, overhanging branches, laundry lines or electrical wires.

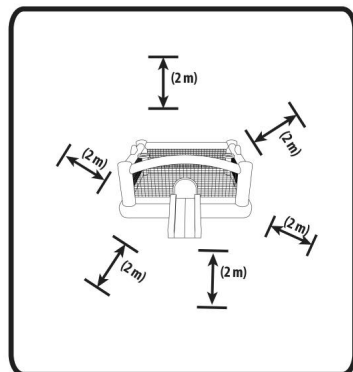

Colocación de la hamaca

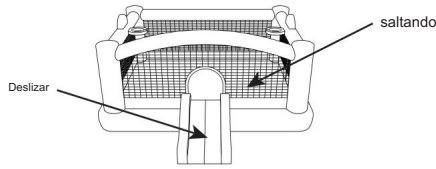

Designate a flat, level surface that allows for 2m of minimum clearance around the Bouncer .

NOTE: DO NOT place the Bouncer with slide on a hard surface like asphalt, concrete or packed earth as both serious bodily injury and damage to the Bounce could result.

ASSEMBLY AREAS

- Make sure the assembly area is flat and level and is free of rocks, sharp objects or other obstructions.
- Do not set up the Bounce on a slope or incline.
- Do not set up the Bounce on hard-packed earth, asphalt, decking or any hard surface as doing so may result in physical injury and/or damage to the Bouncer .
- Once the Bounce inflated or filled with water, do not attempt to drag it to another location.
- Check your local county or city regulations for requirements on securing the pool.
- Secure the pool from unauthorized use.

ADVERTENCIAS DE SEGURIDAD: EL NO SEGUIR ESTAS INSTRUCCIONES PODRÍA RESULTAR EN LESIONES GRAVES O LA MUERTE.



Número máximo de niños: 5



Límite de edad: 3-10



Límite de peso total en tobogán y piscina: 225 kg



Altura mínima (6 supervisión individual de un adulto): requerida. No deje desatendidos a niños de 5 años (152 cm).



Sin objetos punzantes. Sin zapatos, sin gafas.



Sin volar.



No deslice la cabeza primero. Nada de lucha libre.



Límite de peso individual: 45 kg.



Sin manos ni pies en la red. No utilizar en condiciones de viento.



No lo dejes afuera bajo la lluvia.



Manténgase alejado de sopladores y cables eléctricos.



Debe anclarse mediante estacas.

- Se requiere en todo momento la supervisión constante y competente de un adulto de

los niños y otros usuarios jóvenes. • Mantenga el

área alrededor del producto limpia y libre de objetos para evitar resbalones

y caídas. • No permita

que los niños jueguen con el producto hasta que esté completamente inflado.

• No permita que los niños jueguen si está mojado. Séquelo completamente

antes de usarlo. • Este no es un juguete acuático. No debe

usarse en agua. • Instruya a los niños sobre el uso

adecuado de este producto: - Los niños no deben usar ropa holgada o

holgada, bufandas, capuchas o ropa con cordones o cuerdas largas mientras juegan con este

- Los niños deberán quitarse del bolsillo el casco, artículos para la cabeza,

zapatos y gafas, así como cualquier objeto punzante que pueda

perforar la superficie de rebote.

- Nunca se deben permitir juguetes y otros objetos dentro de la hamaca.

- Indique a los niños que no coloquen artículos en el producto que no

estén específicamente diseñados para usarse con el equipo, como, entre

otros, cuerdas para saltar, tendedores, correas para mascotas, cables y

cadena, ya que pueden causar peligro de estrangulamiento.

- Mantenga a las mascotas alejadas del producto.

- Los niños deben alejarse de los demás y mantenerse alejados de las aberturas y paredes laterales.

- Los niños no deben saltar dentro o fuera del producto.

- El peso total de los niños no debe exceder las 500 libras. (225 kg) No deben jugar más de 5 niños al mismo tiempo en la hamaca.

- No permita que jueguen juntos niños que no tengan el mismo peso y altura. • Antes y durante el uso,

verifique si hay pérdida de aire. Verifique que el soplador esté conectado correctamente. •

Revisar siempre el producto y todos sus puntos de anclaje antes y durante su uso, y volver a asegurarlo según corresponda. •

Después de inflar, el soplador debe funcionar continuamente mientras los niños juegan. •

Verifique que no haya ningún usuario sobre el producto antes de

desinflarlo. • Siempre desinfele el producto después de su uso y

guárdelo en el interior. • Para ser

utilizado únicamente en terreno blando. • Se debe disuadir a los usuarios de intentar cualquier modificación no au

El producto debe examinarse periódicamente para detectar condiciones

potencialmente inseguras, como: cable, enchufe, carcasa o piezas dañados, y

en caso de que se encuentren dichos daños, el producto no debe usarse hasta

que se repare adecuadamente. Nunca deje el ventilador afuera bajo la lluvia

o elementos cuando no esté en uso. Consulte las instrucciones de instalación,

almacenamiento, mantenimiento y cuidado.

Apostar al gorila

⚠ PRECAUCIONES: La Hamaca y todos sus puntos de anclaje deben ser revisados antes y durante su uso.

Vuelva a inflar o asegurar según corresponda. ¡NO deje que los niños jueguen en la hamaca hasta que esté completamente inflada!

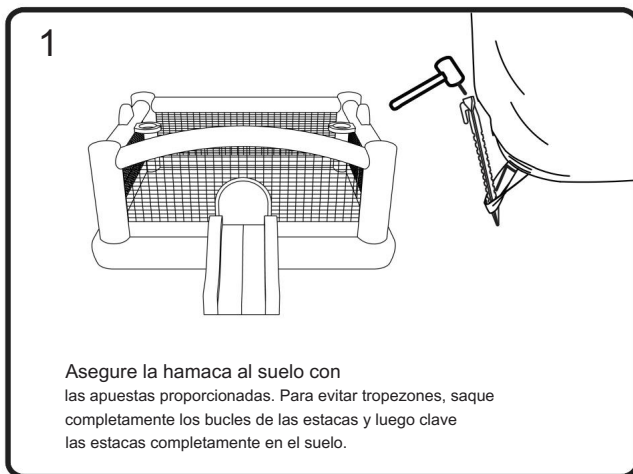

⚠ PRECAUCIONES PARA EL Bouncer:

- Clave las estacas para el suelo completamente en el suelo para evitar riesgos de tropiezo.
- No utilice la hamaca hasta que esté correctamente montada, anclada al suelo y completamente inflada. Los adultos competentes deben terminar todos los pasos del montaje.
- No instale ni infle la hamaca con SLide en condiciones de viento y/o lluvia, ya que las ráfagas de viento pueden causar que el parque se vuelva inestable y posiblemente se levante del suelo.

Configuración

1 Remove Water park from its packaging

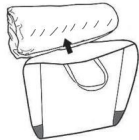

2



Unroll and unfold the Water park in the center of the designated area.

3



4

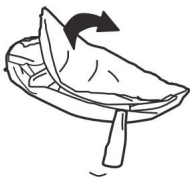

5



6

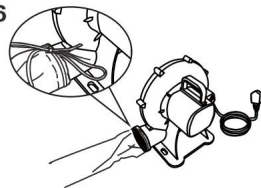

7

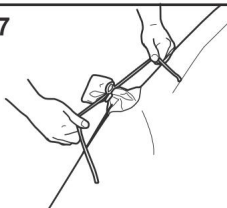

Tie off the short Air Outlet Tube tightly to make a good seal.

8

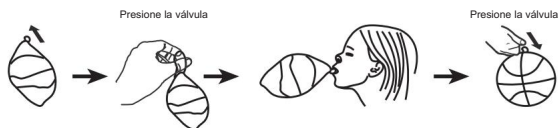

Presione la válvula

Presione la válvula

Infle la pelota de baloncesto inflable y el balón de fútbol inflable con la boca y luego presione el orificio de soplado para que quede plano.

INFLACIÓN Y APUESTA

Asegure la hamaca al suelo con las estacas proporcionadas. Para evitar tropiezos, tire de los bucles de las estacas hasta el final y luego impulsar las apuestas por completo en el suelo.

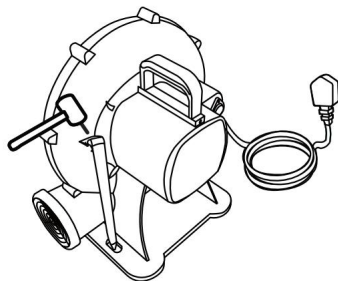
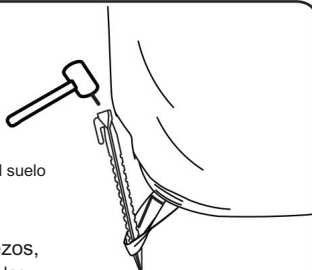

ALMACENAMIENTO

- 1 Turn off the air pump and motor, then unplug it from the outlet.

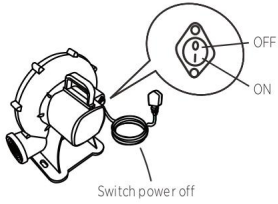

- 2 Untie the drawstring from the short Outlet Tube and allow the bouncer with slide to fully deflate. Remove the Hose Assembly and wrap it up with no kinks.



3



4

Doblar solo



5

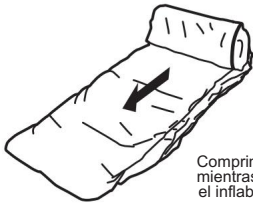

Comprime el aire mientras enrollas el inflable.

6

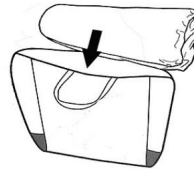

INSTRUCCIONES DEL PARCHE DE REPARACIÓN



ADVERTENCIA: Los parches reparadores deben ser aplicados únicamente por adultos.
MANTENER FUERA DEL ALCANCE DE LOS NIÑOS.

INSTRUCCIÓN:

1. Desinfe el artículo, limpie el área y déjelo secar completamente.
2. Corte una porción del parche al tamaño necesario y redondee las esquinas. (Ver figura).
3. Retire el respaldo adhesivo de la material del parche, coloque el parche sobre el área dañada y alise las burbujas.
4. Déjelo reposar durante 30 minutos antes de volver a inflarlo.

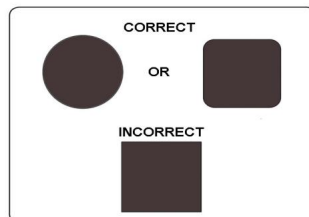

INSTRUCCIONES PARA MANTENIMIENTO DEL VENTILADOR

INSTRUCCIONES PARA EL Bouncer MANTENIMIENTO

- Como producto para exteriores, la hamaca está sujeta a desgaste y deterioro. Inspeccione en busca de signos de falla de la tela; Las superficies débiles o rotas deben repararse rápidamente.
- Para mantener el producto limpio: limpie la hamaca o el soplador con un paño seco o humedecido con una solución limpiadora y desinfectante neutra, no infli amable y no tóxica. o agua pura.
- El producto nunca debe almacenarse mojado. Dejar secar antes de enrollar.

- El soplador debe estar desenchufado antes de realizarle mantenimiento.
- Si el cable de alimentación está dañado, debe ser reemplazado por personas calificadas para evitar riesgos.
- El producto debe examinarse periódicamente para detectar condiciones potencialmente inseguras, como cables, enchufes, carcasas o piezas dañados, y que, incluso si se encontraran dichos daños, el producto no debe utilizarse hasta que se haya reparado adecuadamente. Si estos Si no se realizan controles, el producto podría volcarse o convertirse en un peligro.
- El soplador no requiere lubricación y no tiene piezas reparables por el usuario. No intente reparar el soplador.
- No sumerja el ventilador en agua. Para limpiar, limpie con un paño húmedo.
- Revisar periódicamente las aberturas de entrada y salida y mantenerlas libres de suciedad, hojas, etc.
- Cuando no esté en uso, guarde el soplador en el interior, en un lugar seco.
- Guarde el soplador en posición vertical sobre una superficie estable.
- Enrolle el cable sin apretarlo y colóquelo al lado del soplador.
- Cuando esté en uso, no coloque el cable sobre áreas de tránsito, agua o áreas húmedas.
- El soplador es un soplador de gran volumen y es capaz de moviendo grandes volúmenes de aire muy rápidamente. Coloque el soplador en un área donde no aspire suciedad ni hojas.

ELIMINACIÓN CORRECTA



¡Cuidemos el medio ambiente! El símbolo del contenedor con ruedas indica que el producto no debe desecharse junto con otros residuos domésticos. Utilice los puntos de recogida designados o las instalaciones de reciclaje cuando deseche el artículo.

Conserve este manual ya que contiene información importante.

Dirección: Baoshanqu Shuangchenglu 803long 11hao 1602A-1609shi

Llevar a la fuerza

Importado a AUS: SIHAO PTY LTD, 1 ROKEVA STREET EASTWOOD

Nueva Gales del Sur 2122 Australia

Importado a EE. UU.: Sanven Technology Ltd, Suite 250, 9166 Anaheim

Lugar, Rancho Cucamonga, CA 91730



SHUNSHUN GmbH
Römeräcker 9 Z2021, 76351
Linkenheim-Hochstetten, Alemania

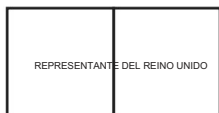

Grupo Pooledas Ltd
Unidad 5 Casa Albert Edward, La
Pabellones Preston, Reino Unido

VEVOR[®]

TOUGH TOOLS, HALF PRICE

Soporte técnico y certificado de garantía
electrónica www.vevor.com/support

VEVOR[®]

TOUGH TOOLS, HALF PRICE

Supporto tecnico e certificato di garanzia

elettronica www.vevor.com/support

SDRAIETTA GONFIABILE

MODELLO:PL2464

Continuiamo a impegnarci per fornirvi strumenti a prezzi competitivi.

"Risparmia la metà", "Metà prezzo" o qualsiasi altra espressione simile da noi utilizzata rappresenta solo una stima del risparmio che potresti trarre dall'acquistare determinati strumenti con noi rispetto ai principali marchi più importanti e non significa necessariamente coprire tutte le categorie di strumenti offerti da noi. Ti ricordiamo gentilmente di verificare attentamente quando effettui un ordine con noi se stai effettivamente risparmiando la metà rispetto ai migliori marchi principali.

VEVOR®

TOUGH TOOLS, HALF PRICE

SDRAIETTA GONFIABILE

MODELLO:PL2464

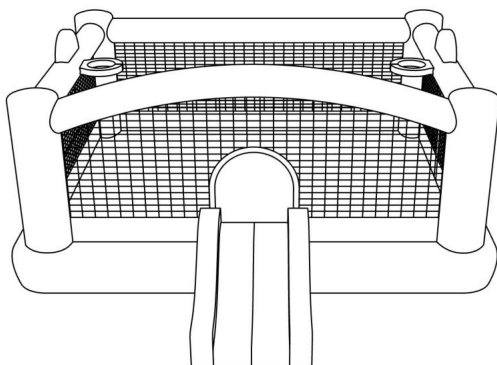

HO BISOGNO DI AIUTO? CONTATTACI!

Hai domande sul prodotto? Hai bisogno di supporto tecnico? Non esitate a contattarci:

Supporto

**tecnico e certificato di garanzia elettronica [www.vevor.com/
support](http://www.vevor.com/support)**

Queste sono le istruzioni originali, leggere attentamente tutte le istruzioni del manuale prima dell'uso. VEVOR si riserva una chiara interpretazione del nostro manuale d'uso. L'aspetto del prodotto sarà soggetto al prodotto ricevuto. Ti preghiamo di perdonarci se non ti informeremo più se sono presenti aggiornamenti tecnologici o software sul nostro prodotto.

Buttafuori gonfiabile

Manuale del proprietario
Età: 3-10 anni

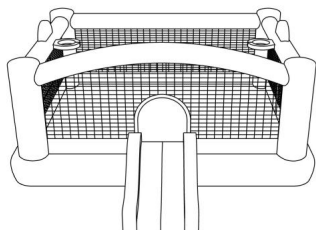

457*447*205 cm
Dimensioni approssimative gonfiate

⚠ ATTENZIONE: LA MANCATA OSSERVANZA DI QUESTE ISTRUZIONI POTREBBE CAUSARE LESIONI GRAVI O MORTE.

Non utilizzare prolunghe con questo prodotto. Solo per uso esterno.
Leggere tutte le istruzioni prima di montare questo dispositivo gonfiabile. Conservare le istruzioni per un uso futuro.

⚠ ATTENZIONE: GLI UTENTI DEVONO PRESTARE ATTENZIONE ALL'ORIENTAMENTO DEL GONFIABILE RISPETTO AL SOLE. La superficie scorrevole non deve essere posizionata rivolta verso il sole poiché può abbagliare i bambini durante l'utilizzo del gonfiabile.

ELENCO PARTI PER GLI USA

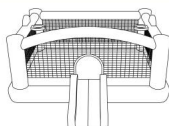

UN). 1 buttafuori gonfiabile



B). 1 borsa per il trasporto



C). 6 lanciate dei buttafuori



D). 6 toppe di riparazione



E). 2 palloni gonfiabili



F). 6 palline bersaglio per freccette



G). 1 ventilatore



H). 2 picchetti del soffiatore

ELENCO PARTI PER EU O AUS

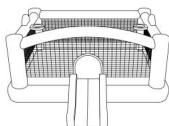

UN). 1 buttafuori gonfiabile



B). 1 borsa per il trasporto



C). 6 lanciate dei buttafuori



D). 6 toppe di riparazione



E). 2 palloni gonfiabili



F). 6 palline bersaglio per freccette



G). 1 ventilatore



H). 4 picchetti del soffiatore

⚠️ SAFETY WARNINGS: SET UP

ADULT SUPERVISION AND SETUP REQUIRED. This product should be inflated or deflated only by a competent adult. Follow all instructions provided.

WARNING! Falls onto hard surfaces can result in head or other serious injuries. Never place on concrete, asphalt, wood, packed earth, or other hard surfaces. Carpet over hard floors may not prevent injury.

- ⚠️ **WARNING! Only for domestic use.** Intended for outdoor domestic family use only. Not for use in public areas or as a rental.
- Product is heavy. Use caution when lifting.
- Product should never be dragged across concrete, pavement or other rough surfaces.
- **WARNING!** Keep away from fire. Keep fabric clear of all flame and ignition sources.
- Do not set up in windy or rainy conditions: sudden gusts of wind may lift the product off the ground.
- Product can be installed in any orientation in relation to the sun, since there are no metal components or surfaces that can absorb excessive solar radiation.
- Set-up in outdoor location only that meets the following criteria:
 - Place on level ground and firm grass or soil to allow proper use of stakes.
 - Placing on slanted or uneven surfaces may cause the product to tip.
 - Stakes should be placed at an angle for better anchorage, should be driven under the ground to prevent tripping.
 - Minimum clearance zones: Place at least 2m away from any other objects.
 - Objects to be avoided include but are not limited to fences, buildings, trees, overhead branches, laundry lines, electrical wires, walls, or bodies or sources of water.
 - Make sure the area around the product is secure by adding safety barriers, if necessary, to keep young children and pets from gaining access.
 - Electrical cord must not be passed under the air filled devices (Inflatable Bouncer with Slide) and interfere with its operation.
- The Bouncer with Slide uses a main powered blower (air pump) to maintain pressure, only to be used by an adult.
- Do not use extension cords with this product. Set up as close to power source as possible. The blower should be securely anchored to the ground before use.
- **CAUTION:** the blower is capable of moving large volumes of air very quickly. Place the blower in an area where it will not draw in dirt or leaves. Keep blower and power cord away from children, water and traffic.
- **ATTENTION:** Blower should remain on and continuously inflate Water Park during use. Airflow through seams is normal
- Do not use the product if wind speed exceeds 30km/h.
- Do not consume food, drink and gum on this product.

Minimum Clearance Zones

MINIMUM CLEARANCE ZONES

Make sure that there is a 2m obstacle-free zone around the product, including a fence, garage, house, overhanging branches, laundry lines or electrical wires.

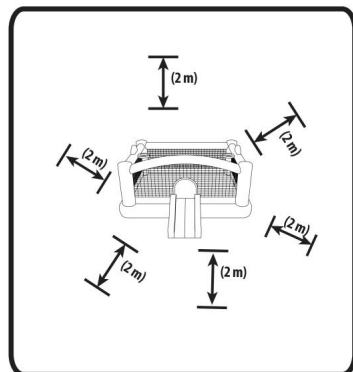

Posizionamento dei buttafuori

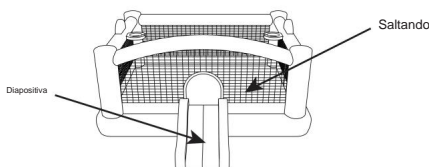

Designate a flat, level surface that allows for 2m of minimum clearance around the Bouncer .

NOTE: DO NOT place the Bouncer with slide on a hard surface like asphalt, concrete or packed earth as both serious bodily injury and damage to the Bounce could result.

ASSEMBLY AREAS

- Make sure the assembly area is flat and level and is free of rocks, sharp objects or other obstructions.
- Do not set up the Bounce on a slope or incline.
- Do not set up the Bounce on hard-packed earth, asphalt, decking or any hard surface as doing so may result in physical injury and/or damage to the Bouncer .
- Once the Bounce inflated or filled with water, do not attempt to drag it to another location.
- Check your local county or city regulations for requirements on securing the pool.
- Secure the pool from unauthorized use.

AVVERTENZE DI SICUREZZA: LA MANCATA OSSERVANZA DI QUESTE ISTRUZIONI POTREBBE CAUSARE LESIONI GRAVI O MORTE.



Numero massimo di bambini: 5



Limite di età: 3-10



Limite di peso totale su scivolo e piscina: 225 kg



Altezza massima individuale della supervisione di un adulto: richiesta. Non lasciare incustoditi i bambini alti 5 piedi (152 cm).



Nessun oggetto appuntito. Niente scarpe, niente occhiali.



Nessun animale domestico.



Non far scivolare la testa per prima. Niente lottò.



Limite di peso individuale: 45 kg.



Niente mani o piedi sulla rete. Non utilizzare in condizioni di vento.



Non lasciare fuori sotto la pioggia.



Stare lontano da ventilatori e cavi elettrici



Deve essere ancorato mediante picchetti.

• È richiesta in ogni momento la supervisione costante e competente di bambini e

altri giovani utenti. • Mantenere l'area intorno al

prodotto pulita e priva di oggetti per evitare scivolamenti e cadute. • Non consentire ai bambini di

giocare nel prodotto finché non è completamente gonfiato. • Non permettere ai bambini di giocarci sopra se sono bagnati. Asciugare accuratamente prima dell'uso. •Questo non è un giocattolo acquatico. Non deve essere utilizzato in acqua. • Istruire i bambini sull'uso

corretto di questo prodotto: - I bambini non devono indossare indumenti larghi o larghi, scarpe, cappucci o indumenti con lacci o corde lunghe mentre giocano con questo prodotto.

- I bambini devono togliere dalle tasche caschi, copricapo, scarpe e occhiali, nonché eventuali oggetti appuntiti, poiché potrebbero forare la superficie gonfiabile.

- Non devono mai essere ammessi giocattoli e altri oggetti all'interno della sdraietta.

- Chiedere ai bambini di non attaccare al prodotto oggetti che non siano specificatamente progettati per l'uso con l'attrezzatura, come, ma non limitati a, corde per saltare, stendibiancheria, guinzagli per animali domestici, cavi e catene poiché potrebbero causare pericolo di strangolamento.

- Tenere gli animali lontani dal prodotto.

- I bambini dovrebbero rimbalzare lontano dagli altri e stare lontano dalle aperture e dalle pareti laterali.

- I bambini non devono saltare sul o scendere dal prodotto.

- Il peso totale dei bambini non deve superare le 500 libbre. (225 kg) Non più di 5 bambini possono giocare contemporaneamente sulla sdraietta.

- Non permettere che giochino insieme bambini che non sono uguali in peso e altezza. • Prima e durante l'uso,

verificare la presenza di perdite d'aria. Controllare che il ventilatore sia collegato correttamente. •

Controllare sempre il prodotto e tutti i suoi punti di ancoraggio prima e durante l'uso e fissarli nuovamente in modo appropriato. • Dopo il

gonfiaggio, il ventilatore deve funzionare continuamente mentre i bambini giocano. • Verificare che nessun utente sia sul prodotto prima di sgonfiarlo. • Sgonfiare sempre il prodotto

dopo l'uso e conservarlo al chiuso. • Da utilizzare solo su terreni

morbidici. • Gli utenti devono essere

scoraggiati dal tentare qualsiasi modifica non autorizzata.

Il prodotto deve essere periodicamente esaminato per verificare la presenza di condizioni

potenzialmente pericolose quali: cavo, spina, alloggiamento o parti danneggiate e, nel caso in cui venga riscontrato tale danno, il prodotto non deve essere utilizzato finché non

viene adeguatamente riparato. Non lasciare mai il ventilatore fuori dalla pioggia o

dagli elementi quando non è in uso. Fare riferimento alle istruzioni per l'installazione, la conservazione, la manutenzione e la cura.

Picchettare il buttafuori

⚠ ATTENZIONE: La sdraietta e tutti i suoi punti di ancoraggio devono essere controllati prima e durante l'uso.

Rigonfiare o fissare nuovamente a seconda dei casi. **NON** lasciare che i bambini giochino sulla sdraietta finché non è completamente gonfia!

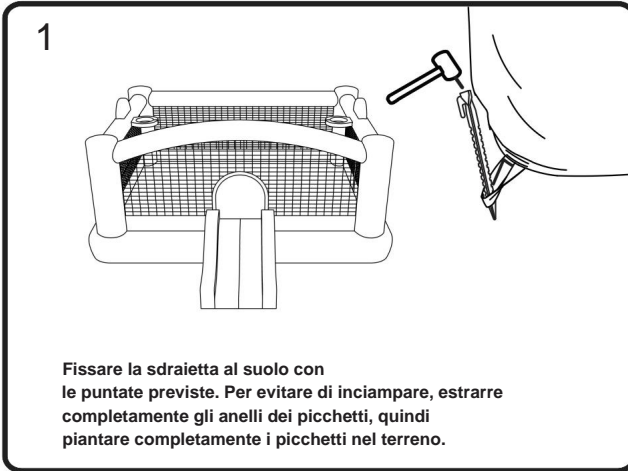

⚠ AVVERTENZE SULLA SBALLACCIA:

- Conficcare completamente i picchetti nel terra per evitare il rischio di inciampare.
- Si prega di non utilizzare la sdraietta finché non è correttamente assemblata, ancorata al terreno e completamente gonfiata. Gli adulti competenti dovrebbero completare tutte le fasi di assemblaggio.
- Non installare o gonfiare la sdraietta con SLide in condizioni di vento e/o pioggia le raffiche di vento potrebbero rendere instabile il parco ed eventualmente sollevarlo da terra.

Impostare

1 Remove Water park from its packaging



2



Unroll and unfold the Water park in the center of the designated area.

3

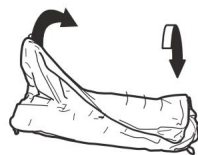

4

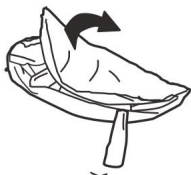

5

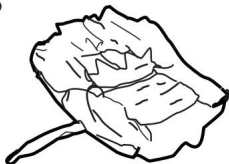

6

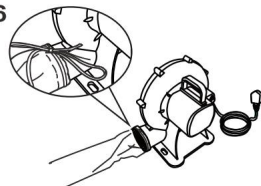

7

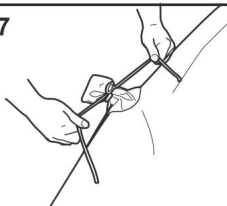

Tie off the short Air Outlet Tube tightly to make a good seal.

8

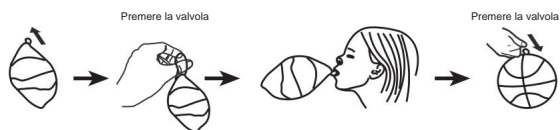

Gonfiare il pallone da basket gonfiabile e il pallone da calcio gonfiabile con la bocca, quindi premere il foro di sfiato in posizione piatta.

INFLAZIONE E PUNTATA

Fissare la sdraietta al suolo con i picchetti forniti. Per evitare di inciampare, quindi tira fuori completamente gli anelli del picchetto guidare completamente i paletti nel terreno.

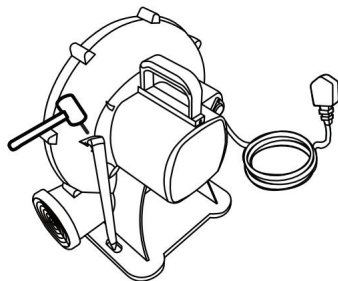
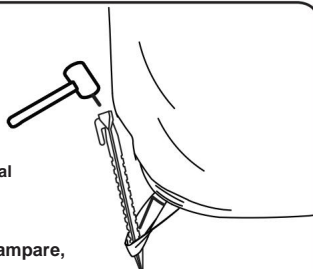

MAGAZZINAGGIO

- 1 Turn off the air pump and motor, then unplug it from the outlet.

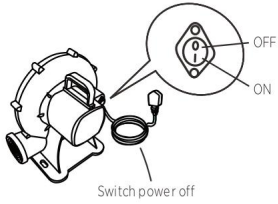

- 2 Untie the drawstring from the short Outlet Tube and allow the bouncer with slide to fully deflate. Remove the Hose Assembly and wrap it up with no kinks.

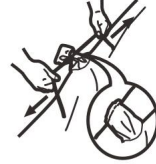

3



4

Solo piegatura



5

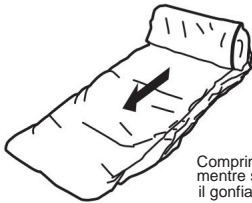

Comprimere l'aria mentre si arrotola il gonfiabile

6

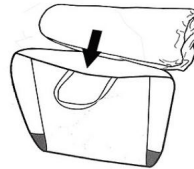

ISTRUZIONI PER LA PATCH DI RIPARAZIONE



ATTENZIONE: i cerotti di riparazione devono essere applicati solo da adulti. TENERE FUORI DALLA PORTATA DEI BAMBINI.

ISTRUZIONI:

1. Sgonfiare l'oggetto, pulire l'area e lasciarlo asciugare completamente.
2. Taglia una porzione della toppa alla misura necessaria e arrotonda gli angoli. (Vedi figura).
3. Rimuovere la protezione adesiva dal materiale del cerotto, posizionare il cerotto sull'area danneggiata e appianare eventuali bolle.
4. Lasciare riposare per 30 minuti prima di rigonfiare.

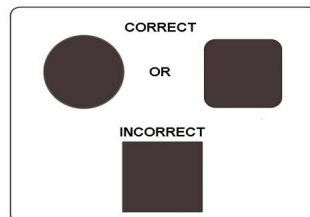

ISTRUZIONI PER BOTTEGA MANUTENZIONE

- Essendo un prodotto per esterni, la sdraietta è soggetta ad usura e deterioramento. Ispezionare eventuali segni di cedimento del tessuto; le superfici deboli o strappate devono essere riparate tempestivamente.
- Per mantenere il prodotto pulito: pulire la sdraietta o il ventilatore utilizzando un panno asciutto o inumidito con una soluzione detergente e igienizzante neutra, non infiammabile e non tossica o acqua pura.
- Il prodotto non deve mai essere conservato bagnato. Lasciare asciugare prima di arrotolare.

ISTRUZIONI PER MANUTENZIONE DEL SOFFIATORE

- Il ventilatore deve essere scollegato prima della manutenzione.
 - Se il cavo di alimentazione è danneggiato, deve essere sostituito da personale qualificato per evitare pericoli
 - Il prodotto deve essere periodicamente esaminato per individuare condizioni potenzialmente pericolose quali cavo, spina, alloggiamento o parti danneggiate e, anche qualora si riscontrassero tali danni, il prodotto non deve essere utilizzato finché non viene adeguatamente riparato. Se questi non vengono effettuati controlli, il prodotto potrebbe ribaltarsi o comunque costituire pericolo.
 - Il soffiatore non richiede alcuna lubrificazione e non ha parti riparabili dall'utente. Non tentare di riparare il soffiatore.
 - Non immergere il ventilatore in acqua. Per pulire, strofinare con un panno umido.
 - Controllare regolarmente le aperture di aspirazione e di uscita e mantenerle libere da sporco, foglie, ecc.
 - Quando non viene utilizzato, riporre il soffiatore al chiuso in un luogo asciutto.
 - Conservare il soffiatore in posizione verticale su una superficie stabile.
 - Avvolgere il cavo senza stringere e posizionarlo accanto al soffiatore.
 - Durante l'uso, non posizionare il cavo in aree trafficate, acqua o aree umide.
- Il soffiatore è un soffiatore ad alto volume ed è in grado di muovere grandi volumi d'aria molto rapidamente. Posizionare il soffiatore in un'area in cui non attriti sporco o foglie.

CORRETTA SMALTIMENTO



"Prendiamoci cura dell'ambiente!" Il simbolo del bidone della spazzatura indica che il prodotto non deve essere smaltito con gli altri rifiuti domestici. Si prega di utilizzare punti di raccolta designati o strutture di riciclaggio per lo smaltimento dell'articolo.

Si prega di conservare questo manuale poiché contiene informazioni importanti.

Indirizzo: Baoshanqu Shuangchenglu 803long 11hao 1602A-1609shi
Shangai

Importato in Australia: SIHAO PTY LTD, 1 ROKEVA STREETEASTWOOD
NSW 2122Australia

Importato negli Stati Uniti: Sanven Technology Ltd, Suite 250, 9166 Anaheim
Luogo, Rancho Cucamonga, CA 91730



SHUNSHUN GmbH
Römeräcker 9 Z2021, 76351
Linkenheim-Hochstetten, Germania

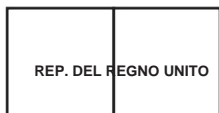

Gruppo Pooledas Ltd
Unità 5 Casa Albert Edward, The
Padiglioni Preston, Regno Unito

VEVOR[®]

TOUGH TOOLS, HALF PRICE

**Supporto tecnico e certificato di garanzia
elettronica www.vevor.com/support**