

VEVOR[®]

TOUGH TOOLS, HALF PRICE

Technical Support and E-Warranty Certificate www.vevor.com/support

WATERPROOF SHOWER SUBSTRATE

MODEL:JQ-3860P

We continue to be committed to provide you tools with competitive price.

"Save Half", "Half Price" or any other similar expressions used by us only represents an estimate of savings you might benefit from buying certain tools with us compared to the major top brands and dose not necessarily mean to cover all categories of tools offered by us. You are kindly reminded to verify carefully when you are placing an order with us if you are actually saving half in comparison with the top major brands.

VEVOR[®]

TOUGH TOOLS, HALF PRICE

WATERPROOF SHOWER
SUBSTRATE

MODEL:JQ-3860P

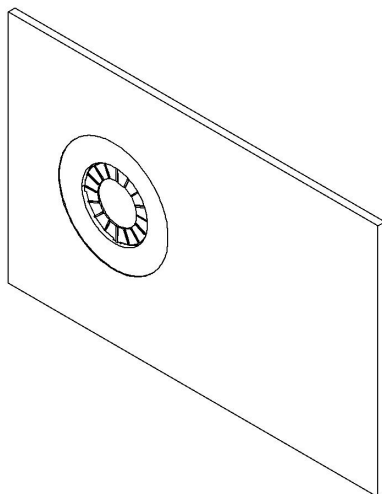

NEED HELP? CONTACT US!

Have product questions? Need technical support? Please feel free to contact us:



Technical Support and E-Warranty Certificate
www.vevor.com/support

This is the original instruction, please read all manual instructions carefully before operating. VEVOR reserves a clear interpretation of our user manual. The appearance of the product shall be subject to the product you received. Please forgive us that we won't inform you again if there are any technology or software updates on our product.

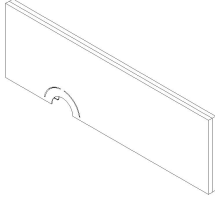

Warning-To reduce the risk of injury, user must read instructions manual carefully.

Part List

Code	Name	Picture	QTY.
A	Tray 1		1
B	Tray 2		1
C	Waterproof Cloth		1

Model	Specification (inch)	Colour	Shower Tray Hole
JQ-3636	38*36	Gray	Centre
JQ-4872	48*72		Centre
JQ-6038	60*38		Centre
JQ-7272	72*72		Centre

INSTALLATION STEPS

◆ Clean any dust or other debris from the surface of the solid backing. Dampen particularly dry and porous substrates in order to help prevent premature drying or skinning of the thin-set mortar.





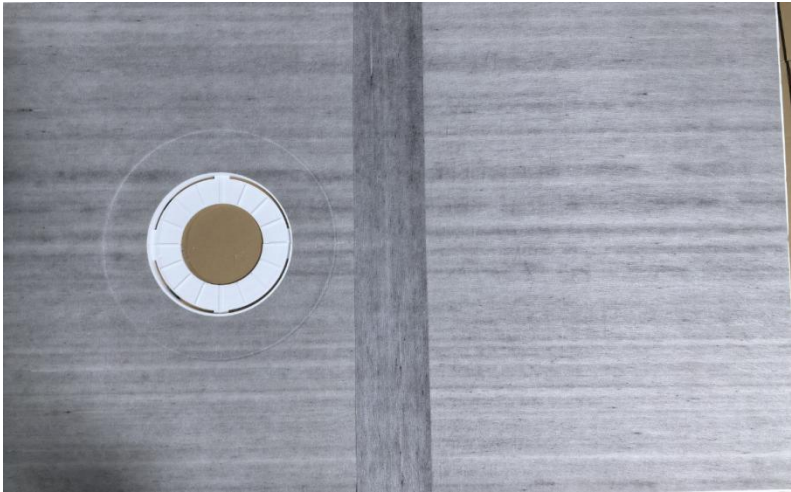

Step 1:



Cover the mixing valve seal(Not provide)



Make the surface even

Step 2:





Unfold the tray



Embed the tray in the mortar



Step 3:

	
Brush the mortar	Install the waterproofing corners(Not provide)
	Trim the corner(Not provide)

Step 4:

	
Brush the mortar	Cover the waterproofing strip(Not provide)
	
Make the surface even	

Step 5:

	
Brush the mortar	Cover the pipe seal
	Trim the pipe seal(Not provide)

Step 6:

	
Brush the mortar	Press the bonding flange into the mortar(Not provide)
	
Rotate the flange to fix it firmly	Brush the mortar around



Trim the surface



Cover the waterproofing membrane(Not provide)



Make the surface even

Step 7:



Install the drain adjustment ring(Not provide)



Ensure full coverage

Manufacturer: Shanghaimuxinmuyeyouxiangongsi

Address: Shuangchenglu 803nong11hao1602A-1609shi, baoshanqu, shanghai 200000 CN.

Imported to AUS: SIHAO PTY LTD. 1 ROKEVA STREETEASTWOOD NSW 2122 Australia

Imported to USA: Sanven Technology Ltd. Suite 250, 9166 Anaheim Place, Rancho Cucamonga, CA 91730



E-CrossStu GmbH
Mainzer Landstr.69, 60329 Frankfurt am Main.



YH CONSULTING LIMITED.
C/O YH Consulting Limited Office 147, Centurion House, London Road, Staines-upon-Thames, Surrey, TW18 4AX

VEVOR[®]

TOUGH TOOLS, HALF PRICE

Technical Support and E-Warranty Certificate

www.vevor.com/support