

VEVOIT

TOUGH TOOLS, HALF PRICE

Technical Support and E-Warranty Certificate www.vevor.com/support

TELEVISION STAND USER MANUAL

MODEL: TV16-Y

We continue to be committed to provide you tools with competitive price. "Save Half", "Half Price" or any other similar expressions used by us only represents an estimate of savings you might benefit from buying certain tools with us compared to the major top brands and does not necessarily mean to cover all categories of tools offered by us. You are kindly reminded to verify carefully when you are placing an order with us if you are actually saving half in comparison with the top major brands.

VEVOR®

TOUGH TOOLS, HALF PRICE

TELEVISION STAND

MODEL:TV16-Y



NEED HELP? CONTACT US!

Have product questions? Need technical support? Please feel free to contact us:

公 CustomerService@vevor.com

This is the original instruction, please read all manual instructions carefully before operating. VEVOR reserves a clear interpretation of our user manual. The appearance of the product shall be subject to the product you received. Please forgive us that we won't inform you again if there are any technology or software updates on our product.

SAFETY INSTRUCTIONS

WARNING:

Read this material before using this product. Failure to do so can result in serious injury.

Assembly precautions

- 1 .Assemble only according to these instructions. Improper assembly can create hazards.
2. Wear ANSI-approved safety goggles and heavy-duty work gloves during assembly.
3. Keep assembly area clean and well lit.
4. Keep bystanders out of the area during assembly.
5. Do not assemble when tired or when under the influence of alcohol, drugs or medication.
6. Weight capacity and other product capabilities apply to properly and completely assembled product only.
7. Assemble on a flat, level, hard and smooth surface capable of safely supporting a fully loaded Television Stand.

Use precautions

TO PREVENT SERIOUS INJURY AND DEATH FROM TIPPING:

1. **DO NOT SIT, STAND OR CLIMB ON THIS ITEM.**
2. This product is not a toy. Do not allow children to play with or near this item.
3. Do not exceed rated listed weight. Serious injury or property damage may occur!.
4. Use only on a flat, level, hard and smooth surface capable of safely supporting a fully loaded Television Stand.
5. Do not lift while loaded.
6. Use as intended only.
7. Inspect before every use; do not use if parts are loose or damaged.

SAVE THIS MANUAL

PRODUCT PARAMETER

Model	TV16-Y
Bearing Weight	90lbs Max
Mounting Dimension	Max:400x400mm/16"x16" Min:75x75mm/3"x3'
Screen Size	55" Max
Product Size	670x435x260mm
Net Weight	4.40 kg
Gross Weight	4.65 kg

PARTS LIST



\wedge 3^{\wedge} Plastic Washer
 雲鵬 Steel Washer

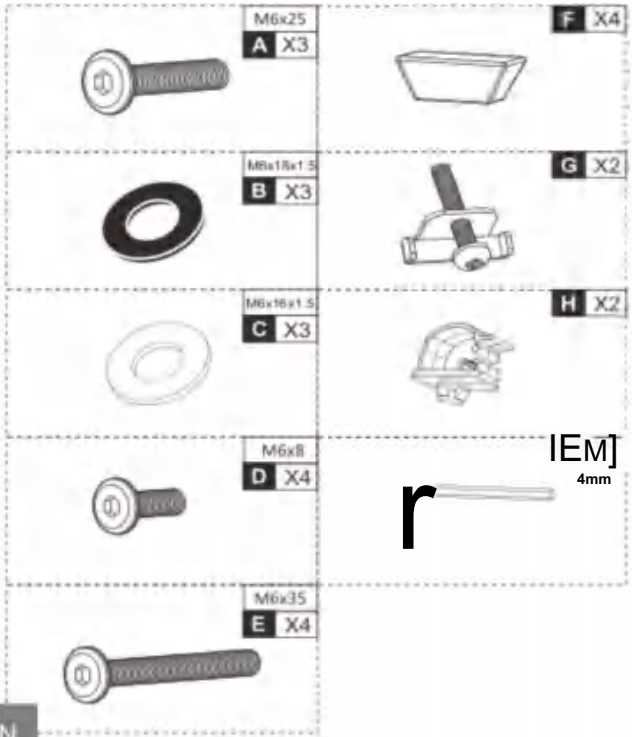

FORTVINSTALLATI ON

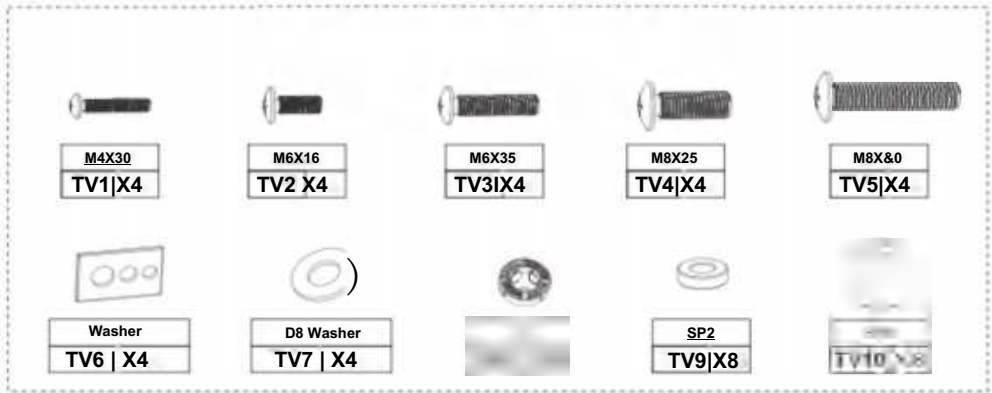

ASSEMBLY STEP

1

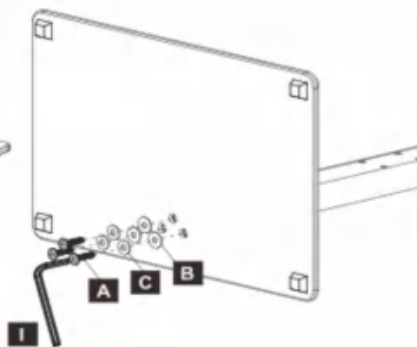
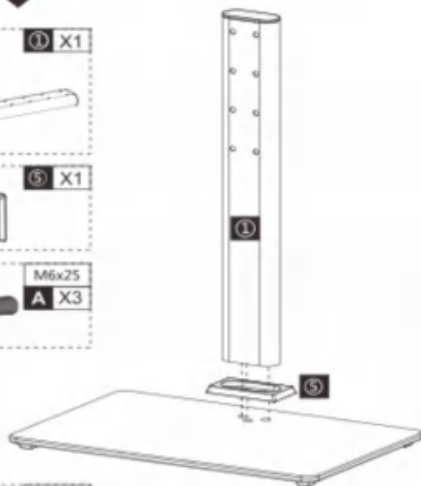
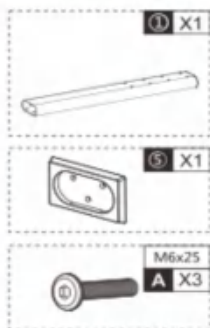
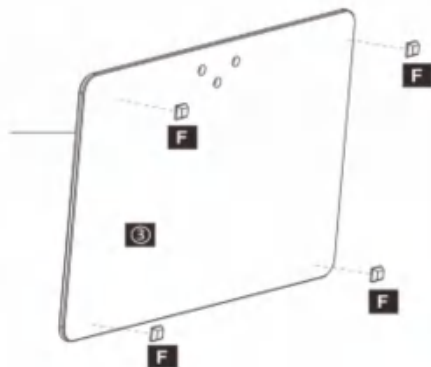
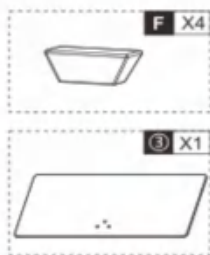

2

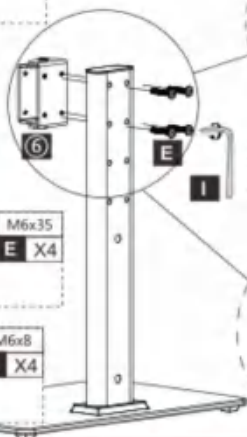

Note: There are three choices for height adjustment

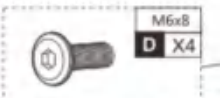

First Choice for Height Adjustment

Second Choice for Height Adjustment

Third choice for height Adjustment

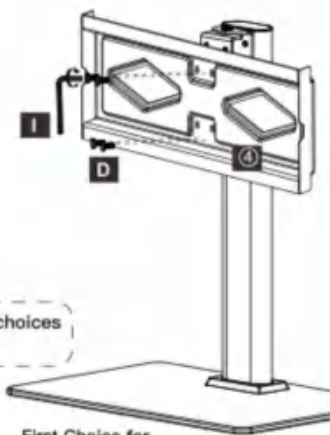

3

Measure the TV fixing holes Width and Height

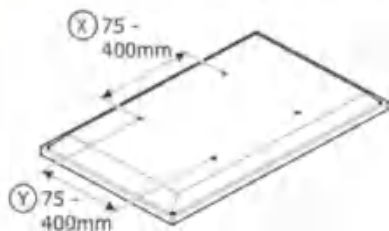

If width (X) is greater than 600mm or height (Y) greater than 400mm STOP installation now and contact the customer help line

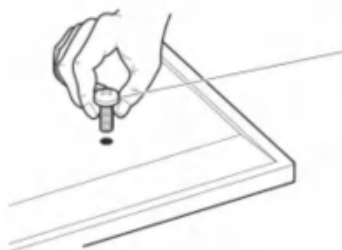

TV1

TV2-3

TV4-5

You are provided with 4 diameters of TV fixing screws, **M4**, **M6** and **M8**. Determine the screw diameter that fits.

Spacers

SP

For TVs with irregular/obstructed back



No Spacers

For TVs with flat/unobstructed back

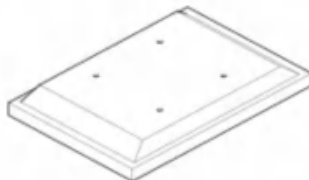

WARNING

please keep for future reference.

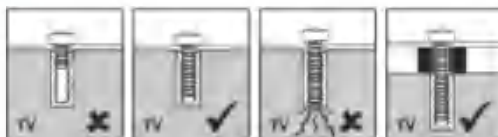

4

NOT INCLUDED

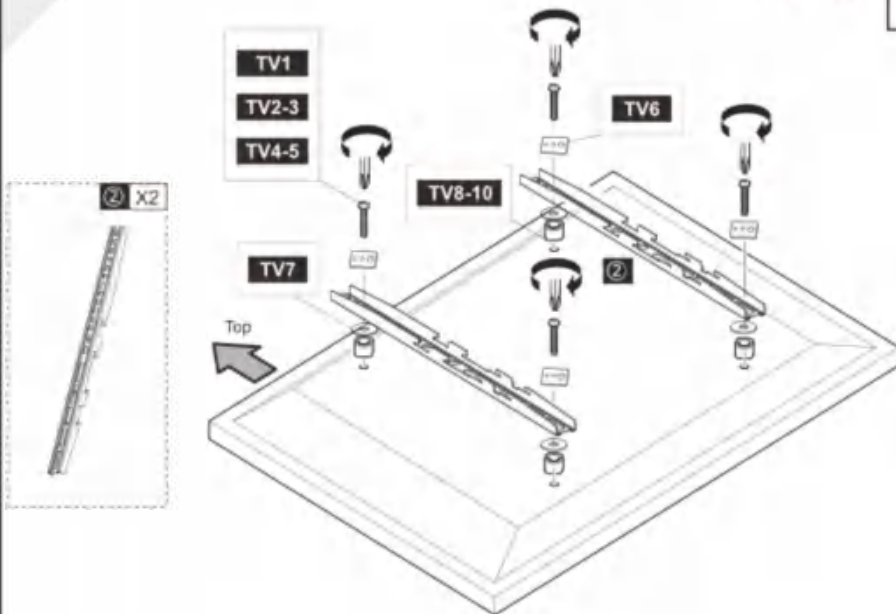

+

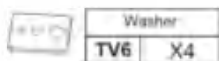

+



+



o



+

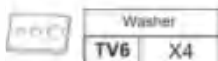

+



+



o



+

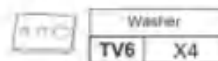

+



+



o

Attach the bracket to the back of your TV using suitable screw, reducer and spacer combinations.

5

NOT INCLUDED

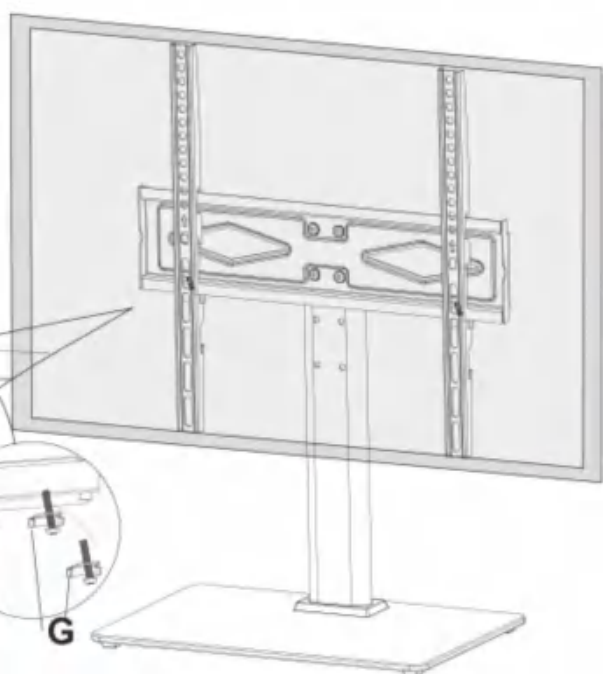
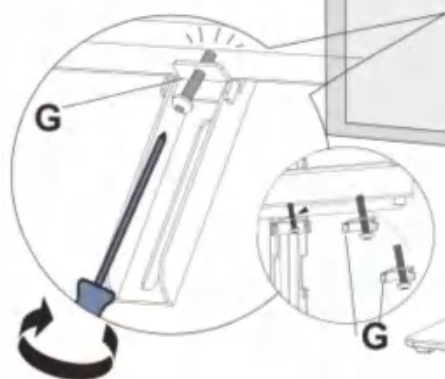
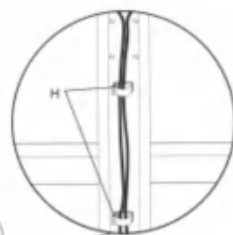
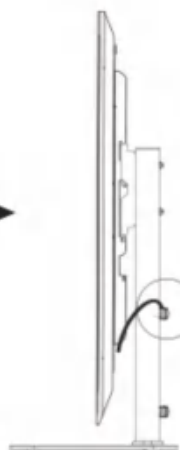
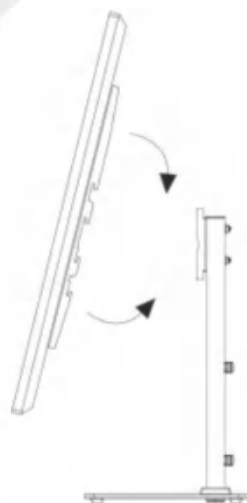

Manufacturer: Shanghaimuxinmuyeyouxiangongsi

Address: Shuangchenglu 803nong11 hao1602A-1609shi,
baoshanqu, shanghai 200000 CN.

Imported to AUS: SIHAO PTY LTD. 1 ROKEVA STREETEAST-
WOOD NSW 2122 Australia

Imported to USA: Sanven Technology Ltd. Suite 250, 9166
Anaheim Place, Rancho Cucamonga, CA91730



E-CrossStu GmbH
Mainzer Landstr.69, 60329 Frankfurt am Main.



YH CONSULTING LIMITED.
C/O YH Consulting Limited Office 147, Centurion House,
London Road, Staines-upon-Thames, Surrey, TW18 4AX

VEVOR[®]

TOUGH TOOLS, HALF PRICE

Technical Support and E-Warranty Certificate

www.vevor.com/support

vevoit

OUTILS ROBUSTES, MOITIÉ PRIX

Assistance technique et certificat de garantie électronique www.vevor.com/support

SUPPORT DE TÉLÉVISION

MANUEL D'UTILISATION

MODÈLE : TV16-Y

Nous continuons à nous engager à vous fournir des outils à des prix compétitifs. « Sauver la moitié », « Moitié prix » ou toute autre expression similaire utilisée par nous ne représente qu'une estimation des économies que vous pourriez réaliser en achetant certains outils chez nous par rapport aux grandes marques et les doses ne couvrent pas nécessairement toutes les catégories d'outils que nous proposons. Nous vous rappelons de bien vouloir vérifier lors de votre commande si vous économisez réellement la moitié par rapport aux grandes marques.

VEVOR®

SUPPORT DE TÉLÉVISION

OUTILS ROBUSTES, MOITIÉ PRIX

Modèle : TV16-Y



BESOIN D'AIDE? CONTACTEZ-NOUS!

Vous avez des questions sur nos produits ? Vous avez besoin d'assistance technique ? N'hésitez pas à nous contacter :

CustomerService@vevor.com

Il s'agit de la notice d'utilisation d'origine. Veuillez lire attentivement toutes les instructions du manuel avant de l'utiliser. VEVOR se réserve le droit d'interpréter clairement notre manuel d'utilisation. L'apparence du produit dépend du produit que vous avez reçu. Veuillez nous excuser, nous ne vous informerons plus en cas de mise à jour technologique ou logicielle de notre produit.

CONSIGNES DE SÉCURITÉ

AVERTISSEMENT:

Lisez ce document avant d'utiliser ce produit. Le non-respect de ces instructions peut entraîner des blessures graves.

Précautions d'assemblage 1.

Assemblez uniquement selon ces instructions. Un assemblage incorrect peut créer des dangers.

2. Portez des lunettes de sécurité approuvées ANSI et des gants de travail robustes pendant l'assemblage.
3. Gardez la zone de montage propre et bien éclairée.
4. Gardez les spectateurs hors de la zone pendant l'assemblage.
5. Ne vous réunissez pas lorsque vous êtes fatigué ou sous l'influence de l'alcool, drogues ou médicaments.
6. La capacité de poids et les autres capacités du produit s'appliquent uniquement au produit correctement et complètement assemblé.
7. Assemblez sur une surface plane, de niveau, dure et lisse capable de supporter en toute sécurité un support de télévision entièrement chargé.

Précautions d'emploi

POUR ÉVITER LES BLESSURES GRAVES ET LA MORT RÉSULTANT DU BASCULEMENT :

1. NE PAS S'ASSEOIR, SE TENIR DEBOUT OU MONTER SUR CET ARTICLE.
2. Ce produit n'est pas un jouet. Ne laissez pas les enfants jouer avec ou à proximité de cet article.
3. Ne dépassez pas le poids nominal indiqué. Des blessures graves ou des dommages matériels peuvent survenir.
4. Utiliser uniquement sur une surface plane, plane, dure et lisse capable de supporter en toute sécurité un support de télévision entièrement chargé.
5. Ne pas soulever pendant la charge.
6. Utiliser uniquement comme prévu.
7. Inspectez avant chaque utilisation ; ne pas utiliser si des pièces sont desserrées ou endommagées.

CONSERVER CE MANUEL

PARAMÈTRE DU PRODUIT

Modèle	TV16-Y
Portant le poids	90 lb maximum
Dimensions de montage	Max: 400x400mm/16"x16" Min:75x75mm/3wx3"
Taille de l'écran	55" Max
Taille du produit	670x435x260mm
Poids net	4,40 kg
Poids brut	4,65 kg

LISTE DES PIÈCES

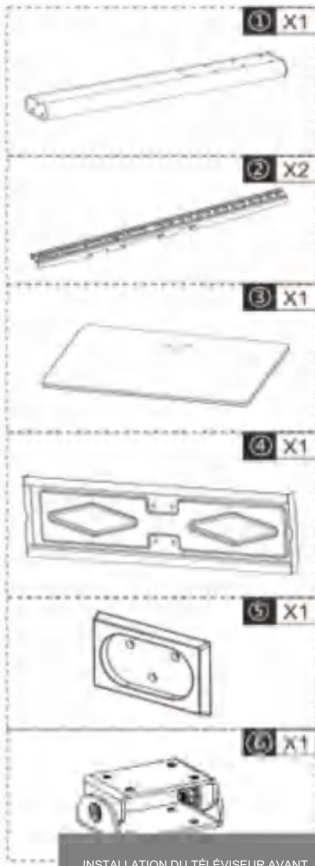

⚠ 3^e Rondelle en plastique
Rondelle en acier



INSTALLATION DU TÉLÉVISEUR AVANT ON

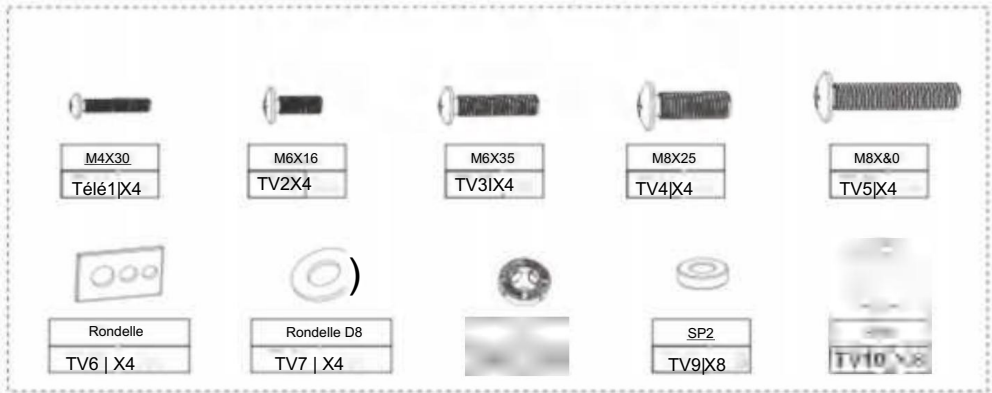

ÉTAPE D'ASSEMBLAGE

1

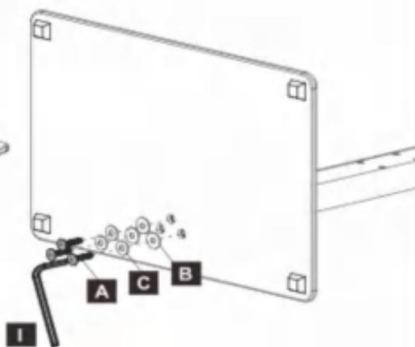
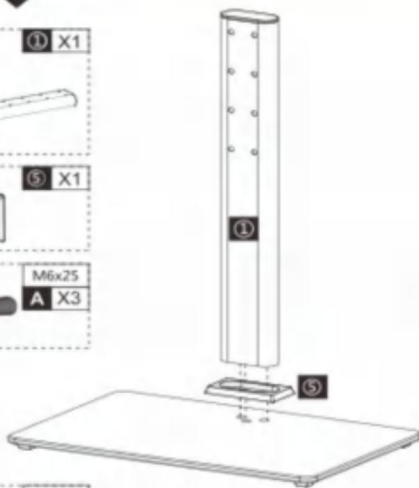
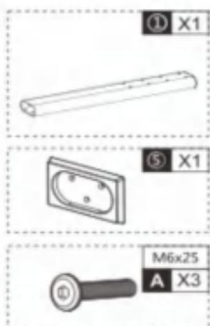
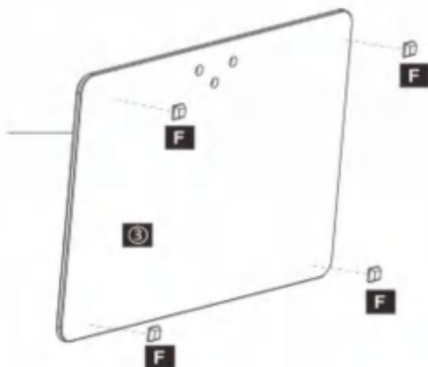
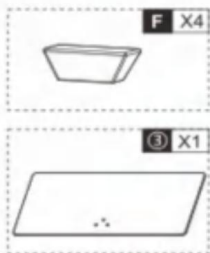

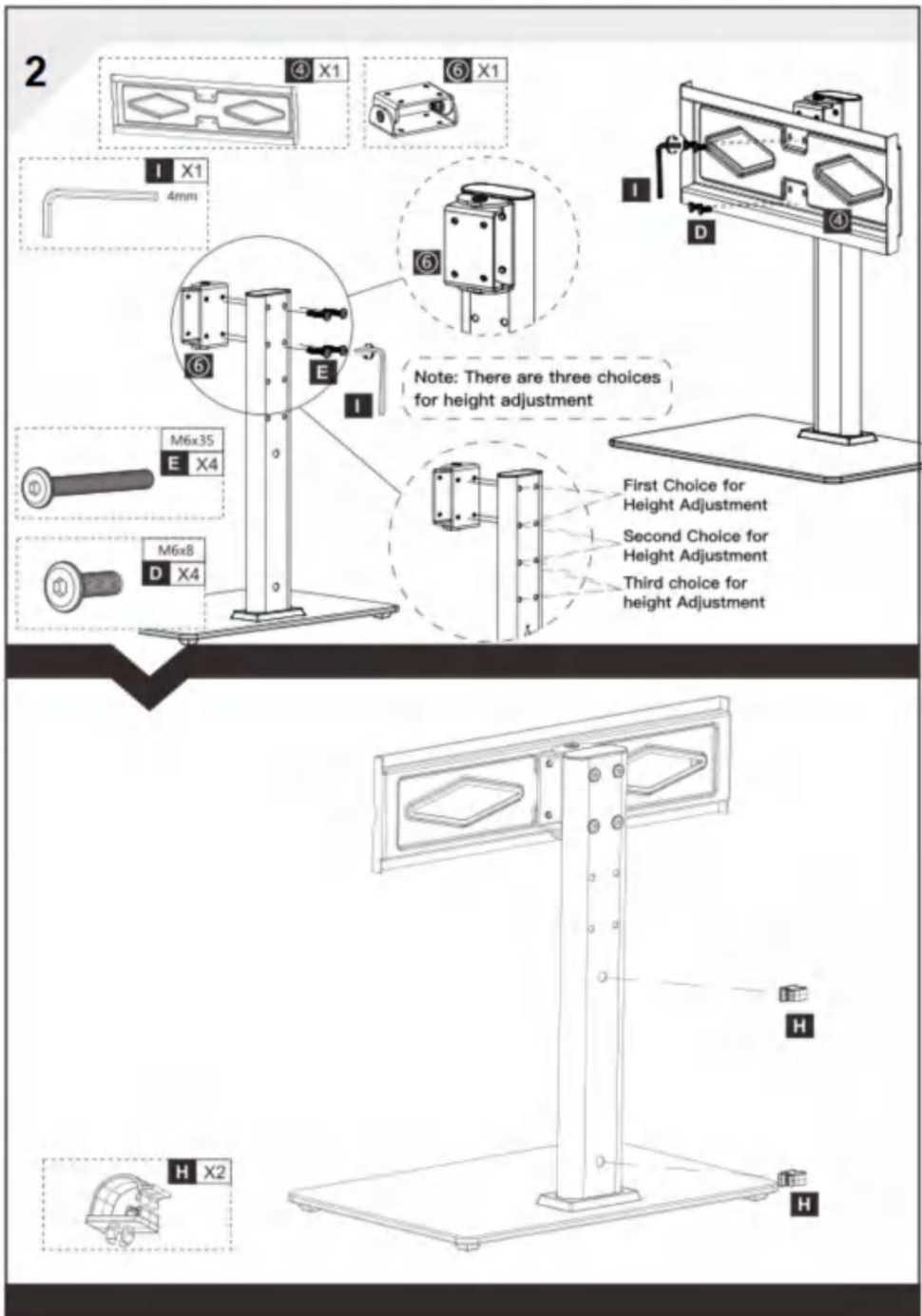

3

Measure the TV fixing holes Width and Height

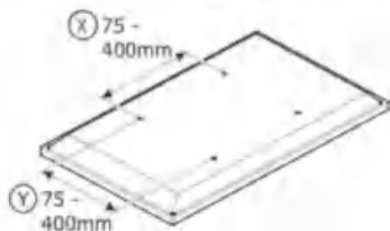

If width (X) is greater than 600mm or height (Y) greater than 400mm STOP installation now and contact the customer help line

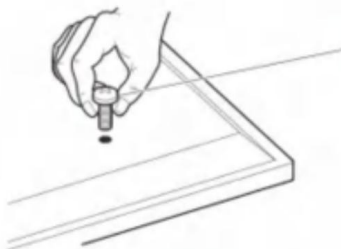

- TV1
- TV2-3
- TV4-5

You are provided with 4 diameters of TV fixing screws, **M4**, **M6** and **M8**. Determine the screw diameter that fits.

Spacers

SP

For TVs with irregular/obstructed back



No Spacers

For TVs with flat/unobstructed back

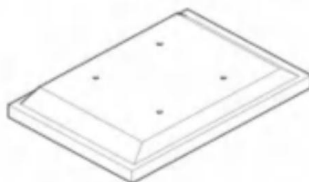

WARNING

please keep for future reference.

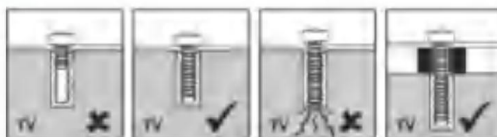

4

NOT INCLUDED

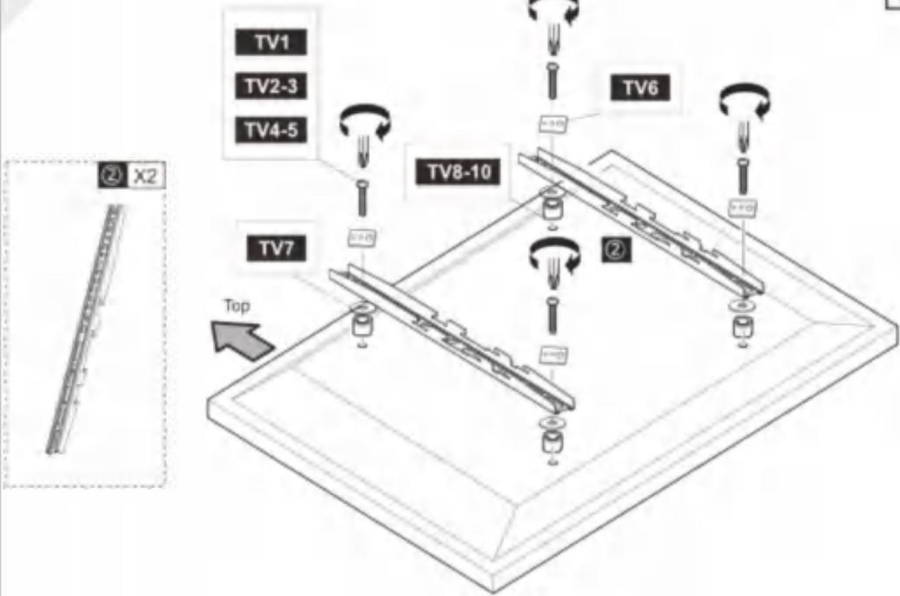

+

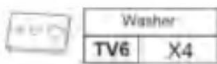

+



+



+

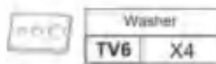

+



+



+

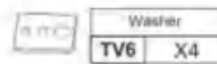

+



+



le

LE

Fixez le support à l'arrière de votre téléviseur à l'aide de combinaisons de vis, de réductions et d'entretoises appropriées.

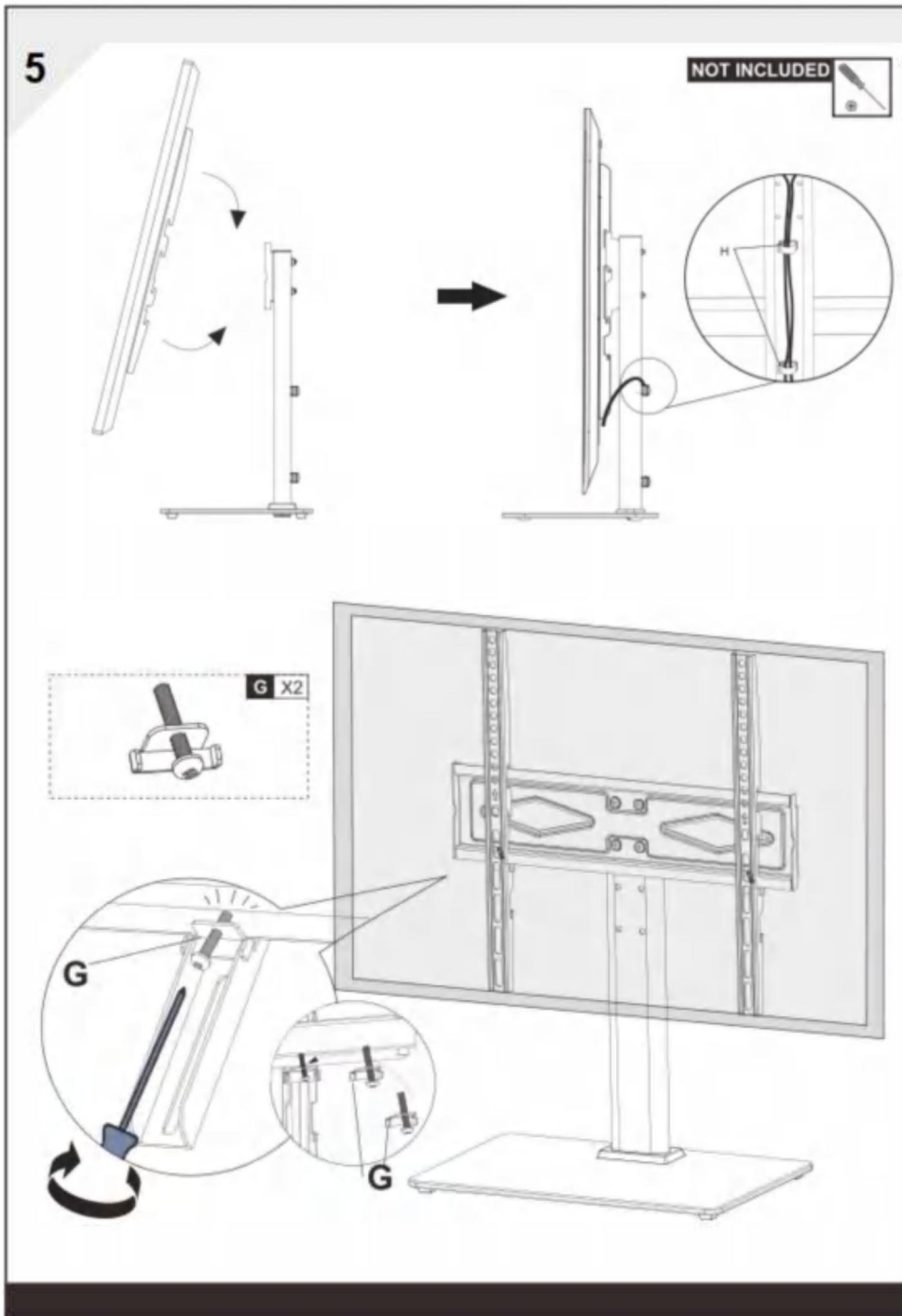

Fabricant : Shanghai muxin muyeyouxiangongsi Adresse :

Shuangchenglu 803nong11 hao1602A-1609shi, baoshanqu, shanghai
200000 CN.

Importé en AUS : SIHAO PTY LTD. 1 ROKEVA STREETEAST-WOOD NSW 2122
Australie Importé aux USA : Sanven

Technology Ltd. Suite 250, 9166 Anaheim Place, Rancho Cucamonga, CA91730



E-CrossStu GmbH

Mainzer Landstr.69, 60329 Francfort-sur-le-Main.



YH CONSULTING LIMITÉE.

A/S YH Consulting Limited Bureau 147, Centurion House, London Road,
Staines-upon-Thames, Surrey, TW18 4AX

V ET LER[®]

DIFFICILE OUTILS V, DEMI PRIX_{ET}

Assistance technique et certificat de garantie
électronique www.vevor.com/support

vevoit

ROBUSTE WERKZEUGE ZUM HALBEN PREIS

Technischer Support und E-Garantie-Zertifikat www.vevor.com/support

Fernsehständer

BENUTZERHANDBUCH

MODELL: TV16-Y

Wir sind weiterhin bestrebt, Ihnen Werkzeuge zu wettbewerbsfähigen Preisen anzubieten.

*Sparen Sie die Hälfte ? "Halber Preis" oder andere ähnliche Ausdrücke, die wir verwenden, stellen nur eine

Schätzung der Ersparnisse, die Sie beim Kauf bestimmter Werkzeuge bei uns im Vergleich zu den großen Topmarken erzielen können. Diese Angaben decken nicht unbedingt alle von uns angebotenen Werkzeugkategorien ab. Wir möchten

Sie freundlich daran erinnern, bei Ihrer Bestellung bei uns sorgfältig zu prüfen, ob Sie im Vergleich zu den großen

Topmarken tatsächlich die Hälfte sparen.

VEVOR®

Fernsehständer

ROBUSTE WERKZEUGE ZUM HALBEN PREIS

MODELL:TV16-Y



Brauchen Sie Hilfe? Kontaktieren Sie uns!

Sie haben Fragen zu unseren Produkten? Sie benötigen technischen Support? Dann kontaktieren Sie uns gerne:

CustomerService@vevor.com

Dies ist die Originalanleitung. Bitte lesen Sie alle Anweisungen sorgfältig durch, bevor Sie das Gerät in Betrieb nehmen. VEVOR behält sich eine klare Auslegung unserer Bedienungsanleitung vor. Das Erscheinungsbild des Produkts richtet sich nach dem Produkt, das Sie erhalten haben. Bitte verzeihen Sie uns, dass wir Sie nicht erneut informieren, wenn es Technologie- oder Software-Updates für unser Produkt gibt.

SICHERHEITSHINWEISE

WARNUNG:

Lesen Sie dieses Material, bevor Sie dieses Produkt verwenden. Andernfalls kann es zu schweren Verletzungen kommen.

Vorsichtsmaßnahmen bei der

Montage 1. Die Montage muss gemäß dieser Anleitung erfolgen. Eine unsachgemäße Montage kann Gefahren schaffen.

2. Tragen Sie während der Montage eine ANSI-geprüfte Schutzbrille und strapazierfähige Arbeitshandschuhe.

3. Halten Sie den Versammlungsbereich sauber und gut beleuchtet.

4. Halten Sie während der Montage unbeteiligte Zuschauer vom Bereich fern.

5. Nicht bei Müdigkeit oder unter Alkoholeinfluss montieren, Drogen oder Medikamente.

6. Gewichtskapazität und andere Produkteigenschaften gelten nur für ordnungsgemäß und vollständig montierte Produkte.

7. Auf einer flachen, ebenen, harten und glatten Oberfläche zusammenbauen, die einen voll beladenen Fernsehständer sicher tragen kann.

Vorsichtsmaßnahmen treffen

UM SCHWERE VERLETZUNGEN UND TOD DURCH KIPPEN ZU VERMEIDEN:

1. Setzen, stellen oder klettern Sie nicht auf diesen Gegenstand.

2. Dieses Produkt ist kein Spielzeug. Erlauben Sie Kindern nicht, mit diesem Produkt zu spielen oder sich in seiner Nähe aufzuhalten.

3. Das angegebene Nenngewicht darf nicht überschritten werden. Es kann zu schweren Verletzungen oder Sachschäden kommen!

4. Nur auf einer flachen, ebenen, harten und glatten Oberfläche verwenden, die einen voll beladenen Fernsehständer sicher tragen kann.

5. Nicht unter Last heben.

6. Nur bestimmungsgemäß verwenden.

7. Vor jedem Gebrauch prüfen; nicht verwenden, wenn Teile lose oder beschädigt sind.

BEWAHREN SIE DIESES HANDBUCH AUF

PRODUKTPARAMETER

Modell	TV16-Y
Lagergewicht	90 Pfund Max
Montagemaße	Max:400x400mm/16"x16 b Min: 75 x 75 mm/3 x 3 Zoll
Bildschirmgröße	55" Max
Produktgröße	670x435x260mm
Nettogewicht	4,40 kg
Bruttogewicht	4,65 kg

TEILELISTE



FRONT-TV-INSTALLATION ON

^3^
Kunststoffscheibe
Stahlscheibe

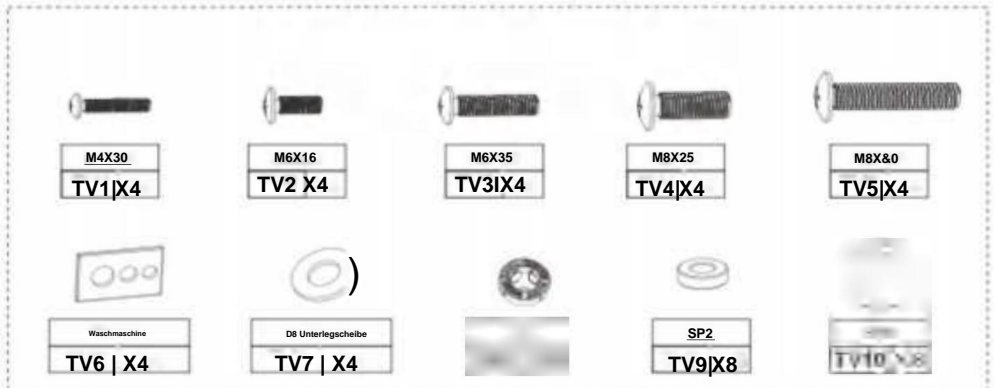
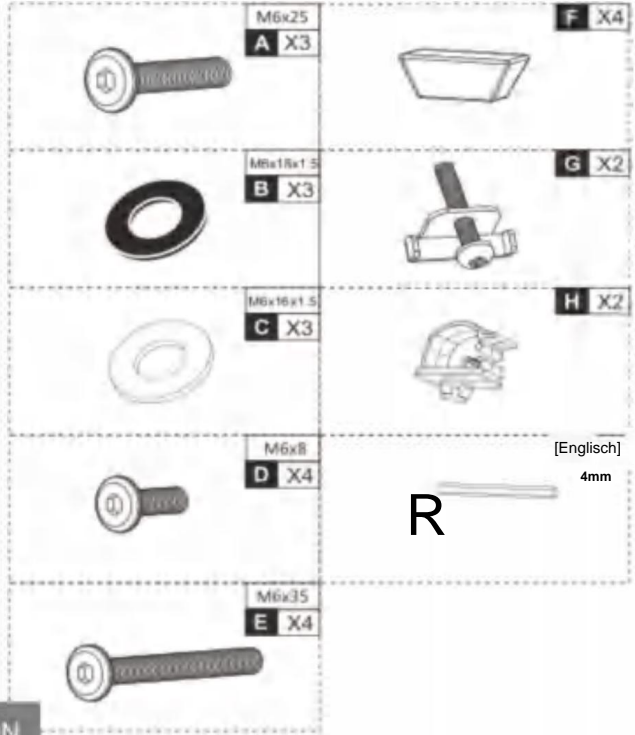

MONTAGESTRITT

1

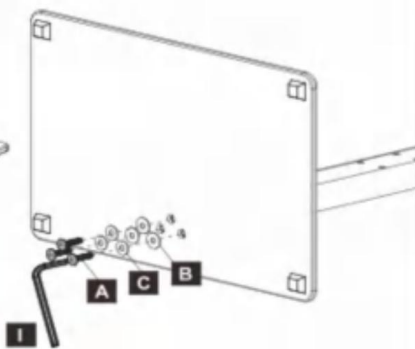
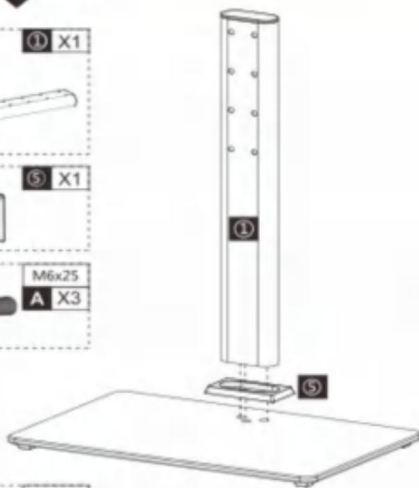
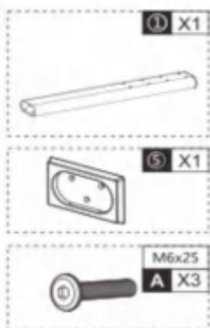
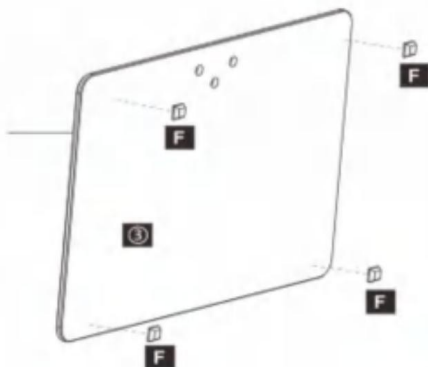
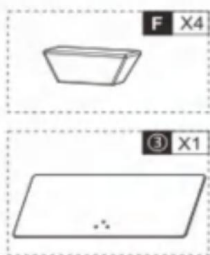

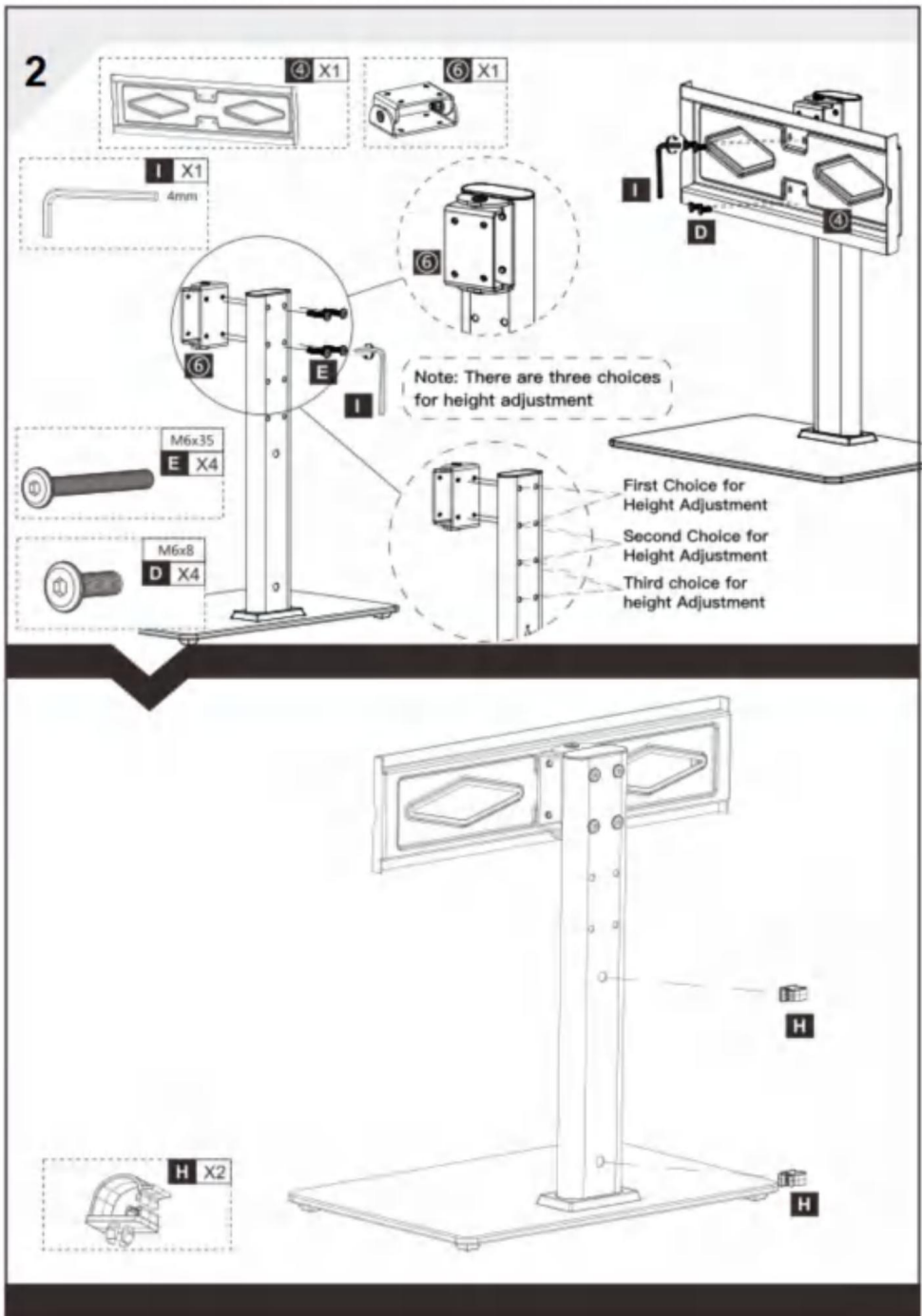

3

Measure the TV fixing holes Width and Height

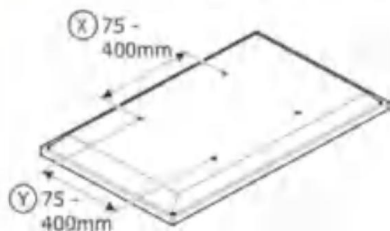

If width (X) is greater than 600mm or height (Y) greater than 400mm STOP installation now and contact the customer help line

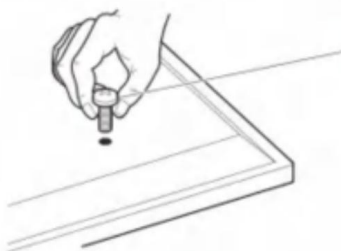

TV1

TV2-3

TV4-5

You are provided with 4 diameters of TV fixing screws, **M4**, **M6** and **M8**. Determine the screw diameter that fits.

Spacers

SP

For TVs with irregular/obstructed back



No Spacers

For TVs with flat/unobstructed back

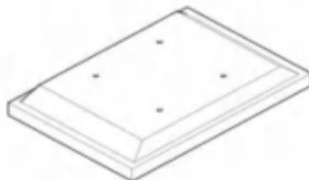

WARNING

please keep for future reference.

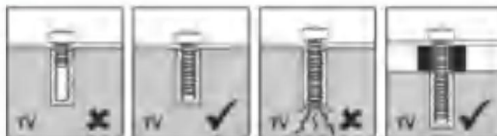

4

NOT INCLUDED

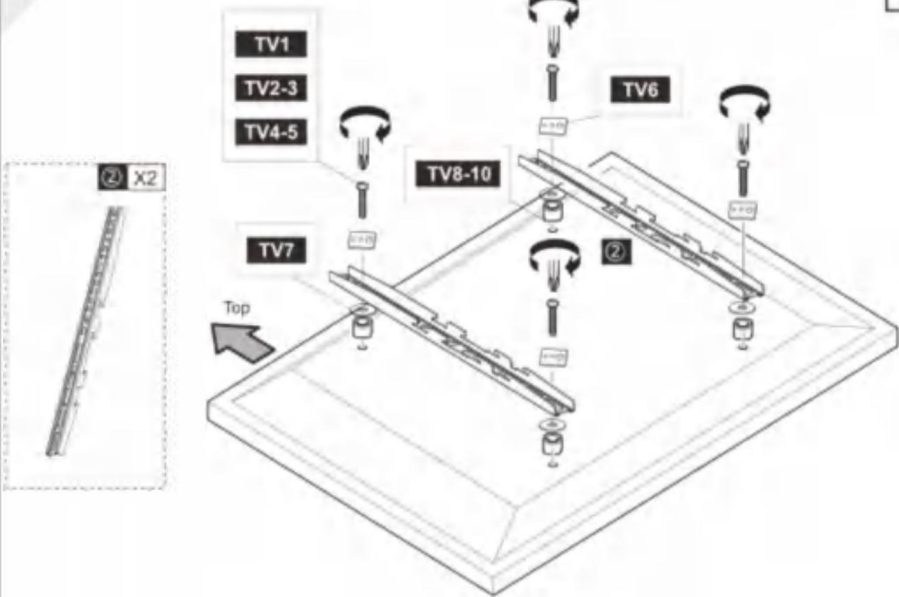

Befestigen Sie die Halterung mit geeigneten Schrauben-, Reduzier- und Distanzstückkombinationen an der Rückseite Ihres Fernsehers.

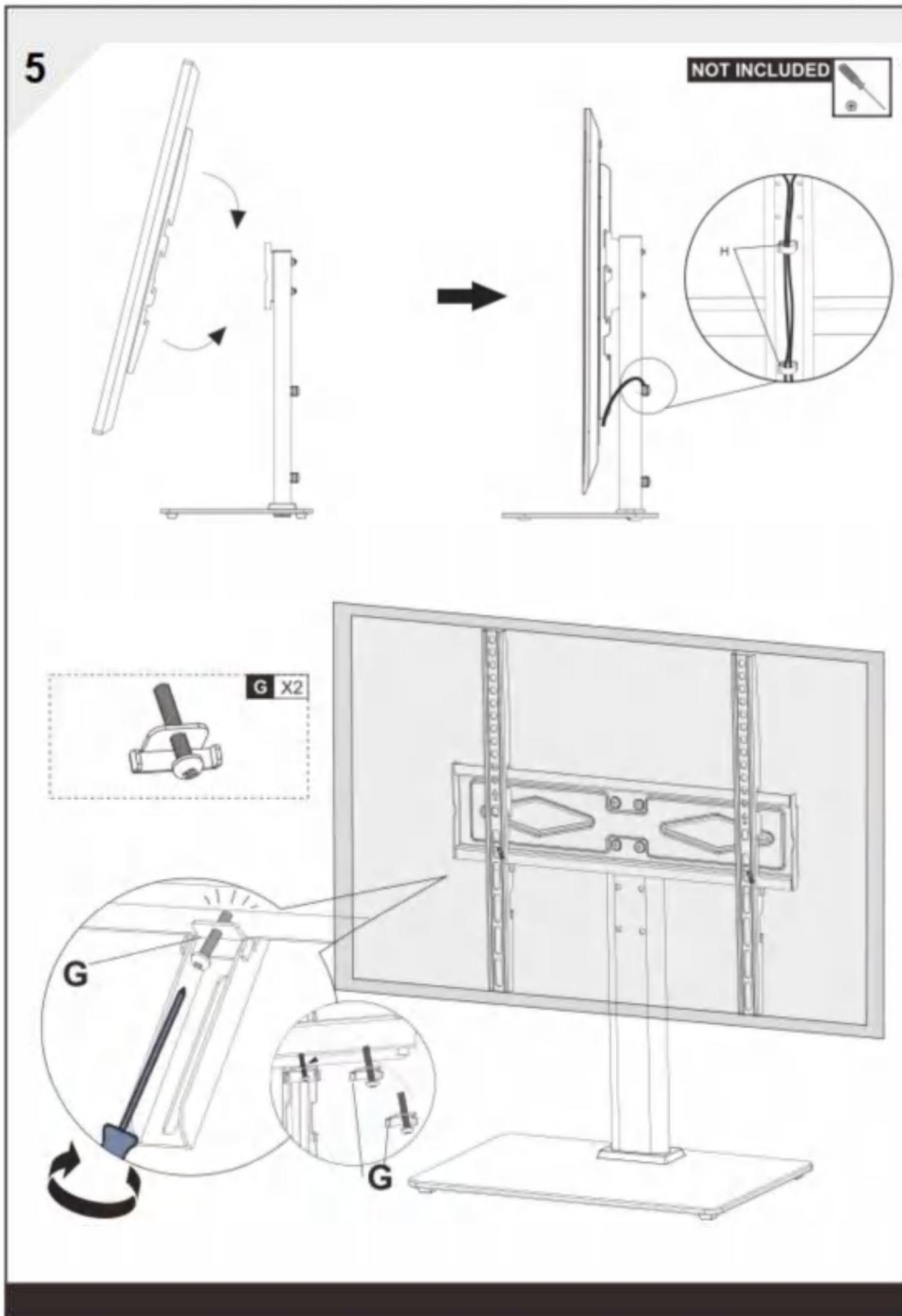

Hersteller: Shanghaimuxinmuyeyouxiangongsi Adresse:

Shuangchenglu 803nong11 hao1602A-1609shi, baoshanqu, Shanghai
200000 CN.

Importiert nach AUS: SIHAO PTY LTD. 1 ROKEVA STREETEAST-WOOD NSW
2122 Australien Importiert nach

USA: Sanven Technology Ltd. Suite 250, 9166 Anaheim Place, Rancho
Cucamonga, CA91730

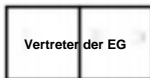

E-CrossStu GmbH
Mainzer Landstr.69, 60329 Frankfurt am Main.



YH CONSULTING LIMITED.
C/O YH Consulting Limited Office 147, Centurion House, London
Road, Staines-upon-Thames, Surrey, TW18 4AX

V UND **DER R**®

HART WERKZEUGE V, HALB PREIS UND

Technischer Support und E-Garantie-Zertifikat

www.vevor.com/support

vevoit

UTENSILI RESISTENTI, A METÀ PREZZO

Supporto tecnico e certificato di garanzia elettronica www.vevor.com/support

SUPPORTO PER TELEVISIONE

MANUALE D'USO

MODELLO: TV16-Y

Continuiamo a impegnarci per fornirvi strumenti a prezzi competitivi.

*Risparmia la metà ? "Metà prezzo" o qualsiasi altra espressione simile da noi utilizzata rappresenta solo un stima dei risparmi che potresti ottenere acquistando determinati utensili con noi rispetto ai principali marchi principali e dosi non necessariamente intendono coprire tutte le categorie di utensili da noi offerti. Ti ricordiamo gentilmente di verificare attentamente quando effettui un ordine con noi se stai effettivamente risparmiando la metà rispetto ai principali marchi principali.

VEVOR®

SUPPORTO PER TELEVISIONE

UTENSILI RESISTENTI, A METÀ PREZZO

MODELLO:TV16-Y



HAI BISOGNO DI AIUTO? CONTATTACI!

Hai domande sui prodotti? Hai bisogno di supporto tecnico? Non esitare a contattarci:

CustomerService@vevor.com

Questa è l'istruzione originale, si prega di leggere attentamente tutte le istruzioni del manuale prima di utilizzare. VEVOR si riserva una chiara interpretazione del nostro manuale utente. L'aspetto del prodotto sarà soggetto al prodotto ricevuto. Vi preghiamo di perdonarci se non vi informeremo di nuovo se ci sono aggiornamenti tecnologici o software sul nostro prodotto.

ISTRUZIONI DI SICUREZZA

AVVERTIMENTO:

Leggere questo materiale prima di utilizzare questo prodotto. La mancata osservanza di questa precauzione può causare gravi lesioni.

Precauzioni di montaggio 1.

Montare solo secondo queste istruzioni. Un montaggio non corretto può creare pericoli.

2. Durante il montaggio, indossare occhiali di sicurezza omologati ANSI e guanti da lavoro resistenti.
3. Mantenere l'area di assemblaggio pulita e ben illuminata.
4. Tenere gli astanti fuori dall'area durante l'assemblaggio.
5. Non riunirsi quando si è stanchi o sotto l'effetto dell'alcool, farmaci o medicinali.
6. La capacità di peso e le altre caratteristiche del prodotto si applicano solo al prodotto correttamente e completamente assemblato.
7. Montare su una superficie piana, livellata, dura e liscia, in grado di sostenere in modo sicuro un supporto per TV completamente carico.

Usare precauzioni

PER PREVENIRE LESIONI GRAVI E MORTALI DOVUTE AL RIBALTAMENTO:

1. NON SEDERSI, STARE IN PIEDI O SALIRE SU QUESTO OGGETTO.

2. Questo prodotto non è un giocattolo. Non permettere ai bambini di giocare con o vicino a questo articolo.
3. Non superare il peso nominale indicato. Potrebbero verificarsi gravi lesioni o danni alla proprietà.
4. Utilizzare solo su una superficie piana, livellata, dura e liscia in grado di sostenere in modo sicuro un supporto per televisore completamente carico.
5. Non sollevare oggetti carichi.
6. Utilizzare solo come previsto.
7. Ispezionare prima di ogni utilizzo; non utilizzare se alcune parti sono allentate o danneggiate.

SALVA QUESTO MANUALE

PARAMETRO PRODOTTO

Modello	TV16-Y
Peso del cuscinetto	90 libbre massimo
Dimensioni di montaggio	Max: 400x400mm/16"x16" Min:75x75mm/3lx3"
Dimensioni dello schermo	55" massimo
Dimensioni del prodotto	Dimensioni: 670x435x260mm
Peso netto	4,40 kg
Peso lordo	4,65 kg

ELENCO DELLE PARTI

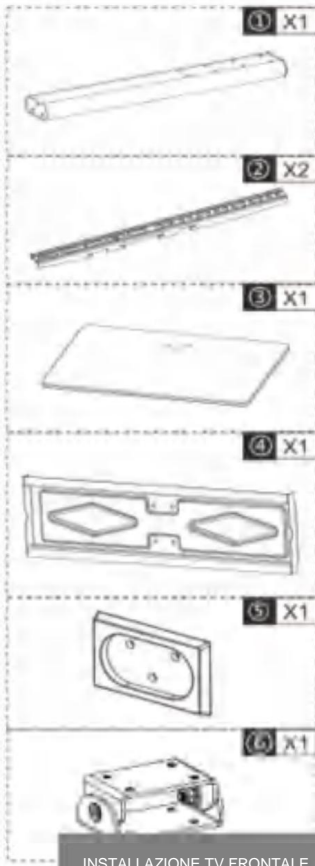

^3^ Rondella di
plastica Rondella in acciaio

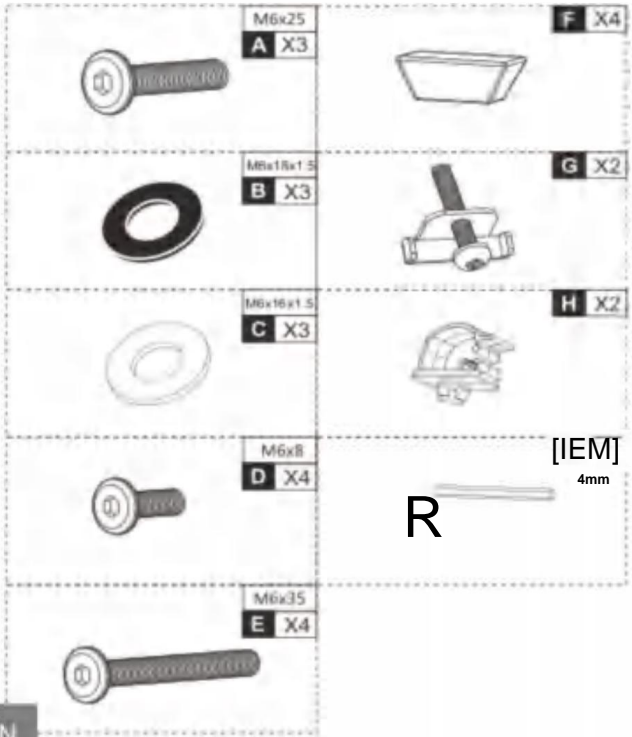

INSTALLAZIONE TV FRONTALE ON

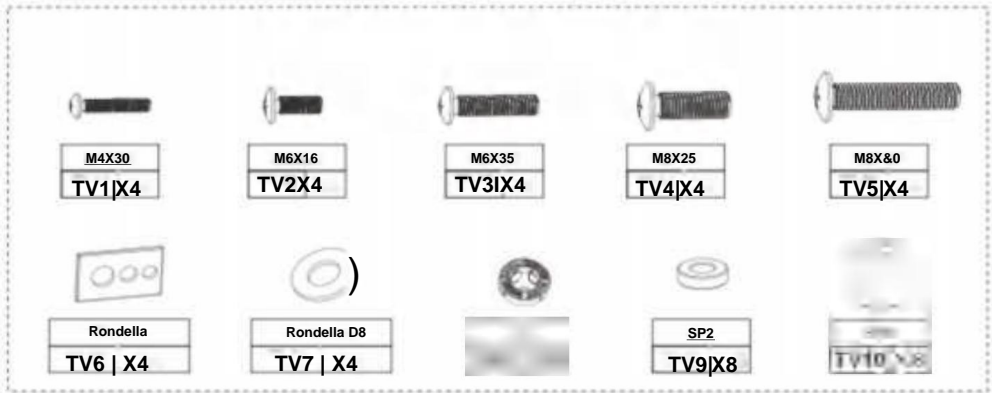

FASE DI MONTAGGIO

1

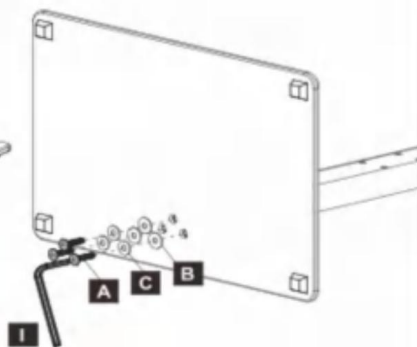
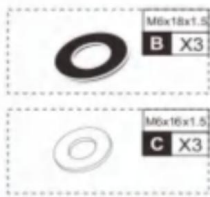
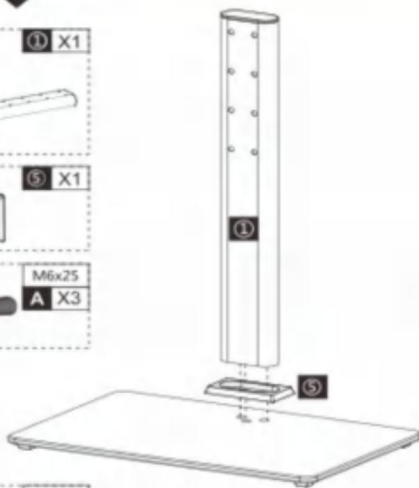
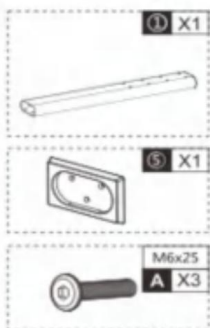
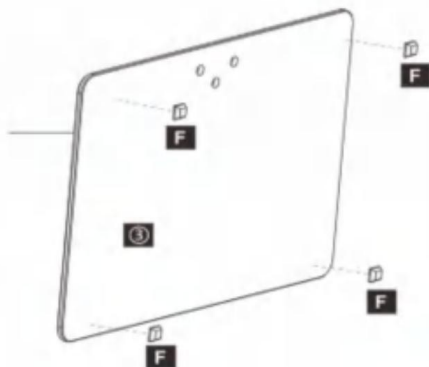
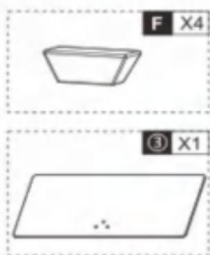

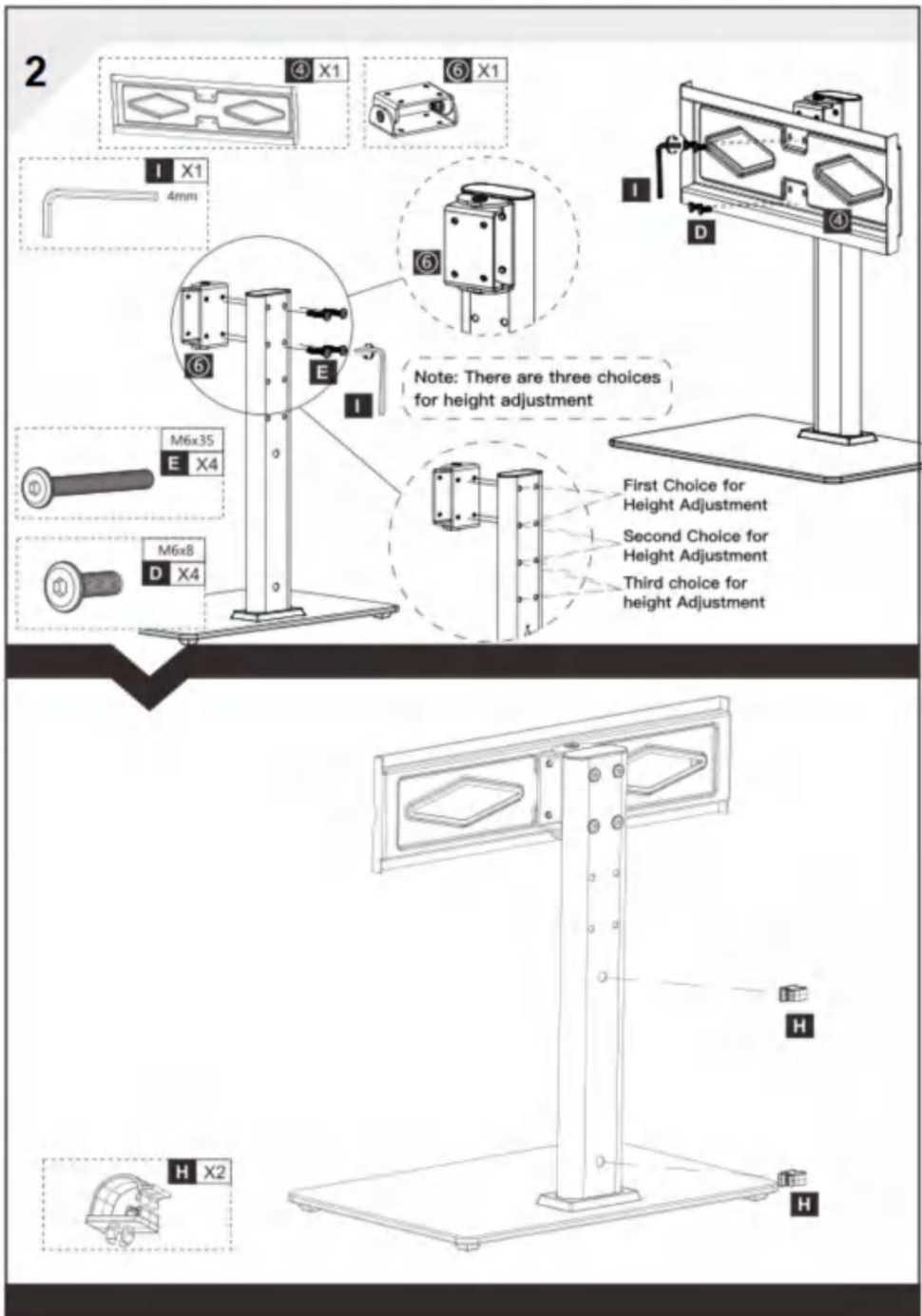

3

Measure the TV fixing holes Width and Height

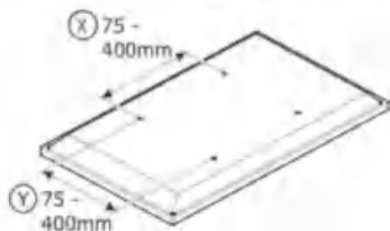

If width (X) is greater than 600mm or height (Y) greater than 400mm STOP installation now and contact the customer help line

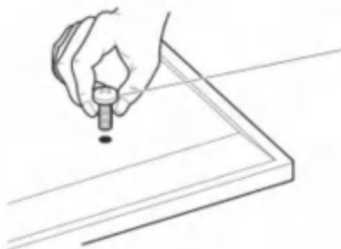

TV1

TV2-3

TV4-5

You are provided with 4 diameters of TV fixing screws, **M4**, **M6** and **M8**. Determine the screw diameter that fits.

Spacers

SP

For TVs with irregular/obstructed back



No Spacers

For TVs with flat/unobstructed back

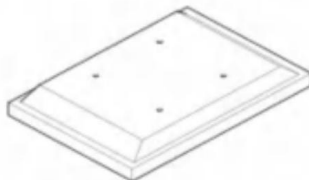

WARNING

please keep for future reference.



4

NOT INCLUDED

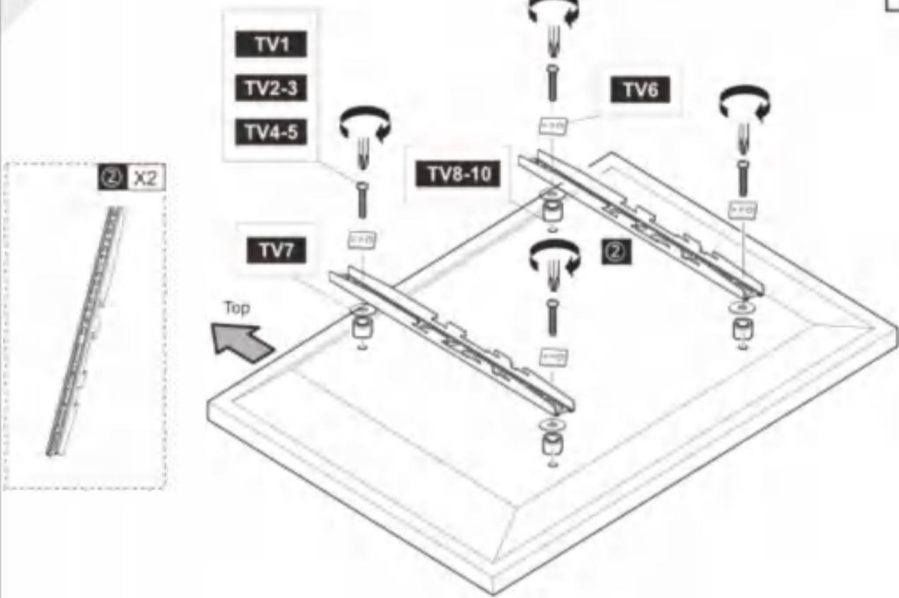

+

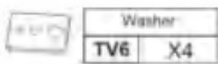

+

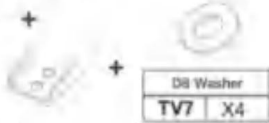

+



+

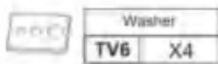

+



+



+

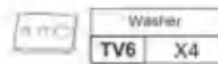

+



+



■

■

IL

IL

Fissare la staffa sul retro del televisore utilizzando le combinazioni idonee di viti, riduttori e distanziatori.

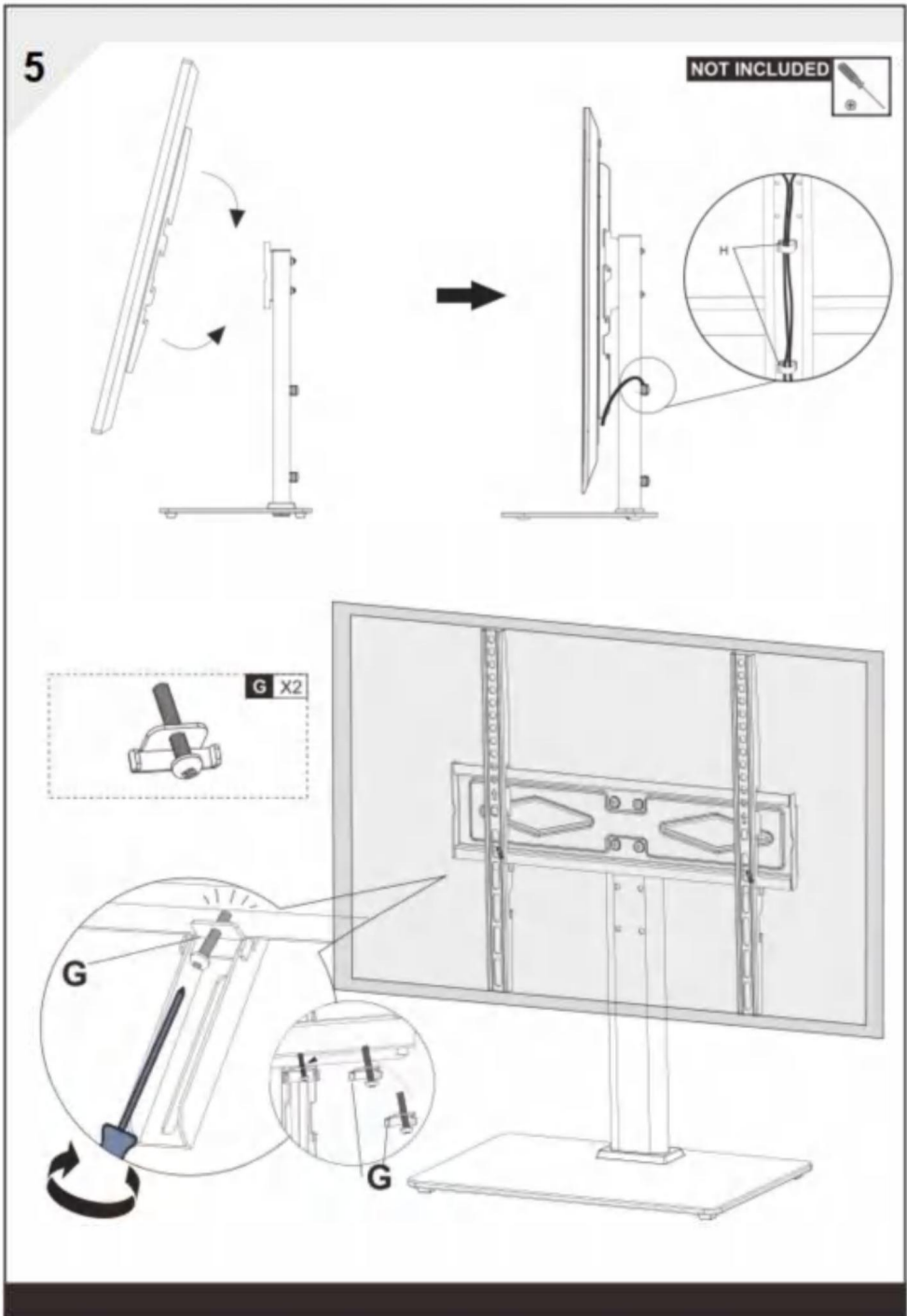

Produttore: Shanghai muxinmuyeyouxiangongsi Indirizzo:

Shuangchenglu 803nong11 hao1602A-1609shi, baoshanqu, shanghai
200000 CN.

Importato in AUS: SIHAO PTY LTD. 1 ROKEVA STREET EAST-WOOD NSW 2122
Australia Importato negli USA:

Sanven Technology Ltd. Suite 250, 9166 Anaheim Place, Rancho Cucamonga,
CA91730



E-CrossStu GmbH

Mainzer Landstr.69, 60329 Francoforte sul Meno.



CONSULENZA YH LIMITATA.

C/O YH Consulting Limited Ufficio 147, Centurion House, London
Road, Staines-upon-Thames, Surrey, TW18 4AX

VE ILR®

DIFFICILE STRUMENTI V, METÀ PREZZO E

Supporto tecnico e certificato di garanzia
elettronica www.vevor.com/support

vevoit

HERRAMIENTAS RESISTENTES A MITAD DE PRECIO

Soporte técnico y certificado de garantía electrónica www.vevor.com/support

SOPORTE DE TELEVISIÓN

MANUAL DEL USUARIO

MODEL TV16-Y

Seguimos comprometidos a brindarle herramientas a precios competitivos.

"Ahorra la mitad", "Mitad de Precio" o cualquier otra expresión similar utilizada por nosotros sólo representa una

Estimación del ahorro que podría obtener al comprar ciertas herramientas con nosotros en comparación con las principales marcas principales. Las dosis no necesariamente cubren todas las categorías de herramientas que ofrecemos. Le recordamos que verifique cuidadosamente al realizar un pedido con nosotros si realmente está ahorrando la mitad en comparación con las principales marcas principales.

VEVOR®

SOPORTE DE TELEVISIÓN

HERRAMIENTAS RESISTENTES A MITAD DE PRECIO

MODEL:TV16-Y



¿NECESITA AYUDA? ¡CONTÁCTENOS!

¿Tiene preguntas sobre el producto? ¿Necesita asistencia técnica? No dude en ponerse en contacto con nosotros:

ServicioalCliente@vevor.com

Estas son las instrucciones originales, lea atentamente todas las instrucciones del manual antes de utilizar el producto. VEVOR se reserva una interpretación clara de nuestro manual de usuario. La apariencia del producto estará sujeta al producto que recibió. Perdónenos por no informarle nuevamente si hay actualizaciones de tecnología o software en nuestro producto.

INSTRUCCIONES DE SEGURIDAD

ADVERTENCIA:

Lea este material antes de utilizar este producto. No hacerlo puede provocar lesiones graves.

Precauciones de montaje 1.

Realice el montaje únicamente de acuerdo con estas instrucciones. Un montaje incorrecto puede crear peligros

2. Use gafas de seguridad aprobadas por ANSI y guantes de trabajo resistentes durante el montaje.
3. Mantenga el área de reunión limpia y bien iluminada.
4. Mantenga a los transeúntes fuera del área durante el montaje.
5. No se reúna cuando esté cansado o bajo los efectos del alcohol, drogas o medicamentos.
6. La capacidad de peso y otras capacidades del producto se aplican únicamente a productos ensamblados de forma correcta y completa.
7. Monte sobre una superficie plana, nivelada, dura y lisa capaz de soportar de forma segura un soporte de televisión completamente cargado.

Tome precauciones

PARA EVITAR LESIONES GRAVES Y LA MUERTE POR VUELCO:

1. NO SE SIENTA, SE PARE NI SE SUBA SOBRE ESTE ARTÍCULO.
2. Este producto no es un juguete. No permita que los niños jueguen con este artículo ni cerca de él.
3. No exceda el peso nominal indicado. ¡Pueden producirse lesiones graves o daños a la propiedad!.
4. Úselo únicamente sobre una superficie plana, nivelada, dura y lisa capaz de soportar de forma segura un soporte de televisión completamente cargado.
5. No levante mientras esté cargado.
6. Utilícelo únicamente según lo previsto.
7. Inspeccione antes de cada uso; no utilice si las piezas están sueltas o dañadas.

GUARDE ESTE MANUAL

PARÁMETRO DEL PRODUCTO

Modelo	TV16-Y
Soportando peso	90 libras máximo
Dimensión de montaje	Máx.: 400 x 400 mm/16 x 16 x 16 mm. Mínimo: 75x75mm/3wx3 '
Tamaño de pantalla	55" Máximo
Tamaño del producto	670 x 435 x 260 mm
Peso neto	4,40 kilos
Peso bruto	4,65 kilos

LISTA DE PIEZAS

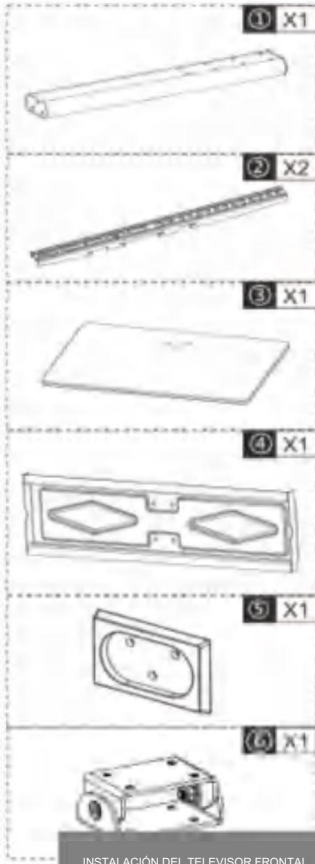

^3^ Arandela de plástico
Arandela de acero

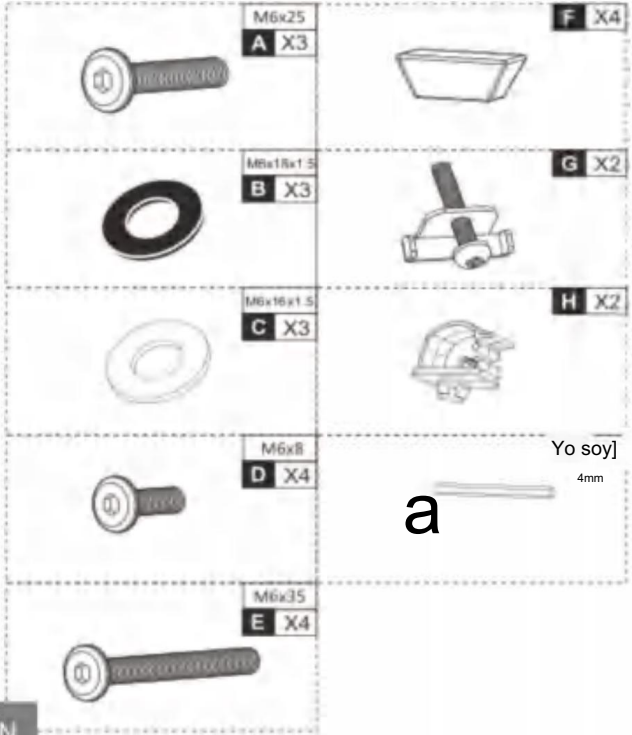

INSTALACIÓN DEL TELEVISOR FRONTAL ON

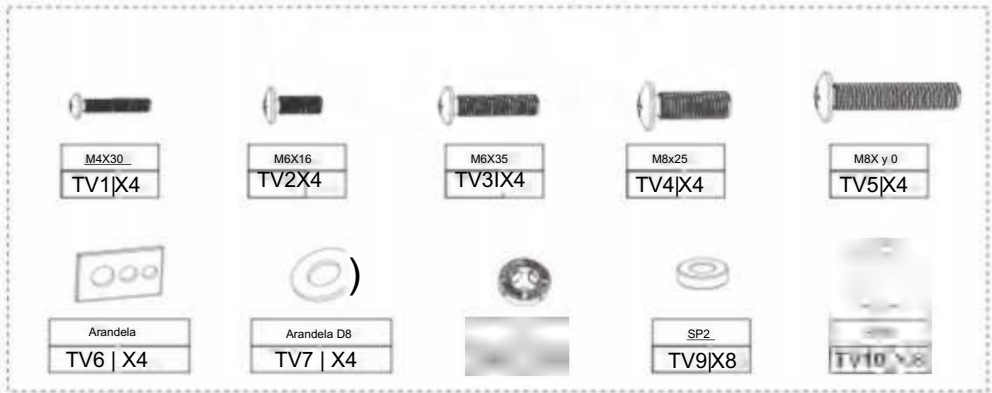

PASO DE MONTAJE

1

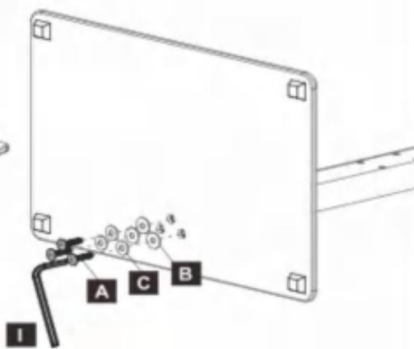
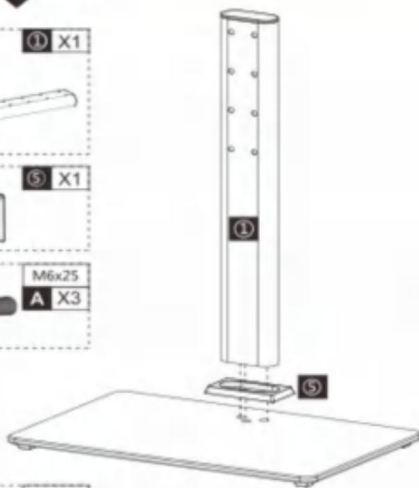
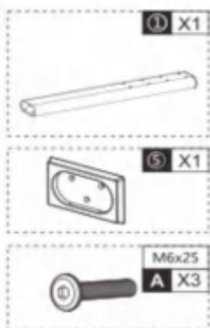
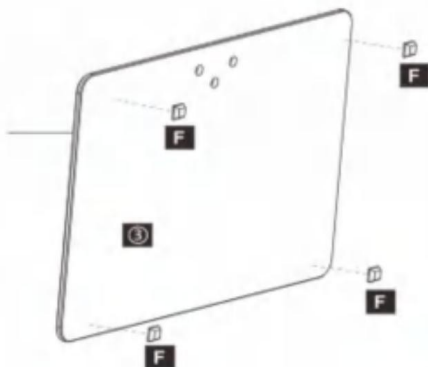
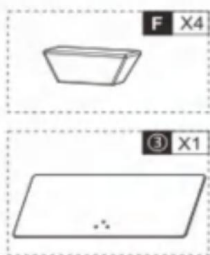

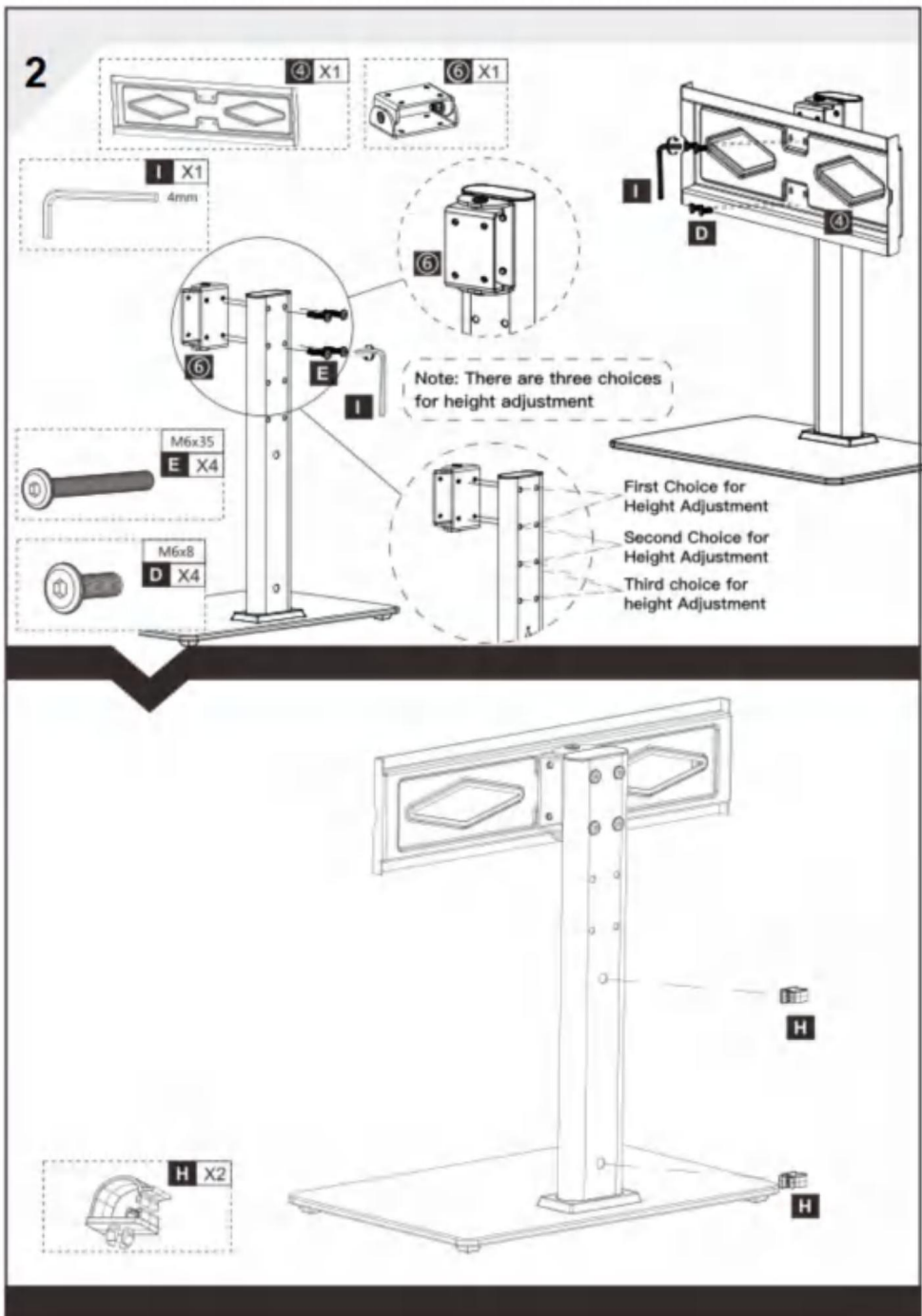

3

Measure the TV fixing holes Width and Height

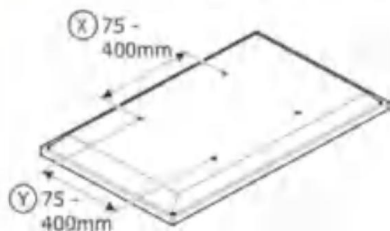

If width (X) is greater than 600mm or height (Y) greater than 400mm STOP installation now and contact the customer help line

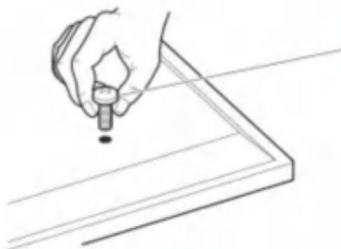

- TV1
- TV2-3
- TV4-5

You are provided with 4 diameters of TV fixing screws, **M4**, **M6** and **M8**. Determine the screw diameter that fits.

Spacers

SP

For TVs with irregular/obstructed back



No Spacers

For TVs with flat/unobstructed back

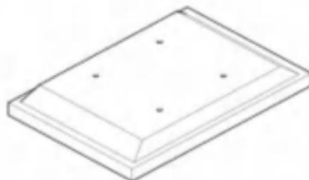

WARNING

please keep for future reference.

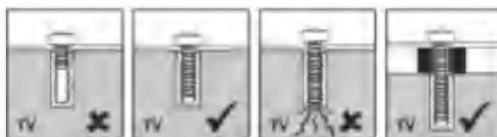

4

NOT INCLUDED

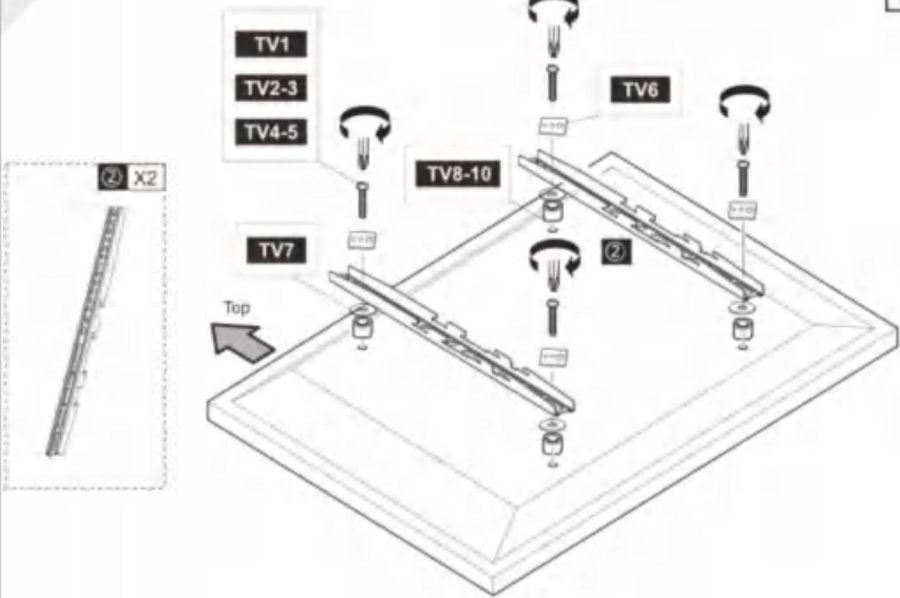

+

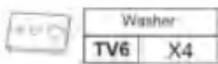

+



+



+

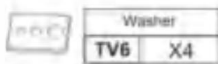

+



+



+



+



+



CI

el

EL

Fije el soporte a la parte posterior de su televisor utilizando combinaciones adecuadas de tornillos, reducidos y espaciadores.

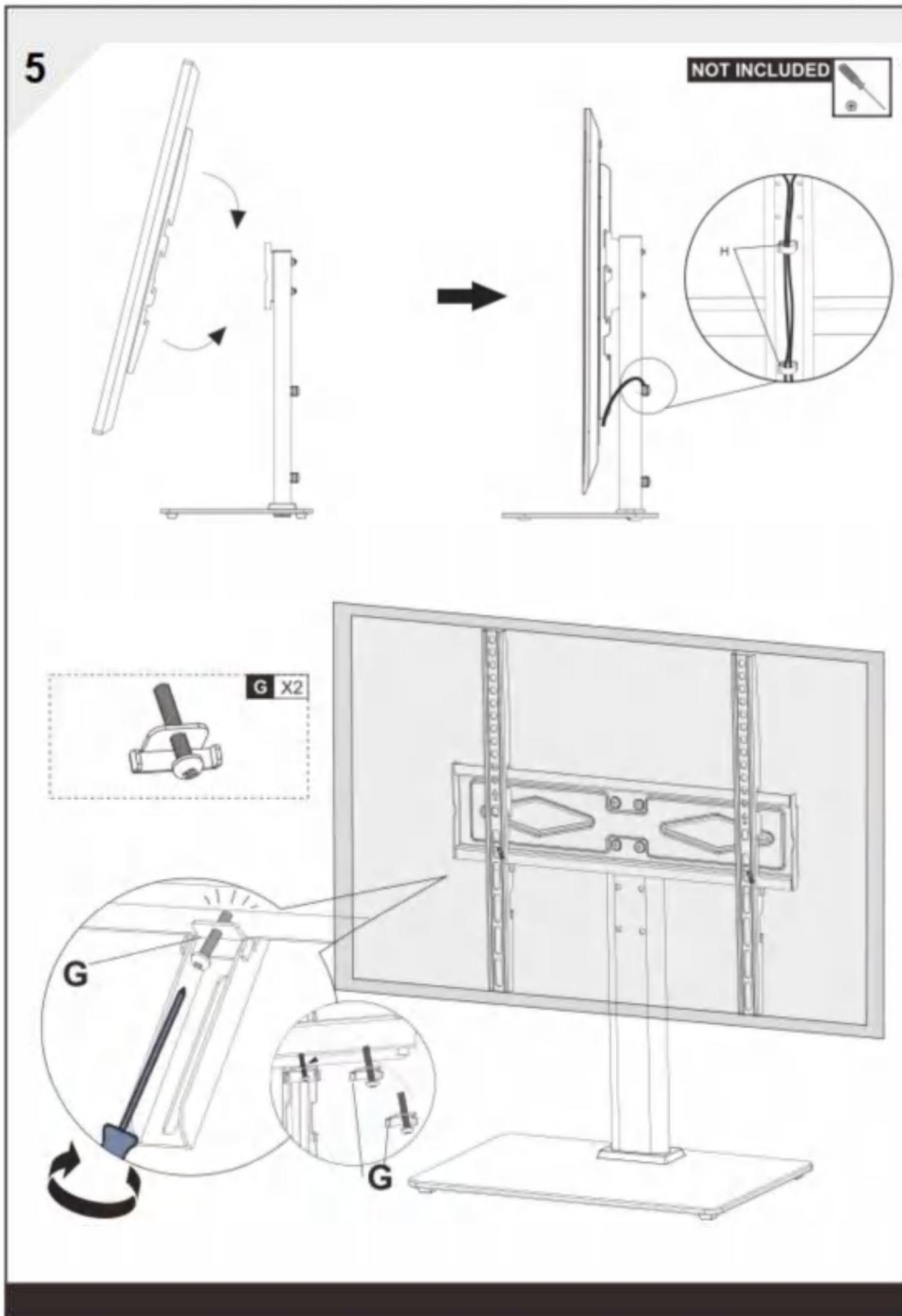

Fabricante: Shanghaimuxinmuyeyouxiangongsi Dirección:
Shuangchenglu 803nong11 hao1602A-1609shi, baoshanqu, shanghai
200000 CN.

Importado a AUS: SIHAO PTY LTD. 1 ROKEVA STREETEAST-WOOD NSW 2122
Australia Importado a EE. UU.:

Sanven Technology Ltd. Suite 250, 9166 Anaheim Place, Rancho Cucamonga,
CA 91730



E-CrossStu GmbH
Mainzer Landstr.69, 60329 Fráncfort del Meno.



YH CONSULTING LIMITADA.
C/O YH Consulting Limited Oficina 147, Centurion House, London
Road, Staines-upon-Thames, Surrey, TW18 4AX

V Y ELR[®]

DIFÍCIL HERRAMIENTAS V, MITAD PRECIO Y

Soporte técnico y certificado de garantía
electrónica www.vevor.com/support

wevoit

WYTRZYMAŁE NARZĘDZIA, POŁOWA CENY

Wsparcie techniczne i certyfikat gwarancji elektronicznej www.vevor.com/support

PODSTAWKA POD TELEWIZOR

INSTRUKCJA OBSŁUGI

MODEL: TV16-Y

Nadal staramy się oferować Państwu narzędzia w konkurencyjnych cenach.

„Zaoszczędź połowę” ? „Połowa ceny” lub jakiegokolwiek inne podobne wyrażenia używane przez nas oznaczają jedynie szacunkowe oszczędności, jakie możesz uzyskać kupując u nas określone narzędzia w porównaniu z głównymi markami i niekoniecznie oznacza to, że obejmuje wszystkie kategorie narzędzi oferowanych przez nas. Uprzejmie przypominamy, aby dokładnie sprawdzić, czy składając u nas zamówienie faktycznie oszczędzasz połowę w porównaniu z głównymi markami.

VEVOR®

PODSTAWKA POD TELEWIZOR

WYTRZYMAŁE NARZĘDZIA, POŁOWA CENY

MODEL:TV16-Y



POTRZEBUJESZ POMOCY? SKONTAKTUJ SIĘ Z NAMI!!

Masz pytania dotyczące produktu? Potrzebujesz wsparcia technicznego? Skontaktuj się z nami:

[Obsługa Klienta@vevor.com](mailto:Obsługa.Klienta@vevor.com)

To jest oryginalna instrukcja, przed użyciem należy uważnie przeczytać wszystkie instrukcje. VEVOR zastrzega sobie jasną interpretację naszej instrukcji obsługi. Wygląd produktu będzie zależał od produktu, który otrzymałeś. Prosimy o wybaczenie, że nie poinformujemy Cię ponownie, jeśli w naszym produkcie pojawią się jakiegokolwiek aktualizacje technologiczne lub oprogramowania.

INSTRUKCJE BEZPIECZEŃSTWA

OSTRZEŻENIE:

Przeczytaj ten materiał przed użyciem tego produktu. Nieprzestrzeganie tego może spowodować poważne obrażenia.

Środki ostrożności przy montażu

1. Montaż należy wykonywać wyłącznie zgodnie z niniejszą instrukcją. Nieprawidłowy montaż może stwarzać zagrożenia.
2. Podczas montażu należy nosić okulary ochronne z atestem ANSI oraz wytrzymałe rękawice robocze.
3. Utrzymuj miejsce zgromadzenia w czystości i zapewnij dobre oświetlenie.
4. Podczas montażu nie dopuszczaj osób postronnych na teren montażu.
5. Nie należy uczestniczyć w zgromadzeniach, będąc zmęczonym lub pod wpływem alkoholu, narkotyki lub leki.
6. Podane parametry dotyczące nośności i innych parametrów produktu odnoszą się wyłącznie do produktu prawidłowo i kompletnie zmontowanego.
7. Zmontuj na płaskiej, równej, twardej i gładkiej powierzchni, która może bezpiecznie utrzymać w pełni załadowany stojak pod telewizor.

Stosuj środki ostrożności

ABY ZAPOBIEĆ POWAŻNYM OBRAŻENIOM I ŚMIERCI SPOWODOWANEJ PRZEWRÓCENIEM:

1. NIE SIADAJ, NIE STÓJ ANI NIE WSPINAJ SIĘ NA TYM PRZEDMIOCIE.
2. Ten produkt nie jest zabawką. Nie pozwalaj dzieciom bawić się tym przedmiotem ani przebywać w jego pobliżu.
3. Nie przekraczać dopuszczalnej masy całkowitej. Może to spowodować poważne obrażenia ciała lub uszkodzenie mienia!
4. Używać wyłącznie na płaskiej, równej, twardej i gładkiej powierzchni, która może bezpiecznie utrzymać w pełni załadowany stojak pod telewizor.
5. Nie podnoś, gdy jesteś obciążony.
6. Używać wyłącznie zgodnie z przeznaczeniem.
7. Przed każdym użyciem należy przeprowadzić kontrolę. Nie należy używać produktu, jeśli jakieś części są luźne lub uszkodzone.

ZAPISZ TĘ INSTRUKCJĘ

PARAMETR PRODUKTU

Model	TV16-Y
Nośność	Maksymalnie 90 funtów
Wymiary montażowe	Maks.: 400x400mm/16*x16 szer. Min.: 75 x 75 mm / 3 szer. x 3 '
Rozmiar ekranu	Maksymalnie 55"
Rozmiar produktu	670x435x260mm
Masa netto	4,40 kg
Masa brutto	4,65 kg

LISTA CZĘŚCI



MONTAŻ TELEWIZORA PRZEDNIEGO ON

Podkładka
plastikowa Podkładka stalowa

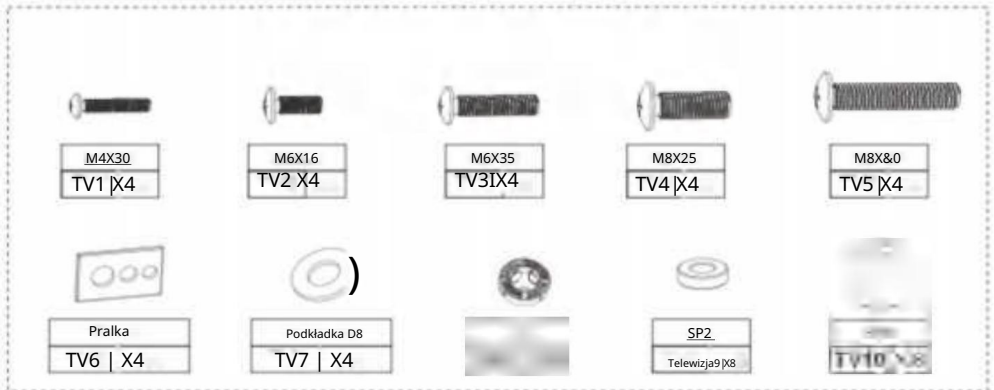
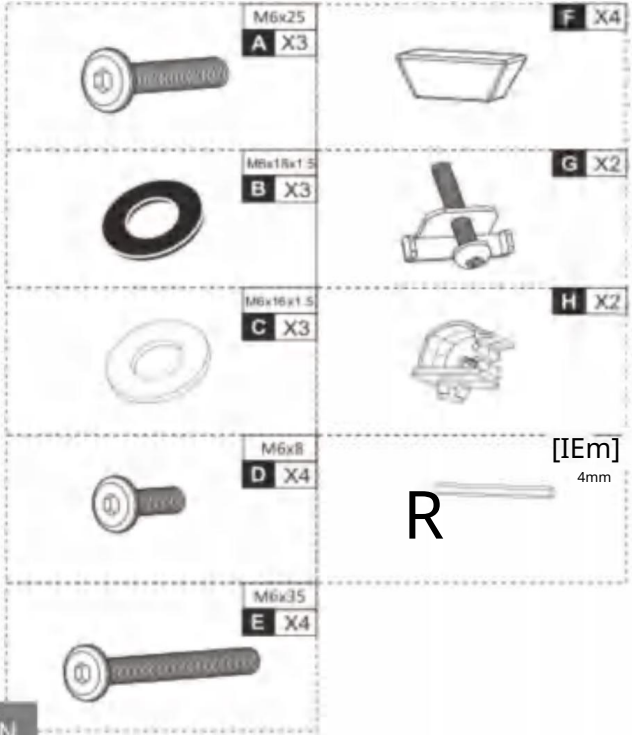

KROK MONTÁŽU

1

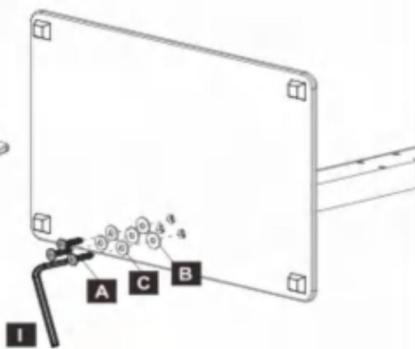
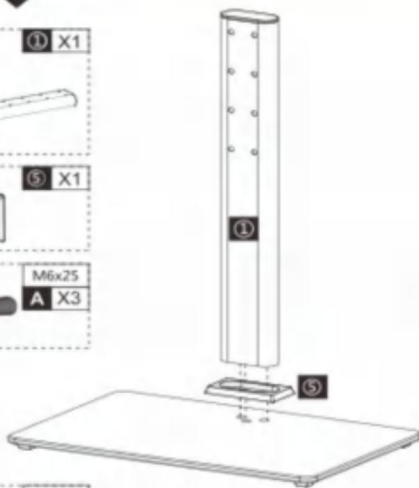
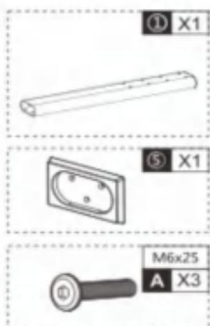
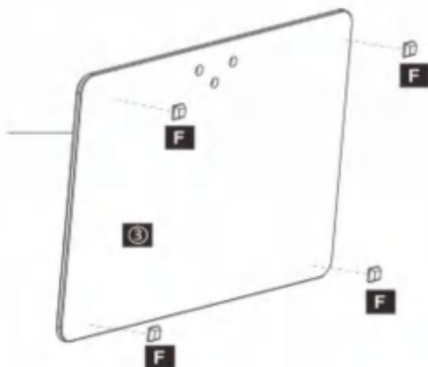
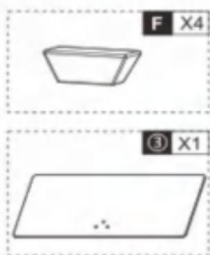

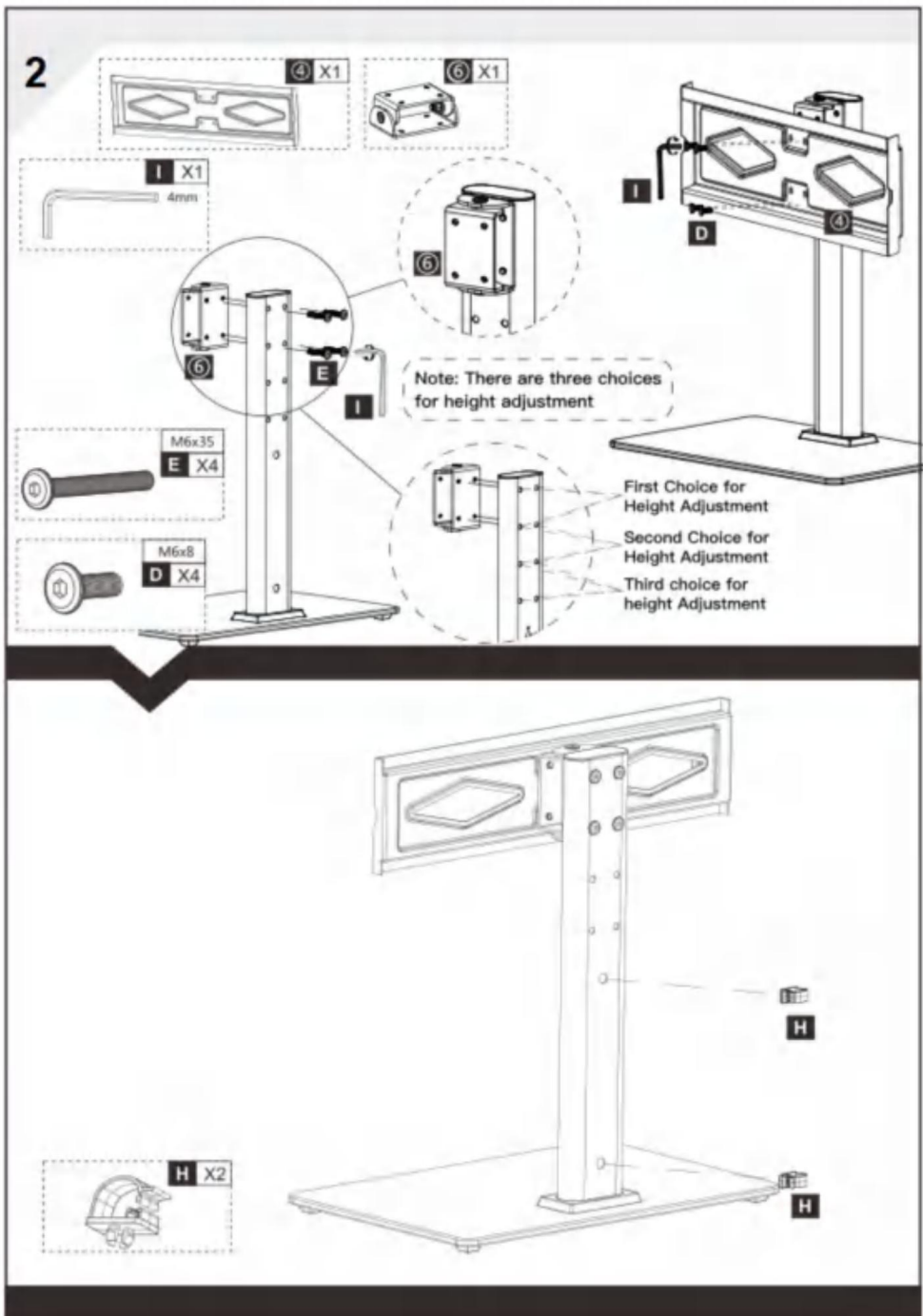

3

Measure the TV fixing holes Width and Height

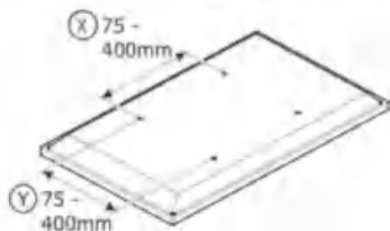

If width (X) is greater than 600mm or height (Y) greater than 400mm STOP installation now and contact the customer help line

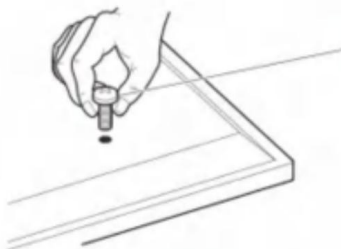

- TV1
- TV2-3
- TV4-5

You are provided with 4 diameters of TV fixing screws, **M4**, **M6** and **M8**. Determine the screw diameter that fits.

Spacers

SP

For TVs with irregular/obstructed back



No Spacers

For TVs with flat/unobstructed back

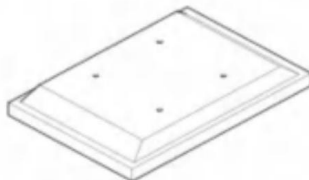

WARNING

please keep for future reference.



4

NOT INCLUDED

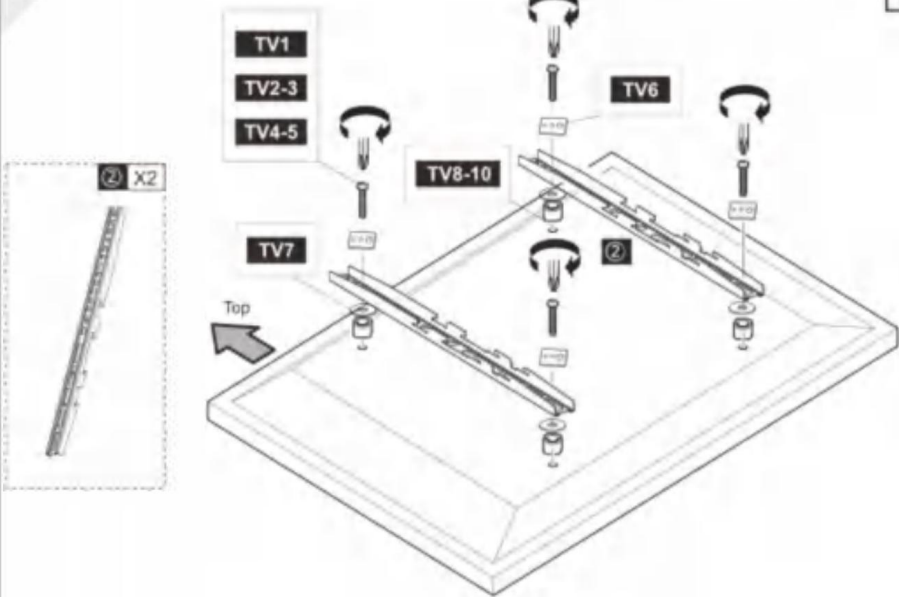

+

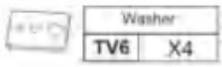

+



+

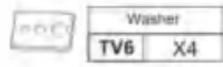

+



+

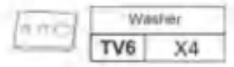

+

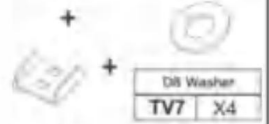

Przymocuj uchwyt do tylnej części telewizora za pomocą odpowiednich śrub, reduktorów i dystansów.

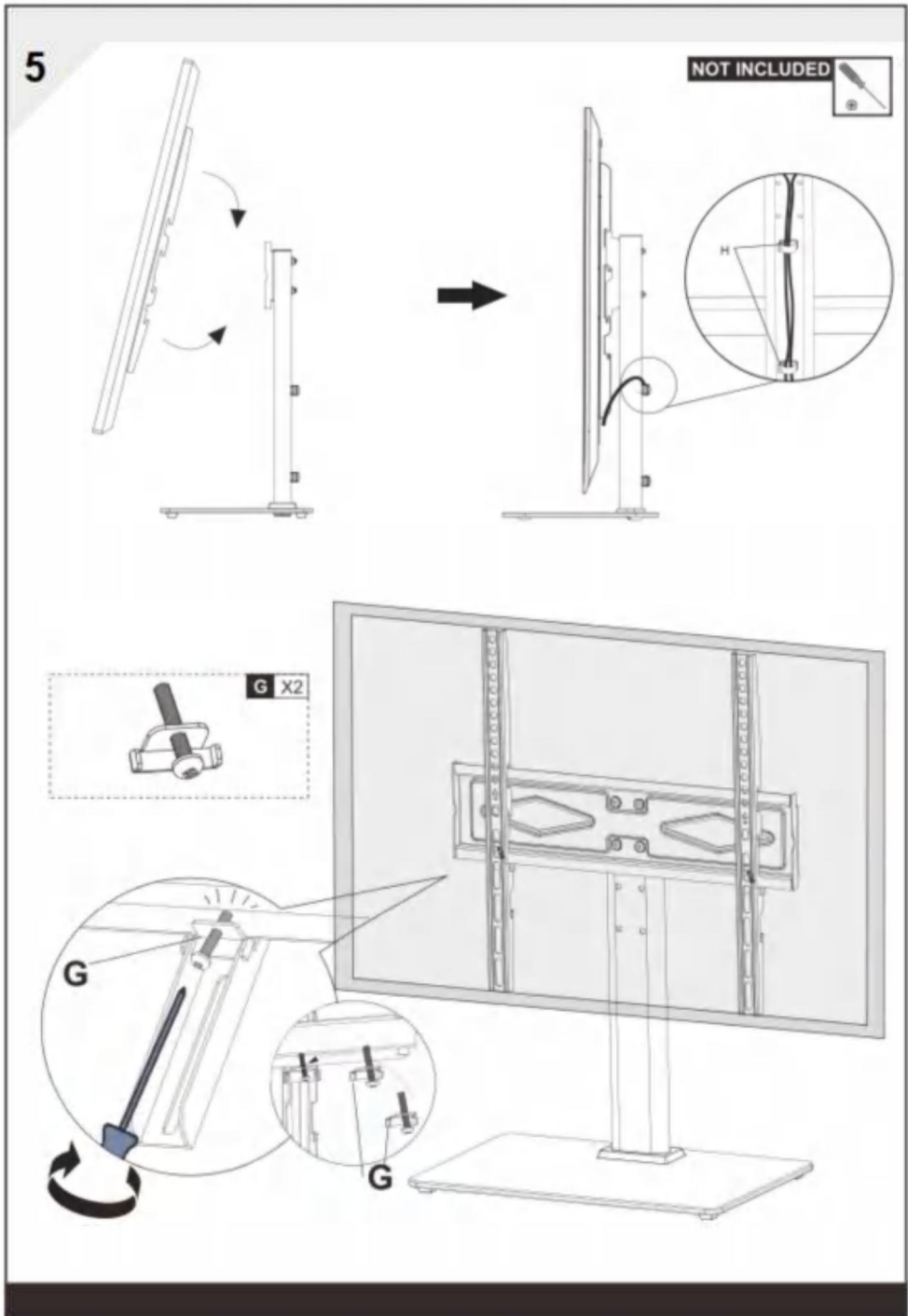

Producent: Shanghaimuxinmuyeyouxiangongsi Adres:

Shuangchenglu 803nong11 hao1602A-1609shi, baoshanqu, szanghaj
200000 CN.

Importowane do AUS: SIHAO PTY LTD. 1 ROKEVA STREETEAST-WOOD NSW 2122
Australia Importowane do USA:

Sanven Technology Ltd. Suite 250, 9166 Anaheim Place, Rancho Cucamonga,
CA91730



E-CrossStu GmbH

Mainzer Landstr.69, 60329 Frankfurt nad Menem.



YH CONSULTING LIMITED.

C/O YH Consulting Limited Biuro 147, Centurion House, London
Road, Staines-upon-Thames, Surrey, TW18 4AX

V I TO R[®]

TRUDNY NARZĘDZIA V, POŁOWA CENAI

Wsparcie techniczne i certyfikat gwarancji
elektronicznej www.vevor.com/support

Vevoit

ROBUUSTE GEREEDSCHAPPEN, HALVE PRIJS

Technische ondersteuning en e-garantiecertificaat www.vevor.com/support

TELEVISIE STANDAARD

GEBRUIKERSHANDLEIDING

MODEL: TV16-Y

Wij streven er voortdurend naar om u gereedschappen tegen concurrerende prijzen te leveren.

"Bewaars de helft" of "Halve prijs" of andere soortgelijke uitdrukkingen die wij gebruiken, vertegenwoordigen slechts een schatting van de besparingen die u kunt behalen door bepaalde gereedschappen bij ons te kopen in vergelijking met de grote topmerken en doseringen betekenen niet noodzakelijkerwijs dat alle categorieën gereedschappen die wij aanbieden, worden gedekt. Wij herinneren u eraan om zorgvuldig te controleren of u daadwerkelijk de helft bespaart in vergelijking met de grote topmerken wanneer u een bestelling bij ons plaatst.

VEVOR®

ROBUUSTE GEREEDSCHAPPEN, HALVE PRIJS

TELEVISIE STANDAARD

MODEL:TV16-Y



HULP NODIG? NEEM CONTACT MET ONS OP!

Heeft u vragen over het product? Heeft u technische ondersteuning nodig? Neem dan gerust contact met ons op:

Klantenservice@vevor.com

Dit is de originele instructie, lees alle handleidingen zorgvuldig door voordat u het product gebruikt. VEVOR behoudt zich een duidelijke interpretatie van onze gebruikershandleiding voor. Het uiterlijk van het product is afhankelijk van het product dat u hebt ontvangen. Vergeef ons dat we u niet opnieuw zullen informeren als er technologie- of software-updates voor ons product zijn.

VEILIGHEIDSINSTRUCTIES

WAARSCHUWING:

Lees dit materiaal voordat u dit product gebruikt. Als u dit niet doet, kan dit leiden tot ernstig letsel.

Voorzorgsmaatregelen bij

de montage 1. Monteer alleen volgens deze instructies. Onjuiste montage kan gevaren creëren.

2. Draag tijdens de montage een ANSI-goedgekeurde veiligheidsbril en stevige werkhandschoenen.

3. Zorg ervoor dat de montageplek schoon en goed verlicht is.

4. Houd omstanders uit de buurt tijdens de montage.

5. Kom niet bijeen als u moe bent of onder invloed van alcohol, drugs of medicijnen.

6. Het draagvermogen en andere producteigenschappen gelden alleen voor een correct en volledig gemonteerd product.

7. Monteer de set op een vlak, egaal, hard en glad oppervlak dat een volledig beladen tv-standaard veilig kan dragen.

Neem voorzorgsmaatregelen

OM ERNSTIG LETSEL EN DE DOOD DOOR KANTELEN TE VOORKOMEN:

1. NIET OP DIT ITEM ZITTEN, STAAN OF KLIMMEN.

2. Dit product is geen speelgoed. Laat kinderen niet met of in de buurt van dit item spelen.

3. Overschrijd het aangegeven gewicht niet. Dit kan ernstig letsel of materiële schade tot gevolg hebben!

4. Gebruik het apparaat alleen op een vlak, egaal, hard en glad oppervlak dat een volledig beladen tv-standaard veilig kan dragen.

5. Til niet terwijl het geladen is.

6. Gebruik het product alleen zoals bedoeld.

7. Controleer het apparaat voor elk gebruik. Gebruik het apparaat niet als er onderdelen loszitten of beschadigd zijn.

BEWAAR DEZE HANDLEIDING

PRODUCTPARAMETER

Model	TV16-J
Draaggewicht	Maximaal 90 pond
Montage-afmeting	Max: 400x400mm/16"x16 b Min: 75x75mm/3wx3 '
Schermgrootte	55" Maximaal
Productgrootte	670x435x260mm
Netto gewicht	4,40kg
Brutogewicht	4,65kg

ONDERDELENLIJST

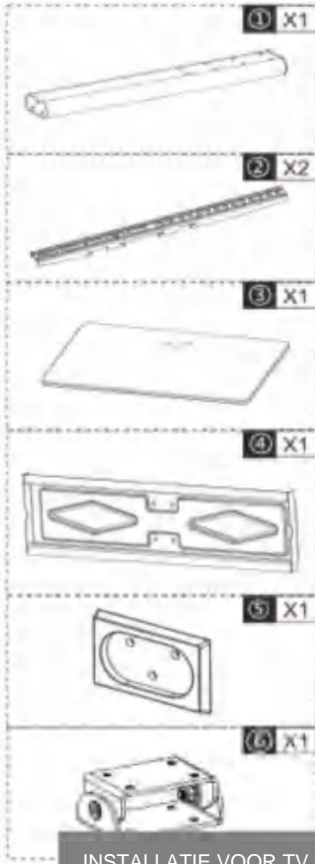

^3^ Plastic Ring
 yyStalen Ring

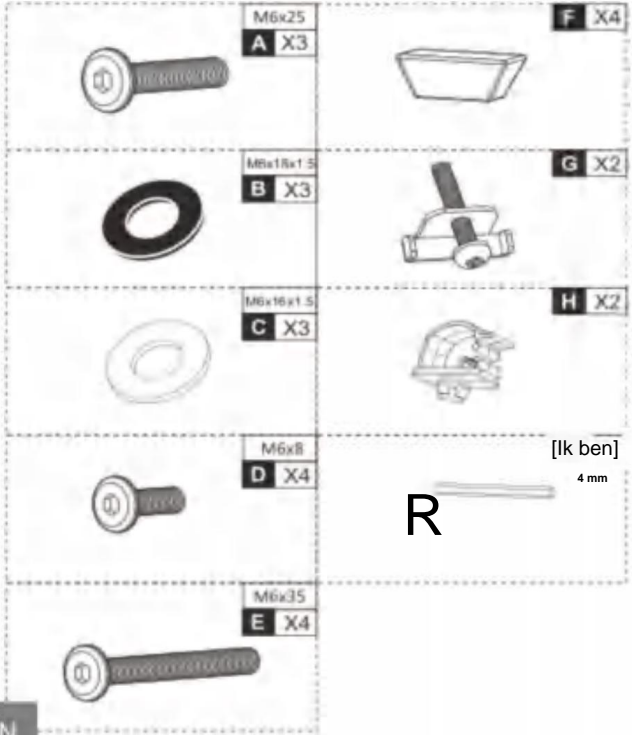

INSTALLATIE VOOR TV ON

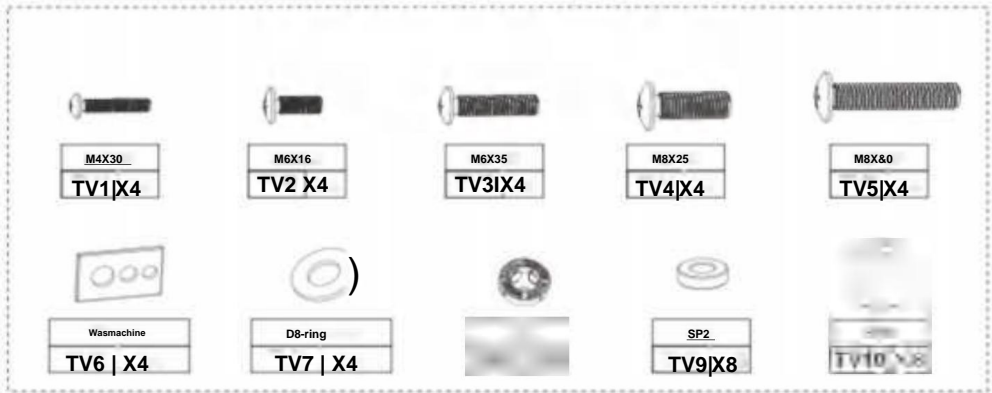

MONTAGESTAP

1

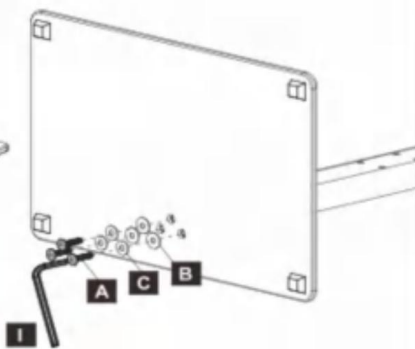
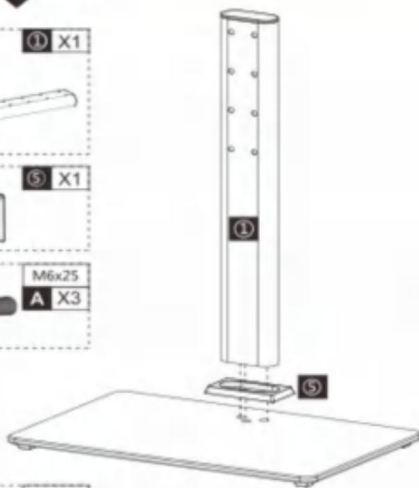
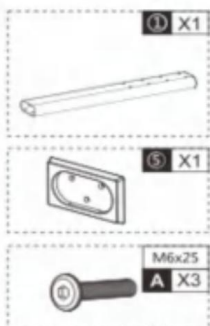
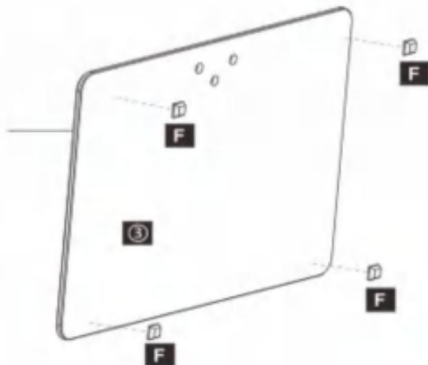
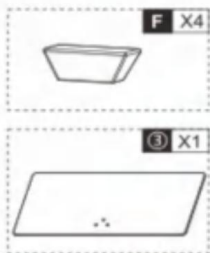

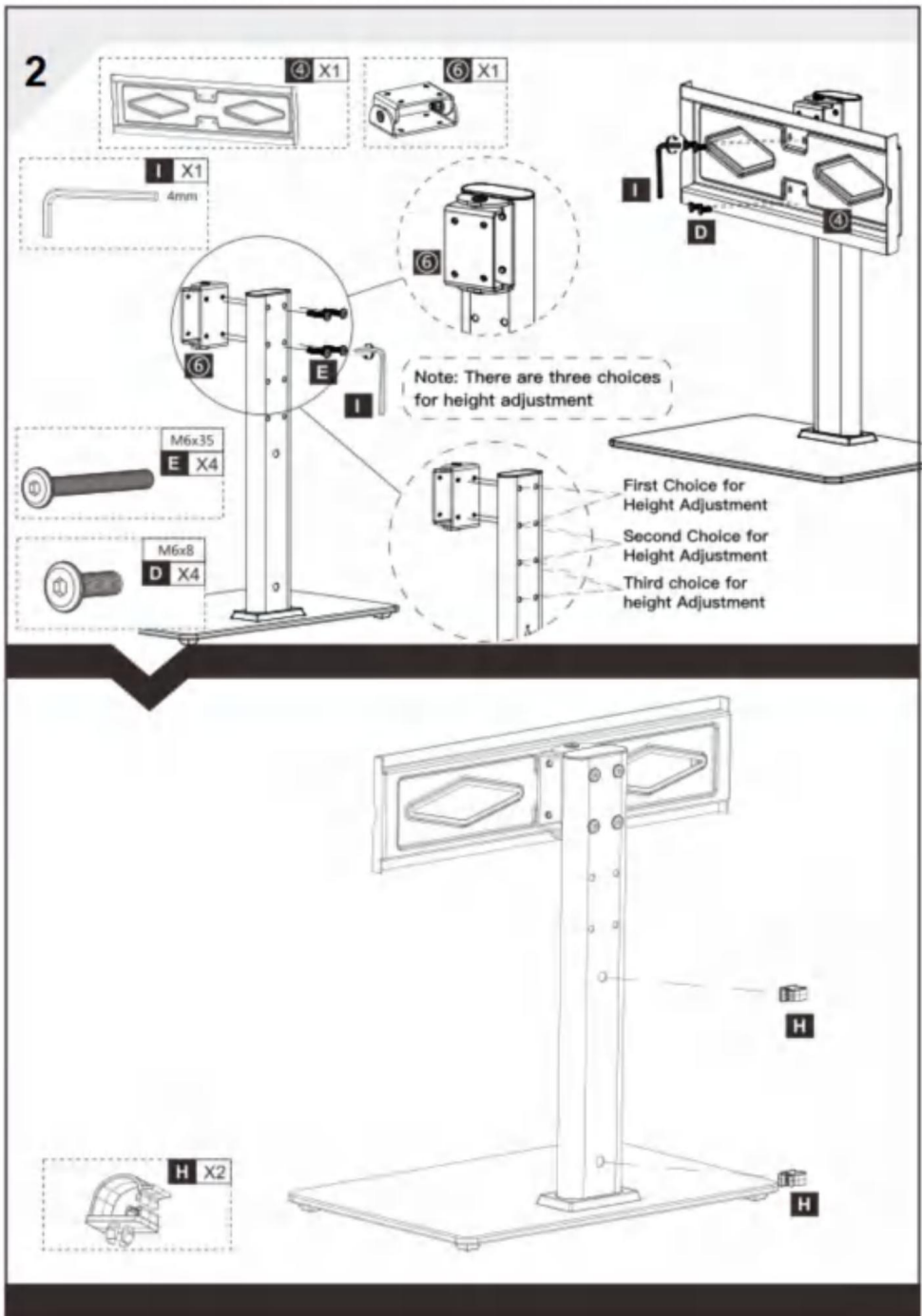

3

Measure the TV fixing holes Width and Height

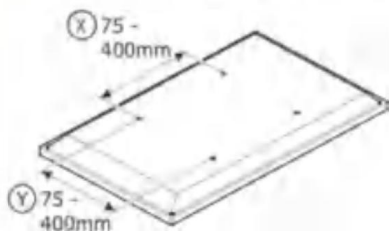

If width (X) is greater than 600mm or height (Y) greater than 400mm STOP installation now and contact the customer help line

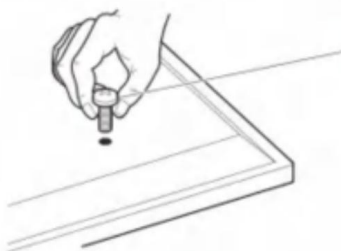

TV1

TV2-3

TV4-5

You are provided with 4 diameters of TV fixing screws, **M4**, **M6** and **M8**. Determine the screw diameter that fits.

Spacers

SP

For TVs with irregular/obstructed back



No Spacers

For TVs with flat/unobstructed back

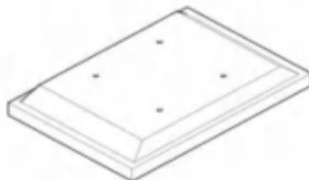

WARNING

please keep for future reference.

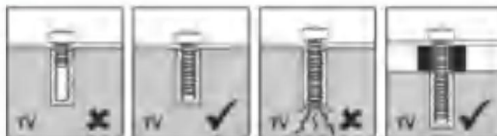

4

NOT INCLUDED 

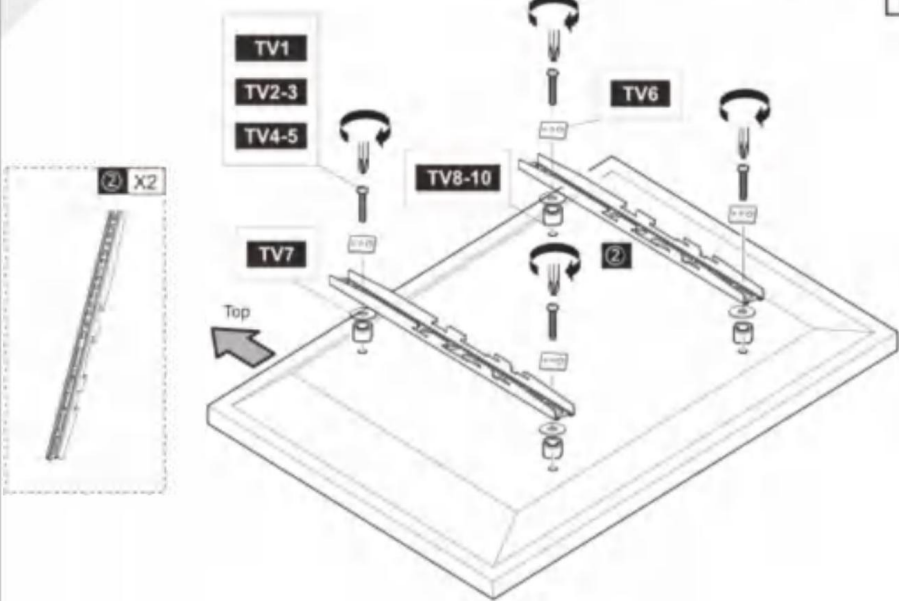

+

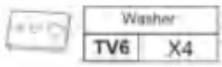

+



+



+

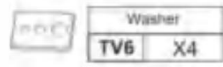

+



+



+

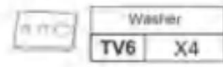

+



+



FR

IT

DE

DE

Bevestig de beugel aan de achterkant van uw tv met behulp van de juiste combinatie van schroeven, verloopstukken en afstandhouders.

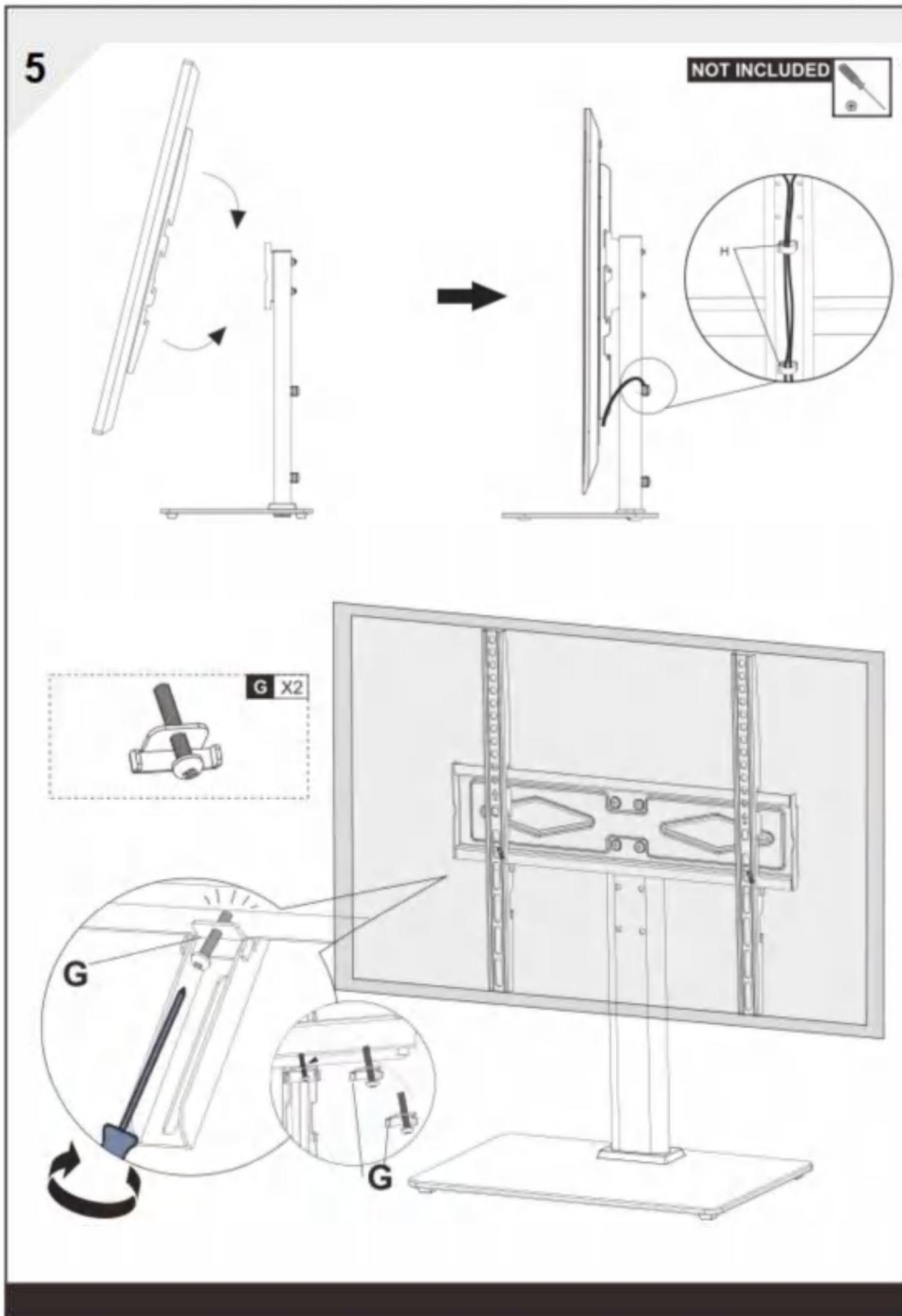

Fabrikant: Shanghaimuxinmuyeyouxiangongsi Adres:

Shuangchenglu 803nong11 hao1602A-1609shi, baoshanqu, shanghai
200000 CN.

Geïmporteerd naar AUS: SIHAO PTY LTD. 1 ROKEVA STREETEAST-WOOD NSW
2122 Australië Geïmporteerd naar

de VS: Sanven Technology Ltd. Suite 250, 9166 Anaheim Place, Rancho
Cucamonga, CA91730



E-CrossStu GmbH
Mainzer Landstr.69, 60329 Frankfurt am Main.



YH CONSULTING LIMITED.
C/O YH Consulting Limited Kantoor 147, Centurion House, London
Road, Staines-upon-Thames, Surrey, TW18 4AX

V EN DER [®]

MOEILIK GEREEDSCHAP V, HALF **PRIJS**^{EN}

Technische ondersteuning en e-
garantiecertificaat www.vevor.com/support

vevoit

TÅRA VERKTYG, HALVA PRISET

Teknisk support och e-garanticertifikat www.vevor.com/support

TV-STAT

ANVÄNDARMANUAL

MODELL: TV16-Y

Vi fortsätter att vara engagerade i att ge dig verktyg till konkurrenskraftiga priser.

"Spara hälften", "Halva priset" eller andra liknande uttryck som används av oss representerar endast en uppskattning av besparingar du kan dra nytta av att köpa vissa verktyg hos oss jämfört med de stora toppmärkena och doserna betyder inte nödvändigtvis att täcka alla kategorier av verktyg som erbjuds av oss. Du påminns vänligen om att noggrant verifiera när du lägger en beställning hos oss om du faktiskt sparar hälften i jämförelse med de främsta stora varumärkena.

VEVOR®

TV-STAT

HÅRA VERKTYG, HALVA PRISET

MODELL:TV16-Y



BEHÖVER HJÄLP? KONTAKTA OSS!

Har du produktfrågor? Behöver du teknisk support? Kontakta oss gärna:

CustomerService@vevor.com

Detta är den ursprungliga instruktionen, läs alla instruktioner noggrant innan du använder den. VEVOR reserverar sig för en tydlig tolkning av vår användarmanual. Utseendet på produkten är beroende av den produkt du fått. Ursäkta oss att vi inte kommer att informera dig igen om det finns någon teknik eller mjukvaruuppdateringar på vår produkt.

SÄKERHETSINSTRUKTIONER

VARNING:

Läs detta material innan du använder denna produkt. Underlåtenhet att göra det kan resultera i allvarliga skador.

Försiktighetsåtgärder vid

- montering**
1. Montera endast enligt dessa instruktioner. Felaktig montering kan skapa faror.
 2. Bär ANSI-godkända skyddsglasögon och kraftiga arbetshandskar vid montering.
 3. Håll monteringsområdet rent och väl upplyst.
 4. Håll åskådare borta från området under monteringen.
 5. Montera inte när du är trött eller påverkad av alkohol, droger eller mediciner.
 6. Viktkapacitet och andra produkttegenskaper gäller endast för korrekt och färdigmonterad produkt.
 7. Montera på en plan, jämn, hård och slät yta som säkert kan stödja ett fullt laddat TV-ställ.

Använd försiktighetsåtgärder

FÖR ATT FÖRHINDRA ALLVARLIGA SKADA OCH DÖDSFALL VID VÄLLNING:

1. **SIT, STÅ ELLER KLÄTTRA INTE PÅ DETTA FÖREMÅL.**
2. Denna produkt är inte en leksak. Låt inte barn leka med eller nära detta föremål.
3. Överskrid inte den angivna vikten. Allvarliga skador eller materiella skador kan uppstå!
4. Använd endast på en plan, jämn, hård och slät yta som säkert kan stödja ett fullt laddat TV-ställ.
5. Lyft inte när den är lastad.
6. Använd endast på avsett sätt.
7. Inspektera före varje användning; Använd inte om delar är lösa eller skadade.







SPARA DENNA MANUAL









PRODUKTPARAMETER

Modell	TV16-Y
Bärande vikt	90lbs Max
Monteringsmått	Max: 400x400mm/16"x16 w Min:75x75mm/3wx3 '
Skärmstorlek	55" Max
Produktstorlek	670x435x260mm
Nettovikt	4,40 kg
Bruttovikt	4,65 kg











DELLISTA

 ^{^3^} **Plastbricka**
 **Stålbricka**

-  ① X1
-  ② X2
-  ③ X1
-  ④ X1
-  ⑤ X1
-  ⑥ X1

- | | | | |
|--|--------------------------|--|-------------------|
|  | M6x25
A X3 |  | F X4 |
|  | M6x16x1.5
B X3 |  | G X2 |
|  | M6x16x1.5
C X3 |  | H X2 |
|  | M6x8
D X4 |  | Em
4 mm |
|  | M6x35
E X4 | | |

INSTALLATION AV FRONT TV ON

- | | | | | |
|---|---|---|---|--|
|  |  |  |  |  |
| M4X30
TV1 X4 | M6X16
TV2 X4 | M6X35
TV3 X4 | M8X25
TV4 X4 | M8X80
TV5 X4 |
|  |  |  |  |  |
| Bricka
TV6 X4 | D8 Bricka
TV7 X4 | | SP2
TV9 X8 | TV10 X8 |

MONTERINGSTEG

1

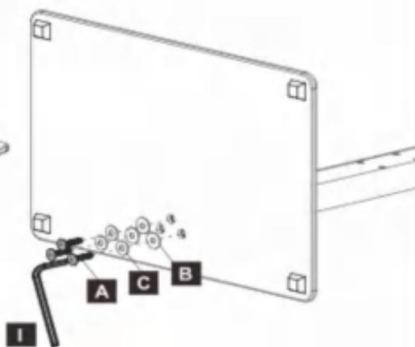
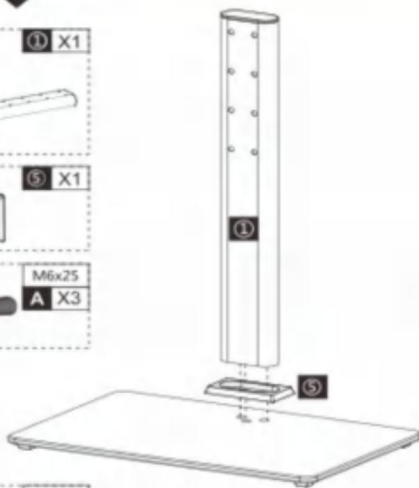
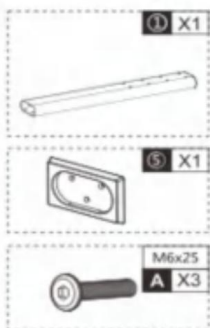
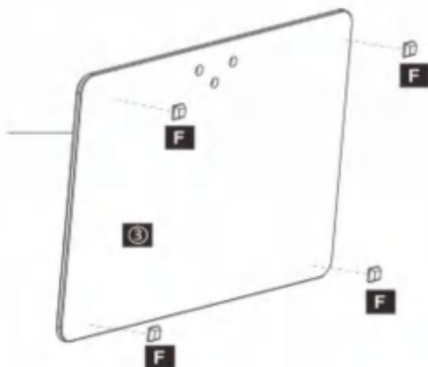
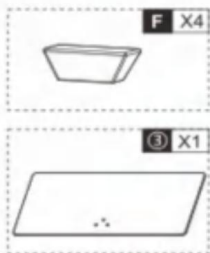

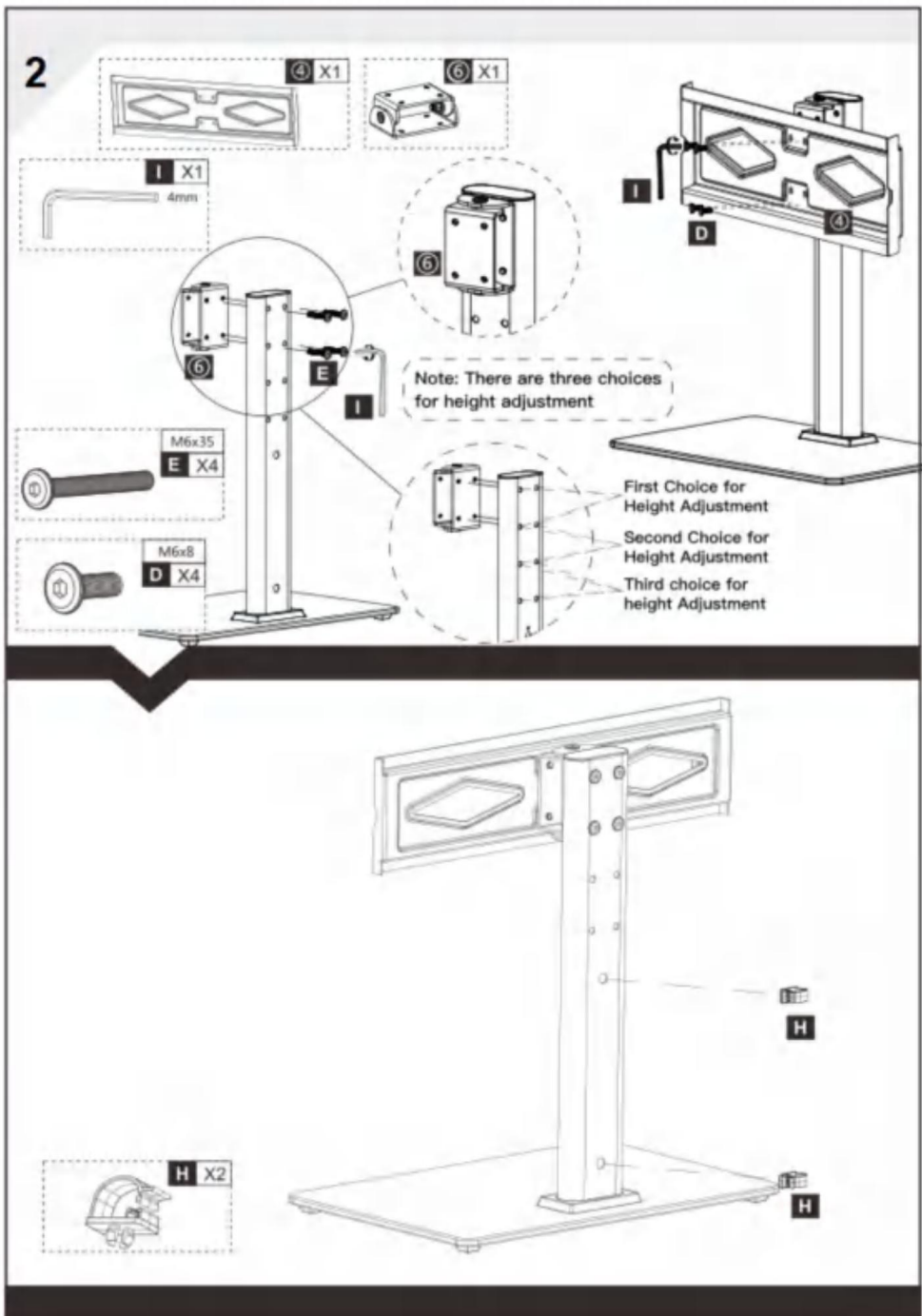

3

Measure the TV fixing holes Width and Height

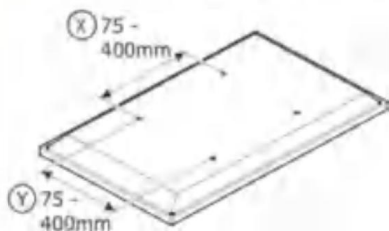

If width (X) is greater than 600mm or height (Y) greater than 400mm STOP installation now and contact the customer help line

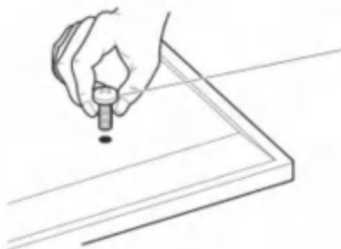

TV1

TV2-3

TV4-5

You are provided with 4 diameters of TV fixing screws, **M4**, **M6** and **M8**. Determine the screw diameter that fits.

Spacers

SP

For TVs with irregular/obstructed back



No Spacers

For TVs with flat/unobstructed back

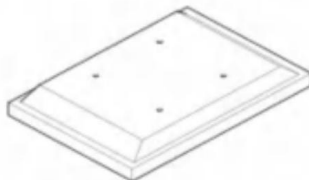

WARNING

please keep for future reference.



4

NOT INCLUDED

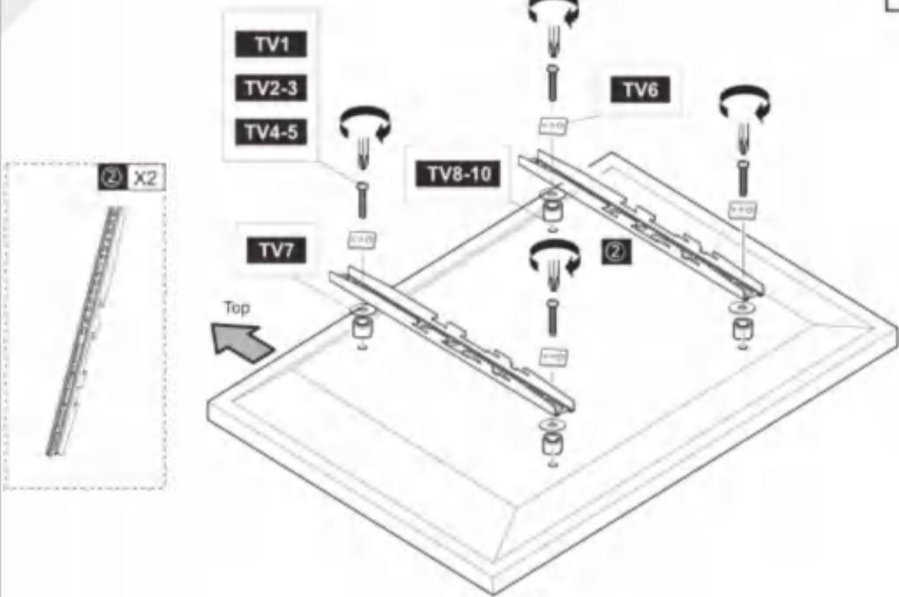

+

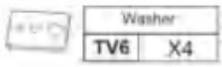

+



+



+

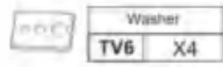

+



+



+

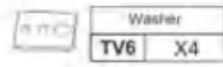

+

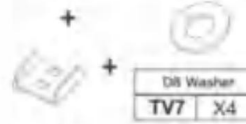

+



■

■

de

DE

Fäst fästet på baksidan av din TV med lämpliga kombinationer av skruv, reducering och distans.

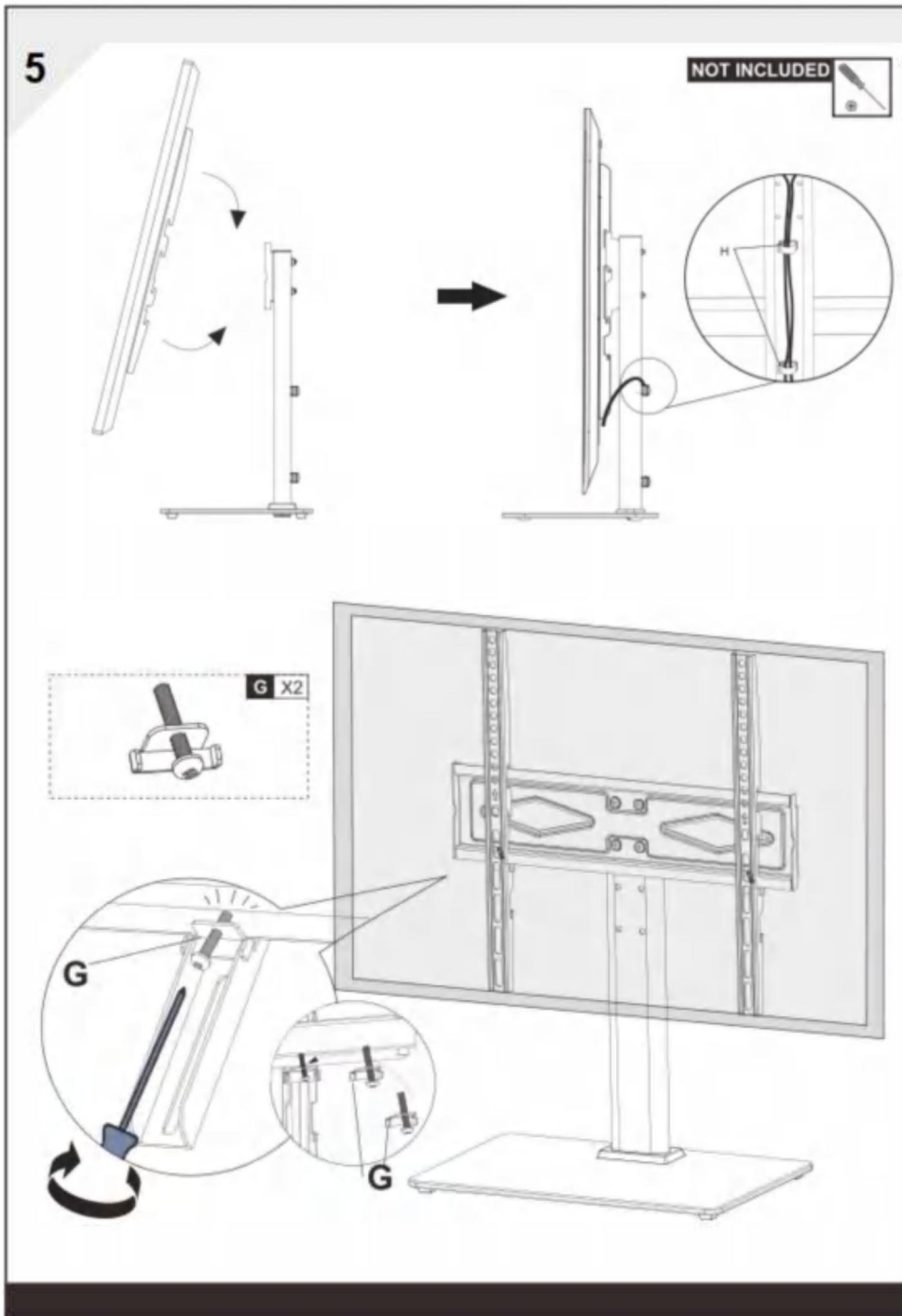

Tillverkare: Shanghaimuxinmuyeyouxiangongsi Adress:

Shuangchenglu 803nong11 hao1602A-1609shi, baoshanqu, shanghai
200000 CN.

Importerad till AUS: SIHAO PTY LTD. 1 ROKEVA STREETEAST-WOOD NSW 2122
Australien Importerad till USA:

Sanven Technology Ltd. Suite 250, 9166 Anaheim Place, Rancho Cucamonga,
CA91730



E-CrossStu GmbH
Mainzer Landstr.69, 60329 Frankfurt am Main.



YH CONSULTING LIMITED.
C/O YH Consulting Limited Office 147, Centurion House, London
Road, Staines-upon-Thames, Surrey, TW18 4AX

V OCH **DER**®

TUFF VERKTYG V, HALV PRIC_{och}

Teknisk support och e-garanticertifikat

www.vevor.com/support
