

VEVOR[®]

TOUGH TOOLS, HALF PRICE

Technical Support and E-Warranty Certificate www.vevor.com/support

UTILITY CARTS

USER MANUAL

MODEL:UD253-3

We continue to be committed to provide you tools with competitive price.

"Save Half", "Half Price" or any other similar expressions used by us only represents an estimate of savings you might benefit from buying certain tools with us compared to the major top brands and does not necessarily mean to cover all categories of tools offered by us. You are kindly reminded to verify carefully when you are placing an order with us if you are actually saving half in comparison with the top major brands.

VEVOR[®]

TOUGH TOOLS, HALF PRICE

UTILITY CARTS

MODEL:UD253-3



NEED HELP? CONTACT US!

Have product questions? Need technical support? Please feel free to contact us:

Technical Support and E-Warranty Certificate www.vevor.com/support

This is the original instruction, please read all manual instructions carefully before operating. VEVOR reserves a clear interpretation of our user manual. The appearance of the product shall be subject to the product you received. Please forgive us that we won't inform you again if there are any technology or software updates on our product.

SAFETY INSTRUCTION AND PRECAUTIONS



WARNING:

Read this material before using this product. Failure to do so can result in serious injury. SAVE THIS MANUAL

Assembly precautions

1. Assemble only according to these instructions. Improper assembly can create hazards.
2. Wear ANSI-approved safety goggles and heavy-duty work gloves during assembly.
3. Keep assembly area clean and well lit.
4. Keep bystanders out of the area during assembly.
5. Do not assemble when tired or when under the influence of alcohol, drugs or medication.
6. Weight capacity and other product capabilities apply to properly and completely assembled product only.
7. Assemble on a flat, level, hard and smooth surface capable of safely supporting a fully loaded service cart.

Use precautions

TO PREVENT SERIOUS INJURY AND DEATH FROM TIPPING:

1. DO NOT SIT, STAND OR CLIMB ON THIS ITEM.
2. This product is not a toy nor a toy chest. Do not allow children to play with or near this item.
3. Do not exceed weight capacities, evenly distributed from bottom up. Be aware of dynamic loading! Sudden load movement may briefly create excess load causing product failure. Do not exceed capacity of bench or shelf supporting Top Chest.
4. Use only on a flat, level, hard and smooth surface capable of safely supporting a fully loaded Chest.
5. Do not lift while loaded.
6. To prevent tipping, push/pull using supplied handle only.







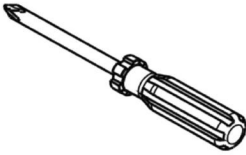
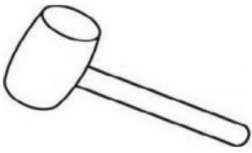

7. Use as intended only.

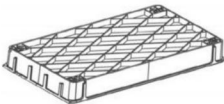
8. Inspect before every use; do not use if parts are loose or damaged.

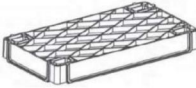
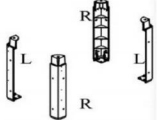
TOOL REQUIRED FOR INSTALLATION

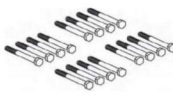
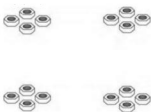
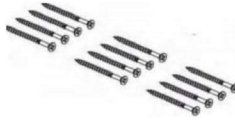
Phillips Screwdriver	Rubber mallet	Note: The phillips screwdriver and rubber mallet tools not included with this product
		

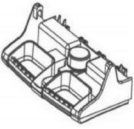
PARTS LIST

1-TOP Tray	2-Middle Tray	3-Bottom Tray	4-Beams
			
5-SwivelCaster	6-FixedCaster	7-Bolts	8-Nuts
			
9-M6Screw	10-SpringWasher	11-Handletray	12-Towelbar
			

ASSEMBLY

1.

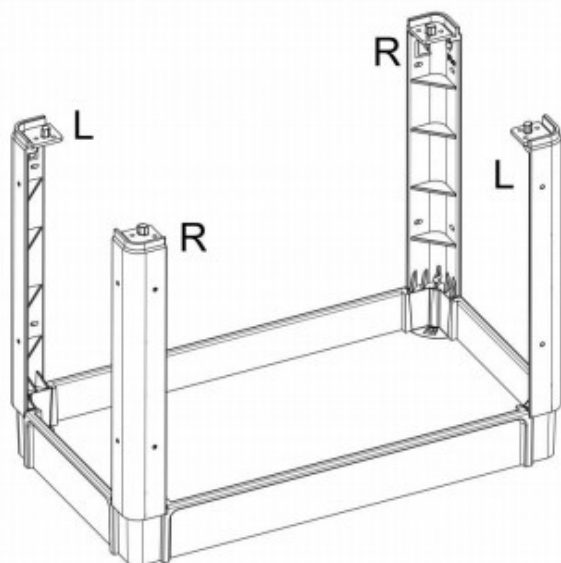

Insert Beam(4) to
the Bottom Shelf(3)
* **R to R, L to L**

2.

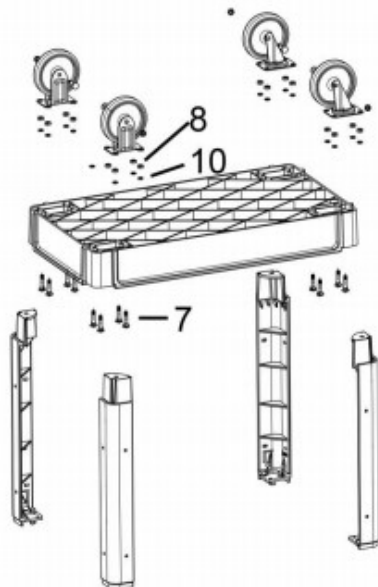

Put 4 wheels(5) & (6)
on the Bottom Shelf
with Blot(7),
Washer(10), Nut(8).

3.

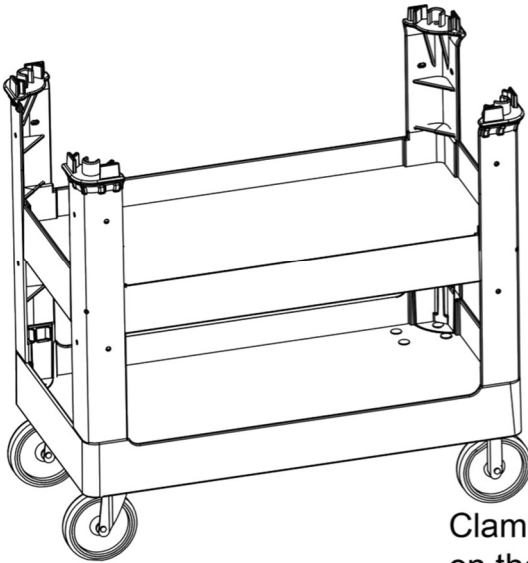

Clamb the Middle Tray (2)
on the Beams (4)

4.

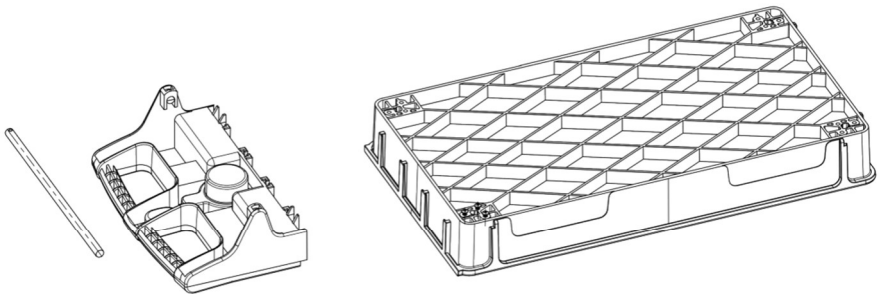

Insert Handle Tray(11) to the TOP Shelf(1),
Knock & reinforce with Rubber Mallet.
Put the Towel Bar (12) in to Handle Tray.

5.

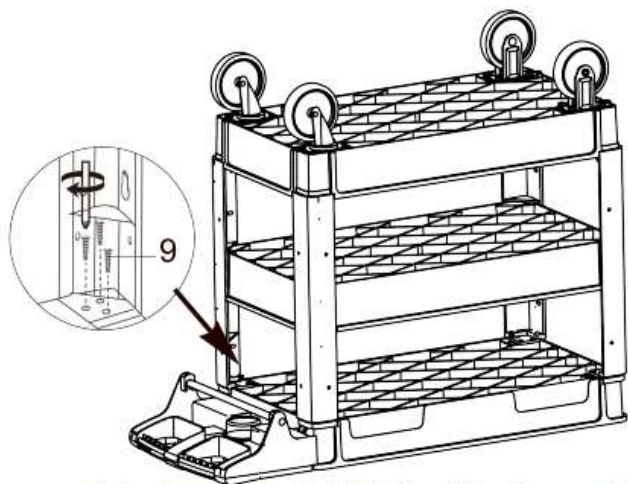

Fix the Beams (4) with TOP Tray (1) by Screws (9).

VEVOR[®]

TOUGH TOOLS, HALF PRICE

Technical Support and E-Warranty Certificate

www.vevor.com/support

VEVOR[®]

TOUGH TOOLS, HALF PRICE

Assistance technique et certificat de garantie électronique www.vevor.com/support

CHARIOTS UTILITAIRES

MANUEL D'UTILISATION

MODÈLE : UD253-3

Nous continuons à nous engager à vous fournir des outils à des prix compétitifs.

« Économisez la moitié », « Moitié prix » ou toute autre expression similaire utilisée par nous ne représente qu'une estimation des économies que vous pourriez réaliser en achetant certains outils chez nous par rapport aux grandes marques et ne couvre pas nécessairement toutes les catégories d'outils que nous proposons.

Nous vous rappelons de bien vouloir vérifier soigneusement lorsque vous passez une commande chez nous si vous économisez réellement la moitié par rapport aux grandes marques.

VEVOR[®]
TOUGH TOOLS, HALF PRICE

CHARIOTS UTILITAIRES

MODÈLE : UD253-3



BESOIN D'AIDE? CONTACTEZ-NOUS!

Vous avez des questions sur nos produits ? Vous avez besoin d'assistance technique ? N'hésitez pas à nous contacter :

Assistance technique et certificat de garantie électronique www.vevor.com/support

Il s'agit de la notice d'utilisation d'origine. Veuillez lire attentivement toutes les instructions du manuel avant de l'utiliser. VEVOR se réserve le droit d'interpréter clairement notre manuel d'utilisation. L'apparence du produit dépend du produit que vous avez reçu. Veuillez nous excuser, nous ne vous informerons plus en cas de mise à jour technologique ou logicielle de notre produit.

SAFETY INSTRUCTION AND PRECAUTIONS



AVERTISSEMENT:

Lisez ce manuel avant d'utiliser ce produit. Le non-respect de ces instructions peut entraîner des blessures graves.

CONSERVEZ CE MANUEL

Précautions de montage

1. Assembler uniquement selon ces instructions. Un assemblage incorrect peut créer des dangers.
2. Portez des lunettes de sécurité approuvées par l'ANSI et des gants de travail robustes pendant l'assemblage.
3. Gardez la zone de montage propre et bien éclairée.
4. Gardez les spectateurs hors de la zone pendant l'assemblage.
5. Ne montez pas lorsque vous êtes fatigué ou sous l'influence de l'alcool, de drogues ou de médicaments.
6. La capacité de poids et les autres capacités du produit s'appliquent correctement et uniquement au produit entièrement assemblé.
7. Assembler sur une surface plane, de niveau, dure et lisse capable de supporter en toute sécurité un chariot de service entièrement chargé.



Précautions d'emploi

POUR ÉVITER LES BLESSURES GRAVES ET LA MORT RÉSULTANT DU BASCULEMENT :





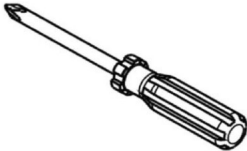



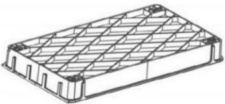

1. NE PAS S'ASSEOIR, SE TENIR DEBOUT OU MONTER SUR CET ARTICLE.
2. Ce produit n'est ni un jouet ni un coffre à jouets. Ne laissez pas les enfants jouer avec ou à proximité de cet article.
3. Ne pas dépasser les capacités de poids, réparties uniformément de bas en haut. Attention au chargement dynamique ! Un mouvement de charge soudain peut brièvement créer une charge excessive entraînant une défaillance du produit. Ne pas dépasser la capacité du banc ou de l'étagère supportant le coffre supérieur.
4. Utiliser uniquement sur une surface plane, dure et lisse capable de supporter en toute sécurité un coffre entièrement chargé.
5. Ne pas soulever pendant la charge.
6. Pour éviter tout basculement, poussez/tirez uniquement à l'aide de la poignée fournie.

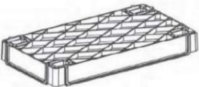
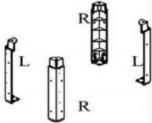
7. Use as intended only.
8. Inspect before every use; do not use if parts are loose or damaged.

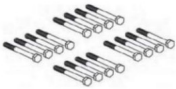
TOOL REQUIRED FOR INSTALLATION

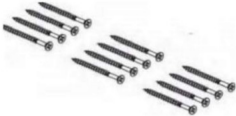
Phillips Screwdriver	Rubber mallet	Note: The phillips screwdriver and rubber mallet tools not included with this product
		

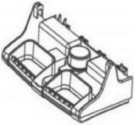
PARTS LIST

1-TOP Tray	2-Middle Tray	3-Bottom Tray	4-Beams
			
5-SwivelCaster	6-FixedCaster	7-Bolts	8-Nuts
			
9-M6Screw	10-SpringWasher	11-Handletray	12-Towelbar
			

ASSEMBLY

1.

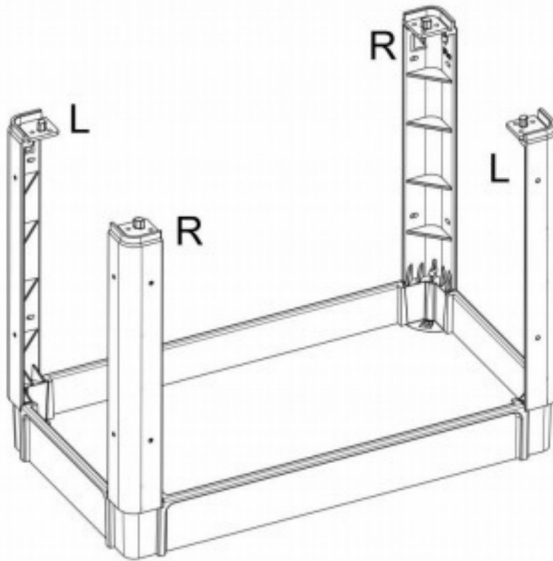

Insert Beam(4) to
the Bottom Shelf(3)
* **R to R, L to L**

2.

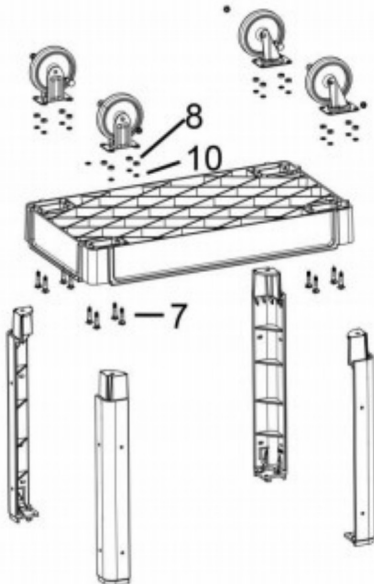

Put 4 wheels(5) & (6)
on the Bottom Shelf
with Blot(7),
Washer(10), Nut(8).

3.

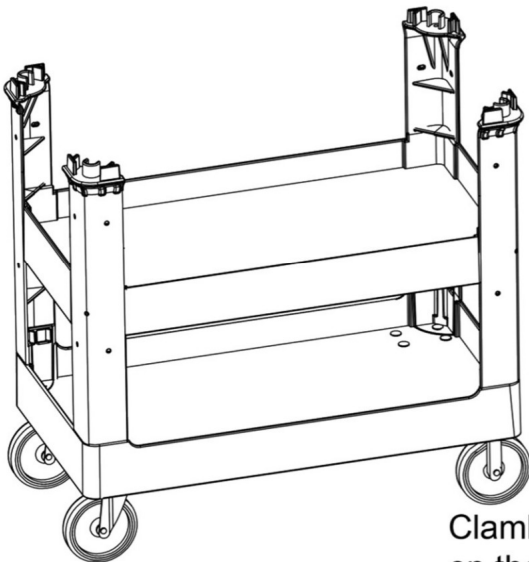

Clamb the Middle Tray (2)
on the Beams (4)

4.

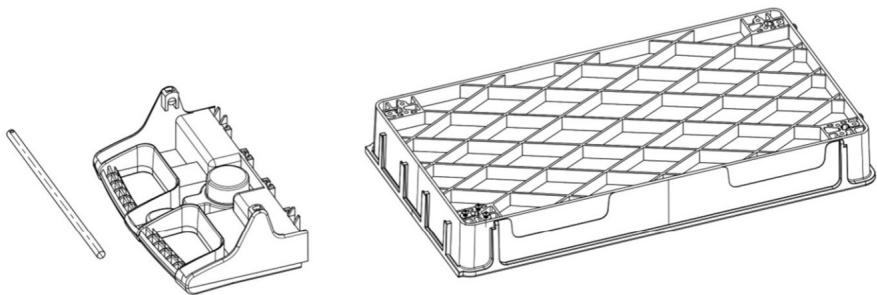

Insert Handle Tray(11) to the TOP Shelf(1),
Knock & reinforce with Rubber Mallet.
Put the Towel Bar (12) in to Handle Tray.

5.

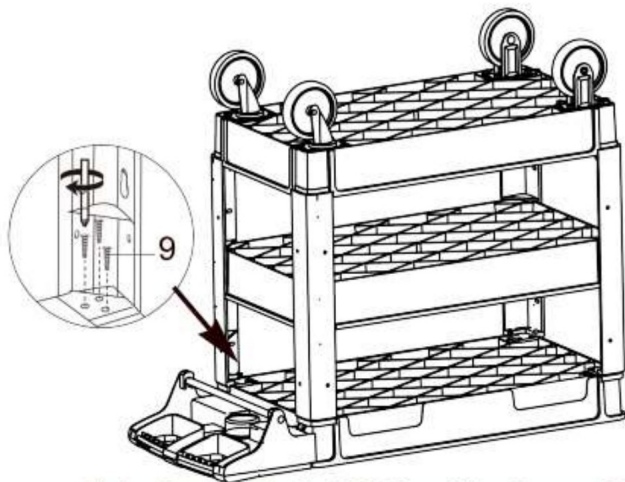

Fix the Beams (4) with TOP Tray (1) by Screws (9).

VEVOR[®]
TOUGH TOOLS, HALF PRICE

Assistance technique et certificat de garantie
électronique www.vevor.com/support

VEVOR[®]

TOUGH TOOLS, HALF PRICE

Technischer Support und E-Garantie-Zertifikat www.vevor.com/support

Mehrzweckwagen

BENUTZERHANDBUCH

MODELL:UD253-3

Wir sind weiterhin bestrebt, Ihnen Werkzeuge zu wettbewerbsfähigen Preisen anzubieten. „Sparen Sie die Hälfte“, „Halber Preis“ oder andere ähnliche Ausdrücke, die wir verwenden, stellen nur eine Schätzung der Ersparnis dar, die Sie beim Kauf bestimmter Werkzeuge bei uns im Vergleich zu den großen Topmarken erzielen können, und decken nicht notwendigerweise alle von uns angebotenen Werkzeugkategorien ab. Wir möchten Sie freundlich daran erinnern, bei Ihrer Bestellung bei uns sorgfältig zu prüfen, ob Sie im Vergleich zu den großen Topmarken tatsächlich die Hälfte sparen.

VEVOR[®]

TOUGH TOOLS, HALF PRICE

Mehrzweckwagen

MODELL:UD253-3

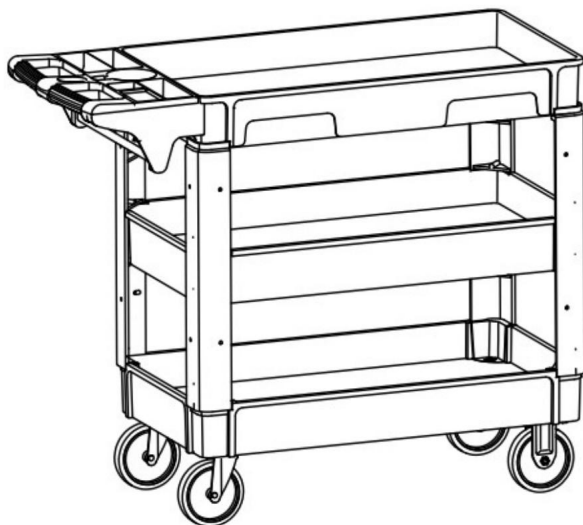

Brauchen Sie Hilfe? Kontaktieren Sie uns!

Sie haben Fragen zu unseren Produkten? Sie benötigen technischen Support? Dann kontaktieren Sie uns gerne:

Technischer Support und E-Garantie-Zertifikat www.vevor.com/support

Dies ist die Originalanleitung. Bitte lesen Sie alle Anweisungen sorgfältig durch, bevor Sie das Gerät in Betrieb nehmen. VEVOR behält sich eine klare Auslegung unserer Bedienungsanleitung vor. Das Erscheinungsbild des Produkts richtet sich nach dem Produkt, das Sie erhalten haben. Bitte verzeihen Sie uns, dass wir Sie nicht erneut informieren, wenn es Technologie- oder Software-Updates für unser Produkt gibt.

SAFETY INSTRUCTION AND PRECAUTIONS



WARNUNG:

Lesen Sie dieses Material, bevor Sie dieses Produkt verwenden. Andernfalls kann es zu schweren Verletzungen kommen. **BEWAHREN SIE DIESES HANDBUCH AUF**

Vorsichtsmaßnahmen bei der Montage

- 1. Nur gemäß dieser Anleitung zusammenbauen. Unsachgemäße Montage kann Gefahren verursachen.**
- 2. Tragen Sie ANSI-zugelassene Schutzbrillen und schwere Arbeitshandschuhe während Montage.**
- 3. Halten Sie den Versammlungsbereich sauber und gut beleuchtet.**
- 4. Halten Sie während der Montage unbeteiligte Zuschauer vom Bereich fern.**
- 5. Nicht zusammenbauen, wenn Sie müde sind oder unter dem Einfluss von Alkohol, Drogen oder Medikamenten stehen.**
- 6. Gewichtskapazität und andere Produktfunktionen gelten für richtig und Nur komplett montiertes Produkt.**
- 7. Auf einer flachen, ebenen, harten und glatten Oberfläche montieren, die sicher zur Unterstützung eines voll beladenen Servicewagens.**

Vorsichtsmaßnahmen treffen



UM SCHWERE VERLETZUNGEN UND TOD DURCH KIPPEN ZU VERMEIDEN:

- 1. Setzen, stellen oder klettern Sie nicht auf diesen Gegenstand.**
- 2. Dieses Produkt ist weder ein Spielzeug noch eine Spielzeugkiste. Erlauben Sie Kindern nicht, mit diesem Artikel oder in dessen Nähe zu spielen.**
- 3. Überschreiten Sie die Gewichtskapazität nicht und verteilen Sie sie gleichmäßig von unten nach oben. Achten Sie auf dynamische Belastung! Plötzliche Lastbewegungen können kurzzeitig zu einer Überlastung führen, die zu Produktausfällen führt. Überschreiten Sie nicht die Tragfähigkeit der Bank oder des Regals, auf dem die Top Chest steht.**
- 4. Nur auf einer flachen, ebenen, harten und glatten Oberfläche verwenden, die eine voll beladene Truhe sicher tragen kann.**
- 5. Nicht unter Last heben.**
- 6. Um ein Umkippen zu verhindern, drücken/ziehen Sie nur mit dem mitgelieferten Griff.**





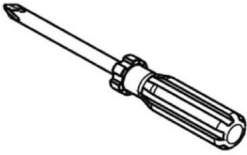

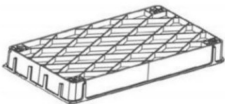

7. Use as intended only.

8. Inspect before every use; do not use if parts are loose or damaged.

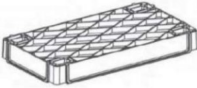
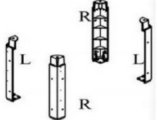
TOOL REQUIRED FOR INSTALLATION

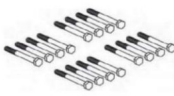
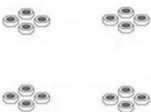
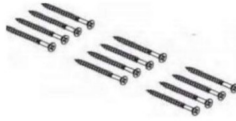
Phillips Screwdriver	Rubber mallet	Note: The phillips screwdriver and rubber mallet tools not included with this product
		

PARTS LIST

1-TOP Tray	2-Middle Tray	3-Bottom Tray	4-Beams
			
5-SwivelCaster	6-FixedCaster	7-Bolts	8-Nuts
			
9-M6Screw	10-SpringWasher	11-Handletray	12-Towelbar
			

ASSEMBLY

1.

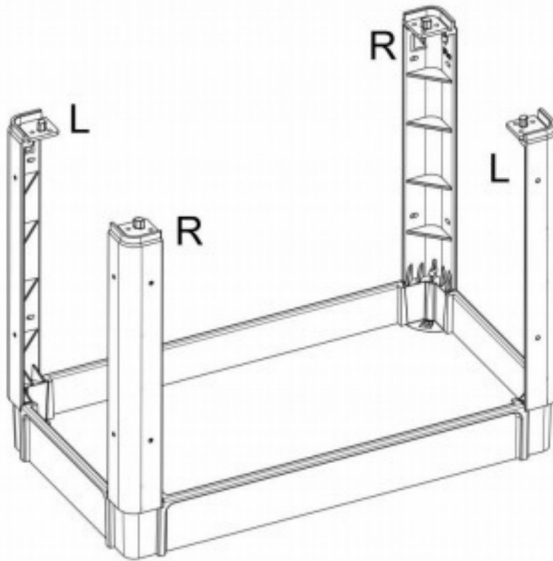

Insert Beam(4) to
the Bottom Shelf(3)
* **R to R, L to L**

2.

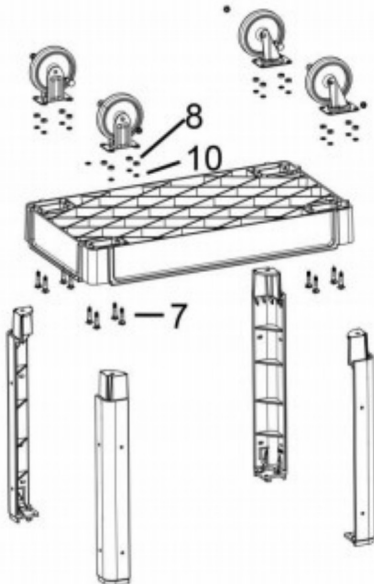

Put 4 wheels(5) & (6)
on the Bottom Shelf
with Blot(7),
Washer(10), Nut(8).

3.

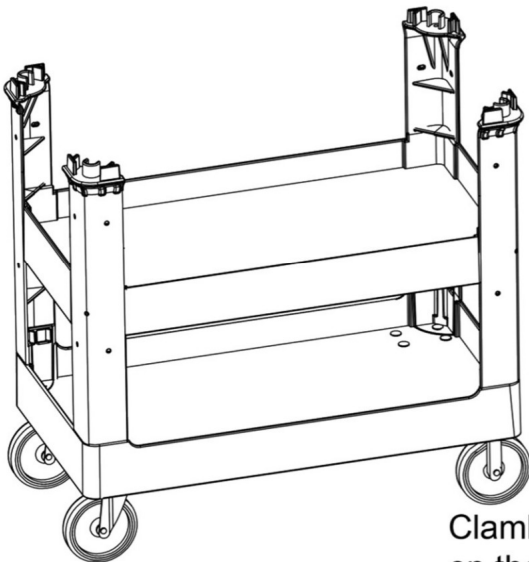

Clamb the Middle Tray (2)
on the Beams (4)

4.

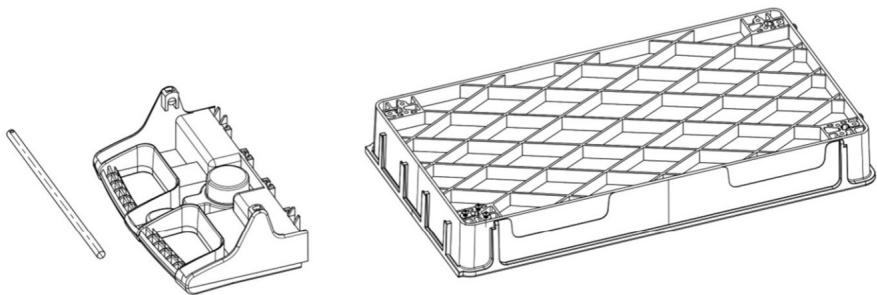

Insert Handle Tray(11) to the TOP Shelf(1),
Knock & reinforce with Rubber Mallet.
Put the Towel Bar (12) in to Handle Tray.

5.

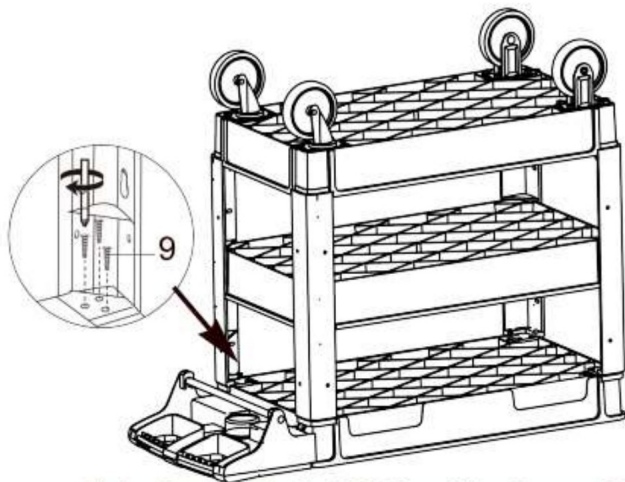

Fix the Beams (4) with TOP Tray (1) by Screws (9).

VEVOR[®]
TOUGH TOOLS, HALF PRICE

Technischer Support und E-Garantie-Zertifikat
www.vevor.com/support

VEVOR[®]

TOUGH TOOLS, HALF PRICE

Supporto tecnico e certificato di garanzia elettronica www.vevor.com/support

CARRELLI DI SERVIZIO

MANUALE D'USO

MODELLO:UD253-3

Continuiamo a impegnarci per fornirvi strumenti a prezzi competitivi.

"Risparmia la metà", "Metà prezzo" o qualsiasi altra espressione simile da noi utilizzata rappresenta solo una stima del risparmio che potresti ottenere acquistando determinati utensili con noi rispetto ai principali marchi principali e non significa necessariamente coprire tutte le categorie di utensili da noi offerti. Ti ricordiamo gentilmente di verificare attentamente

quando effettui un ordine con noi se stai effettivamente risparmiando la metà rispetto ai principali

VEVOR[®]

TOUGH TOOLS, HALF PRICE

CARRELLI DI SERVIZIO

MODELLO:UD253-3



HAI BISOGNO DI AIUTO? CONTATTACI!

Hai domande sui prodotti? Hai bisogno di supporto tecnico? Non esitare a contattarci:

Supporto tecnico e certificato di garanzia elettronica www.vevor.com/support

Questa è l'istruzione originale, si prega di leggere attentamente tutte le istruzioni del manuale prima di utilizzare. VEVOR si riserva una chiara interpretazione del nostro manuale utente. L'aspetto del prodotto sarà soggetto al prodotto ricevuto. Vi preghiamo di perdonarci se non vi informeremo di nuovo se ci sono aggiornamenti tecnologici o software sul nostro prodotto.

SAFETY INSTRUCTION AND PRECAUTIONS



AVVERTIMENTO:

Leggere questo materiale prima di utilizzare questo prodotto. La mancata osservanza di questa norma può causare gravi lesioni. **CONSERVARE QUESTO MANUALE**

Precauzioni di montaggio

1. Assemblare solo secondo queste istruzioni. Un assemblaggio improprio può creare pericoli.
2. Indossare occhiali di sicurezza approvati ANSI e guanti da lavoro resistenti durante l'assemblaggio.
3. Mantenere l'area di assemblaggio pulita e ben illuminata.
4. Tenere gli astanti fuori dall'area durante l'assemblaggio.
5. Non riunirsi quando si è stanchi o sotto l'effetto di alcol, droghe o farmaci.
6. La capacità di peso e le altre capacità del prodotto si applicano correttamente e solo prodotto completamente assemblato.
7. Montare su una superficie piana, livellata, dura e liscia in grado di sostenere in modo sicuro sostenere un carrello di servizio completamente carico.

Usare precauzioni



PER PREVENIRE LESIONI GRAVI E MORTALI DOVUTE AL RIBALTAMENTO:

1. **NON SEDERSI, STARE IN PIEDI O ARRAMPICARSI SU QUESTO OGGETTO.**
2. Questo prodotto non è un giocattolo né un baule porta-giocattoli. Non permettere ai bambini di giocare con o vicino a questo articolo.
3. Non superare le capacità di peso, distribuite uniformemente dal basso verso l'alto. Siate consapevoli del carico dinamico! Un movimento improvviso del carico può creare brevemente un carico eccessivo che causa il guasto del prodotto. Non superare la capacità del banco o dello scaffale che supporta Top Chest.
4. Utilizzare solo su una superficie piana, livellata, dura e liscia in grado di sostenere in modo sicuro un baule completamente carico.
5. Non sollevare oggetti carichi.
6. Per evitare il ribaltamento, spingere/tirare utilizzando solo la maniglia in dotazione.





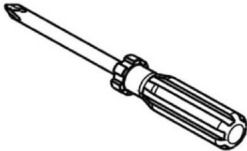



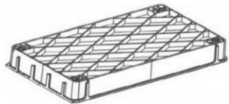

7. Use as intended only.

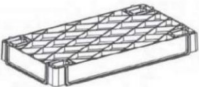
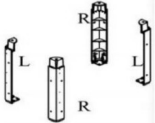
8. Inspect before every use; do not use if parts are loose or damaged.

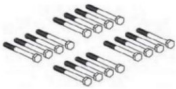
TOOL REQUIRED FOR INSTALLATION

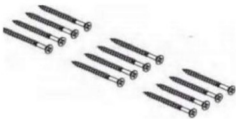
Phillips Screwdriver	Rubber mallet	Note: The phillips screwdriver and rubber mallet tools not included with this product
		

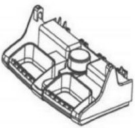
PARTS LIST

1-TOP Tray	2-Middle Tray	3-Bottom Tray	4-Beams
			
5-SwivelCaster	6-FixedCaster	7-Bolts	8-Nuts
			
9-M6Screw	10-SpringWasher	11-Handletray	12-Towelbar
			

ASSEMBLY

1.

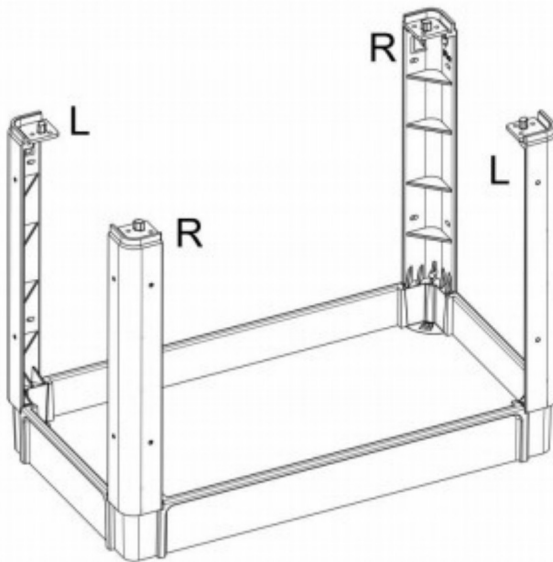

Insert Beam(4) to
the Bottom Shelf(3)
* **R to R, L to L**

2.

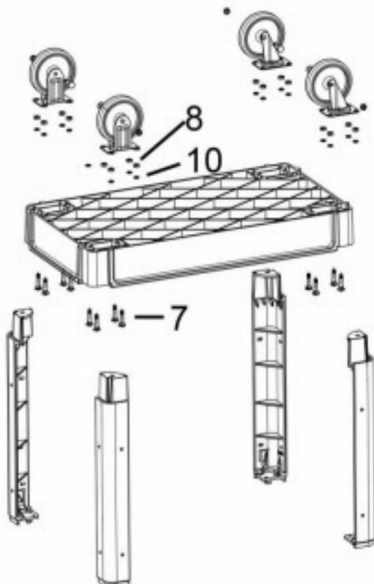

Put 4 wheels(5) & (6)
on the Bottom Shelf
with Blot(7),
Washer(10), Nut(8).

3.

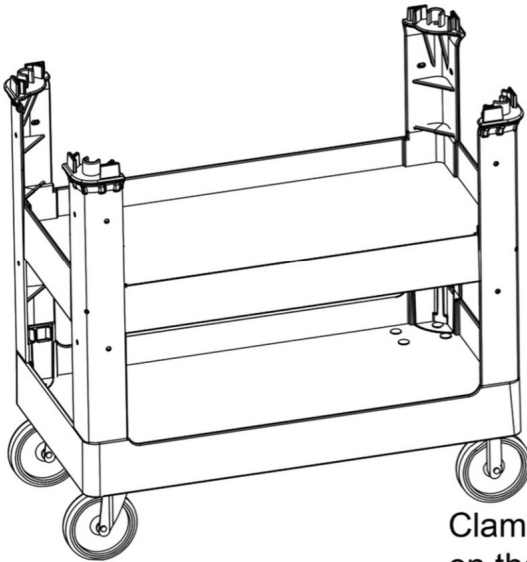

Clamb the Middle Tray (2)
on the Beams (4)

4.

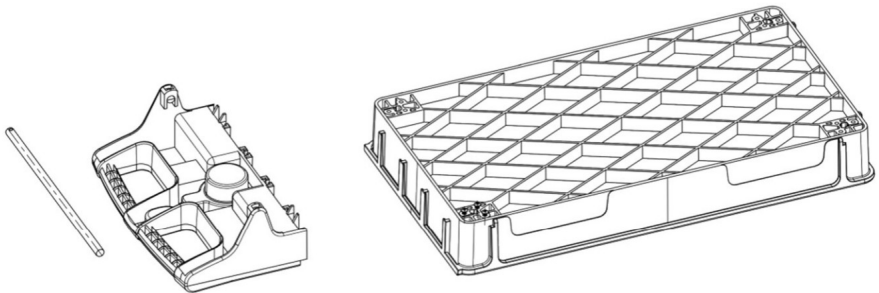

Insert Handle Tray(11) to the TOP Shelf(1),
Knock & reinforce with Rubber Mallet.
Put the Towel Bar (12) in to Handle Tray.

5.

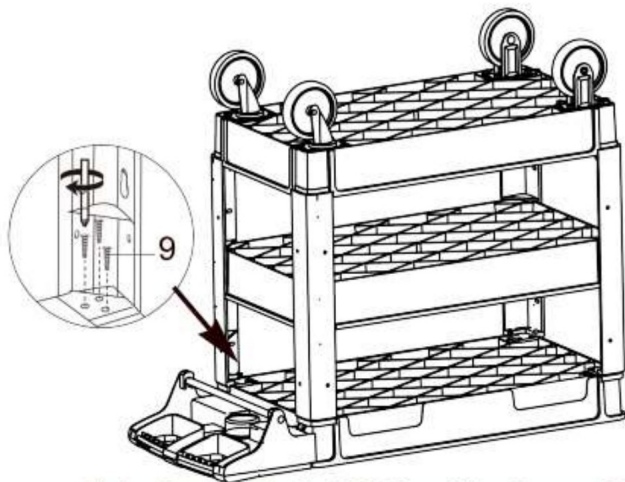

Fix the Beams (4) with TOP Tray (1) by Screws (9).

VEVOR[®]

TOUGH TOOLS, HALF PRICE

**Supporto tecnico e certificato di garanzia
elettronica www.vevor.com/support**

VEVOR[®]

TOUGH TOOLS, HALF PRICE

Soporte técnico y certificado de garantía electrónica www.vevor.com/support

CARRITOS UTILITARIOS

MANUAL DEL USUARIO

MODELO:UD253-3

Seguimos comprometidos a brindarle herramientas a precios competitivos.

"Ahorre la mitad", "mitad de precio" o cualquier otra expresión similar que utilicemos solo representa una estimación del ahorro que podría obtener al comprar ciertas herramientas con nosotros en comparación con las principales marcas y no necesariamente significa que cubra todas las categorías de herramientas que ofrecemos. Le recordamos que, al realizar un pedido con nosotros, verifique cuidadosamente si realmente está ahorrando la mitad en comparación con las principales marcas.

VEVOR[®]
TOUGH TOOLS, HALF PRICE

CARRITOS UTILITARIOS

MODELO:UD253-3



¿NECESITA AYUDA? ¡CONTÁCTENOS!

¿Tiene preguntas sobre el producto? ¿Necesita asistencia técnica? No dude en ponerse en contacto con nosotros:

Soporte técnico y certificado de garantía electrónica www.vevor.com/support

Estas son las instrucciones originales, lea atentamente todas las instrucciones del manual antes de utilizar el producto. VEVOR se reserva una interpretación clara de nuestro manual de usuario. La apariencia del producto estará sujeta al producto que recibió. Perdónenos por no informarle nuevamente si hay actualizaciones de tecnología o software en nuestro producto.

SAFETY INSTRUCTION AND PRECAUTIONS



ADVERTENCIA:

Lea este material antes de utilizar este producto. No hacerlo puede provocar lesiones graves. **GUARDE ESTE MANUAL**

Precauciones de montaje

1. Realice el montaje únicamente de acuerdo con estas instrucciones. Un montaje inadecuado puede generar peligros.
2. Use gafas de seguridad aprobadas por ANSI y guantes de trabajo resistentes durante
asamblea.
3. Mantenga el área de reunión limpia y bien iluminada.
4. Mantenga a los transeúntes fuera del área durante el montaje.
5. No realizar el montaje cuando se encuentre cansado o bajo la influencia de alcohol, drogas o
medicamentos.
6. La capacidad de peso y otras capacidades del producto se aplican de manera adecuada y
Solo producto completamente ensamblado.
7. Montar sobre una superficie plana, nivelada, dura y lisa capaz de soportar cargas de forma segura.
soportando un carro de servicio completamente cargado.



Tome precauciones

PARA EVITAR LESIONES GRAVES Y LA MUERTE POR VUELCO:





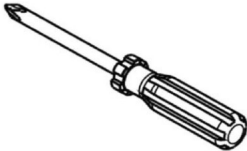



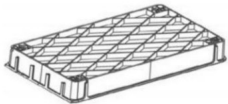

1. **NO SE SIENTA, SE PARE NI SE SUBA SOBRE ESTE ARTÍCULO.**
2. Este producto no es un juguete ni un baúl de juguetes. No permita que los niños jueguen con este artículo
ni cerca de él.
3. No exceda las capacidades de peso, distribuidas uniformemente de abajo hacia arriba. ¡Tenga cuidado con la
carga dinámica! El movimiento repentino de la carga puede generar brevemente un exceso de carga que
provoque fallas en el producto. No exceda la capacidad del banco o estante que soporta el baúl superior.
4. Úselo únicamente sobre una superficie plana, nivelada, dura y lisa capaz de soportar de forma segura un
cofre completamente cargado.
5. No levante mientras esté cargado.
6. Para evitar que se vuelque, empuje o tire utilizando únicamente el mango suministrado.

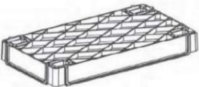
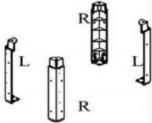
7. Use as intended only.
8. Inspect before every use; do not use if parts are loose or damaged.

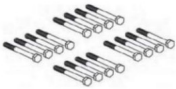
TOOL REQUIRED FOR INSTALLATION

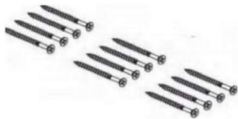
Phillips Screwdriver	Rubber mallet	Note: The phillips screwdriver and rubber mallet tools not included with this product
		

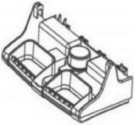
PARTS LIST

1-TOP Tray	2-Middle Tray	3-Bottom Tray	4-Beams
			
5-SwivelCaster	6-FixedCaster	7-Bolts	8-Nuts
			
9-M6Screw	10-SpringWasher	11-Handletray	12-Towelbar
			

ASSEMBLY

1.

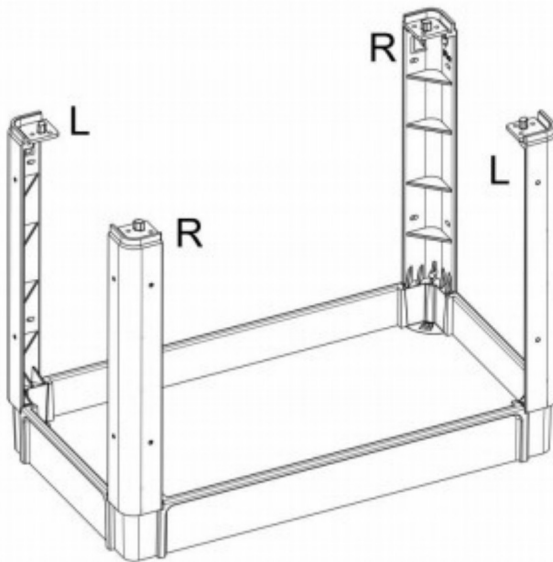

Insert Beam(4) to
the Bottom Shelf(3)
* **R to R, L to L**

2.

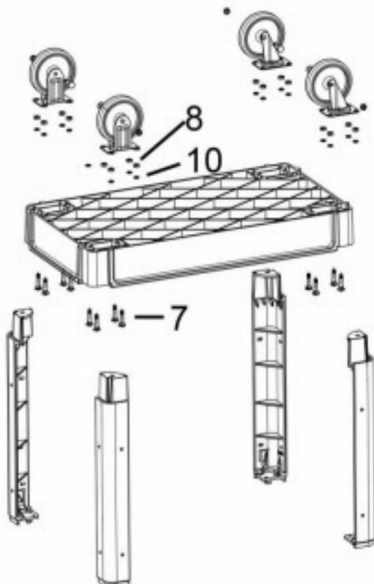

Put 4 wheels(5) & (6)
on the Bottom Shelf
with Blot(7),
Washer(10), Nut(8).

3.

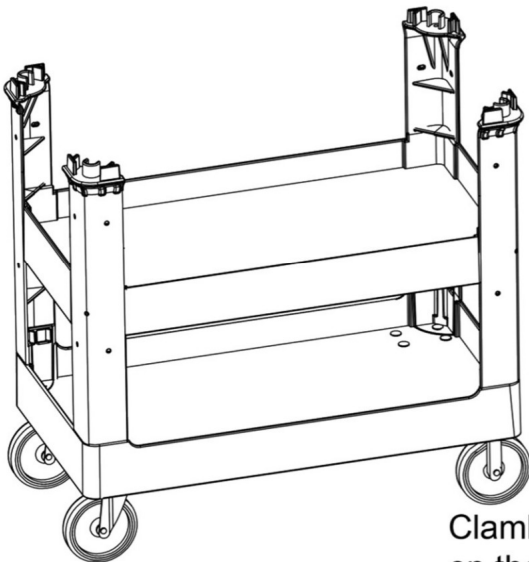

Clamb the Middle Tray (2)
on the Beams (4)

4.

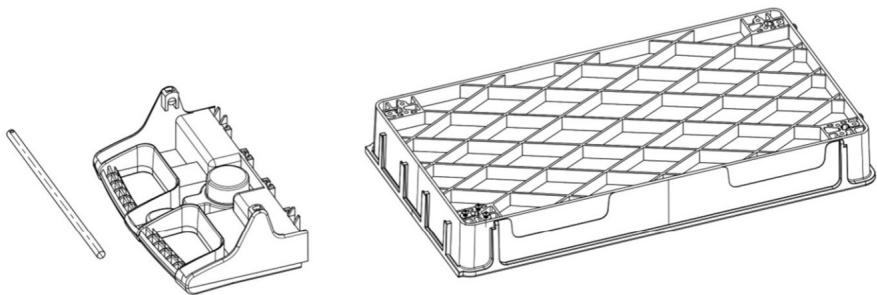

Insert Handle Tray(11) to the TOP Shelf(1),
Knock & reinforce with Rubber Mallet.
Put the Towel Bar (12) in to Handle Tray.

5.

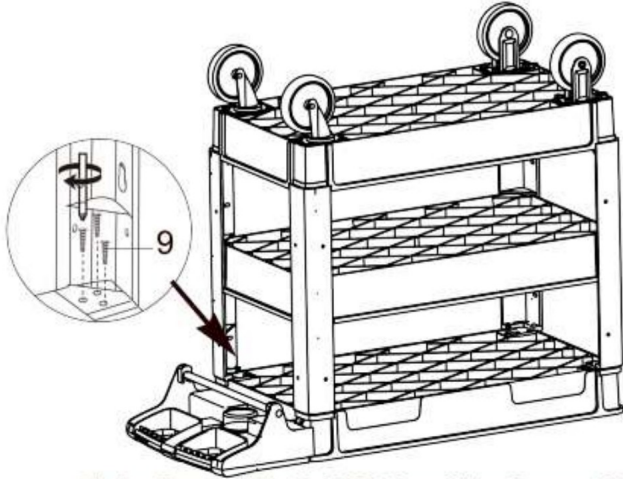

Fix the Beams (4) with TOP Tray (1) by Screws (9).

VEVOR[®]
TOUGH TOOLS, HALF PRICE

Soporte técnico y certificado de garantía
electrónica www.vevor.com/support

VEVOR[®]

TOUGH TOOLS, HALF PRICE

Wsparcie techniczne i certyfikat gwarancji elektronicznej www.vevor.com/support

WÓZKI UŻYTKOWE

INSTRUKCJA OBSŁUGI

MODEL:UD253-3

Nadal staramy się oferować Państwu narzędzia w konkurencyjnych cenach.

„Oszczędź połowę”, „Połowa ceny” lub inne podobne wyrażenia używane przez nas stanowią jedynie szacunkowe oszczędności, jakie możesz uzyskać, kupując u nas określone narzędzia w porównaniu z głównymi markami i niekoniecznie oznaczają one objęcie wszystkich kategorii narzędzi oferowanych przez nas. Uprzejmie przypominamy, aby dokładnie sprawdzić, czy składając u nas zamówienie faktycznie oszczędzasz połowę w porównaniu z głównymi markami.

VEVOR[®]

TOUGH TOOLS, HALF PRICE

WÓZKI UŻYTKOWE

MODEL:UD253-3



POTRZEBUJESZ POMOCY? SKONTAKTUJ SIĘ Z NAMI!

Masz pytania dotyczące produktu? Potrzebujesz wsparcia technicznego? Skontaktuj się z nami:

Wsparcie techniczne i certyfikat gwarancji elektronicznej www.vevor.com/support

To jest oryginalna instrukcja, przed użyciem należy uważnie przeczytać wszystkie instrukcje. VEVOR zastrzega sobie jasną interpretację naszej instrukcji obsługi. Wygląd produktu będzie zależał od produktu, który otrzymałeś. Prosimy o wybaczenie, że nie poinformujemy Cię ponownie, jeśli w naszym produkcie pojawią się jakiegokolwiek aktualizacje technologiczne lub oprogramowania.

SAFETY INSTRUCTION AND PRECAUTIONS



OSTRZEŻENIE:

Przeczytaj ten materiał przed użyciem tego produktu. Nieprzestrzeganie tego może spowodować poważne obrażenia. ZACHOWAJ TĘ INSTRUKCJĘ

Środki ostrożności podczas montażu

1. Montaż należy wykonywać wyłącznie zgodnie z niniejszą instrukcją. Nieprawidłowy montaż może stwarzać zagrożenia.
2. Podczas pracy należy nosić okulary ochronne i wytrzymałe rękawice robocze zgodne z normą ANSI. montaż.
3. Utrzymuj miejsce zgromadzenia w czystości i zapewnij dobre oświetlenie.
4. Podczas montażu nie dopuszczaj osób postronnych na teren montażu.
5. Nie przychodź na spotkania, jeśli jesteś zmęczony lub pod wpływem alkoholu, narkotyków lub leków.
6. Nośność i inne możliwości produktu mają zastosowanie do prawidłowego i Tylko produkt całkowicie zmontowany.
7. Montaż należy wykonać na płaskiej, równej, twardej i gładkiej powierzchni, która będzie bezpieczna obsługujący w pełni załadowany wózek serwisowy.

Stosuj środki ostrożności



ABY ZAPOBIEC POWAŻNYM OBRAŻENIOM I ŚMIERCI SPOWODOWANEJ PRZEWRÓCENIEM:

1. NIE SIADAJ, NIE STÓJ ANI NIE WSPINAJ SIĘ NA TYM PRZEDMIOCIE.
2. Ten produkt nie jest zabawką ani skrzynią na zabawki. Nie pozwalaj dzieciom bawić się tym przedmiotem ani przebywać w jego pobliżu.
3. Nie przekraczaj nośności równomiernie rozłożonej od dołu do góry. Uważaj na obciążenie dynamiczne! Nagły ruch ładunku może chwilowo spowodować nadmierne obciążenie, powodując awarię produktu. Nie przekraczaj nośności ławki lub półki podtrzymującej skrzynię górną.
4. Używać wyłącznie na płaskiej, równej, twardej i gładkiej powierzchni, która może bezpiecznie utrzymać w pełni załadowaną skrzynię.
5. Nie podnoś, gdy jesteś obciążony.
6. Aby zapobiec przewróceniu, należy pchać/ciągnąć wyłącznie za dołączony uchwyt.





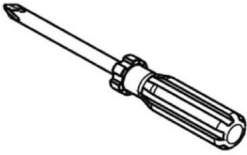

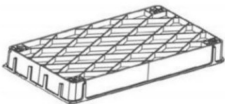

7. Use as intended only.

8. Inspect before every use; do not use if parts are loose or damaged.

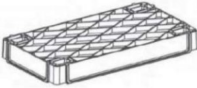
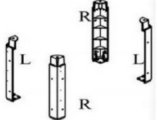
TOOL REQUIRED FOR INSTALLATION

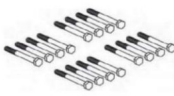
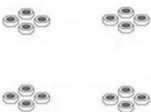
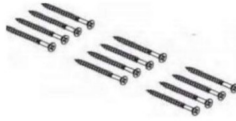
Phillips Screwdriver	Rubber mallet	Note: The phillips screwdriver and rubber mallet tools not included with this product
		

PARTS LIST

1-TOP Tray	2-Middle Tray	3-Bottom Tray	4-Beams
			
5-SwivelCaster	6-FixedCaster	7-Bolts	8-Nuts
			
9-M6Screw	10-SpringWasher	11-Handletray	12-Towelbar
			

ASSEMBLY

1.

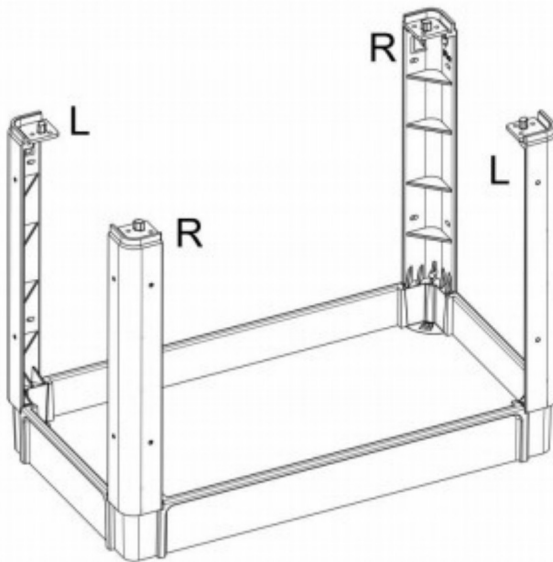

Insert Beam(4) to
the Bottom Shelf(3)
* **R to R, L to L**

2.

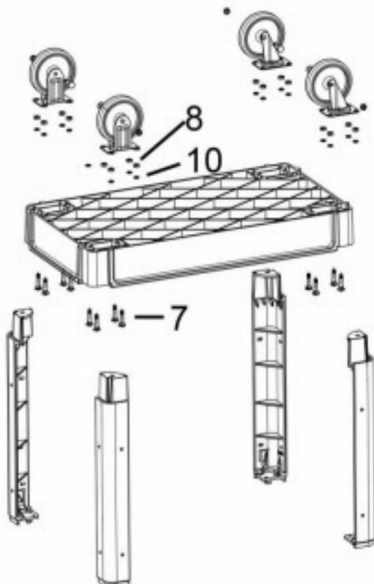

Put 4 wheels(5) & (6)
on the Bottom Shelf
with Blot(7),
Washer(10), Nut(8).

3.

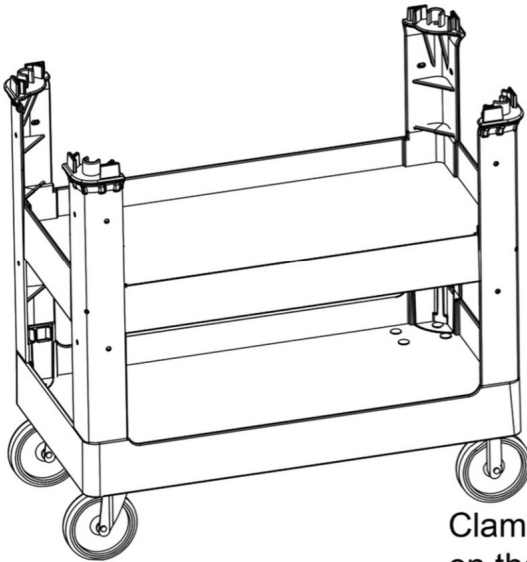

Clamb the Middle Tray (2)
on the Beams (4)

4.

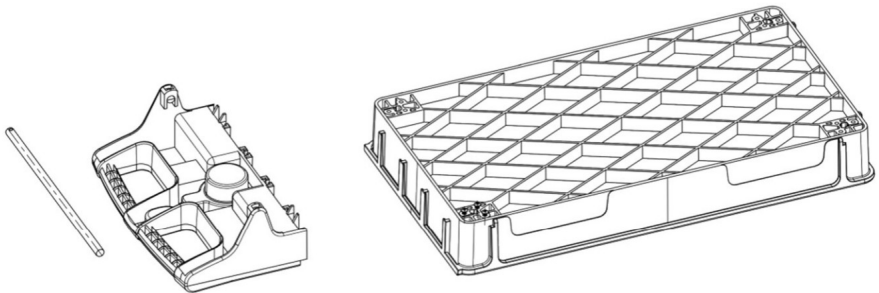

Insert Handle Tray(11) to the TOP Shelf(1),
Knock & reinforce with Rubber Mallet.
Put the Towel Bar (12) in to Handle Tray.

5.

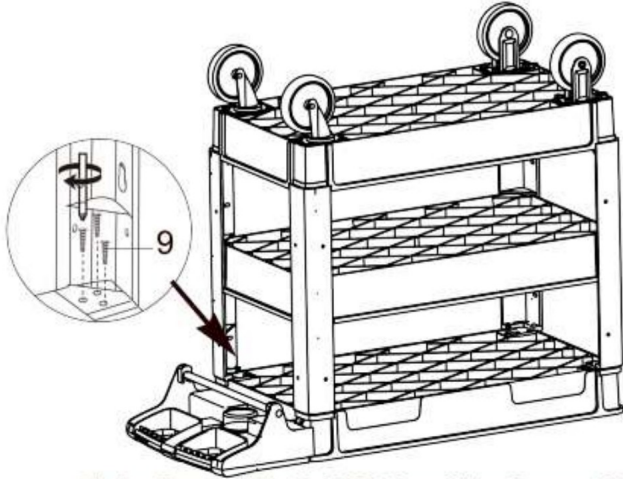

Fix the Beams (4) with TOP Tray (1) by Screws (9).

VEVOR[®]
TOUGH TOOLS, HALF PRICE

Wsparcie techniczne i certyfikat gwarancji
elektronicznej www.vevor.com/support

VEVOR[®]

TOUGH TOOLS, HALF PRICE

Technische ondersteuning en e-garantiecertificaat www.vevor.com/support

NUTSWAGENS

GEBRUIKERSHANDLEIDING

MODEL:UD253-3

Wij streven er voortdurend naar om u gereedschappen tegen concurrerende prijzen te leveren.

"Save Half", "Half Price" of andere soortgelijke uitdrukkingen die wij gebruiken, geven alleen een schatting weer van de besparingen die u kunt behalen door bepaalde gereedschappen bij ons te kopen in vergelijking met de grote topmerken en betekent niet noodzakelijkerwijs dat alle categorieën gereedschappen die wij aanbieden, worden gedekt. Wij herinneren u eraan om zorgvuldig te controleren of u daadwerkelijk de helft bespaart in vergelijking met de grote topmerken wanneer u een bestelling bij ons plaatst.

VEVOR[®]

TOUGH TOOLS, HALF PRICE

NUTSWAGENS

MODEL:UD253-3



HULP NODIG? NEEM CONTACT MET ONS OP!

Heeft u vragen over het product? Heeft u technische ondersteuning nodig? Neem dan gerust contact met ons op:

Technische ondersteuning en e-garantiecertificaat www.vevor.com/support

Dit is de originele instructie, lees alle handleidingen zorgvuldig door voordat u het product gebruikt. VEVOR behoudt zich een duidelijke interpretatie van onze gebruikershandleiding voor. Het uiterlijk van het product is afhankelijk van het product dat u hebt ontvangen. Vergeef ons dat we u niet opnieuw zullen informeren als er technologie- of software-updates voor ons product zijn.

SAFETY INSTRUCTION AND PRECAUTIONS



WAARSCHUWING:

Lees dit materiaal voordat u dit product gebruikt. Als u dit niet doet, kan dit leiden tot ernstig letsel.

BEWAAR DEZE HANDLEIDING

Vorzorgsmaatregelen bij de montage

1. Monteer alleen volgens deze instructies. Onjuiste montage kan gevaren opleveren.
2. Draag tijdens het werk een door de ANSI goedgekeurde veiligheidsbril en stevige werkhandschoenen.
montage.
3. Zorg ervoor dat de montageplek schoon en goed verlicht is.
4. Houd omstanders uit de buurt tijdens de montage.
5. Ga niet in de winkel staan als u moe bent of onder invloed van alcohol, drugs of medicijnen.
6. Het draagvermogen en andere productcapaciteiten zijn van toepassing op de juiste en
Enkel volledig gemonteerd product.
7. Monteer op een vlak, egaal, hard en glad oppervlak dat veilig kan worden gebruikt
ter ondersteuning van een volledig geladen servicekar.

Neem voorzorgsmaatregelen



OM ERNSTIG LETSEL EN DE DOOD DOOR KANTELEN TE VOORKOMEN:

1. NIET OP DIT ITEM ZITTEN, STAAN OF KLIMMEN.
2. Dit product is geen speelgoed of speelgoedkist. Laat kinderen niet met of in de buurt van dit
item spelen.
3. Overschrijd de gewichtscapaciteit niet, gelijkmatig verdeeld van onder naar boven. Wees u bewust
van dynamische belasting! Plotselinge belastingbewegingen kunnen kortstondig overmatige
belasting veroorzaken, wat kan leiden tot productfalen. Overschrijd de capaciteit van de bank of
plank die de bovenste kist ondersteunt niet.
4. Gebruik de kist alleen op een vlak, egaal, hard en glad oppervlak dat een volledig beladen
kist veilig kan dragen.
5. Til niet terwijl het geladen is.
6. Om kantelen te voorkomen, duwt of trekt u alleen met behulp van de meegeleverde handgreep.





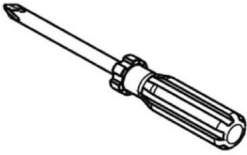

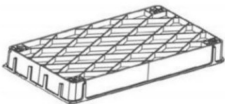

7. Use as intended only.

8. Inspect before every use; do not use if parts are loose or damaged.

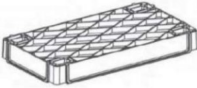
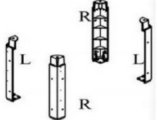
TOOL REQUIRED FOR INSTALLATION

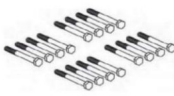
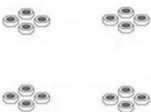
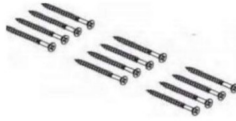
Phillips Screwdriver	Rubber mallet	Note: The phillips screwdriver and rubber mallet tools not included with this product
		

PARTS LIST

1-TOP Tray	2-Middle Tray	3-Bottom Tray	4-Beams
			
5-SwivelCaster	6-FixedCaster	7-Bolts	8-Nuts
			
9-M6Screw	10-SpringWasher	11-Handletray	12-Towelbar
			

ASSEMBLY

1.

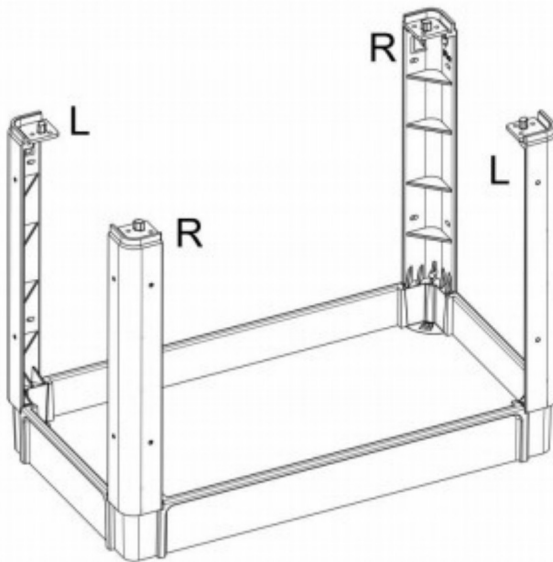

Insert Beam(4) to
the Bottom Shelf(3)
* **R to R, L to L**

2.

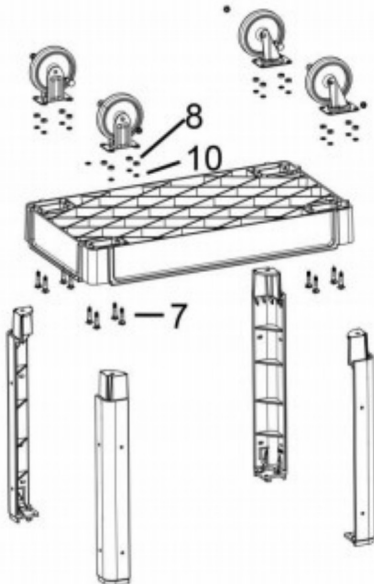

Put 4 wheels(5) & (6)
on the Bottom Shelf
with Blot(7),
Washer(10), Nut(8).

3.

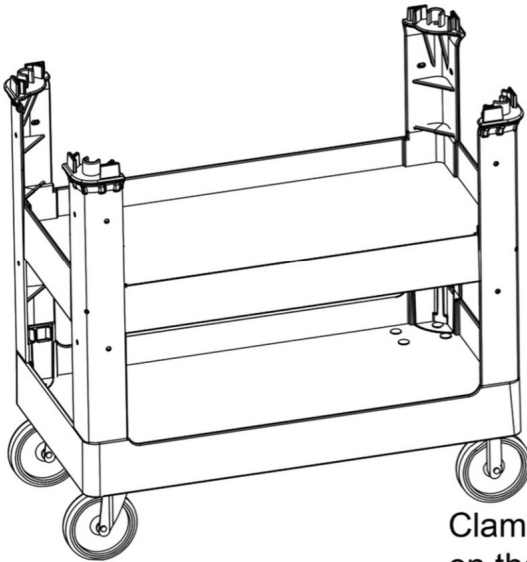

Clamb the Middle Tray (2)
on the Beams (4)

4.

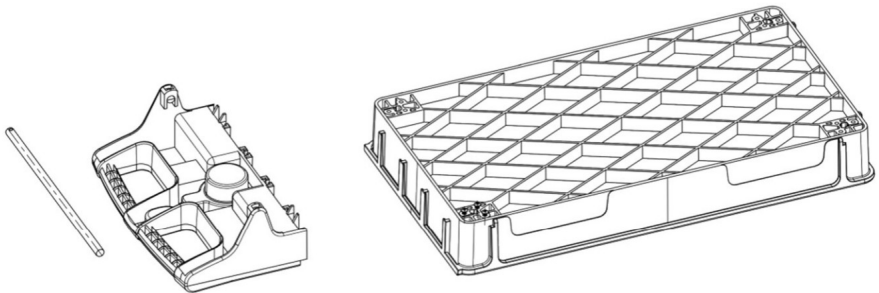

Insert Handle Tray(11) to the TOP Shelf(1),
Knock & reinforce with Rubber Mallet.
Put the Towel Bar (12) in to Handle Tray.

5.

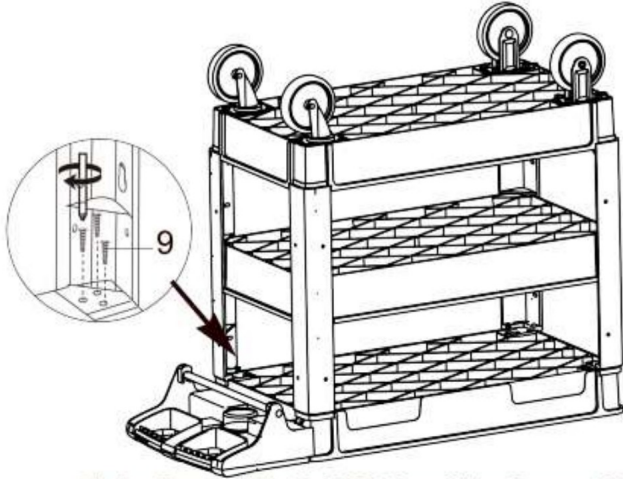

Fix the Beams (4) with TOP Tray (1) by Screws (9).

VEVOR[®]

TOUGH TOOLS, HALF PRICE

**Technische ondersteuning en e-
garantiecertificaat www.vevor.com/support**

VEVOR[®]

TOUGH TOOLS, HALF PRICE

Teknisk support och e-garanticertifikat www.vevor.com/support

BRUKVAGNAR

ANVÄNDARMANUAL

MODELL:UD253-3

Vi fortsätter att vara engagerade i att ge dig verktyg till konkurrenskraftiga priser. "Spara hälften", "halva priset" eller andra liknande uttryck som används av oss representerar bara en uppskattning av besparingar du kan dra nytta av att köpa vissa verktyg hos oss jämfört med de stora toppmärkena och betyder inte nödvändigtvis att täcka alla kategorier av verktyg som erbjuds av oss. Du påminns vänligen om att noggrant kontrollera när du gör en beställning hos oss om du faktiskt sparar hälften i jämförelse med de

VEVOR[®]

TOUGH TOOLS, HALF PRICE

BRUKVAGNAR

MODELL:UD253-3



BEHÖVER HJÄLP? KONTAKTA OSS!

Har du produktfrågor? Behöver du teknisk support? Kontakta oss gärna:

Teknisk support och e-garanticertifikat www.vevor.com/support

Detta är den ursprungliga instruktionen, läs alla instruktioner noggrant innan du använder den. VEVOR reserverar sig för en tydlig tolkning av vår användarmanual. Utseendet på produkten är beroende av den produkt du fått. Ursäkta oss att vi inte kommer att informera dig igen om det finns någon teknik eller mjukvaruuppdateringar på vår produkt.

SAFETY INSTRUCTION AND PRECAUTIONS



VARNING:

Läs detta material innan du använder denna produkt. Underlåtenhet att göra det kan resultera i allvarliga skador. **SPARA DENNA MANUAL**

Försiktighetsåtgärder vid montering

1. Montera endast enligt dessa instruktioner. Felaktig montering kan skapa faror.
2. Bär ANSI-godkända skyddsglasögon och kraftiga arbetshandskar under montering.
3. Håll monteringsområdet rent och väl upplyst.
4. Håll åskådare borta från området under monteringen.
5. Sätt dig inte ihop när du är trött eller påverkad av alkohol, droger eller medicin.
6. Viktkapacitet och andra produkttegenskaper gäller för korrekt och endast färdigmonterad produkt.
7. Montera på en plan, jämn, hård och slät yta som kan säkert stöder en fullastad servicevagn.



Använd försiktighetsåtgärder

FÖR ATT FÖRHINDRA ALLVARLIGA SKADA OCH DÖDSFALL VID VÄLLNING:





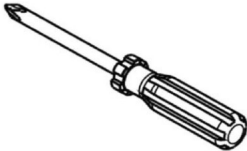



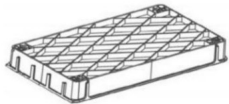

1. **SIT, STÅ ELLER KLÄTTRA INTE PÅ DETTA FÖREMÅL.**
2. Denna produkt är inte en leksak eller en leksakskrin. Låt inte barn leka med eller nära detta föremål.
3. Överskrid inte viktkapaciteten, jämnt fördelad nedifrån och upp. Var uppmärksam på dynamisk laddning! Plötsliga laströrelser kan kortvarigt skapa överbelastning som orsakar produktfel. Överskrid inte kapaciteten hos bänken eller hyllan som stöder övre bröstet.
4. Använd endast på en plan, jämn, hård och slät yta som säkert kan stödja en fullastad kista.
5. Lyft inte när den är lastad.
6. För att förhindra tippning, tryck/dra endast med det medföljande handtaget.

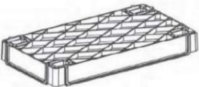
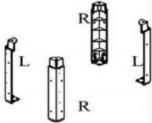
7. Use as intended only.
8. Inspect before every use; do not use if parts are loose or damaged.

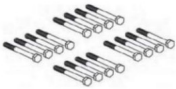
TOOL REQUIRED FOR INSTALLATION

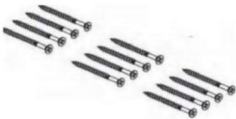
Phillips Screwdriver	Rubber mallet	Note: The phillips screwdriver and rubber mallet tools not included with this product
		

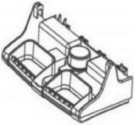
PARTS LIST

1-TOP Tray	2-Middle Tray	3-Bottom Tray	4-Beams
			
5-SwivelCaster	6-FixedCaster	7-Bolts	8-Nuts
			
9-M6Screw	10-SpringWasher	11-Handletray	12-Towelbar
			

ASSEMBLY

1.

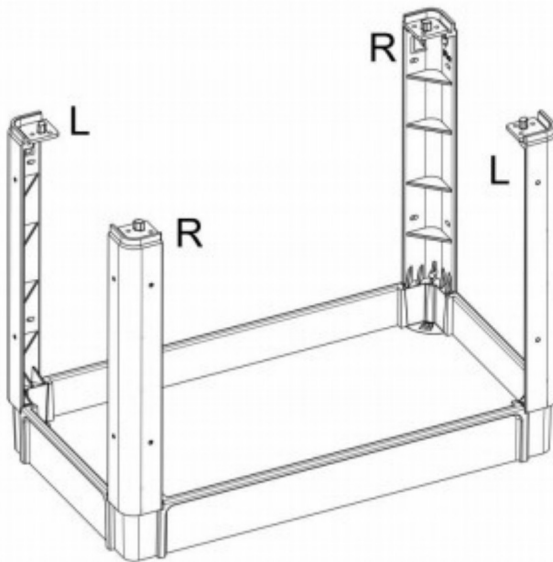

Insert Beam(4) to
the Bottom Shelf(3)
* **R to R, L to L**

2.

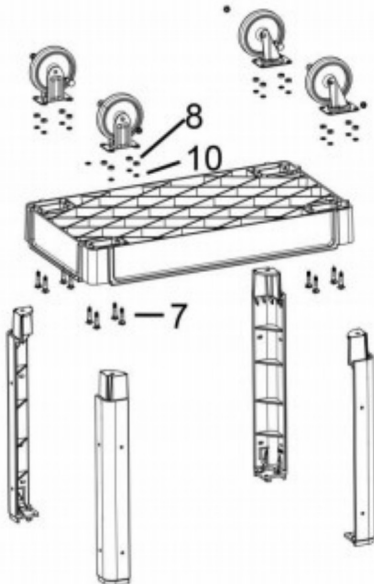

Put 4 wheels(5) & (6)
on the Bottom Shelf
with Blot(7),
Washer(10), Nut(8).

3.

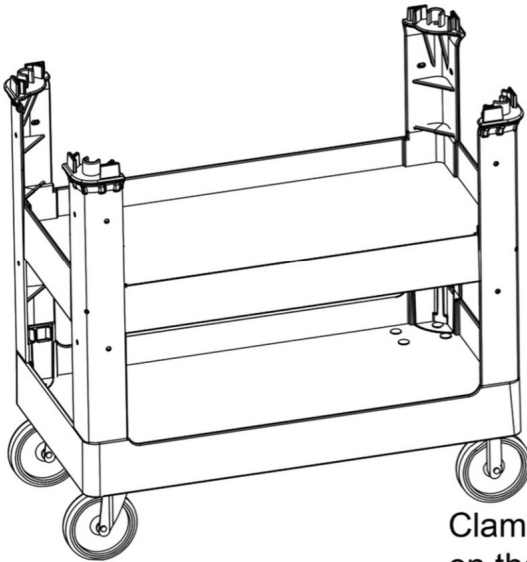

Clamb the Middle Tray (2)
on the Beams (4)

4.

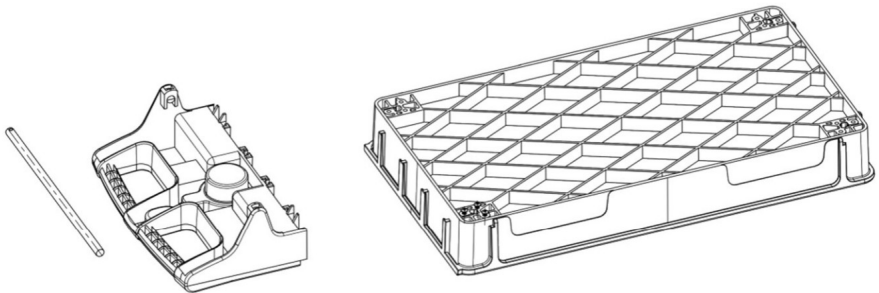

Insert Handle Tray(11) to the TOP Shelf(1),
Knock & reinforce with Rubber Mallet.
Put the Towel Bar (12) in to Handle Tray.

5.

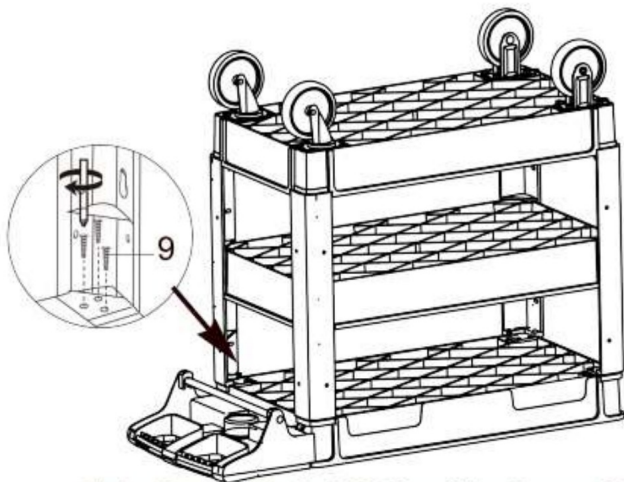

Fix the Beams (4) with TOP Tray (1) by Screws (9).

VEVOR[®]

TOUGH TOOLS, HALF PRICE

Teknisk support och e-garanticertifikat

www.vevor.com/support